

Terminal Blocks, Fuse Blocks and Fuse Holders

Screw Connection



Spring Cage



Insulation Displacement Connection



42.1 IEC—XB Series

IEC— XB Series Overview	T42-2
Screw Connection Terminal Blocks	T42-4
Spring Cage Terminal Blocks	T42-31
Pluggable Spring Cage Connection Terminal Blocks	T42-58
IDC Terminal Blocks	T42-67
Miniature Circuit Breakers	T42-82
XB Series Accessories	T42-90

42.2 NEMA

NEMA Overview	T42-106
C381 Series Terminal Blocks, Rail Mounted	T42-107
TB Series Terminal Blocks, Modular	T42-111

42.3 Power Distribution

Power Distribution Overview	T42-116
CHDB Series—Power Distribution Blocks	T42-117
CH160 Series—Power Terminal Blocks	T42-123
Power Terminal Block Accessories	T42-126

42.4 Fuse Blocks and Fuse Holders

Fuse Blocks and Fuse Holders Overview	T42-128
C383 Series Disconnect Fuse Holders	T42-129
C350 Series Fuse Blocks and W Series Fuse Holders	T42-131

IEC—XB Series

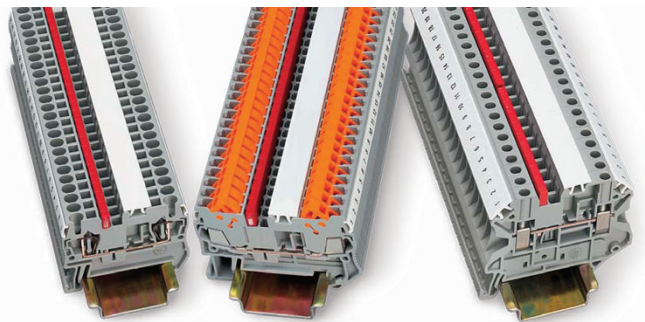

IEC—XB Series Overview

Product Description

The **XB** Series from Eaton offers a complete terminal block system with a universal range of accessories. Marking, bridging and testing accessories are standardized across the different termination technologies—reducing inventory and logistics costs. The modular terminal block design allows for use of the different terminal block types together or individually, providing the highest degree of flexibility.

Application Description

The metal portion of the **XB** Series terminal blocks are made from high-grade, strain-crack and corrosion-proof copper alloys. They won't experience any electrolytic corrosion or rusting, even when moisture is present. The metal surfaces are protected with a lead-free, galvanic nickel or tin plating. The good electrical conductivity permits only a low temperature rise. The Polyamide 6.6 housings allow for operating temperatures up to 257°F (125°C) and are certified for inflammability Class V0 in accordance with UL 94.

Features

Global acceptance—The **XB** Series terminal blocks are designed to worldwide standards and meet the latest international requirements.

Flexible Plug-in bridge system—All three technologies (screw, spring and IDC) use the same bridge system, allowing for individual potential distribution and quickly bridged connections among the same terminal block type or across different types. The **XB** Series terminal blocks have two bridge shafts arranged in one line, making flexible chain bridging and skip bridging between non-adjacent terminal blocks possible. Plug-in bridges are available from 2 to 50 positions. Reducing bridges are also available to connect a larger terminal block to a smaller one.

Contents

Description

Description	Page
IEC— XB Series	
Screw Connection Terminal Blocks	T42-4
Spring Cage Terminal Blocks	T42-31
Pluggable Spring Cage Connection Terminal Blocks	T42-58
IDC Terminal Blocks	T42-67
Miniature Circuit Breakers	T42-82
XB Series Accessories	T42-90

Large surface area for marking—All **XB** Series terminal blocks have generously sized surface areas for labeling. This allows for clearly labeled wiring that results in reduced startup time and simplifies activities such as testing and maintenance. There are provisions for marking individual terminal blocks and end stops, strips of terminal blocks, and large groups of terminal blocks.

Standardized testing system—All test plugs make contact in one of the easily accessible bridge shafts. A 2.3 mm diameter test plug is available for individual measuring wires. Modular test plugs are also available for more advanced testing.

Standards and Certifications

- UL® and cUL® recognized—File No. E67464
- CE approved
- LVD ①
 - EN 60947-7-1
 - EN 60947-7-2
 - EN 60998-2-3
 - EN 60352-4/A1
- ATEX approval (Ex e applications)



Note

- ① Not all standards apply to all terminal blocks. Contact Eaton for details.

Technical Data and Specifications

IEC—XB Series

Description	Specification
Insulation material	Polyamide 6.6
Dielectric strength	600 kV/cm
Creep resistance	600 CTI
Internal insulation resistance	10 ¹² ohms cm
Surface resistance	10 ¹⁰ ohms
Flammability rating	UL 94 V0
Continuous operating temperature	−40 to 257°F (−40 to 125°C)

Modular Terminal Blocks for Potentially Explosive Environments

The standard modular terminal blocks from Eaton are approved for potentially explosive environments. In addition to the usual approvals, they also have been approved by a testing centre authorized by the EU. No extra approval is required in Intrinsic Safety type applications.

Modular terminal blocks on www.eaton.com fulfill the requirements for “Increased Safety” protection type when installation instructions are followed, and have a type examination certificate in accordance with the Ex directive Ex-RL 94/9/EU.

These test certificates are recognized in all the EU member states and beyond.

The modular terminal blocks are approved for fitting in Zone 1, the Ex environment, as well as Zone 2. Zone 1 fitting is conditional upon terminal blocks being used in connection boxes approved for EEx e type protection and having the equivalent of at least IP54 protection.

The EEx approved modular terminal blocks can be divided into the following groups:

- Screw connection terminal blocks
- Spring-cage connection terminal blocks
- Insulation Displacement Connection terminal blocks
- Mini terminal blocks
- Terminal blocks for specialized applications

More detailed information on modular terminal blocks in the EEx e area is available on the Internet at www.eaton.com for downloading.

Here you will find the following:

- Technical data in accordance with EN 50 019
- Approved accessories
- Important installation instructions and mounting diagrams
- EU type examination certificates
- General information on Ex protection

Identifications

Explosion protected electrical equipment must be marked so that the safety characteristics are identifiable. The identification of electrical equipment is described in the harmonized standard EN 50014, as shown in the following example:

EN 50014 Standard Example

Description	Identification
Manufacturer or trademark	Eaton
Type designation	XBUT25
Abbreviation of explosion protection	EEx e II
Protection type increased safety “e”	e
Equipment group	II
Mark of the testing body	KEMA
Approval number	05ATEX2158 U

Identification in Accordance with ATEX-RL

Electrical equipment that is certified in accordance with the ATEX 100a guideline also receives identification describing the site for use.

ATEX Guideline Example

Description	Identification
Manufacturing data	02.01.2004
Address of the manufacturer	Duncan, SC
Number of the appointed dept.	344
Common marking	Ex symbol
Equipment group	II
Category	2
Use in gas and/or dust atmospheres	G D

Screw Connection



Contents

<i>Description</i>	<i>Page</i>
Screw Connection Terminal Blocks	
Single Level—Through-Feed	T42-5
Single Level—Ground Blocks	T42-10
Multi-Conductor Terminal Blocks	T42-12
Multi-Conductor Ground Blocks	T42-14
Double Level	T42-16
Triple Level Sensor/Actuator	T42-18
Fuse Terminal Blocks	T42-21
Disconnect and Component Terminal Blocks	T42-24
High Current Blocks	T42-27
Mini Screw Connection	T42-29

Screw Connection Terminal Blocks Overview

Product Description

The XBUT Series uses a screw connection system that is accepted worldwide and is suitable in most applications. The maintenance-free connection provides the reliability you expect from Eaton.

Application Description

Designed for applications with high demands, the XBUT Series screw terminal block has a maintenance-free wire connection. re-tightening of the terminal screws is not necessary to ensure proper operation. The screw locking technique prevents the screws from backing out. Copper wires can be clamped without pre-treatment or ferrules can be used for splicing protection. Multiple conductors can be connected in the same clamping mechanism, saving space.

Features

- Maintenance-free connections
- Global acceptance
- Multi-conductor connections
- Flexible Plug-in bridge system
- Large surface area for marking
- Standardized testing system
- Metal parts made of tin-plated copper alloy

Standards and Certifications

- UL and cUL recognized—File No. E67464
- CE approved
- LVD ①:
 - EN 60947-7-1
 - EN 60947-7-2
 - EN 60998-2-3
 - EN 60352-4/A1
- ATEX approval (Eex e applications)



Note

① Not all standards apply to all terminal blocks. Contact Eaton for details.

Single Level—Through-Feed

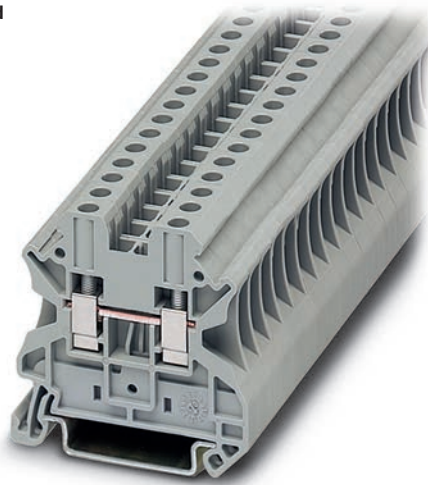

Single Level—Through-Feed

Product Description

The XBUT terminal blocks feature a compact design and maintenance-free screw connection. There is a double bridge shaft providing maximum flexibility.

The double bridge shaft can accommodate individual chain bridging and step-down bridging from other terminal blocks. There are numerous options for accessories,

Contents

Description

	<i>Page</i>
Single Level—Through-Feed	
Product Selection	T42-6
Accessories	T42-7
Technical Data and Specifications	T42-9
Dimensions	T42-9
Single Level—Ground Blocks	T42-10
Multi-Conductor Terminal Blocks	T42-12
Multi-Conductor Ground Blocks	T42-14
Double Level	T42-16
Triple Level Sensor/Actuator	T42-18
Fuse Terminal Blocks	T42-21
Disconnect and Component Terminal Blocks	T42-24
High Current Blocks	T42-27
Mini Screw Connection	T42-29

including those for testing and marking. Terminal blocks are available for wire cross-sections ranging from 12 AWG (2.5 mm²) to 2/0 AWG (150 mm²).

42.1

Terminal Blocks, Fuse Blocks and Fuse Holders

IEC—XB Series

Product Selection

XBUT4



Screw Connection Single Level—Through-Feed

Terminal Width	Maximum Wire Size	IEC 60 947-7-1 in V/A/AWG	EN 50 019 ① in V/A/AWG	UL-cUL Ratings in V/A/AWG	Colour	Standard Pack	Catalogue Number
5.2 mm	12 AWG/2.5 mm ²	800/32/26–12	750/22/28/26–12	600/20/26–12	Gray	50	XBUT25
					Blue	50	XBUT25BU
6.2 mm	10 AWG/4 mm ²	800/41/26–10	750/30/38/26–10	600/30/26–10	Gray	50	XBUT4
					Blue	50	XBUT4BU
					Orange	50	XBUT4OR
					Yellow	50	XBUT4YE
					Red	50	XBUT4RD
					White	50	XBUT4WH
					Black	50	XBUT4BK
8.2 mm	8 AWG/6 mm ²	800/57/24–8	750/40/50/24–8	600/50/24–8	Gray	50	XBUT6
					Blue	50	XBUT6BU
10.2 mm	6 AWG/10 mm ²	1000/76/20–6	750/54/69/20–6	600/65/20–6	Gray	50	XBUT10
					Blue	50	XBUT10BU
					Orange	50	XBUT10OR
					Yellow	50	XBUT10YE
					Red	50	XBUT10RD
12 mm	4 AWG/16 mm ²	1000/101/17–4	—	600/85/16–4	Gray	50	XBUT16
					Blue	50	XBUT16BU
16 mm	0 AWG/35 mm ²	1000/150/15–0	—	600/150/14–1/0	Gray	50	XBUT35
					Blue	50	XBUT35BU

Note

① EU type—examination certificate number: KEMA 05ATEX2158 U.

Accessories

Screw Connection Single Level—Through-Feed

Description	Colour	Number of Positions	Standard Pack	XBUT25 Catalogue Number	XBUT4 Catalogue Number	XBUT6 Catalogue Number	XBUT10 Catalogue Number	XBUT16 Catalogue Number	XBUT35 Catalogue Number
End cover	Gray	—	10	XBACUT10	XBACUT10	XBACUT10	XBACUT10	XBACUT16	①
Partition plate	Gray	—	10	XBATUT10	XBATUT10	XBATUT10	XBATUT10	—	—
Plug-in bridge— for cross connections in the bridge shaft	Red	2	10	XBAFBS25	XBAFBS26	XBAFBS28	XBAFBS210	XBAFBS212	XBAFBS216
		3	10	XBAFBS35	XBAFBS36	—	—	—	—
		5	10	XBAFBS55	XBAFBS56	—	—	—	—
		10	10	XBAFBS105	XBAFBS106	—	—	—	—
		50	10	XBAFBS505	XBAFBS506	—	—	—	—
Test adapter	—	—	10	XBATSPAI4	XBATSPAI4	XBATSPAI4	—	—	—
2.3 mm diameter test plug	—	—	—	XBATSMPS- ①	XBATSMPS- ①	—	—	—	—
Modular test plug	—	—	10	XBATSPS5	XBATSPS6	XBATSPS8	—	—	—
Blank marker strip (strip of 10)	White	—	10	XBMZB5 ②	XBMZB6 ②	XBMZB8 ②	XBMZB10 ②	XBMZB12 ②	XBMZB15 ②

Notes① For ordering information, see **Page T42-105**.② For information on Printed Marking Tag Options, see **Page T42-98**.For additional accessories, see **Page T42-90**.

42.1

Terminal Blocks, Fuse Blocks and Fuse Holders

IEC—XB Series

42

XBUT with Reducing Bridge

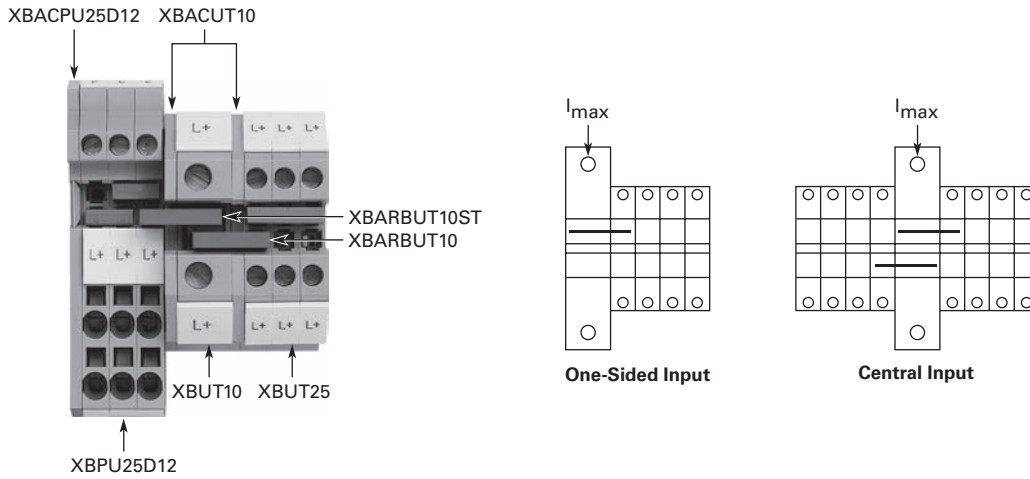

Step-Down Bridge with Standard Feed-Through Terminal Blocks

Input Terminal Blocks	Cross-Section	Pick-Off Terminal Blocks	Cross-Section AWG (mm ²)	One-Sided Input I _{max}	Central Input I _{max}	Bridge Catalogue Number
XBUT10	6 AWG (10 mm ²)	XBUT25	12 (2.5)	40	65	XBARBUT10
		XBUT4	10 (4)	45	65	XBARBUT10
		XBPT25	12 (2.5)	40	65	XBARBUT10ST
		XBPT4	10 (4)	45	65	XBARBUT10ST
		XBQT15	14 (1.5)	35	65	XBARBUT10ST
		XBQT25	12 (2.5)	40	65	XBARBUT10ST
XBUT16	4 AWG (16 mm ²)	XBUT25	12 (2.5)	40	80	XBARBUT16
		XBUT4	10 (4)	45	90	XBARBUT16
		XBPT25	12 (2.5)	40	80	XBARBUT16ST
		XBPT4	10 (4)	45	90	XBARBUT16ST
		XBQT15	14 (1.5)	35	70	XBARBUT16ST
		XBQT25	12 (2.5)	40	80	XBARBUT16ST

Technical Data and Specifications

Screw Connection Single Level—Through-Feed

Description	XBUT25	XBUT4	XBUT6	XBUT10	XBUT16	XBUT35
Technical Data in Accordance with IEC						
Maximum load current in A/cross-section in mm ²	32/4	41/6	57/10	76/16	101/25	150/50
Rated surge voltage in kV/contamination class	8/3	8/3	8/3	8/3	8/3	8/3
Surge voltage category/insulating material group	III/II	III/I	III/I	III/I	III/I	III/I
Connection Capacity						
Stranded with ferrule/with ferrule and plastic sleeve in mm ²	0.25–2.5/0.25–2.5	0.25–4/0.25–4	0.25–6/0.25–6	0.5–10/0.5–10	1.0–16/1.0–16	1.5–35/1.5–35
Multi-Conductor Connection (same cross-section)						
Solid/stranded in mm ²	0.14–1.5/0.14–1.5	0.14–1.5/0.14–1.5	0.2–2.5/0.2–2.5	0.5–4/0.5–4	1.0–6/1.0–4	1.5–16/1.5–10
Stranded with ferrules without plastic sleeve in mm ²	0.25–1.5	0.25–1.5	0.25–1.5	0.5–2.5	1.0–4	1.5–10
Stranded with twin ferrule with plastic sleeve in mm ²	0.5–1.5	0.5–2.5	0.5–4	0.5–6	0.75–10	1.5–10
Stripping length in inches (mm)	0.35 (9)	0.35 (9)	0.39 (10)	0.39 (10)	0.39 (10)	0.63 (16)
Thread	M3	M3	M4	M4	M5	M6
Torque in in-lb (Nm)	5.3–7.1 (0.6–0.8)	5.3–7.1 (0.6–0.8)	13.3–15.9 (1.5–1.8)	13.3–15.9 (1.5–1.8)	22.1–26.6 (2.5–3)	28.3–32.7 (3.2–3.7)

Dimensions

Approximate Dimensions in Inches (mm)

Screw Connection Single Level—Through-Feed

Catalogue Number	Width	Length	Cover Width	Height for—	
				35 x 7.5 in	35 x 15 in
XBUT25	0.20 (5.2)	1.85 (46.9)	0.09 (2.2)	1.87 (47.5)	2.17 (55.0)
XBUT4	0.24 (6.2)	1.85 (46.9)	0.09 (2.2)	1.87 (47.5)	2.17 (55.0)
XBUT6	0.32 (8.2)	1.85 (46.9)	0.09 (2.2)	1.87 (47.5)	2.17 (55.0)
XBUT10	0.40 (10.2)	1.85 (46.9)	0.09 (2.2)	1.87 (47.5)	2.17 (55.0)
XBUT16	0.47 (12.0)	2.08 (52.8)	0.09 (2.2)	2.16 (54.8)	2.45 (62.3)
XBUT35	0.63 (16.0)	2.37 (60.2)	—	2.59 (65.7)	2.88 (73.2)

Notes

- ① XBUT35 has an enclosed design. The use of an end cover is not required.
- ② For information on Printed Marking Tag Options, see **Page T42-98**.

42.1

Terminal Blocks, Fuse Blocks and Fuse Holders

IEC—XB Series

Single Level—Ground Blocks

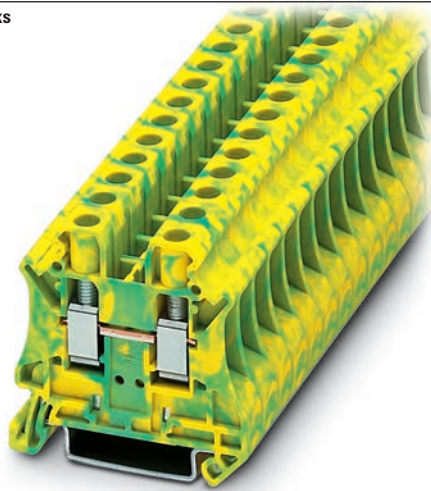

Contents

Description	Page
Single Level—Through-Feed	T42-5
Single Level—Ground Blocks	
Accessories	T42-11
Technical Data and Specifications	T42-11
Dimensions	T42-11
Multi-Conductor Terminal Blocks	T42-12
Multi-Conductor Ground Blocks	T42-14
Double Level	T42-16
Triple Level Sensor/Actuator	T42-18
Fuse Terminal Blocks	T42-21
Disconnect and Component Terminal Blocks	T42-24
High Current Blocks	T42-27
Mini Screw Connection	T42-29

42

Single Level—Ground Blocks

Product Description

The ground terminal blocks have the same shape and pitch as the standard terminal block, in a green-yellow housing. They easily snap

onto the DIN rail to make a reliable mechanical and electrical contact that meets all requirements of IEC 60-947-7-2.

Product Selection

XBUT6PE



Screw Connection Single Level—Ground Blocks

Terminal Width	Maximum Wire Size	IEC 60 947-7-1 in V/A/AWG	EN 50 019 ① in V/A/AWG	UL-cUL Ratings in V/A/AWG	Colour	Standard Pack	Catalogue Number
5.2 mm	12 AWG/2.5 mm ²	—/—/26-12	—/—/26-12	—/—/26-12	Green/Yellow	50	XBUT25PE
6.2 mm	10 AWG/4 mm ²	—/—/26-10	—/—/26-10	—/—/26-10	Green/Yellow	50	XBUT4PE
8.2 mm	8 AWG/6 mm ²	—/—/24-8	—/—/24-8	—/—/24-8	Green/Yellow	50	XBUT6PE
10.2 mm	6 AWG/10 mm ²	—/76/20-6	—/54/69/20-6	—/—/20-6	Green/Yellow	50	XBUT10PE
12 mm	4 AWG/16 mm ²	—/101/15-4	—	—/—/16-4	Green/Yellow	50	XBUT16PE
16 mm	2 AWG/35 mm ²	—/125/15-2	—	—/—/14-1/0	Green/Yellow	50	XBUT35PE

Note

① EU type—examination certificate number: KEMA 05ATEX2158 U.

Accessories

Screw Connection Single Level—Ground Blocks

Description	Colour	Number of Positions	Standard Pack	XBUT25PE Catalogue Number	XBUT4PE Catalogue Number	XBUT6PE Catalogue Number	XBUT10PE Catalogue Number	XBUT16PE Catalogue Number	XBUT35PE Catalogue Number
End cover	Gray	—	10	XBACUT10	XBACUT10	XBACUT10	XBACUT10	XBACUT16	③
Partition plate	—	—	10	XBATUT10	XBATUT10	XBATUT10	XBATUT10	—	—
Plug-in bridge— for cross connections in the bridge shaft	Red	2	10	XBAFBS25	XBAFBS26	XBAFBS28	XBAFBS210	XBAFBS212	XBAFBS212
		3	10	XBAFBS35	XBAFBS36	—	—	—	—
		5	10	XBAFBS55	XBAFBS56	—	—	—	—
		10	10	XBAFBS105	XBAFBS106	—	—	—	—
		50	10	XBAFBS505	XBAFBS506	—	—	—	—
Test adapter	—	—	10	XBATSPAI4	XBATSPAI4	XBATSPAI4	—	—	—
2.3 mm diameter test plug	—	—	—	XBATSMPS_ ①	XBATSMPS_ ①	—	—	—	—
Modular test plug	—	—	10	XBATSPS5	XBATSPS6	XBATSPS8	—	—	—
Blank marker strip (strip of 10)	White	—	10	XBMZB5 ②	XBMZB6 ②	XBMZB8 ②	XBMZB10 ②	XBMZB12 ②	XBMZB15 ②

Technical Data and Specifications

Screw Connection Single Level—Ground Blocks

Description	XBUT25PE	XBUT4PE	XBUT6PE	XBUT10PE	XBUT16PE	XBUT35PE
Technical Data in Accordance with IEC						
Maximum load current in A/cross-section in mm ²	—	—	—	76/16	101/25	125/50
Rated surge voltage in kV/contamination class	8/3	8/3	8/3	8/3	8/3	8/3
Surge voltage category/insulating material group	III/II	III/I	III/I	III/I	III/I	III/I
Connection Capacity						
Stranded with ferrule/with ferrule and plastic sleeve in mm ²	0.25–2.5/0.25–2.5	0.25–4/0.25–4	0.25–6/0.25–6	0.5–10/0.5–10	1.0–16/1.0–16	1.5–35/1.5–35
Multi-Conductor Connection (same cross-section)						
Solid/stranded in mm ²	0.14–1.5/0.14–1.5	0.14–1.5/0.14–1.5	0.2–2.5/0.2–2.5	0.5–4/0.5–4	1.0–6/1.0–4	1.5–16/1.5–10
Stranded with ferrules without plastic sleeve in mm ²	0.25–1.5	0.25–1.5	0.25–1.5	0.5–2.5	1.0–4	1.5–10
Stranded with twin ferrule with plastic sleeve in mm ²	0.5–1.5	0.5–2.5	0.5–4	0.5–6	0.75–10	1.5–10
Stripping length in inches (mm)	0.35 (9)	0.35 (9)	0.39 (10)	0.39 (10)	0.39 (10)	0.63 (16)
Thread	M3	M3	M4	M4	M5	M6
Torque in in-lb (Nm)	5.3–7.1 (0.6–0.8)	5.3–7.1 (0.6–0.8)	13.3–15.9 (1.5–1.8)	13.3–15.9 (1.5–1.8)	22.1–26.6 (2.5–3)	28.3–32.7 (3.2–3.7)

Dimensions

Approximate Dimensions in Inches (mm)

Screw Connection Single Level—Ground Blocks

Catalogue Number	Width	Length	Cover Width	Height for—	
				35 x 7.5 in	35 x 15 in
XBUT25PE	0.20 (5.2)	1.85 (46.9)	0.09 (2.2)	1.87 (47.5)	2.17 (55.0)
XBUT4PE	0.24 (6.2)	1.85 (46.9)	0.09 (2.2)	1.87 (47.5)	2.17 (55.0)
XBUT6PE	0.32 (8.2)	1.85 (46.9)	0.09 (2.2)	1.87 (47.5)	2.17 (55.0)
XBUT10PE	0.40 (10.2)	1.85 (46.9)	0.09 (2.2)	1.87 (47.5)	2.17 (55.0)
XBUT16PE	0.47 (12.0)	2.08 (52.8)	0.09 (2.2)	2.16 (54.8)	2.45 (62.3)
XBUT35PE	0.63 (16.0)	2.37 (60.2)	—	2.59 (65.7)	2.88 (73.2)

Notes

- ① For ordering information, see **Page T42-105**.
- ② For information on Printed Marking Tag Options, see **Page T42-98**.
- ③ XBUT35PE has an enclosed design. The use of an end cover is not required.

For additional accessories, see **Page T42-90**.

Multi-Conductor Terminal Blocks

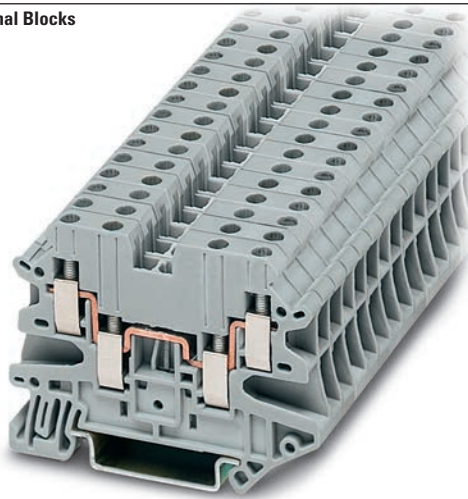

Contents

Description	Page
Single Level—Through-Feed	T42-5
Single Level—Ground Blocks	T42-10
Multi-Conductor Terminal Blocks	
Accessories	T42-13
Technical Data and Specifications	T42-13
Dimensions	T42-13
Multi-Conductor Ground Blocks	T42-14
Double Level	T42-16
Triple Level Sensor/Actuator	T42-18
Fuse Terminal Blocks	T42-21
Disconnect and Component Terminal Blocks	T42-24
High Current Blocks	T42-27
Mini Screw Connection	T42-29

Multi-Conductor Terminal Blocks

Product Description

The multi-conductor terminal blocks offer a space-saving alternative to standard feed-through terminal blocks allowing for high density wiring. Often, three

connections have to be led to one terminal block. The XBUT...D12 terminal block accomplishes this without any additional terminal blocks or bridging required.

The XBUT...D22 terminal blocks allow four wires to be connected to one potential—and can therefore be used as compact power distributors.

Product Selection

XBUT25D12

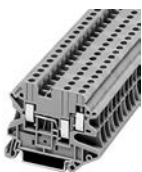

Screw Connection Multi-Conductor Terminal Blocks, Three-Wire

Terminal Width	Maximum Wire Size	IEC 60 947-7-1 in V/A/AWG	UL-cUL Ratings in V/A/AWG	Colour	Standard Pack	Catalogue Number
5.2 mm	12 AWG/2.5 mm ²	500/28/26–12	150/20/26–12	Gray	50	XBUT25D12
				Blue	50	XBUT25D12BU
6.2 mm	10 AWG/4 mm ²	500/39/26–10	150/30/26–10	Gray	50	XBUT4D12
				Blue	50	XBUT4D12BU

XBUT4D22

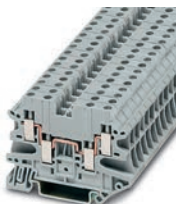

Screw Connection Multi-Conductor Terminal Blocks, Four-Wire

Terminal Width	Maximum Wire Size	IEC 60 947-7-1 in V/A/AWG	UL-cUL Ratings in V/A/AWG	Colour	Standard Pack	Catalogue Number
5.2 mm	12 AWG/2.5 mm ²	500/28/26–12	150/20/26–12	Gray	50	XBUT25D22
				Blue	50	XBUT25D22BU
6.2 mm	10 AWG/4 mm ²	500/39/26–10	150/30/26–10	Gray	50	XBUT4D22
				Blue	50	XBUT4D22BU

Accessories

Screw Connection Multi-Conductor Terminal Blocks

Description	Colour	Number of Positions	Standard Pack	XBUT25D12 Catalogue Number	XBUT4D12 Catalogue Number	XBUT25D22 Catalogue Number	XBUT4D22 Catalogue Number
End cover	Gray	—	10	XBACUT4D12	XBACUT4D12	XBACUT4D22	XBACUT4D22
End cover segment	Gray	—	10	XBASUT4	XBASUT4	XBASUT4	XBASUT4
Partition plate	—	—	10	XBATUTD12	XBATUTD12	XBATUTD22	XBATUTD22
Plug-in bridge—for cross connections in the bridge shaft	Red	2	10	XBAFBS25	XBAFBS26	XBAFBS25	XBAFBS26
		3	10	XBAFBS35	XBAFBS36	XBAFBS35	XBAFBS36
		5	10	XBAFBS55	XBAFBS56	XBAFBS55	XBAFBS56
		10	10	XBAFBS105	XBAFBS106	XBAFBS105	XBAFBS106
		50	10	XBAFBS505	XBAFBS506	XBAFBS505	XBAFBS506
Test adapter	—	—	10	XBATSPAI4	XBATSPAI4	XBATSPAI4	XBATSPAI4
2.3 mm diameter test plug	—	—	—	XBATSMPS- ^①	XBATSMPS- ^①	XBATSMPS- ^①	XBATSMPS- ^①
Modular test plug	—	—	10	XBATSPS5	XBATSPS6	XBATSPS5	XBATSPS6
Blank marker strip (strip of 10)	White	—	10	XBMZB5 ^②	XBMZB6 ^②	XBMZB5 ^②	XBMZB6 ^②

Technical Data and Specifications

Screw Connection Multi-Conductor Terminal Blocks

Description	XBUT25D12	XBUT4D12	XBUT25D22	XBUT4D22
Technical Data in Accordance with IEC				
Maximum load current in A/cross-section in mm ²	28/4	39/6	28/4	39/6
Rated surge voltage in kV/contamination class	6/3	6/3	6/3	6/3
Surge voltage category/insulating material group	III/I	III/I	III/I	III/I
Connection Capacity				
Stranded with ferrule/with ferrule and plastic sleeve in mm ²	0.25–2.5/0.25–2.5	0.25–4/0.25–4	0.25–2.5/0.25–2.5	0.25–4/0.25–4
Multi-Conductor Connection (same cross-section)				
Solid/stranded in mm ²	0.14–1.0/0.14–1.0	0.14–1.0/0.14–1.5	0.14–1.0/0.14–1.0	0.14–1.0/0.14–1.5
Stranded with ferrules without plastic sleeve in mm ²	0.25–1.0	0.25–1.5	0.25–1.0	0.25–1.5
Stranded with twin ferrule with plastic sleeve in mm ²	0.5–1.0	0.5–1.0	0.5–1.0	0.5–1.0
Stripping length in inches (mm)	0.31 (8)	0.31 (8)	0.31 (8)	0.31 (8)
Thread	M3	M3	M3	M3
Torque in in-lb (Nm)	5.3–7.1 (0.6–0.8)	5.3–7.1 (0.6–0.8)	5.3–7.1 (0.6–0.8)	5.3–7.1 (0.6–0.8)

Dimensions

Approximate Dimensions in Inches (mm)

Screw Connection Multi-Conductor Terminal Blocks

Catalogue Number	Width	Length	Cover Width	Height for—	
				35 x 7.5 in	35 x 15 in
XBUT25D12	0.20 (5.2)	2.24 (56.8)	0.09 (2.2)	1.87 (47.5)	2.17 (55.0)
XBUT4D12	0.24 (6.2)	2.24 (56.8)	0.09 (2.2)	1.87 (47.5)	2.17 (55.0)
XBUT25D22	0.20 (5.2)	2.52 (64.1)	0.09 (2.2)	1.87 (47.5)	2.17 (55.0)
XBUT4D22	0.24 (6.2)	2.52 (64.1)	0.09 (2.2)	1.87 (47.5)	2.17 (55.0)

Notes

^① For ordering information, see **Page T42-105**.

^② For information on Printed Marking Tag Options, see **Page T42-98**.

For additional accessories, see **Page T42-90**.

Multi-Conductor Ground Blocks

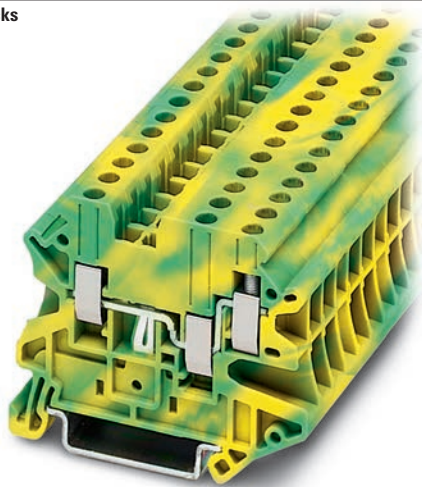

Contents

<i>Description</i>	<i>Page</i>
Single Level—Through-Feed	T42-5
Single Level—Ground Blocks	T42-10
Multi-Conductor Terminal Blocks	T42-12
Multi-Conductor Ground Blocks	
Accessories	T42-15
Technical Data and Specifications	T42-15
Dimensions	T42-15
Double Level	T42-16
Triple Level Sensor/Actuator	T42-18
Fuse Terminal Blocks	T42-21
Disconnect and Component Terminal Blocks	T42-24
High Current Blocks	T42-27
Mini Screw Connection	T42-29

Multi-Conductor Ground Blocks

Product Description

The ground terminal blocks have the same shape and pitch as the standard terminal block, in a green-yellow housing. They easily snap

onto the DIN rail to make a reliable mechanical and electrical contact that meets all requirements of IEC 60-947-7-2.

Product Selection

XBUT4D12PE



Screw Connection Multi-Conductor Ground Blocks—Three-Wire

Terminal Width	Maximum Wire Size	IEC 60 947-7-1 in V/A/AWG	UL-cUL Ratings in V/A/AWG	Colour	Standard Pack	Catalogue Number
5.2 mm	12 AWG/2.5 mm ²	—/—/26-12	—/—/26-12	Green/Yellow	50	XBUT25D12PE
6.2 mm	10 AWG/4 mm ²	—/—/26-10	—/—/26-10	Green/Yellow	50	XBUT4D12PE

XBUT25D22PE



Screw Connection Multi-Conductor Ground Blocks—Four-Wire

Terminal Width	Maximum Wire Size	IEC 60 947-7-1 in V/A/AWG	UL-cUL Ratings in V/A/AWG	Colour	Standard Pack	Catalogue Number
5.2 mm	12 AWG/2.5 mm ²	—/—/26-12	—/—/26-12	Green/Yellow	50	XBUT25D22PE
6.2 mm	10 AWG/4 mm ²	—/—/26-10	—/—/26-10	Green/Yellow	50	XBUT4D22PE

Accessories

Screw Connection Multi-Conductor Ground Blocks

Description	Colour	Number of Positions	Standard Pack	XBUT25D12PE	XBUT4D12PE	XBUT25D22PE	XBUT4D22PE
				Catalogue Number	Catalogue Number	Catalogue Number	Catalogue Number
End cover	Gray	—	10	XBACUT4D12	XBACUT4D12	XBACUT4D22	XBACUT4D22
End cover segment	Gray	—	10	XBASUT4	XBASUT4	XBASUT4	XBASUT4
Partition plate	—	—	10	XBATUTD12	XBATUTD12	XBATUTD22	XBATUTD22
Plug-in bridge—for cross connections in the bridge shaft	Red	2	10	XBAFBS25	XBAFBS26	XBAFBS25	XBAFBS26
		3	10	XBAFBS35	XBAFBS36	XBAFBS35	XBAFBS36
		5	10	XBAFBS55	XBAFBS56	XBAFBS55	XBAFBS56
		10	10	XBAFBS105	XBAFBS106	XBAFBS105	XBAFBS106
		50	10	XBAFBS505	XBAFBS506	XBAFBS505	XBAFBS506
Test adapter	—	—	10	XBATSPA14	XBATSPA14	XBATSPA14	XBATSPA14
2.3 mm diameter test plug	—	—	—	XBATSMPS-^①	XBATSMPS-^①	XBATSMPS-^①	XBATSMPS-^①
Modular test plug	—	—	10	XBATSPS5	XBATSPS6	XBATSPS5	XBATSPS6
Blank marker strip (strip of 10)	White	—	10	XBMZB5^②	XBMZB6^②	XBMZB5^②	XBMZB6^②

42

Technical Data and Specifications

Screw Connection Multi-Conductor Ground Blocks

Description	XBUT25D12PE	XBUT4D12PE	XBUT25D22PE	XBUT4D22PE
Technical Data in Accordance with IEC				
Maximum load current in A/cross-section in mm ²	—	—	—	—
Rated surge voltage in kV/contamination class	6/3	6/3	6/3	6/3
Surge voltage category/insulating material group	III/I	III/I	III/I	III/I
Connection Capacity				
Stranded with ferrule/with ferrule and plastic sleeve in mm ²	0.25–2.5/0.25–2.5	0.25–4/0.25–4	0.25–2.5/0.25–2.5	0.25–4/0.25–4
Multi-Conductor Connection (same cross-section)				
Solid/stranded in mm ²	0.14–1.0/0.14–1.0	0.14–1.0/0.14–1.5	0.14–1.0/0.14–1.0	0.14–1.0/0.14–1.5
Stranded with ferrules without plastic sleeve in mm ²	0.25–1.0	0.25–1.5	0.25–1.0	0.25–1.5
Stranded with twin ferrule with plastic sleeve in mm ²	0.5–1.0	0.5–1.0	0.5–1	0.5–1
Stripping length in inches (mm)	0.31 (8)	0.31 (8)	0.31 (8)	0.31 (8)
Thread	M3	M3	M3	M3
Torque in in-lb (Nm)	5.3–7.1 (0.6–0.8)	5.3–7.1 (0.6–0.8)	5.3–7.1 (0.6–0.8)	5.3–7.1 (0.6–0.8)

Dimensions

Approximate Dimensions in Inches (mm)

Screw Connection Multi-Connector Ground Blocks

Catalogue Number	Width	Length	Cover Width	Height for—	
				35 x 7.5 in	35 x 15 in
XBUT25D12PE	0.20 (5.2)	2.24 (56.8)	0.09 (2.2)	1.87 (47.5)	2.17 (55.0)
XBUT4D12PE	0.20 (5.2)	2.24 (56.8)	0.09 (2.2)	1.87 (47.5)	2.17 (55.0)
XBUT25D22PE	0.20 (5.2)	2.52 (64.1)	0.09 (2.2)	1.87 (47.5)	2.17 (55.0)
XBUT4D22PE	0.24 (6.2)	2.52 (64.1)	0.09 (2.2)	1.87 (47.5)	2.17 (55.0)

Notes

① For ordering information, see **Page T42-105**.② For information on Printed Marking Tag Options, see **Page T42-98**.For additional accessories, see **Page T42-90**.

Double Level



Contents

Description	Page
Single Level—Through-Feed	T42-5
Single Level—Ground Blocks	T42-10
Multi-Conductor Terminal Blocks	T42-12
Multi-Conductor Ground Blocks	T42-14
Double Level	
Accessories	T42-17
Technical Data and Specifications	T42-17
Dimensions	T42-17
Triple Level Sensor/Actuator	T42-18
Fuse Terminal Blocks	T42-21
Disconnect and Component Terminal Blocks	T42-24
High Current Blocks	T42-27
Mini Screw Connection	T42-29

Double Level

Product Description

The potentials of the XBUTT double-level terminal blocks are on two levels to reduce space requirements by 50% over single-level terminal

blocks. The XBUTT Series can be bridged on both levels for maximum flexibility. Marking can be provided at each termination point.

Product Selection

XBUTT4



Screw Connection Double Level Blocks, XBUTT4

Terminal Width	Maximum Wire Size	IEC 60 947-7-1 in V/A/AWG	UL-cUL Ratings in V/A/AWG	Colour	Standard Pack	Catalogue Number
Screw Connection Double Level Blocks						
6.2 mm	10 AWG/4 mm ²	800/36/26–10	300/30/26–10	Gray	50	XBUTT4
				Blue	50	XBUTT4BU
				Red	50	XBUTT4RD
Screw Connection Double Level Block (terminal block with potential distribution between the levels)						
6.2 mm	10 AWG/4 mm ²	800/36/26–10	300/30/26–10	Gray	50	XBUTT4PV

XBUTT4PE



Screw Connection Double Level Ground Block, XBUTT4PE

Terminal Width	Maximum Wire Size	IEC 60 947-7-1 in V/A/AWG	UL-cUL Ratings in V/A/AWG	Colour	Standard Pack	Catalogue Number
Screw Connection Double Level—Ground Blocks						
6.2 mm	10 AWG/4 mm ²	—/—/26–10	—/—/26–10	Green/Yellow	50	XBUTT4PE

Accessories

Screw Connection Terminal/Ground Blocks, Double Level

Description	Colour	Number of Positions	Standard Pack	XBUTT4 Catalogue Number	XBUTT4PE Catalogue Number
End cover	Gray	—	10	XBACUTT4	XBACUTT4
End cover segment	Gray	—	10	XBDPUTT4	XBDPUTT4
Partition plate	—	—	10	XBATUTT4	XBATUTT4
Plug-in bridge—for cross connections in the bridge shaft	Red	2	10	XBAFBS26	XBAFBS26
		3	10	XBAFBS36	XBAFBS36
		5	10	XBAFBS56	XBAFBS56
		10	10	XBAFBS106	XBAFBS106
		50	10	XBAFBS506	XBAFBS506
Test adapter	—	—	10	XBATSPA14	XBATSPA14
2.3 mm diameter test plug	—	—	—	XBATSMPS- ^①	XBATSMPS- ^①
Modular test plug	—	—	10	XBATSPS6	XBATSPS6
Blank marker strip (strip of 10)	White	—	10	XBMZB6 ^②	XBMZB6 ^②

Technical Data and Specifications

Screw Connection Double Level

Description	XBUTT4	XBUTT4PE
Technical Data in Accordance with IEC		
Maximum load current in A/cross-section in mm ²	30/6	—/6
Rated surge voltage in kV/contamination class	8/3	6/3
Surge voltage category/insulating material group	III/I	III/I
Connection Capacity		
Stranded with ferrule/with ferrule and plastic sleeve in mm ²	0.25–4/0.25–4	0.25–4/0.25–4
Multi-Conductor Connection (same cross-section)		
Solid/stranded in mm ²	0.14–1.5/0.14–1.5	0.14–1.5/0.14–1.5
Stranded with ferrules without plastic sleeve in mm ²	0.25–1.5	0.25–1.5
Stranded with twin ferrule with plastic sleeve in mm ²	0.5–2.5	0.5–2.5
Stripping length in inches (mm)	0.35 (9)	0.35 (9)
Thread	M3	M3
Torque in in-lb (Nm)	5.3–7.1 (0.6–0.8)	5.3–7.1 (0.6–0.8)

Dimensions

Approximate Dimensions in Inches (mm)

Screw Connection Double Level

Catalogue Number	Width	Length	Cover Width	Height for—	
				35 x 7.5 in	35 x 15 in
XBUTT4	0.24 (6.2)	2.75 (69.9)	0.09 (2.2)	2.56 (65.0)	2.85 (72.5)
XBUTT4PE	0.24 (6.2)	2.75 (69.9)	0.09 (2.2)	2.56 (65.0)	2.85 (72.5)

Notes

① For ordering information, see **Page T42-105**.

② For information on Printed Marking Tag Options, see **Page T42-98**.

For additional accessories, see **Page T42-90**.

Triple Level Sensor/Actuator

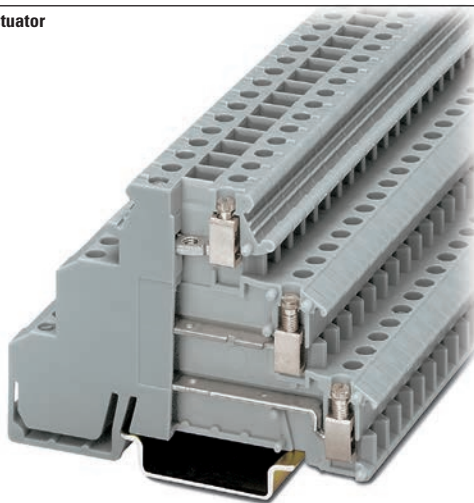

Contents

Description	Page
Single Level—Through-Feed	T42-5
Single Level—Ground Blocks	T42-10
Multi-Conductor Terminal Blocks	T42-12
Multi-Conductor Ground Blocks	T42-14
Double Level	T42-16
Triple Level Sensor/Actuator	
Accessories	T42-19
Technical Data and Specifications	T42-20
Dimensions	T42-20
Fuse Terminal Blocks	T42-21
Disconnect and Component Terminal Blocks	T42-24
High Current Blocks	T42-27
Mini Screw Connection	T42-29

Triple Level Sensor/Actuator

Product Description

The XB3UK sensor terminal blocks reduce installation time by terminating three-wire devices such as photoelectric and proximity sensors in a single terminal block. The XB3UK Series accommodates a design where the positive and negative connections are

grouped so that only the signal lines and one pair of wires for the power supply need to be wired between the terminal box and the control. The upper level accommodates the markable feed-through terminals for the signal line. The two lower terminal points can be

bridged. These are used for the sensor power supply. The positive and negative potential can be fed into the bridges with XB3UKF25. The first sensor can also be connected to this three-wire feed-through block.

Product Selection

XB3UKA25



Screw Connection Triple Level Sensor/Actuator

Terminal Width	Maximum Wire Size	Connection Data in V/A/AWG	IEC 60 947-7-1 in V/A/AWG	UL-cUL Ratings in V/A/AWG	Colour	Standard Pack	Catalogue Number
Screw Connection Triple Level							
6.2 mm	14 AWG/2.5 mm ²	250/26/24-12	—	300/15/30-14	Gray	50	XB3UKA25
Screw Connection Triple Level with Red LED, 15-30 Vdc, 2.5-7.5A							
6.2 mm	14 AWG/2.5 mm ²	250/26/24-12	—	300/15/30-14	Gray	50	XB3UKA25L24

XB3UKF25

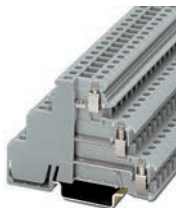

Screw Connection Triple Level Sensor/Actuator

Terminal Width	Maximum Wire Size	Connection Data in V/A/AWG	IEC 60 947-7-1 in V/A/AWG	UL-cUL Ratings in V/A/AWG	Colour	Standard Pack	Catalogue Number
Screw Connection Triple Level							
6.2 mm	14 AWG/2.5 mm ²	—	250/30/24-12	300/15/30-14	Gray	50	XB3UKF25

XB3UKA25PE



Screw Connection Triple Level Sensor/Actuator

Terminal Width	Maximum Wire Size	Connection Data in V/A/AWG	UL-cUL Ratings in V/A/AWG	Colour	Standard Pack	Catalogue Number
Screw Connection Triple Level						
6.2 mm	14 AWG/2.5 mm ²	250/26/24–12	300/15/30–14	Gray	50	XB3UKA25PE
Screw Connection Triple Level with Red LED, 15–30 Vdc, 2.5–7.5A						
6.2 mm	14 AWG/2.5 mm ²	250/26/24–12	300/15/30–14	Gray	50	XB3UKA25PEL24

XB3UKF25PE



Screw Connection Triple Level Sensor/Actuator

Terminal Width	Maximum Wire Size	Connection Data in V/A/AWG	UL-cUL Ratings in V/A/AWG	Colour	Standard Pack	Catalogue Number
Screw Connection Triple Level						
6.2 mm	14 AWG/2.5 mm ²	—	300/15/30–14	Gray	50	XB3UKF25PE

Accessories

Screw Connection Triple Level Sensor/Actuator

Description	Colour	Number of Positions	Standard Pack	XB3UKA25	XB3UKF25	XB3UKA25PE	XB3UKF25PE
				Catalogue Number	Catalogue Number	Catalogue Number	Catalogue Number
Insertion bridge	Blue	80	1	XBAEB80DIKB	XBAEB80DIKB	XBAEB80DIKB	XBAEB80DIKB
	Red	80	1	XBAEB80DIKR	XBAEB80DIKR	XBAEB80DIKR	XBAEB80DIKR
Insertion bridge	Blue	10	10	XBAEB10DIKB	XBAEB10DIKB	XBAEB10DIKB	XBAEB10DIKB
	Red	10	10	XBAEB10DIKR	XBAEB10DIKR	XBAEB10DIKR	XBAEB10DIKR
Blank marker strip (strip of 10)	White	—	10	XBMZB6 ①	XBMZB6 ②	XBMZB6 ②	XBMZB6 ②

Notes

① For information on Printed Marking Tag Options, see **Page T42-98**.

For additional accessories, see **Page T42-90**.

Technical Data and Specifications

Screw Connection Triple Level Sensor/Actuator

Description	XB3UKA25	XB3UKF25	XB3UKA25PE	XB3UKF25PE
Technical Data in Accordance with IEC				
Maximum load current in A/cross-section in mm ²	26/2.5	30/4	26/2.5	26/2.5
Maximum cross section with insertion bridge solid/stranded in mm ²	4/2.5	4/2.5	4/2.5	4/2.5
Rated surge voltage in kV/contamination class	4/3	4/3	4/3	6/3
Surge voltage category/insulating material group	III/1	III/1	III/1	III/1
Connection Capacity				
Stranded with ferrule/with ferrule and plastic sleeve in mm ²	0.25–2.5/0.25–2.5	0.25–2.5/0.25–2.5	0.25–2.5/0.25–2.5	0.25–2.5/0.25–2.5
Multi-Conductor Connection (same cross-section)				
Solid/stranded in mm ²	0.2–1.0/0.2–1.0	0.2–1.0/0.2–1.0	0.2–1.0/0.2–1.0	0.2–1.0/0.2–1.0
Stranded with ferrules without plastic sleeve in mm ²	0.25–1.0	0.25–1.0	0.25–1.0	0.25–1.0
Stranded with twin ferrule with plastic sleeve in mm ²	0.5–1.0	0.5–1.0	0.5–1.0	0.5–1.0
Stripping length in inches (mm)	0.31 (8)	0.31 (8)	0.31 (8)	0.31 (8)
Thread	M3	M3	M3	M3
Torque in in-lb (Nm)	4.4–5.3 (0.5–0.6)	4.4–5.3 (0.5–0.6)	4.4–5.3 (0.5–0.6)	4.4–5.3 (0.5–0.6)

Wiring for Three-Level Sensor Terminal Blocks

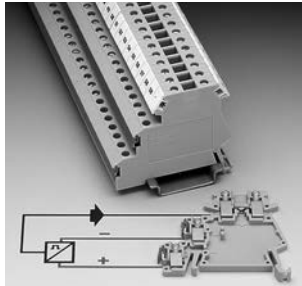

Wiring for Four-Level Sensor Terminal Blocks

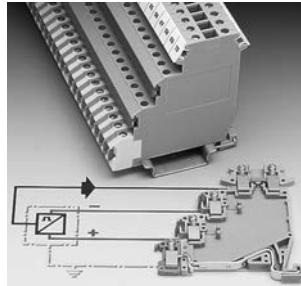

Dimensions

Approximate Dimensions in Inches (mm)

Screw Connection Triple Level Sensor/Actuator

Catalogue Number	Width	Length	Height for—	
			35 x 7.5 in	35 x 15 in
XB3UKA25	0.24 (6.2)	2.17 (55.0)	2.15 (54.5)	2.44 (62.0)
XB3UKF25	0.24 (6.2)	2.85 (72.5)	2.15 (54.5)	2.44 (62.0)
XB3UKA25PE	0.24 (6.2)	2.46 (62.5)	2.76 (70.0)	3.05 (77.5)
XB3UKF25PE	0.24 (6.2)	3.25 (82.5)	2.76 (70.0)	3.05 (77.5)

Fuse Terminal Blocks



Contents

Description	Page
Single Level—Through-Feed	T42-5
Single Level—Ground Blocks	T42-10
Multi-Conductor Terminal Blocks	T42-12
Multi-Conductor Ground Blocks	T42-14
Double Level.....	T42-16
Triple Level Sensor/Actuator	T42-18
Fuse Terminal Blocks	
Accessories	T42-23
Technical Data and Specifications	T42-23
Dimensions	T42-23
Disconnect and Component Terminal Blocks	T42-24
High Current Blocks	T42-27
Mini Screw Connection	T42-29

Fuse Terminal Blocks

Product Description

The UT Series fuse terminal blocks come in two varieties—lever type and cap. Each performs two functions. They act as a fuse carrier for most common North American and European fuses and they

allow for potential distribution with the double bridge shaft. The terminal blocks therefore allow bypass routing of two separate potentials next to each other. This has the advantage of a time-saving

potential infeed and a correct, functional configuration of the terminal strip. For signaling a triggered fuse, fuse terminal blocks with light indicators are available (for both AC and DC voltage).

Product Selection

XBUT4FBE



Screw Connection Fuse Terminal Blocks, for 5 x 20 mm Fuse

Terminal Width	Maximum Wire Size	IEC 60 947-7-3 in V/A/AWG	UL-cUL Ratings in V/A/AWG	Colour	Standard Pack	Catalogue Number
Fuse Terminal Blocks						
6.2 mm	10 AWG/4 mm ²	①/6.3/26–10	600/6.3/26–10	Black	50	XBUT4FBE
Fuse Terminal Blocks with LED 12–30V, 1–2.5 mA						
6.2 mm	10 AWG/4 mm ²	①/6.3/26–10	600/6.3/26–10	Black	50	XBUT4FBEL24
Fuse Terminal Blocks with LED 30–60V, 0.8–2.0 mA						
6.2 mm	10 AWG/4 mm ²	①/6.3/26–10	600/6.3/26–10	Black	50	XBUT4FBEL60
Fuse Terminal Blocks with LED 110–250V, 0.5–2.5 mA						
6.2 mm	10 AWG/4 mm ²	①/6.3/26–10	600/6.3/26–10	Black	50	XBUT4FBEL250

Note

① As disconnect terminal block 400V, as fuse terminal block 250V.

XBUT6FBN



Screw Connection Fuse Terminal Blocks for 6.3 x 32 mm (1/4 in x 1-1/4 in) Fuse

Terminal Width	Maximum Wire Size	IEC 60 947-7-3 in V/A/AWG	UL-cUL Ratings in V/A/AWG	Colour	Standard Pack	Catalogue Number
Fuse Terminal Blocks						
8.2 mm	8 AWG/6 mm ²	①/10/24-8	400/10/24-8	Black	50	XBUT6FBN
Fuse Terminal Blocks with LED 12-30V, 1-2.5 mA						
8.2 mm	8 AWG/6 mm ²	①/10/24-8	400/10/24-8	Black	50	XBUT6FBNL24
Fuse Terminal Blocks with LED 30-60V, 0.8-2.0 mA						
8.2 mm	8 AWG/6 mm ²	①/10/24-8	400/10/24-8	Black	50	XBUT6FBNL60
Fuse Terminal Blocks with LED 110-250V, 0.5-2.5 mA						
8.2 mm	8 AWG/6 mm ²	①/10/24-8	400/10/24-8	Black	50	XBUT6FBNL250

XBUK10FBCE



Screw Connection Fuse Terminal Blocks, XBUK10FBC

Terminal Width	Maximum Wire Size	IEC 60 947-7-3 with Fuse in V/A/AWG	IEC 60 947-7-3 as Disconnected t.b. in V/A/AWG	UL-cUL Ratings in V/A/AWG	Colour	Standard Pack	Catalogue Number
Fuse Terminal Blocks for 5 x 20 mm fuse							
12 mm	6 AWG/16 mm ²	①/①/20-4	800/10/20-6	300/20/22-6	Black	50	XBUK10FBCE
Fuse Terminal Blocks for 6.3 x 32 mm (1/4 in x 1-1/4 in) fuse							
12 mm	6 AWG/16 mm ²	①/①/20-4	800/10/20-6	300/20/22-6	Black	50	XBUK10FBCN
Fuse Terminal Blocks with Light Indicator 15-30V, 1-2.5 mA, 5 x 20 mm							
12 mm	6 AWG/16 mm ²	①/①/20-4	800/10/20-6	300/20/22-6	Black	50	XBUK10FBCEL24
Fuse Terminal Blocks with Light Indicator 15-30V, 1-2.5 mA, 6.3 x 32 mm							
12 mm	6 AWG/16 mm ²	①/①/20-4	800/10/20-6	300/20/22-6	Black	50	XBUK10FBCNL24
Fuse Terminal Blocks with Light Indicator 110-250V, 0.5-1.1A, 5 x 20 mm							
12 mm	6 AWG/16 mm ²	①/①/20-4	800/10/20-6	300/20/22-6	Black	50	XBUK10FBCEL250
Fuse Terminal Blocks with Light Indicator 110-250V, 0.5-1.1A, 6.3 x 32 mm							
12 mm	6 AWG/16 mm ²	①/①/20-4	800/10/20-6	300/20/22-6	Black	50	XBUK10FBCNL250

Cartridge Fuse Inserts 5 x 20 mm Based on DIN EN 60 947-7-3: 2003-7

Terminal Blocks	U (V)	Overload Protection		Short-Circuit Protection Only		I _{max.} (A)
		Individual	Interconnected	Individual	Interconnected	
XBUT4FBE	250	1.6W	1.6W	4W	2.5W	6.3

Notes

Max. power dissipation at 73.4°F (23°C) based on DIN EN 60 947-7-3: 2003-7.

When selecting cartridge fuse inserts, please ensure that the maximum power dissipation specified above is not exceeded. Details can be obtained from the fuse suppliers.

If the fuse is defective, the downstream circuit is not off load.

① As disconnect terminal block 500V, as fuse terminal block 400V.

Accessories

Screw Connection Fuse Terminal Blocks

Description	Colour	Number of Positions	Standard Pack	XBUT4FBE Catalogue Number	XBUT6FBN Catalogue Number	XBUK10FBCE Catalogue Number
End cover	—	—	—	①	①	—
Plug-in bridge—for cross connections in the bridge shaft	Red	2	10	XBAFBS26	XBAFBS28	—
		3	10	XBAFBS36	XBAFBS38	—
		5	10	XBAFBS56	XBAFBS58	—
		10	10	XBAFBS106	XBAFBS108	—
		50	10	XBAFBS506	—	—
Blank marker strip centre labeling (strip of 10)	White	—	—	XBMZB5 ②	XBMZB6 ②	—
Blank marker strip external labeling (strip of 10)	White	—	—	XBMZB6 ②	XBMZB8 ②	—
Fixed bridge	—	2	10	—	—	XBAFBI212
Screw heads with insulating collar	—	10	10	—	—	XBAFBI1012
Blank marker strip (strip of 10)	White	—	10	—	—	XBMZB6 ②

Technical Data and Specifications

Screw Connection Fuse Terminal Blocks

Description	XBUT4FBE	XBUT4FBN	XBUK10FBCE
Technical Data in Accordance with IEC			
Fuse type/dimensions in (mm)	—	—	G/5 x 20/5 x 25/6.3 x 32
Maximum cross section with insertion bridge solid/stranded in mm ²	6.3/6	10/10	10/10
Rated surge voltage in kV/contamination class	4/3	4/3	4/3
Surge voltage category/insulating material group	III/II	III/II	III/I
Connection Capacity			
Stranded with ferrule/with ferrule and plastic sleeve in mm ²	0.25–4/0.25–4	0.25–6/0.25–6	0.5–10/0.5–10
Multi-Conductor Connection (same cross-section)			
Solid/stranded in mm ²	0.14–1.5/0.14–1.5	—	0.5–4/0.5–4
Stranded with ferrules without plastic sleeve in mm ²	0.25–1.5	—	0.5–4
Stranded with twin ferrule with plastic sleeve in mm ²	0.5–2.5	0.5–4	0.5–10
Stripping length in inches (mm)	0.35 (9)	0.39 (10)	0.43 (11)
Thread	M3	M4	M4
Torque in in-lb (Nm)	5.3–7.1 (0.6–0.8)	13.3–15.9 (1.5–1.8)	13.3–15.9 (1.5–1.8)

Dimensions

Approximate Dimensions in Inches (mm)

Screw Connection Fuse Terminal Blocks

Catalogue Number	Width	Length	Height for—		
			35 x 7.5 in	35 x 15 in	32 in
XBUT4FBE	0.24 (6.2)	2.24 (56.8)	2.87 (73.0)	3.17 (80.5)	—
XBUT4FBN	0.32 (8.2)	2.24 (56.8)	2.87 (73.0)	3.17 (80.5)	—
XBUK10FBCE	0.47 (12.0)	2.44 (62.0)	2.32 (59.0)	2.62 (66.5)	2.52 (64.0)

Notes

① XBUT4FBE and XBUT6FBN have an enclosed design. The use of an end cover is not required.

② For information on Printed Marking Tag Options, see **Page T42-98**.

For additional accessories, see **Page T42-90**.

Disconnect and Component Terminal Blocks

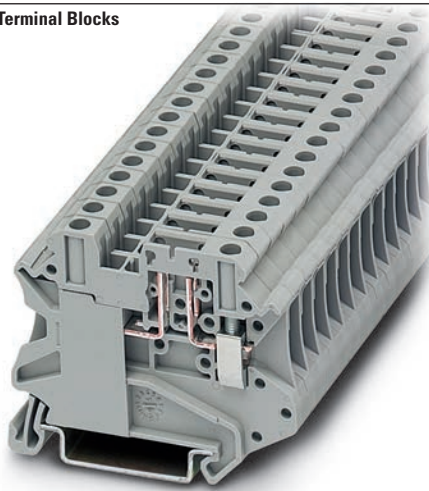

Contents

<i>Description</i>	<i>Page</i>
Single Level—Through-Feed	T42-5
Single Level—Ground Blocks	T42-10
Multi-Conductor Terminal Blocks	T42-12
Multi-Conductor Ground Blocks	T42-14
Double Level	T42-16
Triple Level Sensor/Actuator	T42-18
Fuse Terminal Blocks	T42-21
Disconnect and Component Terminal Blocks	
Product Selection	T42-25
Accessories	T42-26
Technical Data and Specifications	T42-26
Dimensions	T42-26
High Current Blocks	T42-27
Mini Screw Connection	T42-29

Disconnect and Component Terminal Blocks

Product Description

The **XB** Series includes application specific terminal blocks like the XBUT4TG disconnect block that accommodates disconnect component and fuse terminal blocks. It can also be bridged with standard terminal blocks via the double bridge shaft. The component plug XBPCO serves to accommodate different components such as resistors or capacitors.

5 x 20 mm fuses can be inserted into the fuse plug XBPFU, also available with light indication. The XBUT4MT knife disconnect terminal block features a compact design and a high current carrying capacity of 16A. Versions with test socket screws provide a test option for 2.3 mm diameter test plugs on both sides of the disconnect point.

Product Selection

XBUT4TG
Disconnect

Screw Connection Disconnect and Component Terminal Blocks

Terminal Width	Maximum Wire Size	Connection Data in V/A/AWG	UL-cUL Ratings for Disconnect in V/A/AWG	UL-cUL Ratings for Disconnect with Test Sockets in V/A/AWG	Colour	Standard Pack	Catalogue Number
Screw Connection Disconnect							
6.2 mm	10 AWG/4 mm ²	500/16/26–10	600/16/26–10	300/16/26–10	Gray	50	XBUT4TG
Screw Connection Disconnect with Test Sockets							
6.2 mm	10 AWG/4 mm ²	500/16/26–10	600/16/26–10	300/16/26–10	Gray	50	XBUT4TGP
Component Plug							
6.2 mm	10 AWG/4 mm ²	500/16/26–10	600/16/26–10	300/16/26–10	Gray	10	XBPCO
Fuse Plug							
6.2 mm	10 AWG/4 mm ²	500/16/26–10	600/16/26–10	300/16/26–10	Black	10	XBPFU
Fuse Plug with Light Indicator for 12–30V, 1–2.5 mA							
6.2 mm	10 AWG/4 mm ²	500/16/26–10	600/16/26–10	300/16/26–10	Black	10	XBPFUL24
Fuse Plug with Light Indicator for 110–250V, 0.5–2.5 mA							
6.2 mm	10 AWG/4 mm ²	500/16/26–10	600/16/26–10	300/16/26–10	Black	10	XBPFUL250
Screw Connection Disconnect Knife Disconnect							
6.2 mm	10 AWG/4 mm ²	500/16/26–10	600/16/26–10	300/16/26–10	Gray	50	XBUT4MT
Screw Connection Disconnect Knife Disconnect with Test Sockets							
6.2 mm	10 AWG/4 mm ²	500/16/26–10	600/16/26–10	300/16/26–10	Gray	50	XBUT4MTP
Screw Connection Terminal Blocks with Integrated Diodes							
6.2 mm	12 AWG/4 mm ²	500/32/24–10	600/30/26–10	—	Gray	50	XBUK4DIO

XBTKT25 Thermal
Electric Voltage

Screw Connection Thermoelectric Voltage Terminal Blocks

Terminal Width	Maximum Wire Size	Connection Data in V/A/AWG	UL-cUL Ratings in V/A/AWG	Colour	Standard Pack	Catalogue Number
Copper/Constantan (CU/CUNI44)						
10.4 mm	12 AWG/2.5 mm ²	400/—/24–12	300/10/28–12	Gray	50	XBTKT25 (Type T)
Iron/Constantan (FE/CUNI44)						
10.4 mm	12 AWG/2.5 mm ²	400/—/24–12	300/10/28–12	Gray	50	XBTKJ25 (Type J)
Nickel-Chrome/Constantan (NICR/CUNI44)						
10.4 mm	12 AWG/2.5 mm ²	400/—/24–12	300/10/28–12	Gray	50	XBTK25 (Type E)
Nickel-Chrome/Nickel (NICRNI)						
10.4 mm	12 AWG/2.5 mm ²	400/—/24–12	300/10/28–12	Gray	50	XBTKK25 (Type K)
Copper/Copper Nickel (E-CU/A-CU)						
10.4 mm	12 AWG/2.5 mm ²	400/—/24–12	300/10/28–12	Gray	50	XBTKR25 (Type R)

Accessories

Screw Connection Disconnect and Component Terminal Blocks

Description	Colour	Number of Positions	Standard Pack	XBUT4TG Catalogue Number	XBUT4MT Catalogue Number	XBUKK4D10 Catalogue Number	XBTK25 Catalogue Number
Plug-in bridge—for cross connections in the bridge shaft	Red	2	10	XBAFBS26	XBAFBS26	—	—
		3	10	XBAFBS36	XBAFBS36	—	—
		5	10	XBAFBS56	XBAFBS56	—	—
		10	10	XBAFBS106	XBAFBS106	—	—
		50	10	XBAFBS506	XBAFBS506	—	—
Test adapter	—	—	10	XBATSPA14	XBATSPA14	—	—
2.3 mm diameter test plug	—	—	—	XBATSMPS- ^①	XBATSMPS- ^①	—	—
Modular test plug	—	—	10	XBATSDPPS6	XBATSDPPS6	—	—
Blank marker strip (strip of 10)	White	—	10	XBMZB6 ^②	XBMZB6 ^②	XBMZB6 ^②	XBMZB10 ^②
End cover	Gray	—	10	—	—	XBACUKK35	XBACTK4
Spacer cover	Gray	—	10	—	—	XBADGUKK35	—
Spacer plate	—	—	10	—	—	XBADPUKK35	—
Partition plate	—	—	—	—	—	—	XBATTK4
Fixed bridge	—	10	10	—	—	XBAFBI106	—

Technical Data and Specifications

Screw Connection Disconnect and Component Terminal Blocks

Description	XBUT4TG	XBUT4MT	XBUKK4D10	XBTK
Technical Data in Accordance with IEC				
Maximum load current in A/cross-section in mm ²	16/6	16/6	32/4	—
Rated surge voltage in kV/contamination class	6/3	6/3	6/3	—
Surge voltage category/insulating material group	III/I	III/I	III/I	—
Connection Capacity				
Stranded with ferrule/with ferrule and plastic sleeve in mm ²	0.25–4/0.25–4	0.25–4/0.25–4	0.25–4/0.25–2.5	—
Multi-Conductor Connection (same cross-section)				
Solid/stranded in mm ²	0.14–1.5/0.14–1.5	0.14–1.5/0.14–1.5	0.2–1.5/0.2–1.5	—
Stranded with ferrules without plastic sleeve in mm ²	0.25–1.5	0.25–1.5	0.25–1.5	—
Stranded with twin ferrule with plastic sleeve in mm ²	0.5–2.5	0.5–2.5	0.5–1.5	—
Stripping length in inches (mm)	0.35 (9)	0.35 (9)	0.31 (8)	0.28 (7)
Thread	M3	M3	M3	M3
Torque in in-lb (Nm)	5.3–7.1 (0.6–0.8)	5.3–7.1 (0.6–0.8)	5.3–7.1 (0.6–0.8)	5.3–7.1 (0.6–0.8)

Dimensions

Approximate Dimensions in Inches (mm)

Screw Connection Disconnect and Component Terminal Blocks

Catalogue Number	Width	Length	Cover Width	Height for—		
				35 x 7.5 in	35 x 15 in	32 in
XBUT4TG	0.24 (6.2)	2.24 (56.8)	—	1.87 (47.5)	2.17 (55.0)	—
XBUT4MT	0.24 (6.2)	2.24 (56.8)	—	1.87 (47.5)	2.17 (55.0)	—
XBUKK4D10	0.24 (6.2)	2.20 (56.0)	0.10 (2.5)	2.44 (62.0)	2.74 (69.5)	2.64 (67.0)
XBTK	0.20 (5.2)	1.81 (46.0)	0.04 (1.0)	1.57 (40.0)	1.87 (47.5)	1.77 (45.0)

Notes

① For ordering information, see Page T42-105.

② For information on Printed Marking Tag Options, see Page T42-98.

For additional accessories, see Page T42-90.

High Current Blocks

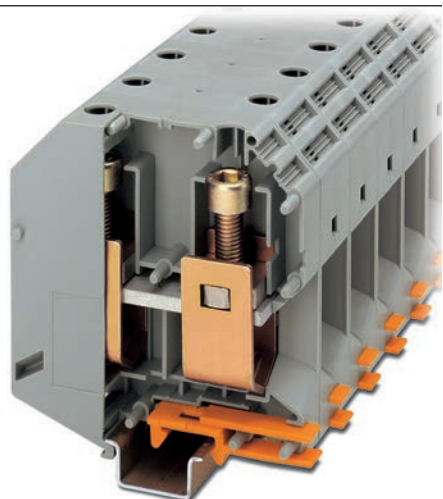

Contents

Description	Page
Single Level—Through-Feed	T42-5
Single Level—Ground Blocks	T42-10
Multi-Conductor Terminal Blocks	T42-12
Multi-Conductor Ground Blocks	T42-14
Double Level	T42-16
Triple Level Sensor/Actuator	T42-18
Fuse Terminal Blocks	T42-21
Disconnect and Component Terminal Blocks	T42-24
High Current Blocks	
Accessories	T42-28
Technical Data and Specifications	T42-28
Dimensions	T42-28
Mini Screw Connection	T42-29

High Current Blocks

Product Description

Eaton's XBUK high current terminal blocks offer a reliable connection via the superior construction that includes three-point centering of the wire in the

prism-shaped sleeve base, a fluted contact surface for low contact resistance, and screws secured with spring-loaded elements. The terminal blocks have

an enclosed housing made from polyamide 6.6. Green-yellow ground terminal blocks are also available.

Product Selection

XBUK150



Screw Connection High Current Blocks

Terminal Width	Maximum Wire Size	IEC 60 947-7-1 in V/A/AWG	EN 50 019 ① in V/A/AWG	UL-cUL Ratings in V/A/AWG	Colour	Standard Pack	Catalogue Number
20.0 mm	1/0/50 mm ²	1000/150/1/0	750/135/1/0	600/150/1/0	Gray	10	XBUK50
					Blue	10	XBUK50BU
31.0 mm	300 kcmil/150 mm ²	1000/309/2-300	726/265/2-300	600/285/ 2 AWG-300 kcmil	Gray	10	XBUK150

XBUK95PE



Screw Connection High Current Ground Blocks

Terminal Width	Maximum Wire Size	IEC 60 947-7-1 in V/A/AWG	EN 50 019 ① in V/A/AWG	UL-cUL Ratings in V/A/AWG	Colour	Standard Pack	Catalogue Number
25.0 mm	000 AWG/95 mm ²	—/232/4-000	—/—/4-000	—/—/2-4/0	Green/Yellow	10	XBUK95PE

Note

① U type—examination certificate number: KEMA 05ATEX2170 U (XBUK50), KEMA 05ATEX2171 U (XBUK150).

Accessories

Screw Connection High Current Blocks

Description	Colour	Number of Positions	Standard Pack	XBUK50 Catalogue Number	XBUK150 Catalogue Number	XBUK95PE Catalogue Number
Fixed bridge, screw heads with insulating colour	—	2	10	XBAFBI220	—	—
Insertion bridge	—	2	10	—	XBAEB231	—
Blank marker strip external labeling (strip of 10)	White	—	10	XBMZB10 ①	XBMZB10 ①	XBMZB10 ①

Technical Data and Specifications

Screw Connection High Current Blocks

Description	XBUK50	XBUK150	XBUK95PE
Technical Data in Accordance with IEC			
Maximum load current in A/cross-section in mm ²	150/50	309/150	232/95
Maximum cross-section with insertion bridge solid/stranded in mm ²	—/—	150/120	—/—
Rated surge voltage in kV/contamination class	8/3	8/3	8/3
Surge voltage category/insulating material group	III/I	III/I	III/I
Connection Capacity			
Stranded with ferrule/with ferrule and plastic sleeve in mm ²	25–50/25–50	50–150/50–150	35–95/35–95
Multi-Conductor Connection (same cross-section)			
Solid/stranded in mm ²	10–16/10–16	25–50/35–50	25–35/25–35
Stranded with ferrules without plastic sleeve in mm ²	10–16	25–50	16–35
Stripping length in inches (mm)	0.94 (24)	1.57 (40)	1.18 (30)
Thread	M6	M10	M8
Terminal point—thread/torque in in-lb (Nm)	53–71 (6–8)	221–267 (25–30)	133–177 (15–20)
Fastening—thread/torque in in-lb (Nm)	53–71 (6–8)	221–267 (25–30)	133–177 (15–20)

Dimensions

Approximate Dimensions in Inches (mm)

Screw Connection High Current Blocks

Catalogue Number	Width	Length	Height for—		
			35 x 7.5 in	35 x 15 in	32 in
XBUK50	0.79 (20.0)	2.78 (70.5)	3.29 (83.5)	3.21 (81.5)	—
XBUK150	1.22 (31.0)	3.94 (100.0)	4.67 (118.5)	4.57 (116.0)	—
XBUK95PE	0.98 (25.0)	3.27 (83.0)	—	3.90 (99.0)	3.80 (96.5)

Notes

① For information on Printed Marking Tag Options, see Page T42-98.

For additional accessories, see Page T42-90.

Mini Screw Connection Terminal Blocks

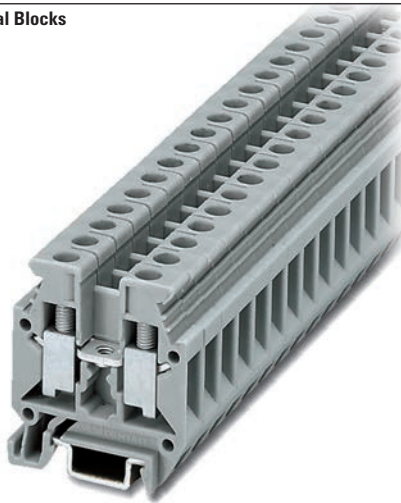

Contents

Description	Page
Single Level—Through-Feed	T42-5
Single Level—Ground Blocks	T42-10
Multi-Conductor Terminal Blocks	T42-12
Multi-Conductor Ground Blocks	T42-14
Double Level.	T42-16
Triple Level Sensor/Actuator	T42-18
Fuse Terminal Blocks	T42-21
Disconnect and Component Terminal Blocks	T42-24
High Current Blocks	T42-27
Mini Screw Connection	
Accessories	T42-30
Technical Data and Specifications	T42-30
Dimensions	T42-30

Mini Screw Connection

Product Description

The **XB** miniature terminal blocks have a connection cross-section from 2 mm² through 4 mm² and mount on 15 mm DIN rail. There is an

opening for bridging with a fixed bridge in the centre of the terminal blocks. These miniature terminal blocks also offer the same accessories

that you would find with the larger blocks—including marking tags, end covers, end stop and ground blocks.

Product Selection

XBMUK4



Mini Screw Connection Terminal Blocks

Terminal Width	Maximum Wire Size	IEC 60 947-7-1 in V/A/AWG	EN 50 019 ① in V/A/AWG	UL-cUL Ratings in V/A/AWG	Colour	Standard Pack	Catalogue Number
5.2 mm	12 AWG/2.5 mm ²	400/32/24–12	275/28/21/24–12	600/20/28–12	Gray	50	XBMUK25
					Blue	50	XBMUK25BU
6.2 mm	10 AWG/4 mm ²	500/41/24–10	—/—/—	600/10/26–10	Gray	50	XBMUK4
					Blue	50	XBMUK4BU

XBMUK25PE



Mini Screw Connection Ground Blocks

Terminal Width	Maximum Wire Size	IEC 60 947-7-2 in V/A/AWG	UL-cUL Ratings in V/A/AWG	Colour	Standard Pack	Catalogue Number
5.2 mm	12 AWG/2.5 mm ²	—/—/24–12	—/—/30–12	Green/ Yellow	50	XBMUK25PE
6.2 mm	10 AWG/2.4 mm ²	—/—/24–10	—/—/26–14	Green/ Yellow	50	XBMUK4PE

Note

① EU type—examination certificate number: KEMA 05ATEX2169 U (XBMUK25).

Accessories

Mini Screw Connection Terminal/Ground Blocks

Description	Colour	Number of Positions	Standard Pack	XBMUK25 Catalogue Number	XBMUK4 Catalogue Number	XBMUK25PE Catalogue Number	XBMUK4PE Catalogue Number
End cover	Gray	—	10	XBACMU254	XBACMU254	—	—
	Blue	—	10	XBACMU254B	XBACMU254B	—	—
Partition plate	—	—	10	XBATMU254	XBATMU254	—	—
Fixed bridge	—	10	10	XBAFBR105N	—	—	—
Separating plate	—	—	10	XBATMPKK15	XBATMPKK15	—	—
Blank marker strip (strip of 10)	White	—	10	XBMZB5 ①	XBMZB6 ①	XBMZB5 ①	XBMZB6 ①

Technical Data and Specifications

Mini Spring Cage Terminal/Ground Blocks

Description	XBMUK25	XBMUK4	XBMUK25PE	XBMUK4PE
Technical Data in Accordance with IEC				
Maximum load current in A/cross-section in mm ²	32/4	41/6	—	—
Maximum cross-section with insertion bridge (solid/stranded)	2.5/2.5	4/4	—	—
Rated surge voltage in kV/contamination class	6/3	6/3	6/3	6/3
Surge voltage category/insulating material group	III/1	III/1	III/1	III/1
Connection Cross-Section				
Stranded with ferrule with plastic sleeve in mm ²	0.25–1.5	0.25–2.5	0.25–1.5	0.25–2.5
Stranded with ferrule without plastic sleeve in mm ²	0.25–2.5	0.25–4	0.25–2.5	0.25–4
Multi-Conductor Connection (same cross-section)				
Solid/stranded in mm ²	0.2–1.0/0.2–1.5	0.2–1.5/0.2–1.5	0.2–1.0/0.2–1.5	0.2–1.5/0.2–1.5
Stranded with ferrule without plastic sleeve in mm ²	0.25–1.5	0.25–1.5	0.25–1.5	0.25–1.5
Stranded with ferrule with plastic sleeve in mm ²	0.5–1.0	0.5–2.5	0.5–1.5	0.5–2.5
Stripping length in Inches (mm)	0.31 (8)	0.31 (8)	0.31 (8)	0.31 (8)
Thread	M3	M3	M3	M3
Torque in in-lb (Nm)	5.3–7.1 (0.6–0.8)	4.4–5.3 (0.5–0.6)	5.3–7.1 (0.6–0.8)	5.3–7.1 (0.6–0.8)

Dimensions

Approximate Dimensions in Inches (mm)

Mini Spring Cage Terminal/Ground Blocks

Catalogue Number	Width	Length	Cover Length	Height for— 15 in
XBMUK25	0.20 (5.2)	1.10 (28.0)	0.04 (1.0)	1.26 (32.0)
XBMUK4	0.24 (6.2)	1.10 (28.0)	0.04 (1.0)	1.26 (32.0)
XBMUK25PE	0.20 (5.2)	1.10 (28.0)	—	1.24 (31.5)
XBMUK4PE	0.24 (6.2)	1.10 (28.0)	—	1.26 (32.0)

Notes

① For information on Printed Marking Tag Options, see **Page T42-98**.For additional accessories, see **Page T42-90**.

Spring Cage Connection



Contents

Description

Description	Page
Spring Cage Terminal Blocks	
Single Level—Through-Feed	T42-32
Single Level—Ground Blocks	T42-37
Multi-Conductor Terminal Blocks	T42-39
Multi-Conductor Ground Blocks	T42-42
Double Level Blocks	T42-44
Triple Level Blocks	T42-46
Fuse Terminal Blocks	T42-48
Disconnect and Component Terminal Blocks	T42-51
Hybrid Terminal Blocks	T42-54
Mini Spring Cage	T42-56

Spring Cage Terminal Blocks Overview

Product Description

The XBPT Series incorporates a spring cage connection system proven in applications that are sensitive to vibration. The spring mechanism always exerts the same constant force on the wire, resulting in a vibration-proof, gas-tight connection, independent of the user. The space-saving front connection, with the wire and screwdriver coming in parallel from the same direction, allows for simple wiring in places where there is little space available.

Application Description

The connection point is opened with a standard screwdriver. After the wire has been inserted into the wire guide of the terminal block, the screwdriver is removed and the wire automatically makes contact.

Features

- Vibration-resistance
- Global acceptance
- Multi-conductor connections
- Flexible Plug-in bridge system
- Large surface area for marking
- Standardized testing system

Standards and Certifications

- UL recognized—File No. E67464
- CE approved
- LVD ①:
 - EN 60947-7-1
 - EN 60947-7-2
 - EN 60998-2-3
 - EN 60352-4/A1
- ATEX approval (Eex e applications)



Note

① Not all standards apply to all terminal blocks. Contact Eaton for details.

42.1

Terminal Blocks, Fuse Blocks and Fuse Holders

IEC—XB Series

Single Level—Through-Feed

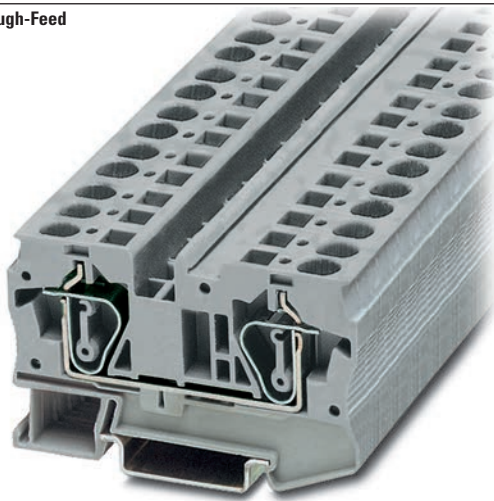

42

Contents

Description

Page

Single Level—Through-Feed	
Accessories	T42-34
Technical Data and Specifications	T42-36
Dimensions	T42-36
Single Level—Ground Blocks	T42-37
Multi-Conductor Terminal Blocks	T42-39
Multi-Conductor Ground Blocks	T42-42
Double Level Blocks	T42-44
Triple Level Blocks	T42-46
Fuse Terminal Blocks	T42-48
Disconnect and Component Terminal Blocks	T42-51
Hybrid Terminal Blocks	T42-54
Mini Spring Cage	T42-56

Single Level—Through-Feed

Product Description

The space-saving design and front entry design make the XBPT Series ideal for control systems where there is little space. Even so, they offer maximum connection space, resulting in fast wiring of stranded and solid conductors with or without ferrules.

XBPT terminal blocks are available with cross-sections from 2.5 mm² up to 35 mm². The double bridge shaft can accommodate individual chain bridging and step-down bridging from other terminal blocks.

Product Selection

XBPT6



Spring Cage Connection Single Level—Through-Feed

Terminal Width	Maximum Wire Size	IEC 60 947-7-1 in V/A/AWG	EN 50 019 ^① in V/A/AWG	UL-cUL Ratings in V/A/AWG	Colour	Standard Pack	Catalogue Number
5.2 mm	12 AWG/2.5 mm ²	800/31/28–12	550/25/21/24–12	600/20/26–12	Gray	50	XBPT25
					Blue	50	XBPT25BU
					White	50	XBPT25WH
					Red	50	XBPT25RD
					Black	50	XBPT25BK
6.2 mm	10 AWG/4 mm ²	800/40/28–10	550/34/30/24–10	600/30/20–10	Gray	50	XBPT4
					Blue	50	XBPT4BU
8.2 mm	8 AWG/6 mm ²	800/52/24–8	550/45/36/20–8	600/50/20–8	Gray	50	XBPT6
					Blue	50	XBPT6BU
10.2 mm	6 AWG/10 mm ²	800/65/24–6	550/50/63/16–6	600/65/16–6	Gray	50	XBPT10
					Blue	50	XBPT10BU
12 mm	4 AWG/16 mm ²	800/90/24–4	550/65/82/16–4	600/50/16–4	Gray	50	XBPT16
					Blue	50	XBPT16BU
16 mm	2 AWG/35 mm ²	800/125/14–2	750/108/14–2	600/115/14–2	Gray	50	XBPT35
					Blue	50	XBPT35BU

Note

^① EU type—examination certificate number: KEMA 05ATEX2158 U.

Accessories

Spring Cage Connection Single Level—Through-Feed, XBPT25, XBPT4 and XBPT6

Description	Colour	Number of Positions	Standard Pack	XBPT25 Catalogue Number	XBPT4 Catalogue Number	XBPT6 Catalogue Number
End cover	Gray	—	10	XBACPT25	XBACPT4	XBACPT6
Partition plate	Gray	—	10	XBATPT4	XBATPT4	XBATPT6
Plug-in bridge—for cross connections in the bridge shaft	Red	2	10	XBAFBS25	XBAFBS26	XBAFBS28
		3	10	XBAFBS35	XBAFBS36	—
		5	10	XBAFBS55	XBAFBS56	—
		10	10	XBAFBS105	XBAFBS106	—
		50	10	XBAFBS505	XBAFBS506	—
Test adapter	—	—	10	XBATSPA14	XBATSPA14	XBATSPA14
2.3 mm diameter test plug	—	—	—	XBATSMPS-^①	XBATSMPS-^①	XBATSMPS-^①
Modular test plug	—	—	10	XBATSPS5	XBATSPS6	XBATSPS8
Blank marker strip external labeling	White	—	10	XBMZBF5^②	XBMZBF6^②	XBMZBF8^②
Blank marker strip centre labeling (strip of 10)	White	—	10	XBMZB5^②	XBMZB6^②	XBMZB8^②

Spring Cage Connection Single Level—Through-Feed, XBPT10, XBPT16 and XBPT35

Description	Colour	Number of Positions	Standard Pack	XBPT10 Catalogue Number	XBPT16 Catalogue Number	XBPT35 Catalogue Number
End cover	Gray	—	10	XBACPT10	XBACPT16	^③
Plug-in bridge—for cross connections in the bridge shaft	Red	2	10	XBAFBS210	XBAFBS212^①	XBAFBS216^②
2.3 mm diameter test plug	—	—	10	XBATSMPS-^①	XBATSMPS-^①	XBATSMPS-^①
Blank marker strip external labeling	White	—	10	XBMZF10^②	XBMZBF12^②	XBMZBF15^②
Blank marker strip centre labeling (strip of 10)	White	—	10	XBMZB10^②	XBMZB12^②	XBMZB15^②

Notes

- ① For ordering information, see **Page T42-105**
 ② For information on Printed Marking Tag Options, see **Page T42-98**.
 ③ XBPT35 has an enclosed design. The use of an end cover is not required.

For additional accessories, see **Page T42-90**.

XBPT with Reducing Bridge

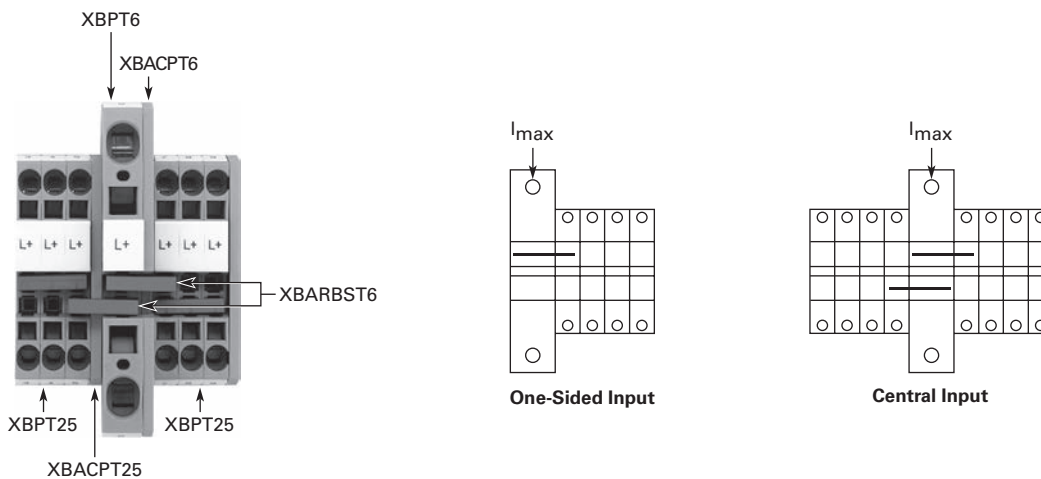

Step-Down Bridge with Standard Feed-Through Terminal Blocks

Input Terminal Blocks	Cross-Section	Pick-Off Terminal Blocks	Cross-Section AWG (mm ²)	One-Sided Input I _{max}	Central Input I _{max}	Bridge Catalogue Number
XBPT6	8 AWG (6 mm ²)	XBPT25	12 (2.5)	40	56	XBARBST6
		XBPT4	10 (4)	45	56	XBARBST6
		XBQT15	14 (1.5)	35	56	XBARBST6
		XBQT25	12 (2.5)	40	56	XBARBST6
XBPT10	6 AWG (10 mm ²)	XBPT25	12 (2.5)	40	65	XBARBST10
		XBPT4	10 (4)	45	65	XBARBST10
		XBQT15	14 (1.5)	35	65	XBARBST10
		XBQT25	12 (2.5)	40	65	XBARBST10
XBPT16	4 AWG (16 mm ²)	XBPT25	12 (2.5)	40	80	XBARBST16
		XBPT4	10 (4)	45	90	XBARBST16
		XBQT15	14 (1.5)	35	70	XBARBST16
		XBQT25	12 (2.5)	40	80	XBARBST16

Technical Data and Specifications

Spring Cage Connection Single Level—Through-Feed

Description	XBPT25	XBPT4	XBPT6	XBPT10	XBPT16	XBPT35
Technical Data in Accordance with IEC						
Maximum load current in A/cross-section in mm ²	31/4	40/6	52/10	65/16	90/25	125/35
Rated surge voltage in kV/contamination class	8/3	8/3	8/3	8/3	8/3	8/3
Surge voltage category/insulating material group	III/I	III/I	III/I	III/I	III/I	III/I
Connection Capacity						
Stranded with ferrule/with ferrule and plastic sleeve in mm ²	0.25–2.5	0.25–4	0.25–6	0.25–10	0.25–16	2.5–35
Stranded with ferrules without plastic sleeve in mm ²	0.25–2.5	0.25–4	0.25–6	0.25–10	0.25–16	2.5–35
Stranded with twin ferrule with plastic sleeve in mm ²	0.5	0.5–1	0.5–1.5	1.5–2.5	1.5–4	2.5–10
Stripping length in inches (mm)	0.39 (10)	0.39 (10)	0.47 (12)	0.71 (18)	0.71 (18)	0.98 (25)

Dimensions

Approximate Dimensions in Inches (mm)

Spring Cage Connection Single Level—Through-Feed

Catalogue Number	Width	Length	Cover Width	Height for—	
				35 x 7.5 in	35 x 15 in
XBPT25	0.20 (5.2)	1.91 (48.5)	0.09 (2.2)	1.45 (36.8)	1.73 (44.0)
XBPT4	0.24 (6.2)	2.20 (56.0)	0.09 (2.2)	1.45 (36.8)	1.73 (44.0)
XBPT6	0.32 (8.2)	2.74 (69.5)	0.09 (2.2)	1.71 (43.5)	2.01 (51.0)
XBPT10	0.39 (10.0)	2.81 (71.5)	0.09 (2.2)	1.99 (50.5)	2.30 (58.5)
XBPT16	0.47 (12.0)	3.15 (80.0)	0.09 (2.2)	2.01 (51.0)	2.30 (58.5)
XBPT35	0.63 (16.0)	3.94 (100.0)	①	2.32 (59.0)	2.62 (66.5)

Note

① XBPT35 has an enclosed design. The use of an end cover is not required.

Single Level—Ground Blocks



Contents

Description	Page
Single Level—Through-Feed	T42-32
Single Level—Ground Blocks	
Accessories	T42-38
Technical Data and Specifications	T42-38
Dimensions	T42-38
Multi-Conductor Terminal Blocks	T42-39
Multi-Conductor Ground Blocks	T42-42
Double Level Blocks	T42-44
Triple Level Blocks	T42-46
Fuse Terminal Blocks	T42-48
Disconnect and Component Terminal Blocks	T42-51
Hybrid Terminal Blocks	T42-54
Mini Spring Cage	T42-56

Single Level—Ground Blocks

Product Description

The XBPT ground blocks are the same shape as the feed-through terminal blocks with the same wide range of cross-sections available. They easily snap onto the

DIN rail to make a reliable mechanical and electrical contact that meets all requirements of IEC 60-947-7-2.

Product Selection

XBPT4PE



Spring Cage Connection Single Level—Ground Blocks

Terminal Width	Maximum Wire Size	IEC 60 947-7-2 in V/A/AWG	EN 50 019 ① in V/A/AWG	UL-cUL Ratings in V/A/AWG	Colour	Standard Pack	Catalogue Number
5.2 mm	12 AWG/2.5 mm ²	—/—/28-12	—/—/24-12	—/—/26-12	Green/Yellow	50	XBPT25PE
6.2 mm	10 AWG/4 mm ²	—/—/28-10	—/—/24-10	—/—/20-10	Green/Yellow	50	XBPT4PE
8.2 mm	8 AWG/6 mm ²	—/—/24-8	—/—/20-8	—/—/20-8	Green/Yellow	50	XBPT6PE
10.2 mm	6 AWG/10 mm ²	—/65/24-6	—/—/16-6	—/—/16-6	Green/Yellow	50	XBPT10PE
12 mm	4 AWG/16 mm ²	—/90/24-4	—/—/16-4 ②	—/—/16-4	Green/Yellow	25	XBPT16PE
16 mm	2 AWG/35 mm ²	—/125/14-2	—/—/14-2 ②	—/—/14-2	Green/Yellow	10	XBPT35PE

Notes

① EU type—examination certificate number: KEMA 05ATEX2154 U (XBPT25PE), KEMA 05ATEX2155 U (XBPT4PE).

② EU type—examination certificate number: KEMA 05ATEX2156 U.

Accessories

Spring Cage Connection Single Level Ground Blocks, XBPT25PE, XBPT4PE and XBPT6PE

Description	Colour	Number of Positions	Standard Pack	XBPT25PE Catalogue Number	XBPT4PE Catalogue Number	XBPT6PE Catalogue Number
End cover	Gray	—	10	XBACPT25	XBACPT4	XBACPT6
Blank marker strip external labeling	White	—	10	XBMZBF5 ①	XBMZBF6 ①	XBMZBF8 ①
Blank marker strip centre labeling (strip of 10)	White	—	10	XBMZB5 ①	XBMZB6 ①	XBMZB8 ①

Spring Cage Connection Single Level Ground Blocks, XBPT10PE, XBPT16PE and XBPT35PE

Description	Colour	Number of Positions	Standard Pack	XBPT10PE Catalogue Number	XBPT16PE Catalogue Number	XBPT35PE Catalogue Number
End cover	Gray	—	10	XBACPT10	XBACPT16	②
Plug-in bridge—for cross connections in the bridge shaft	—	2	10	XBAFBS210	XBAFBS212	XBAFBS216
Blank marker strip external labeling	White	—	10	XBMZBF10 ①	XBMZBF12 ①	XBMZBF15 ①
Blank marker strip centre labeling (strip of 10)	White	—	10	XBMZB10 ①	XBMZB12 ①	XBMZB15 ①

Technical Data and Specifications

Spring Cage Connection Single Level Ground Blocks

Description	XBPT25PE	XBPT4PE	XBPT6PE	XBPT10PE	XBPT16PE	XBPT35PE
Technical Data in Accordance with IEC						
Maximum load current in A/cross-section in mm ²	—	—	—	65/16	90/25	125/35
Rated surge voltage in kV/contamination class	8/3	8/3	8/3	8/3	8/3	8/3
Surge voltage category/insulating material group	III/I	III/I	III/I	III/I	III/I	III/I
Connection Capacity						
Stranded with ferrule with plastic sleeve in mm ²	0.25–2.5	0.25–4	0.25–6	0.25–10	0.25–16	2.5–35
Stranded with ferrules without plastic sleeve in mm ²	0.25–2.5	0.25–4	0.25–6	0.25–10	0.25–16	2.5–35
Stranded with twin ferrule with plastic sleeve in mm ²	0.5	0.5–1	0.5–1.5	1.5–2.5	1.5–4	2.5–10
Stripping length in inches (mm)	0.39 (10)	0.39 (10)	0.47 (12)	0.71 (18)	0.71 (18)	0.98 (25)

Dimensions

Approximate Dimensions in Inches (mm)

Spring Cage Connection Single Level Ground Blocks

Catalogue Number	Width	Length	Cover Width	Height for—	
				35 x 7.5 in	35 x 15 in
XBPT25PE	0.20 (5.2)	1.91 (48.5)	0.09 (2.2)	1.45 (36.8)	1.73 (44.0)
XBPT4PE	0.24 (6.2)	2.20 (56.0)	0.09 (2.2)	1.45 (36.8)	1.73 (44.0)
XBPT6PE	0.32 (8.2)	2.74 (69.5)	0.09 (2.2)	1.71 (43.5)	2.01 (51.0)
XBPT10PE	0.39 (10.0)	2.81 (71.5)	0.09 (2.2)	1.99 (50.5)	2.28 (58.0)
XBPT16PE	0.47 (12.0)	3.15 (80.0)	0.09 (2.2)	2.01 (51.0)	2.30 (58.5)
XBPT35PE	0.63 (16.0)	3.94 (100.0)	—	2.32 (59.0)	2.62 (66.5)

Notes

① For information on Printed Marking Tag Options, see **Page T42-98**.

② XBPT35PE has an enclosed design. The use of an end cover is not required.

For additional accessories, see **Page T42-90**.

Multi-Conductor Terminal Blocks

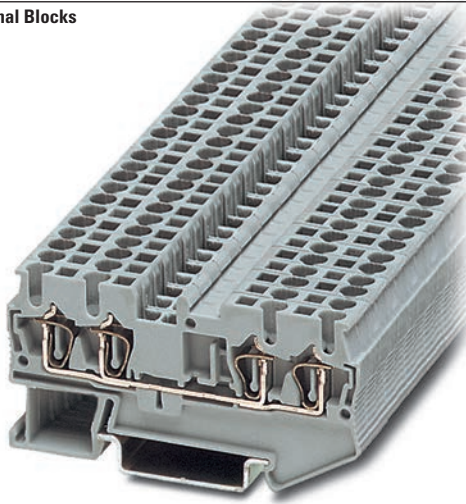

Contents

Description	Page
Single Level—Through-Feed	T42-32
Single Level—Ground Blocks	T42-37
Multi-Conductor Terminal Blocks	
Accessories	T42-40
Technical Data and Specifications	T42-41
Dimensions	T42-41
Multi-Conductor Ground Blocks	T42-42
Double Level Blocks	T42-44
Triple Level Blocks	T42-46
Fuse Terminal Blocks	T42-48
Disconnect and Component Terminal Blocks	T42-51
Hybrid Terminal Blocks	T42-54
Mini Spring Cage	T42-56

Multi-Conductor Terminal Blocks

Product Description

The multi-conductor terminal blocks offer a space-saving alternative to standard feed-through terminal blocks, allowing for high-density wiring. Often, three connections have to be led to one terminal block. The XBPT...D12 terminal block accomplishes this without

any additional terminal blocks or bridging required. The XBPT...D22 terminal blocks allow four wires to be connected to one potential—and can therefore be used as compact power distributors. There is also a version, XBPT25D22U or XBPT4D22U, with an interrupted bus bar in

the terminal centre. This makes two feed-through terminal blocks available in one level. One side of this block can be bridged using the standard Plug-in bridges. Double marker carriers are available for clear marking of the feed-through levels.

Product Selection

XBPT4D12



Spring Cage Connection Multi-Conductor Terminal Blocks, Three-Wire

Terminal Width	Maximum Wire Size	IEC 60 947-7-1 in V/A/AWG	EN 50 019 ① in V/A/AWG	UL-cUL Ratings in V/A/AWG	Colour	Standard Pack	Catalogue Number
5.2 mm	12 AWG/2.5 mm ²	800/28/28–12	550/25/21/24–12	600/20/26–12	Gray	50	XBPT25D12
					Blue	50	XBPT25D12BU
6.2 mm	10 AWG/4 mm ²	800/40/28–10	550/34/29/24–10	600/30/20–10	Gray	50	XBPT4D12
					Blue	50	XBPT4D12BU

Note

① EU type—examination certificate number: KEMA 05ATEX2154 U (XBPT25D12), KEMA 05ATEX2155 U (XBPT4D12).

XBPT25D22



Spring Cage Connection Multi-Conductor Terminal Blocks, Four-Wire

Terminal Width	Maximum Wire Size	IEC 60 947-7-1 in V/A/AWG	EN 50 019 ① in V/A/AWG	UL-cUL Ratings in V/A/AWG	Colour	Standard Pack	Catalogue Number
Spring Cage Multi-Conductor							
5.2 mm	12 AWG/2.5 mm ²	800/28/28-12	550/24/21/24-12	600/20/26-12	Gray	50	XBPT25D22
					Blue	50	XBPT25D22BU
6.2 mm	10 AWG/4 mm ²	800/40/28-10	550/34/25/24-10	600/30/20-10	Gray	50	XBPT4D22
					Blue	50	XBPT4D22BU
Spring Cage Multi-Conductor with Interrupted Bus Bar							
5.2 mm	12 AWG/2.5 mm ²	800/28/28-12	550/24/21/24-12	600/20/26-12	Blue	50	XBPT25D22U
6.2 mm	10 AWG/4 mm ²	800/40/28-10	550/34/25/24-10	600/30/20-10	Blue	50	XBPT4D22U

Accessories

Spring Cage Connection Multi-Conductor Terminal Blocks

Description	Colour	Number of Positions	Standard Pack	XBPT25D12 Catalogue Number	XBPT4D12 Catalogue Number	XBPT25D22 Catalogue Number	XBPT4D22 Catalogue Number
End cover	Gray	—	10	XBACPT25D12	XBACPT4D12	XBACPT25D22	XBACPT4D22
End cover segment	Gray	—	10	XBASPT25	XBASPT4	XBASPT25	XBASPT4
Partition plate	—	—	10	XBATPTD12	XBATPTD12	XBATPTD22	XBATPTD22
Plug-in bridge—for cross connections in the bridge shaft	Red	2	10	XBAFBS25	XBAFBS26	XBAFBS25	XBAFBS26
		3	10	XBAFBS35	XBAFBS36	XBAFBS35	XBAFBS36
		5	10	XBAFBS55	XBAFBS56	XBAFBS55	XBAFBS56
		10	10	XBAFBS105	XBAFBS106	XBAFBS105	XBAFBS106
		50	10	XBAFBS505	XBAFBS506	XBAFBS505	XBAFBS506
Test adapter	—	—	10	XBATSPA14	XBATSPA14	XBATSPA14	XBATSPA14
2.3 mm diameter test plug	—	—	—	XBATSMPS-^②	XBATSMPS-^②	XBATSMPS-^②	XBATSMPS-^②
Modular test plug	—	—	10	XBATSPS5	XBATSPS6	XBATSPS5	XBATSPS6
Blank marker strip external labeling	White	—	10	XBMZBF5^③	XBMZBF6^③	XBMZBF5^③	XBMZBF6^③
Blank marker strip centre labeling (strip of 10)	White	—	10	XBMZB5^③	XBMZB6^③	XBMZB5^③	XBMZB6^③

Notes

① EU type—examination certificate number: KEMA 05ATEX2154 U (XBPT25D22), KEMA 05ATEX2155 (XBPT4D22).

② For ordering information, see **Page T42-105**.

③ For information on Printed Marking Tag Options, see **Page T42-98**.

For additional accessories, see **Page T42-90**.

Technical Data and Specifications

Spring Cage Connection Multi-Conductor Terminal Blocks

Description	XBPT25D12	XBPT4D12	XBPT25D22	XBPT4D22
Technical Data in Accordance with IEC				
Maximum load current in A/cross-section in mm ²	28/4	40/6	28/4	40/6
Rated surge voltage in kV/contamination class	8/3	8/3	8/3	8/3
Surge voltage category/insulating material group	III/I	III/I	III/I	III/I
Connection Capacity				
Stranded with ferrule with plastic sleeve in mm ²	0.25–2.5	0.25–4	0.25–2.5	0.25–4
Stranded with ferrules without plastic sleeve in mm ²	0.25–2.5	0.25–4	0.25–2.5	0.25–4
Stranded with twin ferrule with plastic sleeve in mm ²	0.5	0.5–1	0.5	0.5–1
Stripping length in inches (mm)	0.39 (10)	0.39 (10)	0.39 (10)	0.39 (10)

Dimensions

Approximate Dimensions in Inches (mm)

Spring Cage Connection Multi-Conductor Terminal Blocks

Catalogue Number	Width	Length	Cover Width	Height for—	
				35 x 7.5 in	35 x 15 in
XBPT25D12	0.20 (5.2)	2.38 (60.5)	0.09 (2.2)	1.44 (36.5)	1.73 (44.0)
XBPT4D12	0.24 (6.2)	2.81 (71.5)	0.09 (2.2)	1.44 (36.5)	1.73 (44.0)
XBPT25D22	0.20 (5.2)	2.83 (72.0)	0.09 (2.2)	1.44 (36.5)	1.73 (44.0)
XBPT4D22	0.24 (6.2)	3.43 (87.0)	0.09 (2.2)	1.44 (36.5)	1.73 (44.0)

Multi-Conductor Terminal Blocks



Contents

<i>Description</i>	<i>Page</i>
Single Level—Through-Feed	T42-32
Single Level—Ground Blocks	T42-37
Multi-Conductor Terminal Blocks	T42-39
Multi-Conductor Ground Blocks	
Accessories	T42-43
Technical Data and Specifications	T42-43
Dimensions	T42-43
Double Level Blocks	T42-44
Triple Level Blocks	T42-46
Fuse Terminal Blocks	T42-48
Disconnect and Component Terminal Blocks	T42-51
Hybrid Terminal Blocks	T42-54
Mini Spring Cage	T42-56

Multi-Conductor Ground Blocks

Product Description

The ground terminal blocks have the same shape and pitch as the standard terminal block, in a green-yellow housing. They easily snap

onto the DIN rail to make a reliable mechanical and electrical contact that meets all requirements of IEC 60-947-7-2.

Product Selection

XBPT25D12PE



Spring Cage Connection Multi-Conductor Ground Blocks, Three-Wire

Terminal Width	Maximum Wire Size	IEC 60 947-7-2 in V/A/AWG	EN 50 019 ① in V/A/AWG	UL-cUL Ratings in V/A/AWG	Colour	Standard Pack	Catalogue Number
5.2 mm	12 AWG/2.5 mm ²	—/—/28-12	—/—/24-12	—/—/26-12	Green/Yellow	50	XBPT25D12PE
6.2 mm	10 AWG/4 mm ²	—/—/28-10	—/—/24-10	—/—/20-10	Green/Yellow	50	XBPT4D12PE

XBPT4D22PE



Spring Cage Connection Multi-Conductor Ground Blocks, Four-Wire

Terminal Width	Maximum Wire Size	IEC 60 947-7-2 in V/A/AWG	EN 50 019 ① in V/A/AWG	UL-cUL Ratings in V/A/AWG	Colour	Standard Pack	Catalogue Number
5.2 mm	12 AWG/2.5 mm ²	—/—/28-12	—/—/24-12	—/—/26-12	Green/Yellow	50	XBPT25D22PE
6.2 mm	10 AWG/4 mm ²	—/—/28-10	—/—/24-10	—/—/20-10	Green/Yellow	50	XBPT4D22PE

Note

① EU type—examination certificate number: KEMA 05ATEX2154 U (XBPT25D12PE), KEMA 05ATEX2155 U (XBPT4D12PE).

Accessories

Spring Cage Connection Multi-Conductor Ground Blocks

Description	Colour	Number of Positions	Standard Pack	XBPT25D12PE	XBPT4D12PE	XBPT25D22PE	XBPT4D22PE
				Catalogue Number	Catalogue Number	Catalogue Number	Catalogue Number
End cover	Gray	—	10	XBACPT25D12	XBACPT4D12	XBACPT25D22	XBACPT4D22
End cover segment	Gray	—	10	XBASPT25	XBASPT4	XBASPT25	XBASPT4
Blank marker strip external labeling	White	—	10	XBMZBF5 ①	XBMZBF6 ①	XBMZBF5 ①	XBMZBF6 ①
Blank marker strip centre labeling (strip of 10)	White	—	10	XBMZB5 ①	XBMZB6 ①	XBMZB5 ①	XBMZB6 ①

Technical Data and Specifications

Spring Cage Connection Multi-Conductor Ground Blocks

Description	XBPT25D12PE	XBPT4D12PE	XBPT25D22PE	XBPT4D22PE
Technical Data in Accordance with IEC				
Maximum load current in A/cross-section in mm ²	—	—	—	—
Rated surge voltage in kV/contamination class	8/3	8/3	8/3	8/3
Surge voltage category/insulating material group	III/1	III/1	III/1	III/1
Connection Capacity				
Stranded with ferrule with plastic sleeve in mm ²	0.25–2.5	0.25–4	0.25–2.5	0.25–4
Stranded with ferrules without plastic sleeve in mm ²	0.25–2.5	0.25–4	0.25–2.5	0.25–4
Stranded with twin ferrule with plastic sleeve in mm ²	0.5	0.5–1	0.5	0.5–1
Stripping length in inches (mm)	0.39 (10)	0.39 (10)	0.39 (10)	0.39 (10)

Dimensions

Approximate Dimensions in Inches (mm)

Spring Cage Connection Multi-Conductor Ground Blocks

Catalogue Number	Width	Length	Cover Width	Height for—	
				35 x 7.5 in	35 x 15 in
XBPT25D12PE	0.20 (5.2)	2.38 (60.5)	0.09 (2.2)	1.44 (36.5)	1.73 (44.0)
XBPT4D12PE	0.24 (6.2)	2.81 (71.5)	0.09 (2.2)	1.44 (36.5)	1.73 (44.0)
XBPT25D22PE	0.20 (5.2)	2.83 (72.0)	0.09 (2.2)	1.44 (36.5)	1.73 (44.0)
XBPT4D22PE	0.24 (6.2)	3.43 (87.0)	0.09 (2.2)	1.44 (36.5)	1.73 (44.0)

Notes

① For information on Printed Marking Tag Options, see **Page T42-98**.

For additional accessories, see **Page T42-90**.

Double Level Blocks



Contents

Description	Page
Single Level—Through-Feed	T42-32
Single Level—Ground Blocks	T42-37
Multi-Conductor Terminal Blocks	T42-39
Multi-Conductor Ground Blocks	T42-42
Double Level Blocks	
Accessories	T42-45
Technical Data and Specifications	T42-45
Dimensions	T42-45
Triple Level Blocks	T42-46
Fuse Terminal Blocks	T42-48
Disconnect and Component Terminal Blocks	T42-51
Hybrid Terminal Blocks	T42-54
Mini Spring Cage	T42-56

Double Level Blocks

Product Description

The potentials of the **XB** double level terminal blocks routed on two levels reduce space requirements by 50% compared with single level terminal blocks.

The XBPTT blocks can be bridged on both levels with the Plug-in bridge system and labeling options are available for each terminal point, resulting in maximum

customization for each application. The XBPTT25PV and XBPTT4PV terminal blocks have two interconnected levels.

Equipotential bonding is marked by an imprint on the housing. These terminal blocks can also be bridged and used to construct compact potential distributor blocks.

Product Selection

XBPTT4



Spring Cage Connection Double Level Blocks

Terminal Width	Maximum Wire Size	IEC 60 947-7-1 in V/A/AWG	EN 50 019 ① in V/A/AWG	UL-cUL Ratings in V/A/AWG	Colour	Standard Pack	Catalogue Number
Spring Cage Connection Double Level Blocks							
5.2 mm	12 AWG/2.5 mm ²	500/26/28-12	420/23/19/24-12	600/20/26-12	Gray	50	XBPTT25
					Blue	50	XBPTT25BU
6.2 mm	10 AWG/4 mm ²	500/32/28-10	420/32/27/24-10	300/30/20-10	Gray	50	XBPTT4
					Blue	50	XBPTT4BU
Spring Cage Connection Double Level Blocks (terminal block with potential distribution between the levels)							
5.2 mm	112 AWG/2.5 mm ²	500/26/28-12	420/23/19/24-12	600/20/26-12	Gray	50	XBPTT25PV
6.2 mm	10 AWG/4 mm ²	500/32/28-10	420/32/27/24-10	300/30/20-10	Gray	50	XBPTT4PV

XBPTT25PE



Spring Cage Connection Double Level Ground Blocks

Terminal Width	Maximum Wire Size	IEC 60 947-7-2 in V/A/AWG	EN 50 019 ① in V/A/AWG	UL-cUL Ratings in V/A/AWG	Colour	Standard Pack	Catalogue Number
5.2 mm	12 AWG/2.5 mm ²	—/—/28-12	—/—/24-12	—/—/26-12	Green/Yellow	50	XBPTT25PE
6.2 mm	10 AWG/4 mm ²	—/—/28-10	—/—/24-10	—/—/20-10	Green/Yellow	50	XBPTT4PE

Note

① EU type—examination certificate number: KEMA 05ATEX2154 U (XBPTT25), KEMA 05ATEX2155 U (XBPTT4).

Accessories

Spring Cage Connection Double Level Blocks

Description	Colour	Number of Positions	Standard Pack	XBPTT25 Catalogue Number	XBPTT4 Catalogue Number	XBPTT25PE Catalogue Number	XBPTT4PE Catalogue Number
End cover	Gray	—	10	XBACPTT25	XBACPTT4	XBACPTT25	XBACPTT4
Partition plate	—	—	10/50	XBATPTT4	XBATPTT4	—	—
Plug-in bridge—for cross connections in the bridge shaft	Red	2	10	XBAFBS25	XBAFBS26	XBAFBS25	XBAFBS26
		3	10	XBAFBS35	XBAFBS36	XBAFBS35	XBAFBS36
		5	10	XBAFBS55	XBAFBS56	XBAFBS55	XBAFBS56
		10	10	XBAFBS105	XBAFBS106	XBAFBS105	XBAFBS106
		50	10	XBAFBS505	XBAFBS506	XBAFBS505	XBAFBS506
Test adapter	—	—	10	XBATSPAI4	XBATSPAI4	—	—
Modular test plug	—	—	10	XBATSPS5	XBATSPS6	—	—
Blank marker strip (strip of 10)	White	—	10	XBMZBF5 ①	XBMZBF6 ①	XBMZBF5 ①	XBMZBF6 ①

Technical Data and Specifications

Spring Cage Connection Double Level Blocks

Description	XBPTT25	XBPTT4	XBPTT25PE	XBPTT4PE
Technical Data in Accordance with IEC				
Maximum load current in A/cross-section in mm ²	26/4	32/6	—	—
Rated surge voltage in kV/contamination class	6/3	6/3	6/3	6/3
Surge voltage category/insulating material group	III/I	III/I	III/I	III/I
Connection Capacity				
Stranded with ferrule with plastic sleeve in mm ²	0.25–2.5	0.25–4	0.25–2.5	0.25–4
Stranded with ferrules without plastic sleeve in mm ²	0.25–2.5	0.25–4	0.25–2.5	0.25–4
Stranded with twin ferrule with plastic sleeve in mm ²	0.5	0.5–1	0.5	0.5–1
Stripping length in inches (mm)	0.39 (10)	0.39 (10)	0.39 (10)	0.39 (10)

Dimensions

Approximate Dimensions in Inches (mm)

Spring Cage Connection Double Level Blocks

Catalogue Number	Width	Length	Cover Width	Height for—	
				35 x 7.5 in	35 x 15 in
XBPTT25	0.20 (5.2)	2.66 (67.5)	0.09 (2.2)	1.87 (47.5)	2.17 (55.0)
XBPTT4	0.24 (6.2)	3.29 (83.5)	0.09 (2.2)	1.87 (47.5)	2.17 (55.0)
XBPTT25PE	0.20 (5.2)	2.66 (67.5)	0.09 (2.2)	1.87 (47.5)	2.17 (55.0)
XBPTT4PE	0.24 (6.2)	3.29 (83.5)	0.09 (2.2)	1.87 (47.5)	2.17 (55.0)

Notes

① For information on Printed Marking Tag Options, see **Page T42-98**.

For additional accessories, see **Page T42-90**.

42.1

Terminal Blocks, Fuse Blocks and Fuse Holders

IEC—XB Series

Triple Level Blocks

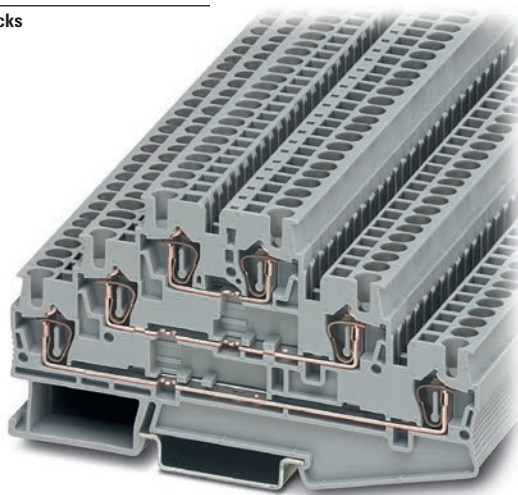

42

Contents

<i>Description</i>	<i>Page</i>
Single Level—Through-Feed	T42-32
Single Level—Ground Blocks	T42-37
Multi-Conductor Terminal Blocks	T42-39
Multi-Conductor Ground Blocks	T42-42
Double Level Blocks	T42-44
Triple Level Blocks	
Accessories	T42-47
Technical Data and Specifications	T42-47
Dimensions	T42-47
Fuse Terminal Blocks	T42-48
Disconnect and Component Terminal Blocks	T42-51
Hybrid Terminal Blocks	T42-54
Mini Spring Cage	T42-56

Triple Level Blocks

Product Description

The spring cage triple level terminal block incorporates three feed-through levels in a 5.2 mm wide housing. This is ideal for high density wiring, especially important

when switchgear space is restricted. There is a bridge shaft on each level allowing use of this block as a compact potential distributor or as a sensor terminal.

The XBPTK25PV has all six terminal points interconnected. All the triple level blocks can be labeled on each level.

Product Selection

XBPTK25

Spring Cage Connection Triple Level Blocks



Terminal Width	Maximum Wire Size	IEC 60 947-7-1 in V/A/AWG	UL-cUL Ratings in V/A/AWG	Colour	Standard Pack	Catalogue Number
5.2 mm	12 AWG/2.5 mm ²	500/28/28-12	600/20/26-12	Gray	50	XBPTK25
5.2 mm	12 AWG/2.5 mm ²	500/28/28-12	600/20/26-12	Gray	50	XBPTK25PV ①

Note

① Terminal block with potential distribution between the levels.

Accessories

Spring Cage Connection Triple Level Blocks

Description	Colour	Number of Positions	Standard Pack	XBPTK25 Catalogue Number	XBPTK25PV Catalogue Number
End cover	Gray	—	10	XBACPT25K	XBACPT25K
Plug-in bridge—for cross connections in the bridge shaft	Red	2	10	XBAFBS25	XBAFBS25
		3	10	XBAFBS35	XBAFBS35
		5	10	XBAFBS55	XBAFBS55
		10	10	XBAFBS105	XBAFBS105
		50	10	XBAFBS505	XBAFBS505
Test adapter	—	—	10	XBATSPA14	XBATSPA14
Modular test plug	—	—	10	XBATSPS5	XBATSPS5
Blank marker strip (strip of 10)	White	—	10	XBMZBF5 ①	XBMZBF5 ①

Technical Data and Specifications

Spring Cage Connection Triple Level Blocks

Description	XBPTK25	XBPTK25PV
Technical Data in Accordance with IEC		
Maximum load current in A/cross-section in mm ²	28/4	28/4
Rated surge voltage in kV/contamination class	6/3	6/3
Surge voltage category/insulating material group	III/I	III/I
Connection Capacity		
Stranded with ferrule with plastic sleeve in mm ²	0.25–2.5	0.25–2.5
Stranded with ferrules without plastic sleeve in mm ²	0.25–2.5	0.25–2.5
Stranded with twin ferrule with plastic sleeve in mm ²	0.5	0.5
Stripping length in inches (mm)	0.39 (10)	0.39 (10)

Dimensions

Approximate Dimensions in Inches (mm)

Spring Cage Connection Triple Level Blocks

Catalogue Number	Width	Length	Cover Length	Height for—	
				35 x 7.5 in	35 x 15 in
XBPTK25	0.20 (5.2)	3.92 (99.5)	0.09 (2.2)	2.28 (58.0)	2.58 (65.5)
XBPTK25PV	0.20 (5.2)	3.92 (99.5)	0.09 (2.2)	2.28 (58.0)	2.58 (65.5)

Notes

① For information on Printed Marking Tag Options, see **Page T42-98**.

For additional accessories, see **Page T42-90**.

Fuse Terminal Blocks

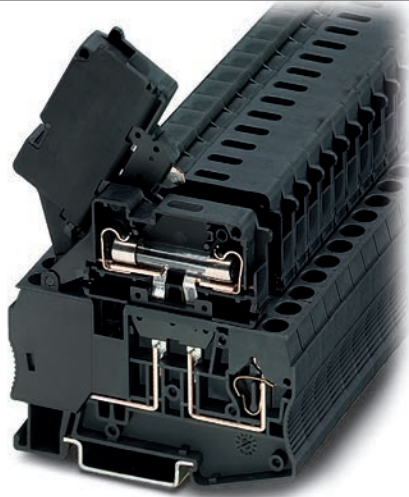

Contents

<i>Description</i>	<i>Page</i>
Single Level—Through-Feed	T42-32
Single Level—Ground Blocks	T42-37
Multi-Conductor Terminal Blocks	T42-39
Multi-Conductor Ground Blocks	T42-42
Double Level Blocks	T42-44
Triple Level Blocks	T42-46
Fuse Terminal Blocks	
Accessories	T42-49
Technical Data and Specifications	T42-50
Dimensions	T42-50
Disconnect and Component Terminal Blocks	T42-51
Hybrid Terminal Blocks	T42-54
Mini Spring Cage	T42-56

Fuse Terminal Blocks

Product Description

The spring cage fuse terminal blocks act as a fuse carrier for 5 x 20 mm or 6.3 x 32 mm fuses. They also allow for potential distribution with the

double bridge shaft. For signaling a triggered fuse, fuse terminal blocks with light indicators are available (for both AC and DC voltage).

Product Selection

XBPT4FBE

Spring Cage Connection Fuse Terminal Blocks, for 5 x 20 mm Fuse



Terminal Width	Maximum Wire Size	IEC 60 947-7-3 with Fuse in V/A/AWG	IEC 60 947-7-3 as Disconnect Terminal Blocks in V/A/AWG	UL-cUL Ratings in V/A/AWG	Colour	Standard Pack	Catalogue Number
Fuse Terminal Blocks							
6.2 mm	10 AWG/4 mm ²	①/①/28-10	250/6.3/28-10	300/6.3/24-10	Black	50	XBPT4FBE
Fuse Terminal Blocks with LED 15-30V, 3.5-8.1A							
6.2 mm	10 AWG/4 mm ²	①/①/28-10	250/6.3/28-10	300/6.3/24-10	Black	50	XBPT4FBEL24
Fuse Terminal Blocks with LED 30-60V, 0.8-2.0A							
6.2 mm	10 AWG/4 mm ²	①/①/28-10	250/6.3/28-10	300/6.3/24-10	Black	50	XBPT4FBEL60
Fuse Terminal Blocks with LED 110-250V, 0.5-1.0A							
6.2 mm	10 AWG/4 mm ²	①/①/28-10	250/6.3/28-10	300/6.3/24-10	Black	50	XBPT4FBEL250

Notes

The cartridge fuse holders should be selected according to the maximum power dissipation (self-heating) of the cartridge fuse inserts. The thermal conditions in closed fuse holes should be checked according to the application and installation.

Higher ambient temperatures are an additional strain on fuse inserts. In applications of this kind, the shift of the rated current should be taken into consideration accordingly.

Maximum power dissipation at 73.4°F (23°C) (in accordance with IEC 60 947-7-3).

When selecting cartridge fuse inserts, please ensure that the maximum power dissipation specified at right is not exceeded. Details can be obtained from the fuse suppliers.

Cartridge Fuse Inserts 5 x 20 and 6.3 x 32 mm in accordance with IEC 60 947-7-3.

① The current is determined by the fuse used, the voltage by the selected light indicator. See **Page T42-49**.

XBPT4FBN



Spring Cage Connection Fuse Terminal Blocks, for 6.3 x 32 mm (1/4 in x 1-1/4 in) Fuse

Terminal Width	Maximum Wire Size	IEC 60 947-7-3 with Fuse in V/A/AWG	IEC 60 947-7-3 as Disconnect Terminal Blocks in V/A/AWG	UL-cUL Ratings in V/A/AWG	Colour	Standard Pack	Catalogue Number
Fuse Terminal Blocks							
8.2 mm	10 AWG/4 mm ²	400/10/28-10	400/10/28-10	300/10/24-10	Black	50	XBPT4FBN
Fuse Terminal Blocks with LED 12-30V, 1.0-2.5 mA							
8.2 mm	10 AWG/4 mm ²	400/10/28-10	400/10/28-10	300/10/24-10	Black	50	XBPT4FBNL24
Fuse Terminal Blocks with LED 110-250V, 0.5-2.5 mA							
8.2 mm	10 AWG/4 mm ²	400/10/28-10	400/10/28-10	300/10/24-10	Black	50	XBPT4FBNL250

42

Accessories

Spring Cage Connection Fuse Terminal Blocks

Description	Colour	Number of Positions	Standard Pack	XBPT4FBE Catalogue Number	XBPT4FBN Catalogue Number
Partition plate	—	—	10	XBATPT4	XBATQTD12
Plug-in bridge—for cross connections in the bridge shaft	Red	2	10	XBAFBS26	XBAFBS28
		3	10	XBAFBS36	—
		5	10	XBAFBS56	—
		10	10	XBAFBS106	—
Blank marker strip external labeling	White	—	10	XBMZBF6 ①	XBMZBF8 ①
Blank marker strip centre labeling (strip of 10)	White	—	10	XBMZB5 ①	XBMZB6 ①

Notes

The cartridge fuse holders should be selected according to the maximum power dissipation (self-heating) of the cartridge fuse inserts. The thermal conditions in closed fuse holes should be checked according to the application and installation.

Higher ambient temperatures are an additional strain on fuse inserts. In applications of this kind, the shift of the rated current should be taken into consideration accordingly.

Maximum power dissipation at 73.4°F (23°C) (in accordance with IEC 60 947-7-3).

When selecting cartridge fuse inserts, please ensure that the maximum power dissipation specified at right is not exceeded. Details can be obtained from the fuse suppliers.

Cartridge Fuse Inserts 5 x 20 and 6.3 x 32 mm in accordance with IEC 60 947-7-3.

① For information on Printed Marking Tag Options, see **Page T42-98**.

For additional accessories, see **Page T42-90**.

Technical Data and Specifications

Overload and Short-Circuit Protection

Terminal Blocks	U (V)	Overload Protection		Short-Circuit Protection Only		I _{max} (A)
		Individual	Interconnected	Individual	Interconnected	
XBPT4FBN	400	1.6W	1.6W	4W	2.5W	10.0
XBPT4FBE	250	1.6W	1.6W	4W	2.5W	6.3

Spring Cage Connection Fuse Terminal Blocks

Description	XBPT4FBE	XBPT4FBN
Technical Data in Accordance with IEC		
Fuse type/dimensions in mm ²	G/5 x 20	G/6.3 x 32
Maximum current with single arrangement in A	6.3	10
Maximum Power Dissipation		
At 73.4°F (23°C) in accordance with IEC 60 947-7-3 in W	①	①
Rated surge voltage in kV/contamination class	4/3	6/3
Surge voltage category/insulating material group	III/I	III/I
Connection Capacity		
Stranded with ferrule/with ferrule and plastic sleeve in mm ²	0.25–4/0.25–4	0.25–4/0.25–4
Stranded with twin ferrule and plastic sleeve in mm ²	0.5	0.5
Stripping length in inches (mm)	0.39 (10)	0.39 (10)

Dimensions

Approximate Dimensions in Inches (mm)

Spring Cage Connection Fuse Terminal Blocks

Catalogue Number	Width	Length	Height for—	
			35 x 7.5 in	35 x 15 in
XBPT4FBE	0.24 (6.2)	2.42 (61.5)	2.46 (62.5)	2.76 (70.0)
XBPT4FBN	0.32 (8.2)	3.01 (76.5)	2.72 (69.0)	3.01 (76.5)

Note

① The current is determined by the fuse used, the voltage by the selected light indicator. See **Page T42-49**.

Disconnect and Component Terminal Blocks

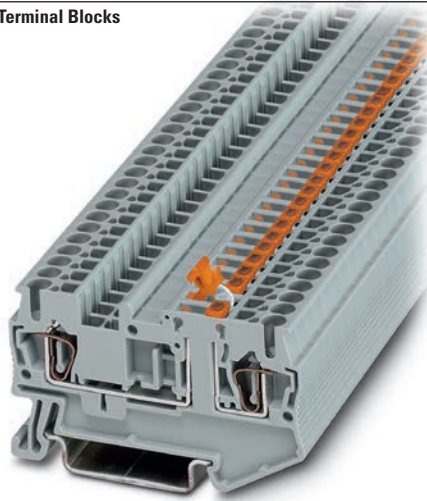

Contents

Description	Page
Single Level—Through-Feed	T42-32
Single Level—Ground Blocks	T42-37
Multi-Conductor Terminal Blocks	T42-39
Multi-Conductor Ground Blocks	T42-42
Double Level Blocks	T42-44
Triple Level Blocks	T42-46
Fuse Terminal Blocks	T42-48
Disconnect and Component Terminal Blocks	
Accessories	T42-52
Technical Data and Specifications	T42-53
Dimensions	T42-53
Hybrid Terminal Blocks	T42-54
Mini Spring Cage	T42-56

Disconnect and Component Terminal Blocks

Product Description

The XBPT knife disconnect terminal blocks feature narrow construction and high current carrying capacity. They also have a test connection parallel to the disconnect point for a 2.3 mm

diameter test plug. Potential distribution is easily accomplished with the Plug-in bridges. There are front connection spring cage terminal blocks available for multi-conductor connections

in the smallest possible space. The XBPT4TG disconnect terminal block accommodates component plugs for resistors, diodes, or capacitors, and fuse plugs with or without indication.

Product Selection

XBPT25MT
Knife Disconnect

Disconnect and Component Terminal Blocks

Terminal Width	Maximum Wire Size	IEC 60 947-7-1 in V/A/AWG	UL-cUL Ratings in V/A/AWG	Colour	Standard Pack	Catalogue Number
Single Level Knife Disconnect						
5.2 mm	12 AWG/2.5 mm ²	400/16/28–12	600/16/26–12	Gray	50	XBPT25MT
6.2 mm	10 AWG/4 mm ²	400/16/28–10	300/6.3/24–10	Gray	50	XBPT4MT
Three-Wire Knife Disconnect						
5.2 mm	12 AWG/2.5 mm ²	400/16/28–12	600/16/26–12	Gray	50	XBPT25D12MT
Four-Wire Knife Disconnect						
5.2 mm	12 AWG/2.5 mm ²	400/16/28–12	600/16/26–12	Gray	50	XBPT25D22MT
Spring Cage Disconnect/Component Plug						
6.2 mm	10 AWG/4 mm ²	400/16/28–10	300/6.3/24–10	Gray	50	XBPT4TG
Component Plug						
6.2 mm	10 AWG/4 mm ²	400/16/28–10	300/6.3/24–10	Gray	10	XBPCO
Fuse Plug						
6.2 mm	10 AWG/4 mm ²	400/16/28–10	300/6.3/24–10	Black	10	XBPFU
Fuse Plug with Light Indicator for 12–30V, 1–2.5 mA						
6.2 mm	10 AWG/4 mm ²	400/16/28–10	300/6.3/24–10	Black	10	XBPFUL24
Fuse Plug with Light Indicator for 110–250V, 0.5–2.5 mA						
6.2 mm	10 AWG/4 mm ²	400/16/28–10	300/6.3/24–10	Black	10	XBPFUL250

Accessories

Spring Cage Connection Disconnect and Component Terminal Blocks

Description	Colour	Number of Positions	Standard Pack	XBPT25MT Catalogue Number	XBPT25D12MT Catalogue Number	XBPT25D22MT Catalogue Number	XBPT4MT Catalogue Number	XBPT4TG Catalogue Number
End cover	Gray	—	10	XBACPT25D12	XBACPT25D22	XBACPT25D22MT	③	③
End cover segment	Gray	—	10	—	XBACPT25	XBACPT25	—	—
Partition plate	—	—	—	XBATPTD12	XBATPTD22	—	XBATPT4	XBATPT4
Plug-in bridge—for cross connections in the terminal centre	Red	2	10	XBAFBS25	XBAFBS25	XBAFBS25	XBAFBS26	XBAFBS26
		3	10	XBAFBS35	XBAFBS35	XBAFBS35	XBAFBS36	XBAFBS36
		5	10	XBAFBS55	XBAFBS55	XBAFBS55	XBAFBS56	XBAFBS56
		10	10	XBAFBS105	XBAFBS105	XBAFBS105	XBAFBS106	XBAFBS106
		50	10	XBAFBS505	XBAFBS505	XBAFBS505	XBAFBS506	XBAFBS506
Test adapter	—	—	10	XBATSPA14	XBATSPA14	XBATSPA14	XBATSPA14	XBATSPA14
2.3 mm diameter test plug	—	—	—	XBATSMPS-^①	XBATSMPS-^①	XBATSMPS-^①	XBATSMPS-^①	XBATSMPS-^①
Modular test plug	—	—	10	XBATSPS5	XBATSPS5	XBATSPS5	XBATSPS6	XBATSPS6
Blank marker strip external labeling	White	—	10	XBMZBF5^②	XBMZBF5^②	XBMZBF5^②	XBMZBF6^②	XBMZBF6^②
Blank marker strip centre labeling (strip of 10)	White	—	10	XBMZB5^②	XBMZB5^②	XBMZB5^②	XBMZB6^②	XBMZB6^②

Notes

- ① For ordering information, see **Page T42-105**.
- ② For information on Printed Marking Tag Options, see **Page T42-98**.
- ③ XBPT4MT and XBPT4TG have an enclosed design. The use of an end cover is not required.

For additional accessories, see **Page T42-90**.

Technical Data and Specifications

Spring Cage Connection Disconnect and Component Terminal Blocks, XBPT25MT, XBPT25D12MT and XBPT25D22MT

Description	XBPT25MT	XBPT25D12MT	XBPT25D22MT
Technical Data in Accordance with IEC			
Maximum load current in A/cross-section in mm ²	16/4	16/4	16/4
Rated surge voltage in kV/contamination class	6/3	6/3	6/3
Surge voltage category/insulating material group	III/1	III/1	III/1
Connection Capacity			
Stranded with ferrule with plastic sleeve in mm ²	0.25–2.5	0.25–2.5	0.25–2.5
Stranded with ferrules without plastic sleeve in mm ²	0.25–2.5	0.25–2.5	0.25–2.5
Stranded with twin ferrule with plastic sleeve in mm ²	0.5	0.5	0.5
Stripping length in inches (mm)	0.39 (10)	0.39 (10)	0.39 (10)

Spring Cage Connection Disconnect and Component Terminal Blocks, XBPT25D12MT and XBPT4TG

Description	XBPT4MT	XBPT4TG
Technical Data in Accordance with IEC		
Maximum load current in A/cross-section in mm ²	16/6	16/6
Rated surge voltage in kV/contamination class	6/3	6/3
Surge voltage category/insulating material group	III/1	III/1
Connection Capacity		
Stranded with ferrule with plastic sleeve in mm ²	0.25–4	0.25–4
Stranded with ferrules without plastic sleeve in mm ²	0.25–4	0.25–4
Stranded with twin ferrule with plastic sleeve in mm ²	0.5	0.5
Stripping length in inches (mm)	0.39 (10)	0.39 (10)

Dimensions

Approximate Dimensions in Inches (mm)

Spring Cage Connection Disconnect and Component Terminal Blocks

Catalogue Number	Width	Length	Cover Length	Height for—	
				35 x 7.5 in	35 x 15 in
XBPT25MT	0.20 (5.2)	2.38 (60.5)	0.09 (2.2)	1.44 (36.5)	1.73 (44.0)
XBPT25D12MT	0.20 (5.2)	2.83 (72.0)	0.09 (2.2)	1.44 (36.5)	1.73 (44.0)
XBPT25D22MT	0.20 (5.2)	3.31 (84.0)	0.09 (2.2)	1.44 (36.5)	1.73 (44.0)
XBPT4MT	0.24 (6.2)	2.42 (61.5)	—	1.44 (36.5)	1.73 (44.0)
XBPT4TG	0.24 (6.2)	2.42 (61.5)	—	1.44 (36.5)	1.73 (44.0)

Hybrid Terminal Blocks

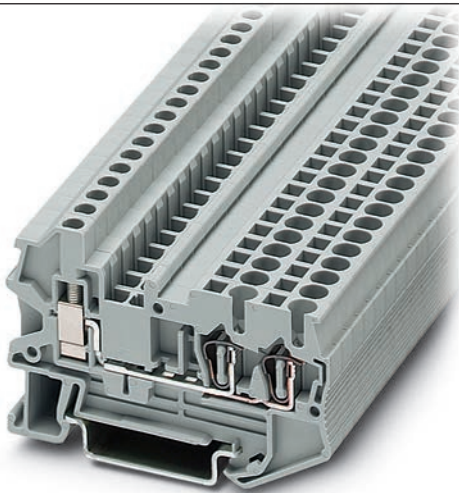

Contents

<i>Description</i>	<i>Page</i>
Single Level—Through-Feed	T42-32
Single Level—Ground Blocks	T42-37
Multi-Conductor Terminal Blocks	T42-39
Multi-Conductor Ground Blocks	T42-42
Double Level Blocks	T42-44
Triple Level Blocks	T42-46
Fuse Terminal Blocks	T42-48
Disconnect and Component Terminal Blocks	T42-51
Hybrid Terminal Blocks	
Accessories	T42-55
Technical Data and Specifications	T42-55
Dimensions	T42-55
Mini Spring Cage	T42-56

Hybrid Terminal Blocks

Product Description

The XBPU spring cage hybrid terminal blocks offer the best of both worlds. One side offers a spring cage connection and the other side offers the universal screw connection. Use the spring

cage connection on the internal (factory) control cabinet side and the screw connection on the end customer (field) side. Ground terminal blocks of the same shape are also available.

Product Selection

XBPU25D12



Spring Cage Hybrid Terminal Blocks

Terminal Width	Maximum Wire Size	IEC 60 947-7-1 with ...		IEC 60 947-7-2 with ...		UL-cUL Ratings with ...		Colour	Std. Pack	Catalogue Number
		Spring in V/A/AWG	Screw in V/A/AWG	Spring in V/A/AWG	Screw in V/A/AWG	Spring in V/A/AWG	Screw in V/A/AWG			
5.2 mm	12 AWG/ 2.5 mm ²	800/28/28-12	800/28/26-14	—	—	600/15/28-12	600/15/26-12	Gray	50	XBPU25D12

XBPU25D12PE

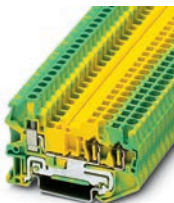

Spring Cage Hybrid Ground Blocks

Terminal Width	Maximum Wire Size	IEC 60 947-7-1 with ...		IEC 60 947-7-2 with ...		UL-cUL Ratings with ...		Colour	Std. Pack	Catalogue Number
		Spring in V/A/AWG	Screw in V/A/AWG	Spring in V/A/AWG	Screw in V/A/AWG	Spring in V/A/AWG	Screw in V/A/AWG			
5.2 mm	12 AWG/ 2.5 mm ²	—	—	—/—/28-12	—/—/26-14	—/—/28-12	—/—/28-12	Green/ Yellow	50	XBPU25D12PE

Accessories

Spring Cage Hybrid Terminal/Ground Blocks

Description	Colour	Number of Positions	Standard Pack	XBPU25D12 Catalogue Number	XBPU25D12PE Catalogue Number
End cover	Gray	—	10	XBACPU25D12	XBACPU25D12
Plug-in bridge—for cross connections in the terminal centre	Red	2	10	XBAFBS25	XBAFBS25
		3	10	XBAFBS35	XBAFBS35
		5	10	XBAFBS55	XBAFBS55
		10	10	XBAFBS105	XBAFBS105
		50	10	XBAFBS505	XBAFBS505
Test adapter	—	—	10	XBATSPAI4	—
2.3 mm diameter test plug	—	—	—	XBATSMPS_ ①	—
Modular test plug	—	—	10	XBATSPS5	—
Blank marker strip external labeling	White	—	10	XBMZBF5 ②	XBMZBF5 ②
Blank marker strip centre labeling (strip of 10)	White	—	10	XBMZB5 ②	XBMZB5 ②

Technical Data and Specifications

Spring Cage Hybrid Blocks

Description	XBPU25D12	XBPU25D12PE
Technical Data in Accordance with IEC		
Maximum load current in A/cross-section in mm ²	28/4	—
Rated surge voltage in kV/contamination class	8/3	8/3
Surge voltage category/insulating material group	III/1	III/1
Connection Capacity		
Stranded with ferrule with plastic sleeve in mm ²	0.25–2.5	0.25–2.5
Stranded with ferrules without plastic sleeve in mm ²	0.25–2.5	0.25–2.5
Stranded with twin ferrule with plastic sleeve in mm ²	0.5–1	0.5–1
Stripping length in inches (mm)	0.39 (10)	0.39 (10)

Dimensions

Approximate Dimensions in Inches (mm)

Spring Cage Hybrid Blocks

Catalogue Number	Width	Length	Cover Length	Height for—	
				35 x 7.5 in	35 x 15 in
XBPU25D12	0.20 (5.2)	2.57 (65.3)	0.09 (2.2)	1.69 (42.8)	1.98 (50.3)
XBPU25D12PE	0.20 (5.2)	2.57 (65.3)	0.09 (2.2)	1.69 (42.8)	1.98 (50.3)

Notes

- ① For ordering information, see **Page T42-105**.
 - ② For information on Printed Marking Tag Options, see **Page T42-98**.
- For additional accessories, see **Page T42-90**.

Mini Spring Cage



Contents

Description	Page
Single Level—Through-Feed	T42-5
Single Level—Ground Blocks	T42-10
Multi-Conductor Terminal Blocks	T42-12
Multi-Conductor Ground Blocks	T42-14
Double Level	T42-16
Triple Level Sensor/Actuator	T42-18
Fuse Terminal Blocks	T42-21
Disconnect and Component Terminal Blocks	T42-24
High Current Blocks	T42-27
Mini Spring Cage	
Accessories	T42-57
Technical Data and Specifications	T42-57
Dimensions	T42-57

Mini Spring Cage

Product Description

The **XB** miniature terminal blocks have a connection cross-section from 1.5 mm² through 4 mm² and mount on 15 mm DIN rail. There is an

opening for bridging with a fixed bridge in the centre of the terminal blocks. These miniature terminal blocks also offer the same accessories

that you would find with the larger blocks—including marking tags, end covers, end stop and ground blocks.

Product Selection

XBMPK15



Mini Spring Cage Terminal Blocks

Terminal Width	Maximum Wire Size	IEC 60 947-7-1 in V/A/AWG	IEC 60 947-7-2 in V/A/AWG	UL-cUL Ratings in V/A/AWG	Colour	Standard Pack	Catalogue Number
5.2 mm	14 AWG/1.5 mm ²	800/24/26–14	—	600/15/26–14	Gray	50	XBMPK15
					Blue	50	XBMPK15BU

XBMPK15PE



Mini Spring Cage Ground Blocks

Terminal Width	Maximum Wire Size	IEC 60 947-7-1 in V/A/AWG	IEC 60 947-7-2 in V/A/AWG	UL-cUL Ratings in V/A/AWG	Colour	Standard Pack	Catalogue Number
5.2 mm	14 AWG/1.5 mm ²	—	—/—/26–14	—/—/26–14	Green/ Yellow	50	XBMPK15PE

XBMPKK15



Mini Spring Cage Terminal Blocks—Double Level

Terminal Width	Maximum Wire Size	IEC 60 947-7-1 in V/A/AWG	UL-cUL Ratings in V/A/AWG	Colour	Standard Pack	Catalogue Number
5.2 mm	14 AWG/1.5 mm ²	500/20/26–14	600/15/26–14	Gray	50	XBMPKK15

Accessories

Mini Spring Cage Terminal/Ground Blocks

Description	Colour	Number of Positions	Standard Pack	XBMPK15 Catalogue Number	XBMPK15PE Catalogue Number	XBMPKK15 Catalogue Number
End cover	Gray	—	10	XBACMPK15	XBACMPK15	XBACMPKK15
Fixed bridge	—	2	10	XBAFBR25N	—	XBAFBR25N
Separating plate	—	—	10	XBATMPKK15	—	XBATMPKK15
Blank marker strip	White	—	10	XBMZBF5 ^①	XBMZBF5 ^①	XBMZBF5 ^①

42

Technical Data and Specifications

Mini Spring Cage Terminal/Ground Blocks

Description	XBMPK15	XBMPK15PE	XBMPKK15
Technical Data in Accordance with IEC			
Maximum load current in A/cross-section in mm ²	24/2.5	—	20/2.5
Rated surge voltage in kV/contamination class	8/3	8/3	6/3
Surge voltage category/insulating material group	III/1	III/1	III/1
Connection Cross-Section			
Stranded with ferrule with plastic sleeve in mm ²	0.25–1.5	0.25–1.5	0.25–1.5
Stranded with ferrule without plastic sleeve in mm ²	0.25–1.5	0.25–1.5	0.25–1.5
Stranded with twin ferrule with plastic sleeve in mm ²	—	—	—
Stripping length in Inches (mm)	0.35 (9)	0.35 (9)	0.35 (9)

Dimensions

Approximate Dimensions in Inches (mm)

Mini Spring Cage Terminal/Ground Blocks

Catalogue Number	Width	Length	Cover Length	Height for—		
				15 x 5.5 in	35 x 7.5 in	35 x 15 in
XBMPK15	0.20 (5.2)	1.57 (40.0)	0.04 (1.1)	1.36 (34.5)	—	—
XBMPK15PE	0.20 (5.2)	1.57 (40.0)	0.04 (1.1)	1.36 (34.5)	—	—
XBMPKK15	0.20 (5.2)	3.35 (85.0)	0.04 (1.1)	1.65 (42.0)	1.67 (42.5)	1.97 (50.0)

Notes

① For information on Printed Marking Tag Options, see **Page T42-98**.

For additional accessories, see **Page T42-90**.

Pluggable Spring Cage Terminal Blocks

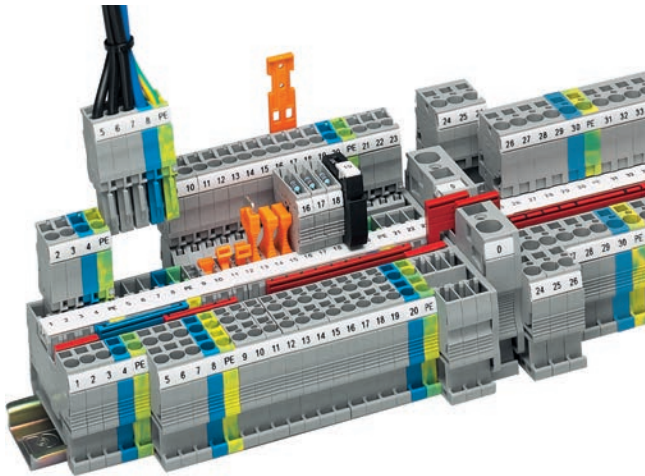

42

Pluggable Spring Cage Terminal Blocks Overview

Product Description

The pluggable spring cage connection terminal blocks allow signal and power wiring to be made pluggable. This complete pluggable system has a spring that provides maximum connection space in a space-saving design. The pluggable system accommodates stranded conductors with a nominal cross-section of 2.5 mm², with or without ferrules.

Application Description

For applications requiring pluggable wiring up to a rated current of 32A and a rated voltage of 800V. The integrated overspring meets the most stringent vibration requirements. Also ideal where safety is a concern and flexibility is required. The basic terminal blocks and the plugs are finger-safe, which also means the supply voltage can be input via either the terminal blocks or the plugs. With the XBAPSC receptacles, plug-in contacts can be accommodated safely in cable ducts and distributor shafts using minimal space. A test hole can accommodate a 2.3 mm diameter test plug in each receptacle, providing a practical solution. The XBAPSP plugs are intended for connecting one wire, while the XBAPSPDB plugs are designed to connect two wires and provide an optional bridge.

Contents

Description

<i>Description</i>	<i>Page</i>
Pluggable Spring Cage Terminal Blocks	
Connection Terminal Blocks	T42-59
Connection Plugs	T42-62
Connection Receptacles	T42-64
Connection Accessories	T42-66

Features

- Space-saving design
- Powerful contact
- Finger-safe

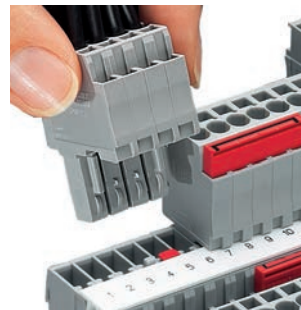

Pluggability

Standards and Certifications

- UL recognized—File No. E67464
- CE approved
- LVD ①:
 - EN 60947-7-1
 - EN 60947-7-2
 - EN 60998-2-3
 - EN 60352-4/A1
- ATEX approval (Eex e applications)



Note

① Not all standards apply to all terminal blocks. Contact Eaton for details.

Connection Terminal Blocks

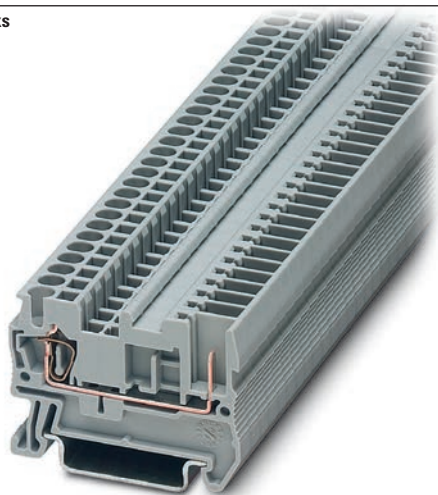

Contents

Description	Page
Connection Terminal Blocks	
Accessories	T42-60
Technical Data and Specifications	T42-60
Dimensions	T42-61
Connection Plugs	T42-62
Connection Receptacles	T42-64
Connection Accessories	T42-66

Connection Terminal Blocks

Product Description

Contact to the DIN rail is made by simply snapping the terminal block onto the rail.

These blocks act as the stationary position of the pluggable terminal blocks.

Product Selection

XBPT25P

Pluggable Spring Cage Connection Terminal Blocks



Terminal Width	Maximum Wire Size	IEC 61 984 in V/A/AWG	UL-cUL Ratings in V/A/AWG	Colour	Standard Pack	Catalogue Number
Single Level						
5.2 mm	12 AWG/2.5 mm ²	500/24/28-12	300/20/26-12	Gray	50	XBPT25P
Three-Wire						
5.2 mm	12 AWG/2.5 mm ²	500/24/28-12	300/20/26-12	Gray	50	XBPT25PD12

Accessories

Pluggable Spring Cage Connection Terminal Blocks

Description	Colour	Number of Positions	Standard Pack	XBPT25P Catalogue Number	XBPT25PD12 Catalogue Number
End cover	Gray	—	10	XBACPT25	XBACPT25D12
End cover segment	Gray	—	10	—	XBASPT25
Partition plate	—	—	10	XBATPT4	XBATPTD12
Plug-in bridge—for cross connections in the terminal centre	Red	2	10	XBAFBS25	XBAFBS25
		3	10	XBAFBS35	XBAFBS35
		5	10	XBAFBS55	XBAFBS55
		10	10	XBAFBS105	XBAFBS105
		50	10	XBAFBS505	XBAFBS505
Test adapter	—	—	10	XBATSPA14	XBATSPA14
2.3 mm diameter test plug	—	—	—	XBATSMPS- ^①	XBATSMPS- ^①
Modular test plug	—	—	10	XBATSPS5	XBATSPS5
Blank marker strip external labeling	White	—	10	XBMZBF5 ^②	XBMZBF5 ^②
Blank marker strip centre labeling (strip of 10)	White	—	10	XBMZB5 ^②	XBMZB5 ^②

Technical Data and Specifications

Pluggable Spring Cage Connection Terminal Blocks

Description	XBPT25P	XBPT25PD12
Technical Data in Accordance with IEC		
Maximum load current in A/cross-section in mm ²	24/4	24/4
Rated surge voltage in kV/contamination class	6/3	6/3
Surge voltage category/insulating material group	III/1	III/1
Connection Capacity		
Stranded with ferrule with plastic sleeve in mm ²	0.25–2.5	0.25–2.5
Stranded with ferrules without plastic sleeve in mm ²	0.25–2.5	0.25–2.5
Stranded with twin ferrule with plastic sleeve in mm ²	0.5	0.5
Stripping length in inches (mm)	0.39 (10)	0.39 (10)

**Derating Curve for Pluggable Terminal Blocks
XBPT25P and XBPT25PD12**

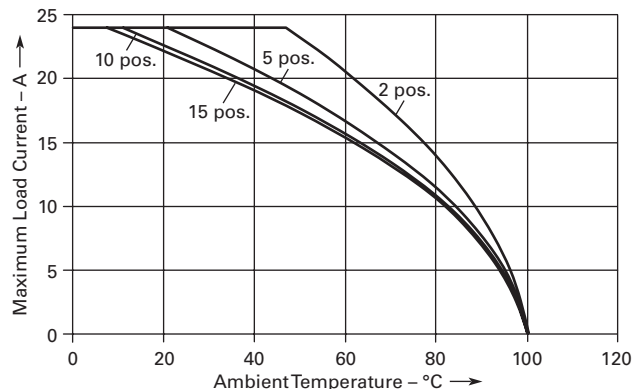

Notes

① For ordering information, see **Page T42-105**.

② For information on Printed Marking Tag Options, see **Page T42-98**.

For additional accessories, see **Page T42-90**.

Dimensions

Approximate Dimensions in Inches (mm)

Pluggable Spring Cage Connection Terminal Blocks—Without Plug

Catalogue Number	Width	Length	Cover Length	Height for—	
				35 x 7.5 in	35 x 15 in
XBPT25P	0.20 (5.2)	1.91 (48.5)	0.09 (2.2)	1.44 (36.5)	1.73 (44.0)
XBPT25PD12	0.20 (5.2)	2.38 (60.5)	0.09 (2.2)	1.44 (36.5)	1.73 (44.0)

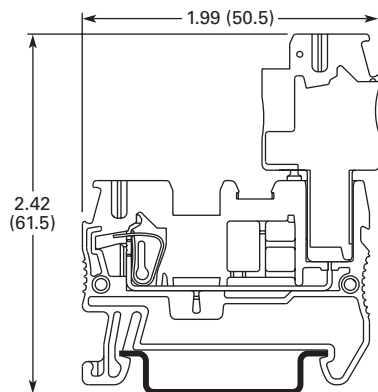
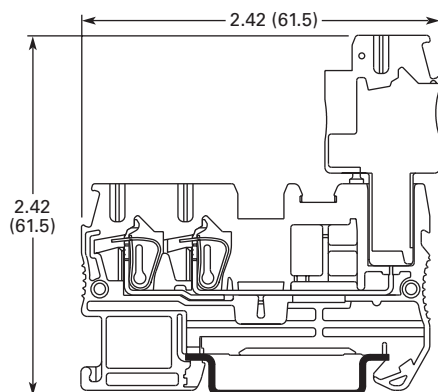
XBPT25P**XBPT25PD12**

Connection Plugs



42

Contents

<i>Description</i>	<i>Page</i>
Connection Terminal Blocks	T42-59
Connection Plugs	
Accessories	T42-63
Technical Data and Specifications	T42-63
Dimensions	T42-63
Connection Receptacles	T42-64
Connection Accessories	T42-66

Connection Plugs

Product Description

Just like the basic terminal blocks, the plugs also offer the perfect solution for every application. The XBAPSP25_ plugs are designed for

connecting one conductor. The XBAPSPDB25_ plug is designed for connecting two conductors and provides an additional bridging option.

Product Selection

XBAPSP25_



Spring Cage Connection Plugs, Single, Not Bridgeable

Terminal Width	Maximum Wire Size	Connection Data in V/A/AWG	UL-cUL Ratings in V/A/AWG	Colour	Number of Positions	Standard Pack	Catalogue Number
5.2 mm	12 AWG/2.5 mm ²	500/24/28-12	300/20/26-12	Gray	1	25	XBAPSP251
					2	25	XBAPSP252
					3	25	XBAPSP253
					4	25	XBAPSP254
					5	25	XBAPSP255
					6	25	XBAPSP256
					7	25	XBAPSP257
					8	25	XBAPSP258
					9	25	XBAPSP259
					10	25	XBAPSP2510
					11	10	XBAPSP2511
					12	10	XBAPSP2512

XBAPSPDB25



Spring Cage Connection Plugs, Double, Bridgeable

Terminal Width	Maximum Wire Size	Connection Data in V/A/AWG	UL-cUL Ratings in V/A/AWG	Colour	Number of Positions	Standard Pack	Catalogue Number
5.2 mm	12 AWG/2.5 mm ²	500/24/28–12	300/20/26–12	Gray	1	25	XBAPSPDB251
					2	25	XBAPSPDB252
					3	25	XBAPSPDB253
					4	25	XBAPSPDB254
					5	25	XBAPSPDB255
					6	25	XBAPSPDB256
					7	25	XBAPSPDB257
					8	25	XBAPSPDB258
					9	25	XBAPSPDB259
					10	25	XBAPSPDB2510
					11	10	XBAPSPDB2511
					12	10	XBAPSPDB2512

Accessories

Spring Cage Connection Plugs

Description	Colour	Number of Positions	Standard Pack	XBAPSP25_ Catalogue Number	XBAPSPDB25_ Catalogue Number
Plug-in bridge—for cross connections in the terminal centre	Red	2	10	—	XBAFBS25
		3	10	—	XBAFBS35
		5	10	—	XBAFBS55
		10	10	—	XBAFBS105
Snap-lock fitting and strain relief	Orange	2	10	XBAPPRZ	XBAPPRZ
Snap-lock fitting	Orange	1	10	XBAPPR	XBAPPR
	Orange	2	10	XBAPPR2	XBAPPR2
Strain relief	Black	2	10	XBAPPZ2	XBAPPDZ2
	Black	4	10	XBAPPZ4	XBAPPDZ4
Blank marker strip	White	—	10	XBMZBF5 ①	XBMZBF5 ①

Technical Data and Specifications

Spring Cage Connection Plugs

Description	XBAPSP25_	XBAPSPDB25_
Technical Data in Accordance with IEC		
Maximum load current in A/cross-section in mm ²	24/4	24/4
Rated surge voltage in kV/contamination class	6/3	6/3
Surge voltage category/insulating material group	III/1	III/1
Connection Capacity		
Stranded with ferrule with plastic sleeve in mm ²	0.25–2.5	0.25–2.5
Stranded with ferrules without plastic sleeve in mm ²	0.25–2.5	0.25–2.5
Stranded with twin ferrule with plastic sleeve in mm ²	0.5	0.5
Stripping length in inches (mm)	0.39 (10)	0.39 (10)

Dimensions

See **Page T42-61** for dimensions.

Notes

① For information on Printed Marking Tag Options, see **Page T42-98**.

For additional accessories, see **Page T42-90**.

42.1

Terminal Blocks, Fuse Blocks and Fuse Holders

IEC—XB Series

Connection Receptacles

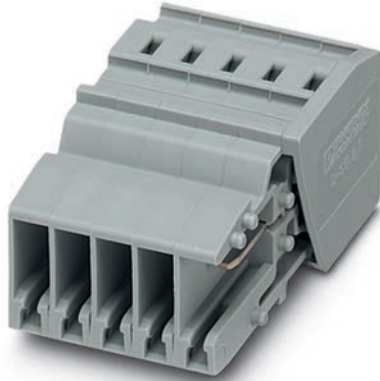

42

Contents

<i>Description</i>	<i>Page</i>
Connection Terminal Blocks	T42-59
Connection Plugs	T42-62
Connection Receptacles	
Accessories	T42-65
Technical Data and Specifications	T42-65
Dimensions	T42-65
Connection Accessories	T42-66

Connection Receptacles

Product Description

With the XBAPSC25_ Plug-in contacts can be accommodated safely in cable ducts and distributor shafts without using much

space. The standard strain reliefs can also be used. Large-surface labeling makes it possible to mark the terminal points and the entire

receptacle. A test hole can accommodate a 2.3 mm diameter test plug in each receptacle element, providing a practical solution.

Product Selection

XBAPSC25_

Pluggable Spring Connection Receptacles



Terminal Width	Maximum Wire Size	Connection Data in V/A/AWG	UL-cUL Ratings in V/A/AWG	Colour	Number of Positions	Standard Pack	Catalogue Number
5.2 mm	12 AWG/2.5 mm ²	500/24/28-12	300/20/26-12	Gray	2	25	XBAPSC252
					3	25	XBAPSC253
					4	25	XBAPSC254
					5	25	XBAPSC255
					6	25	XBAPSC256
					7	25	XBAPSC257
					8	25	XBAPSC258
					9	25	XBAPSC259
					10	25	XBAPSC2510
					11	10	XBAPSC2511
					12	10	XBAPSC2512

Accessories

Pluggable Spring Connection Receptacles

Description	Colour	Number of Positions	Standard Pack	XBAPSC25_ Catalogue Number
2.3 mm diameter test plug	Red	—	—	XBATSMPS_- ^①
Strain relief	Black	2	10	XBAPPDZ2
	Black	4	10	XBAPPDZ4
Blank marker strip	White	—	10	XBMZBF5 ^②

Technical Data and Specifications

Spring Cage Connection Plugs

Description	XBAPSP25_
Technical Data in Accordance with IEC	
Maximum load current in A/cross-section in mm ²	24/4
Rated surge voltage in kV/contamination class	6/3
Surge voltage category/insulating material group	III/I
Connection Capacity	
Stranded with ferrule with plastic sleeve in mm ²	0.25–2.5
Stranded with ferrules without plastic sleeve in mm ²	0.25–2.5
Stranded with twin ferrule with plastic sleeve in mm ²	0.5
Stripping length in inches (mm)	0.39 (10)

Dimensions

Approximate Dimensions in Inches (mm)

Spring Cage Connection Plugs

Catalogue Number	Width	Length	Cover Length	Height
XBAPSP25_	0.20 (5.2)	1.46 (37.2)	0.09 (2.2)	0.71 (18.0)

Receptacle Widths

Catalogue Number	Width	Catalogue Number	Width
XBAPSC252	0.41 (10.4)	XBAPSC258	1.64 (41.6)
XBAPSC253	0.61 (15.6)	XBAPSC259	1.84 (46.8)
XBAPSC254	0.82 (20.8)	XBAPSC2510	2.05 (52.0)
XBAPSC255	1.02 (26.0)	XBAPSC2511	2.25 (57.2)
XBAPSC256	1.23 (31.2)	XBAPSC2512	2.46 (62.4)
XBAPSC257	1.43 (36.4)		

Notes

① For ordering information, see **Page T42-105**.

② For information on Printed Marking Tag Options, see **Page T42-98**.

For additional accessories, see **Page T42-90**.

42.1

Terminal Blocks, Fuse Blocks and Fuse Holders

IEC—XB Series

Connection Accessories

Product Description

The pluggable XBPT series features an extensive range of application-oriented accessories. Strain reliefs are available for the plugs and

can be snapped on at the required points as an option. The snap-lock fitting can be used for all plug variants. It is snapped into the outside of

the plug housing as an option and hooks onto the terminal block housing when the plug is snapped on.

Product Selection

Pluggable Spring Cage Connection Accessories

	Description	Number of Positions	Standard Pack	Catalogue Number
XBAPPZ2 	Strain relief for single plugs	2	10	XBAPPZ2
		4	10	XBAPPZ4
XBAPPDZ4 	Strain relief for double plugs and receptacles	2	10	XBAPPDZ2
		4	10	XBAPPDZ4
XBAPPR2 	Snap-lock fitting for plugs	1	10	XBAPPR
		2	10	XBAPPR2
XBAPPRZ 	Snap-lock fitting and strain relief for plugs	2	10	XBAPPRZ

Strain Relief

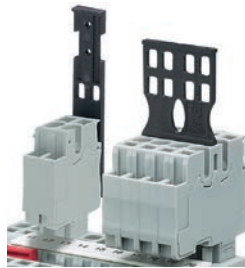

Snap-Lock Fitting



Optional Accessory Recommendations

Number of Positions Receptacle	Strain Relief
2–4	XBAPPZ2
5–10	XBAPPZ4 or (2) XBAPPZ2
11–15	(2) XBAPPZ4 or (4) XBAPPZ2

IDC Terminal Blocks



Contents

Description	Page
IDC Terminal Blocks	
Single Level	T42-68
Multi-Conductor	T42-70
Double Level	T42-73
Fuse Terminal Blocks	T42-75
Disconnect and Component Terminal Blocks	T42-77
Hybrid Terminal Blocks	T42-79

IDC (Insulation Displacement Connection) Terminal Blocks Overview

Product Description

The superior design of Eaton's Insulation Displacement Connection (IDC) technology terminal blocks reduces wiring installation time and labor, especially in high-volume applications. IDC terminal blocks are suited for applications in automated equipment and machine tools, packaging and material handling machinery, railway/mass transit systems, petrochemical, and any other application requiring high-volume connections for low-voltage control and signal circuitry where labor cost reduction and ease of assembly is desired. These terminal blocks are designed for long-term use under demanding conditions.

The XBQT Series allows for wire to be connected without any prior stripping. The quick connection provides up to 60% reduction in wiring time. One turn of a standard screwdriver results in a simple, fast and reliable connection.

Application Description

The XBQT is operated with a standard screwdriver. The switching states are clearly signaled by engagement points in the start and end positions. Solid and stranded wires of 0.25 to 2.5 mm² can be wired without the use of ferrules. Stripping the wire is not required—the wire's insulation is cut open when it is properly connected. The wire is securely placed in the end position where it makes large-area, gas-tight contact. Connections are made in seconds!

Features

- Quick connection capability
- Global acceptance
- Flexible plug-in bridge system
- Large surface area for marking
- Standardized testing system

Standards and Certifications

- UL recognized—File No. E67464
- CE approved
- LVD ^①
 - EN 60947-7-1
 - EN 60947-7-2
 - EN 60998-2-3
 - EN 60352-4/A1
- ATEX approval (Eex e applications)

**Note**

- ^① Not all standards apply to all terminal blocks. Contact Eaton for details.

Single Level

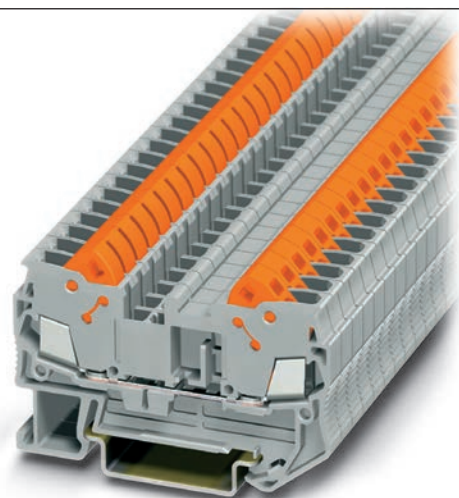

Contents

Description	Page
Single Level	
Accessories	T42-69
Technical Data and Specifications	T42-69
Dimensions	T42-69
Multi-Conductor	T42-70
Double Level	T42-73
Fuse Terminal Blocks	T42-75
Disconnect and Component Terminal Blocks	T42-77
Hybrid Terminal Blocks	T42-79

Single Level

Product Description

The XBQT IDC terminal block has the fastest connection time in a compact design. The space-saving front connection design offers additional space for wiring between the cable ducts. The double bridge shaft can

accommodate individual chain bridging and step-down bridging from other terminal blocks. The XBQT ground blocks are the same shape as the feed-through terminal blocks with the same wide range of cross-sections

available. They easily snap onto the DIN rail to make a reliable mechanical and electrical contact that meets all requirements of IEC 60-947-7-2.

Product Selection

XBQT25

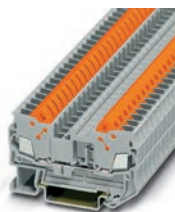

IDC—Single Level Terminal Blocks

Terminal Width	Maximum Wire Size	Connection Data in V/A/AWG	EN 50 019 ① in V/A/AWG	UL-cUL Ratings in V/A/AWG	Colour	Standard Pack	Catalogue Number
5.2 mm	16 AWG/1.5 mm ²	800/17.5/24–16	550/16/24–16	600/10/24–16	Gray	50	XBQT15
					Blue	50	XBQT15BU
6.2 mm	14 AWG/2.5 mm ²	800/24/20–14	—	600/15/20–14	Gray	50	XBQT25
					Blue	50	XBQT25BU

XBQT15PE



IDC—Single Level Terminal Ground Blocks

Terminal Width	Maximum Wire Size	Connection Data in V/A/AWG	EN 50 019 ① in V/A/AWG	UL-cUL Ratings in V/A/AWG	Colour	Standard Pack	Catalogue Number
5.2 mm	16 AWG/1.5 mm ²	—/—/24–16	—/—/24–16	—/—/24–16	Green/Yellow	50	XBQT15PE
6.2 mm	14 AWG/2.5 mm ²	—/—/20–14	—	—/—/20–14	Green/Yellow	50	XBQT25PE

Note

① EU type—examination certificate number: KEMA 05ATEX2157 U (XBQT15), KEMA 05ATEX2160 U (XBQT25).

Accessories

IDC—Single Level Terminal/Ground Blocks

Description	Colour	Number of Positions	Standard Pack	XBQT15 Catalogue Number	XBQT25 Catalogue Number	XBQT15PE Catalogue Number	XBQT25PE Catalogue Number
End cover	Gray	—	10	XBACQT15	XBACQT25	XBACQT15	XBACQT25
Partition plate	—	—	10	XBATQT25	XBATQT25	XBATQT25	XBATQT25
Plug-in bridge	Red	2	10	XBAFBS25	XBAFBS26	XBAFBS25	XBAFBS26
		3	10	XBAFBS35	XBAFBS36	XBAFBS35	XBAFBS36
		5	10	XBAFBS55	XBAFBS56	XBAFBS55	XBAFBS56
		10	10	XBAFBS105	XBAFBS106	XBAFBS105	XBAFBS106
		50	10	XBAFBS505	XBAFBS506	XBAFBS505	XBAFBS506
Test adapter	—	—	10	XBATSPA14	XBATSPA14	XBATSPA14	XBATSPA14
2.3 mm diameter test plug	—	—	—	XBATSMPS-^①	XBATSMPS-^①	XBATSMPS-^①	XBATSMPS-^①
Modular test plug	—	—	10	XBATSPS5	XBATSPS6	XBATSPS5	XBATSPS6
Blank marker strip centre and external marking	White	—	10	XBMZBF5^②	XBMZBF6^②	XBMZBF5^②	XBMZBF6^②
Blank marker strip centre labeling (strip of 10)	White	—	10	XBMZB5^②	XBMZB6^②	XBMZB5^②	XBMZB6^②

Technical Data and Specifications

IDC—Single Level Terminal/Ground Blocks

Description	XBQT15	XBQT25	XBQT15PE	XBQT25PE
Technical Data in Accordance with IEC				
Maximum load current in A/cross-section in mm ²	17.5/1.5	24/2.5	—	—
Rated surge voltage in kV/contamination class	8/3	8/3	8/3	8/3
Surge voltage category/insulating material group	III/I	III/I	III/I	III/I
Connection Cross-Section				
Core insulation	PVC/PE	PVC/PE	PVC/PE	PVC/PE
Single/multiple/fine strand in mm ²	1.5	2.5	1.5	2.5
Halogen-free in mm ²	1.5	2.5	1.5	2.5
Fine strand/superfine strand in AWG (mm ²)	24–16 (0.25–0.34)	20–14 (—)	24–16 (0.25–0.34)	20–14 (—)
Repeated connections minimum 100 x in mm ²	0.25–1.5	0.5–2.5	0.25–1.5	0.5–2.5

Dimensions

Approximate Dimensions in Inches (mm)

IDC—Single Level Terminal/Ground Blocks

Catalogue Number	Width	Length	Cover Length	Height for—	
				35 x 7.5 in	35 x 15 in
XBQT15	0.20 (5.2)	2.31 (58.8)	0.09 (2.2)	1.55 (39.3)	1.84 (46.8)
XBQT25	0.24 (6.2)	2.46 (62.6)	0.09 (2.2)	1.55 (39.3)	1.84 (46.8)
XBQT15PE	0.20 (5.2)	2.31 (58.8)	0.09 (2.2)	1.55 (39.3)	1.84 (46.8)
XBQT25PE	0.24 (6.2)	2.46 (62.6)	0.09 (2.2)	1.55 (39.3)	1.84 (46.8)

Notes

① For ordering information, see **Page T42-105**.

② For information on Printed Marking Tag Options, see **Page T42-98**.

For additional accessories, see **Page T42-90**.

Multi-Conductor

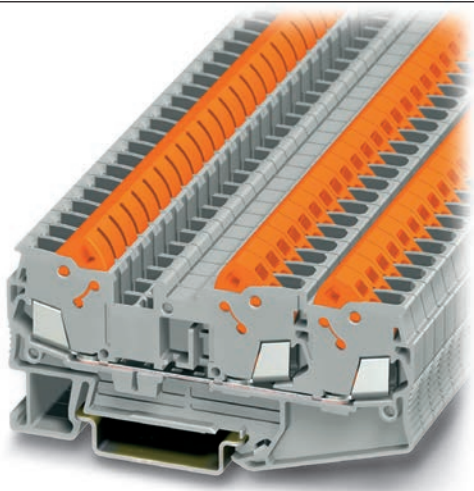

Contents

Description	Page
Single Level	T42-68
Multi-Conductor	
Accessories	T42-71
Technical Data and Specifications	T42-72
Dimensions	T42-72
Double Level	T42-73
Fuse Terminal Blocks	T42-75
Disconnect and Component Terminal Blocks	T42-77
Hybrid Terminal Blocks	T42-79

Multi-Conductor

Product Description

The XBQT IDC terminal block has the fastest connection time in a compact design. The space-saving front connection design offers additional space for wiring between the cable ducts. The double bridge shaft can

accommodate individual chain bridging and step-down bridging from other terminal blocks. The XBQT ground blocks are the same shape as the feed-through terminal blocks with the same wide range of cross-sections

available. They easily snap onto the DIN rail to make a reliable mechanical and electrical contact that meets all requirements of IEC 60-947-7-2.

Product Selection

XBQT25D12



IDC—Multi-Conductor Terminal Blocks, Three-Wire

Terminal Width	Maximum Wire Size	Connection Data in V/A/AWG	EN 50 019 ① in V/A/AWG	UL-cUL Ratings in V/A/AWG	Colour	Standard Pack	Catalogue Number
5.2 mm	16 AWG/1.5 mm ²	800/17.5/24–16	550/16/24–16	600/10/24–16	Gray	50	XBQT15D12
					Blue	50	XBQT15D12BU
6.2 mm	14 AWG/2.5 mm ²	800/24/20–14	—	600/15/20–14	Gray	50	XBQT25D12
					Blue	50	XBQT25D12BU

XBQT15D22PE



IDC—Multi-Conductor Terminal Blocks, Four-Wire

Terminal Width	Maximum Wire Size	Connection Data in V/A/AWG	EN 50 019 ① in V/A/AWG	UL-cUL Ratings in V/A/AWG	Colour	Standard Pack	Catalogue Number
5.2 mm	16 AWG/1.5 mm ²	800/17.5/24–16	550/16/24–16	600/10/24–16	Gray	50	XBQT15D22
					Blue	50	XBQT15D22BU

IDC—Multi-Conductor Terminal Blocks, Four-Wire Ground Blocks

Terminal Width	Maximum Wire Size	Connection Data in V/A/AWG	EN 50 019 ① in V/A/AWG	UL-cUL Ratings in V/A/AWG	Colour	Standard Pack	Catalogue Number
5.2 mm	16 AWG/1.5 mm ²	—/—/24–16	—/—/24–16	—/—/24–16	Green/Yellow	50	XBQT15D22PE

Note

① EU type—examination certificate number: KEMA 05ATEX2157 U (XBQT15), KEMA 05ATEX2160 U (XBQT25).

XBQT15D12PE

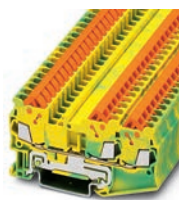

IDC—Multi-Conductor Terminal Blocks, Three-Wire Ground Blocks

Terminal Width	Maximum Wire Size	Connection Data in V/A/AWG	EN 50 019 ^① in V/A/AWG	UL-cUL Ratings in V/A/AWG	Colour	Standard Pack	Catalogue Number
5.2 mm	16 AWG/1.5 mm ²	—/—/24–16	—/—/24–16	—/—/24–16	Green/Yellow	50	XBQT15D12PE
6.2 mm	14 AWG/2.5 mm ²	—/—/20–14	—	—/—/20–14	Green/Yellow	50	XBQT25D12PE

Accessories

IDC—Multi-Conductor Terminal Blocks

Description	Colour	Number of Positions	Standard Pack	XBQT15D12 Catalogue Number	XBQT25D12 Catalogue Number	XBQT15D22 Catalogue Number
End cover	Gray	—	10	XBACQT15D12	XBACQT25D12	XBACQT15D22
End cover segment	Gray	—	10	XBASQT15	XBASQT25	XBASQT15
Partition plate	—	—	10	XBATQTD12	XBATQTD12	XBATQTD22
Plug-in bridge—for cross connections in the terminal centre	Red	2	10	XBAFBS25	XBAFBS26	XBAFBS25
		3	10	XBAFBS35	XBAFBS36	XBAFBS35
		5	10	XBAFBS55	XBAFBS56	XBAFBS55
		10	10	XBAFBS105	XBAFBS106	XBAFBS105
		50	10	XBAFBS505	XBAFBS506	XBAFBS505
Test adapter	—	—	10	XBATSPA14	XBATSPA14	XBATSPA14
2.3 mm diameter test plug	—	—	—	XBATSMPS- ^②	XBATSMPS- ^②	XBATSMPS- ^②
Modular test plug	—	—	10	XBATSPS5	XBATSPS6	XBATSPS5
Blank marker strip centre and external marking	White	—	10	XBMZBF5 ^③	XBMZBF6 ^③	XBMZBF5 ^③
Blank marker strip centre labeling (strip of 10)	White	—	10	XBMZB5 ^③	XBMZB6 ^③	XBMZB5 ^③

IDC—Multi-Conductor Terminal/Ground Blocks

Description	Colour	Number of Positions	Standard Pack	XBQT15D12PE Catalogue Number	XBQT25D12PE Catalogue Number	XBQT15D22PE Catalogue Number
End cover	Gray	—	10	XBACQT15D12	XBACQT25D12	XBACQT15D22
End cover segment	Gray	—	10	XBASQT15	XBASQT25	XBASQT15
Partition plate	—	—	10	XBATQTD12	XBATQTD12	XBATQTD22
Plug-in bridge—for cross connections in the terminal centre	Red	2	10	XBAFBS25	XBAFBS26	XBAFBS25
		3	10	XBAFBS35	XBAFBS36	XBAFBS35
		5	10	XBAFBS55	XBAFBS56	XBAFBS55
		10	10	XBAFBS105	XBAFBS106	XBAFBS105
		50	10	XBAFBS505	XBAFBS506	XBAFBS505
Test adapter	—	—	10	XBATSPA14	XBATSPA14	XBATSPA14
2.3 mm diameter test plug	—	—	—	XBATSMPS- ^②	XBATSMPS- ^②	XBATSMPS- ^②
Modular test plug	—	—	10	XBATSPS5	XBATSPS6	XBATSPS5
Blank marker strip centre and external marking	White	—	10	XBMZBF5 ^③	XBMZBF6 ^③	XBMZBF5 ^③
Blank marker strip centre labeling (strip of 10)	White	—	10	XBMZB5 ^③	XBMZB6 ^③	XBMZB5 ^③

Notes

^① EU type—examination certificate number: KEMA 05ATEX2157 U (XBQT15PE), KEMA 05ATEX2160 U (XBQT25PE).

^② For ordering information, see [Page T42-105](#).

^③ For information on Printed Marking Tag Options, see [Page T42-98](#).

For additional accessories, see [Page T42-90](#).

Technical Data and Specifications

IDC—Multi-Conductor Terminal Blocks

Description	XBQT15D12	XBQT25D12	XBQT15D12PE	XBQT25D12PE	XBQT15D22	XBQT15D22PE
Technical Data in Accordance with IEC						
Maximum load current in A/cross-section in mm ²	17.5/1.5	24/2.5	—	—	17.5/1.5	—
Rated surge voltage in kV/contamination class	8/3	8/3	8/3	8/3	8/3	8/3
Surge voltage category/insulating material group	III/I	III/I	III/I	III/I	III/I	III/I
Connection Cross-Section						
Core insulation	PVC/PE	PVC/PE	PVC/PE	PVC/PE	PVC/PE	PVC/PE
Single/multiple/fine strand in mm ²	1.5	2.5	1.5	2.5	1.5	1.5
Halogen-free in mm ²	1.5	2.5	1.5	2.5	1.5	1.5
Fine strand/superfine strand in AWG (mm ²)	24–16 (0.25–0.34)	20–14 (—)	24–16 (0.25–0.34)	20–14 (—)	24–16 (0.25–0.34)	24–16 (0.25–0.34)
Repeated connections minimum 100 x in mm ²	0.25–1.5	0.5–2.5	0.25–1.5	0.5–2.5	0.25–1.5	0.25–1.5

Dimensions

Approximate Dimensions in Inches (mm)

IDC—Multi-Conductor Terminal Blocks

Catalogue Number	Width	Length	Cover Length	Height for—	
				35 x 7.5 in	35 x 15 in
XBQT15D12	0.20 (5.2)	3.01 (76.4)	0.09 (2.2)	1.55 (39.3)	1.84 (46.8)
XBQT25D12	0.24 (6.2)	3.25 (82.5)	0.09 (2.2)	1.69 (42.8)	1.98 (50.3)
XBQT15D12PE	0.20 (5.2)	3.01 (76.4)	0.09 (2.2)	1.55 (39.3)	1.84 (46.8)
XBQT25D12PE	0.20 (5.2)	3.25 (82.5)	0.09 (2.2)	1.69 (42.8)	1.98 (50.3)
XBQT15D22	0.20 (5.2)	3.70 (94.0)	0.09 (2.2)	1.55 (39.3)	1.84 (46.8)
XBQT15D22PE	0.20 (5.2)	3.70 (94.0)	0.09 (2.2)	1.55 (39.3)	1.84 (46.8)

Double Level

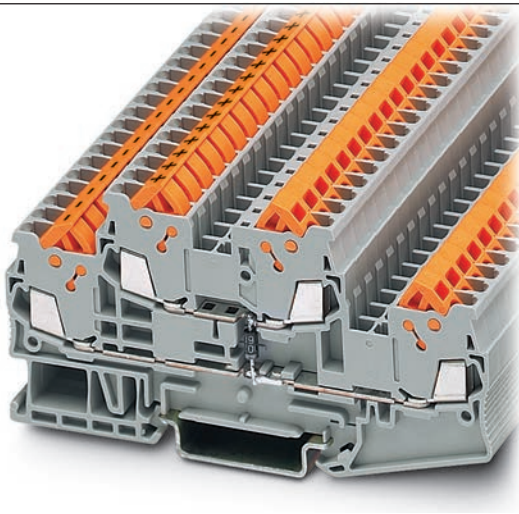

Contents

Description	Page
Single Level	T42-68
Multi-Conductor	T42-70
Double Level	
Accessories	T42-74
Technical Data and Specifications	T42-74
Dimensions	T42-74
Fuse Terminal Blocks	T42-75
Disconnect and Component Terminal Blocks	T42-77
Hybrid Terminal Blocks	T42-79

Double Level

Product Description

The XBQTT IDC terminal block has the fastest connection time in a compact design. The space-saving front connection design offers additional space for wiring between the cable ducts. The double bridge

shaft, found in each level, can accommodate individual chain bridging and step-down bridging from other terminal blocks. The XBQTT ground blocks are the same shape as the feed-through terminal blocks with the same wide

range of cross-sections available. They easily snap onto the DIN rail to make a reliable mechanical and electrical contact that meets all requirements of IEC 60-947-7-2.

Product Selection

XBQTT15

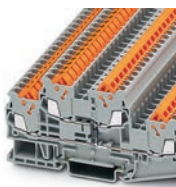

IDC—Double Level Terminal Blocks

Terminal Width	Maximum Wire Size	Connection Data in V/A/AWG	EN 50 019 ① in V/A/AWG	UL-cUL Ratings in V/A/AWG	Colour	Standard Pack	Catalogue Number
5.2 mm	16 AWG/1.5 mm ²	800/17.5/24–16	420/15/24–16	600/10/24–16	Gray	50	XBQTT15
					Blue	50	XBQTT15BU

XBQTT15PE

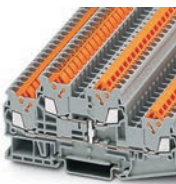

IDC—Double Level Ground Blocks

Terminal Width	Maximum Wire Size	Connection Data in V/A/AWG	EN 50 019 ① in V/A/AWG	UL-cUL Ratings in V/A/AWG	Colour	Standard Pack	Catalogue Number
6.2 mm	14 AWG/2.5 mm ²	—/—/24–16	—/—/24–16	—/—/24–16	Green/Yellow	50	XBQTT15PE

Note

① EU type—examination certificate number: KEMA 05ATEX2157 U (XBQTT15), KEMA 05ATEX2160 U (XBQTT25).

Accessories

IDC—Double Level Terminal/Ground Blocks

Description	Colour	Number of Positions	Standard Pack	XBQTT15 Catalogue Number	XBQTT15PE Catalogue Number
End cover	Gray	—	10	XBACQTT15	XBACQTT15
Partition plate	—	—	10	XBATQTT15	XBATQTT15
Plug-in bridge—for cross connections in the terminal centre	Red	2	10	XBAFBS25	XBAFBS25
		3	10	XBAFBS35	XBAFBS35
		5	10	XBAFBS55	XBAFBS55
		10	10	XBAFBS105	XBAFBS105
		20	10	XBAFBS505	XBAFBS505
Test adapter	—	—	10	XBATSPA14	XBATSPA14
2.3 mm diameter test plug	—	—	—	XBATSMPS- ^①	XBATSMPS- ^①
Modular test plug	—	—	10	XBATSPS5	XBATSPS5
Blank marker strip	White	—	10	XBMZBF5 ^②	XBMZBF5 ^②

Technical Data and Specifications

IDC—Double Level Terminal/Ground Blocks

Description	XBQTT15	XBQTT15PE
Technical Data in Accordance with IEC		
Maximum load current in A/cross-section in mm ²	17.5/1.5	—
Rated surge voltage in kV/contamination class	6/3	6/3
Surge voltage category/insulating material group	III/I	III/I
Connection Cross-Section		
Core insulation	PVC/PE	PVC/PE
Single/multiple/fine strand in mm ²	1.5	1.5
Halogen-free in mm ²	1.5	1.5
Fine strand/superfine strand in AWG (mm ²)	24–16 (0.25–0.34)	24–16 (0.25–0.34)
Repeated connections minimum 100 x in mm ²	0.25–1.5	0.25–1.5

Dimensions

Approximate Dimensions in Inches (mm)

IDC—Double Level Terminal/Ground Blocks

Catalogue Number	Width	Length	Cover Length	Height for—	
				35 x 7.5 in	35 x 15 in
XBQTT15	0.20 (5.2)	3.92 (99.6)	0.09 (2.2)	1.96 (49.9)	2.26 (57.4)
XBQTT15PE	0.20 (5.2)	3.92 (99.6)	0.09 (2.2)	1.96 (49.9)	2.26 (57.4)

Notes

① For ordering information, see **Page T42-105**.② For information on Printed Marking Tag Options, see **Page T42-98**.For additional accessories, see **Page T42-90**.

Fuse Terminal Blocks



Contents

Description	Page
Single Level	T42-68
Multi-Conductor	T42-70
Double Level	T42-73
Fuse Terminal Blocks	
Accessories	T42-76
Technical Data and Specifications	T42-76
Dimensions	T42-76
Disconnect and Component Terminal Blocks	T42-77
Hybrid Terminal Blocks	T42-79

Fuse Terminal Blocks

Product Description

The XBQT lever-type fuse terminal blocks perform two main functions. It is a carrier for a 5 x 20 mm cartridge fuse insert and can also allow for potential distribution via the double bridge shaft.

This means that two potentials can be carried separately alongside each other. Versions with light indication (AC and DC voltage) are available to signal a triggered fuse.

Product Selection

XBQT25FB



IDC—Fuse Terminal Blocks

Terminal Width	Maximum Wire Size	Connection Data in V/A/AWG	UL-cUL Ratings in V/A/AWG	Colour	Standard Pack	Catalogue Number
IDC Fuse Terminal Blocks						
6.2 mm	14 AWG/2.5 mm ²	①/6.3/20–14	300/15/20–14	Black	50	XBQT25FBE
IDC Fuse Terminal Blocks with LED 12–30V, 1–2.5 mA						
6.2 mm	14 AWG/2.5 mm ²	①/6.3/20–14	300/15/20–14	Black	50	XBQT25FBEL24
IDC Fuse Terminal Blocks with LED 30–60V, 0.8–2.0 mA						
6.2 mm	14 AWG/2.5 mm ²	①/6.3/20–14	300/15/20–14	Black	50	XBQT25FBEL60
IDC Fuse Terminal Blocks with LED 110–250V, 0.5–2.5 mA						
6.2 mm	14 AWG/2.5 mm ²	①/6.3/20–14	300/15/20–14	Black	50	XBQT25FBEL250

Note

① As disconnect terminal block, 400V; as fuse terminal blocks 250V.

Accessories

IDC—Fuse Terminal Blocks

Description	Colour	Number of Positions	Standard Pack	XBQT25FBE Catalogue Number
End cover	Gray	—	10	XBACQT25D12
Partition plate	—	—	10	XBATQTD12
Plug-in bridge—for cross connections in the terminal centre	Red	2	10	XBAFBS26
		3	10	XBAFBS36
		5	10	XBAFBS56
		10	10	XBAFBS106
Test adapter	—	—	10	XBATSPA14
2.3 mm diameter test plug	—	—	—	XBATSMPS- ^①
Modular test plug	—	—	10	XBATSPS5
Blank marker strip centre and external marking	White	—	10	XBMZBF6 ^②
Blank marker strip lever labeling	White	—	10	XBMZB5 ^②
Blank marker strip centre labeling (strip of 10)	White	—	10	XBMZB6 ^②

Technical Data and Specifications

IDC—Fuse Terminal Blocks

Description	XBQT25FBE
Technical Data in Accordance with IEC	
Maximum load current in A/cross-section in mm ²	6.3/2.5
Rated surge voltage in kV/contamination class	4/3
Surge voltage category/insulating material group	III/I
Connection Cross-Section	
Core insulation	PVC/PE
Single/multiple/fine strand in mm ²	2.5
Halogen-free in mm ²	2.5
Fine strand/superfine strand in AWG (mm ²)	24–14 (—)
Repeated connections minimum 100 x in mm ²	0.5–2.5

Dimensions

Approximate Dimensions in Inches (mm)

IDC—Fuse Terminal Blocks

Catalogue Number	Width	Length	Cover Length	Height for—	
				35 x 7.5 in	35 x 15 in
XBQT25FBE	0.24 (6.2)	3.25 (82.5)	0.09 (2.2)	1.69 (42.8)	1.98 (50.3)

Notes

^① For ordering information, see **Page T42-105**.

^② For information on Printed Marking Tag Options, see **Page T42-98**.

For additional accessories, see **Page T42-90**.

Disconnect and Component Terminal Blocks

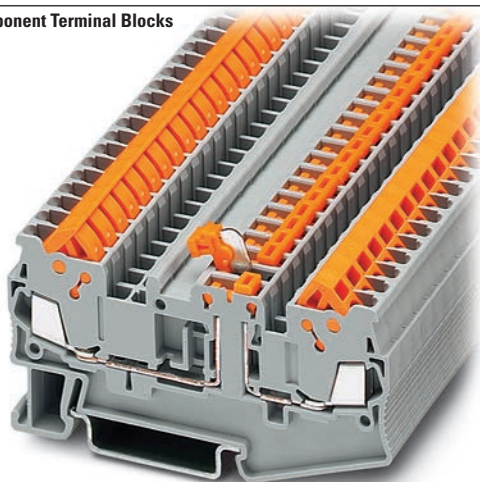

Contents

Description	Page
Single Level	T42-68
Multi-Conductor	T42-70
Double Level	T42-73
Fuse Terminal Blocks	T42-75
Disconnect and Component Terminal Blocks	
Accessories	T42-78
Technical Data and Specifications	T42-78
Dimensions	T42-78
Hybrid Terminal Blocks	T42-79

Disconnect and Component Terminal Blocks

Product Description

The **XB** Series includes application specific terminal blocks like disconnect blocks. The knife disconnect terminal blocks (XBQT15MT) has a fitted knife. The XBQT15TG

can accommodate component plugs for resistors or capacitors and fuse plugs for 5 x 20 mm fuses with or without a light indicator for signaling a triggered fuse.

Both terminal blocks have three bridge shafts—two in the standard positions and one on the other side of the disconnect point.

Product Selection

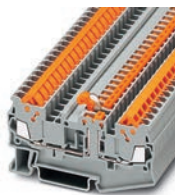
XBQT15MT
Knife Disconnect

IDC—Disconnect and Component Terminal Blocks

Terminal Width	Maximum Wire Size	Connection Data in V/A/AWG	UL-cUL Ratings in V/A/AWG	UL-cUL Ratings for Disconnect in V/A/AWG	UL-cUL Ratings for Disconnect with Test Sockets in V/A/AWG	Colour	Standard Pack	Catalogue Number
Knife Disconnect								
5.2 mm	16 AWG/1.5 mm ²	400/16/24–16	600/10/24–16	—	—	Gray	50	XBQT15MT
Component Disconnect								
5.2 mm	16 AWG/1.5 mm ²	400/16/24–16	600/10/24–16	—	—	Gray	50	XBQT15TG
6.2 mm	14 AWG/2.5 mm ²	400/16/20–14	300/10/20–14	—	—	Gray	50	XBQT25TG
Component Plug								
6.2 mm	10 AWG/4 mm ²	500/16/26–10	—	600/16/26–10	300/16/26–10	Gray	10	XBPCO
Fuse Plug								
6.2 mm	10 AWG/4 mm ²	500/16/26–10	—	600/16/26–10	300/16/26–10	Black	10	XBPFU
Fuse Plug with Light Indicator for 12–30V, 1–2.5 mA								
6.2 mm	10 AWG/4 mm ²	500/16/26–10	—	600/16/26–10	300/16/26–10	Black	10	XBPFUL24
Fuse Plug with Light Indicator for 110–250V, 0.5–2.5 mA								
6.2 mm	10 AWG/4 mm ²	500/16/26–10	—	600/16/26–10	300/16/26–10	Black	10	XBPFUL250

Accessories

IDC—Disconnect and Component Terminal Blocks

Description	Colour	Number of Positions	Standard Pack	XBQT15MT Catalogue Number	XBQT15TG Catalogue Number	XBQT25TG Catalogue Number
End cover	Gray	—	10	XBACQT15D12	XBACQT15D12	XBACQT25D12
End cover segment	Gray	—	10	XBASQT15	XBASQT15	XBASQT25
Partition plate	—	—	10	XBATQTD12	XBATQTD12	XBATQTD12
Plug-in bridge	Red	2	10	XBAFBS25	XBAFBS25	XBAFBS26
		3	10	XBAFBS35	XBAFBS35	XBAFBS36
		5	10	XBAFBS55	XBAFBS55	XBAFBS56
		10	10	XBAFBS105	XBAFBS105	XBAFBS106
Test adapter	—	—	10	XBATSPA14	XBATSPA14	XBATSPA14
2.3 mm diameter test plug	—	—	—	XBATSMPS_ ^①	XBATSMPS_ ^①	XBATSMPS_ ^①
Modular test plug	—	—	10	XBATSPS5	XBATSPS5	XBATSPS5
Blank marker strip centre and external marking	White	—	10	XBMZBF5 ^②	XBMZBF5 ^②	XBMZBF6 ^②
Blank marker strip centre labeling (strip of 10)	White	—	10	XBMZB5 ^②	XBMZB5 ^②	XBMZB6 ^②

Technical Data and Specifications

IDC—Disconnect and Component Terminal Blocks

Description	XBQT15MT	XBQT15TG	XBQT25TG
Technical Data in Accordance with IEC			
Maximum load current in A/cross-section in mm ²	16/1.5	16/1.5	16/2.5
Rated surge voltage in kV/contamination class	6/3	6/3	6/3
Surge voltage category/insulating material group	III/I	III/I	III/I
Connection Cross-Section			
Core insulation	PVC/PE	PVC/PE	PVC/PE
Single/multiple/fine strand in mm ²	1.5	1.5	2.5
Halogen-free in mm ²	1.5	1.5	2.5
Fine strand/superfine strand in AWG (mm ²)	24–16 (0.25–0.34)	24–16 (0.25–0.34)	20–14 (—)
Repeated connections minimum 100 x in mm ²	0.25–1.5	0.25–1.5	0.5–2.5

Dimensions

Approximate Dimensions in Inches (mm)

IDC—Disconnect and Component Terminal Blocks

Catalogue Number	Width	Length	Cover Length	Height for—	
				35 x 7.5 in	35 x 15 in
XBQT15MT	0.20 (5.2)	3.01 (76.4)	0.09 (2.2)	1.55 (39.3)	1.84 (46.8)
XBQT15TG	0.20 (5.2)	3.01 (76.4)	0.09 (2.2)	1.55 (39.3)	1.84 (46.8)
XBQT25TG	0.24 (6.2)	3.25 (82.5)	0.09 (2.2)	1.69 (42.8)	1.98 (50.3)

Notes

① For ordering information, see **Page T42-105**.② For information on Printed Marking Tag Options, see **Page T42-98**.For additional accessories, see **Page T42-90**.

Hybrid Terminal Blocks

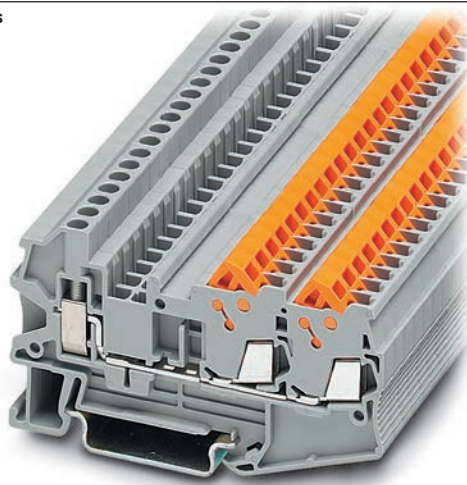

Contents

<i>Description</i>	<i>Page</i>
Single Level	T42-68
Multi-Conductor	T42-70
Double Level	T42-73
Fuse Terminal Blocks	T42-75
Disconnect and Component Terminal Blocks	T42-77
Hybrid Terminal Blocks	
Accessories	T42-80
Technical Data and Specifications	T42-81
Dimensions	T42-81

Hybrid Terminal Blocks

Product Description

The XBQT hybrid terminal blocks offer the best of both worlds. One side offers the time-saving advantage of our insulation displacement

connection technology, while the other side offers a universal screw connection. Use the IDC side on the internal (factory) control

cabinet side and the screw connection on the end customer (field) side. Ground terminal blocks of the same shape are also available

Product Selection

XBQU25

IDC—Hybrid Terminal Blocks, Single Level



Terminal Width	Maximum Wire Size	IEC Screw Connection in V/A/AWG	IEC IDC Connection in V/A/AWG	UL-cUL Screw Connection in V/A/AWG	UL-cUL IDC Connection in V/A/AWG	Colour	Standard Pack	Catalogue Number
5.2 mm	12 AWG/2.5 mm ²	800/17.5/26–12	800/17.5/24–16	600/10/26–12	600/10/24–16	Gray	50	XBQU15
6.2 mm	10 AWG/4 mm ²	800/24/26–10	800/24/20–14	600/15/26–10	600/15/20–14	Gray	50	XBQU25

XBQU15D12

IDC—Hybrid Terminal Blocks, Three-Wire



Terminal Width	Maximum Wire Size	IEC Screw Connection in V/A/AWG	IEC IDC Connection in V/A/AWG	UL-cUL Screw Connection in V/A/AWG	UL-cUL IDC Connection in V/A/AWG	Colour	Standard Pack	Catalogue Number
5.2 mm	12 AWG/2.5 mm ²	800/17.5/26–12	800/17.5/24–16	800/10/26–12	800/10/24–16	Gray	50	XBQU15D12
6.2 mm	10 AWG/4 mm ²	800/24/26–10	800/24/20–14	600/15/26–10	600/15/20–14	Gray	50	XBQU25D12

XBQU25PE

IDC—Hybrid Terminal/Ground Blocks



Terminal Width	Maximum Wire Size	IEC Screw Connection in V/A/AWG	IEC IDC Connection in V/A/AWG	UL-cUL Screw Connection in V/A/AWG	UL-cUL IDC Connection in V/A/AWG	Colour	Standard Pack	Catalogue Number
5.2 mm	12 AWG/2.5 mm ²	—/—/26–12	—/—/24–16	—/—/26–12	—/—/24–16	Gray	50	XBQU15PE
6.2 mm	10 AWG/4 mm ²	—/—/26–10	—/—/20–14	—/—/26–10	—/—/20–14	Gray	50	XBQU25PE

Accessories

IDC—Hybrid Terminal Blocks

Description	Colour	Number of Positions	Standard Pack	XBQU15 Catalogue Number	XBQU25 Catalogue Number	XBQU15D12 Catalogue Number	XBQU25D12 Catalogue Number
End cover	Gray	—	10	XBACQU15	XBACQU25	XBACQU15D12	XBACQU25D12
End segment	Gray	—	10	—	—	XBASQT15	XBASQT25
Partition plate	—	—	10	XBATQT25	XBATQT25	XBATQTD12	XBATQTD12
Plug-in bridge—for cross connections in the bridge shaft	Red	2	10	XBAFBS25	XBAFBS26	XBAFBS25	XBAFBS26
		3	10	XBAFBS35	XBAFBS36	XBAFBS35	XBAFBS36
		5	10	XBAFBS55	XBAFBS56	XBAFBS55	XBAFBS56
		10	10	XBAFBS105	XBAFBS106	XBAFBS105	XBAFBS106
		50	10	XBAFBS505	XBAFBS506	XBAFBS505	XBAFBS506
Test adapter	—	—	10	XBATSPA14	XBATSPA14	XBATSPA14	XBATSPA14
2.3 mm diameter test plug	—	—	—	XBATSMPS- ^①	XBATSMPS- ^①	XBATSMPS- ^①	XBATSMPS- ^①
Modular test plug	—	—	10	XBATSPS5	XBATSPS6	XBATSPS5	XBATSPS6
Blank marker strip centre and external marking	White	—	10	XBMZBF5 ^②	XBMZBF6 ^②	XBMZBF5 ^②	XBMZBF6 ^②
Blank marker strip centre labeling (strip of 10)	—	—	—	XBMZB5 ^②	XBMZB6 ^②	XBMZB5 ^②	XBMZB6 ^②

IDC—Hybrid Terminal/Ground Blocks

Description	Colour	Number of Positions	Standard Pack	XBQU15PE Catalogue Number	XBQU25PE Catalogue Number
End cover	Gray	—	10	XBACQU15	XBACQU25
Partition plate	—	—	10	XBATQT25	XBATQT25
Plug-in bridge—for cross connections in the bridge shaft	Red	2	10	XBAFBS25	XBAFBS26
		3	10	XBAFBS35	XBAFBS36
		5	10	XBAFBS55	XBAFBS56
		10	10	XBAFBS105	XBAFBS106
		50	10	XBAFBS505	XBAFBS506
Test adapter	—	—	10	XBATSPA14	XBATSPA14
2.3 mm diameter test plug	—	—	—	XBATSMPS- ^①	XBATSMPS- ^①
Modular test plug	—	—	10	XBATSPS5	XBATSPS6
Blank marker strip centre and external marking	White	—	10	XBMZBF5 ^②	XBMZBF6 ^②
Blank marker strip centre labeling (strip of 10)	—	—	—	XBMZB5 ^②	XBMZB6 ^②

Notes

^① For ordering information, see **Page T42-105**.

^② For information on Printed Marking Tag Options, see **Page T42-98**.

For additional accessories, see **Page T42-90**.

Technical Data and Specifications

Screw Connection Single Level—Through-Feed

Description	XBQU15	XBQU25	XBQU15PE	XBQU25PE	XBQU15D12	XBQU25D12
Technical Data in Accordance with IEC						
Maximum load current in A/cross-section in mm ²	17.5/1.5	24/2.5	—	—	17.5/1.5	24/2.5
Rated surge voltage in kV/contamination class	8/3	8/3	8/3	8/3	8/3	8/3
Surge voltage category/insulating material group	III/I	III/I	III/I	III/I	III/I	III/I
Connection Cross-Section						
Core insulation	PVC/PE	PVC/PE	PVC/PE	PVC/PE	PVC/PE	PVC/PE
Single/multiple/fine strand in mm ²	1.5	2.5	1.5	2.5	1.5	2.5
Halogen-free in mm ²	1.5	2.5	1.5	2.5	1.5	2.5
Fine strand/superfine strand in AWG (mm ²)	24–16 (0.25–0.34)	20–14 (—)	24–16 (0.25–0.34)	20–14 (—)	24–16 (0.25–0.34)	20–14 (—)
Repeated connections minimum 100 x in mm ²	0.25–1.5	0.5–2.5	0.25–1.5	0.5–2.5	0.25–1.5	0.5–2.5
Connection Capacity—Screw Connection						
Stranded with ferrule/with ferrule and plastic sleeve in mm ²	0.25–2.5/0.25–2.5	0.25–4/0.25–4	0.25–2.5/0.25–2.5	0.25–4/0.25–4	0.25–2.5/0.25–2.5	0.25–4/0.25–4
Multi-Conductor Connection (same cross-section)						
Solid/stranded in mm ²	0.14–1.5/0.14–1.5	0.14–1.5/0.14–1.5	0.14–1.5/0.14–1.5	0.14–1.5/0.14–1.5	0.14–1.5/0.14–1.5	0.14–1.5/0.14–1.5
Stranded with ferrules without plastic sleeve in mm ²	0.25–1.5	0.25–1.5	0.25–1.5	0.25–1.5	0.25–1.5	0.25–1.5
Stranded with twin ferrule with plastic sleeve in mm ²	0.5–1.5	0.5–2.5	0.5–1.5	0.5–2.5	0.5–1.5	0.5–2.5
Stripping length in inches (mm)	0.35 (9)	0.35 (9)	0.35 (9)	0.35 (9)	0.35 (9)	0.35 (9)
Thread	M3	M3	M3	M3	M3	M3
Torque in in-lb (Nm)	5.3–7.1 (0.6–0.8)	5.3–7.1 (0.6–0.8)	5.3–7.1 (0.6–0.8)	5.3–7.1 (0.6–0.8)	5.3–7.1 (0.6–0.8)	5.3–7.1 (0.6–0.8)

Dimensions

Approximate Dimensions in Inches (mm)

Screw Connection Single Level—Through-Feed

Catalogue Number	Width	Length	Cover Width	Height for—	
				35 x 7.5 in	35 x 15 in
XBQU15	0.20 (5.2)	2.31 (58.8)	0.09 (2.2)	1.69 (42.8)	1.98 (50.3)
XBQU25	0.24 (6.2)	2.46 (62.6)	0.09 (2.2)	1.69 (42.8)	1.98 (50.3)
XBQU15PE	0.20 (5.2)	2.31 (58.8)	0.09 (2.2)	1.69 (42.8)	1.98 (50.3)
XBQU25PE	0.24 (6.2)	2.46 (62.6)	0.09 (2.2)	1.69 (42.8)	1.98 (50.3)
XBQU15D12	0.20 (5.2)	3.01 (76.4)	0.09 (2.2)	1.69 (42.8)	1.98 (50.3)
XBQU25D12	0.24 (6.2)	3.25 (82.5)	0.09 (2.2)	1.69 (42.8)	1.98 (50.3)

Miniature Circuit Breakers



42

Contents

Description

Page

Miniature Circuit Breakers	
Circuit Breakers.	T42-83
Flat-Type Fuse Terminal Blocks.	T42-86
Spring Cage Fuse Terminal Blocks	T42-88

Miniature Circuit Breakers Overview

Product Description

The new **XB** Series thermal miniature circuit breaker offers convenient overload protection. This space-saving single-pole circuit breaker, available up to 10 amps, can be inserted into a screw connection fuse terminal block, XBUK6FSI, or a spring cage fuse terminal block, XBPT4FSI, which is available with or without light indication. The XBATCP combines the

reclosing capability of a circuit breaker with the overload protection of a fuse. The integrated switching function makes it possible to switch the circuit breaker back on immediately, guaranteeing system availability. The device can also be used for switching purposes, as an ON/OFF switch. The Plug-in design allows for quick and efficient replacement.

Standards and Certifications

- UL and cUL recognized
- UL 1077—File No. E301915
- CE approved



Circuit Breakers

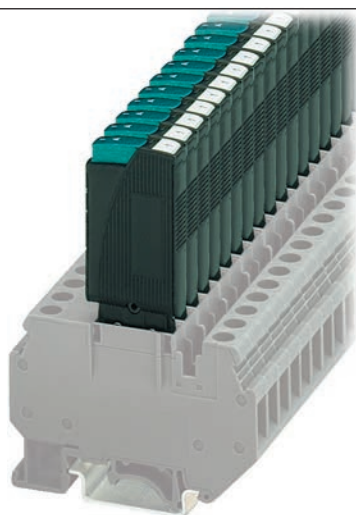

Contents

Description	Page
Circuit Breakers	
Accessories	T42-84
Technical Data and Specifications	T42-84
Time/Current Curve	T42-85
Dimensions	T42-85
Flat-Type Fuse Terminal Blocks	T42-86
Spring Cage Fuse Terminal Blocks	T42-88

Circuit Breakers

Product Description

The thermal miniature circuit breaker can be switched back on again, has a compact design, and is available

in 10 finely graded steps for nominal currents from 0.1 to 10A.

Product Selection

XBAT

Thermal Miniature Circuit Breaker

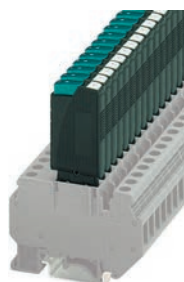

Connection Data in Vac/Vdc	Nominal Current	Colour	Standard Pack	Catalogue Number
250/65	0.1A	Black	20	XBATCPT
	0.25A	Black	20	XBATCPQ
	0.5A	Black	20	XBATCPH
	1.0A	Black	20	XBATCP1
	2.0A	Black	20	XBATCP2
	3.0A	Black	20	XBATCP3
	4.0A	Black	20	XBATCP4
	6.0A	Black	20	XBATCP6
	8.0A	Black	20	XBATCP8
	10.0A	Black	20	XBATCP10

Accessories

Thermal Miniature Circuit Breaker

Description	Colour	Number of Positions	Standard Pack	XBAT Catalogue Number
Blank marker strip	White	—	10	XBZBF5 ①
Flat type terminal blocks	—	—	—	XBUK6FSI XBUK6FSIL12 XBUK6FSIL24 XBPT4FSI XBPT4FSIL12 XBPT4FSIL24

42

Technical Data and Specifications

Thermal Miniature Circuit Breaker

Description	XBAT
Technical Data in Accordance with IEC	
Nominal voltage in Vac/Vdc	250/65
Nominal current in A	0.25–10
Ambient temperature	–4 to 140°F (–20 to 60°C)
Maximum Power Dissipation	
Rated surge voltage in kV/contamination class	2.5/2
Surge voltage category/insulating material group	III/I
Switching Capacity	
Cycles with 1 x I _N (low-induction)	6000
Cycles with 1 x I _N (induction)	3000
Cycles with 2 x I _N (induction)	500
Switching Capacity I CN	
For nominal currents of 0.25–4A/6–10A	6 x I _N /8 x I _N
Switching capacity (UL 1077) 250 Vac/65 Vdc	2000/200

Nominal Currents and Internal Resistances

Nominal Current (A)	Internal Resistance (3/4)
0.25	14
0.5	3.4
1.0	0.9
2.0	0.25
3.0	0.11
4.0	0.07
6.0	≤0.05
8.0	≤0.05
10.0	≤0.05

Note

① For information on Printed Marking Tag Options, see **Page T42-98**.

Time/Current Curve

Total Switch-Off Period for Nominal Current, 73.4°F (23°C)

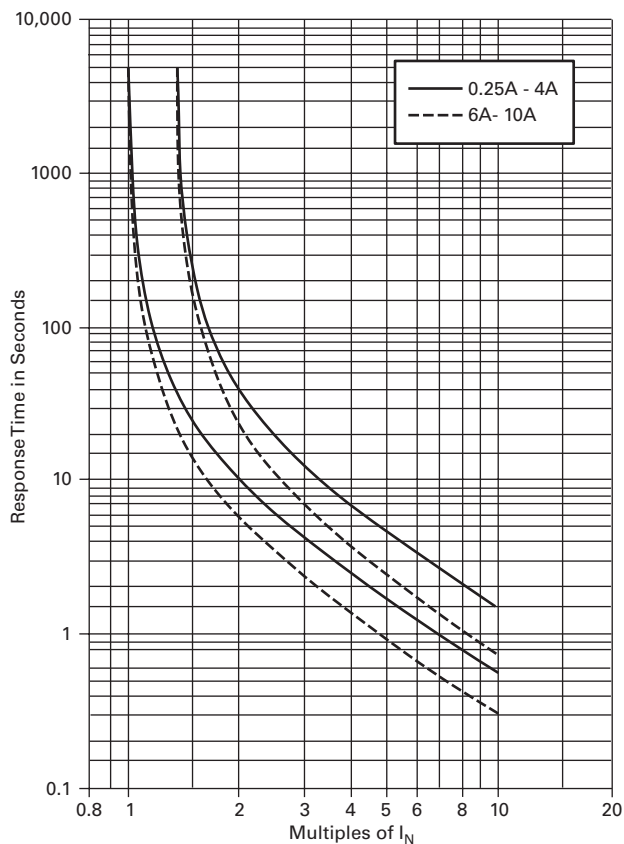

Note: When mounted in rows, the nominal current of the devices can only be transmitted at 80% or must be correspondingly over-dimensioned.

Temperature Factor

Ambient Temperature	Temperature Factor
-4°F (-20°C)	0.76
14°F (-10°C)	0.84
32°F (0°C)	0.91
73.4°F (23°C)	1.00
104°F (40°C)	1.08
122°F (50°C)	1.16
140°F (60°C)	1.24

Dimensions

Approximate Dimensions in Inches (mm)

XBUK6FSI with XBAT

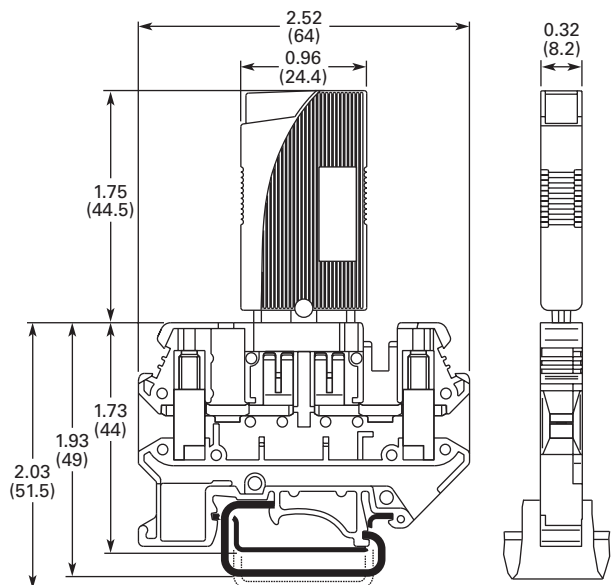

XBPT4FSI with XBAT

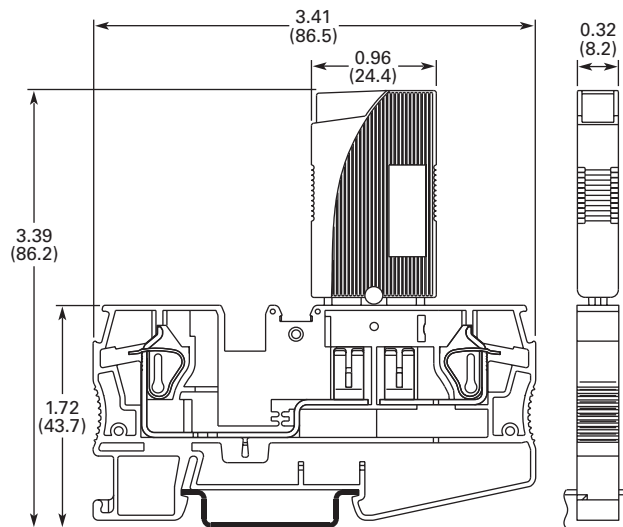

Flat-Type Fuse Terminal Blocks

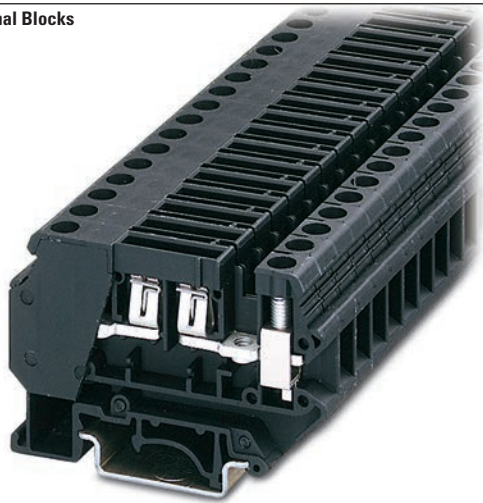

Contents

<i>Description</i>	<i>Page</i>
Circuit Breakers	T42-83
Flat-Type Fuse Terminal Blocks	
Accessories	T42-86
Technical Data and Specifications	T42-87
Dimensions	T42-87
Spring Cage Fuse Terminal Blocks	T42-88

Flat-Type Fuse Terminal Blocks

Product Description

The fuse terminal blocks can be used as a basic terminal blocks for the XBAT overload miniature circuit breaker, see **Page T42-83**.

Product Selection

XBUK6FSI

Screw Connection Flat-Type Fuse Terminal Blocks



Terminal Width	Maximum Wire Size	Connection Data in V/A/AWG	UL-cUL Ratings in V/A/AWG	Colour	Standard Pack	Catalogue Number
Flat-Type Fuse Terminal Block						
8.2 mm	8 AWG/6 mm ²	250/—/24–8	300/30/26–8	Black	50	XBUK6FSI
Flat-Type Fuse Terminal Block with LED, Red 12 Vdc, 2.0 mA						
8.2 mm	8 AWG/6 mm ²	250/—/24–8	300/30/26–8	Black	50	XBUK6FSIL12
Flat-Type Fuse Terminal Block with LED, Red 24 Vdc, 2.0 mA						
8.2 mm	8 AWG/6 mm ²	250/—/24–8	300/30/26–8	Black	50	XBUK6FSIL24

Accessories

Flat-Type Fuse Terminal Blocks

Description	Colour	Number of Positions	Standard Pack	XBUK6FSI Catalogue Number	XBUK6FSIL_ Catalogue Number
Blank marker strip	White	—	10	XBMZB8 ①	XBMZB8 ①

Note

① For information on Printed Marking Tag Options, see **Page T42-98**.

Technical Data and Specifications

Flat-Type Fuse Terminal Blocks

Description	XBUK6FSI	XBUK6FSIL ₂
Technical Data in Accordance with IEC		
Fuse type ISO	C	C
Maximum current with single arrangement in A	30	30
Maximum Power Dissipation		
Rated surge voltage in kV/contamination class	4/3	4/3
Surge voltage category/insulating material group	III/I	III/I
Connection Capacity		
Stranded with ferrule with plastic sleeve in mm ²	0.25–4	0.25–4
Stranded with ferrule without plastic sleeve in mm ²	0.25–6	0.25–6
Stranded with twin ferrule with plastic sleeve in mm ²	—	—
Multi-Conductor Connection (same cross-section)		
Solid/stranded in mm ²	0.2–2.5/0.2–2.5	0.2–2.5/0.2–2.5
Stranded with ferrules without plastic sleeve in mm ²	0.25–2.5	0.25–2.5
Stranded with twin ferrule with plastic sleeve in mm ²	0.5–4.0	0.5–4.0
Stripping length in inches (mm)	0.39 (10)	0.39 (10)
Thread	M4	M4
Torque in in-lb (Nm)	13.3–14.2 (1.5–1.6)	13.3–14.2 (1.5–1.6)

Dimensions

Approximate Dimensions in Inches (mm)

Flat-Type Fuse Terminal Blocks

Catalogue Number	Width	Length	Height for—		
			32 in	35 x 7.5 in	35 x 15 in
XBUK6FSI	0.32 (8.2)	2.91 (74.0)	2.24 (57.0)	2.05 (52.0)	2.34 (59.5)
XBUK6FSIL ₁₂	0.32 (8.2)	2.91 (74.0)	2.24 (57.0)	2.05 (52.0)	2.34 (59.5)
XBUK6FSIL ₂₄	0.32 (8.2)	2.91 (74.0)	2.24 (57.0)	2.05 (52.0)	2.34 (59.5)

Spring Cage Fuse Terminal Blocks

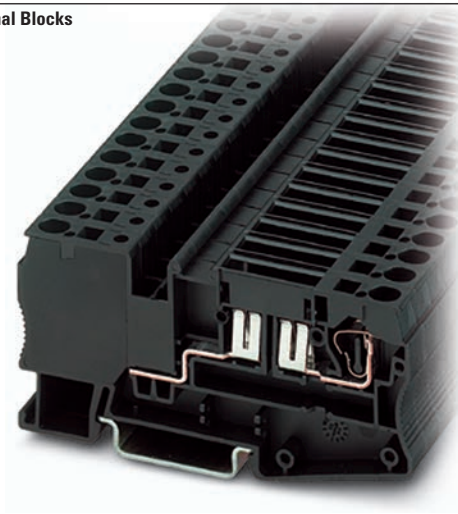

Contents

<i>Description</i>	<i>Page</i>
Circuit Breakers	T42-83
Flat-Type Fuse Terminal Blocks	T42-86
Spring Cage Fuse Terminal Blocks	
Accessories	T42-88
Technical Data and Specifications	T42-89
Dimensions	T42-89

Spring Cage Fuse Terminal Blocks

Product Description

Flat-type fuses or the XBAT miniature circuit breaker (see **Page T42-83**) can be used as the fuse element in these XBPT

Spring Cage Fuse Terminal Blocks. Terminal blocks with a light indicator are available for quick error diagnosis.

Product Selection

XBPT4FSI



Spring Cage Fuse Terminal Blocks

Terminal Width	Maximum Wire Size	Connection Data in V/A/AWG	UL-cUL Ratings in V/A/AWG	Colour	Standard Pack	Catalogue Number
Spring Cage Fuse Terminal Block						
8.2 mm	10 AWG/4 mm ²	400/30/28–10	300/30/24–10	Black	50	XBPT4FSI
Spring Cage Fuse Terminal Block with LED, Red 12 Vdc, 2.0 mA						
8.2 mm	10 AWG/4 mm ²	400/30/28–10	300/30/24–10	Black	50	XBPT4FSIL12
Spring Cage Fuse Terminal Block with LED, Red 24 Vdc, 2.0 mA						
8.2 mm	10 AWG/4 mm ²	400/30/28–10	300/30/24–10	Black	50	XBPT4FSIL24

Accessories

Flat-Type Fuse Terminal Blocks

Description	Colour	Number of Positions	Standard Pack	XBPT4FSI Catalogue Number	XBPT4FSIL_ Catalogue Number
Test adapter	—	—	10	XBATSPA14	XBATSPA14
2.3 mm diameter test plug	—	—	—	XBATSMPS-^①	XBATSMPS-^①
Modular test plug	—	—	10	XBATSPS8	XBATSPS8
Blank marker strip centre and external marking	White	—	10	XBZBF8^②	XBZBF8^②
Blank marker strip centre labeling (strip of 10)	White	—	10	XBZB8^②	XBZB8^②

Notes

- ① For ordering information, see **Page T42-105**
- ② For information on Printed Marking Tag Options, see **Page T42-98**.

Technical Data and Specifications

Flat-Type Fuse Terminal Blocks

Description	XBPT4FSI	XBPT4FSIL_
Technical Data in Accordance with IEC		
Fuse type ISO	C	C
Maximum current with single arrangement in A	30	30
Maximum Power Dissipation		
Rated surge voltage in kV/contamination class	6/3	6/3
Surge voltage category/insulating material group	III/1	III/1
Connection Capacity		
Stranded with ferrule with plastic sleeve in mm ²	0.25–4	0.25–4
Stranded with ferrule without plastic sleeve in mm ²	0.25–4	0.25–4
Stranded with twin ferrule with plastic sleeve in mm ²	0.5	0.5
Stripping length in inches (mm)	0.39 (10)	0.39 (10)

Dimensions

Approximate Dimensions in Inches (mm)

Flat-Type Fuse Terminal Blocks

Catalogue Number	Width	Length	Height for—	
			35 x 7.5 in	35 x 15 in
XBPT4FSI	0.32 (8.2)	3.41 (86.5)	1.71 (43.5)	2.01 (51.0)
XBPT4FSIL12	0.32 (8.2)	3.41 (86.5)	1.71 (43.5)	2.01 (51.0)
XBPT4FSIL24	0.32 (8.2)	3.41 (86.5)	1.71 (43.5)	2.01 (51.0)

XB Series Accessories

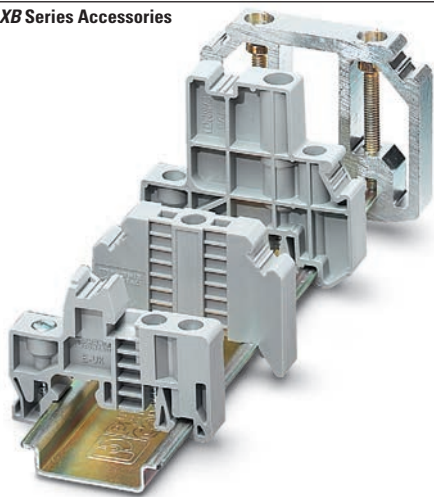

Contents

Description	Page
XB Series Accessories	
End Stops	T42-91
DIN Rails	T42-92
Angled Mounting Brackets	T42-93
Ferrules	T42-94
Hand Tools	T42-97
Marking Accessories	T42-98
Testing Accessories	T42-105
Separating Plates, Covers and Bridges	T42-105

XB Series Accessories Overview

End Stops

The end stop provides an anchor point at each end of the rail assembly by attaching directly to the DIN rail. A wide range of end stop options are available, including those that mount with one or multiple screws and those that do not require screws for mounting. End stops also have a location for marking material to be placed.

DIN Rail

Eaton offers ways for time-saving and secure mounting of components needed for electrical connections. DIN rail provides the basis for the inner design of the control cabinet and ensures a firm hold of the rail-mountable components. Eaton offers a wide range of standard DIN rails sizes and materials, solid or slotted. Or, contact us about custom lengths of pre-cut rail or ordering pre-drilled rail. The DIN rails are designed in accordance with the European standard EN 60715.

Angled Mounting Brackets

Angled mounting brackets are used to mount DIN rail at a more accessible angle for wiring and troubleshooting.

Ferrules

Ferrules are available with or without an insulating sleeve. The plastic insulating sleeve simplifies the fitting of the conductor and the colour indicates the size of the cross-section. The closer the connections are, the more reliable the insulation is and the less likely the wires are to splice. Twin ferrules are also available allowing two wires to be easily compressed in one ferrule. Chain bridging, frequently used in industry, becomes easier with twin ferrules.

Hand Tools

Eaton offers an array of hand tools to make it easier to work with our terminal blocks. The XBTCUTSTP tool is recommended for cutting and stripping PVC insulated wires. The ergonomically shaped crimping pliers, XBTCRMP66, result in fatigue-free work by spreading the manual force equally between the six jaws. The XBTDVR screwdrivers have a rotating cap that prevents user discomfort even at high torques and allows rapid rotation. The ergonomically shaped handle further aids the user's comfort. The blade is made from CVM steel, hardened and chrome-plated.

Marking Accessories

The marking system provides logical and clear identification of the modular terminal blocks and interface modules. The blank marker strip is designed for marking terminal blocks, equipment and smaller modules with marker grooves. The marker strip is available in all common pitches in printed and unprinted versions.

Testing Accessories

The range of test accessories available includes different test plugs, so that an optimum solution can be realized for every application. In addition to pre-assembled test plugs, plugs are also available that can be configured individually to form test adapters.

End Stops

Product Selection

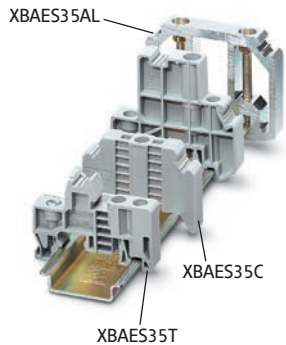

Snap-On End Stop (15 mm)

Standard Pack	Catalogue Number
50	XBAES15N

Snap-On End Stop (35 mm)

Standard Pack	Catalogue Number
50	XBAES35N

Snap-on end stops for 35 mm and 15 mm DIN rails can be fitted with blank marker strips and adjustable terminal strip markers, parking facility for bridges and testing accessories.

Universal End Stop (15 mm)

Standard Pack	Catalogue Number
50	XBAES15C

Universal End Stop (35 mm)

Standard Pack	Catalogue Number
50	XBAES35T
50	XBAES35C

Screwed on, labeling with blank marker strips and terminal strip markers.

Aluminum End

Standard Pack	Catalogue Number
10	XBAES35AL

Snaps on, for end support of 50–240 mm terminal blocks, labeling with XBMZB10.

Cross-Reference of Terminal Blocks Marking, End Stops

Catalogue Number	XBMKLM2	XBMGLMA	XBMUBE
XBAES35N	X	—	—
XBAES35T	—	X	X

Dimensions

Approximate Dimensions in Inches (mm)

Snap-On End Stop

XBAES35N

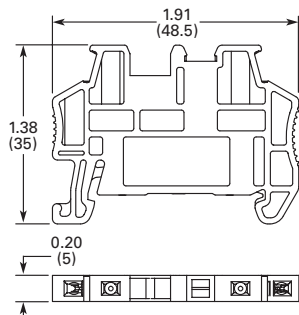

XBAES15N

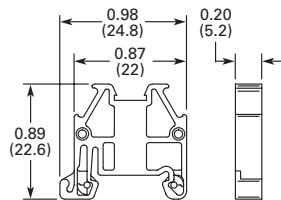

Aluminum End Stop

XBAES35AL

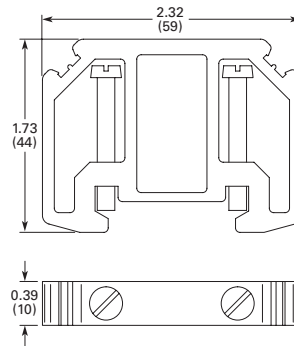

Universal End Stop

XBAES35T

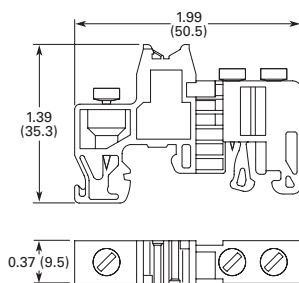

XBAES35C

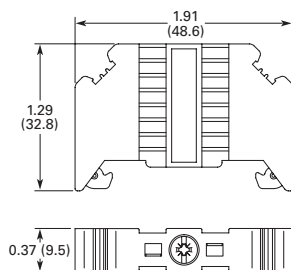

XBAES15C

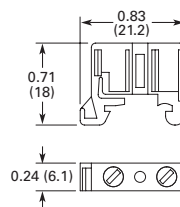

42.1

Terminal Blocks, Fuse Blocks and Fuse Holders

IEC—XB Series

DIN Rails

Product Selection



Perforated and unperforated DIN rails in accordance with E 60715.

Features

- High dimensional accuracy
- Restricted tolerances
- Double surface tempering, galvanized and chromated
- All 2m in length
- Customization available

35 x 7.5 mm x 2m

Standard Pack	Catalogue Number
Slotted	
25	XBANS3575P
Solid	
25	XBANS3575U

35 x 15 mm x 2m

Standard Pack	Catalogue Number
Slotted	
25	XBANS3515P
Solid	
25	XBANS3515U

15 x 5.5 mm x 2m

Standard Pack	Catalogue Number
25	XBANS15P

Aluminum DIN Rails (Perforated)

Standard Pack	Catalogue Number
35/7.5/2m	
25	XBANS3575PL
35/58/2m	
6	XBANS35PL

42

Dimensions

Approximate Dimensions in Inches (mm)

35 x 7.5 mm DIN Rail

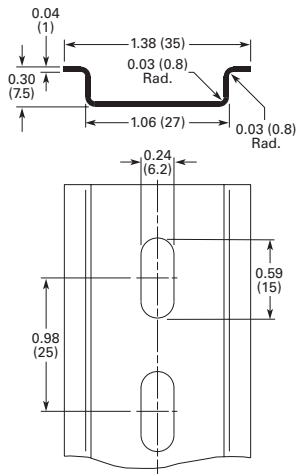

35 x 15 mm DIN Rail

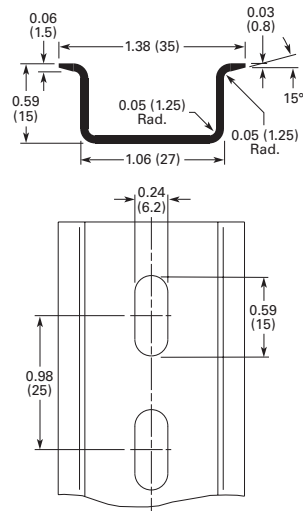

15 x 5.5 mm x 2m DIN Rail

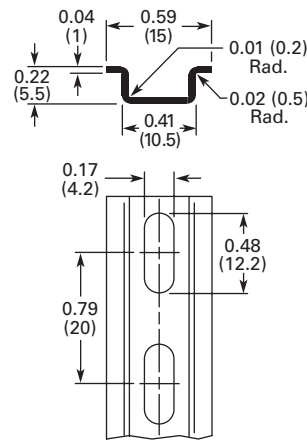

XBANS35PL Raised Rail

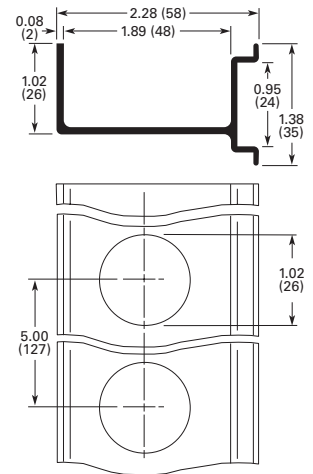

Angled Mounting Brackets

Product Selection



The angled brackets enable the DIN rail to be mounted with a spacing or at an angle of 30°.

Features

- For mounting DIN rail at 30° angle
- For use with M6 screw
- Chromated steel
- Provides better visibility

Angled Mounting Bracket

Standard Pack	Catalogue Number
Height Inches (mm) 1.39 (35.4)	
10	XBANBGS
Height Inches (mm) 1.81 (46)	
10	XBANBGSH

Dimensions

Approximate Dimensions in Inches (mm)

XBANBGS

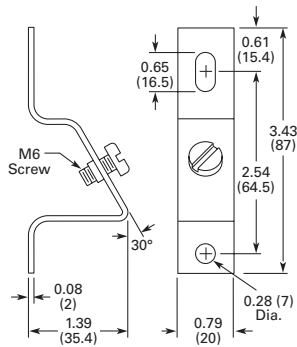

XBANBGSH

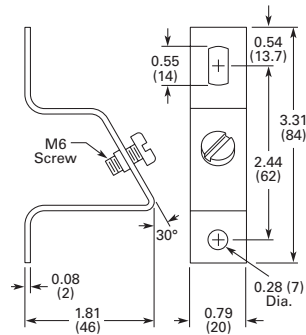

42.1

Terminal Blocks, Fuse Blocks and Fuse Holders

IEC—XB Series

Ferrules

Product Selection

Ferrules are offered in two basic designs—an insulated style available in models for wire sizes 20 through 4 AWG and a non-insulated type available in models for wire sizes 22 through 6 AWG.

Note: UL Ratings do not typically pertain to the use of Ferrules—Ferrules are covered under DIN VDE 0611.

42

Insulated

- Tube: soft electrolytic copper (E-CU), tin plated
- Plastic sleeve: polypropylene
 - Long-term temperature 105°C
 - Short-term temperature 120°C

XBAF1



Insulated Ferrules

Wire Size AWG (mm ²)	Colour ^①	Standard Pack ^②	Catalogue Number
20 (0.5)	White	100	XBAF1
18 (0.75)	Gray	100	XBAF3
18 (1)	Red	100	XBAF4
16 (1.5)	Black	100	XBAF6
14 (2.5)	Blue	100	XBAF9
14 (2.5)	Blue	100	XBAF10
12 (4)	Gray	100	XBAF11
12 (4)	Gray	100	XBAF12
10 (6)	Yellow	100	XBAF13
10 (6)	Yellow	100	XBAF14
8 (10)	Red	100	XBAF15
8 (10)	Red	100	XBAF16
6 (16)	Blue	100	XBAF17
6 (16)	Blue	100	XBAF18
4 (25)	Yellow	50	XBAF19

Non-Insulated

- Tube: soft electrolytic copper (E-CU), tin plated

XBAF20



Non-Insulated Ferrules

Wire Size AWG (mm ²)	Standard Pack ^②	Catalogue Number
20 (0.5)	100	XBAF20
18 (0.75)	100	XBAF21
18 (1)	100	XBAF23
16 (1.5)	100	XBAF24
14 (2.5)	100	XBAF25
12 (4)	100	XBAF26
10 (6)	100	XBAF27
8 (10)	100	XBAF28
6 (16)	100	XBAF29

Special Applications

The twin ferrules allow two conductors to be compressed practically in one ferrule.

The colored coding of the various cross sections corresponds to DIN 46 228-4.

XBAFT1



Non-Insulated Twin Ferrules

Wire Size AWG (mm ²)	Colour ^①	Standard Pack ^②	Catalogue Number
20 (0.5)	White	100	XBAFT1
18 (0.75)	Gray	100	XBAFT3
18 (1)	Red	100	XBAFT4
16 (1.5)	Black	100	XBAFT6
14 (2.5)	Blue	100	XBAFT9
12 (4)	Gray	100	XBAFT11
10 (6)	Yellow	100	XBAFT13
8 (10)	Red	100	XBAFT15
6 (16)	Blue	50	XBAFT18

Notes

- ① The colored coding of the various cross-sections corresponds to DIN 46 228-4.
- ② Standard pack is the number of ferrules that come in each bag. Must order in multiples of standard pack.
Example: XBAF1—an order for 200 pieces will receive 2 bags of ferrules, each with 100 pieces.

Dimensions

Approximate Dimensions in Inches (mm)

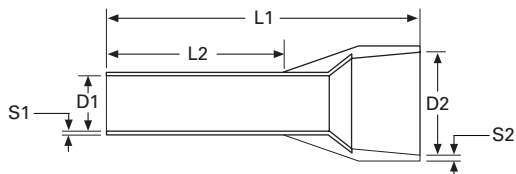
Ferrules with Insulating Collar

Catalogue Number	Approximate Dimensions					
	D1	D2	L1	L2	S1	S2
XBAF1	0.04 (1.1)	0.10 (2.5)	0.55 (14.0)	0.31 (8.0)	0.006 (0.15)	0.010 (0.25)
XBAF3	0.05 (1.3)	0.11 (2.8)	0.55 (14.0)	0.31 (8.0)	0.006 (0.15)	0.010 (0.25)
XBAF4	0.06 (1.5)	0.12 (3.0)	0.55 (14.0)	0.31 (8.0)	0.006 (0.15)	0.012 (0.30)
XBAF6	0.07 (1.8)	0.13 (3.4)	0.55 (14.0)	0.31 (8.0)	0.006 (0.15)	0.012 (0.30)
XBAF9	0.09 (2.3)	0.17 (4.2)	0.55 (14.0)	0.31 (8.0)	0.006 (0.15)	0.012 (0.30)
XBAF10	0.09 (2.3)	0.17 (4.2)	0.94 (24.0)	0.71 (18.0)	0.006 (0.15)	0.012 (0.30)
XBAF11	0.11 (2.8)	0.19 (4.8)	0.67 (17.0)	0.39 (10.0)	0.008 (0.20)	0.012 (0.30)
XBAF12	0.11 (2.8)	0.19 (4.8)	1.02 (26.0)	0.71 (18.0)	0.008 (0.20)	0.012 (0.30)
XBAF13	0.14 (3.5)	0.24 (6.2)	0.79 (20.0)	0.47 (12.0)	0.008 (0.20)	0.012 (0.30)
XBAF14	0.14 (3.5)	0.24 (6.2)	1.02 (26.0)	0.71 (18.0)	0.008 (0.20)	0.012 (0.30)
XBAF15	0.18 (4.6)	0.30 (7.5)	0.87 (22.0)	0.47 (12.0)	0.008 (0.20)	0.012 (0.30)
XBAF16	0.18 (4.6)	0.30 (7.5)	1.10 (28.0)	0.71 (18.0)	0.008 (0.20)	0.012 (0.30)
XBAF17	0.23 (5.8)	0.35 (8.8)	0.94 (24.0)	0.47 (12.0)	0.008 (0.20)	0.016 (0.40)
XBAF18	0.23 (5.8)	0.35 (8.8)	1.10 (28.0)	0.71 (18.0)	0.008 (0.20)	0.016 (0.40)
XBAF19	0.29 (7.3)	0.43 (11.0)	1.26 (32.0)	0.71 (18.0)	0.008 (0.20)	0.020 (0.50)

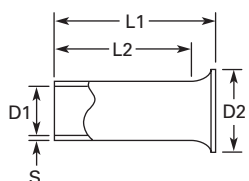
Ferrules without Insulating Collar

Catalogue Number	Approximate Dimensions				
	D1	D2	L1	L2	S
XBAF20	0.04 (1.0)	0.08 (2.1)	0.24 (6.0)	0.21 (5.3)	0.006 (0.15)
XBAF21	0.05 (1.2)	0.09 (2.3)	0.24 (6.0)	0.21 (5.3)	0.006 (0.15)
XBAF23	0.06 (1.4)	0.10 (2.5)	0.24 (6.0)	0.21 (5.3)	0.006 (0.15)
XBAF24	0.07 (1.7)	0.11 (2.8)	0.28 (7.0)	0.24 (6.0)	0.006 (0.15)
XBAF25	0.09 (2.2)	0.13 (3.4)	0.28 (7.0)	0.24 (6.0)	0.006 (0.15)
XBAF26	0.11 (2.8)	0.16 (4.0)	0.35 (9.0)	0.31 (8.0)	0.008 (0.20)
XBAF27	0.14 (3.5)	0.19 (4.7)	0.47 (12.0)	0.35 (9.0)	0.008 (0.20)
XBAF28	0.18 (4.5)	0.23 (5.8)	0.47 (12.0)	0.43 (10.8)	0.008 (0.20)
XBAF29	0.23 (5.8)	0.30 (7.5)	0.47 (12.0)	0.41 (10.5)	0.008 (0.20)

42.1

Terminal Blocks, Fuse Blocks and Fuse Holders

IEC—XB Series

Approximate Dimensions in Inches (mm)

Twin Ferrules

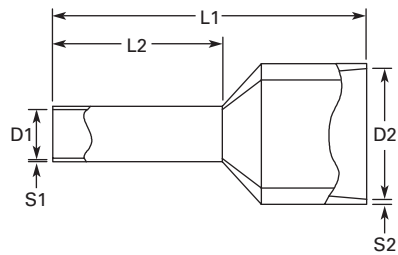

42

Catalogue Number	Approximate Dimensions		L1	L2	S1	S2
	D1	D2				
XBAFT1	0.06 (1.5)	0.10 (2.5)	0.59 (15.0)	0.31 (8.0)	0.006 (0.15)	0.010 (0.25)
XBAFT3	0.07 (1.8)	0.11 (2.8)	0.59 (15.0)	0.31 (8.0)	0.006 (0.15)	0.010 (0.25)
XBAFT4	0.08 (2.1)	0.13 (3.4)	0.59 (15.0)	0.31 (8.0)	0.006 (0.15)	0.012 (0.30)
XBAFT6	0.09 (2.3)	0.14 (3.6)	0.63 (16.0)	0.31 (8.0)	0.006 (0.15)	0.012 (0.30)
XBAFT9	0.11 (2.9)	0.17 (4.2)	0.73 (18.5)	0.39 (10.0)	0.008 (0.20)	0.012 (0.30)
XBAFT11	0.15 (3.8)	0.19 (4.9)	0.91 (23.0)	0.47 (12.0)	0.008 (0.20)	0.012 (0.30)
XBAFT13	0.19 (4.9)	0.23 (5.9)	0.98 (25.0)	0.55 (14.0)	0.008 (0.20)	0.016 (0.40)
XBAFT15	0.26 (6.5)	0.28 (7.2)	1.02 (26.0)	0.55 (14.0)	0.008 (0.20)	0.016 (0.40)
XBAFT18	0.33 (8.5)	0.35 (8.8)	1.22 (31.0)	0.63 (16.0)	0.008 (0.20)	0.020 (0.50)

Hand Tools**Stripping Tools****Product Selection****Stripping Tools**

Standard Pack	Catalogue Number
1	XBTCUTSTP

Technical Data and Specifications**Conductor/Cable Stripping Range**

Description	Specification
Conductor/cable	0.2–6 mm ² /24–10 AWG
Wire cutter	6 mm ² /10 AWG

Crimping Pliers

The crimping pliers deform the ferrules hexagonally. For 0.25–6 mm² ferrules in accordance with DIN 46 228-1: 1992-08 and DIN 46 228-4: 1990-09.

Product Selection**Crimping Pliers**

Standard Pack	Catalogue Number
1	XBTCRMP66

Technical Data and Specifications**Areas of Application**

Description	Specification
Conductor	0.25–6 mm ²
Conductor	23–10 AWG

Slotted Screwdrivers**Product Selection****Slotted Screwdrivers**

Standard Pack	Catalogue Number
3.5 mm	
1	XBTDVR35
4.0 mm	
1	XBTDVR40

Dimensions

Approximate Dimensions in Inches (mm)

Stripping Tools

Length	Stripping Length	Weight In lbs (g)
8.07 (205)	Up to 18 mm	0.44 (200)

Dimensions

Approximate Dimensions in Inches (mm)

Crimping Pliers

Length	Weight In lbs (g)
6.85 (175)	0.79 (360)

Marking Accessories

Printed Marking Tag Options

Horizontally Printed Marking Tags and Marking Directions

1	2	3	4	5	6	7	8	9	10
---	---	---	---	---	---	---	---	---	----

Marking Direction: Horizontal

1	2	3	4	5	6	7	8	9	10
---	---	---	---	---	---	---	---	---	----

Marking Direction: Vertical

42

Marking Tags for 5.2 mm Wide Terminal Blocks

Standard Pack	Number Sequence	Catalogue Number
ZB5 Tags Vertically Numbered		
10	1–10 ①	XBMZB5V/1
10	11–20	XBMZB5V/11
10	21–30	XBMZB5V/21
10	31–40	XBMZB5V/31
10	41–50	XBMZB5V/41
10	51–60	XBMZB5V/51
10	61–70	XBMZB5V/61
10	71–80	XBMZB5V/71
10	81–90	XBMZB5V/81
10	91–100	XBMZB5V/91
ZBF5 Tags Vertically Numbered		
10	1–10 ①	XBMZBF5V/1
10	11–20	XBMZBF5V/11
10	21–30	XBMZBF5V/21
10	31–40	XBMZBF5V/31
10	41–50	XBMZBF5V/41
10	51–60	XBMZBF5V/51
10	61–70	XBMZBF5V/61
10	71–80	XBMZBF5V/71
10	81–90	XBMZBF5V/81
10	91–100	XBMZBF5V/91

Marking Tags for 6.2 mm Wide Terminal Blocks

Standard Pack	Number Sequence	Catalogue Number
ZB6 Tags Vertically Numbered		
10	1–10 ①	XBMZB6V/1
10	11–20	XBMZB6V/11
10	21–30	XBMZB6V/21
10	31–40	XBMZB6V/31
10	41–50	XBMZB6V/41
10	51–60	XBMZB6V/51
10	61–70	XBMZB6V/61
10	71–80	XBMZB6V/71
10	81–90	XBMZB6V/81
10	91–100	XBMZB6V/91
ZBF6 Tags Vertically Numbered		
10	1–10 ①	XBMZBF6V/1
10	11–20	XBMZBF6V/11
10	21–30	XBMZBF6V/21
10	31–40	XBMZBF6V/31
10	41–50	XBMZBF6V/41
10	51–60	XBMZBF6V/51
10	61–70	XBMZBF6V/61
10	71–80	XBMZBF6V/71
10	81–90	XBMZBF6V/81
10	91–100	XBMZBF6V/91

Note

① For text printed horizontally, change “V” in catalogue number to “H.”

Marking Tags for 8.2 mm Wide Terminal Blocks

Standard Pack	Number Sequence	Catalogue Number
ZB8 Tags Vertically Numbered		
10	1–10 ①	XBMZB8V/1
10	11–20	XBMZB8V/11
10	21–30	XBMZB8V/21
10	31–40	XBMZB8V/31
10	41–50	XBMZB8V/41
10	51–60	XBMZB6V/51
10	61–70	XBMZB8V/61
10	71–80	XBMZB8V/71
10	81–90	XBMZB8V/81
10	91–100	XBMZB8V/91
ZBF8 Tags Vertically Numbered		
10	1–10 ①	XBMZBF8V/1
10	11–20	XBMZBF8V/11
10	21–30	XBMZBF8V/21
10	31–40	XBMZBF8V/31
10	41–50	XBMZBF8V/41
10	51–60	XBMZBF8V/51
10	61–70	XBMZBF8V/61
10	71–80	XBMZBF8V/71
10	81–90	XBMZBF8V/81
10	91–100	XBMZBF8V/91

Marking Tags for 10.2 mm Wide Terminal Blocks

Standard Pack	Number Sequence	Catalogue Number
ZB10 Tags Vertically Numbered		
10	1–10 ①	XBMZB10V/1
10	11–20	XBMZB10V/11
10	21–30	XBMZB10V/21
ZBF10 Tags Vertically Numbered		
10	1–10 ①	XBMZBF10V/1
10	11–20	XBMZBF10V/11
10	21–30	XBMZBF10V/21

Marking Tags for 12 mm Wide Terminal Blocks

Standard Pack	Number Sequence	Catalogue Number
ZB12 Tags Vertically Numbered		
10	1–10 ①	XBMZB12V/1
10	11–20	XBMZB12V/11
10	21–30	XBMZB12V/21
ZBF12 Tags Vertically Numbered		
10	1–10 ①	XBMZBF12V/1
10	11–20	XBMZBF12V/11
10	21–30	XBMZBF12V/21

Marking Tags for 16 mm Wide Terminal Blocks

Standard Pack	Number Sequence	Catalogue Number
ZB15 Tags Vertically Numbered		
10	1–10 ①	XBMZB15V/1
10	11–20	XBMZB15V/11
10	21–30	XBMZB15V/21
ZBF15 Tags Vertically Numbered		
10	1–10 ①	XBMZBF15V/1
10	11–20	XBMZBF15V/11
10	21–30	XBMZBF15V/21

Note

① For text printed horizontally, change “V” in catalogue number to “H.”

Pre-Printed Marking Tags**Terminal Blocks Marking Tags**

The tags are made of white self-extinguishing polyamide 6.6 and the imprint is hot stamped with rubproof black ink.

- White marking strip available preprinted. Strip covers 10 terminals. Marking 1 – 10, 11–20, up to 991–999. Contact Eaton for more options.
- XBMZB5 or XBMZBF5 for terminal blocks 5.2 mm wide
- XBMZB6 or XBMZBF6 for terminal blocks 6.2 mm wide
- XBMZB8 or XBMZBF8 for terminal blocks 8.2 mm wide
- XBMZB10 or XBMZBF10 for terminal blocks 10.2 mm wide
- XBMZB12 or XBMZBF12 for terminal blocks 12 mm wide
- XBMZB15 or XBMZBF15 for terminal blocks 16 mm wide

Marking Tag Sizes

Note: Marking Tag Sizes are for all catalogue numbers starting with given prefix, EXCEPT FUSE TERMINAL Blocks.

Proper Marking Tag Size

XBMZB5	XBMZBF5	XBMZB6	XBMZBF6	XBMZB8	XBMZBF8	XBMZB10	XBMZBF10	XBMZB12	XBMZBF12	XBMZB15	XBMZBF15	XBMSSZB
XBUT25	XBPT25 ^②	XBUT4	XBPT4 ^②	XBUT6	XBPT6 ^②	XBUT10	XBPT10 ^②	XBPT16 ^①	XBPT16 ^②	XBUT35	XBPT35 ^②	XBMKLMZ
XBUT4FBE ^①	XBPTT25	XBUTT4	XBPTT4	XBPT6 ^①	XBPT4FBN ^②	XBUT16	—	—	—	XBPT35 ^①	—	—
XBUT6FBN ^①	XBPTK	XB3UKA	XBPT4FBE ^②	XBUK6	XBPT4FSI ^②	XBTK	—	—	—	—	—	—
XBPT25 ^①	XBPU25 ^②	XB3UKF	XBQT25 ^③	XBPT4FSI ^①	—	XBUK50	—	—	—	—	—	—
XBPT4FBE ^①	XBAP ...	XBUT4FBE ^②	XBQT25FBE ^③	—	—	XBUK150	—	—	—	—	—	—
XBPU25 ^①	XBQT15 ^③	XBUT6FBN ^②	XBQU25 ^⑤	—	—	XBUK95	—	—	—	—	—	—
XBQT15 ^①	XBQT15	XBUK10	—	—	—	XBPT10 ^①	—	—	—	—	—	—
XBQT25FBE ^④	XBQU15 ^③	XBUK4	—	—	—	XBMKLMZ ^⑤	—	—	—	—	—	—
XBQU15 ^①	XBMPK15	XBPT4 ^①	—	—	—	—	—	—	—	—	—	—
XBMUK25	XBMPK15	XBPT4FBN ^①	—	—	—	—	—	—	—	—	—	—
—	XBATCP...	XBQT25 ^①	—	—	—	—	—	—	—	—	—	—
—	—	XBQT25FBE ^①	—	—	—	—	—	—	—	—	—	—
—	—	XBQU25 ^①	—	—	—	—	—	—	—	—	—	—
—	—	XBMUK4	—	—	—	—	—	—	—	—	—	—

Notes

- ① For centre labeling.
- ② For external labeling.
- ③ For centre and outside labeling.
- ④ For lever labeling.
- ⑤ Two (2) XBMZB10 tags fit in one (1) XBMKLMZ.

Marker Strips and Sheets (for use with XBAPLT2006K1 plotter)

The **XB** Series marking system provides logical and clear identification of the modular terminal blocks and interface modules.

Product Selection**XBMZB_****Marker Strips (Strip of 10)**

Terminal Width	Standard Pack	Catalogue Number
Blank Strips		
5.2 mm	10	XBMZB5
6.2 mm	10	XBMZB6
8.2 mm	10	XBMZB8
10.2 mm	10	XBMZB10
12 mm	10	XBMZB12
16 mm	10	XBMZB15 ①
Flat Strips		
5.2 mm	10	XBMZBF5
6.2 mm	10	XBMZBF6
8.2 mm	10	XBMZBF8
10.2 mm	10	XBMZBF10
12 mm	10	XBMZBF12
16 mm	10	XBMZBF15

Marker Sheets (Strip of 10)

Terminal Width)	Colour	Std. Pack	Catalogue Number
XBMPZB_			
Marker Sheets (10 rows of 12)			
5.2 mm	White	50	XBMPZB5
	Blue	50	XBMPZB5BU
	Red	50	XBMPZB5RD
	Yellow	50	XBMPZB5YE
	Green	50	XBMPZB5GN
Marker Sheets (10 rows of 10)			
6.2 mm	White	50	XBMPZB6
	Blue	50	XBMPZB6BU
	Red	50	XBMPZB6RD
	Yellow	50	XBMPZB6YE
	Green	50	XBMPZB6GN
Flat Marker Sheets (10 rows of 10)			
5.2 mm	White	10	XBMPZBF5
	Orange	10	XBMPZBF5OG
	White	10	XBMPZBF6
	Orange	10	XBMPZBF6OG
	White	10	XBMPZBF8

XBMPZB_**XBMPZBF_****Label Sheets for Laser Printers**

The XBM labels have been specially developed for laser printers and have considerable advantages:

- Can be printed on all commercially available laser printers
- Or can use plotter or pen for printing
- Good adhesive properties
- A4 size
- XBMKL25X12WH designed to fit XGBS2512 group marker
- XBMLMAL447 is perforated for terminal strip marker XBMGLMA and is 44 x 7 mm

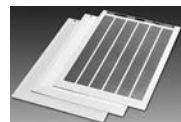
Product Selection**XBM_****Label Sheets**

Standard Pack	Catalogue Number
10	XBMKL25X12WH
10	XBMLMAL447

Note

① All markers are strips of 10, except XBMZB15, which is a strip of 5.

42.1

Terminal Blocks, Fuse Blocks and Fuse Holders

IEC—XB Series

Terminal Block Group Marking

Terminal block groups are marked using marking labels that are snapped into the marker strip groove of the terminal blocks. The group is marked using either labels or insert markers.

Product Selection

XGBS2512



Terminal Block Group Marking ^①

Standard Pack	Catalogue Number
100	XGBS2512

Insert Markers for Laser Printers

One sheet = 56 labels. Lettering field is 40 x 17 mm.

Product Selection

XBMUBEL4017



Insert Markers for XBMUBE(D)

Standard Pack	Catalogue Number
10	XBMUBEL4017

42

Terminal Strip Markers

Adjustable height for end bracket labeling.

Product Selection

XBM_



Terminal Strip Markers ^①

Standard Pack	Catalogue Number
20 x 8 mm Wide	
10	XBMKLM2
44 x 7 mm Wide	
10	XBMGLMA

Refillable Marker Pen

Refillable marker pen for manual labeling, line thickness 0.35 mm.

Product Selection

XBMXPEN



Terminal Strip Markers ^①

Standard Pack	Catalogue Number
Pen	
1	XBMXPEN
Ink Cartridge	
1	XBMINK

Terminal Strip Marker Carriers

For labeling terminal groups, for mounting on DIN rail. Lettering field is 40 x 17 mm.

Product Selection

XBMUB_



Terminal Strip Marker Carriers

Standard Pack	Catalogue Number
10	XBMUBE
10	XBMUBED

Non-Refillable Marker Pen

For manual labeling, line thickness 0.5 mm.

Product Selection

XBMUBE



Non-Refillable Marker Pen

Standard Pack	Catalogue Number
1	XBMBSTIFT

Note

^① See Page T42-101 for insert labels.

Marking Plotter

The automatic Prepare Pen function ensures optimum marking results right from the first character.

Custom Marking Tag System

This plotter system uses Windows®-based software to interface with a PC, allowing custom printing on standard terminal blocks marking tags. These standard marking tags provide circuit identification for Eaton DIN rail mount terminal blocks.

Pens can remain in the pen station even for prolonged intervals without drying out.

Features

- Enter tag text directly into EMARK software program or import file from AutoCAD or Excel®
- Selectable font sizes, types and colors including common symbols for circuit identification (ground, ~ etc.)
- Various text formatting options including copy, paste, increment functions, text alignment, etc.
- Durable templates allow printing of four different tag sizes at the same time
- Automatic prepare pen function for optimum results

Technical Data and Specifications**Marking Plotter**

Description	Specification
Plotter	
Plotter type	Flatbed plotter
Maximum plotting surface	440 mm x 296 mm
Maximum material height	10.5 mm
Maximum plotting speed	40 cm/sec
Pen station	Four depots with double sealing
Drive	Two-phase impulse-driven motor
Interfaces	Parallel (Centronics)/USB Level 1.1
Electronics	
Command language	Based on HP-GL 7475A
Data buffer	16 MB
Addressable resolution	0.01 mm
Repeat accuracy	0.05 mm
Repeat accuracy on pen change	0.05 mm with optimum pen
Power Supply	
Power supply	Via separate power supply unit with exchangeable mains feeder cable
Power supply unit input voltage	100–240 Vac/50–60 Hz
Power supply unit input current (maximum)	0.3A at 230V~
Power supply unit output voltage	24 Vdc
Power supply unit output current (maximum)	1.4A
Environmental conditions	
Operation	50° to 95°F (10° to 35°C) 35% to 75% relative humidity
Storage	14° to 122°F (–10° to 50°C) 10% to 90% relative humidity

Dimensions

Approximate Dimensions in Inches (mm)

Marking Plotter

L	W	H	Approx. Weight In Lbs (kg)
25.98 (660)	17.32 (440)	4.92 (125)	18 (8)

Marking Plotter

Description	Standard Pack	Catalogue Number
Plotter kit ^①	1	XBAPLT2006K1
Pen station sealing set	1	XBMP1PENDEPOT
Plotter pen preparation plate	1	XBMP1PREPLATES
Template for marker strips	1	XBMP1MZB
Template for flat marker strips	1	XBMP1MZBF
Template for XBMPZB marker sheets	1	XBMP1MPZB
Template for XBMPZBF marker sheets	1	XBMP1MPZBF
Template for Weidmuller multiscard sheet	1	XBMP1MCSF46
Template for Weidmuller multiscard sheet universal	1	XBMP1MCU
Template for Entrelec sheets	1	XBMP1MRC
0.25 mm disposal pen	1	XBMDPEN25R
0.35 mm disposal pen	1	XBMDPEN35R
0.25 mm pen	1	XBMPEN25
0.35 mm pen	1	XBMPEN35
Ink Cartridge	2	XBMINK
Pen cleaning set	1	XBMRSET
Cleaning cartridges	2	XBMRMEKFC2

EMARK Software

Eaton's EMARK software makes labeling your terminal blocks quick and simple. You can import your data from ECHART, any other CAD/CAE program, or enter text directly into EMARK. The software allows marking tags to be printed on the PLT2006 plotter in a professional manner.

Note

^① Plotter kit includes PLT2006 plotter system with EMARK software and user manual, starter ink and cleaning sets, and templates for marking all XBMZB and XBMZBF tags.

Testing Accessories

Test Adapter

For 4 mm diameter test plug and 4 mm diameter safety test plug. Makes contact in the bridge shaft.

Product Selection

XBATSPA14



Test Adapter

Standard Pack	Catalogue Number
1	XBATSPA14

Modular Test Plugs

For individual assembly of test plug strips.

Product Selection

XBATS_

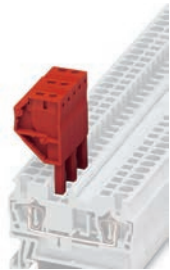

Modular Test Plugs

Standard Pack	Catalogue Number
Test Plugs	
10	XBATSPS5
10	XBATSPS6
10	XBATSPS8
Spacer Plate	
10	XBATSDPPS5
10	XBATSDPPS6
10	XBATSDPPS8

Test Plugs

Consisting of metal part for socket hole and insulating sleeve.

Product Selection

Test Plugs

Standard Pack		Catalogue Number
2.3 mm		
10	—	XBATSMPSMT
10	Blue	XBATSMPSIHBU
10	White	XBATSMPSIHHW
10	Red	XBATSMPSIHRD
10	Black	XBATSMPSIHBK
4 mm		
10	—	XBATSPSMT
10	Blue	XBATSPSIHBU
10	White	XBATSPSIHHW
10	Red	XBATSPSIHRD
10	Black	XBATSPSIHBK

XBATSMP_



XBATSMP_



Separating Plates, Covers and Bridges

End Cover

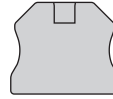

Used to cover an open end of terminal block when changing sizes within an assembly and/or for last terminal block in a row.

Partition Plate

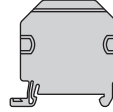

Protrudes over the terminal block and is used to increase electrical clearance between terminals. Also provides visual indications of the functions of terminal blocks. For example, terminal blocks between two partition plates may provide an exact location for test points.

End Cover Segment



Covers protruding terminal block segments of three- and four-wire terminal blocks when next to a two-wire blocks. This ensures that all is touch-proof and saves space over using a standard end cover.

Jumper/Bridge

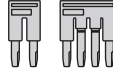

Provides the ability to electrically connect terminal blocks. Non-adjacent blocks may be bridged by snapping off the contact tabs of the standard bridge. The reducing bridge permits simple connection of terminal blocks with different nominal cross-sections.

Note

See these accessories as listed with terminal blocks for more information.

42.2

Terminal Blocks, Fuse Blocks and Fuse Holders

NEMA

NEMA



Contents

Description

Page

NEMA

C381 Series Terminal Blocks, Rail Mounted	T42-107
TB Series Terminal Blocks, Modular	T42-111

42



NEMA Overview

Product Description

NEMA terminal blocks provide a panel or DIN rail mount block that can be assembled from modular pieces. These blocks accommodate wire from 22 to 1/0 AWG and up to 175A and 600V.

Standards and Certifications

- UL File #E67464 and #E56797

C381 Series Terminal Blocks, Rail Mounted



Contents

Description	Page
C381 Series Terminal Blocks, Rail Mounted	
Product Selection	T42-108
Accessories	T42-109
Modifications	T42-109
Technical Data and Specifications	T42-110
Dimensions	T42-110
TB Series Terminal Blocks, Modular	T42-111

C381 Series Terminal Blocks, Rail Mounted

Product Description

- 600V
- Snap-fit nylon sections
 - Control circuit blocks
 - Power circuit blocks
 - Fuse blocks
 - Switch blocks
- Sections can be interlocked in any quantity and any mixture for direct panel mounting or channel mounting
- Three terminal choices in control circuit blocks, up to 32 circuits per foot
- Power circuit blocks for heavy-duty applications, up to 16 circuits per foot
- Fuse blocks accommodate any 0.406 x 1.5 in (10.3 x 38.1 mm) ferrule type cartridge fuse up to 30A
- Switch blocks have removable blade for extra safety

Standards and Certifications

- UL File #E67464



A Typical Mixture of Control Circuit Blocks, Power Blocks, Switch and Fuse Blocks in a Mounting Channel

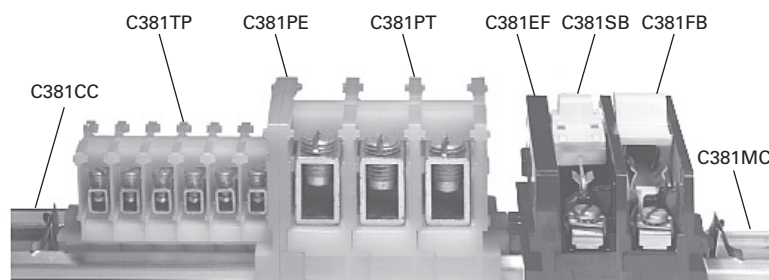

42.2

Terminal Blocks, Fuse Blocks and Fuse Holders

NEMA

Product Selection

When Ordering Specify

Catalogue number and quantity, which must be in a multiple of the available minimum standard package.

Examples:









- 200 Cat. No. C381ST
- 20 Cat. No. C381PT
- 100 Cat. No. C381CC

Catalogue number and quantity of end sections also in minimum quantity standard package.

Example:

- 25 Cat. No. C381ES.

Control, Power, Switch and Fuse Blocks ^①

	Description	AWG Wire Size	Standard Pack ^②	Catalogue Number
Control Circuit Terminal Blocks—Rated 50A				
	C381ST Type ST (screw terminal)	22–14 AWG	100	C381ST
	C381TP Type TP (tubular pressure plt)	22–10	100	C381TP
	C381TS Type TS (tubular screw) end section	18–8	100	C381TS
	C381ES End section	—	25	C381ES
Power Circuit Terminal Blocks—Rated 155A				
	C381PT Type PT (tubular screw)	10–1/0	10	C381PT
	C381PE End section	—	10	C381PE
Switch Blocks—Rated 15A and Fuse Blocks—Rated 30A				
	C381SB Switch blocks	18–8	10	C381SB
	C381FB Fuse blocks	18–8	10	C381FB
	C381EF End section	—	10	C381EF

Notes

- ① Available only in minimum quantity standard packages.
- ② Must be ordered in standard package quantity or in multiples of these quantities.

Accessories

C381 Series Terminal Blocks, Rail Mounted ^①

Description	Standard Pack ^②	Catalogue Number
Aluminum mounting channel—6 ft (1.8m) lengths	25	C381MC
Screw type channel clamp (one required each end) ^③	100	C381VC
Spring type channel clamp (one required each end) ^③	100	C381CC
Vinyl marking strip—3/8 in x 25 ft (9.5 mm x 7.6m) coil	1	C381MS
Marking paper—pressure sensitive—5/16 x 11-11/16 in (7.9 x 296.9 mm), 24 strips/sheet	5 sheets	C381MP
Marking strip retainer (one required/grouping)		
For use on control circuit blocks	100	C381SR
For use on power circuit blocks	100	C381SP
Fanning strip—for type TP and/or TS	50	C381TF
Fanning strip—for type ST	50	C381SF
Terminal jumper (two-pole) ^④	100	C381TJ
Ganging rod—1/8 in x 6 in (3.2 mm x 152.4 mm) ^⑤	10	C381GR

Modifications

Pull Apart Terminal Blocks ^①

Description	AWG Wire Size	Standard Pack ^②	Catalogue Number
One-pole stationary section (tubular pressure plt)	22–10	100	C381PS
Three-pole movable section (tubular pressure plt)	22–10	12	C381PM
End section	—	25	C381ES
Polarizing plug (promotes alignment of poles) ^⑥	—	100	C381PP

Pull Apart Terminal Blocks

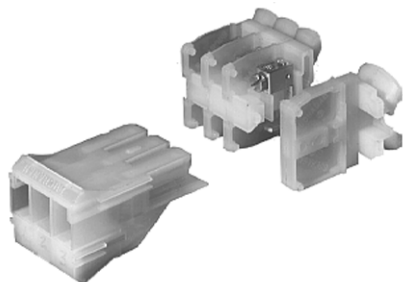

Illustrates: One–Three-Pole Movable Section, Three–One-Pole Stationary Sections and One–End Piece

Notes

- ① Available only in minimum quantity standard packages.
- ② Must be ordered in standard package quantity or in multiples of these quantities.
- ③ C381CC is a snap-in, one time use disposable type. C381VC can be readjusted or reused as desired.
- ④ For use on adjacent Type TP and/or TS control circuit sections.
- ⑤ May be used on section covers or to gang fuse and/or switch blocks.
- ⑥ L shaped plug installs in end of stationary section, Catalogue Number C381PS, and prevents incorrect installation of movable section, Catalogue Number C381PM.

Technical Data and Specifications

Formulas for Calculating Blocks and Channel Lengths

N = Number of Blocks

C381 Series Terminal Blocks, Rail Mounted

Description	Blocks Length
Control blocks and pull apart blocks	$0.762 + (0.375 \times N)$
Power circuit blocks	$0.812 + (0.750 \times N)$
Fuse and switch blocks	$0.812 + (0.755 \times N)$
Mounting channel (minimum channel length)	$0.75 + \text{blocks length}$

42

Dimensions

Approximate Dimensions in Inches (mm)

C381 Series Terminal Blocks, Rail Mounted

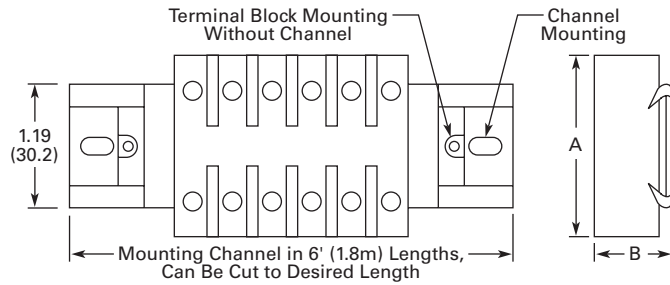

Block	A	B
Control circuit blocks	1.25 (31.8)	1.55 (39.4)
Power circuit blocks	1.75 (44.5)	2.00 (50.8)
Fuse blocks	2.75 (69.9)	2.00 (50.8)
Switch blocks	2.75 (69.9)	2.00 (50.8)
Pull apart blocks	1.88 (47.8)	2.75 (69.9)

TB Series Terminal Blocks, Modular



Contents

<i>Description</i>	<i>Page</i>
C381 Series Terminal Blocks, Rail Mounted	T42-107
TB Series Terminal Blocks, Modular	
Product Selection	T42-112
Accessories	T42-113
Technical Data and Specifications	T42-114
Dimensions	T42-115

TB Series Terminal Blocks, Modular

Product Description

TBA and TBD modular terminal blocks are designed to conserve space, while allowing maximum flexibility and ease of installation. Available as one-, two- and three-pole circuits, simple and uniform installation is possible because their design is based on 5/8 in (15.9 mm) modules. Standard blocks are white nylon.

Breathing Action Clamping Collar

The unique design of the clamping collar permits the collar to breathe as the wire expands and contracts, maintaining a constant and permanent clamping pressure. This eliminates loose connections resulting from the gradual flattening of conductors and joint deterioration caused by heating and cooling cycles.

Features**Blocks—Design Features**

- Compact design permits mounting 48–600V or 90–300V terminals per foot
- Fully shielded construction, 600V spacings
- Nylon construction provides anti-tracking and impact resistance
- TBA types are available in rail mounted, base mounted and power distribution types
- Terminal blocks easily snap on or off mounting rails; not necessary to disturb adjacent units
- No end pieces or backing plates are needed when rail mounting
- A 12 circuit subminiature blocks, rated 20A at 300V, is available for “high density” applications
- Popular blocks are also available in dual mount for use with standard TBA or 35 mm DIN rails

Terminals—Design Features

- Insulated walls of lug guide wire into lug
- Blocks are shipped with clamping screw backed out
- Constant locking torque keeps terminal screws in position
- Terminal screws are captive; cannot be lost in shipment or handling
- Hardened stainless steel clamping collar eliminates stripped threads
- Large opening in clamping collar accommodates oversized conductors; smallest collar will accept three 14 AWG stranded conductors

Standards and Certifications

- UL recognized: File No. E56797
- CE approved



Product Selection

TBA Modular Terminal Blocks

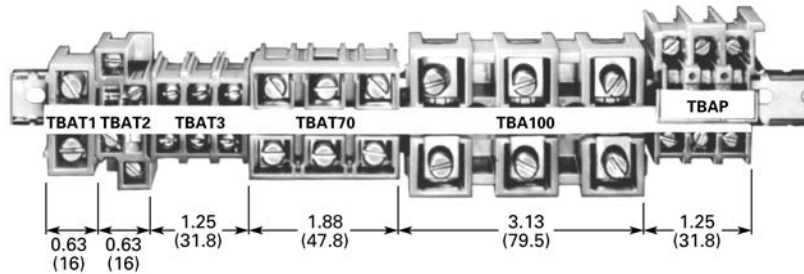

Rail and Base Mounted Terminal Blocks

Description	AWG Wire Size	Number of Poles	Ampacity (per Circuit) ^①	Carton Quantity ^②	TBA Rail Catalogue Number	DIN Rail ^③ Catalogue Number
Rail Mounted—600V						
Subminiature blocks	(2) 14–12	12	5A	100	TBDSM12 ^④	TBDSM12 ^④
Miniature blocks	22–10	4	30A	100	TBDV4	TBDV4
Standard blocks—screw terminals with tang clamping collars	18–2	1	90A	100	—	TBDT1
	22–8	2	40A	100	TBAT2	—
	22–8	3	40A	20	TBAT3-20	TBDT3-20
	18–4	3	90A	100	TBDT70	TBDT70
High current blocks	14–2/0	3	175A	12	TBA100 ^⑤	—
Standard blocks—plug-in terminals	22–8	3	40A	20	TBAP	—
	18–4	3	70A	20	TBAP70	—
	14–8	3	40A	20	TBAPL70	—
Panel mount blocks	22–10	3	30A	100	TBAL30	—
	8–4	3	115A	12	TBAL90	—
Disconnect blocks—for 1/4 in (6.4 mm) dia. by 1–1/16 in (25.4–36.5 mm) fuse	22–8	1	30A	50	TBAD	—
Fuse blocks—for 13/32 in (10.3 mm) dia. by 1-1/2 in (38.1 mm) fuse	22–8	1	30A	50	TBDTF	TBDTF
Base Mounted—600V						
Miniature blocks—screw terminals with tang clamping collars	22–10	4	30A (600V)	90	TBBT4	—
Standard blocks—standard screw terminals	22–8	3	40A	80	TBAPT3	—
Universal mounting blocks	8 maximum	4	50A ^⑥	25	TBU4	—
	8 maximum	6	50A ^⑥	60	TBU6	—
	8 maximum	8	50A ^⑥	45	TBU8	—
	8 maximum	12	50A ^⑥	35	TBU12	—

Notes

- ① Based on 50°C rise, test at 25°C ambient while using maximum wire size.
- ② Must be ordered in standard package quantity or in multiples of these quantities.
- ③ Dual mounting blocks—mount on either TMR/TBA rail or 35 mm DIN rail.
- ④ May also be mounted on mini-DIN rail (15 mm). Catalogue Number C383TS15.
- ⑤ May also be base mounted.
- ⑥ TBU Series = 60A with crimped wire.

Accessories**TB Series Terminal Blocks, Modular**

Description	Length ^①	Number of Poles	Carton Quantity ^②	Catalogue Number
Mounting Rail				
Aluminum	12.5 (317.5)	—	25	TMR12
	37.5 (952.5)	—	25	TMR37
	72.0 (1828.8)	—	25	TBATR72
35 mm DIN—steel	1m	—	20	MC382MA1-20
Marking Strips				
Miniature blocks—TBDV4 and TBBT4	6.0 (152.4)	—	50	TMS6
TBU Series—matte finish	7.5 (190.5)	—	25	TMSU
All other blocks	12.5 (317.5)	—	50	TMS
Jumpers				
TBAT1 and TBAP70	—	2-pole	100	TJ1
TBAT2	—	2-pole	100	TJ2
TBAT3, TBABT3, TBAP and TBBP	—	2-pole	100	TJ3
TBDV4 and TBBT4	—	4-pole	100	TJ4
TBAD and TBATF	—	2-pole	100	TJ5
TBAL30	—	2-pole	100	TJ6
TBU	—	12-pole	10	TJ7
TBDT3	—	2-pole	100	TJ8
Miscellaneous				
End piece for TBABT3 and TBBP	—	—	50	TAD
Lug shield for TBA100 and TBAL90	—	—	50	TAS
Fuse puller	—	—	50	TBP
Lighted fuse puller—blown fuse indication	—	—	25	TBLP

Notes

- ① Length in inches (mm) except as noted.
 ② Must be ordered in standard package quantity or in multiples of these quantities.

Technical Data and Specifications

TB Series Terminal Blocks, Modular

Description	Specification
Continuous temperature	212°F (100°C)
Tensile strength	10,000–12,000 psi
Impact resistance	2.0 ft-lb/in (arc)
Arc resistance	140 seconds

- Chemical resistance to:
 - Acetone
 - Ammonia gas
 - Benzene
 - Gasoline
 - Mineral oil
 - Sodium bisulfate
 - Sodium chloride
 - Sodium nitrate
 - Water up to 50°C

Flashover Voltages

Catalogue Number	Vac rms, 60 Hz	
	Opposite Polarity	To Ground
TBAT1	9100	6600
TBAT2	9600	7300
TBAT3	8600	7300

Recommended Terminal Tightening Torque

Wire Size	Torque
Up to 8 AWG	20 lb-in
Up to 4 AWG	35 lb-in
Up to 2/0 AWG	50 lb-in

42

To find a current rating, place a straight edge horizontally at the value of anticipated maximum internal panel ambient (scale on the left), and read the current rating for the device on the bottom scale. *Example:* at 60°C, TBAT3 is rated 54 amperes.

Ampere rating is based on maximum allowable temperature—ambient temperature plus temperature rise due to current.

Ratings based on 90°C total temperature of a three-pole block with each pole carrying current and wired with largest size conductors.

Temperature Rating

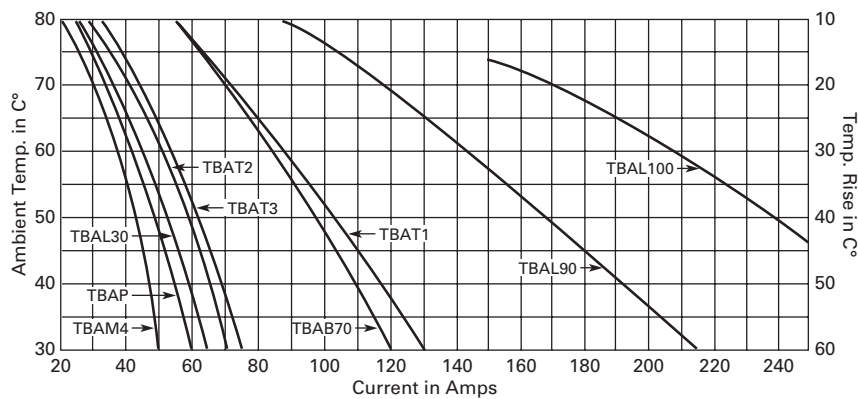

Dimensions

Approximate Dimensions in Inches (mm)

TB Series Terminal Blocks, Modular

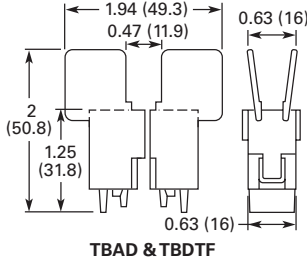
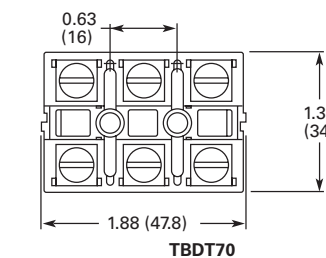
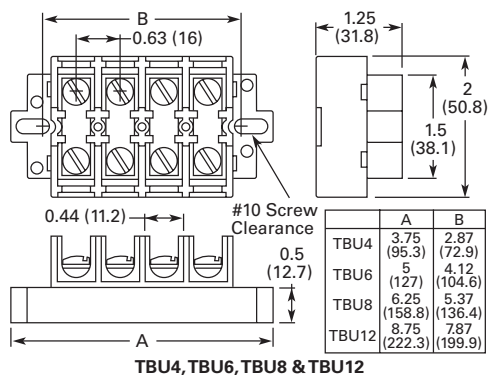
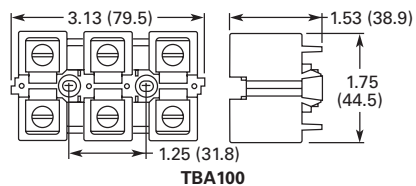
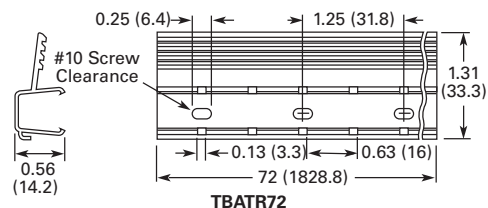
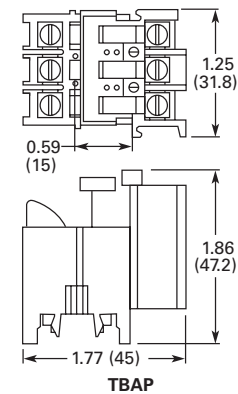
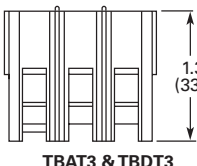
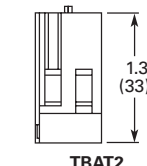
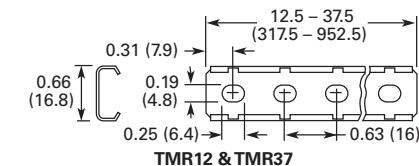
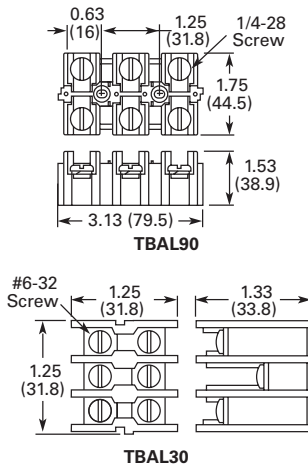
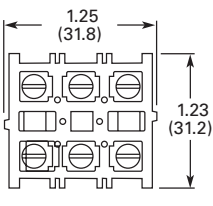
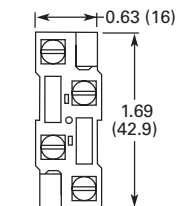
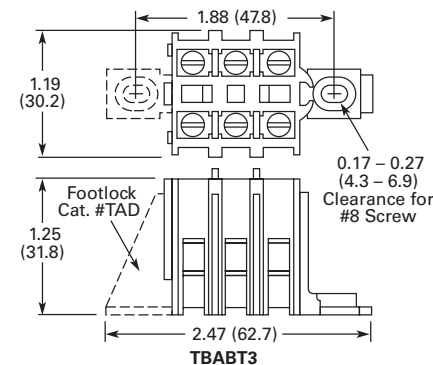
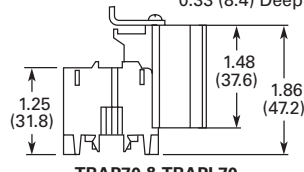
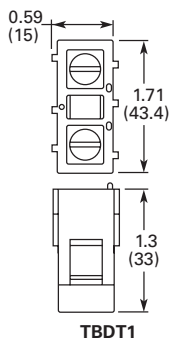
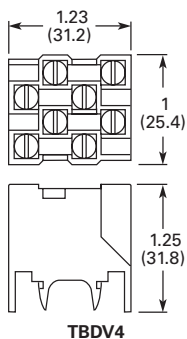
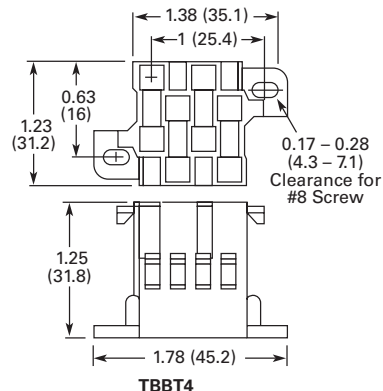
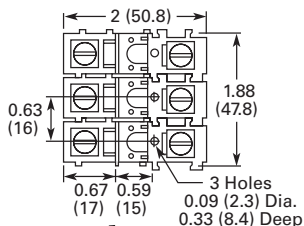
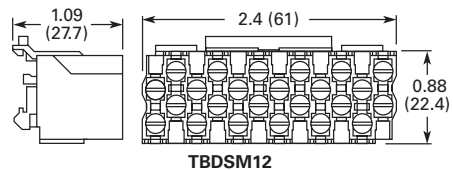

	A	B
TBU4	3.75 (95.3)	2.87 (72.9)
TBU6	5 (127)	4.12 (104.6)
TBU8	6.25 (158.8)	5.37 (136.4)
TBU12	8.75 (222.3)	7.87 (199.9)

42.3

Terminal Blocks, Fuse Blocks and Fuse Holders

Power Distribution

Power Distribution Products



42

Contents

<i>Description</i>	<i>Page</i>
Power Distribution	
CHDB Series—Power Distribution Blocks	T42-117
CH160 Series—Power Terminal Blocks	T42-123
Power Terminal Block Accessories	T42-126

Power Distribution Overview

Product Selection Guide

Series	Current Range	UL Certification	High Short Circuit Current Rating ^①	UL 508A Approved for Industrial Control Panels		
				Branch Circuits	Feeder Circuits	HVAC UL 1995
CH162	115–175A	UL 1059 Recognized	No	Yes	No ^②	Yes
CH163	175–420A	UL 1059 Recognized	No	Yes	No ^②	Yes
CH165	620–840A	UL 1059 Recognized	No	Yes	No ^②	Yes
CHDB	175–570A	UL 1953 Listed	Yes	Yes	Yes	Yes

Notes

- ① Refer to **Page T42-118** to determine short circuit current ratings with fuses and **Pages T42-119** and **T42-120** to determine short circuit current ratings in conjunction with specific Eaton circuit breakers.
- ② Single-pole units, when installed with proper spacings, may meet requirements for UL 508A feeder circuits.

CHDB Series—Power Distribution Blocks, Enclosed and Open**Contents**

Description	Page
CHDB Series—Power Distribution Blocks	
Product Selection	T42-118
Technical Data and Specifications	T42-118
Dimensions	T42-121
CH160 Series—Power Terminal Blocks	T42-123
Power Terminal Block Accessories	T42-126

CHDB Series—Power Distribution Blocks**Product Description**

Eaton's CHDB Series of Power Distribution Blocks was designed for high short circuit current rating (SCCR) applications up to 200,000 amperes. They are assembled with the minimum spacing to meet UL 1953 requirements for feeder circuits in UL 508A industrial control panels, and provide significant wiring flexibility.

Available in three-pole open style and single-pole enclosed style with a variety of terminal arrangements and current-carrying capability up to 570 amperes.

Features and Benefits**Enclosed Style**

- IP20 finger-safe enclosure
- 600 Vac or Vdc (UL 1953), 690 Vac or Vdc
- DIN rail or panel mount
- Captive termination screws prevent lost screws
- Single-pole, gang mountable for multi-pole applications
- Tin plated Al connections suitable for Cu conductors
- Flammability, UL 94V-0

Open Style

- 600 Vac or Vdc (UL 1953)
- Panel mount
- Three-pole open design for easy wiring
- Tin-plated Al connections suitable for Cu conductors
- Flammability, UL 94V-0
- Available covers for additional protection (does not meet IP20)











Standards and Certifications

- UL Listed 1953, Guide QPOS, File E256146
- CSA Certified, Class 6228-01, File 15364 (enclosed style)
- CE Component IEC 60947-7-1 (enclosed style)
- IEC 60529, IP20 (finger-safe) under specific wiring conditions (enclosed style)



Product Selection

CHDB Series—Power Distribution Blocks

	Line Connection	Load Connection	Configuration	Amperes	Style	Poles	Catalogue Number
	2/0-#8 AWG	(4) #4-#14 AWG		175	Open	3	CHDB2203
	2/0-#8 AWG	(6) #4-#14 AWG		175	Open	3	CHDB3213
	300 kcmil-#4 AWG	(6) #4-#12 AWG		310	Open	3	CHDB3233
	300 kcmil-#4 AWG	(12) #4-#14 AWG		310	Open	3	CHDB3703
	300 kcmil-#4 AWG	(6) #2-#12 AWG (3) 1/0-#12 AWG		310 310	Open Open	3 3	CHDB3713 CHDB3713
	2/0-#8 AWG	2/0-#8 AWG		175	Enclosed ^①	1	CHDB204F
	500 kcmil-#6 AWG	(6) #2-#14 AWG		380	Enclosed ^①	1	CHDB330F
	300 kcmil-#4 AWG	(12) #4-#14 AWG		570	Enclosed ^①	1	CHDB377F

Technical Data and Specifications







































Power Terminal Block Short-Circuit Current Ratings (SCCR) with Fuses

Catalogue Number	Terminal Copper Conductors		Maximum Fuse Class and Amperes				SCCR (kA)
			J	T	RK-1	RK-5	
Line	Load	LPJ	JJS/JJN	LPS-RK/LPN-RK	FRS-R/FRN-R		
CHDB2203	2/0-#8 AWG	#4-#12 AWG	200	200	200	60	200
		#4-#14 AWG	175	175	100	60	100
			200	200	100	60	50
CHDB3213	2/0-#8 AWG	#4-#12 AWG	400	400	200	100	200
			400	400	400	100	100
		#4-#14 AWG	175	175	100	60	100
CHDB3233	300 kcmil-#4 AWG	#4-#8 AWG	400	400	200	100	200
			400	400	400	100	100
		#4-#12 AWG	175	175	100	60	100
CHDB3703	300 kcmil-#4 AWG	#4-#8 AWG	400	400	200	100	200
		#4-#14 AWG	400	400	400	100	100
			175	175	100	60	100
CHDB3713	300 kcmil-#4 AWG	1/0-#6 AWG	400	400	200	100	200
		#4-#12 AWG	400	400	400	100	100
			175	175	100	60	100
CHDB204F	2/0-#8 AWG	2/0-#8 AWG	200	200	100	60	200
CHDB330F	500 kcmil-#6 AWG	#2-#6 AWG	400	400	200	100	200
		#2-#14 AWG	200	200	100	30	50
			175	175	100	30	100
CHDB377F	300 kcmil	#4-#8 AWG	600	600	400	200	200
	300 kcmil-#4 AWG	#4 AWG	600	600	400	200	50
		#4-#14 AWG	200	200	100	30	50

Note

^① Finger-safe.

































Power Terminal Block Short-Circuit Ratings (SCCR) for UL 508A Applications with Circuit Breakers

Catalogue Number	Description	Enclosure Size in Inches (mm)	Current Rating	Opening per Pole		Line Conductors Cu	Load Conductors Cu	SCCR @ 480V (Load Side)	Eaton Breaker	Available Breaker Current Ratings
				Line	Load					
CHDB2203	Feeder Listed Open PDB	16.00 x 16.00 x 6.75 (406.4 x 406.4 x 171.5)	175			2/0-#8	#4-#10 #12 #14	18 kA 18 kA 14 kA	EGB125	15, 20, 25, 30, 35, 40, 45, 50, 60, 70, 80, 90, 100, 125
CHDB2203	Feeder Listed Open PDB	16.00 x 16.00 x 6.75 (406.4 x 406.4 x 171.5)	175			2/0-#8	#4-#10 #12 #14	25 kA 22 kA 14 kA	EGE125	15, 20, 25, 30, 35, 40, 45, 50, 60, 70, 80, 90, 100, 125
CHDB2203	Feeder Listed Open PDB	16.00 x 16.00 x 6.75 (406.4 x 406.4 x 171.5)	175			2/0-#8	#4-#10 #12 #14	50 kA 22 kA 14 kA	EGS125	15, 20, 25, 30, 35, 40, 45, 50, 60, 70, 80, 90, 100, 125
CHDB2203	Feeder Listed Open PDB	16.00 x 16.00 x 6.75 (406.4 x 406.4 x 171.5)	175			2/0-#8	#4-#10 #12 #14	65 kA 22 kA 14 kA	EGH125	15, 20, 25, 30, 35, 40, 45, 50, 60, 70, 80, 90, 100, 125
CHDB2203	Feeder Listed Open PDB	16.00 x 16.00 x 6.75 (406.4 x 406.4 x 171.5)	175			2/0-#8	#4-#10 #12 #14	65 kA 22 kA 14 kA	EGC125 [Ⓢ]	15, 20, 25, 30, 35, 40, 45, 50, 60, 70, 80, 90, 100, 125
CHDB3213	Feeder Listed Open PDB	24.00 x 20.00 x 6.75 (609.6 x 508.0 x 171.5)	175			2/0-#8	#4-#10 #12 #14	18 kA 18 kA 18 kA	EGB125	15, 20, 25, 30, 35, 40, 45, 50, 60, 70, 80, 90, 100, 125
CHDB3213	Feeder Listed Open PDB	24.00 x 20.00 x 6.75 (609.6 x 508.0 x 171.5)	175			2/0-#8	#4-#10 #12 #14	25 kA 22 kA 18 kA	EGE125	15, 20, 25, 30, 35, 40, 45, 50, 60, 70, 80, 90, 100, 125
CHDB3213	Feeder Listed Open PDB	24.00 x 20.00 x 6.75 (609.6 x 508.0 x 171.5)	175			2/0-#8	#4-#10 #12 #14	50 kA 22 kA 18 kA	EGS125	15, 20, 25, 30, 35, 40, 45, 50, 60, 70, 80, 90, 100, 125
CHDB3213	Feeder Listed Open PDB	24.00 x 20.00 x 6.75 (609.6 x 508.0 x 171.5)	175			2/0-#8	#4-#10 #12 #14	65 kA 22 kA 18 kA	EGH125	15, 20, 25, 30, 35, 40, 45, 50, 60, 70, 80, 90, 100, 125
CHDB3213	Feeder Listed Open PDB	24.00 x 20.00 x 6.75 (609.6 x 508.0 x 171.5)	175			2/0-#8	#4-#10 #12 #14	65 kA 22 kA 18 kA	EGC125 [Ⓢ]	15, 20, 25, 30, 35, 40, 45, 50, 60, 70, 80, 90, 100, 125
CHDB204F	Feeder Listed Enclosed PDB	16.00 x 16.00 x 6.75 (406.4 x 406.4 x 171.5)	175			2/0-#8	2/0-#8	18 kA	EGB125	15, 20, 25, 30, 35, 40, 45, 50, 60, 70, 80, 90, 100, 125
CHDB204F	Feeder Listed Enclosed PDB	16.00 x 16.00 x 6.75 (406.4 x 406.4 x 171.5)	175			2/0-#8	2/0-#8	25 kA	EGE125	15, 20, 25, 30, 35, 40, 45, 50, 60, 70, 80, 90, 100, 125
CHDB204F	Feeder Listed Enclosed PDB	16.00 x 16.00 x 6.75 (406.4 x 406.4 x 171.5)	175			2/0-#8	2/0-#8	35 kA	EGS125	15, 20, 25, 30, 35, 40, 45, 50, 60, 70, 80, 90, 100, 125
CHDB204F	Feeder Listed Enclosed PDB	16.00 x 16.00 x 6.75 (406.4 x 406.4 x 171.5)	175			2/0-#8	2/0-#8	65 kA	EGH125	15, 20, 25, 30, 35, 40, 45, 50, 60, 70, 80, 90, 100, 125
CHDB204F	Feeder Listed Enclosed PDB	16.00 x 16.00 x 6.75 (406.4 x 406.4 x 171.5)	175			2/0-#8	2/0-#8	65 kA	EGC125 [Ⓢ]	15, 20, 25, 30, 35, 40, 45, 50, 60, 70, 80, 90, 100, 125
CHDB3233	Feeder Listed Open PDB	24.00 x 20.00 x 6.75 (609.6 x 508.0 x 171.5)	310			350 kmil-#4	#4-#6 #8 #10	25 kA 25 kA 14 kA	JGE250	70, 90, 100, 125, 150, 175, 200, 225, 250
CHDB3233	Feeder Listed Open PDB	24.00 x 20.00 x 6.75 (609.6 x 508.0 x 171.5)	310			350 kmil-#4	#4-#6 #8 #10	35 kA 35 kA 14 kA	JGS250	70, 90, 100, 125, 150, 175, 200, 225, 250
CHDB3233	Feeder Listed Open PDB	24.00 x 20.00 x 6.75 (609.6 x 508.0 x 171.5)	310			350 kmil-#4	#4-#6 #8 #10	65 kA 42 kA 14 kA	JGH250	70, 90, 100, 125, 150, 175, 200, 225, 250
CHDB3233	Feeder Listed Open PDB	24.00 x 20.00 x 6.75 (609.6 x 508.0 x 171.5)	310			350 kmil-#4	#4-#6 #8 #10	65 kA 42 kA 25 kA	JGC250 [Ⓢ]	70, 90, 100, 125, 150, 175, 200, 225, 250

Note

Ⓢ This breaker frame is marked current limiting and suitable for use as current limiting per UL 508A SB.4.3.2.

Power Terminal Block Short-Circuit Ratings (SCCR) for UL 508A Applications with Circuit Breakers, continued

Catalogue Number	Description	Enclosure Size in Inches (mm)	Current Rating	Opening per Pole		Line Conductors Cu	Load Conductors Cu	SCCR at 480V (Load Side)	Eaton Breaker	Available Breaker Current Ratings
				Line	Load					
CHDB3703	Feeder Listed Open PDB	24.00 x 20.00 x 6.75 (609.6 x 508.0 x 171.5)	310			350 kmil-#4	#4-#6 #8 #10	25 kA 25 kA 14 kA	JGE250	70, 90, 100, 125, 150, 175, 200, 225, 250
CHDB3703	Feeder Listed Open PDB	24.00 x 20.00 x 6.75 (609.6 x 508.0 x 171.5)	310			350 kmil-#4	#4-#6 #8 #10	35 kA 35 kA 14 kA	JGS250	70, 90, 100, 125, 150, 175, 200, 225, 250
CHDB3703	Feeder Listed Open PDB	24.00 x 20.00 x 6.75 (609.6 x 508.0 x 171.5)	310			350 kmil-#4	#4-#6 #8 #10	65 kA 42 kA 14 kA	JGH250	70, 90, 100, 125, 150, 175, 200, 225, 250
CHDB3703	Feeder Listed Open PDB	24.00 x 20.00 x 6.75 (609.6 x 508.0 x 171.5)	310			350 kmil-#4	#4-#6 #8 #10	65 kA 42 kA 25 kA	JGC250 ①	70, 90, 100, 125, 150, 175, 200, 225, 250
CHDB3713	Feeder Listed Open PDB	24.00 x 20.00 x 6.75 (609.6 x 508.0 x 171.5)	310			350 kmil-#4	#4-#6 #8 #10	25 kA 25 kA 14 kA	JGE250	70, 90, 100, 125, 150, 175, 200, 225, 250
CHDB3713	Feeder Listed Open PDB	24.00 x 20.00 x 6.75 (609.6 x 508.0 x 171.5)	310			350 kmil-#4	#4-#6 #8 #10	35 kA 35 kA 14 kA	JGS250	70, 90, 100, 125, 150, 175, 200, 225, 250
CHDB3713	Feeder Listed Open PDB	24.00 x 20.00 x 6.75 (609.6 x 508.0 x 171.5)	310			350 kmil-#4	#4-#6 #8 #10	50 kA 42 kA 14 kA	JGH250	70, 90, 100, 125, 150, 175, 200, 225, 250
CHDB3713	Feeder Listed Open PDB	24.00 x 20.00 x 6.75 (609.6 x 508.0 x 171.5)	310			350 kmil-#4	#4-#6 #8 #10	65 kA 50 kA 25 kA	JGC250 ①	70, 90, 100, 125, 150, 175, 200, 225, 250
CHDB330F	Feeder Listed Enclosed PDB	24.00 x 20.00 x 6.75 (609.6 x 508.0 x 171.5)	380			500 kmil-#3	#2-#8	14 kA	LGE400	250, 300, 350, 400
CHDB330F	Feeder Listed Enclosed PDB	24.00 x 20.00 x 6.75 (609.6 x 508.0 x 171.5)	380			500 kmil-#3	#2-#8	14 kA	LGS400	250, 300, 350, 400
CHDB330F	Feeder Listed Enclosed PDB	24.00 x 20.00 x 6.75 (609.6 x 508.0 x 171.5)	380			500 kmil-#3	#2-#8	14 kA	LGH400	250, 300, 350, 400
CHDB330F	Feeder Listed Enclosed PDB	24.00 x 20.00 x 6.75 (609.6 x 508.0 x 171.5)	380			500 kmil-#3	#2-#8	25 kA	LGC400 ①	250, 300, 350, 400
CHDB377F	Feeder Listed Enclosed PDB	24.00 x 20.00 x 6.75 (609.6 x 508.0 x 171.5)	570			(2) 300 kmil-#2	#4 #6 #8	30 kA 18 kA 14 kA	LGE600	250, 300, 350, 400, 500, 600
CHDB377F	Feeder Listed Enclosed PDB	24.00 x 20.00 x 6.75 (609.6 x 508.0 x 171.5)	570			(2) 300 kmil-#2	#4 #6 #8	30 kA 18 kA 14 kA	LGS600	250, 300, 350, 400, 500, 600
CHDB377F	Feeder Listed Enclosed PDB	24.00 x 20.00 x 6.75 (609.6 x 508.0 x 171.5)	570			(2) 300 kmil-#2	#4 #6 #8	30 kA 18 kA 14 kA	LGH600	250, 300, 350, 400, 500, 600
CHDB377F	Feeder Listed Enclosed PDB	24.00 x 20.00 x 6.75 (609.6 x 508.0 x 171.5)	570			(2) 300 kmil-#2	#4 #6 #8	42 kA 35 kA 14 kA	LGC600 ①	250, 300, 350, 400, 500, 600

Note

① This breaker frame is marked current limiting and suitable for use as current limiting per UL 508A SB.4.3.2.

Dimensions

Approximate Dimensions in Inches (mm)

CHDB2203

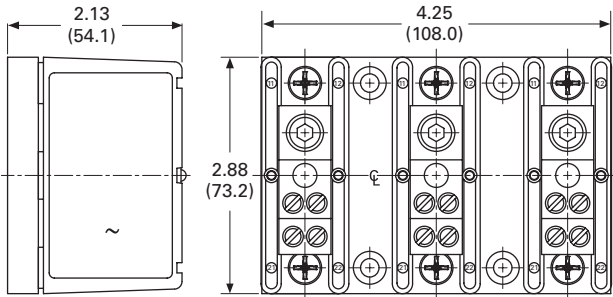

CHDB3713

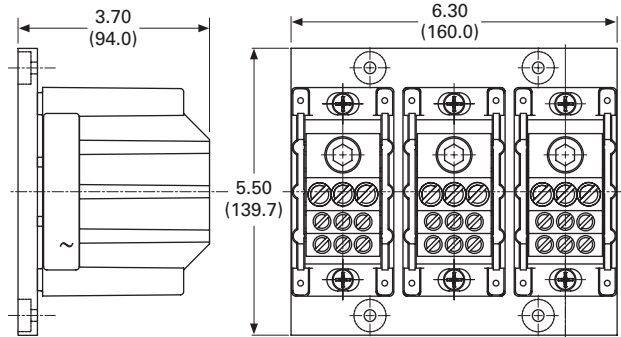

CHDB3213

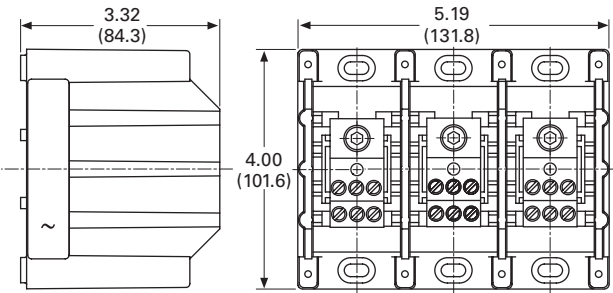

CHDB204F

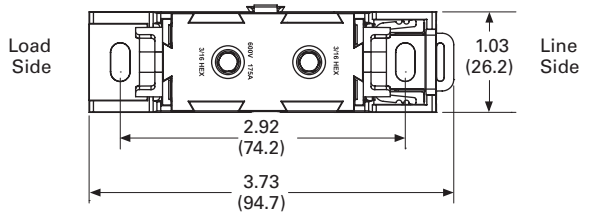

CHDB3233

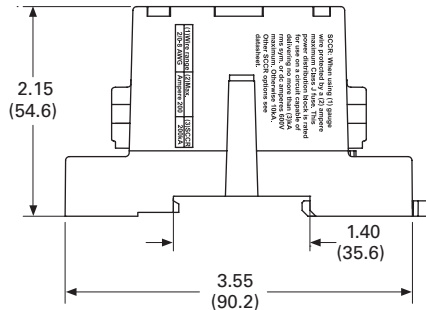
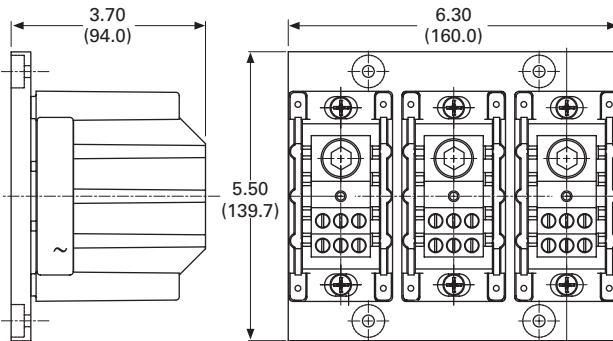

CHDB3703

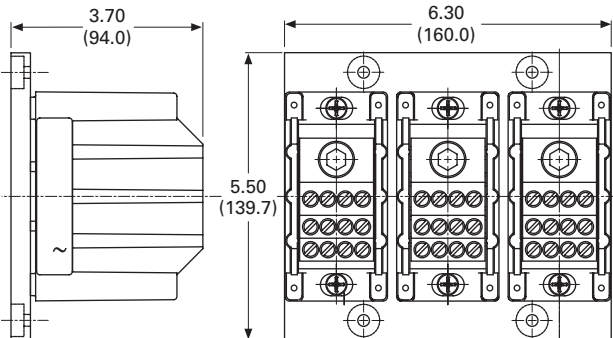

42.3

Terminal Blocks, Fuse Blocks and Fuse Holders

Power Distribution

Approximate Dimensions in Inches (mm)

CHDB330F

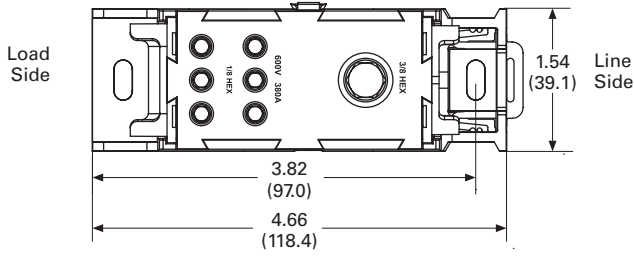

CHDB377F

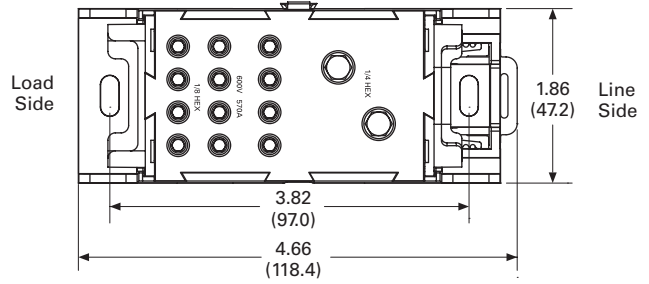

42

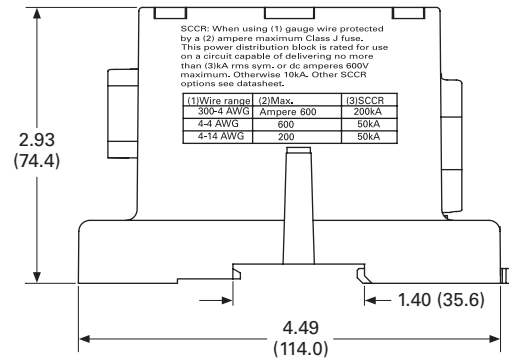
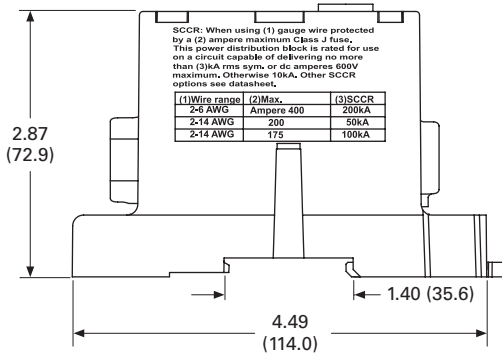

CH160 Series—Power Terminal Blocks**Contents**

Description	Page
CHDB Series—Power Distribution Blocks	T42-117
CH160 Series—Power Terminal Blocks	
Product Selection	T42-124
Technical Data and Specifications	T42-125
Dimensions	T42-125
Power Terminal Block Accessories	T42-126

CH160 Series—Power Terminal Blocks**Product Description**

The CH160 Series of Power Terminal Blocks are UL 1059 recognized power terminal blocks for branch circuit applications. All short circuit current ratings (SCCR) are 10 kA per UL 508A Table SB4.1. The blocks are available in a wide variety of wiring configurations, providing excellent flexibility.

Features and Benefits

- Ratings: To 840A, 600V
- Materials
 - Molded material; black, UL rated 94V-0 thermoplastic
- Operating temperature: 302°F (150°C)
- Optional cover: See **Page T42-126**

Standards and Certifications

- UL Recognized
- CSA Certified



Product Selection

When Ordering, Specify

- Catalogue number
- Number of poles (up to three-pole available)

CH160 Power Terminal Blocks—CH162 Series

Line Connection	Load Connection	Connector Material and Ampacity	Catalogue Number ^①
#2-#14 Cu/#8 Al	#2-#14 Cu/#8 Al	Al 115A	CH16200_
1/0-#14 Cu	1/0-#14 Cu	Cu 150A	CH16201_
2/0-#8 Cu/Al	2/0-#8 Cu/Al	Al 175A	CH16204_
2/0-#14 Cu/#8 Al	(4) #4-#14 Cu/#8 Al	Al 175A	CH16220_

CH160 Power Terminal Blocks—CH163 Series

Line Connection	Load Connection	Connector Material and Ampacity	Catalogue Number ^①
250 kcmil-#6 Cu	250 kcmil-#6 Cu	Cu 255A	CH16301_
350 kcmil-#6 Cu/Al	350 kcmil-#6 Cu/Al	Al 310A	CH16303_
500 kcmil-#6 Cu/Al	500 kcmil-#6 Cu/Al	Al 380A	CH16306_
2/0-#14 Cu/Al	(6) #4-#14 Cu/#8 Al	Al 175A	CH16321_
350 kcmil-#6 Cu/Al	(6) #4-#14 Cu/#8 Al	Al 310A	CH16323_
(2) 2/0-#14 Cu/#8 Al	(6) #4-#14 Cu/#8 Al	Al 350A	CH16325_
500 kcmil-#6 Cu/Al	(6) #2-#14 Cu/#8 Al	Al 380A	CH16330_
350 kcmil-#6 Cu/Al	(3) #2-#14 Cu/#8 Al	Al 310A	CH16332_
	(2) 1/0-#14 Cu/#8 Al	Al 310A	CH16332_
350 kcmil-#6 Cu/Al	(12) #4-#14 Cu/#8 Al	Al 310A	CH16370_
350 kcmil-#6 Cu/Al	(6) #2-#14 Cu/#8 Al	Al 310A	CH16371_
	(3) 1/0-#14 Cu/#8 Al	Al 310A	CH16371_
350 kcmil-#6 Cu/Al	(21) #10-#14 Cu/#10 Al	Al 310A	CH16372_
350 kcmil-#6 Cu/Al	(3) 1/0-#14 Cu/#8 Al	Al 310A	CH16373_
	(14) #10-#14 Cu/#8 Al	Al 310A	CH16373_
600 kcmil-#2 Cu/Al	(12) #4-#14 Cu/#8 Al	Al 420A	CH16375_
600 kcmil-#2 Cu/Al	(6) #2-#14 Cu/#8 Al	Al 420A	CH16376_
	(3) 1/0-#14 Cu/#8 Al	Al 420A	CH16376_

CH160 Power Terminal Blocks—CH165 Series

Line Connection	Load Connection	Connector Material and Ampacity	Catalogue Number ^①
(2) 350 kcmil-4 Cu/Al	(2) 350 kcmil-4 Cu/Al	Al 620A	CH16500_
(2) 500 kcmil-#6 Cu/Al	(2) 500 kcmil-#6 Cu/Al	Al 760A	CH16504_
(2) 600 kcmil-#2 Cu/Al	(4) 3/0-#8 Cu/Al	Al 840A	CH16528_
	(4) #4-#14 Cu/#8 Al	Al 840A	CH16528_
(2) 500 kcmil-#6 Cu/Al	(12) #4-#14 Cu/#8 Al	Al 760A	CH16530_

Note

- ^① Incomplete catalogue number—add code suffix **-1**, **-2**, **-3** for number of poles.
Example: For a 150A 1/0-#14 Cu to 1/0-#14 Cu three-pole PDB, order CH16201-3.

Technical Data and Specifications

CH160 Power Terminal Blocks

Description	Specification
Ratings	To 840A, 600V
Materials	Molded material; black, UL rated 94V-0 thermoplastic
Operating temperature	302°F (150°C)

Note: For optional cover, see Power Terminal Block Accessories, **Page T42-126**.

Dimensions

Approximate Dimensions in Inches (mm)

Series CH163 (Single-, Two- and Three-Pole Available)

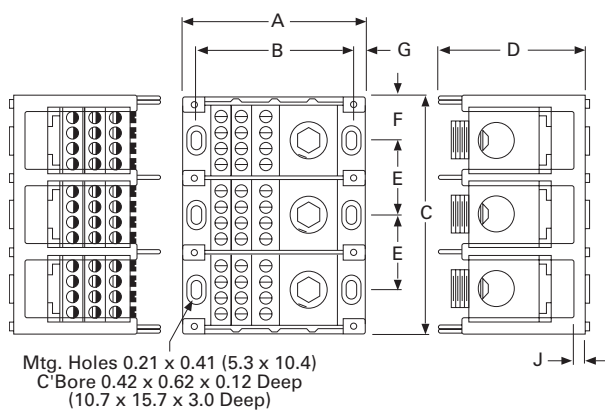

Series CH162 and CH165 (Single-, Two- and Three-Pole Available)

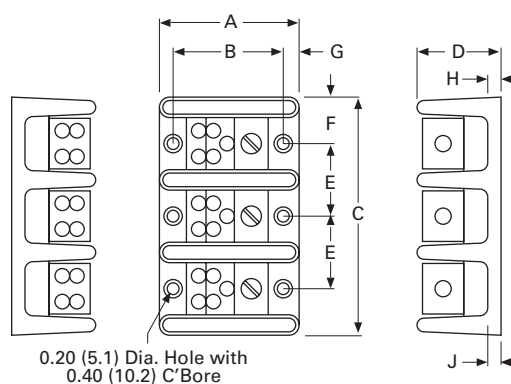

CH160 Power Terminal Block Dimensions

Series	A	B	C			D	E4	F	G	H	J
			Single-Pole	Two-Pole	Three-Pole						
CH162	2.87 (72.9)	2.25 (57.2)	1.06 (26.9)	1.87 (47.5)	2.68 (68.1)	1.75 (44.5)	0.81 (20.6)	0.53 (13.5)	0.31 (7.9)	0.84 (21.3)	0.31 (7.9)
CH163	4.00 (101.6)	3.37 (85.6)	1.96 (49.8)	3.58 (90.9)	5.20 (132.1)	3.32 (84.3)	1.62 (41.1)	0.97 (24.6)	0.31 (7.9)	0.87 (22.1)	0.35 (8.9)
CH165	5.50 (139.7)	4.75 (120.7)	3.12 (79.2)	5.81 (147.6)	8.50 (215.9)	3.12 (79.2)	2.68 (68.1)	1.56 (39.6)	0.37 (9.4)	1.37 (34.8)	0.62 (15.7)

Power Terminal Block Accessories



42

Contents

<i>Description</i>	<i>Page</i>
CHDB Series—Power Distribution Blocks	T42-117
CH160 Series—Power Terminal Blocks	T42-123
Power Terminal Block Accessories	
Technical Data and Specifications	T42-127
Dimensions	T42-127

Power Terminal Block Accessories

Product Description

Protective Cover

- Guards against accidental contact
- Clear with write-on surface for field termination identification
- Available in single-, two- and three-pole

Standards and Certifications

TB Series Power Blocks

- Contact Eaton for the latest UL 508A short circuit ratings on terminal blocks
- UL Recognized: File No. E62622
- CSA Certified: File No. LR15364



Product Selection

When Ordering, Specify

- Catalogue number

CH163 Series Cover

Description	Catalogue Number
Single-pole cover	CHCPDB-1 ①
Two-pole cover	CHCPDB-2 ①
Three-pole cover	CHCPDB-3 ①

TB Series Power Blocks

Line Connection	Load Connection	Catalogue Number
#300 kcmil-#6 Cu/Al	(6) #6-#14 Cu/#8Al	TBAN63

Note

① Standard pack, five pieces.

Technical Data and Specifications

TB Series Power Blocks

Description	Specification
Ratings	285A, 600V; UL/CSA
Materials	Molded material; black, UL rated 94V-2 thermoplastic
Operating temperature	257°F (125°C)

Dimensions

Approximate Dimensions in Inches (mm)

CH163 Series Cover

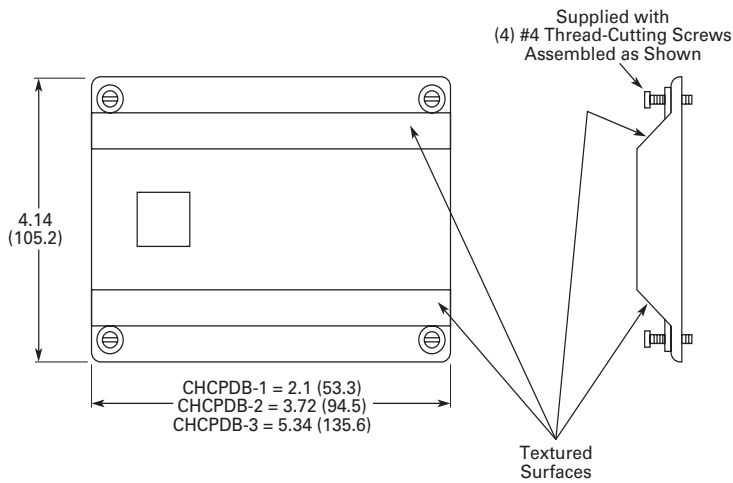

TB Series Power Blocks

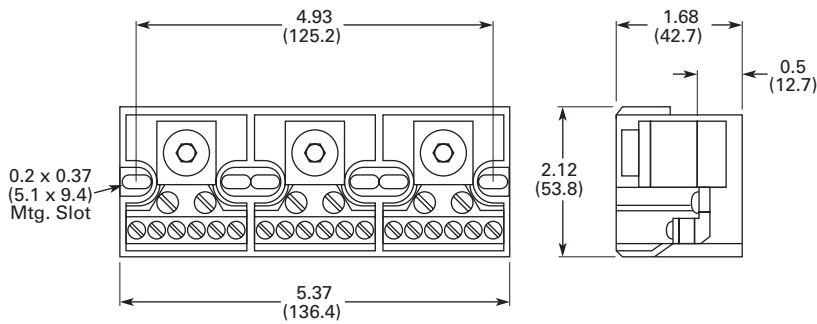

42.4

Terminal Blocks, Fuse Blocks and Fuse Holders

Fuse Blocks and Fuse Holders

Fuse Blocks and Fuse Holders



42

Contents

Description

Page

Fuse Blocks and Fuse Holders	
C383 Series Disconnect Fuse Holders	T42-129
C350 Series Fuse Blocks and W Series Fuse Holders	T42-131

Fuse Blocks and Fuse Holders Overview

Product Description

Available in compact finger safe (C383) and an open (C350) design. Eaton's fuse blocks and holders provide a simple DIN mounting device for protection in control circuits.

Application Description

Fuse holders and blocks available for Class CC, midget, H, M and R.

Standards and Certifications

- UL listed
- CSA certified (may not apply to all styles)



C383 Series Fuse Holders**Contents**

Description	Page
C383 Series Disconnect Fuse Holders	
Product Selection	T42-130
Accessories	T42-130
Technical Data and Specifications	T42-130
Dimensions	T42-130
C350 Series Fuse Blocks and W Series Fuse Holders	T42-131

C383 Series Disconnect Fuse Holders**Product Description**

Eaton's C383 Series disconnect fuse holders offer 600V fused circuit protection and subsequently "no load" switching.

These compact disconnects are designed as components in switchboards, panels and control consoles where positive and safe circuit protection is required and where space is at a premium.

The C383 fuse holders mount directly on standard TS35 DIN rails.

Features

- "Finger-Safe" design— Recessed termination screws and a fuse extraction door afford you IP20 grade protection and qualify as "finger-safe" per IEC standards
- Easy to adjust position on rail—Simply unlatch the DIN rail adapter, slide the holder to desired position and relock
- Quick change of fuse— A permanently attached pivoting fuse door simplifies and speeds fuse extraction. No tools or accessories needed
- Class CC model is UL listed and CSA certified for branch circuit protection. Midget models are UL Recognized and CSA certified for supplementary and high-speed protection
- Runs cool—The vented design provides adequate air flow around the holders at all times
- Self-extinguishing UL 94-VO rated polyester material

Standards and Certifications

Rated voltage:

- CSA/UL: 600 Vac/Vdc, 30A
- IEC (midget only): 690 Vac, 32A



42.4

Terminal Blocks, Fuse Blocks and Fuse Holders

Fuse Blocks and Fuse Holders

Product Selection

C383FH_



Disconnect Fuse Holders

Description	Standard Pack	Catalogue Number
For Class CC Fuse		
Single-pole fuse holder	12	C383FHCC
For Midget Fuse (1-1/2 in x 13/32 in)		
Single-pole fuse holder	12	C383FHMD

42

Accessories

Disconnect Fuse Holders

Description	Standard Pack	Catalogue Number
Midget or Class CC Fuse Holder		
Multi-pole connection links	100	C383MPCL
Multi-pole handle pins	100	C383MPHP

Accessory Details

C383MPCL

Multi-pole connection links can be used to connect fuse holders together for multi-pole applications. Use two per connection.

C383MPHP

Handle pins can be used to connect handles in multi-pole applications.

Technical Data and Specifications

Disconnect Fuse Holders ①

Description	Specification
Housing	Polyester UL 94-V0 rated
Colour	White
Wire size	8–18 AWG ②
Torque	22 lb-in (2.5 Nm)
Fuse size	0.41 x 1.5 in

Dimensions

Approximate Dimensions in Inches (mm)

CH163 Series Cover

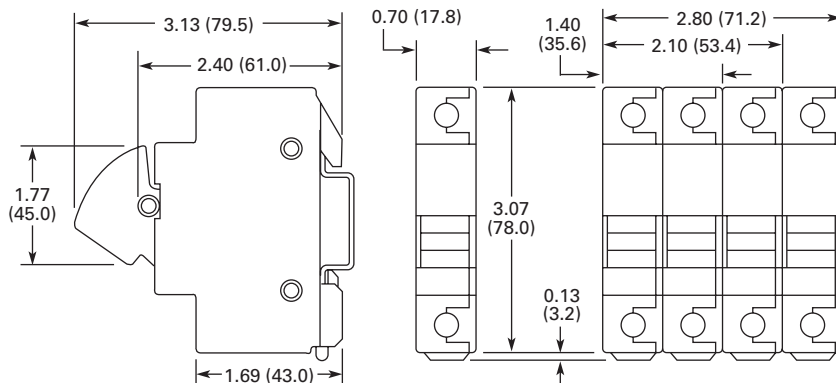

Notes

- ① For additional technical information, consult the Eaton web site or Customer Support Centre.
- ② UL recognizes both solid and stranded wire. Ferrules are not required. CSA requires ferrules on stranded wire to achieve approval.

C350 Series Fuse Blocks and W Series Fuse Holders



Contents

Description	Page
C383 Series Disconnect Fuse Holders	T42-129
C350 Series Fuse Blocks and W Series Fuse Holders	
Product Selection	T42-132
Accessories	T42-133
Technical Data and Specifications	T42-133
Dimensions	T42-133

C350 Series Fuse Blocks and W Series Fuse Holders

Product Description

Fuse Blocks

These space-saving Type C350 Fuse Blocks are UL approved for motor loads and are rated 600V, 30A.

Fuse Holders

- Class H, M and R

Features

Fuse Blocks

- Mount to 35 mm flat and 32 mm asymmetrical DIN rails
- 600V, 30A rated captive pressure plate terminals with copper alloy fuse clips
- Interlocking fuse blocks permit single, double or three-pole application—reduce inventory
- Class CC fuses have an interrupting rating of 200,000A
- Rejection feature prevents insertion of fuses with lower interrupting or voltage ratings

Fuse Holders

- Break-resistant: molded of heat-stabilized nylon
- Fuse clips: spring-reinforced for cool operation
- Fuse clip terminations: one-piece construction
- Universal mounting dimensions, for easy assembly and retrofit
- Breathing action collar: maintenance-free
- Pressure wire connectors: vibration resistant

Standards and Certifications

Contact Eaton for the latest UL 508A short circuit ratings on terminal blocks.

Fuse Blocks

- UL listed
- CSA certified



Fuse Holders

- UL tested for OEM subfeed applications



Fuse Blocks and Adapters

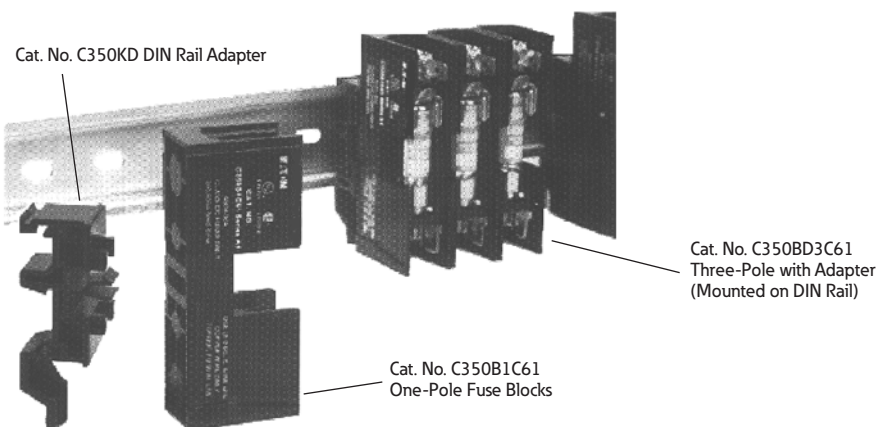

42.4

Terminal Blocks, Fuse Blocks and Fuse Holders

Fuse Blocks and Fuse Holders

Product Selection

Class CC Fuse Blocks

Type	Catalogue Number
Three-pole ①	C350BD3C61
Single-pole	C350B1C61
DIN adapter	C350KD

42

Class R, Three-Pole Fuse Holder



Fuse Holders—250V

Wire Termination		Number of Poles	Carton Qty.	30A Catalogue Number	Carton Qty.	60A Catalogue Number
Class H Fuse Holders						
Single collar (box lug)—sized to ampere rating		1	10	W231HA	10	W261HA
		2	5	W232HA	5	W262HA
		3	5	W233HA	5	W263HA
Class R Fuse Holders						
Single collar (box lug)—sized to ampere rating		1	10	WR231HA	—	—
		2	—	—	—	—
		3	5	WR233HA	1	WR263HA

Fuse Holders—600V

Wire Termination		Number of Poles	Carton Qty.	30A Catalogue Number	Carton Qty.	60A Catalogue Number
Class H Fuse Holders						
Single collar (box lug)—sized to ampere rating		1	10	W631HA	1	W661HA
		2	5	W632HA	1	W662HA
		3	1	W633HA	2	W663HA
Class M Fuse Holders						
Combination of double quick-connect, 20A max., and binding head screw, #10 max., Cu/Al		1	10	WM631F	—	—
		2	8	WM632F	—	—
		3	6	WM633F	—	—
Combination of double quick-connect, 20A max., and pressure plate screw, #10 max., Cu only		1	10	WM631G	—	—
		2	8	WM632G	—	—
		3	6	WM633G	—	—
Class R Fuse Holders						
Single collar (box lug)—sized to ampere rating		1	10	WR631HA	—	—
		2	5	WR632HA	—	—
		3	5	WR633HA	5	WR663HA
Combination of double quick-connect, 20A max., and binding head screw, #10 max., Cu/Al		1	—	—	—	—
		2	1	WMR632F	—	—
		3	6	WMR633F	—	—
Combination of double quick-connect, 20A max., and pressure plate screw, #10 max., Cu only		1	10	WMR631G	—	—
		3	6	WMR633G	—	—
Class R Fuse Holder, Type WRR Control Transformer Fuse Blocks						
Combination of double quick-connect, 20A max., and pressure plate screw, #14–#10 Cu only		3	6	WRR633G	—	—

Note

① Three-pole device is supplied with DIN rail adapter.

Accessories

Fuse Holder Accessories

Description	Catalogue Number
Fuse puller	TBP
Lighted fuse puller (120 Vac)	TBLP

Technical Data and Specifications

Fuse Blocks

Description	Specification
Voltage rating	600V
Ampere rating	Pressure plate terminals rated for 30A
Dielectric strength	1200V maximum
Ambient temperature	221°F (105°C) maximum
Clip/terminals	Tin-plated copper alloy
Screw and captive pressure plate	Zinc-plated steel
Base	Thermoplastic UL 94V0 flammability rating
DIN rail adapter	Thermoplastic UL 94V0 flammability rating

Dimensions

Approximate Dimensions in Inches (mm)

Fuse Blocks

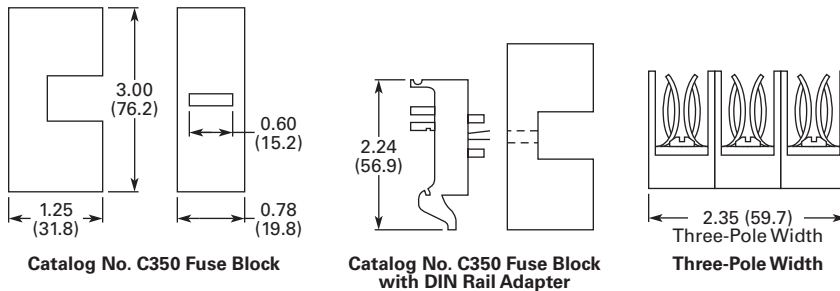

Fuse Holders

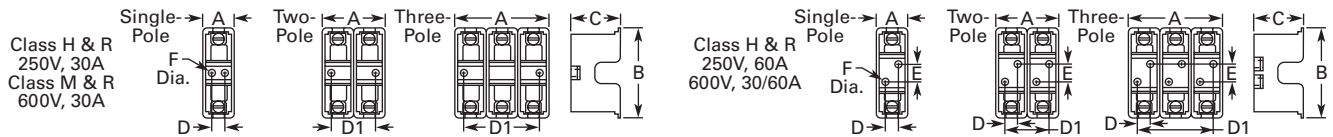

Class	Volts/ Amperes	Width A			Height B	Depth C	Mounting Holes			Diameter F	Number of Mounting Holes			
		Single- Pole	Two- Pole	Three- Pole			D	Two-Pole D1	Three-Pole D1		E	Single- Pole	Two- Pole	Three- Pole
H, R	250V, 30A	1.00 (25.4)	2.00 (50.8)	3.00 (76.2)	3.13 (79.5)	1.56 (39.6)	0.38 (9.7)	1.25 (31.8)	2.50 (63.5)	—	0.22 (5.6)	2	2	2
	250V, 60A	1.44 (36.6)	2.88 (73.2)	4.31 (109.5)	4.75 (120.7)	2.06 (52.3)	0.50 (12.7)	1.81 (46.0)	3.13 (79.5)	1.25 (31.8)	0.22 (5.6)	2	4	4
	600V, 30/60A	1.69 (42.9)	3.38 (85.9)	5.06 (128.5)	6.94 (176.3)	2.63 (66.8)	0.63 (16.0)	2.19 (55.6)	3.75 (95.3)	3.13 (79.5)	0.28 (7.1)	2	4	4
M, R	600V, 30A	0.84 (21.3)	1.63 (41.4)	2.41 (61.2)	3.00 (76.2)	1.28 (32.5)	0.38 (9.7)	0.75 (19.1)	1.50 (38.1)	—	0.17 (4.3)	2	2	2

42.4

Terminal Blocks, Fuse Blocks and Fuse Holders

Fuse Blocks and Fuse Holders

This page left intentionally blank

Terminal Blocks, Fuse Blocks and Fuse Holders

Screw Connection



Spring Cage



Insulation Displacement Connection



42.1 IEC—***XB*** Series

IEC— <i>XB</i> Series Overview	T42-2
Screw Connection Terminal Blocks	T42-4
Spring Cage Terminal Blocks	T42-31
Pluggable Spring Cage Connection Terminal Blocks	T42-58
IDC Terminal Blocks	T42-67
Miniature Circuit Breakers	T42-82
<i>XB</i> Series Accessories	T42-90

42.2 NEMA

NEMA Overview	T42-106
C381 Series Terminal Blocks, Rail Mounted	T42-107
TB Series Terminal Blocks, Modular	T42-111

42.3 Power Distribution

Power Distribution Overview	T42-116
CHDB Series—Power Distribution Blocks	T42-117
CH160 Series—Power Terminal Blocks	T42-123
Power Terminal Block Accessories	T42-126

42.4 Fuse Blocks and Fuse Holders

Fuse Blocks and Fuse Holders Overview	T42-128
C383 Series Disconnect Fuse Holders	T42-129
C350 Series Fuse Blocks and W Series Fuse Holders	T42-131

IEC—XB Series

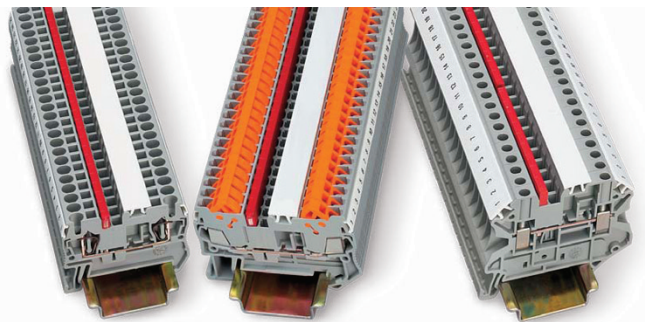

IEC—XB Series Overview

Product Description

The **XB** Series from Eaton offers a complete terminal block system with a universal range of accessories. Marking, bridging and testing accessories are standardized across the different termination technologies—reducing inventory and logistics costs. The modular terminal block design allows for use of the different terminal block types together or individually, providing the highest degree of flexibility.

Application Description

The metal portion of the **XB** Series terminal blocks are made from high-grade, strain-crack and corrosion-proof copper alloys. They won't experience any electrolytic corrosion or rusting, even when moisture is present. The metal surfaces are protected with a lead-free, galvanic nickel or tin plating. The good electrical conductivity permits only a low temperature rise. The Polyamide 6.6 housings allow for operating temperatures up to 257°F (125°C) and are certified for inflammability Class V0 in accordance with UL 94.

Features

Global acceptance—The **XB** Series terminal blocks are designed to worldwide standards and meet the latest international requirements.

Flexible Plug-in bridge system—All three technologies (screw, spring and IDC) use the same bridge system, allowing for individual potential distribution and quickly bridged connections among the same terminal block type or across different types. The **XB** Series terminal blocks have two bridge shafts arranged in one line, making flexible chain bridging and skip bridging between non-adjacent terminal blocks possible. Plug-in bridges are available from 2 to 50 positions. Reducing bridges are also available to connect a larger terminal block to a smaller one.

Contents

Description

Description	Page
IEC— XB Series	
Screw Connection Terminal Blocks	T42-4
Spring Cage Terminal Blocks	T42-31
Pluggable Spring Cage Connection Terminal Blocks	T42-58
IDC Terminal Blocks	T42-67
Miniature Circuit Breakers	T42-82
XB Series Accessories	T42-90

Large surface area for marking—All **XB** Series terminal blocks have generously sized surface areas for labeling. This allows for clearly labeled wiring that results in reduced startup time and simplifies activities such as testing and maintenance. There are provisions for marking individual terminal blocks and end stops, strips of terminal blocks, and large groups of terminal blocks.

Standardized testing system—All test plugs make contact in one of the easily accessible bridge shafts. A 2.3 mm diameter test plug is available for individual measuring wires. Modular test plugs are also available for more advanced testing.

Standards and Certifications

- UL® and cUL® recognized—File No. E67464
- CE approved
- LVD ①
 - EN 60947-7-1
 - EN 60947-7-2
 - EN 60998-2-3
 - EN 60352-4/A1
- ATEX approval (Ex e applications)



Note

- ① Not all standards apply to all terminal blocks. Contact Eaton for details.

Technical Data and Specifications

IEC—XB Series

Description	Specification
Insulation material	Polyamide 6.6
Dielectric strength	600 kV/cm
Creep resistance	600 CTI
Internal insulation resistance	10 ¹² ohms cm
Surface resistance	10 ¹⁰ ohms
Flammability rating	UL 94 V0
Continuous operating temperature	−40 to 257°F (−40 to 125°C)

Modular Terminal Blocks for Potentially Explosive Environments

The standard modular terminal blocks from Eaton are approved for potentially explosive environments. In addition to the usual approvals, they also have been approved by a testing centre authorized by the EU. No extra approval is required in Intrinsic Safety type applications.

Modular terminal blocks on www.eaton.com fulfill the requirements for “Increased Safety” protection type when installation instructions are followed, and have a type examination certificate in accordance with the Ex directive Ex-RL 94/9/EU.

These test certificates are recognized in all the EU member states and beyond.

The modular terminal blocks are approved for fitting in Zone 1, the Ex environment, as well as Zone 2. Zone 1 fitting is conditional upon terminal blocks being used in connection boxes approved for EEx e type protection and having the equivalent of at least IP54 protection.

The EEx approved modular terminal blocks can be divided into the following groups:

- Screw connection terminal blocks
- Spring-cage connection terminal blocks
- Insulation Displacement Connection terminal blocks
- Mini terminal blocks
- Terminal blocks for specialized applications

More detailed information on modular terminal blocks in the EEx e area is available on the Internet at www.eaton.com for downloading.

Here you will find the following:

- Technical data in accordance with EN 50 019
- Approved accessories
- Important installation instructions and mounting diagrams
- EU type examination certificates
- General information on Ex protection

Identifications

Explosion protected electrical equipment must be marked so that the safety characteristics are identifiable. The identification of electrical equipment is described in the harmonized standard EN 50014, as shown in the following example:

EN 50014 Standard Example

Description	Identification
Manufacturer or trademark	Eaton
Type designation	XBUT25
Abbreviation of explosion protection	EEx e II
Protection type increased safety “e”	e
Equipment group	II
Mark of the testing body	KEMA
Approval number	05ATEX2158 U

Identification in Accordance with ATEX-RL

Electrical equipment that is certified in accordance with the ATEX 100a guideline also receives identification describing the site for use.

ATEX Guideline Example

Description	Identification
Manufacturing data	02.01.2004
Address of the manufacturer	Duncan, SC
Number of the appointed dept.	344
Common marking	Ex symbol
Equipment group	II
Category	2
Use in gas and/or dust atmospheres	G D

Screw Connection



42

Contents

<i>Description</i>	<i>Page</i>
Screw Connection Terminal Blocks	
Single Level—Through-Feed	T42-5
Single Level—Ground Blocks	T42-10
Multi-Conductor Terminal Blocks	T42-12
Multi-Conductor Ground Blocks	T42-14
Double Level	T42-16
Triple Level Sensor/Actuator	T42-18
Fuse Terminal Blocks	T42-21
Disconnect and Component Terminal Blocks	T42-24
High Current Blocks	T42-27
Mini Screw Connection	T42-29

Screw Connection Terminal Blocks Overview

Product Description

The XBUT Series uses a screw connection system that is accepted worldwide and is suitable in most applications. The maintenance-free connection provides the reliability you expect from Eaton.

Application Description

Designed for applications with high demands, the XBUT Series screw terminal block has a maintenance-free wire connection. re-tightening of the terminal screws is not necessary to ensure proper operation. The screw locking technique prevents the screws from backing out. Copper wires can be clamped without pre-treatment or ferrules can be used for splicing protection. Multiple conductors can be connected in the same clamping mechanism, saving space.

Features

- Maintenance-free connections
- Global acceptance
- Multi-conductor connections
- Flexible Plug-in bridge system
- Large surface area for marking
- Standardized testing system
- Metal parts made of tin-plated copper alloy

Standards and Certifications

- UL and cUL recognized—File No. E67464
- CE approved
- LVD ①:
 - EN 60947-7-1
 - EN 60947-7-2
 - EN 60998-2-3
 - EN 60352-4/A1
- ATEX approval (Eex e applications)



Note

① Not all standards apply to all terminal blocks. Contact Eaton for details.

Single Level—Through-Feed

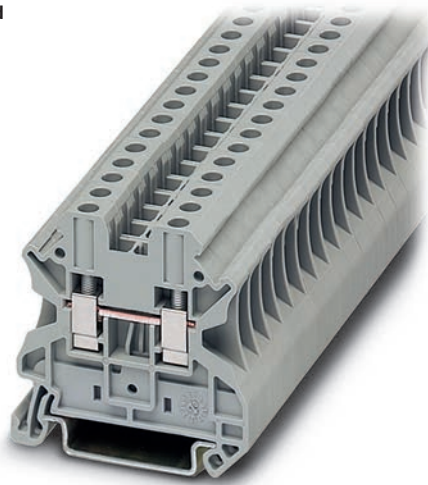

Single Level—Through-Feed

Product Description

The XBUT terminal blocks feature a compact design and maintenance-free screw connection. There is a double bridge shaft providing maximum flexibility.

The double bridge shaft can accommodate individual chain bridging and step-down bridging from other terminal blocks. There are numerous options for accessories,

Contents

Description

	<i>Page</i>
Single Level—Through-Feed	
Product Selection	T42-6
Accessories	T42-7
Technical Data and Specifications	T42-9
Dimensions	T42-9
Single Level—Ground Blocks	T42-10
Multi-Conductor Terminal Blocks	T42-12
Multi-Conductor Ground Blocks	T42-14
Double Level.	T42-16
Triple Level Sensor/Actuator	T42-18
Fuse Terminal Blocks	T42-21
Disconnect and Component Terminal Blocks	T42-24
High Current Blocks	T42-27
Mini Screw Connection	T42-29

including those for testing and marking. Terminal blocks are available for wire cross-sections ranging from 12 AWG (2.5 mm²) to 2/0 AWG (150 mm²).

42.1

Terminal Blocks, Fuse Blocks and Fuse Holders

IEC—XB Series

Product Selection

XBUT4



Screw Connection Single Level—Through-Feed

Terminal Width	Maximum Wire Size	IEC 60 947-7-1 in V/A/AWG	EN 50 019 ① in V/A/AWG	UL-cUL Ratings in V/A/AWG	Colour	Standard Pack	Catalogue Number
5.2 mm	12 AWG/2.5 mm ²	800/32/26–12	750/22/28/26–12	600/20/26–12	Gray	50	XBUT25
					Blue	50	XBUT25BU
6.2 mm	10 AWG/4 mm ²	800/41/26–10	750/30/38/26–10	600/30/26–10	Gray	50	XBUT4
					Blue	50	XBUT4BU
					Orange	50	XBUT4OR
					Yellow	50	XBUT4YE
					Red	50	XBUT4RD
					White	50	XBUT4WH
					Black	50	XBUT4BK
8.2 mm	8 AWG/6 mm ²	800/57/24–8	750/40/50/24–8	600/50/24–8	Gray	50	XBUT6
					Blue	50	XBUT6BU
10.2 mm	6 AWG/10 mm ²	1000/76/20–6	750/54/69/20–6	600/65/20–6	Gray	50	XBUT10
					Blue	50	XBUT10BU
					Orange	50	XBUT10OR
					Yellow	50	XBUT10YE
					Red	50	XBUT10RD
12 mm	4 AWG/16 mm ²	1000/101/17–4	—	600/85/16–4	Gray	50	XBUT16
					Blue	50	XBUT16BU
16 mm	0 AWG/35 mm ²	1000/150/15–0	—	600/150/14–1/0	Gray	50	XBUT35
					Blue	50	XBUT35BU

Note

① EU type—examination certificate number: KEMA 05ATEX2158 U.

Accessories

Screw Connection Single Level—Through-Feed

Description	Colour	Number of Positions	Standard Pack	XBUT25 Catalogue Number	XBUT4 Catalogue Number	XBUT6 Catalogue Number	XBUT10 Catalogue Number	XBUT16 Catalogue Number	XBUT35 Catalogue Number
End cover	Gray	—	10	XBACUT10	XBACUT10	XBACUT10	XBACUT10	XBACUT16	①
Partition plate	Gray	—	10	XBATUT10	XBATUT10	XBATUT10	XBATUT10	—	—
Plug-in bridge— for cross connections in the bridge shaft	Red	2	10	XBAFBS25	XBAFBS26	XBAFBS28	XBAFBS210	XBAFBS212	XBAFBS216
		3	10	XBAFBS35	XBAFBS36	—	—	—	—
		5	10	XBAFBS55	XBAFBS56	—	—	—	—
		10	10	XBAFBS105	XBAFBS106	—	—	—	—
		50	10	XBAFBS505	XBAFBS506	—	—	—	—
Test adapter	—	—	10	XBATSPAI4	XBATSPAI4	XBATSPAI4	—	—	—
2.3 mm diameter test plug	—	—	—	XBATSMPS- ①	XBATSMPS- ①	—	—	—	—
Modular test plug	—	—	10	XBATSPS5	XBATSPS6	XBATSPS8	—	—	—
Blank marker strip (strip of 10)	White	—	10	XBMZB5 ②	XBMZB6 ②	XBMZB8 ②	XBMZB10 ②	XBMZB12 ②	XBMZB15 ②

Notes① For ordering information, see **Page T42-105**.② For information on Printed Marking Tag Options, see **Page T42-98**.For additional accessories, see **Page T42-90**.

42.1

Terminal Blocks, Fuse Blocks and Fuse Holders

IEC—XB Series

42

XBUT with Reducing Bridge

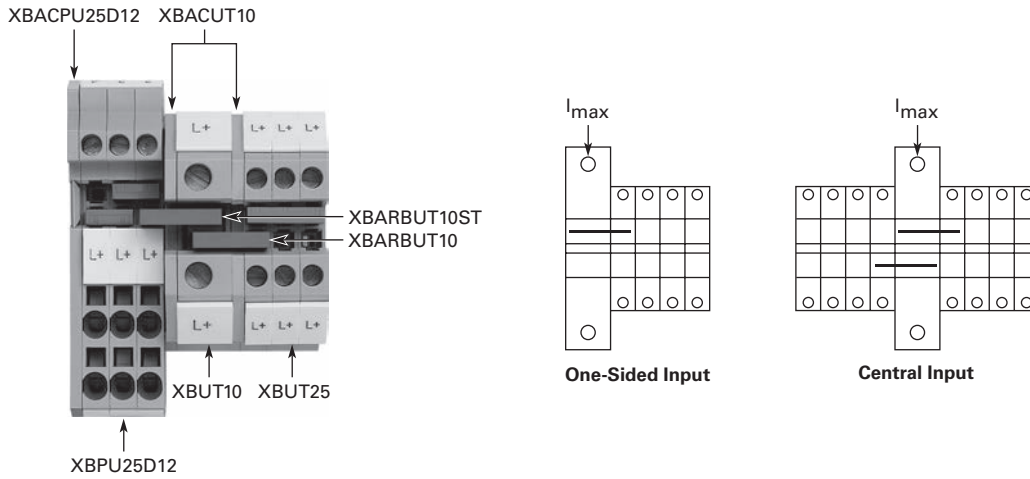

Step-Down Bridge with Standard Feed-Through Terminal Blocks

Input Terminal Blocks	Cross-Section	Pick-Off Terminal Blocks	Cross-Section AWG (mm ²)	One-Sided Input I_{max}	Central Input I_{max}	Bridge Catalogue Number
XBUT10	6 AWG (10 mm ²)	XBUT25	12 (2.5)	40	65	XBARBUT10
		XBUT4	10 (4)	45	65	XBARBUT10
		XBPT25	12 (2.5)	40	65	XBARBUT10ST
		XBPT4	10 (4)	45	65	XBARBUT10ST
		XBQT15	14 (1.5)	35	65	XBARBUT10ST
		XBQT25	12 (2.5)	40	65	XBARBUT10ST
XBUT16	4 AWG (16 mm ²)	XBUT25	12 (2.5)	40	80	XBARBUT16
		XBUT4	10 (4)	45	90	XBARBUT16
		XBPT25	12 (2.5)	40	80	XBARBUT16ST
		XBPT4	10 (4)	45	90	XBARBUT16ST
		XBQT15	14 (1.5)	35	70	XBARBUT16ST
		XBQT25	12 (2.5)	40	80	XBARBUT16ST

Technical Data and Specifications

Screw Connection Single Level—Through-Feed

Description	XBUT25	XBUT4	XBUT6	XBUT10	XBUT16	XBUT35
Technical Data in Accordance with IEC						
Maximum load current in A/cross-section in mm ²	32/4	41/6	57/10	76/16	101/25	150/50
Rated surge voltage in kV/contamination class	8/3	8/3	8/3	8/3	8/3	8/3
Surge voltage category/insulating material group	III/II	III/I	III/I	III/I	III/I	III/I
Connection Capacity						
Stranded with ferrule/with ferrule and plastic sleeve in mm ²	0.25–2.5/0.25–2.5	0.25–4/0.25–4	0.25–6/0.25–6	0.5–10/0.5–10	1.0–16/1.0–16	1.5–35/1.5–35
Multi-Conductor Connection (same cross-section)						
Solid/stranded in mm ²	0.14–1.5/0.14–1.5	0.14–1.5/0.14–1.5	0.2–2.5/0.2–2.5	0.5–4/0.5–4	1.0–6/1.0–4	1.5–16/1.5–10
Stranded with ferrules without plastic sleeve in mm ²	0.25–1.5	0.25–1.5	0.25–1.5	0.5–2.5	1.0–4	1.5–10
Stranded with twin ferrule with plastic sleeve in mm ²	0.5–1.5	0.5–2.5	0.5–4	0.5–6	0.75–10	1.5–10
Stripping length in inches (mm)	0.35 (9)	0.35 (9)	0.39 (10)	0.39 (10)	0.39 (10)	0.63 (16)
Thread	M3	M3	M4	M4	M5	M6
Torque in in-lb (Nm)	5.3–7.1 (0.6–0.8)	5.3–7.1 (0.6–0.8)	13.3–15.9 (1.5–1.8)	13.3–15.9 (1.5–1.8)	22.1–26.6 (2.5–3)	28.3–32.7 (3.2–3.7)

Dimensions

Approximate Dimensions in Inches (mm)

Screw Connection Single Level—Through-Feed

Catalogue Number	Width	Length	Cover Width	Height for—	
				35 x 7.5 in	35 x 15 in
XBUT25	0.20 (5.2)	1.85 (46.9)	0.09 (2.2)	1.87 (47.5)	2.17 (55.0)
XBUT4	0.24 (6.2)	1.85 (46.9)	0.09 (2.2)	1.87 (47.5)	2.17 (55.0)
XBUT6	0.32 (8.2)	1.85 (46.9)	0.09 (2.2)	1.87 (47.5)	2.17 (55.0)
XBUT10	0.40 (10.2)	1.85 (46.9)	0.09 (2.2)	1.87 (47.5)	2.17 (55.0)
XBUT16	0.47 (12.0)	2.08 (52.8)	0.09 (2.2)	2.16 (54.8)	2.45 (62.3)
XBUT35	0.63 (16.0)	2.37 (60.2)	—	2.59 (65.7)	2.88 (73.2)

Notes

- ① XBUT35 has an enclosed design. The use of an end cover is not required.
- ② For information on Printed Marking Tag Options, see **Page T42-98**.

42.1

Terminal Blocks, Fuse Blocks and Fuse Holders

IEC—XB Series

Single Level—Ground Blocks

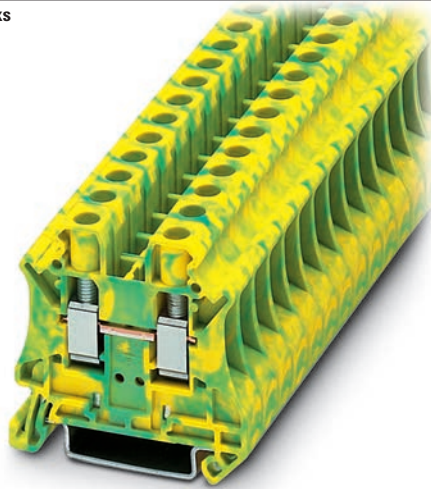

Contents

<i>Description</i>	<i>Page</i>
Single Level—Through-Feed	T42-5
Single Level—Ground Blocks	
Accessories	T42-11
Technical Data and Specifications	T42-11
Dimensions	T42-11
Multi-Conductor Terminal Blocks	T42-12
Multi-Conductor Ground Blocks	T42-14
Double Level	T42-16
Triple Level Sensor/Actuator	T42-18
Fuse Terminal Blocks	T42-21
Disconnect and Component Terminal Blocks	T42-24
High Current Blocks	T42-27
Mini Screw Connection	T42-29

42

Single Level—Ground Blocks

Product Description

The ground terminal blocks have the same shape and pitch as the standard terminal block, in a green-yellow housing. They easily snap

onto the DIN rail to make a reliable mechanical and electrical contact that meets all requirements of IEC 60-947-7-2.

Product Selection

XBUT6PE



Screw Connection Single Level—Ground Blocks

Terminal Width	Maximum Wire Size	IEC 60 947-7-1 in V/A/AWG	EN 50 019 ① in V/A/AWG	UL-cUL Ratings in V/A/AWG	Colour	Standard Pack	Catalogue Number
5.2 mm	12 AWG/2.5 mm ²	—/—/26-12	—/—/26-12	—/—/26-12	Green/Yellow	50	XBUT25PE
6.2 mm	10 AWG/4 mm ²	—/—/26-10	—/—/26-10	—/—/26-10	Green/Yellow	50	XBUT4PE
8.2 mm	8 AWG/6 mm ²	—/—/24-8	—/—/24-8	—/—/24-8	Green/Yellow	50	XBUT6PE
10.2 mm	6 AWG/10 mm ²	—/76/20-6	—/54/69/20-6	—/—/20-6	Green/Yellow	50	XBUT10PE
12 mm	4 AWG/16 mm ²	—/101/15-4	—	—/—/16-4	Green/Yellow	50	XBUT16PE
16 mm	2 AWG/35 mm ²	—/125/15-2	—	—/—/14-1/0	Green/Yellow	50	XBUT35PE

Note

① EU type—examination certificate number: KEMA 05ATEX2158 U.

Accessories

Screw Connection Single Level—Ground Blocks

Description	Colour	Number of Positions	Standard Pack	XBUT25PE Catalogue Number	XBUT4PE Catalogue Number	XBUT6PE Catalogue Number	XBUT10PE Catalogue Number	XBUT16PE Catalogue Number	XBUT35PE Catalogue Number
End cover	Gray	—	10	XBACUT10	XBACUT10	XBACUT10	XBACUT10	XBACUT16	③
Partition plate	—	—	10	XBATUT10	XBATUT10	XBATUT10	XBATUT10	—	—
Plug-in bridge— for cross connections in the bridge shaft	Red	2	10	XBAFBS25	XBAFBS26	XBAFBS28	XBAFBS210	XBAFBS212	XBAFBS212
		3	10	XBAFBS35	XBAFBS36	—	—	—	—
		5	10	XBAFBS55	XBAFBS56	—	—	—	—
		10	10	XBAFBS105	XBAFBS106	—	—	—	—
		50	10	XBAFBS505	XBAFBS506	—	—	—	—
Test adapter	—	—	10	XBATSPAI4	XBATSPAI4	XBATSPAI4	—	—	—
2.3 mm diameter test plug	—	—	—	XBATSMPS_①	XBATSMPS_①	—	—	—	—
Modular test plug	—	—	10	XBATSPS5	XBATSPS6	XBATSPS8	—	—	—
Blank marker strip (strip of 10)	White	—	10	XBMZB5 ②	XBMZB6 ②	XBMZB8 ②	XBMZB10 ②	XBMZB12 ②	XBMZB15 ②

Technical Data and Specifications

Screw Connection Single Level—Ground Blocks

Description	XBUT25PE	XBUT4PE	XBUT6PE	XBUT10PE	XBUT16PE	XBUT35PE
Technical Data in Accordance with IEC						
Maximum load current in A/cross-section in mm ²	—	—	—	76/16	101/25	125/50
Rated surge voltage in kV/contamination class	8/3	8/3	8/3	8/3	8/3	8/3
Surge voltage category/insulating material group	III/II	III/I	III/I	III/I	III/I	III/I
Connection Capacity						
Stranded with ferrule/with ferrule and plastic sleeve in mm ²	0.25–2.5/0.25–2.5	0.25–4/0.25–4	0.25–6/0.25–6	0.5–10/0.5–10	1.0–16/1.0–16	1.5–35/1.5–35
Multi-Conductor Connection (same cross-section)						
Solid/stranded in mm ²	0.14–1.5/0.14–1.5	0.14–1.5/0.14–1.5	0.2–2.5/0.2–2.5	0.5–4/0.5–4	1.0–6/1.0–4	1.5–16/1.5–10
Stranded with ferrules without plastic sleeve in mm ²	0.25–1.5	0.25–1.5	0.25–1.5	0.5–2.5	1.0–4	1.5–10
Stranded with twin ferrule with plastic sleeve in mm ²	0.5–1.5	0.5–2.5	0.5–4	0.5–6	0.75–10	1.5–10
Stripping length in inches (mm)	0.35 (9)	0.35 (9)	0.39 (10)	0.39 (10)	0.39 (10)	0.63 (16)
Thread	M3	M3	M4	M4	M5	M6
Torque in in-lb (Nm)	5.3–7.1 (0.6–0.8)	5.3–7.1 (0.6–0.8)	13.3–15.9 (1.5–1.8)	13.3–15.9 (1.5–1.8)	22.1–26.6 (2.5–3)	28.3–32.7 (3.2–3.7)

Dimensions

Approximate Dimensions in Inches (mm)

Screw Connection Single Level—Ground Blocks

Catalogue Number	Width	Length	Cover Width	Height for—	
				35 x 7.5 in	35 x 15 in
XBUT25PE	0.20 (5.2)	1.85 (46.9)	0.09 (2.2)	1.87 (47.5)	2.17 (55.0)
XBUT4PE	0.24 (6.2)	1.85 (46.9)	0.09 (2.2)	1.87 (47.5)	2.17 (55.0)
XBUT6PE	0.32 (8.2)	1.85 (46.9)	0.09 (2.2)	1.87 (47.5)	2.17 (55.0)
XBUT10PE	0.40 (10.2)	1.85 (46.9)	0.09 (2.2)	1.87 (47.5)	2.17 (55.0)
XBUT16PE	0.47 (12.0)	2.08 (52.8)	0.09 (2.2)	2.16 (54.8)	2.45 (62.3)
XBUT35PE	0.63 (16.0)	2.37 (60.2)	—	2.59 (65.7)	2.88 (73.2)

Notes

- ① For ordering information, see [Page T42-105](#).
- ② For information on Printed Marking Tag Options, see [Page T42-98](#).
- ③ XBUT35PE has an enclosed design. The use of an end cover is not required.

For additional accessories, see [Page T42-90](#).

Multi-Conductor Terminal Blocks

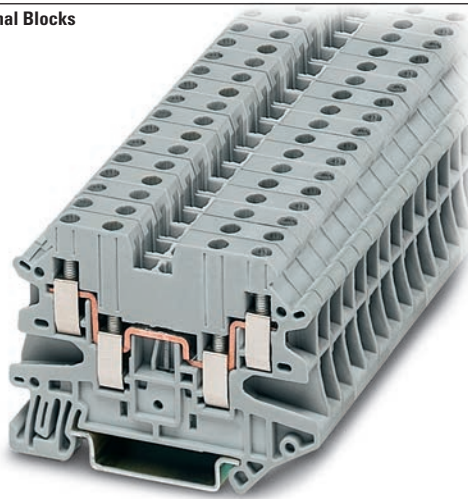

42

Contents

Description	Page
Single Level—Through-Feed	T42-5
Single Level—Ground Blocks	T42-10
Multi-Conductor Terminal Blocks	
Accessories	T42-13
Technical Data and Specifications	T42-13
Dimensions	T42-13
Multi-Conductor Ground Blocks	T42-14
Double Level	T42-16
Triple Level Sensor/Actuator	T42-18
Fuse Terminal Blocks	T42-21
Disconnect and Component Terminal Blocks	T42-24
High Current Blocks	T42-27
Mini Screw Connection	T42-29

Multi-Conductor Terminal Blocks

Product Description

The multi-conductor terminal blocks offer a space-saving alternative to standard feed-through terminal blocks allowing for high density wiring. Often, three

connections have to be led to one terminal block. The XBUT...D12 terminal block accomplishes this without any additional terminal blocks or bridging required.

The XBUT...D22 terminal blocks allow four wires to be connected to one potential—and can therefore be used as compact power distributors.

Product Selection

XBUT25D12

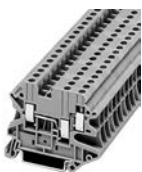

Screw Connection Multi-Conductor Terminal Blocks, Three-Wire

Terminal Width	Maximum Wire Size	IEC 60 947-7-1 in V/A/AWG	UL-cUL Ratings in V/A/AWG	Colour	Standard Pack	Catalogue Number
5.2 mm	12 AWG/2.5 mm ²	500/28/26-12	150/20/26-12	Gray	50	XBUT25D12
				Blue	50	XBUT25D12BU
6.2 mm	10 AWG/4 mm ²	500/39/26-10	150/30/26-10	Gray	50	XBUT4D12
				Blue	50	XBUT4D12BU

XBUT4D22

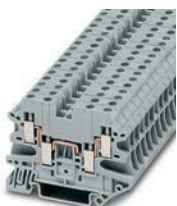

Screw Connection Multi-Conductor Terminal Blocks, Four-Wire

Terminal Width	Maximum Wire Size	IEC 60 947-7-1 in V/A/AWG	UL-cUL Ratings in V/A/AWG	Colour	Standard Pack	Catalogue Number
5.2 mm	12 AWG/2.5 mm ²	500/28/26-12	150/20/26-12	Gray	50	XBUT25D22
				Blue	50	XBUT25D22BU
6.2 mm	10 AWG/4 mm ²	500/39/26-10	150/30/26-10	Gray	50	XBUT4D22
				Blue	50	XBUT4D22BU

Accessories

Screw Connection Multi-Conductor Terminal Blocks

Description	Colour	Number of Positions	Standard Pack	XBUT25D12 Catalogue Number	XBUT4D12 Catalogue Number	XBUT25D22 Catalogue Number	XBUT4D22 Catalogue Number
End cover	Gray	—	10	XBACUT4D12	XBACUT4D12	XBACUT4D22	XBACUT4D22
End cover segment	Gray	—	10	XBASUT4	XBASUT4	XBASUT4	XBASUT4
Partition plate	—	—	10	XBATUTD12	XBATUTD12	XBATUTD22	XBATUTD22
Plug-in bridge—for cross connections in the bridge shaft	Red	2	10	XBAFBS25	XBAFBS26	XBAFBS25	XBAFBS26
		3	10	XBAFBS35	XBAFBS36	XBAFBS35	XBAFBS36
		5	10	XBAFBS55	XBAFBS56	XBAFBS55	XBAFBS56
		10	10	XBAFBS105	XBAFBS106	XBAFBS105	XBAFBS106
		50	10	XBAFBS505	XBAFBS506	XBAFBS505	XBAFBS506
Test adapter	—	—	10	XBATSPAI4	XBATSPAI4	XBATSPAI4	XBATSPAI4
2.3 mm diameter test plug	—	—	—	XBATSMPS- ^①	XBATSMPS- ^①	XBATSMPS- ^①	XBATSMPS- ^①
Modular test plug	—	—	10	XBATSPS5	XBATSPS6	XBATSPS5	XBATSPS6
Blank marker strip (strip of 10)	White	—	10	XBMZB5 ^②	XBMZB6 ^②	XBMZB5 ^②	XBMZB6 ^②

Technical Data and Specifications

Screw Connection Multi-Conductor Terminal Blocks

Description	XBUT25D12	XBUT4D12	XBUT25D22	XBUT4D22
Technical Data in Accordance with IEC				
Maximum load current in A/cross-section in mm ²	28/4	39/6	28/4	39/6
Rated surge voltage in kV/contamination class	6/3	6/3	6/3	6/3
Surge voltage category/insulating material group	III/I	III/I	III/I	III/I
Connection Capacity				
Stranded with ferrule/with ferrule and plastic sleeve in mm ²	0.25–2.5/0.25–2.5	0.25–4/0.25–4	0.25–2.5/0.25–2.5	0.25–4/0.25–4
Multi-Conductor Connection (same cross-section)				
Solid/stranded in mm ²	0.14–1.0/0.14–1.0	0.14–1.0/0.14–1.5	0.14–1.0/0.14–1.0	0.14–1.0/0.14–1.5
Stranded with ferrules without plastic sleeve in mm ²	0.25–1.0	0.25–1.5	0.25–1.0	0.25–1.5
Stranded with twin ferrule with plastic sleeve in mm ²	0.5–1.0	0.5–1.0	0.5–1.0	0.5–1.0
Stripping length in inches (mm)	0.31 (8)	0.31 (8)	0.31 (8)	0.31 (8)
Thread	M3	M3	M3	M3
Torque in in-lb (Nm)	5.3–7.1 (0.6–0.8)	5.3–7.1 (0.6–0.8)	5.3–7.1 (0.6–0.8)	5.3–7.1 (0.6–0.8)

Dimensions

Approximate Dimensions in Inches (mm)

Screw Connection Multi-Conductor Terminal Blocks

Catalogue Number	Width	Length	Cover Width	Height for—	
				35 x 7.5 in	35 x 15 in
XBUT25D12	0.20 (5.2)	2.24 (56.8)	0.09 (2.2)	1.87 (47.5)	2.17 (55.0)
XBUT4D12	0.24 (6.2)	2.24 (56.8)	0.09 (2.2)	1.87 (47.5)	2.17 (55.0)
XBUT25D22	0.20 (5.2)	2.52 (64.1)	0.09 (2.2)	1.87 (47.5)	2.17 (55.0)
XBUT4D22	0.24 (6.2)	2.52 (64.1)	0.09 (2.2)	1.87 (47.5)	2.17 (55.0)

Notes

^① For ordering information, see **Page T42-105**.

^② For information on Printed Marking Tag Options, see **Page T42-98**.

For additional accessories, see **Page T42-90**.

Multi-Conductor Ground Blocks

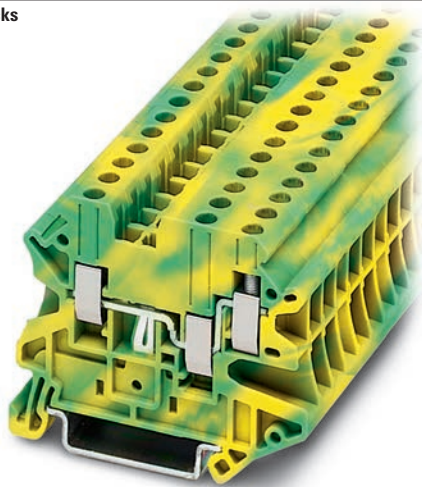

Contents

Description	Page
Single Level—Through-Feed	T42-5
Single Level—Ground Blocks	T42-10
Multi-Conductor Terminal Blocks	T42-12
Multi-Conductor Ground Blocks	
Accessories	T42-15
Technical Data and Specifications	T42-15
Dimensions	T42-15
Double Level	T42-16
Triple Level Sensor/Actuator	T42-18
Fuse Terminal Blocks	T42-21
Disconnect and Component Terminal Blocks	T42-24
High Current Blocks	T42-27
Mini Screw Connection	T42-29

Multi-Conductor Ground Blocks

Product Description

The ground terminal blocks have the same shape and pitch as the standard terminal block, in a green-yellow housing. They easily snap

onto the DIN rail to make a reliable mechanical and electrical contact that meets all requirements of IEC 60-947-7-2.

Product Selection

XBUT4D12PE

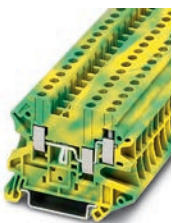

Screw Connection Multi-Conductor Ground Blocks—Three-Wire

Terminal Width	Maximum Wire Size	IEC 60 947-7-1 in V/A/AWG	UL-cUL Ratings in V/A/AWG	Colour	Standard Pack	Catalogue Number
5.2 mm	12 AWG/2.5 mm ²	—/—/26-12	—/—/26-12	Green/Yellow	50	XBUT25D12PE
6.2 mm	10 AWG/4 mm ²	—/—/26-10	—/—/26-10	Green/Yellow	50	XBUT4D12PE

XBUT25D22PE



Screw Connection Multi-Conductor Ground Blocks—Four-Wire

Terminal Width	Maximum Wire Size	IEC 60 947-7-1 in V/A/AWG	UL-cUL Ratings in V/A/AWG	Colour	Standard Pack	Catalogue Number
5.2 mm	12 AWG/2.5 mm ²	—/—/26-12	—/—/26-12	Green/Yellow	50	XBUT25D22PE
6.2 mm	10 AWG/4 mm ²	—/—/26-10	—/—/26-10	Green/Yellow	50	XBUT4D22PE

Accessories

Screw Connection Multi-Conductor Ground Blocks

Description	Colour	Number of Positions	Standard Pack	XBUT25D12PE	XBUT4D12PE	XBUT25D22PE	XBUT4D22PE
				Catalogue Number	Catalogue Number	Catalogue Number	Catalogue Number
End cover	Gray	—	10	XBACUT4D12	XBACUT4D12	XBACUT4D22	XBACUT4D22
End cover segment	Gray	—	10	XBASUT4	XBASUT4	XBASUT4	XBASUT4
Partition plate	—	—	10	XBATUTD12	XBATUTD12	XBATUTD22	XBATUTD22
Plug-in bridge—for cross connections in the bridge shaft	Red	2	10	XBAFBS25	XBAFBS26	XBAFBS25	XBAFBS26
		3	10	XBAFBS35	XBAFBS36	XBAFBS35	XBAFBS36
		5	10	XBAFBS55	XBAFBS56	XBAFBS55	XBAFBS56
		10	10	XBAFBS105	XBAFBS106	XBAFBS105	XBAFBS106
		50	10	XBAFBS505	XBAFBS506	XBAFBS505	XBAFBS506
Test adapter	—	—	10	XBATSPA14	XBATSPA14	XBATSPA14	XBATSPA14
2.3 mm diameter test plug	—	—	—	XBATSMPS-^①	XBATSMPS-^①	XBATSMPS-^①	XBATSMPS-^①
Modular test plug	—	—	10	XBATSPS5	XBATSPS6	XBATSPS5	XBATSPS6
Blank marker strip (strip of 10)	White	—	10	XBMZB5^②	XBMZB6^②	XBMZB5^②	XBMZB6^②

Technical Data and Specifications

Screw Connection Multi-Conductor Ground Blocks

Description	XBUT25D12PE	XBUT4D12PE	XBUT25D22PE	XBUT4D22PE
Technical Data in Accordance with IEC				
Maximum load current in A/cross-section in mm ²	—	—	—	—
Rated surge voltage in kV/contamination class	6/3	6/3	6/3	6/3
Surge voltage category/insulating material group	III/I	III/I	III/I	III/I
Connection Capacity				
Stranded with ferrule/with ferrule and plastic sleeve in mm ²	0.25–2.5/0.25–2.5	0.25–4/0.25–4	0.25–2.5/0.25–2.5	0.25–4/0.25–4
Multi-Conductor Connection (same cross-section)				
Solid/stranded in mm ²	0.14–1.0/0.14–1.0	0.14–1.0/0.14–1.5	0.14–1.0/0.14–1.0	0.14–1.0/0.14–1.5
Stranded with ferrules without plastic sleeve in mm ²	0.25–1.0	0.25–1.5	0.25–1.0	0.25–1.5
Stranded with twin ferrule with plastic sleeve in mm ²	0.5–1.0	0.5–1.0	0.5–1	0.5–1
Stripping length in inches (mm)	0.31 (8)	0.31 (8)	0.31 (8)	0.31 (8)
Thread	M3	M3	M3	M3
Torque in in-lb (Nm)	5.3–7.1 (0.6–0.8)	5.3–7.1 (0.6–0.8)	5.3–7.1 (0.6–0.8)	5.3–7.1 (0.6–0.8)

Dimensions

Approximate Dimensions in Inches (mm)

Screw Connection Multi-Connector Ground Blocks

Catalogue Number	Width	Length	Cover Width	Height for—	
				35 x 7.5 in	35 x 15 in
XBUT25D12PE	0.20 (5.2)	2.24 (56.8)	0.09 (2.2)	1.87 (47.5)	2.17 (55.0)
XBUT4D12PE	0.20 (5.2)	2.24 (56.8)	0.09 (2.2)	1.87 (47.5)	2.17 (55.0)
XBUT25D22PE	0.20 (5.2)	2.52 (64.1)	0.09 (2.2)	1.87 (47.5)	2.17 (55.0)
XBUT4D22PE	0.24 (6.2)	2.52 (64.1)	0.09 (2.2)	1.87 (47.5)	2.17 (55.0)

Notes

^① For ordering information, see **Page T42-105**.

^② For information on Printed Marking Tag Options, see **Page T42-98**.

For additional accessories, see **Page T42-90**.

Double Level

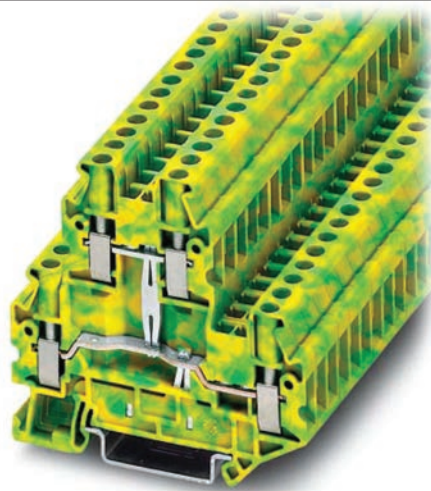

Contents

<i>Description</i>	<i>Page</i>
Single Level—Through-Feed	T42-5
Single Level—Ground Blocks	T42-10
Multi-Conductor Terminal Blocks	T42-12
Multi-Conductor Ground Blocks	T42-14
Double Level	
Accessories	T42-17
Technical Data and Specifications	T42-17
Dimensions	T42-17
Triple Level Sensor/Actuator	T42-18
Fuse Terminal Blocks	T42-21
Disconnect and Component Terminal Blocks	T42-24
High Current Blocks	T42-27
Mini Screw Connection	T42-29

Double Level

Product Description

The potentials of the XBUTT double-level terminal blocks are on two levels to reduce space requirements by 50% over single-level terminal

blocks. The XBUTT Series can be bridged on both levels for maximum flexibility. Marking can be provided at each termination point.

Product Selection

XBUTT4

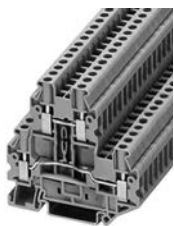

Screw Connection Double Level Blocks, XBUTT4

Terminal Width	Maximum Wire Size	IEC 60 947-7-1 in V/A/AWG	UL-cUL Ratings in V/A/AWG	Colour	Standard Pack	Catalogue Number
Screw Connection Double Level Blocks						
6.2 mm	10 AWG/4 mm ²	800/36/26–10	300/30/26–10	Gray	50	XBUTT4
				Blue	50	XBUTT4BU
				Red	50	XBUTT4RD
Screw Connection Double Level Block (terminal block with potential distribution between the levels)						
6.2 mm	10 AWG/4 mm ²	800/36/26–10	300/30/26–10	Gray	50	XBUTT4PV

XBUTT4PE



Screw Connection Double Level Ground Block, XBUTT4PE

Terminal Width	Maximum Wire Size	IEC 60 947-7-1 in V/A/AWG	UL-cUL Ratings in V/A/AWG	Colour	Standard Pack	Catalogue Number
Screw Connection Double Level—Ground Blocks						
6.2 mm	10 AWG/4 mm ²	—/—/26–10	—/—/26–10	Green/Yellow	50	XBUTT4PE

Accessories

Screw Connection Terminal/Ground Blocks, Double Level

Description	Colour	Number of Positions	Standard Pack	XBUTT4 Catalogue Number	XBUTT4PE Catalogue Number
End cover	Gray	—	10	XBACUTT4	XBACUTT4
End cover segment	Gray	—	10	XBDPUTT4	XBDPUTT4
Partition plate	—	—	10	XBATUTT4	XBATUTT4
Plug-in bridge—for cross connections in the bridge shaft	Red	2	10	XBAFBS26	XBAFBS26
		3	10	XBAFBS36	XBAFBS36
		5	10	XBAFBS56	XBAFBS56
		10	10	XBAFBS106	XBAFBS106
		50	10	XBAFBS506	XBAFBS506
Test adapter	—	—	10	XBATSPA14	XBATSPA14
2.3 mm diameter test plug	—	—	—	XBATSMPS- ^①	XBATSMPS- ^①
Modular test plug	—	—	10	XBATSPS6	XBATSPS6
Blank marker strip (strip of 10)	White	—	10	XBMZB6 ^②	XBMZB6 ^②

Technical Data and Specifications

Screw Connection Double Level

Description	XBUTT4	XBUTT4PE
Technical Data in Accordance with IEC		
Maximum load current in A/cross-section in mm ²	30/6	—/6
Rated surge voltage in kV/contamination class	8/3	6/3
Surge voltage category/insulating material group	III/I	III/I
Connection Capacity		
Stranded with ferrule/with ferrule and plastic sleeve in mm ²	0.25–4/0.25–4	0.25–4/0.25–4
Multi-Conductor Connection (same cross-section)		
Solid/stranded in mm ²	0.14–1.5/0.14–1.5	0.14–1.5/0.14–1.5
Stranded with ferrules without plastic sleeve in mm ²	0.25–1.5	0.25–1.5
Stranded with twin ferrule with plastic sleeve in mm ²	0.5–2.5	0.5–2.5
Stripping length in inches (mm)	0.35 (9)	0.35 (9)
Thread	M3	M3
Torque in in-lb (Nm)	5.3–7.1 (0.6–0.8)	5.3–7.1 (0.6–0.8)

Dimensions

Approximate Dimensions in Inches (mm)

Screw Connection Double Level

Catalogue Number	Width	Length	Cover Width	Height for—	
				35 x 7.5 in	35 x 15 in
XBUTT4	0.24 (6.2)	2.75 (69.9)	0.09 (2.2)	2.56 (65.0)	2.85 (72.5)
XBUTT4PE	0.24 (6.2)	2.75 (69.9)	0.09 (2.2)	2.56 (65.0)	2.85 (72.5)

Notes

① For ordering information, see **Page T42-105**.

② For information on Printed Marking Tag Options, see **Page T42-98**.

For additional accessories, see **Page T42-90**.

Triple Level Sensor/Actuator

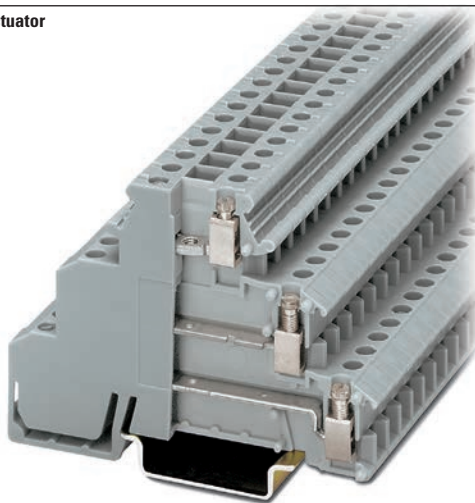

Contents

Description	Page
Single Level—Through-Feed	T42-5
Single Level—Ground Blocks	T42-10
Multi-Conductor Terminal Blocks	T42-12
Multi-Conductor Ground Blocks	T42-14
Double Level	T42-16
Triple Level Sensor/Actuator	
Accessories	T42-19
Technical Data and Specifications	T42-20
Dimensions	T42-20
Fuse Terminal Blocks	T42-21
Disconnect and Component Terminal Blocks	T42-24
High Current Blocks	T42-27
Mini Screw Connection	T42-29

Triple Level Sensor/Actuator

Product Description

The XB3UK sensor terminal blocks reduce installation time by terminating three-wire devices such as photoelectric and proximity sensors in a single terminal block. The XB3UK Series accommodates a design where the positive and negative connections are

grouped so that only the signal lines and one pair of wires for the power supply need to be wired between the terminal box and the control. The upper level accommodates the markable feed-through terminals for the signal line. The two lower terminal points can be

bridged. These are used for the sensor power supply. The positive and negative potential can be fed into the bridges with XB3UKF25. The first sensor can also be connected to this three-wire feed-through block.

Product Selection

XB3UKA25

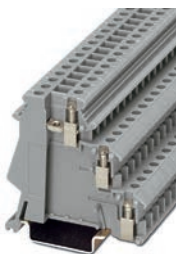

Screw Connection Triple Level Sensor/Actuator

Terminal Width	Maximum Wire Size	Connection Data in V/A/AWG	IEC 60 947-7-1 in V/A/AWG	UL-cUL Ratings in V/A/AWG	Colour	Standard Pack	Catalogue Number
Screw Connection Triple Level							
6.2 mm	14 AWG/2.5 mm ²	250/26/24-12	—	300/15/30-14	Gray	50	XB3UKA25
Screw Connection Triple Level with Red LED, 15-30 Vdc, 2.5-7.5A							
6.2 mm	14 AWG/2.5 mm ²	250/26/24-12	—	300/15/30-14	Gray	50	XB3UKA25L24

XB3UKF25



Screw Connection Triple Level Sensor/Actuator

Terminal Width	Maximum Wire Size	Connection Data in V/A/AWG	IEC 60 947-7-1 in V/A/AWG	UL-cUL Ratings in V/A/AWG	Colour	Standard Pack	Catalogue Number
Screw Connection Triple Level							
6.2 mm	14 AWG/2.5 mm ²	—	250/30/24-12	300/15/30-14	Gray	50	XB3UKF25

XB3UKA25PE



Screw Connection Triple Level Sensor/Actuator

Terminal Width	Maximum Wire Size	Connection Data in V/A/AWG	UL-cUL Ratings in V/A/AWG	Colour	Standard Pack	Catalogue Number
Screw Connection Triple Level						
6.2 mm	14 AWG/2.5 mm ²	250/26/24–12	300/15/30–14	Gray	50	XB3UKA25PE
Screw Connection Triple Level with Red LED, 15–30 Vdc, 2.5–7.5A						
6.2 mm	14 AWG/2.5 mm ²	250/26/24–12	300/15/30–14	Gray	50	XB3UKA25PEL24

XB3UKF25PE

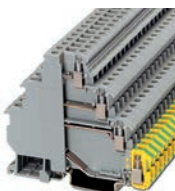

Screw Connection Triple Level Sensor/Actuator

Terminal Width	Maximum Wire Size	Connection Data in V/A/AWG	UL-cUL Ratings in V/A/AWG	Colour	Standard Pack	Catalogue Number
Screw Connection Triple Level						
6.2 mm	14 AWG/2.5 mm ²	—	300/15/30–14	Gray	50	XB3UKF25PE

Accessories

Screw Connection Triple Level Sensor/Actuator

Description	Colour	Number of Positions	Standard Pack	XB3UKA25	XB3UKF25	XB3UKA25PE	XB3UKF25PE
				Catalogue Number	Catalogue Number	Catalogue Number	Catalogue Number
Insertion bridge	Blue	80	1	XBAEB80DIKB	XBAEB80DIKB	XBAEB80DIKB	XBAEB80DIKB
	Red	80	1	XBAEB80DIKR	XBAEB80DIKR	XBAEB80DIKR	XBAEB80DIKR
Insertion bridge	Blue	10	10	XBAEB10DIKB	XBAEB10DIKB	XBAEB10DIKB	XBAEB10DIKB
	Red	10	10	XBAEB10DIKR	XBAEB10DIKR	XBAEB10DIKR	XBAEB10DIKR
Blank marker strip (strip of 10)	White	—	10	XBMZB6 ①	XBMZB6 ②	XBMZB6 ②	XBMZB6 ②

Notes

① For information on Printed Marking Tag Options, see **Page T42-98**.

For additional accessories, see **Page T42-90**.

Technical Data and Specifications

Screw Connection Triple Level Sensor/Actuator

Description	XB3UKA25	XB3UKF25	XB3UKA25PE	XB3UKF25PE
Technical Data in Accordance with IEC				
Maximum load current in A/cross-section in mm ²	26/2.5	30/4	26/2.5	26/2.5
Maximum cross section with insertion bridge solid/stranded in mm ²	4/2.5	4/2.5	4/2.5	4/2.5
Rated surge voltage in kV/contamination class	4/3	4/3	4/3	6/3
Surge voltage category/insulating material group	III/1	III/1	III/1	III/1
Connection Capacity				
Stranded with ferrule/with ferrule and plastic sleeve in mm ²	0.25–2.5/0.25–2.5	0.25–2.5/0.25–2.5	0.25–2.5/0.25–2.5	0.25–2.5/0.25–2.5
Multi-Conductor Connection (same cross-section)				
Solid/stranded in mm ²	0.2–1.0/0.2–1.0	0.2–1.0/0.2–1.0	0.2–1.0/0.2–1.0	0.2–1.0/0.2–1.0
Stranded with ferrules without plastic sleeve in mm ²	0.25–1.0	0.25–1.0	0.25–1.0	0.25–1.0
Stranded with twin ferrule with plastic sleeve in mm ²	0.5–1.0	0.5–1.0	0.5–1.0	0.5–1.0
Stripping length in inches (mm)	0.31 (8)	0.31 (8)	0.31 (8)	0.31 (8)
Thread	M3	M3	M3	M3
Torque in in-lb (Nm)	4.4–5.3 (0.5–0.6)	4.4–5.3 (0.5–0.6)	4.4–5.3 (0.5–0.6)	4.4–5.3 (0.5–0.6)

Wiring for Three-Level Sensor Terminal Blocks

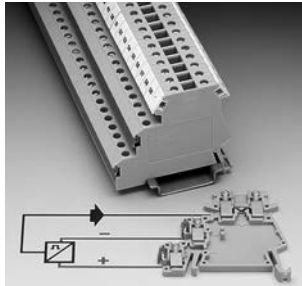

Wiring for Four-Level Sensor Terminal Blocks

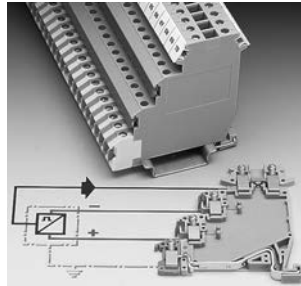

Dimensions

Approximate Dimensions in Inches (mm)

Screw Connection Triple Level Sensor/Actuator

Catalogue Number	Width	Length	Height for—	
			35 x 7.5 in	35 x 15 in
XB3UKA25	0.24 (6.2)	2.17 (55.0)	2.15 (54.5)	2.44 (62.0)
XB3UKF25	0.24 (6.2)	2.85 (72.5)	2.15 (54.5)	2.44 (62.0)
XB3UKA25PE	0.24 (6.2)	2.46 (62.5)	2.76 (70.0)	3.05 (77.5)
XB3UKF25PE	0.24 (6.2)	3.25 (82.5)	2.76 (70.0)	3.05 (77.5)

Fuse Terminal Blocks



Contents

Description	Page
Single Level—Through-Feed	T42-5
Single Level—Ground Blocks	T42-10
Multi-Conductor Terminal Blocks	T42-12
Multi-Conductor Ground Blocks	T42-14
Double Level.....	T42-16
Triple Level Sensor/Actuator	T42-18
Fuse Terminal Blocks	
Accessories	T42-23
Technical Data and Specifications	T42-23
Dimensions	T42-23
Disconnect and Component Terminal Blocks	T42-24
High Current Blocks	T42-27
Mini Screw Connection	T42-29

Fuse Terminal Blocks

Product Description

The UT Series fuse terminal blocks come in two varieties—lever type and cap. Each performs two functions. They act as a fuse carrier for most common North American and European fuses and they

allow for potential distribution with the double bridge shaft. The terminal blocks therefore allow bypass routing of two separate potentials next to each other. This has the advantage of a time-saving

potential infeed and a correct, functional configuration of the terminal strip. For signaling a triggered fuse, fuse terminal blocks with light indicators are available (for both AC and DC voltage).

Product Selection

XBUT4FBE



Screw Connection Fuse Terminal Blocks, for 5 x 20 mm Fuse

Terminal Width	Maximum Wire Size	IEC 60 947-7-3 in V/A/AWG	UL-cUL Ratings in V/A/AWG	Colour	Standard Pack	Catalogue Number
Fuse Terminal Blocks						
6.2 mm	10 AWG/4 mm ²	①/6.3/26–10	600/6.3/26–10	Black	50	XBUT4FBE
Fuse Terminal Blocks with LED 12–30V, 1–2.5 mA						
6.2 mm	10 AWG/4 mm ²	①/6.3/26–10	600/6.3/26–10	Black	50	XBUT4FBEL24
Fuse Terminal Blocks with LED 30–60V, 0.8–2.0 mA						
6.2 mm	10 AWG/4 mm ²	①/6.3/26–10	600/6.3/26–10	Black	50	XBUT4FBEL60
Fuse Terminal Blocks with LED 110–250V, 0.5–2.5 mA						
6.2 mm	10 AWG/4 mm ²	①/6.3/26–10	600/6.3/26–10	Black	50	XBUT4FBEL250

Note

① As disconnect terminal block 400V, as fuse terminal block 250V.

XBUT6FBN



Screw Connection Fuse Terminal Blocks for 6.3 x 32 mm (1/4 in x 1-1/4 in) Fuse

Terminal Width	Maximum Wire Size	IEC 60 947-7-3 in V/A/AWG	UL-cUL Ratings in V/A/AWG	Colour	Standard Pack	Catalogue Number
Fuse Terminal Blocks						
8.2 mm	8 AWG/6 mm ²	①/10/24-8	400/10/24-8	Black	50	XBUT6FBN
Fuse Terminal Blocks with LED 12-30V, 1-2.5 mA						
8.2 mm	8 AWG/6 mm ²	①/10/24-8	400/10/24-8	Black	50	XBUT6FBNL24
Fuse Terminal Blocks with LED 30-60V, 0.8-2.0 mA						
8.2 mm	8 AWG/6 mm ²	①/10/24-8	400/10/24-8	Black	50	XBUT6FBNL60
Fuse Terminal Blocks with LED 110-250V, 0.5-2.5 mA						
8.2 mm	8 AWG/6 mm ²	①/10/24-8	400/10/24-8	Black	50	XBUT6FBNL250

XBUK10FBCE



Screw Connection Fuse Terminal Blocks, XBUK10FBC

Terminal Width	Maximum Wire Size	IEC 60 947-7-3 with Fuse in V/A/AWG	IEC 60 947-7-3 as Disconnected t.b. in V/A/AWG	UL-cUL Ratings in V/A/AWG	Colour	Standard Pack	Catalogue Number
Fuse Terminal Blocks for 5 x 20 mm fuse							
12 mm	6 AWG/16 mm ²	①/①/20-4	800/10/20-6	300/20/22-6	Black	50	XBUK10FBCE
Fuse Terminal Blocks for 6.3 x 32 mm (1/4 in x 1-1/4 in) fuse							
12 mm	6 AWG/16 mm ²	①/①/20-4	800/10/20-6	300/20/22-6	Black	50	XBUK10FBCN
Fuse Terminal Blocks with Light Indicator 15-30V, 1-2.5 mA, 5 x 20 mm							
12 mm	6 AWG/16 mm ²	①/①/20-4	800/10/20-6	300/20/22-6	Black	50	XBUK10FBCEL24
Fuse Terminal Blocks with Light Indicator 15-30V, 1-2.5 mA, 6.3 x 32 mm							
12 mm	6 AWG/16 mm ²	①/①/20-4	800/10/20-6	300/20/22-6	Black	50	XBUK10FBCNL24
Fuse Terminal Blocks with Light Indicator 110-250V, 0.5-1.1A, 5 x 20 mm							
12 mm	6 AWG/16 mm ²	①/①/20-4	800/10/20-6	300/20/22-6	Black	50	XBUK10FBCEL250
Fuse Terminal Blocks with Light Indicator 110-250V, 0.5-1.1A, 6.3 x 32 mm							
12 mm	6 AWG/16 mm ²	①/①/20-4	800/10/20-6	300/20/22-6	Black	50	XBUK10FBCNL250

Cartridge Fuse Inserts 5 x 20 mm Based on DIN EN 60 947-7-3: 2003-7

Terminal Blocks	U (V)	Overload Protection		Short-Circuit Protection Only		I _{max.} (A)
		Individual	Interconnected	Individual	Interconnected	
XBUT4FBE	250	1.6W	1.6W	4W	2.5W	6.3

Notes

Max. power dissipation at 73.4°F (23°C) based on DIN EN 60 947-7-3: 2003-7.

When selecting cartridge fuse inserts, please ensure that the maximum power dissipation specified above is not exceeded. Details can be obtained from the fuse suppliers.

If the fuse is defective, the downstream circuit is not off load.

① As disconnect terminal block 500V, as fuse terminal block 400V.

Accessories

Screw Connection Fuse Terminal Blocks

Description	Colour	Number of Positions	Standard Pack	XBUT4FBE Catalogue Number	XBUT6FBN Catalogue Number	XBUK10FBCE Catalogue Number
End cover	—	—	—	①	①	—
Plug-in bridge—for cross connections in the bridge shaft	Red	2	10	XBAFBS26	XBAFBS28	—
		3	10	XBAFBS36	XBAFBS38	—
		5	10	XBAFBS56	XBAFBS58	—
		10	10	XBAFBS106	XBAFBS108	—
		50	10	XBAFBS506	—	—
Blank marker strip centre labeling (strip of 10)	White	—	—	XBMZB5 ②	XBMZB6 ②	—
Blank marker strip external labeling (strip of 10)	White	—	—	XBMZB6 ②	XBMZB8 ②	—
Fixed bridge	—	2	10	—	—	XBAFBI212
Screw heads with insulating collar	—	10	10	—	—	XBAFBI1012
Blank marker strip (strip of 10)	White	—	10	—	—	XBMZB6 ②

Technical Data and Specifications

Screw Connection Fuse Terminal Blocks

Description	XBUT4FBE	XBUT4FBN	XBUK10FBCE
Technical Data in Accordance with IEC			
Fuse type/dimensions in (mm)	—	—	G/5 x 20/5 x 25/6.3 x 32
Maximum cross section with insertion bridge solid/stranded in mm ²	6.3/6	10/10	10/10
Rated surge voltage in kV/contamination class	4/3	4/3	4/3
Surge voltage category/insulating material group	III/II	III/II	III/I
Connection Capacity			
Stranded with ferrule/with ferrule and plastic sleeve in mm ²	0.25–4/0.25–4	0.25–6/0.25–6	0.5–10/0.5–10
Multi-Conductor Connection (same cross-section)			
Solid/stranded in mm ²	0.14–1.5/0.14–1.5	—	0.5–4/0.5–4
Stranded with ferrules without plastic sleeve in mm ²	0.25–1.5	—	0.5–4
Stranded with twin ferrule with plastic sleeve in mm ²	0.5–2.5	0.5–4	0.5–10
Stripping length in inches (mm)	0.35 (9)	0.39 (10)	0.43 (11)
Thread	M3	M4	M4
Torque in in-lb (Nm)	5.3–7.1 (0.6–0.8)	13.3–15.9 (1.5–1.8)	13.3–15.9 (1.5–1.8)

Dimensions

Approximate Dimensions in Inches (mm)

Screw Connection Fuse Terminal Blocks

Catalogue Number	Width	Length	Height for—		
			35 x 7.5 in	35 x 15 in	32 in
XBUT4FBE	0.24 (6.2)	2.24 (56.8)	2.87 (73.0)	3.17 (80.5)	—
XBUT4FBN	0.32 (8.2)	2.24 (56.8)	2.87 (73.0)	3.17 (80.5)	—
XBUK10FBCE	0.47 (12.0)	2.44 (62.0)	2.32 (59.0)	2.62 (66.5)	2.52 (64.0)

Notes

① XBUT4FBE and XBUT6FBN have an enclosed design. The use of an end cover is not required.

② For information on Printed Marking Tag Options, see **Page T42-98**.

For additional accessories, see **Page T42-90**.

Disconnect and Component Terminal Blocks

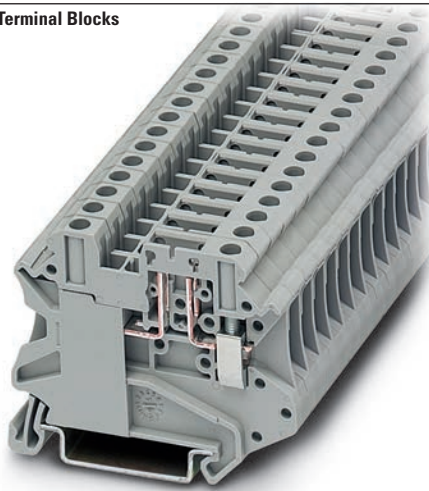

42

Contents

<i>Description</i>	<i>Page</i>
Single Level—Through-Feed	T42-5
Single Level—Ground Blocks	T42-10
Multi-Conductor Terminal Blocks	T42-12
Multi-Conductor Ground Blocks	T42-14
Double Level	T42-16
Triple Level Sensor/Actuator	T42-18
Fuse Terminal Blocks	T42-21
Disconnect and Component Terminal Blocks	
Product Selection	T42-25
Accessories	T42-26
Technical Data and Specifications	T42-26
Dimensions	T42-26
High Current Blocks	T42-27
Mini Screw Connection	T42-29

Disconnect and Component Terminal Blocks

Product Description

The **XB** Series includes application specific terminal blocks like the XBUT4TG disconnect block that accommodates disconnect component and fuse terminal blocks. It can also be bridged with standard terminal blocks via the double bridge shaft. The component plug XBPCO serves to accommodate different components such as resistors or capacitors.

5 x 20 mm fuses can be inserted into the fuse plug XBPFU, also available with light indication. The XBUT4MT knife disconnect terminal block features a compact design and a high current carrying capacity of 16A. Versions with test socket screws provide a test option for 2.3 mm diameter test plugs on both sides of the disconnect point.

Product Selection

XBUT4TG
Disconnect

Screw Connection Disconnect and Component Terminal Blocks

Terminal Width	Maximum Wire Size	Connection Data in V/A/AWG	UL-cUL Ratings for Disconnect in V/A/AWG	UL-cUL Ratings for Disconnect with Test Sockets in V/A/AWG	Colour	Standard Pack	Catalogue Number
Screw Connection Disconnect							
6.2 mm	10 AWG/4 mm ²	500/16/26–10	600/16/26–10	300/16/26–10	Gray	50	XBUT4TG
Screw Connection Disconnect with Test Sockets							
6.2 mm	10 AWG/4 mm ²	500/16/26–10	600/16/26–10	300/16/26–10	Gray	50	XBUT4TGP
Component Plug							
6.2 mm	10 AWG/4 mm ²	500/16/26–10	600/16/26–10	300/16/26–10	Gray	10	XBPCO
Fuse Plug							
6.2 mm	10 AWG/4 mm ²	500/16/26–10	600/16/26–10	300/16/26–10	Black	10	XBPFU
Fuse Plug with Light Indicator for 12–30V, 1–2.5 mA							
6.2 mm	10 AWG/4 mm ²	500/16/26–10	600/16/26–10	300/16/26–10	Black	10	XBPFUL24
Fuse Plug with Light Indicator for 110–250V, 0.5–2.5 mA							
6.2 mm	10 AWG/4 mm ²	500/16/26–10	600/16/26–10	300/16/26–10	Black	10	XBPFUL250
Screw Connection Disconnect Knife Disconnect							
6.2 mm	10 AWG/4 mm ²	500/16/26–10	600/16/26–10	300/16/26–10	Gray	50	XBUT4MT
Screw Connection Disconnect Knife Disconnect with Test Sockets							
6.2 mm	10 AWG/4 mm ²	500/16/26–10	600/16/26–10	300/16/26–10	Gray	50	XBUT4MTP
Screw Connection Terminal Blocks with Integrated Diodes							
6.2 mm	12 AWG/4 mm ²	500/32/24–10	600/30/26–10	—	Gray	50	XBUK4DIO

XBTKT25 Thermal
Electric Voltage

Screw Connection Thermoelectric Voltage Terminal Blocks

Terminal Width	Maximum Wire Size	Connection Data in V/A/AWG	UL-cUL Ratings in V/A/AWG	Colour	Standard Pack	Catalogue Number
Copper/Constantan (CU/CUNI44)						
10.4 mm	12 AWG/2.5 mm ²	400/—/24–12	300/10/28–12	Gray	50	XBTKT25 (Type T)
Iron/Constantan (FE/CUNI44)						
10.4 mm	12 AWG/2.5 mm ²	400/—/24–12	300/10/28–12	Gray	50	XBTKJ25 (Type J)
Nickel-Chrome/Constantan (NICR/CUNI44)						
10.4 mm	12 AWG/2.5 mm ²	400/—/24–12	300/10/28–12	Gray	50	XBTKE25 (Type E)
Nickel-Chrome/Nickel (NICRNI)						
10.4 mm	12 AWG/2.5 mm ²	400/—/24–12	300/10/28–12	Gray	50	XBTKK25 (Type K)
Copper/Copper Nickel (E-CU/A-CU)						
10.4 mm	12 AWG/2.5 mm ²	400/—/24–12	300/10/28–12	Gray	50	XBTKR25 (Type R)

Accessories

Screw Connection Disconnect and Component Terminal Blocks

Description	Colour	Number of Positions	Standard Pack	XBUT4TG Catalogue Number	XBUT4MT Catalogue Number	XBUKK4D10 Catalogue Number	XBTK25 Catalogue Number
Plug-in bridge—for cross connections in the bridge shaft	Red	2	10	XBAFBS26	XBAFBS26	—	—
		3	10	XBAFBS36	XBAFBS36	—	—
		5	10	XBAFBS56	XBAFBS56	—	—
		10	10	XBAFBS106	XBAFBS106	—	—
		50	10	XBAFBS506	XBAFBS506	—	—
Test adapter	—	—	10	XBATSPA14	XBATSPA14	—	—
2.3 mm diameter test plug	—	—	—	XBATSMPS-^①	XBATSMPS-^①	—	—
Modular test plug	—	—	10	XBATSDPPS6	XBATSDPPS6	—	—
Blank marker strip (strip of 10)	White	—	10	XBMZB6^②	XBMZB6^②	XBMZB6^②	XBMZB10^②
End cover	Gray	—	10	—	—	XBACUKK35	XBACTK4
Spacer cover	Gray	—	10	—	—	XBADGUKK35	—
Spacer plate	—	—	10	—	—	XBADPUKK35	—
Partition plate	—	—	—	—	—	—	XBATTK4
Fixed bridge	—	10	10	—	—	XBAFBI106	—

Technical Data and Specifications

Screw Connection Disconnect and Component Terminal Blocks

Description	XBUT4TG	XBUT4MT	XBUKK4D10	XBTK
Technical Data in Accordance with IEC				
Maximum load current in A/cross-section in mm ²	16/6	16/6	32/4	—
Rated surge voltage in kV/contamination class	6/3	6/3	6/3	—
Surge voltage category/insulating material group	III/I	III/I	III/I	—
Connection Capacity				
Stranded with ferrule/with ferrule and plastic sleeve in mm ²	0.25–4/0.25–4	0.25–4/0.25–4	0.25–4/0.25–2.5	—
Multi-Conductor Connection (same cross-section)				
Solid/stranded in mm ²	0.14–1.5/0.14–1.5	0.14–1.5/0.14–1.5	0.2–1.5/0.2–1.5	—
Stranded with ferrules without plastic sleeve in mm ²	0.25–1.5	0.25–1.5	0.25–1.5	—
Stranded with twin ferrule with plastic sleeve in mm ²	0.5–2.5	0.5–2.5	0.5–1.5	—
Stripping length in inches (mm)	0.35 (9)	0.35 (9)	0.31 (8)	0.28 (7)
Thread	M3	M3	M3	M3
Torque in in-lb (Nm)	5.3–7.1 (0.6–0.8)	5.3–7.1 (0.6–0.8)	5.3–7.1 (0.6–0.8)	5.3–7.1 (0.6–0.8)

Dimensions

Approximate Dimensions in Inches (mm)

Screw Connection Disconnect and Component Terminal Blocks

Catalogue Number	Width	Length	Cover Width	Height for—		
				35 x 7.5 in	35 x 15 in	32 in
XBUT4TG	0.24 (6.2)	2.24 (56.8)	—	1.87 (47.5)	2.17 (55.0)	—
XBUT4MT	0.24 (6.2)	2.24 (56.8)	—	1.87 (47.5)	2.17 (55.0)	—
XBUKK4D10	0.24 (6.2)	2.20 (56.0)	0.10 (2.5)	2.44 (62.0)	2.74 (69.5)	2.64 (67.0)
XBTK	0.20 (5.2)	1.81 (46.0)	0.04 (1.0)	1.57 (40.0)	1.87 (47.5)	1.77 (45.0)

Notes

① For ordering information, see [Page T42-105](#).② For information on Printed Marking Tag Options, see [Page T42-98](#).For additional accessories, see [Page T42-90](#).

High Current Blocks

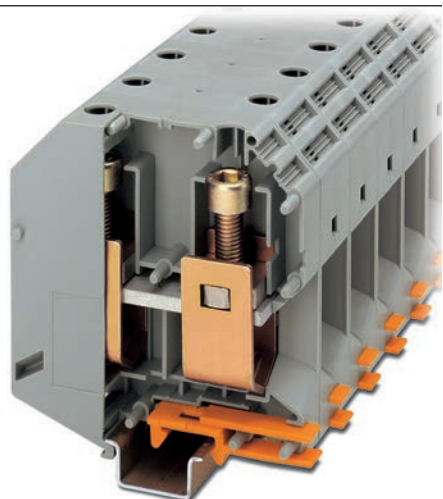

Contents

Description	Page
Single Level—Through-Feed	T42-5
Single Level—Ground Blocks	T42-10
Multi-Conductor Terminal Blocks	T42-12
Multi-Conductor Ground Blocks	T42-14
Double Level	T42-16
Triple Level Sensor/Actuator	T42-18
Fuse Terminal Blocks	T42-21
Disconnect and Component Terminal Blocks	T42-24
High Current Blocks	
Accessories	T42-28
Technical Data and Specifications	T42-28
Dimensions	T42-28
Mini Screw Connection	T42-29

High Current Blocks

Product Description

Eaton's XBUK high current terminal blocks offer a reliable connection via the superior construction that includes three-point centering of the wire in the

prism-shaped sleeve base, a fluted contact surface for low contact resistance, and screws secured with spring-loaded elements. The terminal blocks have

an enclosed housing made from polyamide 6.6. Green-yellow ground terminal blocks are also available.

Product Selection

XBUK150



Screw Connection High Current Blocks

Terminal Width	Maximum Wire Size	IEC 60 947-7-1 in V/A/AWG	EN 50 019 ① in V/A/AWG	UL-cUL Ratings in V/A/AWG	Colour	Standard Pack	Catalogue Number
20.0 mm	1/0/50 mm ²	1000/150/1/0	750/135/1/0	600/150/1/0	Gray	10	XBUK50
					Blue	10	XBUK50BU
31.0 mm	300 kcmil/150 mm ²	1000/309/2-300	726/265/2-300	600/285/ 2 AWG-300 kcmil	Gray	10	XBUK150

XBUK95PE



Screw Connection High Current Ground Blocks

Terminal Width	Maximum Wire Size	IEC 60 947-7-1 in V/A/AWG	EN 50 019 ① in V/A/AWG	UL-cUL Ratings in V/A/AWG	Colour	Standard Pack	Catalogue Number
25.0 mm	000 AWG/95 mm ²	—/232/4-000	—/—/4-000	—/—/2-4/0	Green/Yellow	10	XBUK95PE

Note

① U type—examination certificate number: KEMA 05ATEX2170 U (XBUK50), KEMA 05ATEX2171 U (XBUK150).

Accessories

Screw Connection High Current Blocks

Description	Colour	Number of Positions	Standard Pack	XBUK50 Catalogue Number	XBUK150 Catalogue Number	XBUK95PE Catalogue Number
Fixed bridge, screw heads with insulating colour	—	2	10	XBAFBI220	—	—
Insertion bridge	—	2	10	—	XBAEB231	—
Blank marker strip external labeling (strip of 10)	White	—	10	XBMZB10 ①	XBMZB10 ①	XBMZB10 ①

Technical Data and Specifications

Screw Connection High Current Blocks

Description	XBUK50	XBUK150	XBUK95PE
Technical Data in Accordance with IEC			
Maximum load current in A/cross-section in mm ²	150/50	309/150	232/95
Maximum cross-section with insertion bridge solid/stranded in mm ²	—/—	150/120	—/—
Rated surge voltage in kV/contamination class	8/3	8/3	8/3
Surge voltage category/insulating material group	III/I	III/I	III/I
Connection Capacity			
Stranded with ferrule/with ferrule and plastic sleeve in mm ²	25–50/25–50	50–150/50–150	35–95/35–95
Multi-Conductor Connection (same cross-section)			
Solid/stranded in mm ²	10–16/10–16	25–50/35–50	25–35/25–35
Stranded with ferrules without plastic sleeve in mm ²	10–16	25–50	16–35
Stripping length in inches (mm)	0.94 (24)	1.57 (40)	1.18 (30)
Thread	M6	M10	M8
Terminal point—thread/torque in in-lb (Nm)	53–71 (6–8)	221–267 (25–30)	133–177 (15–20)
Fastening—thread/torque in in-lb (Nm)	53–71 (6–8)	221–267 (25–30)	133–177 (15–20)

Dimensions

Approximate Dimensions in Inches (mm)

Screw Connection High Current Blocks

Catalogue Number	Width	Length	Height for—		
			35 x 7.5 in	35 x 15 in	32 in
XBUK50	0.79 (20.0)	2.78 (70.5)	3.29 (83.5)	3.21 (81.5)	—
XBUK150	1.22 (31.0)	3.94 (100.0)	4.67 (118.5)	4.57 (116.0)	—
XBUK95PE	0.98 (25.0)	3.27 (83.0)	—	3.90 (99.0)	3.80 (96.5)

Notes

① For information on Printed Marking Tag Options, see Page T42-98.

For additional accessories, see Page T42-90.

Mini Screw Connection Terminal Blocks

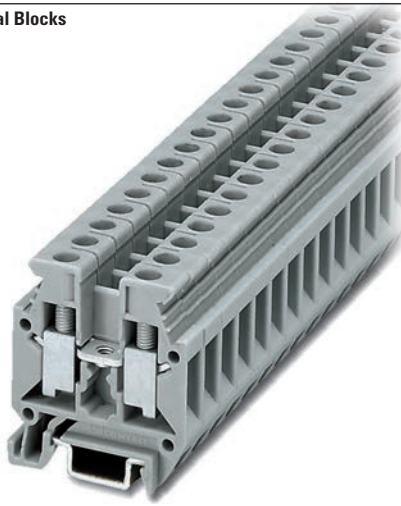

Contents

Description	Page
Single Level—Through-Feed	T42-5
Single Level—Ground Blocks	T42-10
Multi-Conductor Terminal Blocks	T42-12
Multi-Conductor Ground Blocks	T42-14
Double Level	T42-16
Triple Level Sensor/Actuator	T42-18
Fuse Terminal Blocks	T42-21
Disconnect and Component Terminal Blocks	T42-24
High Current Blocks	T42-27
Mini Screw Connection	
Accessories	T42-30
Technical Data and Specifications	T42-30
Dimensions	T42-30

Mini Screw Connection

Product Description

The **XB** miniature terminal blocks have a connection cross-section from 2 mm² through 4 mm² and mount on 15 mm DIN rail. There is an

opening for bridging with a fixed bridge in the centre of the terminal blocks. These miniature terminal blocks also offer the same accessories

that you would find with the larger blocks—including marking tags, end covers, end stop and ground blocks.

Product Selection

XBMUK4

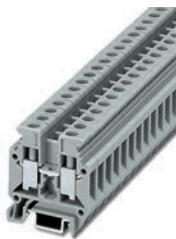

Mini Screw Connection Terminal Blocks

Terminal Width	Maximum Wire Size	IEC 60 947-7-1 in V/A/AWG	EN 50 019 ① in V/A/AWG	UL-cUL Ratings in V/A/AWG	Colour	Standard Pack	Catalogue Number
5.2 mm	12 AWG/2.5 mm ²	400/32/24–12	275/28/21/24–12	600/20/28–12	Gray	50	XBMUK25
					Blue	50	XBMUK25BU
6.2 mm	10 AWG/4 mm ²	500/41/24–10	—/—/—	600/10/26–10	Gray	50	XBMUK4
					Blue	50	XBMUK4BU

XBMUK25PE



Mini Screw Connection Ground Blocks

Terminal Width	Maximum Wire Size	IEC 60 947-7-2 in V/A/AWG	UL-cUL Ratings in V/A/AWG	Colour	Standard Pack	Catalogue Number
5.2 mm	12 AWG/2.5 mm ²	—/—/24–12	—/—/30–12	Green/ Yellow	50	XBMUK25PE
6.2 mm	10 AWG/2.4 mm ²	—/—/24–10	—/—/26–14	Green/ Yellow	50	XBMUK4PE

Note

① EU type—examination certificate number: KEMA 05ATEX2169 U (XBMUK25).

Accessories

Mini Screw Connection Terminal/Ground Blocks

Description	Colour	Number of Positions	Standard Pack	XBMUK25 Catalogue Number	XBMUK4 Catalogue Number	XBMUK25PE Catalogue Number	XBMUK4PE Catalogue Number
End cover	Gray	—	10	XBACMU254	XBACMU254	—	—
	Blue	—	10	XBACMU254B	XBACMU254B	—	—
Partition plate	—	—	10	XBATMU254	XBATMU254	—	—
Fixed bridge	—	10	10	XBAFBR105N	—	—	—
Separating plate	—	—	10	XBATMPKK15	XBATMPKK15	—	—
Blank marker strip (strip of 10)	White	—	10	XBMZB5 ①	XBMZB6 ①	XBMZB5 ①	XBMZB6 ①

Technical Data and Specifications

Mini Spring Cage Terminal/Ground Blocks

Description	XBMUK25	XBMUK4	XBMUK25PE	XBMUK4PE
Technical Data in Accordance with IEC				
Maximum load current in A/cross-section in mm ²	32/4	41/6	—	—
Maximum cross-section with insertion bridge (solid/stranded)	2.5/2.5	4/4	—	—
Rated surge voltage in kV/contamination class	6/3	6/3	6/3	6/3
Surge voltage category/insulating material group	III/I	III/I	III/I	III/I
Connection Cross-Section				
Stranded with ferrule with plastic sleeve in mm ²	0.25–1.5	0.25–2.5	0.25–1.5	0.25–2.5
Stranded with ferrule without plastic sleeve in mm ²	0.25–2.5	0.25–4	0.25–2.5	0.25–4
Multi-Conductor Connection (same cross-section)				
Solid/stranded in mm ²	0.2–1.0/0.2–1.5	0.2–1.5/0.2–1.5	0.2–1.0/0.2–1.5	0.2–1.5/0.2–1.5
Stranded with ferrule without plastic sleeve in mm ²	0.25–1.5	0.25–1.5	0.25–1.5	0.25–1.5
Stranded with ferrule with plastic sleeve in mm ²	0.5–1.0	0.5–2.5	0.5–1.5	0.5–2.5
Stripping length in Inches (mm)	0.31 (8)	0.31 (8)	0.31 (8)	0.31 (8)
Thread	M3	M3	M3	M3
Torque in in-lb (Nm)	5.3–7.1 (0.6–0.8)	4.4–5.3 (0.5–0.6)	5.3–7.1 (0.6–0.8)	5.3–7.1 (0.6–0.8)

Dimensions

Approximate Dimensions in Inches (mm)

Mini Spring Cage Terminal/Ground Blocks

Catalogue Number	Width	Length	Cover Length	Height for— 15 in
XBMUK25	0.20 (5.2)	1.10 (28.0)	0.04 (1.0)	1.26 (32.0)
XBMUK4	0.24 (6.2)	1.10 (28.0)	0.04 (1.0)	1.26 (32.0)
XBMUK25PE	0.20 (5.2)	1.10 (28.0)	—	1.24 (31.5)
XBMUK4PE	0.24 (6.2)	1.10 (28.0)	—	1.26 (32.0)

Notes

① For information on Printed Marking Tag Options, see **Page T42-98**.For additional accessories, see **Page T42-90**.

Spring Cage Connection



Contents

Description	Page
Spring Cage Terminal Blocks	
Single Level—Through-Feed	T42-32
Single Level—Ground Blocks	T42-37
Multi-Conductor Terminal Blocks	T42-39
Multi-Conductor Ground Blocks	T42-42
Double Level Blocks	T42-44
Triple Level Blocks	T42-46
Fuse Terminal Blocks	T42-48
Disconnect and Component Terminal Blocks	T42-51
Hybrid Terminal Blocks	T42-54
Mini Spring Cage	T42-56

Spring Cage Terminal Blocks Overview

Product Description

The XBPT Series incorporates a spring cage connection system proven in applications that are sensitive to vibration. The spring mechanism always exerts the same constant force on the wire, resulting in a vibration-proof, gas-tight connection, independent of the user. The space-saving front connection, with the wire and screwdriver coming in parallel from the same direction, allows for simple wiring in places where there is little space available.

Application Description

The connection point is opened with a standard screwdriver. After the wire has been inserted into the wire guide of the terminal block, the screwdriver is removed and the wire automatically makes contact.

Features

- Vibration-resistance
- Global acceptance
- Multi-conductor connections
- Flexible Plug-in bridge system
- Large surface area for marking
- Standardized testing system

Standards and Certifications

- UL recognized—File No. E67464
- CE approved
- LVD ①:
 - EN 60947-7-1
 - EN 60947-7-2
 - EN 60998-2-3
 - EN 60352-4/A1
- ATEX approval (Eex e applications)



Note

① Not all standards apply to all terminal blocks. Contact Eaton for details.

42.1

Terminal Blocks, Fuse Blocks and Fuse Holders

IEC—XB Series

Single Level—Through-Feed

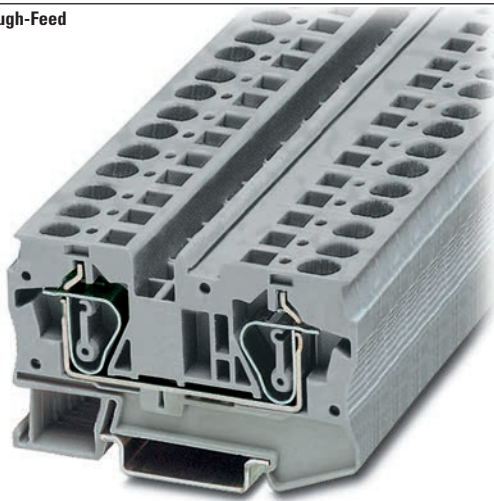

42

Contents

<i>Description</i>	<i>Page</i>
Single Level—Through-Feed	
Accessories	T42-34
Technical Data and Specifications	T42-36
Dimensions	T42-36
Single Level—Ground Blocks	T42-37
Multi-Conductor Terminal Blocks	T42-39
Multi-Conductor Ground Blocks	T42-42
Double Level Blocks	T42-44
Triple Level Blocks	T42-46
Fuse Terminal Blocks	T42-48
Disconnect and Component Terminal Blocks	T42-51
Hybrid Terminal Blocks	T42-54
Mini Spring Cage	T42-56

Single Level—Through-Feed

Product Description

The space-saving design and front entry design make the XBPT Series ideal for control systems where there is little space. Even so, they offer maximum connection space, resulting in fast wiring of stranded and solid conductors with or without ferrules.

XBPT terminal blocks are available with cross-sections from 2.5 mm² up to 35 mm². The double bridge shaft can accommodate individual chain bridging and step-down bridging from other terminal blocks.

Product Selection

XBPT6



Spring Cage Connection Single Level—Through-Feed

Terminal Width	Maximum Wire Size	IEC 60 947-7-1 in V/A/AWG	EN 50 019 ^① in V/A/AWG	UL-cUL Ratings in V/A/AWG	Colour	Standard Pack	Catalogue Number
5.2 mm	12 AWG/2.5 mm ²	800/31/28–12	550/25/21/24–12	600/20/26–12	Gray	50	XBPT25
					Blue	50	XBPT25BU
					White	50	XBPT25WH
					Red	50	XBPT25RD
					Black	50	XBPT25BK
6.2 mm	10 AWG/4 mm ²	800/40/28–10	550/34/30/24–10	600/30/20–10	Gray	50	XBPT4
					Blue	50	XBPT4BU
8.2 mm	8 AWG/6 mm ²	800/52/24–8	550/45/36/20–8	600/50/20–8	Gray	50	XBPT6
					Blue	50	XBPT6BU
10.2 mm	6 AWG/10 mm ²	800/65/24–6	550/50/63/16–6	600/65/16–6	Gray	50	XBPT10
					Blue	50	XBPT10BU
12 mm	4 AWG/16 mm ²	800/90/24–4	550/65/82/16–4	600/50/16–4	Gray	50	XBPT16
					Blue	50	XBPT16BU
16 mm	2 AWG/35 mm ²	800/125/14–2	750/108/14–2	600/115/14–2	Gray	50	XBPT35
					Blue	50	XBPT35BU

Note

^① EU type—examination certificate number: KEMA 05ATEX2158 U.

Accessories

Spring Cage Connection Single Level—Through-Feed, XBPT25, XBPT4 and XBPT6

Description	Colour	Number of Positions	Standard Pack	XBPT25 Catalogue Number	XBPT4 Catalogue Number	XBPT6 Catalogue Number
End cover	Gray	—	10	XBACPT25	XBACPT4	XBACPT6
Partition plate	Gray	—	10	XBATPT4	XBATPT4	XBATPT6
Plug-in bridge—for cross connections in the bridge shaft	Red	2	10	XBAFBS25	XBAFBS26	XBAFBS28
		3	10	XBAFBS35	XBAFBS36	—
		5	10	XBAFBS55	XBAFBS56	—
		10	10	XBAFBS105	XBAFBS106	—
		50	10	XBAFBS505	XBAFBS506	—
Test adapter	—	—	10	XBATSPA14	XBATSPA14	XBATSPA14
2.3 mm diameter test plug	—	—	—	XBATSMPS- ^①	XBATSMPS- ^①	XBATSMPS- ^①
Modular test plug	—	—	10	XBATSPS5	XBATSPS6	XBATSPS8
Blank marker strip external labeling	White	—	10	XBMZBF5 ^②	XBMZBF6 ^②	XBMZBF8 ^②
Blank marker strip centre labeling (strip of 10)	White	—	10	XBMZB5 ^②	XBMZB6 ^②	XBMZB8 ^②

Spring Cage Connection Single Level—Through-Feed, XBPT10, XBPT16 and XBPT35

Description	Colour	Number of Positions	Standard Pack	XBPT10 Catalogue Number	XBPT16 Catalogue Number	XBPT35 Catalogue Number
End cover	Gray	—	10	XBACPT10	XBACPT16	^③
Plug-in bridge—for cross connections in the bridge shaft	Red	2	10	XBAFBS210	XBAFBS212 ^①	XBAFBS216 ^②
2.3 mm diameter test plug	—	—	10	XBATSMPS- ^①	XBATSMPS- ^①	XBATSMPS- ^①
Blank marker strip external labeling	White	—	10	XBMZBF10 ^②	XBMZBF12 ^②	XBMZBF15 ^②
Blank marker strip centre labeling (strip of 10)	White	—	10	XBMZB10 ^②	XBMZB12 ^②	XBMZB15 ^②

Notes

- ① For ordering information, see **Page T42-105**
 ② For information on Printed Marking Tag Options, see **Page T42-98**.
 ③ XBPT35 has an enclosed design. The use of an end cover is not required.

For additional accessories, see **Page T42-90**.

XBPT with Reducing Bridge

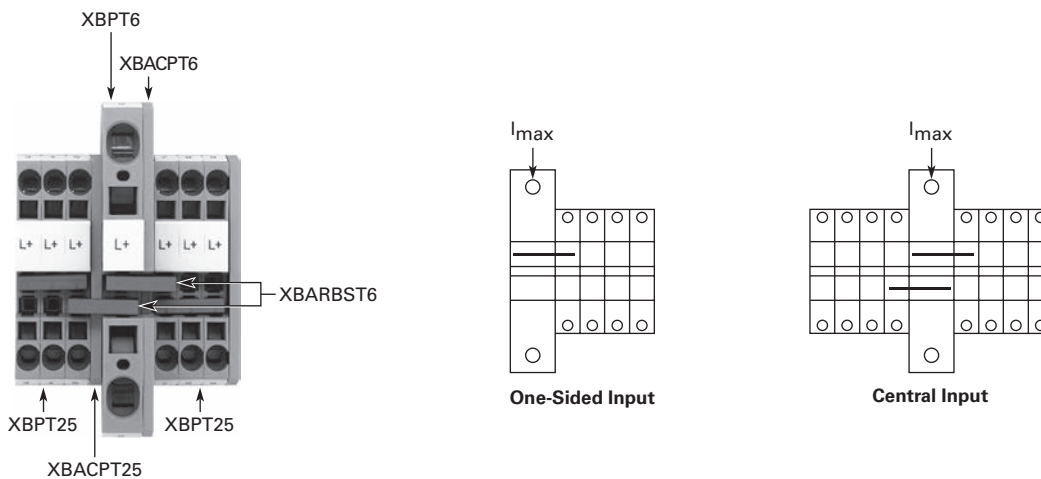

Step-Down Bridge with Standard Feed-Through Terminal Blocks

Input Terminal Blocks	Cross-Section	Pick-Off Terminal Blocks	Cross-Section AWG (mm ²)	One-Sided Input I _{max}	Central Input I _{max}	Bridge Catalogue Number
XBPT6	8 AWG (6 mm ²)	XBPT25	12 (2.5)	40	56	XBARBST6
		XBPT4	10 (4)	45	56	XBARBST6
		XBQT15	14 (1.5)	35	56	XBARBST6
		XBQT25	12 (2.5)	40	56	XBARBST6
XBPT10	6 AWG (10 mm ²)	XBPT25	12 (2.5)	40	65	XBARBST10
		XBPT4	10 (4)	45	65	XBARBST10
		XBQT15	14 (1.5)	35	65	XBARBST10
		XBQT25	12 (2.5)	40	65	XBARBST10
XBPT16	4 AWG (16 mm ²)	XBPT25	12 (2.5)	40	80	XBARBST16
		XBPT4	10 (4)	45	90	XBARBST16
		XBQT15	14 (1.5)	35	70	XBARBST16
		XBQT25	12 (2.5)	40	80	XBARBST16

Technical Data and Specifications

Spring Cage Connection Single Level—Through-Feed

Description	XBPT25	XBPT4	XBPT6	XBPT10	XBPT16	XBPT35
Technical Data in Accordance with IEC						
Maximum load current in A/cross-section in mm ²	31/4	40/6	52/10	65/16	90/25	125/35
Rated surge voltage in kV/contamination class	8/3	8/3	8/3	8/3	8/3	8/3
Surge voltage category/insulating material group	III/I	III/I	III/I	III/I	III/I	III/I
Connection Capacity						
Stranded with ferrule/with ferrule and plastic sleeve in mm ²	0.25–2.5	0.25–4	0.25–6	0.25–10	0.25–16	2.5–35
Stranded with ferrules without plastic sleeve in mm ²	0.25–2.5	0.25–4	0.25–6	0.25–10	0.25–16	2.5–35
Stranded with twin ferrule with plastic sleeve in mm ²	0.5	0.5–1	0.5–1.5	1.5–2.5	1.5–4	2.5–10
Stripping length in inches (mm)	0.39 (10)	0.39 (10)	0.47 (12)	0.71 (18)	0.71 (18)	0.98 (25)

Dimensions

Approximate Dimensions in Inches (mm)

Spring Cage Connection Single Level—Through-Feed

Catalogue Number	Width	Length	Cover Width	Height for—	
				35 x 7.5 in	35 x 15 in
XBPT25	0.20 (5.2)	1.91 (48.5)	0.09 (2.2)	1.45 (36.8)	1.73 (44.0)
XBPT4	0.24 (6.2)	2.20 (56.0)	0.09 (2.2)	1.45 (36.8)	1.73 (44.0)
XBPT6	0.32 (8.2)	2.74 (69.5)	0.09 (2.2)	1.71 (43.5)	2.01 (51.0)
XBPT10	0.39 (10.0)	2.81 (71.5)	0.09 (2.2)	1.99 (50.5)	2.30 (58.5)
XBPT16	0.47 (12.0)	3.15 (80.0)	0.09 (2.2)	2.01 (51.0)	2.30 (58.5)
XBPT35	0.63 (16.0)	3.94 (100.0)	①	2.32 (59.0)	2.62 (66.5)

Note

① XBPT35 has an enclosed design. The use of an end cover is not required.

Single Level—Ground Blocks

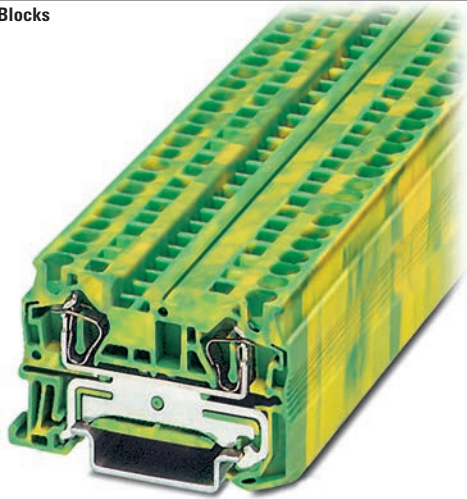

Contents

Description	Page
Single Level—Through-Feed	T42-32
Single Level—Ground Blocks	
Accessories	T42-38
Technical Data and Specifications	T42-38
Dimensions	T42-38
Multi-Conductor Terminal Blocks	T42-39
Multi-Conductor Ground Blocks	T42-42
Double Level Blocks	T42-44
Triple Level Blocks	T42-46
Fuse Terminal Blocks	T42-48
Disconnect and Component Terminal Blocks	T42-51
Hybrid Terminal Blocks	T42-54
Mini Spring Cage	T42-56

Single Level—Ground Blocks

Product Description

The XBPT ground blocks are the same shape as the feed-through terminal blocks with the same wide range of cross-sections available. They easily snap onto the

DIN rail to make a reliable mechanical and electrical contact that meets all requirements of IEC 60-947-7-2.

Product Selection

XBPT4PE



Spring Cage Connection Single Level—Ground Blocks

Terminal Width	Maximum Wire Size	IEC 60 947-7-2 in V/A/AWG	EN 50 019 ① in V/A/AWG	UL-cUL Ratings in V/A/AWG	Colour	Standard Pack	Catalogue Number
5.2 mm	12 AWG/2.5 mm ²	—/—/28-12	—/—/24-12	—/—/26-12	Green/Yellow	50	XBPT25PE
6.2 mm	10 AWG/4 mm ²	—/—/28-10	—/—/24-10	—/—/20-10	Green/Yellow	50	XBPT4PE
8.2 mm	8 AWG/6 mm ²	—/—/24-8	—/—/20-8	—/—/20-8	Green/Yellow	50	XBPT6PE
10.2 mm	6 AWG/10 mm ²	—/65/24-6	—/—/16-6	—/—/16-6	Green/Yellow	50	XBPT10PE
12 mm	4 AWG/16 mm ²	—/90/24-4	—/—/16-4 ②	—/—/16-4	Green/Yellow	25	XBPT16PE
16 mm	2 AWG/35 mm ²	—/125/14-2	—/—/14-2 ②	—/—/14-2	Green/Yellow	10	XBPT35PE

Notes

① EU type—examination certificate number: KEMA 05ATEX2154 U (XBPT25PE), KEMA 05ATEX2155 U (XBPT4PE).

② EU type—examination certificate number: KEMA 05ATEX2156 U.

Accessories

Spring Cage Connection Single Level Ground Blocks, XBPT25PE, XBPT4PE and XBPT6PE

Description	Colour	Number of Positions	Standard Pack	XBPT25PE Catalogue Number	XBPT4PE Catalogue Number	XBPT6PE Catalogue Number
End cover	Gray	—	10	XBACPT25	XBACPT4	XBACPT6
Blank marker strip external labeling	White	—	10	XBMZBF5 ①	XBMZBF6 ①	XBMZBF8 ①
Blank marker strip centre labeling (strip of 10)	White	—	10	XBMZB5 ①	XBMZB6 ①	XBMZB8 ①

Spring Cage Connection Single Level Ground Blocks, XBPT10PE, XBPT16PE and XBPT35PE

Description	Colour	Number of Positions	Standard Pack	XBPT10PE Catalogue Number	XBPT16PE Catalogue Number	XBPT35PE Catalogue Number
End cover	Gray	—	10	XBACPT10	XBACPT16	②
Plug-in bridge—for cross connections in the bridge shaft	—	2	10	XBAFBS210	XBAFBS212	XBAFBS216
Blank marker strip external labeling	White	—	10	XBMZBF10 ①	XBMZBF12 ①	XBMZBF15 ①
Blank marker strip centre labeling (strip of 10)	White	—	10	XBMZB10 ①	XBMZB12 ①	XBMZB15 ①

Technical Data and Specifications

Spring Cage Connection Single Level Ground Blocks

Description	XBPT25PE	XBPT4PE	XBPT6PE	XBPT10PE	XBPT16PE	XBPT35PE
Technical Data in Accordance with IEC						
Maximum load current in A/cross-section in mm ²	—	—	—	65/16	90/25	125/35
Rated surge voltage in kV/contamination class	8/3	8/3	8/3	8/3	8/3	8/3
Surge voltage category/insulating material group	III/I	III/I	III/I	III/I	III/I	III/I
Connection Capacity						
Stranded with ferrule with plastic sleeve in mm ²	0.25–2.5	0.25–4	0.25–6	0.25–10	0.25–16	2.5–35
Stranded with ferrules without plastic sleeve in mm ²	0.25–2.5	0.25–4	0.25–6	0.25–10	0.25–16	2.5–35
Stranded with twin ferrule with plastic sleeve in mm ²	0.5	0.5–1	0.5–1.5	1.5–2.5	1.5–4	2.5–10
Stripping length in inches (mm)	0.39 (10)	0.39 (10)	0.47 (12)	0.71 (18)	0.71 (18)	0.98 (25)

Dimensions

Approximate Dimensions in Inches (mm)

Spring Cage Connection Single Level Ground Blocks

Catalogue Number	Width	Length	Cover Width	Height for—	
				35 x 7.5 in	35 x 15 in
XBPT25PE	0.20 (5.2)	1.91 (48.5)	0.09 (2.2)	1.45 (36.8)	1.73 (44.0)
XBPT4PE	0.24 (6.2)	2.20 (56.0)	0.09 (2.2)	1.45 (36.8)	1.73 (44.0)
XBPT6PE	0.32 (8.2)	2.74 (69.5)	0.09 (2.2)	1.71 (43.5)	2.01 (51.0)
XBPT10PE	0.39 (10.0)	2.81 (71.5)	0.09 (2.2)	1.99 (50.5)	2.28 (58.0)
XBPT16PE	0.47 (12.0)	3.15 (80.0)	0.09 (2.2)	2.01 (51.0)	2.30 (58.5)
XBPT35PE	0.63 (16.0)	3.94 (100.0)	—	2.32 (59.0)	2.62 (66.5)

Notes

① For information on Printed Marking Tag Options, see **Page T42-98**.

② XBPT35PE has an enclosed design. The use of an end cover is not required.

For additional accessories, see **Page T42-90**.

Multi-Conductor Terminal Blocks

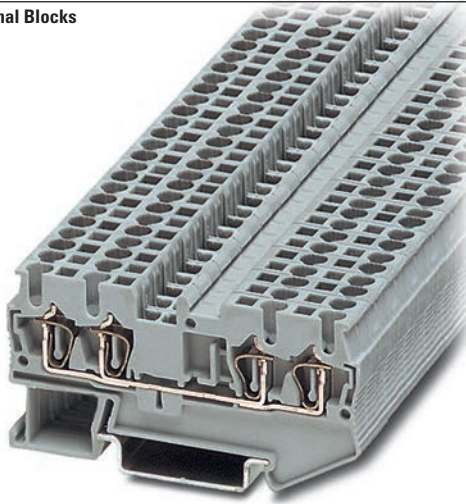

Contents

Description	Page
Single Level—Through-Feed	T42-32
Single Level—Ground Blocks	T42-37
Multi-Conductor Terminal Blocks	
Accessories	T42-40
Technical Data and Specifications	T42-41
Dimensions	T42-41
Multi-Conductor Ground Blocks	T42-42
Double Level Blocks	T42-44
Triple Level Blocks	T42-46
Fuse Terminal Blocks	T42-48
Disconnect and Component Terminal Blocks	T42-51
Hybrid Terminal Blocks	T42-54
Mini Spring Cage	T42-56

Multi-Conductor Terminal Blocks

Product Description

The multi-conductor terminal blocks offer a space-saving alternative to standard feed-through terminal blocks, allowing for high-density wiring. Often, three connections have to be led to one terminal block. The XBPT...D12 terminal block accomplishes this without

any additional terminal blocks or bridging required. The XBPT...D22 terminal blocks allow four wires to be connected to one potential—and can therefore be used as compact power distributors. There is also a version, XBPT25D22U or XBPT4D22U, with an interrupted bus bar in

the terminal centre. This makes two feed-through terminal blocks available in one level. One side of this block can be bridged using the standard Plug-in bridges. Double marker carriers are available for clear marking of the feed-through levels.

Product Selection

XBPT4D12



Spring Cage Connection Multi-Conductor Terminal Blocks, Three-Wire

Terminal Width	Maximum Wire Size	IEC 60 947-7-1 in V/A/AWG	EN 50 019 ① in V/A/AWG	UL-cUL Ratings in V/A/AWG	Colour	Standard Pack	Catalogue Number
5.2 mm	12 AWG/2.5 mm ²	800/28/28–12	550/25/21/24–12	600/20/26–12	Gray	50	XBPT25D12
					Blue	50	XBPT25D12BU
6.2 mm	10 AWG/4 mm ²	800/40/28–10	550/34/29/24–10	600/30/20–10	Gray	50	XBPT4D12
					Blue	50	XBPT4D12BU

Note

① EU type—examination certificate number: KEMA 05ATEX2154 U (XBPT25D12), KEMA 05ATEX2155 U (XBPT4D12).

XBPT25D22



Spring Cage Connection Multi-Conductor Terminal Blocks, Four-Wire

Terminal Width	Maximum Wire Size	IEC 60 947-7-1 in V/A/AWG	EN 50 019 ^① in V/A/AWG	UL-cUL Ratings in V/A/AWG	Colour	Standard Pack	Catalogue Number
Spring Cage Multi-Conductor							
5.2 mm	12 AWG/2.5 mm ²	800/28/28-12	550/24/21/24-12	600/20/26-12	Gray	50	XBPT25D22
					Blue	50	XBPT25D22BU
6.2 mm	10 AWG/4 mm ²	800/40/28-10	550/34/25/24-10	600/30/20-10	Gray	50	XBPT4D22
					Blue	50	XBPT4D22BU
Spring Cage Multi-Conductor with Interrupted Bus Bar							
5.2 mm	12 AWG/2.5 mm ²	800/28/28-12	550/24/21/24-12	600/20/26-12	Blue	50	XBPT25D22U
6.2 mm	10 AWG/4 mm ²	800/40/28-10	550/34/25/24-10	600/30/20-10	Blue	50	XBPT4D22U

Accessories

Spring Cage Connection Multi-Conductor Terminal Blocks

Description	Colour	Number of Positions	Standard Pack	XBPT25D12 Catalogue Number	XBPT4D12 Catalogue Number	XBPT25D22 Catalogue Number	XBPT4D22 Catalogue Number
End cover	Gray	—	10	XBACPT25D12	XBACPT4D12	XBACPT25D22	XBACPT4D22
End cover segment	Gray	—	10	XBASPT25	XBASPT4	XBASPT25	XBASPT4
Partition plate	—	—	10	XBATPTD12	XBATPTD12	XBATPTD22	XBATPTD22
Plug-in bridge—for cross connections in the bridge shaft	Red	2	10	XBAFBS25	XBAFBS26	XBAFBS25	XBAFBS26
		3	10	XBAFBS35	XBAFBS36	XBAFBS35	XBAFBS36
		5	10	XBAFBS55	XBAFBS56	XBAFBS55	XBAFBS56
		10	10	XBAFBS105	XBAFBS106	XBAFBS105	XBAFBS106
		50	10	XBAFBS505	XBAFBS506	XBAFBS505	XBAFBS506
Test adapter	—	—	10	XBATSPA14	XBATSPA14	XBATSPA14	XBATSPA14
2.3 mm diameter test plug	—	—	—	XBATSMPS-^②	XBATSMPS-^②	XBATSMPS-^②	XBATSMPS-^②
Modular test plug	—	—	10	XBATSPS5	XBATSPS6	XBATSPS5	XBATSPS6
Blank marker strip external labeling	White	—	10	XBMZBF5^③	XBMZBF6^③	XBMZBF5^③	XBMZBF6^③
Blank marker strip centre labeling (strip of 10)	White	—	10	XBMZB5^③	XBMZB6^③	XBMZB5^③	XBMZB6^③

Notes

^① EU type—examination certificate number: KEMA 05ATEX2154 U (XBPT25D22), KEMA 05ATEX2155 (XBPT4D22).

^② For ordering information, see **Page T42-105**.

^③ For information on Printed Marking Tag Options, see **Page T42-98**.

For additional accessories, see **Page T42-90**.

Technical Data and Specifications

Spring Cage Connection Multi-Conductor Terminal Blocks

Description	XBPT25D12	XBPT4D12	XBPT25D22	XBPT4D22
Technical Data in Accordance with IEC				
Maximum load current in A/cross-section in mm ²	28/4	40/6	28/4	40/6
Rated surge voltage in kV/contamination class	8/3	8/3	8/3	8/3
Surge voltage category/insulating material group	III/I	III/I	III/I	III/I
Connection Capacity				
Stranded with ferrule with plastic sleeve in mm ²	0.25–2.5	0.25–4	0.25–2.5	0.25–4
Stranded with ferrules without plastic sleeve in mm ²	0.25–2.5	0.25–4	0.25–2.5	0.25–4
Stranded with twin ferrule with plastic sleeve in mm ²	0.5	0.5–1	0.5	0.5–1
Stripping length in inches (mm)	0.39 (10)	0.39 (10)	0.39 (10)	0.39 (10)

Dimensions

Approximate Dimensions in Inches (mm)

Spring Cage Connection Multi-Conductor Terminal Blocks

Catalogue Number	Width	Length	Cover Width	Height for—	
				35 x 7.5 in	35 x 15 in
XBPT25D12	0.20 (5.2)	2.38 (60.5)	0.09 (2.2)	1.44 (36.5)	1.73 (44.0)
XBPT4D12	0.24 (6.2)	2.81 (71.5)	0.09 (2.2)	1.44 (36.5)	1.73 (44.0)
XBPT25D22	0.20 (5.2)	2.83 (72.0)	0.09 (2.2)	1.44 (36.5)	1.73 (44.0)
XBPT4D22	0.24 (6.2)	3.43 (87.0)	0.09 (2.2)	1.44 (36.5)	1.73 (44.0)

Multi-Conductor Terminal Blocks



Contents

Description	Page
Single Level—Through-Feed	T42-32
Single Level—Ground Blocks	T42-37
Multi-Conductor Terminal Blocks	T42-39
Multi-Conductor Ground Blocks	
Accessories	T42-43
Technical Data and Specifications	T42-43
Dimensions	T42-43
Double Level Blocks	T42-44
Triple Level Blocks	T42-46
Fuse Terminal Blocks	T42-48
Disconnect and Component Terminal Blocks	T42-51
Hybrid Terminal Blocks	T42-54
Mini Spring Cage	T42-56

Multi-Conductor Ground Blocks

Product Description

The ground terminal blocks have the same shape and pitch as the standard terminal block, in a green-yellow housing. They easily snap

onto the DIN rail to make a reliable mechanical and electrical contact that meets all requirements of IEC 60-947-7-2.

Product Selection

XBPT25D12PE



Spring Cage Connection Multi-Conductor Ground Blocks, Three-Wire

Terminal Width	Maximum Wire Size	IEC 60 947-7-2 in V/A/AWG	EN 50 019 ① in V/A/AWG	UL-cUL Ratings in V/A/AWG	Colour	Standard Pack	Catalogue Number
5.2 mm	12 AWG/2.5 mm ²	—/—/28-12	—/—/24-12	—/—/26-12	Green/Yellow	50	XBPT25D12PE
6.2 mm	10 AWG/4 mm ²	—/—/28-10	—/—/24-10	—/—/20-10	Green/Yellow	50	XBPT4D12PE

XBPT4D22PE



Spring Cage Connection Multi-Conductor Ground Blocks, Four-Wire

Terminal Width	Maximum Wire Size	IEC 60 947-7-2 in V/A/AWG	EN 50 019 ① in V/A/AWG	UL-cUL Ratings in V/A/AWG	Colour	Standard Pack	Catalogue Number
5.2 mm	12 AWG/2.5 mm ²	—/—/28-12	—/—/24-12	—/—/26-12	Green/Yellow	50	XBPT25D22PE
6.2 mm	10 AWG/4 mm ²	—/—/28-10	—/—/24-10	—/—/20-10	Green/Yellow	50	XBPT4D22PE

Note

① EU type—examination certificate number: KEMA 05ATEX2154 U (XBPT25D12PE), KEMA 05ATEX2155 U (XBPT4D12PE).

Accessories

Spring Cage Connection Multi-Conductor Ground Blocks

Description	Colour	Number of Positions	Standard Pack	XBPT25D12PE Catalogue Number	XBPT4D12PE Catalogue Number	XBPT25D22PE Catalogue Number	XBPT4D22PE Catalogue Number
End cover	Gray	—	10	XBACPT25D12	XBACPT4D12	XBACPT25D22	XBACPT4D22
End cover segment	Gray	—	10	XBASPT25	XBASPT4	XBASPT25	XBASPT4
Blank marker strip external labeling	White	—	10	XBMZBF5 ①	XBMZBF6 ①	XBMZBF5 ①	XBMZBF6 ①
Blank marker strip centre labeling (strip of 10)	White	—	10	XBMZB5 ①	XBMZB6 ①	XBMZB5 ①	XBMZB6 ①

Technical Data and Specifications

Spring Cage Connection Multi-Conductor Ground Blocks

Description	XBPT25D12PE	XBPT4D12PE	XBPT25D22PE	XBPT4D22PE
Technical Data in Accordance with IEC				
Maximum load current in A/cross-section in mm ²	—	—	—	—
Rated surge voltage in kV/contamination class	8/3	8/3	8/3	8/3
Surge voltage category/insulating material group	III/1	III/1	III/1	III/1
Connection Capacity				
Stranded with ferrule with plastic sleeve in mm ²	0.25–2.5	0.25–4	0.25–2.5	0.25–4
Stranded with ferrules without plastic sleeve in mm ²	0.25–2.5	0.25–4	0.25–2.5	0.25–4
Stranded with twin ferrule with plastic sleeve in mm ²	0.5	0.5–1	0.5	0.5–1
Stripping length in inches (mm)	0.39 (10)	0.39 (10)	0.39 (10)	0.39 (10)

Dimensions

Approximate Dimensions in Inches (mm)

Spring Cage Connection Multi-Conductor Ground Blocks

Catalogue Number	Width	Length	Cover Width	Height for—	
				35 x 7.5 in	35 x 15 in
XBPT25D12PE	0.20 (5.2)	2.38 (60.5)	0.09 (2.2)	1.44 (36.5)	1.73 (44.0)
XBPT4D12PE	0.24 (6.2)	2.81 (71.5)	0.09 (2.2)	1.44 (36.5)	1.73 (44.0)
XBPT25D22PE	0.20 (5.2)	2.83 (72.0)	0.09 (2.2)	1.44 (36.5)	1.73 (44.0)
XBPT4D22PE	0.24 (6.2)	3.43 (87.0)	0.09 (2.2)	1.44 (36.5)	1.73 (44.0)

Notes

① For information on Printed Marking Tag Options, see **Page T42-98**.

For additional accessories, see **Page T42-90**.

Double Level Blocks



Contents

Description	Page
Single Level—Through-Feed	T42-32
Single Level—Ground Blocks	T42-37
Multi-Conductor Terminal Blocks	T42-39
Multi-Conductor Ground Blocks	T42-42
Double Level Blocks	
Accessories	T42-45
Technical Data and Specifications	T42-45
Dimensions	T42-45
Triple Level Blocks	T42-46
Fuse Terminal Blocks	T42-48
Disconnect and Component Terminal Blocks	T42-51
Hybrid Terminal Blocks	T42-54
Mini Spring Cage	T42-56

Double Level Blocks

Product Description

The potentials of the **XB** double level terminal blocks routed on two levels reduce space requirements by 50% compared with single level terminal blocks.

The XBPTT blocks can be bridged on both levels with the Plug-in bridge system and labeling options are available for each terminal point, resulting in maximum

customization for each application. The XBPTT25PV and XBPTT4PV terminal blocks have two interconnected levels.

Equipotential bonding is marked by an imprint on the housing. These terminal blocks can also be bridged and used to construct compact potential distributor blocks.

Product Selection

XBPTT4



Spring Cage Connection Double Level Blocks

Terminal Width	Maximum Wire Size	IEC 60 947-7-1 in V/A/AWG	EN 50 019 ① in V/A/AWG	UL-cUL Ratings in V/A/AWG	Colour	Standard Pack	Catalogue Number
Spring Cage Connection Double Level Blocks							
5.2 mm	12 AWG/2.5 mm ²	500/26/28-12	420/23/19/24-12	600/20/26-12	Gray	50	XBPTT25
					Blue	50	XBPTT25BU
6.2 mm	10 AWG/4 mm ²	500/32/28-10	420/32/27/24-10	300/30/20-10	Gray	50	XBPTT4
					Blue	50	XBPTT4BU
Spring Cage Connection Double Level Blocks (terminal block with potential distribution between the levels)							
5.2 mm	112 AWG/2.5 mm ²	500/26/28-12	420/23/19/24-12	600/20/26-12	Gray	50	XBPTT25PV
6.2 mm	10 AWG/4 mm ²	500/32/28-10	420/32/27/24-10	300/30/20-10	Gray	50	XBPTT4PV

XBPTT25PE



Spring Cage Connection Double Level Ground Blocks

Terminal Width	Maximum Wire Size	IEC 60 947-7-2 in V/A/AWG	EN 50 019 ① in V/A/AWG	UL-cUL Ratings in V/A/AWG	Colour	Standard Pack	Catalogue Number
5.2 mm	12 AWG/2.5 mm ²	—/—/28-12	—/—/24-12	—/—/26-12	Green/Yellow	50	XBPTT25PE
6.2 mm	10 AWG/4 mm ²	—/—/28-10	—/—/24-10	—/—/20-10	Green/Yellow	50	XBPTT4PE

Note

① EU type—examination certificate number: KEMA 05ATEX2154 U (XBPTT25), KEMA 05ATEX2155 U (XBPTT4).

Accessories

Spring Cage Connection Double Level Blocks

Description	Colour	Number of Positions	Standard Pack	XBPTT25 Catalogue Number	XBPTT4 Catalogue Number	XBPTT25PE Catalogue Number	XBPTT4PE Catalogue Number
End cover	Gray	—	10	XBACPTT25	XBACPTT4	XBACPTT25	XBACPTT4
Partition plate	—	—	10/50	XBATPTT4	XBATPTT4	—	—
Plug-in bridge—for cross connections in the bridge shaft	Red	2	10	XBAFBS25	XBAFBS26	XBAFBS25	XBAFBS26
		3	10	XBAFBS35	XBAFBS36	XBAFBS35	XBAFBS36
		5	10	XBAFBS55	XBAFBS56	XBAFBS55	XBAFBS56
		10	10	XBAFBS105	XBAFBS106	XBAFBS105	XBAFBS106
		50	10	XBAFBS505	XBAFBS506	XBAFBS505	XBAFBS506
Test adapter	—	—	10	XBATSPAI4	XBATSPAI4	—	—
Modular test plug	—	—	10	XBATSPS5	XBATSPS6	—	—
Blank marker strip (strip of 10)	White	—	10	XBMZBF5 ①	XBMZBF6 ①	XBMZBF5 ①	XBMZBF6 ①

Technical Data and Specifications

Spring Cage Connection Double Level Blocks

Description	XBPTT25	XBPTT4	XBPTT25PE	XBPTT4PE
Technical Data in Accordance with IEC				
Maximum load current in A/cross-section in mm ²	26/4	32/6	—	—
Rated surge voltage in kV/contamination class	6/3	6/3	6/3	6/3
Surge voltage category/insulating material group	III/I	III/I	III/I	III/I
Connection Capacity				
Stranded with ferrule with plastic sleeve in mm ²	0.25–2.5	0.25–4	0.25–2.5	0.25–4
Stranded with ferrules without plastic sleeve in mm ²	0.25–2.5	0.25–4	0.25–2.5	0.25–4
Stranded with twin ferrule with plastic sleeve in mm ²	0.5	0.5–1	0.5	0.5–1
Stripping length in inches (mm)	0.39 (10)	0.39 (10)	0.39 (10)	0.39 (10)

Dimensions

Approximate Dimensions in Inches (mm)

Spring Cage Connection Double Level Blocks

Catalogue Number	Width	Length	Cover Width	Height for—	
				35 x 7.5 in	35 x 15 in
XBPTT25	0.20 (5.2)	2.66 (67.5)	0.09 (2.2)	1.87 (47.5)	2.17 (55.0)
XBPTT4	0.24 (6.2)	3.29 (83.5)	0.09 (2.2)	1.87 (47.5)	2.17 (55.0)
XBPTT25PE	0.20 (5.2)	2.66 (67.5)	0.09 (2.2)	1.87 (47.5)	2.17 (55.0)
XBPTT4PE	0.24 (6.2)	3.29 (83.5)	0.09 (2.2)	1.87 (47.5)	2.17 (55.0)

Notes

① For information on Printed Marking Tag Options, see **Page T42-98**.

For additional accessories, see **Page T42-90**.

42.1

Terminal Blocks, Fuse Blocks and Fuse Holders

IEC—XB Series

Triple Level Blocks

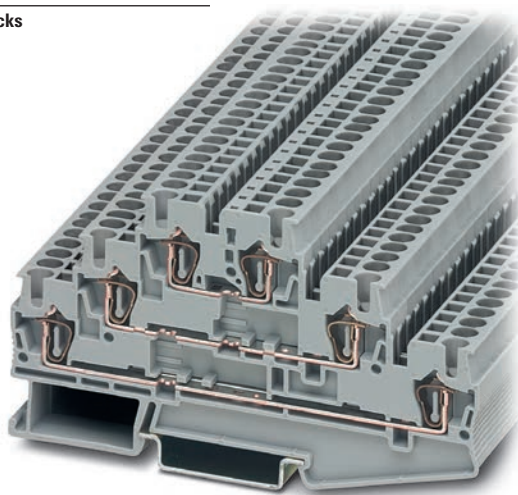

42

Contents

<i>Description</i>	<i>Page</i>
Single Level—Through-Feed	T42-32
Single Level—Ground Blocks	T42-37
Multi-Conductor Terminal Blocks	T42-39
Multi-Conductor Ground Blocks	T42-42
Double Level Blocks	T42-44
Triple Level Blocks	
Accessories	T42-47
Technical Data and Specifications	T42-47
Dimensions	T42-47
Fuse Terminal Blocks	T42-48
Disconnect and Component Terminal Blocks	T42-51
Hybrid Terminal Blocks	T42-54
Mini Spring Cage	T42-56

Triple Level Blocks

Product Description

The spring cage triple level terminal block incorporates three feed-through levels in a 5.2 mm wide housing. This is ideal for high density wiring, especially important

when switchgear space is restricted. There is a bridge shaft on each level allowing use of this block as a compact potential distributor or as a sensor terminal.

The XBPTK25PV has all six terminal points interconnected. All the triple level blocks can be labeled on each level.

Product Selection

XBPTK25

Spring Cage Connection Triple Level Blocks



Terminal Width	Maximum Wire Size	IEC 60 947-7-1 in V/A/AWG	UL-cUL Ratings in V/A/AWG	Colour	Standard Pack	Catalogue Number
5.2 mm	12 AWG/2.5 mm ²	500/28/28-12	600/20/26-12	Gray	50	XBPTK25
5.2 mm	12 AWG/2.5 mm ²	500/28/28-12	600/20/26-12	Gray	50	XBPTK25PV ①

Note

① Terminal block with potential distribution between the levels.

Accessories

Spring Cage Connection Triple Level Blocks

Description	Colour	Number of Positions	Standard Pack	XBPTK25 Catalogue Number	XBPTK25PV Catalogue Number
End cover	Gray	—	10	XBACPT25K	XBACPT25K
Plug-in bridge—for cross connections in the bridge shaft	Red	2	10	XBAFBS25	XBAFBS25
		3	10	XBAFBS35	XBAFBS35
		5	10	XBAFBS55	XBAFBS55
		10	10	XBAFBS105	XBAFBS105
		50	10	XBAFBS505	XBAFBS505
Test adapter	—	—	10	XBATSPA14	XBATSPA14
Modular test plug	—	—	10	XBATSPS5	XBATSPS5
Blank marker strip (strip of 10)	White	—	10	XBMZBF5 ①	XBMZBF5 ①

Technical Data and Specifications

Spring Cage Connection Triple Level Blocks

Description	XBPTK25	XBPTK25PV
Technical Data in Accordance with IEC		
Maximum load current in A/cross-section in mm ²	28/4	28/4
Rated surge voltage in kV/contamination class	6/3	6/3
Surge voltage category/insulating material group	III/I	III/I
Connection Capacity		
Stranded with ferrule with plastic sleeve in mm ²	0.25–2.5	0.25–2.5
Stranded with ferrules without plastic sleeve in mm ²	0.25–2.5	0.25–2.5
Stranded with twin ferrule with plastic sleeve in mm ²	0.5	0.5
Stripping length in inches (mm)	0.39 (10)	0.39 (10)

Dimensions

Approximate Dimensions in Inches (mm)

Spring Cage Connection Triple Level Blocks

Catalogue Number	Width	Length	Cover Length	Height for—	
				35 x 7.5 in	35 x 15 in
XBPTK25	0.20 (5.2)	3.92 (99.5)	0.09 (2.2)	2.28 (58.0)	2.58 (65.5)
XBPTK25PV	0.20 (5.2)	3.92 (99.5)	0.09 (2.2)	2.28 (58.0)	2.58 (65.5)

Notes

① For information on Printed Marking Tag Options, see **Page T42-98**.

For additional accessories, see **Page T42-90**.

Fuse Terminal Blocks

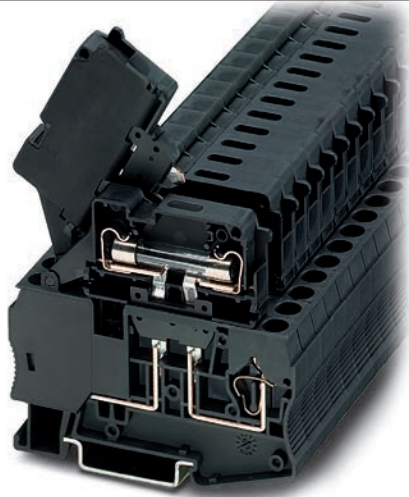

42

Contents

<i>Description</i>	<i>Page</i>
Single Level—Through-Feed	T42-32
Single Level—Ground Blocks	T42-37
Multi-Conductor Terminal Blocks	T42-39
Multi-Conductor Ground Blocks	T42-42
Double Level Blocks	T42-44
Triple Level Blocks	T42-46
Fuse Terminal Blocks	
Accessories	T42-49
Technical Data and Specifications	T42-50
Dimensions	T42-50
Disconnect and Component Terminal Blocks	T42-51
Hybrid Terminal Blocks	T42-54
Mini Spring Cage	T42-56

Fuse Terminal Blocks

Product Description

The spring cage fuse terminal blocks act as a fuse carrier for 5 x 20 mm or 6.3 x 32 mm fuses. They also allow for potential distribution with the

double bridge shaft. For signaling a triggered fuse, fuse terminal blocks with light indicators are available (for both AC and DC voltage).

Product Selection

XBPT4FBE

Spring Cage Connection Fuse Terminal Blocks, for 5 x 20 mm Fuse



Terminal Width	Maximum Wire Size	IEC 60 947-7-3 with Fuse in V/A/AWG	IEC 60 947-7-3 as Disconnect Terminal Blocks in V/A/AWG	UL-cUL Ratings in V/A/AWG	Colour	Standard Pack	Catalogue Number
Fuse Terminal Blocks							
6.2 mm	10 AWG/4 mm ²	①/①/28-10	250/6.3/28-10	300/6.3/24-10	Black	50	XBPT4FBE
Fuse Terminal Blocks with LED 15-30V, 3.5-8.1A							
6.2 mm	10 AWG/4 mm ²	①/①/28-10	250/6.3/28-10	300/6.3/24-10	Black	50	XBPT4FBEL24
Fuse Terminal Blocks with LED 30-60V, 0.8-2.0A							
6.2 mm	10 AWG/4 mm ²	①/①/28-10	250/6.3/28-10	300/6.3/24-10	Black	50	XBPT4FBEL60
Fuse Terminal Blocks with LED 110-250V, 0.5-1.0A							
6.2 mm	10 AWG/4 mm ²	①/①/28-10	250/6.3/28-10	300/6.3/24-10	Black	50	XBPT4FBEL250

Notes

The cartridge fuse holders should be selected according to the maximum power dissipation (self-heating) of the cartridge fuse inserts. The thermal conditions in closed fuse holes should be checked according to the application and installation.

Higher ambient temperatures are an additional strain on fuse inserts. In applications of this kind, the shift of the rated current should be taken into consideration accordingly.

Maximum power dissipation at 73.4°F (23°C) (in accordance with IEC 60 947-7-3).

When selecting cartridge fuse inserts, please ensure that the maximum power dissipation specified at right is not exceeded. Details can be obtained from the fuse suppliers.

Cartridge Fuse Inserts 5 x 20 and 6.3 x 32 mm in accordance with IEC 60 947-7-3.

① The current is determined by the fuse used, the voltage by the selected light indicator. See **Page T42-49**.

XBPT4FBN



Spring Cage Connection Fuse Terminal Blocks, for 6.3 x 32 mm (1/4 in x 1-1/4 in) Fuse

Terminal Width	Maximum Wire Size	IEC 60 947-7-3 with Fuse in V/A/AWG	IEC 60 947-7-3 as Disconnect Terminal Blocks in V/A/AWG	UL-cUL Ratings in V/A/AWG	Colour	Standard Pack	Catalogue Number
Fuse Terminal Blocks							
8.2 mm	10 AWG/4 mm ²	400/10/28-10	400/10/28-10	300/10/24-10	Black	50	XBPT4FBN
Fuse Terminal Blocks with LED 12-30V, 1.0-2.5 mA							
8.2 mm	10 AWG/4 mm ²	400/10/28-10	400/10/28-10	300/10/24-10	Black	50	XBPT4FBNL24
Fuse Terminal Blocks with LED 110-250V, 0.5-2.5 mA							
8.2 mm	10 AWG/4 mm ²	400/10/28-10	400/10/28-10	300/10/24-10	Black	50	XBPT4FBNL250

42

Accessories

Spring Cage Connection Fuse Terminal Blocks

Description	Colour	Number of Positions	Standard Pack	XBPT4FBE Catalogue Number	XBPT4FBN Catalogue Number
Partition plate	—	—	10	XBATPT4	XBATQTD12
Plug-in bridge—for cross connections in the bridge shaft	Red	2	10	XBAFBS26	XBAFBS28
		3	10	XBAFBS36	—
		5	10	XBAFBS56	—
		10	10	XBAFBS106	—
Blank marker strip external labeling	White	—	10	XBMZBF6 ①	XBMZBF8 ①
Blank marker strip centre labeling (strip of 10)	White	—	10	XBMZB5 ①	XBMZB6 ①

Notes

The cartridge fuse holders should be selected according to the maximum power dissipation (self-heating) of the cartridge fuse inserts. The thermal conditions in closed fuse holes should be checked according to the application and installation.

Higher ambient temperatures are an additional strain on fuse inserts. In applications of this kind, the shift of the rated current should be taken into consideration accordingly.

Maximum power dissipation at 73.4°F (23°C) (in accordance with IEC 60 947-7-3).

When selecting cartridge fuse inserts, please ensure that the maximum power dissipation specified at right is not exceeded. Details can be obtained from the fuse suppliers.

Cartridge Fuse Inserts 5 x 20 and 6.3 x 32 mm in accordance with IEC 60 947-7-3.

① For information on Printed Marking Tag Options, see **Page T42-98**.

For additional accessories, see **Page T42-90**.

Technical Data and Specifications

Overload and Short-Circuit Protection

Terminal Blocks	U (V)	Overload Protection		Short-Circuit Protection Only		I _{max} (A)
		Individual	Interconnected	Individual	Interconnected	
XBPT4FBN	400	1.6W	1.6W	4W	2.5W	10.0
XBPT4FBE	250	1.6W	1.6W	4W	2.5W	6.3

Spring Cage Connection Fuse Terminal Blocks

Description	XBPT4FBE	XBPT4FBN
Technical Data in Accordance with IEC		
Fuse type/dimensions in mm ²	G/5 x 20	G/6.3 x 32
Maximum current with single arrangement in A	6.3	10
Maximum Power Dissipation		
At 73.4°F (23°C) in accordance with IEC 60 947-7-3 in W	①	①
Rated surge voltage in kV/contamination class	4/3	6/3
Surge voltage category/insulating material group	III/I	III/I
Connection Capacity		
Stranded with ferrule/with ferrule and plastic sleeve in mm ²	0.25–4/0.25–4	0.25–4/0.25–4
Stranded with twin ferrule and plastic sleeve in mm ²	0.5	0.5
Stripping length in inches (mm)	0.39 (10)	0.39 (10)

Dimensions

Approximate Dimensions in Inches (mm)

Spring Cage Connection Fuse Terminal Blocks

Catalogue Number	Width	Length	Height for—	
			35 x 7.5 in	35 x 15 in
XBPT4FBE	0.24 (6.2)	2.42 (61.5)	2.46 (62.5)	2.76 (70.0)
XBPT4FBN	0.32 (8.2)	3.01 (76.5)	2.72 (69.0)	3.01 (76.5)

Note

① The current is determined by the fuse used, the voltage by the selected light indicator. See **Page T42-49**.

Disconnect and Component Terminal Blocks

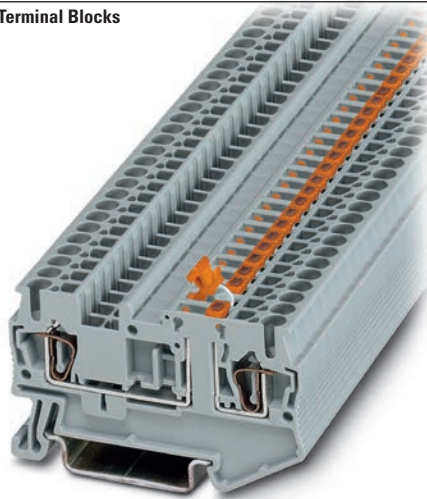

Contents

Description	Page
Single Level—Through-Feed	T42-32
Single Level—Ground Blocks	T42-37
Multi-Conductor Terminal Blocks	T42-39
Multi-Conductor Ground Blocks	T42-42
Double Level Blocks	T42-44
Triple Level Blocks	T42-46
Fuse Terminal Blocks	T42-48
Disconnect and Component Terminal Blocks	
Accessories	T42-52
Technical Data and Specifications	T42-53
Dimensions	T42-53
Hybrid Terminal Blocks	T42-54
Mini Spring Cage	T42-56

Disconnect and Component Terminal Blocks

Product Description

The XBPT knife disconnect terminal blocks feature narrow construction and high current carrying capacity. They also have a test connection parallel to the disconnect point for a 2.3 mm

diameter test plug. Potential distribution is easily accomplished with the Plug-in bridges. There are front connection spring cage terminal blocks available for multi-conductor connections

in the smallest possible space. The XBPT4TG disconnect terminal block accommodates component plugs for resistors, diodes, or capacitors, and fuse plugs with or without indication.

Product Selection

XBPT25MT
Knife Disconnect

Disconnect and Component Terminal Blocks

Terminal Width	Maximum Wire Size	IEC 60 947-7-1 in V/A/AWG	UL-cUL Ratings in V/A/AWG	Colour	Standard Pack	Catalogue Number
Single Level Knife Disconnect						
5.2 mm	12 AWG/2.5 mm ²	400/16/28–12	600/16/26–12	Gray	50	XBPT25MT
6.2 mm	10 AWG/4 mm ²	400/16/28–10	300/6.3/24–10	Gray	50	XBPT4MT
Three-Wire Knife Disconnect						
5.2 mm	12 AWG/2.5 mm ²	400/16/28–12	600/16/26–12	Gray	50	XBPT25D12MT
Four-Wire Knife Disconnect						
5.2 mm	12 AWG/2.5 mm ²	400/16/28–12	600/16/26–12	Gray	50	XBPT25D22MT
Spring Cage Disconnect/Component Plug						
6.2 mm	10 AWG/4 mm ²	400/16/28–10	300/6.3/24–10	Gray	50	XBPT4TG
Component Plug						
6.2 mm	10 AWG/4 mm ²	400/16/28–10	300/6.3/24–10	Gray	10	XBPCO
Fuse Plug						
6.2 mm	10 AWG/4 mm ²	400/16/28–10	300/6.3/24–10	Black	10	XBPFU
Fuse Plug with Light Indicator for 12–30V, 1–2.5 mA						
6.2 mm	10 AWG/4 mm ²	400/16/28–10	300/6.3/24–10	Black	10	XBPFUL24
Fuse Plug with Light Indicator for 110–250V, 0.5–2.5 mA						
6.2 mm	10 AWG/4 mm ²	400/16/28–10	300/6.3/24–10	Black	10	XBPFUL250

Accessories

Spring Cage Connection Disconnect and Component Terminal Blocks

Description	Colour	Number of Positions	Standard Pack	XBPT25MT Catalogue Number	XBPT25D12MT Catalogue Number	XBPT25D22MT Catalogue Number	XBPT4MT Catalogue Number	XBPT4TG Catalogue Number
End cover	Gray	—	10	XBACPT25D12	XBACPT25D22	XBACPT25D22MT	③	③
End cover segment	Gray	—	10	—	XBACPT25	XBACPT25	—	—
Partition plate	—	—	—	XBATPTD12	XBATPTD22	—	XBATPT4	XBATPT4
Plug-in bridge—for cross connections in the terminal centre	Red	2	10	XBAFBS25	XBAFBS25	XBAFBS25	XBAFBS26	XBAFBS26
		3	10	XBAFBS35	XBAFBS35	XBAFBS35	XBAFBS36	XBAFBS36
		5	10	XBAFBS55	XBAFBS55	XBAFBS55	XBAFBS56	XBAFBS56
		10	10	XBAFBS105	XBAFBS105	XBAFBS105	XBAFBS106	XBAFBS106
		50	10	XBAFBS505	XBAFBS505	XBAFBS505	XBAFBS506	XBAFBS506
Test adapter	—	—	10	XBATSPA14	XBATSPA14	XBATSPA14	XBATSPA14	XBATSPA14
2.3 mm diameter test plug	—	—	—	XBATSMPS-^①	XBATSMPS-^①	XBATSMPS-^①	XBATSMPS-^①	XBATSMPS-^①
Modular test plug	—	—	10	XBATSPS5	XBATSPS5	XBATSPS5	XBATSPS6	XBATSPS6
Blank marker strip external labeling	White	—	10	XBMZBF5^②	XBMZBF5^②	XBMZBF5^②	XBMZBF6^②	XBMZBF6^②
Blank marker strip centre labeling (strip of 10)	White	—	10	XBMZB5^②	XBMZB5^②	XBMZB5^②	XBMZB6^②	XBMZB6^②

Notes

- ① For ordering information, see **Page T42-105**.
- ② For information on Printed Marking Tag Options, see **Page T42-98**.
- ③ XBPT4MT and XBPT4TG have an enclosed design. The use of an end cover is not required.

For additional accessories, see **Page T42-90**.

Technical Data and Specifications

Spring Cage Connection Disconnect and Component Terminal Blocks, XBPT25MT, XBPT25D12MT and XBPT25D22MT

Description	XBPT25MT	XBPT25D12MT	XBPT25D22MT
Technical Data in Accordance with IEC			
Maximum load current in A/cross-section in mm ²	16/4	16/4	16/4
Rated surge voltage in kV/contamination class	6/3	6/3	6/3
Surge voltage category/insulating material group	III/1	III/1	III/1
Connection Capacity			
Stranded with ferrule with plastic sleeve in mm ²	0.25–2.5	0.25–2.5	0.25–2.5
Stranded with ferrules without plastic sleeve in mm ²	0.25–2.5	0.25–2.5	0.25–2.5
Stranded with twin ferrule with plastic sleeve in mm ²	0.5	0.5	0.5
Stripping length in inches (mm)	0.39 (10)	0.39 (10)	0.39 (10)

Spring Cage Connection Disconnect and Component Terminal Blocks, XBPT25D12MT and XBPT4TG

Description	XBPT4MT	XBPT4TG
Technical Data in Accordance with IEC		
Maximum load current in A/cross-section in mm ²	16/6	16/6
Rated surge voltage in kV/contamination class	6/3	6/3
Surge voltage category/insulating material group	III/1	III/1
Connection Capacity		
Stranded with ferrule with plastic sleeve in mm ²	0.25–4	0.25–4
Stranded with ferrules without plastic sleeve in mm ²	0.25–4	0.25–4
Stranded with twin ferrule with plastic sleeve in mm ²	0.5	0.5
Stripping length in inches (mm)	0.39 (10)	0.39 (10)

Dimensions

Approximate Dimensions in Inches (mm)

Spring Cage Connection Disconnect and Component Terminal Blocks

Catalogue Number	Width	Length	Cover Length	Height for—	
				35 x 7.5 in	35 x 15 in
XBPT25MT	0.20 (5.2)	2.38 (60.5)	0.09 (2.2)	1.44 (36.5)	1.73 (44.0)
XBPT25D12MT	0.20 (5.2)	2.83 (72.0)	0.09 (2.2)	1.44 (36.5)	1.73 (44.0)
XBPT25D22MT	0.20 (5.2)	3.31 (84.0)	0.09 (2.2)	1.44 (36.5)	1.73 (44.0)
XBPT4MT	0.24 (6.2)	2.42 (61.5)	—	1.44 (36.5)	1.73 (44.0)
XBPT4TG	0.24 (6.2)	2.42 (61.5)	—	1.44 (36.5)	1.73 (44.0)

Hybrid Terminal Blocks

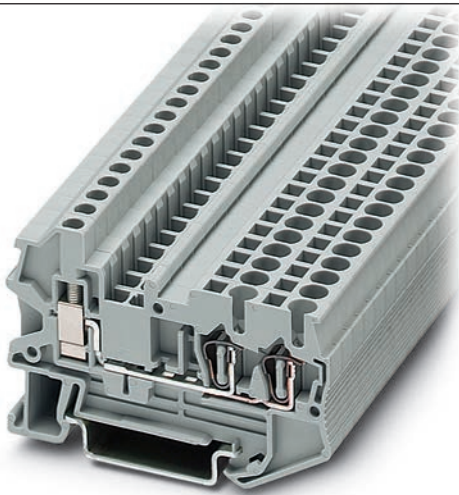

Contents

<i>Description</i>	<i>Page</i>
Single Level—Through-Feed	T42-32
Single Level—Ground Blocks	T42-37
Multi-Conductor Terminal Blocks	T42-39
Multi-Conductor Ground Blocks	T42-42
Double Level Blocks	T42-44
Triple Level Blocks	T42-46
Fuse Terminal Blocks	T42-48
Disconnect and Component Terminal Blocks	T42-51
Hybrid Terminal Blocks	
Accessories	T42-55
Technical Data and Specifications	T42-55
Dimensions	T42-55
Mini Spring Cage	T42-56

Hybrid Terminal Blocks

Product Description

The XBPU spring cage hybrid terminal blocks offer the best of both worlds. One side offers a spring cage connection and the other side offers the universal screw connection. Use the spring

cage connection on the internal (factory) control cabinet side and the screw connection on the end customer (field) side. Ground terminal blocks of the same shape are also available.

Product Selection

XBPU25D12

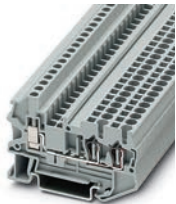

Spring Cage Hybrid Terminal Blocks

Terminal Width	Maximum Wire Size	IEC 60 947-7-1 with ...		IEC 60 947-7-2 with ...		UL-cUL Ratings with ...		Colour	Std. Pack	Catalogue Number
		Spring in V/A/AWG	Screw in V/A/AWG	Spring in V/A/AWG	Screw in V/A/AWG	Spring in V/A/AWG	Screw in V/A/AWG			
5.2 mm	12 AWG/ 2.5 mm ²	800/28/28-12	800/28/26-14	—	—	600/15/28-12	600/15/26-12	Gray	50	XBPU25D12

XBPU25D12PE

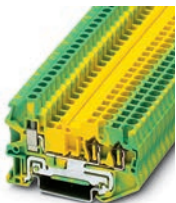

Spring Cage Hybrid Ground Blocks

Terminal Width	Maximum Wire Size	IEC 60 947-7-1 with ...		IEC 60 947-7-2 with ...		UL-cUL Ratings with ...		Colour	Std. Pack	Catalogue Number
		Spring in V/A/AWG	Screw in V/A/AWG	Spring in V/A/AWG	Screw in V/A/AWG	Spring in V/A/AWG	Screw in V/A/AWG			
5.2 mm	12 AWG/ 2.5 mm ²	—	—	—/—/28-12	—/—/26-14	—/—/28-12	—/—/28-12	Green/ Yellow	50	XBPU25D12PE

Accessories

Spring Cage Hybrid Terminal/Ground Blocks

Description	Colour	Number of Positions	Standard Pack	XBPU25D12 Catalogue Number	XBPU25D12PE Catalogue Number
End cover	Gray	—	10	XBACPU25D12	XBACPU25D12
Plug-in bridge—for cross connections in the terminal centre	Red	2	10	XBAFBS25	XBAFBS25
		3	10	XBAFBS35	XBAFBS35
		5	10	XBAFBS55	XBAFBS55
		10	10	XBAFBS105	XBAFBS105
		50	10	XBAFBS505	XBAFBS505
Test adapter	—	—	10	XBATSPA14	—
2.3 mm diameter test plug	—	—	—	XBATSMPS_ ①	—
Modular test plug	—	—	10	XBATSPS5	—
Blank marker strip external labeling	White	—	10	XBMZBF5 ②	XBMZBF5 ②
Blank marker strip centre labeling (strip of 10)	White	—	10	XBMZB5 ②	XBMZB5 ②

Technical Data and Specifications

Spring Cage Hybrid Blocks

Description	XBPU25D12	XBPU25D12PE
Technical Data in Accordance with IEC		
Maximum load current in A/cross-section in mm ²	28/4	—
Rated surge voltage in kV/contamination class	8/3	8/3
Surge voltage category/insulating material group	III/1	III/1
Connection Capacity		
Stranded with ferrule with plastic sleeve in mm ²	0.25–2.5	0.25–2.5
Stranded with ferrules without plastic sleeve in mm ²	0.25–2.5	0.25–2.5
Stranded with twin ferrule with plastic sleeve in mm ²	0.5–1	0.5–1
Stripping length in inches (mm)	0.39 (10)	0.39 (10)

Dimensions

Approximate Dimensions in Inches (mm)

Spring Cage Hybrid Blocks

Catalogue Number	Width	Length	Cover Length	Height for—	
				35 x 7.5 in	35 x 15 in
XBPU25D12	0.20 (5.2)	2.57 (65.3)	0.09 (2.2)	1.69 (42.8)	1.98 (50.3)
XBPU25D12PE	0.20 (5.2)	2.57 (65.3)	0.09 (2.2)	1.69 (42.8)	1.98 (50.3)

Notes

- ① For ordering information, see **Page T42-105**.
 - ② For information on Printed Marking Tag Options, see **Page T42-98**.
- For additional accessories, see **Page T42-90**.

Mini Spring Cage



Contents

Description	Page
Single Level—Through-Feed	T42-5
Single Level—Ground Blocks	T42-10
Multi-Conductor Terminal Blocks	T42-12
Multi-Conductor Ground Blocks	T42-14
Double Level	T42-16
Triple Level Sensor/Actuator	T42-18
Fuse Terminal Blocks	T42-21
Disconnect and Component Terminal Blocks	T42-24
High Current Blocks	T42-27
Mini Spring Cage	
Accessories	T42-57
Technical Data and Specifications	T42-57
Dimensions	T42-57

Mini Spring Cage

Product Description

The **XB** miniature terminal blocks have a connection cross-section from 1.5 mm² through 4 mm² and mount on 15 mm DIN rail. There is an

opening for bridging with a fixed bridge in the centre of the terminal blocks. These miniature terminal blocks also offer the same accessories

that you would find with the larger blocks—including marking tags, end covers, end stop and ground blocks.

Product Selection

XBMPK15



Mini Spring Cage Terminal Blocks

Terminal Width	Maximum Wire Size	IEC 60 947-7-1 in V/A/AWG	IEC 60 947-7-2 in V/A/AWG	UL-cUL Ratings in V/A/AWG	Colour	Standard Pack	Catalogue Number
5.2 mm	14 AWG/1.5 mm ²	800/24/26–14	—	600/15/26–14	Gray	50	XBMPK15
					Blue	50	XBMPK15BU

XBMPK15PE



Mini Spring Cage Ground Blocks

Terminal Width	Maximum Wire Size	IEC 60 947-7-1 in V/A/AWG	IEC 60 947-7-2 in V/A/AWG	UL-cUL Ratings in V/A/AWG	Colour	Standard Pack	Catalogue Number
5.2 mm	14 AWG/1.5 mm ²	—	—/—/26–14	—/—/26–14	Green/ Yellow	50	XBMPK15PE

XBMPKK15



Mini Spring Cage Terminal Blocks—Double Level

Terminal Width	Maximum Wire Size	IEC 60 947-7-1 in V/A/AWG	UL-cUL Ratings in V/A/AWG	Colour	Standard Pack	Catalogue Number
5.2 mm	14 AWG/1.5 mm ²	500/20/26–14	600/15/26–14	Gray	50	XBMPKK15

Accessories

Mini Spring Cage Terminal/Ground Blocks

Description	Colour	Number of Positions	Standard Pack	XBMPK15 Catalogue Number	XBMPK15PE Catalogue Number	XBMPKK15 Catalogue Number
End cover	Gray	—	10	XBACMPK15	XBACMPK15	XBACMPKK15
Fixed bridge	—	2	10	XBAFBR25N	—	XBAFBR25N
Separating plate	—	—	10	XBATMPKK15	—	XBATMPKK15
Blank marker strip	White	—	10	XBMZBF5 ^①	XBMZBF5 ^①	XBMZBF5 ^①

Technical Data and Specifications

Mini Spring Cage Terminal/Ground Blocks

Description	XBMPK15	XBMPK15PE	XBMPKK15
Technical Data in Accordance with IEC			
Maximum load current in A/cross-section in mm ²	24/2.5	—	20/2.5
Rated surge voltage in kV/contamination class	8/3	8/3	6/3
Surge voltage category/insulating material group	III/1	III/1	III/1
Connection Cross-Section			
Stranded with ferrule with plastic sleeve in mm ²	0.25–1.5	0.25–1.5	0.25–1.5
Stranded with ferrule without plastic sleeve in mm ²	0.25–1.5	0.25–1.5	0.25–1.5
Stranded with twin ferrule with plastic sleeve in mm ²	—	—	—
Stripping length in Inches (mm)	0.35 (9)	0.35 (9)	0.35 (9)

Dimensions

Approximate Dimensions in Inches (mm)

Mini Spring Cage Terminal/Ground Blocks

Catalogue Number	Width	Length	Cover Length	Height for—		
				15 x 5.5 in	35 x 7.5 in	35 x 15 in
XBMPK15	0.20 (5.2)	1.57 (40.0)	0.04 (1.1)	1.36 (34.5)	—	—
XBMPK15PE	0.20 (5.2)	1.57 (40.0)	0.04 (1.1)	1.36 (34.5)	—	—
XBMPKK15	0.20 (5.2)	3.35 (85.0)	0.04 (1.1)	1.65 (42.0)	1.67 (42.5)	1.97 (50.0)

Notes

^① For information on Printed Marking Tag Options, see **Page T42-98**.

For additional accessories, see **Page T42-90**.

Pluggable Spring Cage Terminal Blocks

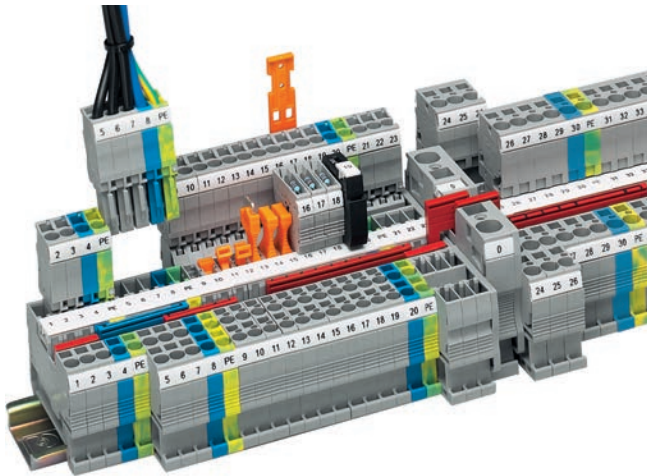

42

Pluggable Spring Cage Terminal Blocks Overview

Product Description

The pluggable spring cage connection terminal blocks allow signal and power wiring to be made pluggable. This complete pluggable system has a spring that provides maximum connection space in a space-saving design. The pluggable system accommodates stranded conductors with a nominal cross-section of 2.5 mm², with or without ferrules.

Application Description

For applications requiring pluggable wiring up to a rated current of 32A and a rated voltage of 800V. The integrated overspring meets the most stringent vibration requirements. Also ideal where safety is a concern and flexibility is required. The basic terminal blocks and the plugs are finger-safe, which also means the supply voltage can be input via either the terminal blocks or the plugs. With the XBAPSC receptacles, plug-in contacts can be accommodated safely in cable ducts and distributor shafts using minimal space. A test hole can accommodate a 2.3 mm diameter test plug in each receptacle, providing a practical solution. The XBAPSP plugs are intended for connecting one wire, while the XBAPSPDB plugs are designed to connect two wires and provide an optional bridge.

Contents

Description

<i>Description</i>	<i>Page</i>
Pluggable Spring Cage Terminal Blocks	
Connection Terminal Blocks	T42-59
Connection Plugs	T42-62
Connection Receptacles	T42-64
Connection Accessories	T42-66

Features

- Space-saving design
- Powerful contact
- Finger-safe

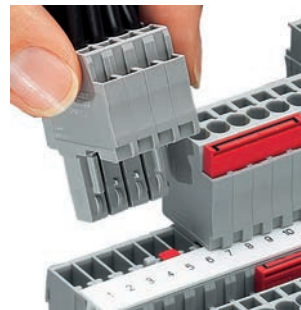

Pluggability

Standards and Certifications

- UL recognized—File No. E67464
- CE approved
- LVD ①:
 - EN 60947-7-1
 - EN 60947-7-2
 - EN 60998-2-3
 - EN 60352-4/A1
- ATEX approval (Eex e applications)



Note

① Not all standards apply to all terminal blocks. Contact Eaton for details.

Connection Terminal Blocks

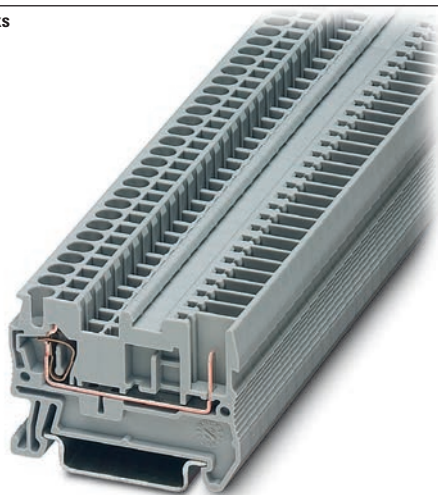

Contents

Description	Page
Connection Terminal Blocks	
Accessories	T42-60
Technical Data and Specifications	T42-60
Dimensions	T42-61
Connection Plugs	T42-62
Connection Receptacles	T42-64
Connection Accessories	T42-66

Connection Terminal Blocks

Product Description

Contact to the DIN rail is made by simply snapping the terminal block onto the rail.

These blocks act as the stationary position of the pluggable terminal blocks.

Product Selection

XBPT25P

Pluggable Spring Cage Connection Terminal Blocks



Terminal Width	Maximum Wire Size	IEC 61 984 in V/A/AWG	UL-cUL Ratings in V/A/AWG	Colour	Standard Pack	Catalogue Number
Single Level						
5.2 mm	12 AWG/2.5 mm ²	500/24/28-12	300/20/26-12	Gray	50	XBPT25P
Three-Wire						
5.2 mm	12 AWG/2.5 mm ²	500/24/28-12	300/20/26-12	Gray	50	XBPT25PD12

Accessories

Pluggable Spring Cage Connection Terminal Blocks

Description	Colour	Number of Positions	Standard Pack	XBPT25P Catalogue Number	XBPT25PD12 Catalogue Number
End cover	Gray	—	10	XBACPT25	XBACPT25D12
End cover segment	Gray	—	10	—	XBASPT25
Partition plate	—	—	10	XBATPT4	XBATPTD12
Plug-in bridge—for cross connections in the terminal centre	Red	2	10	XBAFBS25	XBAFBS25
		3	10	XBAFBS35	XBAFBS35
		5	10	XBAFBS55	XBAFBS55
		10	10	XBAFBS105	XBAFBS105
		50	10	XBAFBS505	XBAFBS505
Test adapter	—	—	10	XBATSPA14	XBATSPA14
2.3 mm diameter test plug	—	—	—	XBATSMPS- ^①	XBATSMPS- ^①
Modular test plug	—	—	10	XBATSPS5	XBATSPS5
Blank marker strip external labeling	White	—	10	XBMZBF5 ^②	XBMZBF5 ^②
Blank marker strip centre labeling (strip of 10)	White	—	10	XBMZB5 ^②	XBMZB5 ^②

Technical Data and Specifications

Pluggable Spring Cage Connection Terminal Blocks

Description	XBPT25P	XBPT25PD12
Technical Data in Accordance with IEC		
Maximum load current in A/cross-section in mm ²	24/4	24/4
Rated surge voltage in kV/contamination class	6/3	6/3
Surge voltage category/insulating material group	III/1	III/1
Connection Capacity		
Stranded with ferrule with plastic sleeve in mm ²	0.25–2.5	0.25–2.5
Stranded with ferrules without plastic sleeve in mm ²	0.25–2.5	0.25–2.5
Stranded with twin ferrule with plastic sleeve in mm ²	0.5	0.5
Stripping length in inches (mm)	0.39 (10)	0.39 (10)

Derating Curve for Pluggable Terminal Blocks XBPT25P and XBPT25PD12

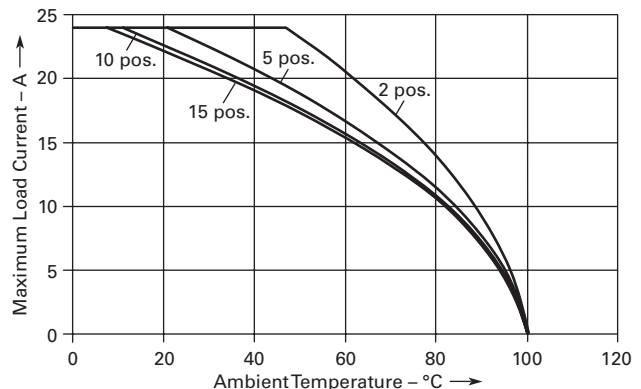

Notes

① For ordering information, see **Page T42-105**.

② For information on Printed Marking Tag Options, see **Page T42-98**.

For additional accessories, see **Page T42-90**.

Dimensions

Approximate Dimensions in Inches (mm)

Pluggable Spring Cage Connection Terminal Blocks—Without Plug

Catalogue Number	Width	Length	Cover Length	Height for—	
				35 x 7.5 in	35 x 15 in
XBPT25P	0.20 (5.2)	1.91 (48.5)	0.09 (2.2)	1.44 (36.5)	1.73 (44.0)
XBPT25PD12	0.20 (5.2)	2.38 (60.5)	0.09 (2.2)	1.44 (36.5)	1.73 (44.0)

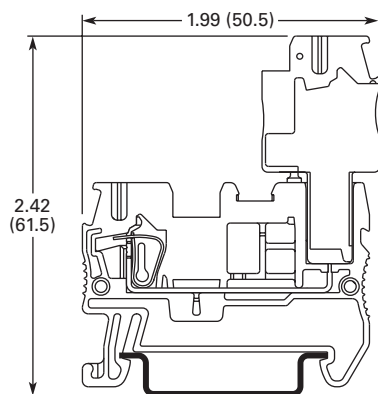
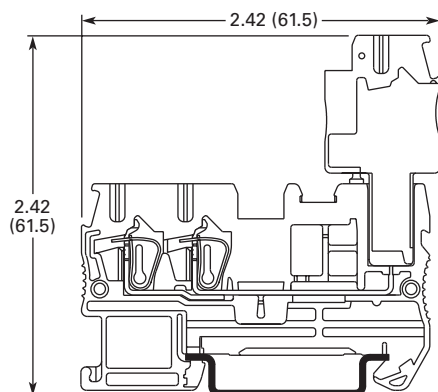
XBPT25P**XBPT25PD12**

42.1

Terminal Blocks, Fuse Blocks and Fuse Holders

IEC—XB Series

Connection Plugs



42

Contents

<i>Description</i>	<i>Page</i>
Connection Terminal Blocks	T42-59
Connection Plugs	
Accessories	T42-63
Technical Data and Specifications	T42-63
Dimensions	T42-63
Connection Receptacles	T42-64
Connection Accessories	T42-66

Connection Plugs

Product Description

Just like the basic terminal blocks, the plugs also offer the perfect solution for every application. The XBAPSP25_ plugs are designed for

connecting one conductor. The XBAPSPDB25_ plug is designed for connecting two conductors and provides an additional bridging option.

Product Selection

XBAPSP25_

Spring Cage Connection Plugs, Single, Not Bridgeable



Terminal Width	Maximum Wire Size	Connection Data in V/A/AWG	UL-cUL Ratings in V/A/AWG	Colour	Number of Positions	Standard Pack	Catalogue Number
5.2 mm	12 AWG/2.5 mm ²	500/24/28-12	300/20/26-12	Gray	1	25	XBAPSP251
					2	25	XBAPSP252
					3	25	XBAPSP253
					4	25	XBAPSP254
					5	25	XBAPSP255
					6	25	XBAPSP256
					7	25	XBAPSP257
					8	25	XBAPSP258
					9	25	XBAPSP259
					10	25	XBAPSP2510
					11	10	XBAPSP2511
					12	10	XBAPSP2512

XBAPSPDB25

Spring Cage Connection Plugs, Double, Bridgeable



Terminal Width	Maximum Wire Size	Connection Data in V/A/AWG	UL-cUL Ratings in V/A/AWG	Colour	Number of Positions	Standard Pack	Catalogue Number
5.2 mm	12 AWG/2.5 mm ²	500/24/28–12	300/20/26–12	Gray	1	25	XBAPSPDB251
					2	25	XBAPSPDB252
					3	25	XBAPSPDB253
					4	25	XBAPSPDB254
					5	25	XBAPSPDB255
					6	25	XBAPSPDB256
					7	25	XBAPSPDB257
					8	25	XBAPSPDB258
					9	25	XBAPSPDB259
					10	25	XBAPSPDB2510
					11	10	XBAPSPDB2511
					12	10	XBAPSPDB2512

Accessories

Spring Cage Connection Plugs

Description	Colour	Number of Positions	Standard Pack	XBAPSP25_ Catalogue Number	XBAPSPDB25_ Catalogue Number
Plug-in bridge—for cross connections in the terminal centre	Red	2	10	—	XBAFBS25
		3	10	—	XBAFBS35
		5	10	—	XBAFBS55
		10	10	—	XBAFBS105
Snap-lock fitting and strain relief	Orange	2	10	XBAPPRZ	XBAPPRZ
Snap-lock fitting	Orange	1	10	XBAPPR	XBAPPR
	Orange	2	10	XBAPPR2	XBAPPR2
Strain relief	Black	2	10	XBAPPZ2	XBAPPDZ2
	Black	4	10	XBAPPZ4	XBAPPDZ4
Blank marker strip	White	—	10	XBMZBF5 ①	XBMZBF5 ①

Technical Data and Specifications

Spring Cage Connection Plugs

Description	XBAPSP25_	XBAPSPDB25_
Technical Data in Accordance with IEC		
Maximum load current in A/cross-section in mm ²	24/4	24/4
Rated surge voltage in kV/contamination class	6/3	6/3
Surge voltage category/insulating material group	III/1	III/1
Connection Capacity		
Stranded with ferrule with plastic sleeve in mm ²	0.25–2.5	0.25–2.5
Stranded with ferrules without plastic sleeve in mm ²	0.25–2.5	0.25–2.5
Stranded with twin ferrule with plastic sleeve in mm ²	0.5	0.5
Stripping length in inches (mm)	0.39 (10)	0.39 (10)

Dimensions

See **Page T42-61** for dimensions.

Notes

① For information on Printed Marking Tag Options, see **Page T42-98**.

For additional accessories, see **Page T42-90**.

42.1

Terminal Blocks, Fuse Blocks and Fuse Holders

IEC—XB Series

Connection Receptacles

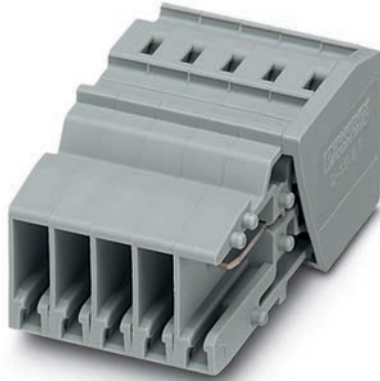

42

Contents

<i>Description</i>	<i>Page</i>
Connection Terminal Blocks	T42-59
Connection Plugs	T42-62
Connection Receptacles	
Accessories	T42-65
Technical Data and Specifications	T42-65
Dimensions	T42-65
Connection Accessories	T42-66

Connection Receptacles

Product Description

With the XBAPSC25_ Plug-in contacts can be accommodated safely in cable ducts and distributor shafts without using much

space. The standard strain reliefs can also be used. Large-surface labeling makes it possible to mark the terminal points and the entire

receptacle. A test hole can accommodate a 2.3 mm diameter test plug in each receptacle element, providing a practical solution.

Product Selection

XBAPSC25_

Pluggable Spring Connection Receptacles



Terminal Width	Maximum Wire Size	Connection Data in V/A/AWG	UL-cUL Ratings in V/A/AWG	Colour	Number of Positions	Standard Pack	Catalogue Number
5.2 mm	12 AWG/2.5 mm ²	500/24/28-12	300/20/26-12	Gray	2	25	XBAPSC252
					3	25	XBAPSC253
					4	25	XBAPSC254
					5	25	XBAPSC255
					6	25	XBAPSC256
					7	25	XBAPSC257
					8	25	XBAPSC258
					9	25	XBAPSC259
					10	25	XBAPSC2510
					11	10	XBAPSC2511
					12	10	XBAPSC2512

Accessories

Pluggable Spring Connection Receptacles

Description	Colour	Number of Positions	Standard Pack	XBAPSC25_ Catalogue Number
2.3 mm diameter test plug	Red	—	—	XBATSMPS_- ^①
Strain relief	Black	2	10	XBAPPDZ2
	Black	4	10	XBAPPDZ4
Blank marker strip	White	—	10	XBMZBF5 ^②

Technical Data and Specifications

Spring Cage Connection Plugs

Description	XBAPSP25_
Technical Data in Accordance with IEC	
Maximum load current in A/cross-section in mm ²	24/4
Rated surge voltage in kV/contamination class	6/3
Surge voltage category/insulating material group	III/I
Connection Capacity	
Stranded with ferrule with plastic sleeve in mm ²	0.25–2.5
Stranded with ferrules without plastic sleeve in mm ²	0.25–2.5
Stranded with twin ferrule with plastic sleeve in mm ²	0.5
Stripping length in inches (mm)	0.39 (10)

Dimensions

Approximate Dimensions in Inches (mm)

Spring Cage Connection Plugs

Catalogue Number	Width	Length	Cover Length	Height
XBAPSP25_	0.20 (5.2)	1.46 (37.2)	0.09 (2.2)	0.71 (18.0)

Receptacle Widths

Catalogue Number	Width	Catalogue Number	Width
XBAPSC252	0.41 (10.4)	XBAPSC258	1.64 (41.6)
XBAPSC253	0.61 (15.6)	XBAPSC259	1.84 (46.8)
XBAPSC254	0.82 (20.8)	XBAPSC2510	2.05 (52.0)
XBAPSC255	1.02 (26.0)	XBAPSC2511	2.25 (57.2)
XBAPSC256	1.23 (31.2)	XBAPSC2512	2.46 (62.4)
XBAPSC257	1.43 (36.4)		

Notes

① For ordering information, see **Page T42-105**.

② For information on Printed Marking Tag Options, see **Page T42-98**.

For additional accessories, see **Page T42-90**.

42.1

Terminal Blocks, Fuse Blocks and Fuse Holders

IEC—XB Series

Connection Accessories

Product Description





The pluggable XBPT series features an extensive range of application-oriented accessories. Strain reliefs are available for the plugs and

can be snapped on at the required points as an option. The snap-lock fitting can be used for all plug variants. It is snapped into the outside of

the plug housing as an option and hooks onto the terminal block housing when the plug is snapped on.

Product Selection

Pluggable Spring Cage Connection Accessories

	Description	Number of Positions	Standard Pack	Catalogue Number
XBAPPZ2 	Strain relief for single plugs	2	10	XBAPPZ2
		4	10	XBAPPZ4
XBAPPDZ4 	Strain relief for double plugs and receptacles	2	10	XBAPPDZ2
		4	10	XBAPPDZ4
XBAPPR2 	Snap-lock fitting for plugs	1	10	XBAPPR
		2	10	XBAPPR2
XBAPPRZ 	Snap-lock fitting and strain relief for plugs	2	10	XBAPPRZ

Strain Relief

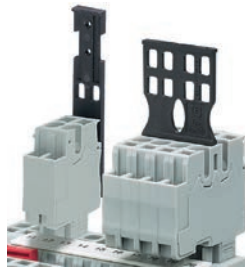

Snap-Lock Fitting



Optional Accessory Recommendations

Number of Positions Receptacle	Strain Relief
2–4	XBAPPZ2
5–10	XBAPPZ4 or (2) XBAPPZ2
11–15	(2) XBAPPZ4 or (4) XBAPPZ2

IDC Terminal Blocks



Contents

Description	Page
IDC Terminal Blocks	
Single Level	T42-68
Multi-Conductor	T42-70
Double Level	T42-73
Fuse Terminal Blocks	T42-75
Disconnect and Component Terminal Blocks	T42-77
Hybrid Terminal Blocks	T42-79

IDC (Insulation Displacement Connection) Terminal Blocks Overview

Product Description

The superior design of Eaton's Insulation Displacement Connection (IDC) technology terminal blocks reduces wiring installation time and labor, especially in high-volume applications. IDC terminal blocks are suited for applications in automated equipment and machine tools, packaging and material handling machinery, railway/mass transit systems, petrochemical, and any other application requiring high-volume connections for low-voltage control and signal circuitry where labor cost reduction and ease of assembly is desired. These terminal blocks are designed for long-term use under demanding conditions.

The XBQT Series allows for wire to be connected without any prior stripping. The quick connection provides up to 60% reduction in wiring time. One turn of a standard screwdriver results in a simple, fast and reliable connection.

Application Description

The XBQT is operated with a standard screwdriver. The switching states are clearly signaled by engagement points in the start and end positions. Solid and stranded wires of 0.25 to 2.5 mm² can be wired without the use of ferrules. Stripping the wire is not required—the wire's insulation is cut open when it is properly connected. The wire is securely placed in the end position where it makes large-area, gas-tight contact. Connections are made in seconds!

Features

- Quick connection capability
- Global acceptance
- Flexible plug-in bridge system
- Large surface area for marking
- Standardized testing system

Standards and Certifications

- UL recognized—File No. E67464
- CE approved
- LVD ^①
 - EN 60947-7-1
 - EN 60947-7-2
 - EN 60998-2-3
 - EN 60352-4/A1
- ATEX approval (Eex e applications)

**Note**

- ^① Not all standards apply to all terminal blocks. Contact Eaton for details.

Single Level

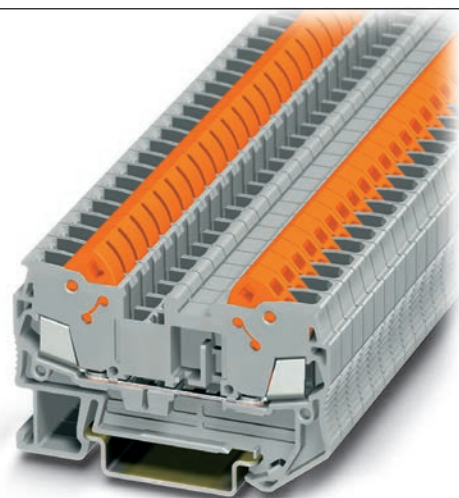

Contents

Description	Page
Single Level	
Accessories	T42-69
Technical Data and Specifications	T42-69
Dimensions	T42-69
Multi-Conductor	T42-70
Double Level	T42-73
Fuse Terminal Blocks	T42-75
Disconnect and Component Terminal Blocks	T42-77
Hybrid Terminal Blocks	T42-79

Single Level

Product Description

The XBQT IDC terminal block has the fastest connection time in a compact design. The space-saving front connection design offers additional space for wiring between the cable ducts. The double bridge shaft can

accommodate individual chain bridging and step-down bridging from other terminal blocks. The XBQT ground blocks are the same shape as the feed-through terminal blocks with the same wide range of cross-sections

available. They easily snap onto the DIN rail to make a reliable mechanical and electrical contact that meets all requirements of IEC 60-947-7-2.

Product Selection

XBQT25

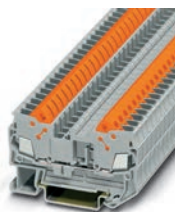

IDC—Single Level Terminal Blocks

Terminal Width	Maximum Wire Size	Connection Data in V/A/AWG	EN 50 019 ① in V/A/AWG	UL-cUL Ratings in V/A/AWG	Colour	Standard Pack	Catalogue Number
5.2 mm	16 AWG/1.5 mm ²	800/17.5/24–16	550/16/24–16	600/10/24–16	Gray	50	XBQT15
					Blue	50	XBQT15BU
6.2 mm	14 AWG/2.5 mm ²	800/24/20–14	—	600/15/20–14	Gray	50	XBQT25
					Blue	50	XBQT25BU

XBQT15PE



IDC—Single Level Terminal Ground Blocks

Terminal Width	Maximum Wire Size	Connection Data in V/A/AWG	EN 50 019 ① in V/A/AWG	UL-cUL Ratings in V/A/AWG	Colour	Standard Pack	Catalogue Number
5.2 mm	16 AWG/1.5 mm ²	—/—/24–16	—/—/24–16	—/—/24–16	Green/Yellow	50	XBQT15PE
6.2 mm	14 AWG/2.5 mm ²	—/—/20–14	—	—/—/20–14	Green/Yellow	50	XBQT25PE

Note

① EU type—examination certificate number: KEMA 05ATEX2157 U (XBQT15), KEMA 05ATEX2160 U (XBQT25).

Accessories

IDC—Single Level Terminal/Ground Blocks

Description	Colour	Number of Positions	Standard Pack	XBQT15 Catalogue Number	XBQT25 Catalogue Number	XBQT15PE Catalogue Number	XBQT25PE Catalogue Number
End cover	Gray	—	10	XBACQT15	XBACQT25	XBACQT15	XBACQT25
Partition plate	—	—	10	XBATQT25	XBATQT25	XBATQT25	XBATQT25
Plug-in bridge	Red	2	10	XBAFBS25	XBAFBS26	XBAFBS25	XBAFBS26
		3	10	XBAFBS35	XBAFBS36	XBAFBS35	XBAFBS36
		5	10	XBAFBS55	XBAFBS56	XBAFBS55	XBAFBS56
		10	10	XBAFBS105	XBAFBS106	XBAFBS105	XBAFBS106
		50	10	XBAFBS505	XBAFBS506	XBAFBS505	XBAFBS506
Test adapter	—	—	10	XBATSPA14	XBATSPA14	XBATSPA14	XBATSPA14
2.3 mm diameter test plug	—	—	—	XBATSMPS-^①	XBATSMPS-^①	XBATSMPS-^①	XBATSMPS-^①
Modular test plug	—	—	10	XBATSPS5	XBATSPS6	XBATSPS5	XBATSPS6
Blank marker strip centre and external marking	White	—	10	XBMZBF5^②	XBMZBF6^②	XBMZBF5^②	XBMZBF6^②
Blank marker strip centre labeling (strip of 10)	White	—	10	XBMZB5^②	XBMZB6^②	XBMZB5^②	XBMZB6^②

Technical Data and Specifications

IDC—Single Level Terminal/Ground Blocks

Description	XBQT15	XBQT25	XBQT15PE	XBQT25PE
Technical Data in Accordance with IEC				
Maximum load current in A/cross-section in mm ²	17.5/1.5	24/2.5	—	—
Rated surge voltage in kV/contamination class	8/3	8/3	8/3	8/3
Surge voltage category/insulating material group	III/1	III/1	III/1	III/1
Connection Cross-Section				
Core insulation	PVC/PE	PVC/PE	PVC/PE	PVC/PE
Single/multiple/fine strand in mm ²	1.5	2.5	1.5	2.5
Halogen-free in mm ²	1.5	2.5	1.5	2.5
Fine strand/superfine strand in AWG (mm ²)	24–16 (0.25–0.34)	20–14 (—)	24–16 (0.25–0.34)	20–14 (—)
Repeated connections minimum 100 x in mm ²	0.25–1.5	0.5–2.5	0.25–1.5	0.5–2.5

Dimensions

Approximate Dimensions in Inches (mm)

IDC—Single Level Terminal/Ground Blocks

Catalogue Number	Width	Length	Cover Length	Height for—	
				35 x 7.5 in	35 x 15 in
XBQT15	0.20 (5.2)	2.31 (58.8)	0.09 (2.2)	1.55 (39.3)	1.84 (46.8)
XBQT25	0.24 (6.2)	2.46 (62.6)	0.09 (2.2)	1.55 (39.3)	1.84 (46.8)
XBQT15PE	0.20 (5.2)	2.31 (58.8)	0.09 (2.2)	1.55 (39.3)	1.84 (46.8)
XBQT25PE	0.24 (6.2)	2.46 (62.6)	0.09 (2.2)	1.55 (39.3)	1.84 (46.8)

Notes

① For ordering information, see **Page T42-105**.② For information on Printed Marking Tag Options, see **Page T42-98**.For additional accessories, see **Page T42-90**.

Multi-Conductor

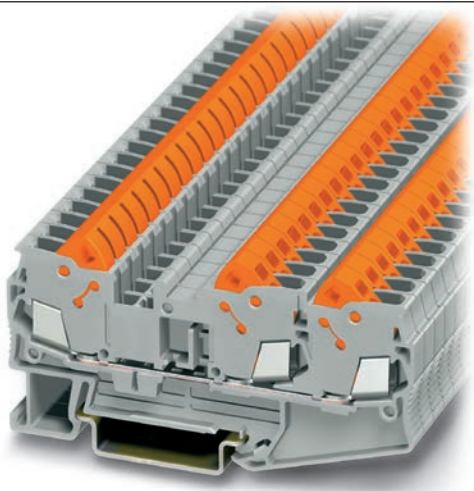

Contents

Description	Page
Single Level	T42-68
Multi-Conductor	
Accessories	T42-71
Technical Data and Specifications	T42-72
Dimensions	T42-72
Double Level	T42-73
Fuse Terminal Blocks	T42-75
Disconnect and Component Terminal Blocks	T42-77
Hybrid Terminal Blocks	T42-79

Multi-Conductor

Product Description

The XBQT IDC terminal block has the fastest connection time in a compact design. The space-saving front connection design offers additional space for wiring between the cable ducts. The double bridge shaft can

accommodate individual chain bridging and step-down bridging from other terminal blocks. The XBQT ground blocks are the same shape as the feed-through terminal blocks with the same wide range of cross-sections

available. They easily snap onto the DIN rail to make a reliable mechanical and electrical contact that meets all requirements of IEC 60-947-7-2.

Product Selection

XBQT25D12



IDC—Multi-Conductor Terminal Blocks, Three-Wire

Terminal Width	Maximum Wire Size	Connection Data in V/A/AWG	EN 50 019 ① in V/A/AWG	UL-cUL Ratings in V/A/AWG	Colour	Standard Pack	Catalogue Number
5.2 mm	16 AWG/1.5 mm ²	800/17.5/24–16	550/16/24–16	600/10/24–16	Gray	50	XBQT15D12
					Blue	50	XBQT15D12BU
6.2 mm	14 AWG/2.5 mm ²	800/24/20–14	—	600/15/20–14	Gray	50	XBQT25D12
					Blue	50	XBQT25D12BU

XBQT15D22PE



IDC—Multi-Conductor Terminal Blocks, Four-Wire

Terminal Width	Maximum Wire Size	Connection Data in V/A/AWG	EN 50 019 ① in V/A/AWG	UL-cUL Ratings in V/A/AWG	Colour	Standard Pack	Catalogue Number
5.2 mm	16 AWG/1.5 mm ²	800/17.5/24–16	550/16/24–16	600/10/24–16	Gray	50	XBQT15D22
					Blue	50	XBQT15D22BU

IDC—Multi-Conductor Terminal Blocks, Four-Wire Ground Blocks

Terminal Width	Maximum Wire Size	Connection Data in V/A/AWG	EN 50 019 ① in V/A/AWG	UL-cUL Ratings in V/A/AWG	Colour	Standard Pack	Catalogue Number
5.2 mm	16 AWG/1.5 mm ²	—/—/24–16	—/—/24–16	—/—/24–16	Green/Yellow	50	XBQT15D22PE

Note

① EU type—examination certificate number: KEMA 05ATEX2157 U (XBQT15), KEMA 05ATEX2160 U (XBQT25).

XBQT15D12PE

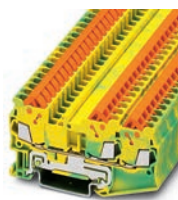

IDC—Multi-Conductor Terminal Blocks, Three-Wire Ground Blocks

Terminal Width	Maximum Wire Size	Connection Data in V/A/AWG	EN 50 019 ^① in V/A/AWG	UL-cUL Ratings in V/A/AWG	Colour	Standard Pack	Catalogue Number
5.2 mm	16 AWG/1.5 mm ²	—/—/24–16	—/—/24–16	—/—/24–16	Green/Yellow	50	XBQT15D12PE
6.2 mm	14 AWG/2.5 mm ²	—/—/20–14	—	—/—/20–14	Green/Yellow	50	XBQT25D12PE

Accessories

IDC—Multi-Conductor Terminal Blocks

Description	Colour	Number of Positions	Standard Pack	XBQT15D12 Catalogue Number	XBQT25D12 Catalogue Number	XBQT15D22 Catalogue Number
End cover	Gray	—	10	XBACQT15D12	XBACQT25D12	XBACQT15D22
End cover segment	Gray	—	10	XBASQT15	XBASQT25	XBASQT15
Partition plate	—	—	10	XBATQTD12	XBATQTD12	XBATQTD22
Plug-in bridge—for cross connections in the terminal centre	Red	2	10	XBAFBS25	XBAFBS26	XBAFBS25
		3	10	XBAFBS35	XBAFBS36	XBAFBS35
		5	10	XBAFBS55	XBAFBS56	XBAFBS55
		10	10	XBAFBS105	XBAFBS106	XBAFBS105
		50	10	XBAFBS505	XBAFBS506	XBAFBS505
Test adapter	—	—	10	XBATSPA14	XBATSPA14	XBATSPA14
2.3 mm diameter test plug	—	—	—	XBATSMPS- ^②	XBATSMPS- ^②	XBATSMPS- ^②
Modular test plug	—	—	10	XBATSPS5	XBATSPS6	XBATSPS5
Blank marker strip centre and external marking	White	—	10	XBMZBF5 ^③	XBMZBF6 ^③	XBMZBF5 ^③
Blank marker strip centre labeling (strip of 10)	White	—	10	XBMZB5 ^③	XBMZB6 ^③	XBMZB5 ^③

IDC—Multi-Conductor Terminal/Ground Blocks

Description	Colour	Number of Positions	Standard Pack	XBQT15D12PE Catalogue Number	XBQT25D12PE Catalogue Number	XBQT15D22PE Catalogue Number
End cover	Gray	—	10	XBACQT15D12	XBACQT25D12	XBACQT15D22
End cover segment	Gray	—	10	XBASQT15	XBASQT25	XBASQT15
Partition plate	—	—	10	XBATQTD12	XBATQTD12	XBATQTD22
Plug-in bridge—for cross connections in the terminal centre	Red	2	10	XBAFBS25	XBAFBS26	XBAFBS25
		3	10	XBAFBS35	XBAFBS36	XBAFBS35
		5	10	XBAFBS55	XBAFBS56	XBAFBS55
		10	10	XBAFBS105	XBAFBS106	XBAFBS105
		50	10	XBAFBS505	XBAFBS506	XBAFBS505
Test adapter	—	—	10	XBATSPA14	XBATSPA14	XBATSPA14
2.3 mm diameter test plug	—	—	—	XBATSMPS- ^②	XBATSMPS- ^②	XBATSMPS- ^②
Modular test plug	—	—	10	XBATSPS5	XBATSPS6	XBATSPS5
Blank marker strip centre and external marking	White	—	10	XBMZBF5 ^③	XBMZBF6 ^③	XBMZBF5 ^③
Blank marker strip centre labeling (strip of 10)	White	—	10	XBMZB5 ^③	XBMZB6 ^③	XBMZB5 ^③

Notes

^① EU type—examination certificate number: KEMA 05ATEX2157 U (XBQT15PE), KEMA 05ATEX2160 U (XBQT25PE).

^② For ordering information, see [Page T42-105](#).

^③ For information on Printed Marking Tag Options, see [Page T42-98](#).

For additional accessories, see [Page T42-90](#).

Technical Data and Specifications

IDC—Multi-Conductor Terminal Blocks

Description	XBQT15D12	XBQT25D12	XBQT15D12PE	XBQT25D12PE	XBQT15D22	XBQT15D22PE
Technical Data in Accordance with IEC						
Maximum load current in A/cross-section in mm ²	17.5/1.5	24/2.5	—	—	17.5/1.5	—
Rated surge voltage in kV/contamination class	8/3	8/3	8/3	8/3	8/3	8/3
Surge voltage category/insulating material group	III/I	III/I	III/I	III/I	III/I	III/I
Connection Cross-Section						
Core insulation	PVC/PE	PVC/PE	PVC/PE	PVC/PE	PVC/PE	PVC/PE
Single/multiple/fine strand in mm ²	1.5	2.5	1.5	2.5	1.5	1.5
Halogen-free in mm ²	1.5	2.5	1.5	2.5	1.5	1.5
Fine strand/superfine strand in AWG (mm ²)	24–16 (0.25–0.34)	20–14 (—)	24–16 (0.25–0.34)	20–14 (—)	24–16 (0.25–0.34)	24–16 (0.25–0.34)
Repeated connections minimum 100 x in mm ²	0.25–1.5	0.5–2.5	0.25–1.5	0.5–2.5	0.25–1.5	0.25–1.5

Dimensions

Approximate Dimensions in Inches (mm)

IDC—Multi-Conductor Terminal Blocks

Catalogue Number	Width	Length	Cover Length	Height for—	
				35 x 7.5 in	35 x 15 in
XBQT15D12	0.20 (5.2)	3.01 (76.4)	0.09 (2.2)	1.55 (39.3)	1.84 (46.8)
XBQT25D12	0.24 (6.2)	3.25 (82.5)	0.09 (2.2)	1.69 (42.8)	1.98 (50.3)
XBQT15D12PE	0.20 (5.2)	3.01 (76.4)	0.09 (2.2)	1.55 (39.3)	1.84 (46.8)
XBQT25D12PE	0.20 (5.2)	3.25 (82.5)	0.09 (2.2)	1.69 (42.8)	1.98 (50.3)
XBQT15D22	0.20 (5.2)	3.70 (94.0)	0.09 (2.2)	1.55 (39.3)	1.84 (46.8)
XBQT15D22PE	0.20 (5.2)	3.70 (94.0)	0.09 (2.2)	1.55 (39.3)	1.84 (46.8)

Double Level

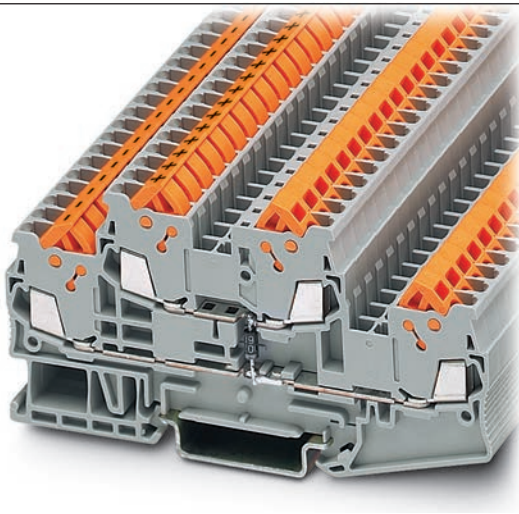

Contents

Description	Page
Single Level	T42-68
Multi-Conductor	T42-70
Double Level	
Accessories	T42-74
Technical Data and Specifications	T42-74
Dimensions	T42-74
Fuse Terminal Blocks	T42-75
Disconnect and Component Terminal Blocks	T42-77
Hybrid Terminal Blocks	T42-79

Double Level

Product Description

The XBQTT IDC terminal block has the fastest connection time in a compact design. The space-saving front connection design offers additional space for wiring between the cable ducts. The double bridge

shaft, found in each level, can accommodate individual chain bridging and step-down bridging from other terminal blocks. The XBQTT ground blocks are the same shape as the feed-through terminal blocks with the same wide

range of cross-sections available. They easily snap onto the DIN rail to make a reliable mechanical and electrical contact that meets all requirements of IEC 60-947-7-2.

Product Selection

XBQTT15

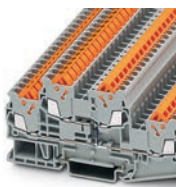

IDC—Double Level Terminal Blocks

Terminal Width	Maximum Wire Size	Connection Data in V/A/AWG	EN 50 019 ① in V/A/AWG	UL-cUL Ratings in V/A/AWG	Colour	Standard Pack	Catalogue Number
5.2 mm	16 AWG/1.5 mm ²	800/17.5/24–16	420/15/24–16	600/10/24–16	Gray	50	XBQTT15
					Blue	50	XBQTT15BU

XBQTT15PE

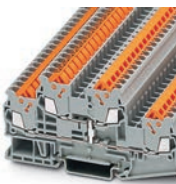

IDC—Double Level Ground Blocks

Terminal Width	Maximum Wire Size	Connection Data in V/A/AWG	EN 50 019 ① in V/A/AWG	UL-cUL Ratings in V/A/AWG	Colour	Standard Pack	Catalogue Number
6.2 mm	14 AWG/2.5 mm ²	—/—/24–16	—/—/24–16	—/—/24–16	Green/Yellow	50	XBQTT15PE

Note

① EU type—examination certificate number: KEMA 05ATEX2157 U (XBQTT15), KEMA 05ATEX2160 U (XBQTT25).

Accessories

IDC—Double Level Terminal/Ground Blocks

Description	Colour	Number of Positions	Standard Pack	XBQTT15 Catalogue Number	XBQTT15PE Catalogue Number
End cover	Gray	—	10	XBACQTT15	XBACQTT15
Partition plate	—	—	10	XBATQTT15	XBATQTT15
Plug-in bridge—for cross connections in the terminal centre	Red	2	10	XBAFBS25	XBAFBS25
		3	10	XBAFBS35	XBAFBS35
		5	10	XBAFBS55	XBAFBS55
		10	10	XBAFBS105	XBAFBS105
		20	10	XBAFBS505	XBAFBS505
Test adapter	—	—	10	XBATSPA14	XBATSPA14
2.3 mm diameter test plug	—	—	—	XBATSMPS- ^①	XBATSMPS- ^①
Modular test plug	—	—	10	XBATSPS5	XBATSPS5
Blank marker strip	White	—	10	XBMZBF5 ^②	XBMZBF5 ^②

Technical Data and Specifications

IDC—Double Level Terminal/Ground Blocks

Description	XBQTT15	XBQTT15PE
Technical Data in Accordance with IEC		
Maximum load current in A/cross-section in mm ²	17.5/1.5	—
Rated surge voltage in kV/contamination class	6/3	6/3
Surge voltage category/insulating material group	III/I	III/I
Connection Cross-Section		
Core insulation	PVC/PE	PVC/PE
Single/multiple/fine strand in mm ²	1.5	1.5
Halogen-free in mm ²	1.5	1.5
Fine strand/superfine strand in AWG (mm ²)	24–16 (0.25–0.34)	24–16 (0.25–0.34)
Repeated connections minimum 100 x in mm ²	0.25–1.5	0.25–1.5

Dimensions

Approximate Dimensions in Inches (mm)

IDC—Double Level Terminal/Ground Blocks

Catalogue Number	Width	Length	Cover Length	Height for—	
				35 x 7.5 in	35 x 15 in
XBQTT15	0.20 (5.2)	3.92 (99.6)	0.09 (2.2)	1.96 (49.9)	2.26 (57.4)
XBQTT15PE	0.20 (5.2)	3.92 (99.6)	0.09 (2.2)	1.96 (49.9)	2.26 (57.4)

Notes

① For ordering information, see Page T42-105.

② For information on Printed Marking Tag Options, see Page T42-98.

For additional accessories, see Page T42-90.

Fuse Terminal Blocks



Contents

Description	Page
Single Level	T42-68
Multi-Conductor	T42-70
Double Level	T42-73
Fuse Terminal Blocks	
Accessories	T42-76
Technical Data and Specifications	T42-76
Dimensions	T42-76
Disconnect and Component Terminal Blocks	T42-77
Hybrid Terminal Blocks	T42-79

Fuse Terminal Blocks

Product Description

The XBQT lever-type fuse terminal blocks perform two main functions. It is a carrier for a 5 x 20 mm cartridge fuse insert and can also allow for potential distribution via the double bridge shaft.

This means that two potentials can be carried separately alongside each other. Versions with light indication (AC and DC voltage) are available to signal a triggered fuse.

Product Selection

XBQT25FB



IDC—Fuse Terminal Blocks

Terminal Width	Maximum Wire Size	Connection Data in V/A/AWG	UL-cUL Ratings in V/A/AWG	Colour	Standard Pack	Catalogue Number
IDC Fuse Terminal Blocks						
6.2 mm	14 AWG/2.5 mm ²	①/6.3/20–14	300/15/20–14	Black	50	XBQT25FBE
IDC Fuse Terminal Blocks with LED 12–30V, 1–2.5 mA						
6.2 mm	14 AWG/2.5 mm ²	①/6.3/20–14	300/15/20–14	Black	50	XBQT25FBEL24
IDC Fuse Terminal Blocks with LED 30–60V, 0.8–2.0 mA						
6.2 mm	14 AWG/2.5 mm ²	①/6.3/20–14	300/15/20–14	Black	50	XBQT25FBEL60
IDC Fuse Terminal Blocks with LED 110–250V, 0.5–2.5 mA						
6.2 mm	14 AWG/2.5 mm ²	①/6.3/20–14	300/15/20–14	Black	50	XBQT25FBEL250

Note

① As disconnect terminal block, 400V; as fuse terminal blocks 250V.

Accessories

IDC—Fuse Terminal Blocks

Description	Colour	Number of Positions	Standard Pack	XBQT25FBE Catalogue Number
End cover	Gray	—	10	XBACQT25D12
Partition plate	—	—	10	XBATQTD12
Plug-in bridge—for cross connections in the terminal centre	Red	2	10	XBAFBS26
		3	10	XBAFBS36
		5	10	XBAFBS56
		10	10	XBAFBS106
Test adapter	—	—	10	XBATSPA14
2.3 mm diameter test plug	—	—	—	XBATSMPS- ^①
Modular test plug	—	—	10	XBATSPS5
Blank marker strip centre and external marking	White	—	10	XBMZBF6 ^②
Blank marker strip lever labeling	White	—	10	XBMZB5 ^②
Blank marker strip centre labeling (strip of 10)	White	—	10	XBMZB6 ^②

Technical Data and Specifications

IDC—Fuse Terminal Blocks

Description	XBQT25FBE
Technical Data in Accordance with IEC	
Maximum load current in A/cross-section in mm ²	6.3/2.5
Rated surge voltage in kV/contamination class	4/3
Surge voltage category/insulating material group	III/I
Connection Cross-Section	
Core insulation	PVC/PE
Single/multiple/fine strand in mm ²	2.5
Halogen-free in mm ²	2.5
Fine strand/superfine strand in AWG (mm ²)	24–14 (—)
Repeated connections minimum 100 x in mm ²	0.5–2.5

Dimensions

Approximate Dimensions in Inches (mm)

IDC—Fuse Terminal Blocks

Catalogue Number	Width	Length	Cover Length	Height for—	
				35 x 7.5 in	35 x 15 in
XBQT25FBE	0.24 (6.2)	3.25 (82.5)	0.09 (2.2)	1.69 (42.8)	1.98 (50.3)

Notes

^① For ordering information, see **Page T42-105**.

^② For information on Printed Marking Tag Options, see **Page T42-98**.

For additional accessories, see **Page T42-90**.

Disconnect and Component Terminal Blocks

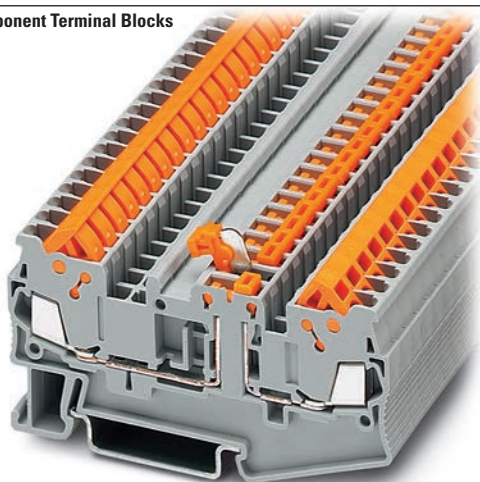

Contents

Description	Page
Single Level	T42-68
Multi-Conductor	T42-70
Double Level	T42-73
Fuse Terminal Blocks	T42-75
Disconnect and Component Terminal Blocks	
Accessories	T42-78
Technical Data and Specifications	T42-78
Dimensions	T42-78
Hybrid Terminal Blocks	T42-79

Disconnect and Component Terminal Blocks

Product Description

The **XB** Series includes application specific terminal blocks like disconnect blocks. The knife disconnect terminal blocks (XBQT15MT) has a fitted knife. The XBQT15TG

can accommodate component plugs for resistors or capacitors and fuse plugs for 5 x 20 mm fuses with or without a light indicator for signaling a triggered fuse.

Both terminal blocks have three bridge shafts—two in the standard positions and one on the other side of the disconnect point.

Product Selection

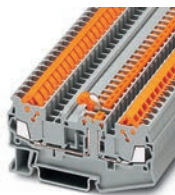
XBQT15MT
Knife Disconnect

IDC—Disconnect and Component Terminal Blocks

Terminal Width	Maximum Wire Size	Connection Data in V/A/AWG	UL-cUL Ratings in V/A/AWG	UL-cUL Ratings for Disconnect in V/A/AWG	UL-cUL Ratings for Disconnect with Test Sockets in V/A/AWG	Colour	Standard Pack	Catalogue Number
Knife Disconnect								
5.2 mm	16 AWG/1.5 mm ²	400/16/24–16	600/10/24–16	—	—	Gray	50	XBQT15MT
Component Disconnect								
5.2 mm	16 AWG/1.5 mm ²	400/16/24–16	600/10/24–16	—	—	Gray	50	XBQT15TG
6.2 mm	14 AWG/2.5 mm ²	400/16/20–14	300/10/20–14	—	—	Gray	50	XBQT25TG
Component Plug								
6.2 mm	10 AWG/4 mm ²	500/16/26–10	—	600/16/26–10	300/16/26–10	Gray	10	XBPCO
Fuse Plug								
6.2 mm	10 AWG/4 mm ²	500/16/26–10	—	600/16/26–10	300/16/26–10	Black	10	XBPFU
Fuse Plug with Light Indicator for 12–30V, 1–2.5 mA								
6.2 mm	10 AWG/4 mm ²	500/16/26–10	—	600/16/26–10	300/16/26–10	Black	10	XBPFUL24
Fuse Plug with Light Indicator for 110–250V, 0.5–2.5 mA								
6.2 mm	10 AWG/4 mm ²	500/16/26–10	—	600/16/26–10	300/16/26–10	Black	10	XBPFUL250

Accessories

IDC—Disconnect and Component Terminal Blocks

Description	Colour	Number of Positions	Standard Pack	XBQT15MT Catalogue Number	XBQT15TG Catalogue Number	XBQT25TG Catalogue Number
End cover	Gray	—	10	XBACQT15D12	XBACQT15D12	XBACQT25D12
End cover segment	Gray	—	10	XBASQT15	XBASQT15	XBASQT25
Partition plate	—	—	10	XBATQTD12	XBATQTD12	XBATQTD12
Plug-in bridge	Red	2	10	XBAFBS25	XBAFBS25	XBAFBS26
		3	10	XBAFBS35	XBAFBS35	XBAFBS36
		5	10	XBAFBS55	XBAFBS55	XBAFBS56
		10	10	XBAFBS105	XBAFBS105	XBAFBS106
Test adapter	—	—	10	XBATSPA14	XBATSPA14	XBATSPA14
2.3 mm diameter test plug	—	—	—	XBATSMPS_ ^①	XBATSMPS_ ^①	XBATSMPS_ ^①
Modular test plug	—	—	10	XBATSPS5	XBATSPS5	XBATSPS5
Blank marker strip centre and external marking	White	—	10	XBMZBF5 ^②	XBMZBF5 ^②	XBMZBF6 ^②
Blank marker strip centre labeling (strip of 10)	White	—	10	XBMZB5 ^②	XBMZB5 ^②	XBMZB6 ^②

Technical Data and Specifications

IDC—Disconnect and Component Terminal Blocks

Description	XBQT15MT	XBQT15TG	XBQT25TG
Technical Data in Accordance with IEC			
Maximum load current in A/cross-section in mm ²	16/1.5	16/1.5	16/2.5
Rated surge voltage in kV/contamination class	6/3	6/3	6/3
Surge voltage category/insulating material group	III/I	III/I	III/I
Connection Cross-Section			
Core insulation	PVC/PE	PVC/PE	PVC/PE
Single/multiple/fine strand in mm ²	1.5	1.5	2.5
Halogen-free in mm ²	1.5	1.5	2.5
Fine strand/superfine strand in AWG (mm ²)	24–16 (0.25–0.34)	24–16 (0.25–0.34)	20–14 (—)
Repeated connections minimum 100 x in mm ²	0.25–1.5	0.25–1.5	0.5–2.5

Dimensions

Approximate Dimensions in Inches (mm)

IDC—Disconnect and Component Terminal Blocks

Catalogue Number	Width	Length	Cover Length	Height for—	
				35 x 7.5 in	35 x 15 in
XBQT15MT	0.20 (5.2)	3.01 (76.4)	0.09 (2.2)	1.55 (39.3)	1.84 (46.8)
XBQT15TG	0.20 (5.2)	3.01 (76.4)	0.09 (2.2)	1.55 (39.3)	1.84 (46.8)
XBQT25TG	0.24 (6.2)	3.25 (82.5)	0.09 (2.2)	1.69 (42.8)	1.98 (50.3)

Notes

① For ordering information, see **Page T42-105**.② For information on Printed Marking Tag Options, see **Page T42-98**.For additional accessories, see **Page T42-90**.

Hybrid Terminal Blocks

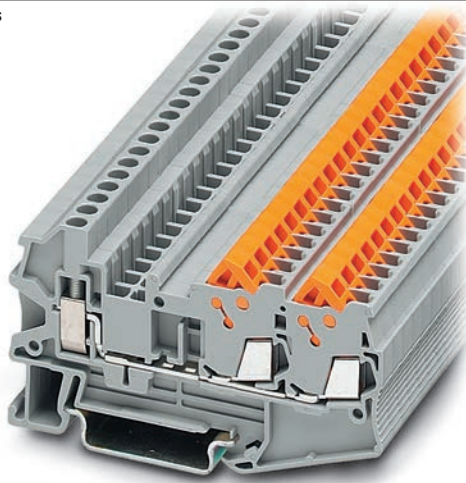

Contents

Description	Page
Single Level	T42-68
Multi-Conductor	T42-70
Double Level	T42-73
Fuse Terminal Blocks	T42-75
Disconnect and Component Terminal Blocks	T42-77
Hybrid Terminal Blocks	
Accessories	T42-80
Technical Data and Specifications	T42-81
Dimensions	T42-81

Hybrid Terminal Blocks

Product Description

The XBQT hybrid terminal blocks offer the best of both worlds. One side offers the time-saving advantage of our insulation displacement

connection technology, while the other side offers a universal screw connection. Use the IDC side on the internal (factory) control

cabinet side and the screw connection on the end customer (field) side. Ground terminal blocks of the same shape are also available

Product Selection

XBQU25

IDC—Hybrid Terminal Blocks, Single Level



Terminal Width	Maximum Wire Size	IEC Screw Connection in V/A/AWG	IEC IDC Connection in V/A/AWG	UL-cUL Screw Connection in V/A/AWG	UL-cUL IDC Connection in V/A/AWG	Colour	Standard Pack	Catalogue Number
5.2 mm	12 AWG/2.5 mm ²	800/17.5/26–12	800/17.5/24–16	600/10/26–12	600/10/24–16	Gray	50	XBQU15
6.2 mm	10 AWG/4 mm ²	800/24/26–10	800/24/20–14	600/15/26–10	600/15/20–14	Gray	50	XBQU25

XBQU15D12

IDC—Hybrid Terminal Blocks, Three-Wire



Terminal Width	Maximum Wire Size	IEC Screw Connection in V/A/AWG	IEC IDC Connection in V/A/AWG	UL-cUL Screw Connection in V/A/AWG	UL-cUL IDC Connection in V/A/AWG	Colour	Standard Pack	Catalogue Number
5.2 mm	12 AWG/2.5 mm ²	800/17.5/26–12	800/17.5/24–16	800/10/26–12	800/10/24–16	Gray	50	XBQU15D12
6.2 mm	10 AWG/4 mm ²	800/24/26–10	800/24/20–14	600/15/26–10	600/15/20–14	Gray	50	XBQU25D12

XBQU25PE

IDC—Hybrid Terminal/Ground Blocks



Terminal Width	Maximum Wire Size	IEC Screw Connection in V/A/AWG	IEC IDC Connection in V/A/AWG	UL-cUL Screw Connection in V/A/AWG	UL-cUL IDC Connection in V/A/AWG	Colour	Standard Pack	Catalogue Number
5.2 mm	12 AWG/2.5 mm ²	—/—/26–12	—/—/24–16	—/—/26–12	—/—/24–16	Gray	50	XBQU15PE
6.2 mm	10 AWG/4 mm ²	—/—/26–10	—/—/20–14	—/—/26–10	—/—/20–14	Gray	50	XBQU25PE

Accessories

IDC—Hybrid Terminal Blocks

Description	Colour	Number of Positions	Standard Pack	XBQU15 Catalogue Number	XBQU25 Catalogue Number	XBQU15D12 Catalogue Number	XBQU25D12 Catalogue Number
End cover	Gray	—	10	XBACQU15	XBACQU25	XBACQU15D12	XBACQU25D12
End segment	Gray	—	10	—	—	XBASQT15	XBASQT25
Partition plate	—	—	10	XBATQT25	XBATQT25	XBATQTD12	XBATQTD12
Plug-in bridge—for cross connections in the bridge shaft	Red	2	10	XBAFBS25	XBAFBS26	XBAFBS25	XBAFBS26
		3	10	XBAFBS35	XBAFBS36	XBAFBS35	XBAFBS36
		5	10	XBAFBS55	XBAFBS56	XBAFBS55	XBAFBS56
		10	10	XBAFBS105	XBAFBS106	XBAFBS105	XBAFBS106
		50	10	XBAFBS505	XBAFBS506	XBAFBS505	XBAFBS506
Test adapter	—	—	10	XBATSPA14	XBATSPA14	XBATSPA14	XBATSPA14
2.3 mm diameter test plug	—	—	—	XBATSMPS- ^①	XBATSMPS- ^①	XBATSMPS- ^①	XBATSMPS- ^①
Modular test plug	—	—	10	XBATSPS5	XBATSPS6	XBATSPS5	XBATSPS6
Blank marker strip centre and external marking	White	—	10	XBMZBF5 ^②	XBMZBF6 ^②	XBMZBF5 ^②	XBMZBF6 ^②
Blank marker strip centre labeling (strip of 10)	—	—	—	XBMZB5 ^②	XBMZB6 ^②	XBMZB5 ^②	XBMZB6 ^②

IDC—Hybrid Terminal/Ground Blocks

Description	Colour	Number of Positions	Standard Pack	XBQU15PE Catalogue Number	XBQU25PE Catalogue Number
End cover	Gray	—	10	XBACQU15	XBACQU25
Partition plate	—	—	10	XBATQT25	XBATQT25
Plug-in bridge—for cross connections in the bridge shaft	Red	2	10	XBAFBS25	XBAFBS26
		3	10	XBAFBS35	XBAFBS36
		5	10	XBAFBS55	XBAFBS56
		10	10	XBAFBS105	XBAFBS106
		50	10	XBAFBS505	XBAFBS506
Test adapter	—	—	10	XBATSPA14	XBATSPA14
2.3 mm diameter test plug	—	—	—	XBATSMPS- ^①	XBATSMPS- ^①
Modular test plug	—	—	10	XBATSPS5	XBATSPS6
Blank marker strip centre and external marking	White	—	10	XBMZBF5 ^②	XBMZBF6 ^②
Blank marker strip centre labeling (strip of 10)	—	—	—	XBMZB5 ^②	XBMZB6 ^②

Notes

^① For ordering information, see **Page T42-105**.

^② For information on Printed Marking Tag Options, see **Page T42-98**.

For additional accessories, see **Page T42-90**.

Technical Data and Specifications

Screw Connection Single Level—Through-Feed

Description	XBQU15	XBQU25	XBQU15PE	XBQU25PE	XBQU15D12	XBQU25D12
Technical Data in Accordance with IEC						
Maximum load current in A/cross-section in mm ²	17.5/1.5	24/2.5	—	—	17.5/1.5	24/2.5
Rated surge voltage in kV/contamination class	8/3	8/3	8/3	8/3	8/3	8/3
Surge voltage category/insulating material group	III/I	III/I	III/I	III/I	III/I	III/I
Connection Cross-Section						
Core insulation	PVC/PE	PVC/PE	PVC/PE	PVC/PE	PVC/PE	PVC/PE
Single/multiple/fine strand in mm ²	1.5	2.5	1.5	2.5	1.5	2.5
Halogen-free in mm ²	1.5	2.5	1.5	2.5	1.5	2.5
Fine strand/superfine strand in AWG (mm ²)	24–16 (0.25–0.34)	20–14 (—)	24–16 (0.25–0.34)	20–14 (—)	24–16 (0.25–0.34)	20–14 (—)
Repeated connections minimum 100 x in mm ²	0.25–1.5	0.5–2.5	0.25–1.5	0.5–2.5	0.25–1.5	0.5–2.5
Connection Capacity—Screw Connection						
Stranded with ferrule/with ferrule and plastic sleeve in mm ²	0.25–2.5/0.25–2.5	0.25–4/0.25–4	0.25–2.5/0.25–2.5	0.25–4/0.25–4	0.25–2.5/0.25–2.5	0.25–4/0.25–4
Multi-Conductor Connection (same cross-section)						
Solid/stranded in mm ²	0.14–1.5/0.14–1.5	0.14–1.5/0.14–1.5	0.14–1.5/0.14–1.5	0.14–1.5/0.14–1.5	0.14–1.5/0.14–1.5	0.14–1.5/0.14–1.5
Stranded with ferrules without plastic sleeve in mm ²	0.25–1.5	0.25–1.5	0.25–1.5	0.25–1.5	0.25–1.5	0.25–1.5
Stranded with twin ferrule with plastic sleeve in mm ²	0.5–1.5	0.5–2.5	0.5–1.5	0.5–2.5	0.5–1.5	0.5–2.5
Stripping length in inches (mm)	0.35 (9)	0.35 (9)	0.35 (9)	0.35 (9)	0.35 (9)	0.35 (9)
Thread	M3	M3	M3	M3	M3	M3
Torque in in-lb (Nm)	5.3–7.1 (0.6–0.8)	5.3–7.1 (0.6–0.8)	5.3–7.1 (0.6–0.8)	5.3–7.1 (0.6–0.8)	5.3–7.1 (0.6–0.8)	5.3–7.1 (0.6–0.8)

Dimensions

Approximate Dimensions in Inches (mm)

Screw Connection Single Level—Through-Feed

Catalogue Number	Width	Length	Cover Width	Height for—	
				35 x 7.5 in	35 x 15 in
XBQU15	0.20 (5.2)	2.31 (58.8)	0.09 (2.2)	1.69 (42.8)	1.98 (50.3)
XBQU25	0.24 (6.2)	2.46 (62.6)	0.09 (2.2)	1.69 (42.8)	1.98 (50.3)
XBQU15PE	0.20 (5.2)	2.31 (58.8)	0.09 (2.2)	1.69 (42.8)	1.98 (50.3)
XBQU25PE	0.24 (6.2)	2.46 (62.6)	0.09 (2.2)	1.69 (42.8)	1.98 (50.3)
XBQU15D12	0.20 (5.2)	3.01 (76.4)	0.09 (2.2)	1.69 (42.8)	1.98 (50.3)
XBQU25D12	0.24 (6.2)	3.25 (82.5)	0.09 (2.2)	1.69 (42.8)	1.98 (50.3)

Miniature Circuit Breakers



42

Contents

Description

Page

Miniature Circuit Breakers	
Circuit Breakers.	T42-83
Flat-Type Fuse Terminal Blocks.	T42-86
Spring Cage Fuse Terminal Blocks	T42-88

Miniature Circuit Breakers Overview

Product Description

The new **XB** Series thermal miniature circuit breaker offers convenient overload protection. This space-saving single-pole circuit breaker, available up to 10 amps, can be inserted into a screw connection fuse terminal block, XBUK6FSI, or a spring cage fuse terminal block, XBPT4FSI, which is available with or without light indication. The XBATCP combines the

reclosing capability of a circuit breaker with the overload protection of a fuse. The integrated switching function makes it possible to switch the circuit breaker back on immediately, guaranteeing system availability. The device can also be used for switching purposes, as an ON/OFF switch. The Plug-in design allows for quick and efficient replacement.

Standards and Certifications

- UL and cUL recognized
- UL 1077—File No. E301915
- CE approved



Circuit Breakers



Contents

Description	Page
Circuit Breakers	
Accessories	T42-84
Technical Data and Specifications	T42-84
Time/Current Curve	T42-85
Dimensions	T42-85
Flat-Type Fuse Terminal Blocks	T42-86
Spring Cage Fuse Terminal Blocks	T42-88

Circuit Breakers

Product Description

The thermal miniature circuit breaker can be switched back on again, has a compact design, and is available

in 10 finely graded steps for nominal currents from 0.1 to 10A.

Product Selection

XBAT

Thermal Miniature Circuit Breaker

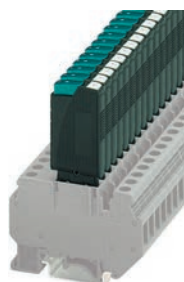

Connection Data in Vac/Vdc	Nominal Current	Colour	Standard Pack	Catalogue Number
250/65	0.1A	Black	20	XBATCPT
	0.25A	Black	20	XBATCPQ
	0.5A	Black	20	XBATCPH
	1.0A	Black	20	XBATCP1
	2.0A	Black	20	XBATCP2
	3.0A	Black	20	XBATCP3
	4.0A	Black	20	XBATCP4
	6.0A	Black	20	XBATCP6
	8.0A	Black	20	XBATCP8
	10.0A	Black	20	XBATCP10

Accessories

Thermal Miniature Circuit Breaker

Description	Colour	Number of Positions	Standard Pack	XBAT Catalogue Number
Blank marker strip	White	—	10	XBZBF5 ①
Flat type terminal blocks	—	—	—	XBUK6FSI XBUK6FSIL12 XBUK6FSIL24 XBPT4FSI XBPT4FSIL12 XBPT4FSIL24

Technical Data and Specifications

Thermal Miniature Circuit Breaker

Description	XBAT
Technical Data in Accordance with IEC	
Nominal voltage in Vac/Vdc	250/65
Nominal current in A	0.25–10
Ambient temperature	–4 to 140°F (–20 to 60°C)
Maximum Power Dissipation	
Rated surge voltage in kV/contamination class	2.5/2
Surge voltage category/insulating material group	III/I
Switching Capacity	
Cycles with 1 x I _N (low-induction)	6000
Cycles with 1 x I _N (induction)	3000
Cycles with 2 x I _N (induction)	500
Switching Capacity I CN	
For nominal currents of 0.25–4A/6–10A	6 x I _N /8 x I _N
Switching capacity (UL 1077) 250 Vac/65 Vdc	2000/200

Nominal Currents and Internal Resistances

Nominal Current (A)	Internal Resistance (3/4)
0.25	14
0.5	3.4
1.0	0.9
2.0	0.25
3.0	0.11
4.0	0.07
6.0	≤0.05
8.0	≤0.05
10.0	≤0.05

Note

① For information on Printed Marking Tag Options, see **Page T42-98**.

Time/Current Curve

Total Switch-Off Period for Nominal Current, 73.4°F (23°C)

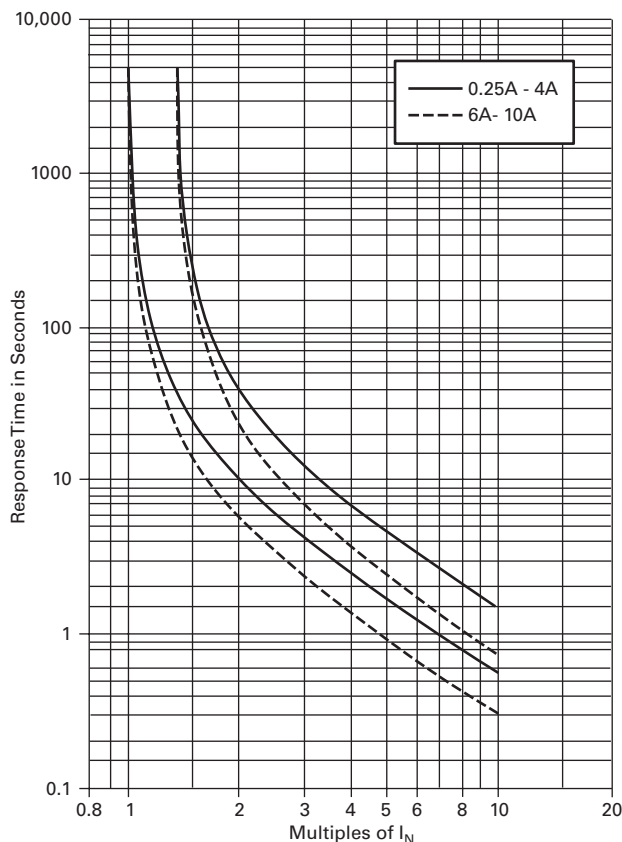

Note: When mounted in rows, the nominal current of the devices can only be transmitted at 80% or must be correspondingly over-dimensioned.

Temperature Factor

Ambient Temperature	Temperature Factor
-4°F (-20°C)	0.76
14°F (-10°C)	0.84
32°F (0°C)	0.91
73.4°F (23°C)	1.00
104°F (40°C)	1.08
122°F (50°C)	1.16
140°F (60°C)	1.24

Dimensions

Approximate Dimensions in Inches (mm)

XBUK6FSI with XBAT

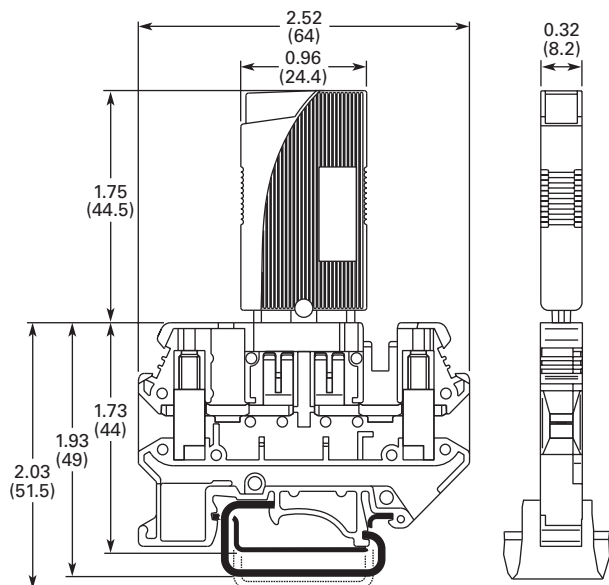

XBPT4FSI with XBAT

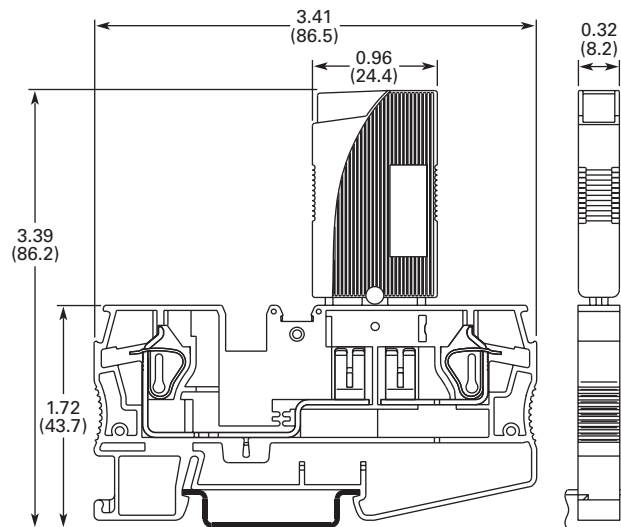

Flat-Type Fuse Terminal Blocks

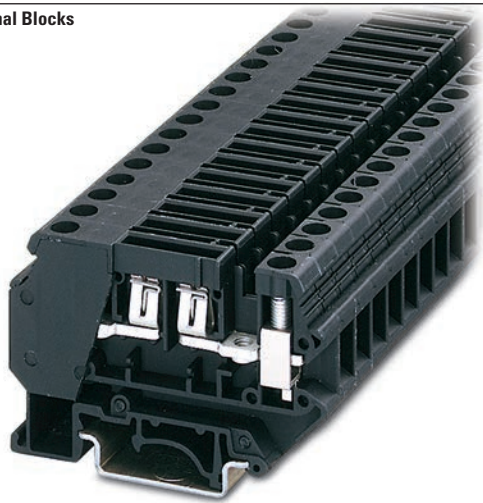

Contents

Description	Page
Circuit Breakers	T42-83
Flat-Type Fuse Terminal Blocks	
Accessories	T42-86
Technical Data and Specifications	T42-87
Dimensions	T42-87
Spring Cage Fuse Terminal Blocks	T42-88

Flat-Type Fuse Terminal Blocks

Product Description

The fuse terminal blocks can be used as a basic terminal blocks for the XBAT overload miniature circuit breaker, see **Page T42-83**.

Product Selection

XBUK6FSI

Screw Connection Flat-Type Fuse Terminal Blocks



Terminal Width	Maximum Wire Size	Connection Data in V/A/AWG	UL-cUL Ratings in V/A/AWG	Colour	Standard Pack	Catalogue Number
Flat-Type Fuse Terminal Block						
8.2 mm	8 AWG/6 mm ²	250/—/24–8	300/30/26–8	Black	50	XBUK6FSI
Flat-Type Fuse Terminal Block with LED, Red 12 Vdc, 2.0 mA						
8.2 mm	8 AWG/6 mm ²	250/—/24–8	300/30/26–8	Black	50	XBUK6FSIL12
Flat-Type Fuse Terminal Block with LED, Red 24 Vdc, 2.0 mA						
8.2 mm	8 AWG/6 mm ²	250/—/24–8	300/30/26–8	Black	50	XBUK6FSIL24

Accessories

Flat-Type Fuse Terminal Blocks

Description	Colour	Number of Positions	Standard Pack	XBUK6FSI Catalogue Number	XBUK6FSIL_ Catalogue Number
Blank marker strip	White	—	10	XBMZB8 ①	XBMZB8 ①

Note

① For information on Printed Marking Tag Options, see **Page T42-98**.

Technical Data and Specifications

Flat-Type Fuse Terminal Blocks

Description	XBUK6FSI	XBUK6FSIL ₂
Technical Data in Accordance with IEC		
Fuse type ISO	C	C
Maximum current with single arrangement in A	30	30
Maximum Power Dissipation		
Rated surge voltage in kV/contamination class	4/3	4/3
Surge voltage category/insulating material group	III/I	III/I
Connection Capacity		
Stranded with ferrule with plastic sleeve in mm ²	0.25–4	0.25–4
Stranded with ferrule without plastic sleeve in mm ²	0.25–6	0.25–6
Stranded with twin ferrule with plastic sleeve in mm ²	—	—
Multi-Conductor Connection (same cross-section)		
Solid/stranded in mm ²	0.2–2.5/0.2–2.5	0.2–2.5/0.2–2.5
Stranded with ferrules without plastic sleeve in mm ²	0.25–2.5	0.25–2.5
Stranded with twin ferrule with plastic sleeve in mm ²	0.5–4.0	0.5–4.0
Stripping length in inches (mm)	0.39 (10)	0.39 (10)
Thread	M4	M4
Torque in in-lb (Nm)	13.3–14.2 (1.5–1.6)	13.3–14.2 (1.5–1.6)

Dimensions

Approximate Dimensions in Inches (mm)

Flat-Type Fuse Terminal Blocks

Catalogue Number	Width	Length	Height for—		
			32 in	35 x 7.5 in	35 x 15 in
XBUK6FSI	0.32 (8.2)	2.91 (74.0)	2.24 (57.0)	2.05 (52.0)	2.34 (59.5)
XBUK6FSIL ₁₂	0.32 (8.2)	2.91 (74.0)	2.24 (57.0)	2.05 (52.0)	2.34 (59.5)
XBUK6FSIL ₂₄	0.32 (8.2)	2.91 (74.0)	2.24 (57.0)	2.05 (52.0)	2.34 (59.5)

Spring Cage Fuse Terminal Blocks

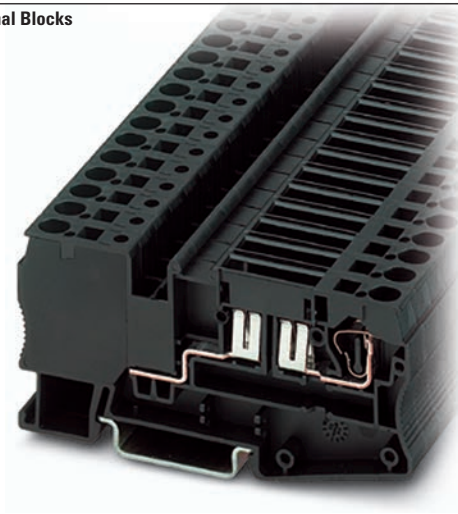

Contents

Description	Page
Circuit Breakers	T42-83
Flat-Type Fuse Terminal Blocks	T42-86
Spring Cage Fuse Terminal Blocks	
Accessories	T42-88
Technical Data and Specifications	T42-89
Dimensions	T42-89

Spring Cage Fuse Terminal Blocks

Product Description

Flat-type fuses or the XBAT miniature circuit breaker (see **Page T42-83**) can be used as the fuse element in these XBPT

Spring Cage Fuse Terminal Blocks. Terminal blocks with a light indicator are available for quick error diagnosis.

Product Selection

XBPT4FSI



Spring Cage Fuse Terminal Blocks

Terminal Width	Maximum Wire Size	Connection Data in V/A/AWG	UL-cUL Ratings in V/A/AWG	Colour	Standard Pack	Catalogue Number
Spring Cage Fuse Terminal Block						
8.2 mm	10 AWG/4 mm ²	400/30/28–10	300/30/24–10	Black	50	XBPT4FSI
Spring Cage Fuse Terminal Block with LED, Red 12 Vdc, 2.0 mA						
8.2 mm	10 AWG/4 mm ²	400/30/28–10	300/30/24–10	Black	50	XBPT4FSIL12
Spring Cage Fuse Terminal Block with LED, Red 24 Vdc, 2.0 mA						
8.2 mm	10 AWG/4 mm ²	400/30/28–10	300/30/24–10	Black	50	XBPT4FSIL24

Accessories

Flat-Type Fuse Terminal Blocks

Description	Colour	Number of Positions	Standard Pack	XBPT4FSI Catalogue Number	XBPT4FSIL_ Catalogue Number
Test adapter	—	—	10	XBATSPA14	XBATSPA14
2.3 mm diameter test plug	—	—	—	XBATSMPS-^①	XBATSMPS-^①
Modular test plug	—	—	10	XBATSPS8	XBATSPS8
Blank marker strip centre and external marking	White	—	10	XBZBF8^②	XBZBF8^②
Blank marker strip centre labeling (strip of 10)	White	—	10	XBZB8^②	XBZB8^②

Notes

- ① For ordering information, see **Page T42-105**
- ② For information on Printed Marking Tag Options, see **Page T42-98**.

Technical Data and Specifications

Flat-Type Fuse Terminal Blocks

Description	XBPT4FSI	XBPT4FSIL_
Technical Data in Accordance with IEC		
Fuse type ISO	C	C
Maximum current with single arrangement in A	30	30
Maximum Power Dissipation		
Rated surge voltage in kV/contamination class	6/3	6/3
Surge voltage category/insulating material group	III/1	III/1
Connection Capacity		
Stranded with ferrule with plastic sleeve in mm ²	0.25–4	0.25–4
Stranded with ferrule without plastic sleeve in mm ²	0.25–4	0.25–4
Stranded with twin ferrule with plastic sleeve in mm ²	0.5	0.5
Stripping length in inches (mm)	0.39 (10)	0.39 (10)

Dimensions

Approximate Dimensions in Inches (mm)

Flat-Type Fuse Terminal Blocks

Catalogue Number	Width	Length	Height for—	
			35 x 7.5 in	35 x 15 in
XBPT4FSI	0.32 (8.2)	3.41 (86.5)	1.71 (43.5)	2.01 (51.0)
XBPT4FSIL12	0.32 (8.2)	3.41 (86.5)	1.71 (43.5)	2.01 (51.0)
XBPT4FSIL24	0.32 (8.2)	3.41 (86.5)	1.71 (43.5)	2.01 (51.0)

XB Series Accessories

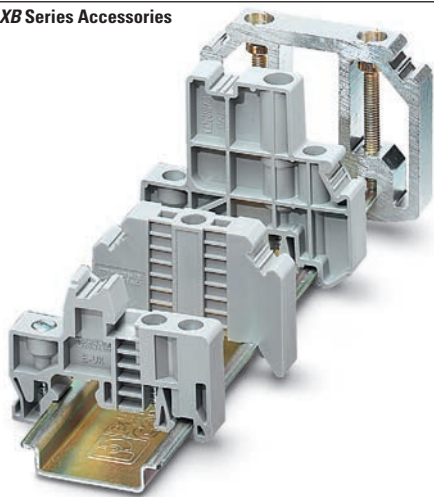

Contents

Description	Page
XB Series Accessories	
End Stops	T42-91
DIN Rails	T42-92
Angled Mounting Brackets	T42-93
Ferrules	T42-94
Hand Tools	T42-97
Marking Accessories	T42-98
Testing Accessories	T42-105
Separating Plates, Covers and Bridges	T42-105

XB Series Accessories Overview

End Stops

The end stop provides an anchor point at each end of the rail assembly by attaching directly to the DIN rail. A wide range of end stop options are available, including those that mount with one or multiple screws and those that do not require screws for mounting. End stops also have a location for marking material to be placed.

DIN Rail

Eaton offers ways for time-saving and secure mounting of components needed for electrical connections. DIN rail provides the basis for the inner design of the control cabinet and ensures a firm hold of the rail-mountable components. Eaton offers a wide range of standard DIN rails sizes and materials, solid or slotted. Or, contact us about custom lengths of pre-cut rail or ordering pre-drilled rail. The DIN rails are designed in accordance with the European standard EN 60715.

Angled Mounting Brackets

Angled mounting brackets are used to mount DIN rail at a more accessible angle for wiring and troubleshooting.

Ferrules

Ferrules are available with or without an insulating sleeve. The plastic insulating sleeve simplifies the fitting of the conductor and the colour indicates the size of the cross-section. The closer the connections are, the more reliable the insulation is and the less likely the wires are to splice. Twin ferrules are also available allowing two wires to be easily compressed in one ferrule. Chain bridging, frequently used in industry, becomes easier with twin ferrules.

Hand Tools

Eaton offers an array of hand tools to make it easier to work with our terminal blocks. The XBTCUTSTP tool is recommended for cutting and stripping PVC insulated wires. The ergonomically shaped crimping pliers, XBTCRMP66, result in fatigue-free work by spreading the manual force equally between the six jaws. The XBTDVR screwdrivers have a rotating cap that prevents user discomfort even at high torques and allows rapid rotation. The ergonomically shaped handle further aids the user's comfort. The blade is made from CVM steel, hardened and chrome-plated.

Marking Accessories

The marking system provides logical and clear identification of the modular terminal blocks and interface modules. The blank marker strip is designed for marking terminal blocks, equipment and smaller modules with marker grooves. The marker strip is available in all common pitches in printed and unprinted versions.

Testing Accessories

The range of test accessories available includes different test plugs, so that an optimum solution can be realized for every application. In addition to pre-assembled test plugs, plugs are also available that can be configured individually to form test adapters.

End Stops

Product Selection

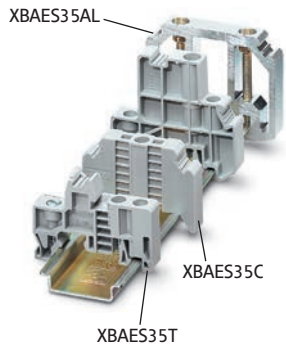

Snap-On End Stop (15 mm)

Standard Pack	Catalogue Number
50	XBAES15N

Snap-On End Stop (35 mm)

Standard Pack	Catalogue Number
50	XBAES35N

Snap-on end stops for 35 mm and 15 mm DIN rails can be fitted with blank marker strips and adjustable terminal strip markers, parking facility for bridges and testing accessories.

Universal End Stop (15 mm)

Standard Pack	Catalogue Number
50	XBAES15C

Universal End Stop (35 mm)

Standard Pack	Catalogue Number
50	XBAES35T
50	XBAES35C

Screwed on, labeling with blank marker strips and terminal strip markers.

Aluminum End

Standard Pack	Catalogue Number
10	XBAES35AL

Snaps on, for end support of 50–240 mm terminal blocks, labeling with XBMZB10.

Cross-Reference of Terminal Blocks Marking, End Stops

Catalogue Number	XBMKLM2	XBMGLMA	XBMUBE
XBAES35N	X	—	—
XBAES35T	—	X	X

Dimensions

Approximate Dimensions in Inches (mm)

Snap-On End Stop

XBAES35N

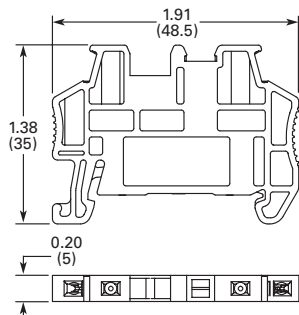

XBAES15N

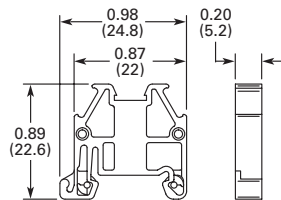

Aluminum End Stop

XBAES35AL

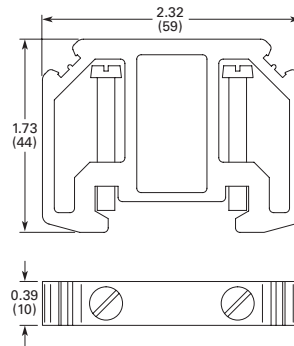

Universal End Stop

XBAES35T

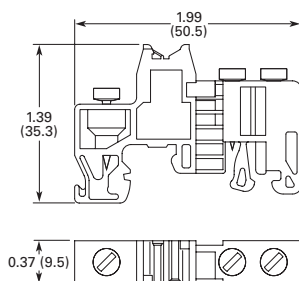

XBAES35C

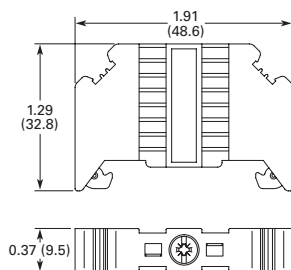

XBAES15C

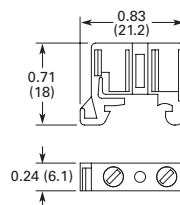

42.1

Terminal Blocks, Fuse Blocks and Fuse Holders

IEC—XB Series

DIN Rails

Product Selection



Perforated and unperforated DIN rails in accordance with E 60715.

Features

- High dimensional accuracy
- Restricted tolerances
- Double surface tempering, galvanized and chromated
- All 2m in length
- Customization available

35 x 7.5 mm x 2m

Standard Pack	Catalogue Number
Slotted	
25	XBANS3575P
Solid	
25	XBANS3575U

35 x 15 mm x 2m

Standard Pack	Catalogue Number
Slotted	
25	XBANS3515P
Solid	
25	XBANS3515U

15 x 5.5 mm x 2m

Standard Pack	Catalogue Number
25	XBANS15P

Aluminum DIN Rails (Perforated)

Standard Pack	Catalogue Number
35/7.5/2m	
25	XBANS3575PL
35/58/2m	
6	XBANS35PL

Dimensions

Approximate Dimensions in Inches (mm)

35 x 7.5 mm DIN Rail

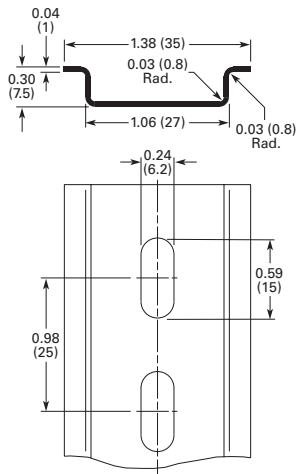

35 x 15 mm DIN Rail

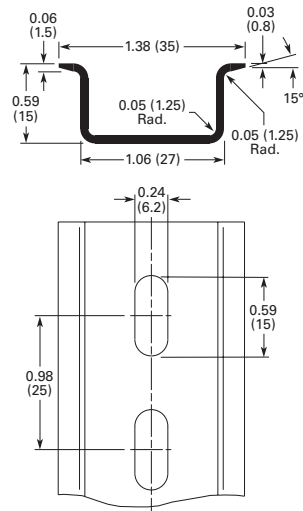

15 x 5.5 mm x 2m DIN Rail

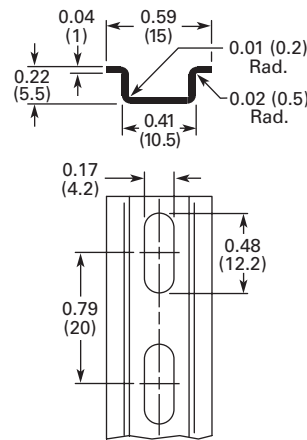

XBANS35PL Raised Rail

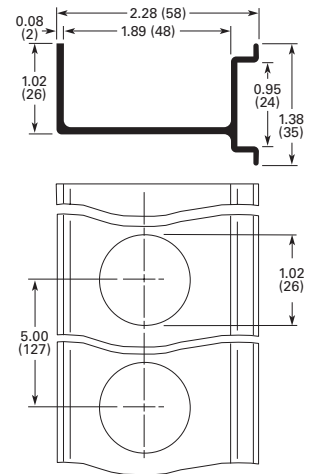

Angled Mounting Brackets

Product Selection



The angled brackets enable the DIN rail to be mounted with a spacing or at an angle of 30°.

Features

- For mounting DIN rail at 30° angle
- For use with M6 screw
- Chromated steel
- Provides better visibility

Angled Mounting Bracket

Standard Pack	Catalogue Number
Height Inches (mm) 1.39 (35.4)	
10	XBANBGS
Height Inches (mm) 1.81 (46)	
10	XBANBGSH

Dimensions

Approximate Dimensions in Inches (mm)

XBANBGS

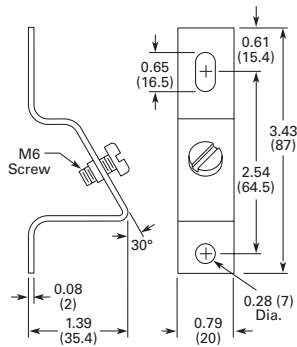

XBANBGSH

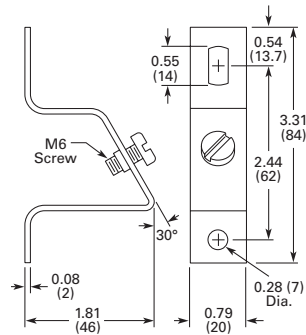

42.1

Terminal Blocks, Fuse Blocks and Fuse Holders

IEC—XB Series

Ferrules

Product Selection

Ferrules are offered in two basic designs—an insulated style available in models for wire sizes 20 through 4 AWG and a non-insulated type available in models for wire sizes 22 through 6 AWG.

Note: UL Ratings do not typically pertain to the use of Ferrules—Ferrules are covered under DIN VDE 0611.

42

Insulated

- Tube: soft electrolytic copper (E-CU), tin plated
- Plastic sleeve: polypropylene
 - Long-term temperature 105°C
 - Short-term temperature 120°C

XBAF1



Insulated Ferrules

Wire Size AWG (mm ²)	Colour ^①	Standard Pack ^②	Catalogue Number
20 (0.5)	White	100	XBAF1
18 (0.75)	Gray	100	XBAF3
18 (1)	Red	100	XBAF4
16 (1.5)	Black	100	XBAF6
14 (2.5)	Blue	100	XBAF9
14 (2.5)	Blue	100	XBAF10
12 (4)	Gray	100	XBAF11
12 (4)	Gray	100	XBAF12
10 (6)	Yellow	100	XBAF13
10 (6)	Yellow	100	XBAF14
8 (10)	Red	100	XBAF15
8 (10)	Red	100	XBAF16
6 (16)	Blue	100	XBAF17
6 (16)	Blue	100	XBAF18
4 (25)	Yellow	50	XBAF19

Non-Insulated

- Tube: soft electrolytic copper (E-CU), tin plated

XBAF20



Non-Insulated Ferrules

Wire Size AWG (mm ²)	Standard Pack ^②	Catalogue Number
20 (0.5)	100	XBAF20
18 (0.75)	100	XBAF21
18 (1)	100	XBAF23
16 (1.5)	100	XBAF24
14 (2.5)	100	XBAF25
12 (4)	100	XBAF26
10 (6)	100	XBAF27
8 (10)	100	XBAF28
6 (16)	100	XBAF29

Special Applications

The twin ferrules allow two conductors to be compressed practically in one ferrule.

The colored coding of the various cross sections corresponds to DIN 46 228-4.

XBAFT1



Non-Insulated Twin Ferrules

Wire Size AWG (mm ²)	Colour ^①	Standard Pack ^②	Catalogue Number
20 (0.5)	White	100	XBAFT1
18 (0.75)	Gray	100	XBAFT3
18 (1)	Red	100	XBAFT4
16 (1.5)	Black	100	XBAFT6
14 (2.5)	Blue	100	XBAFT9
12 (4)	Gray	100	XBAFT11
10 (6)	Yellow	100	XBAFT13
8 (10)	Red	100	XBAFT15
6 (16)	Blue	50	XBAFT18

Notes

- ① The colored coding of the various cross-sections corresponds to DIN 46 228-4.
- ② Standard pack is the number of ferrules that come in each bag. Must order in multiples of standard pack.
Example: XBAF1—an order for 200 pieces will receive 2 bags of ferrules, each with 100 pieces.

Dimensions

Approximate Dimensions in Inches (mm)

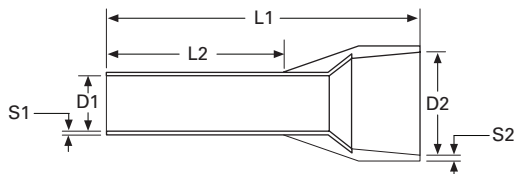
Ferrules with Insulating Collar

Catalogue Number	Approximate Dimensions					
	D1	D2	L1	L2	S1	S2
XBAF1	0.04 (1.1)	0.10 (2.5)	0.55 (14.0)	0.31 (8.0)	0.006 (0.15)	0.010 (0.25)
XBAF3	0.05 (1.3)	0.11 (2.8)	0.55 (14.0)	0.31 (8.0)	0.006 (0.15)	0.010 (0.25)
XBAF4	0.06 (1.5)	0.12 (3.0)	0.55 (14.0)	0.31 (8.0)	0.006 (0.15)	0.012 (0.30)
XBAF6	0.07 (1.8)	0.13 (3.4)	0.55 (14.0)	0.31 (8.0)	0.006 (0.15)	0.012 (0.30)
XBAF9	0.09 (2.3)	0.17 (4.2)	0.55 (14.0)	0.31 (8.0)	0.006 (0.15)	0.012 (0.30)
XBAF10	0.09 (2.3)	0.17 (4.2)	0.94 (24.0)	0.71 (18.0)	0.006 (0.15)	0.012 (0.30)
XBAF11	0.11 (2.8)	0.19 (4.8)	0.67 (17.0)	0.39 (10.0)	0.008 (0.20)	0.012 (0.30)
XBAF12	0.11 (2.8)	0.19 (4.8)	1.02 (26.0)	0.71 (18.0)	0.008 (0.20)	0.012 (0.30)
XBAF13	0.14 (3.5)	0.24 (6.2)	0.79 (20.0)	0.47 (12.0)	0.008 (0.20)	0.012 (0.30)
XBAF14	0.14 (3.5)	0.24 (6.2)	1.02 (26.0)	0.71 (18.0)	0.008 (0.20)	0.012 (0.30)
XBAF15	0.18 (4.6)	0.30 (7.5)	0.87 (22.0)	0.47 (12.0)	0.008 (0.20)	0.012 (0.30)
XBAF16	0.18 (4.6)	0.30 (7.5)	1.10 (28.0)	0.71 (18.0)	0.008 (0.20)	0.012 (0.30)
XBAF17	0.23 (5.8)	0.35 (8.8)	0.94 (24.0)	0.47 (12.0)	0.008 (0.20)	0.016 (0.40)
XBAF18	0.23 (5.8)	0.35 (8.8)	1.10 (28.0)	0.71 (18.0)	0.008 (0.20)	0.016 (0.40)
XBAF19	0.29 (7.3)	0.43 (11.0)	1.26 (32.0)	0.71 (18.0)	0.008 (0.20)	0.020 (0.50)

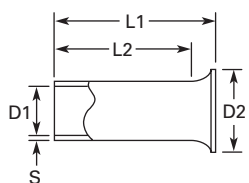
Ferrules without Insulating Collar

Catalogue Number	Approximate Dimensions				
	D1	D2	L1	L2	S
XBAF20	0.04 (1.0)	0.08 (2.1)	0.24 (6.0)	0.21 (5.3)	0.006 (0.15)
XBAF21	0.05 (1.2)	0.09 (2.3)	0.24 (6.0)	0.21 (5.3)	0.006 (0.15)
XBAF23	0.06 (1.4)	0.10 (2.5)	0.24 (6.0)	0.21 (5.3)	0.006 (0.15)
XBAF24	0.07 (1.7)	0.11 (2.8)	0.28 (7.0)	0.24 (6.0)	0.006 (0.15)
XBAF25	0.09 (2.2)	0.13 (3.4)	0.28 (7.0)	0.24 (6.0)	0.006 (0.15)
XBAF26	0.11 (2.8)	0.16 (4.0)	0.35 (9.0)	0.31 (8.0)	0.008 (0.20)
XBAF27	0.14 (3.5)	0.19 (4.7)	0.47 (12.0)	0.35 (9.0)	0.008 (0.20)
XBAF28	0.18 (4.5)	0.23 (5.8)	0.47 (12.0)	0.43 (10.8)	0.008 (0.20)
XBAF29	0.23 (5.8)	0.30 (7.5)	0.47 (12.0)	0.41 (10.5)	0.008 (0.20)

42.1

Terminal Blocks, Fuse Blocks and Fuse Holders

IEC—XB Series

Approximate Dimensions in Inches (mm)

Twin Ferrules

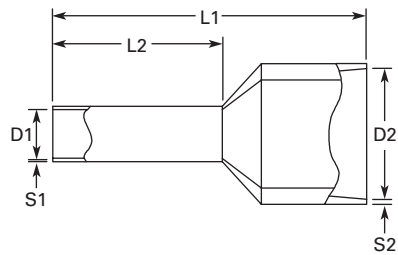

42

Catalogue Number	Approximate Dimensions		L1	L2	S1	S2
	D1	D2				
XBAFT1	0.06 (1.5)	0.10 (2.5)	0.59 (15.0)	0.31 (8.0)	0.006 (0.15)	0.010 (0.25)
XBAFT3	0.07 (1.8)	0.11 (2.8)	0.59 (15.0)	0.31 (8.0)	0.006 (0.15)	0.010 (0.25)
XBAFT4	0.08 (2.1)	0.13 (3.4)	0.59 (15.0)	0.31 (8.0)	0.006 (0.15)	0.012 (0.30)
XBAFT6	0.09 (2.3)	0.14 (3.6)	0.63 (16.0)	0.31 (8.0)	0.006 (0.15)	0.012 (0.30)
XBAFT9	0.11 (2.9)	0.17 (4.2)	0.73 (18.5)	0.39 (10.0)	0.008 (0.20)	0.012 (0.30)
XBAFT11	0.15 (3.8)	0.19 (4.9)	0.91 (23.0)	0.47 (12.0)	0.008 (0.20)	0.012 (0.30)
XBAFT13	0.19 (4.9)	0.23 (5.9)	0.98 (25.0)	0.55 (14.0)	0.008 (0.20)	0.016 (0.40)
XBAFT15	0.26 (6.5)	0.28 (7.2)	1.02 (26.0)	0.55 (14.0)	0.008 (0.20)	0.016 (0.40)
XBAFT18	0.33 (8.5)	0.35 (8.8)	1.22 (31.0)	0.63 (16.0)	0.008 (0.20)	0.020 (0.50)

Hand Tools**Stripping Tools****Product Selection****Stripping Tools**

Standard Pack	Catalogue Number
1	XBTCUTSTP

Technical Data and Specifications**Conductor/Cable Stripping Range**

Description	Specification
Conductor/cable	0.2–6 mm ² /24–10 AWG
Wire cutter	6 mm ² /10 AWG

Crimping Pliers

The crimping pliers deform the ferrules hexagonally. For 0.25–6 mm² ferrules in accordance with DIN 46 228-1: 1992-08 and DIN 46 228-4: 1990-09.

Product Selection**Crimping Pliers**

Standard Pack	Catalogue Number
1	XBTCRMP66

Technical Data and Specifications**Areas of Application**

Description	Specification
Conductor	0.25–6 mm ²
Conductor	23–10 AWG

Slotted Screwdrivers**Product Selection****Slotted Screwdrivers**

Standard Pack	Catalogue Number
3.5 mm	
1	XBTDVR35
4.0 mm	
1	XBTDVR40

Dimensions

Approximate Dimensions in Inches (mm)

Stripping Tools

Length	Stripping Length	Weight In lbs (g)
8.07 (205)	Up to 18 mm	0.44 (200)

Dimensions

Approximate Dimensions in Inches (mm)

Crimping Pliers

Length	Weight In lbs (g)
6.85 (175)	0.79 (360)

Marking Accessories

Printed Marking Tag Options

Horizontally Printed Marking Tags and Marking Directions

1	2	3	4	5	6	7	8	9	10
---	---	---	---	---	---	---	---	---	----

Marking Direction: Horizontal

1	2	3	4	5	6	7	8	9	10
---	---	---	---	---	---	---	---	---	----

Marking Direction: Vertical

42

Marking Tags for 5.2 mm Wide Terminal Blocks

Standard Pack	Number Sequence	Catalogue Number
ZB5 Tags Vertically Numbered		
10	1–10 ①	XBMZB5V/1
10	11–20	XBMZB5V/11
10	21–30	XBMZB5V/21
10	31–40	XBMZB5V/31
10	41–50	XBMZB5V/41
10	51–60	XBMZB5V/51
10	61–70	XBMZB5V/61
10	71–80	XBMZB5V/71
10	81–90	XBMZB5V/81
10	91–100	XBMZB5V/91
ZBF5 Tags Vertically Numbered		
10	1–10 ①	XBMZBF5V/1
10	11–20	XBMZBF5V/11
10	21–30	XBMZBF5V/21
10	31–40	XBMZBF5V/31
10	41–50	XBMZBF5V/41
10	51–60	XBMZBF5V/51
10	61–70	XBMZBF5V/61
10	71–80	XBMZBF5V/71
10	81–90	XBMZBF5V/81
10	91–100	XBMZBF5V/91

Marking Tags for 6.2 mm Wide Terminal Blocks

Standard Pack	Number Sequence	Catalogue Number
ZB6 Tags Vertically Numbered		
10	1–10 ①	XBMZB6V/1
10	11–20	XBMZB6V/11
10	21–30	XBMZB6V/21
10	31–40	XBMZB6V/31
10	41–50	XBMZB6V/41
10	51–60	XBMZB6V/51
10	61–70	XBMZB6V/61
10	71–80	XBMZB6V/71
10	81–90	XBMZB6V/81
10	91–100	XBMZB6V/91
ZBF6 Tags Vertically Numbered		
10	1–10 ①	XBMZBF6V/1
10	11–20	XBMZBF6V/11
10	21–30	XBMZBF6V/21
10	31–40	XBMZBF6V/31
10	41–50	XBMZBF6V/41
10	51–60	XBMZBF6V/51
10	61–70	XBMZBF6V/61
10	71–80	XBMZBF6V/71
10	81–90	XBMZBF6V/81
10	91–100	XBMZBF6V/91

Note

① For text printed horizontally, change “V” in catalogue number to “H.”

Marking Tags for 8.2 mm Wide Terminal Blocks

Standard Pack	Number Sequence	Catalogue Number
ZB8 Tags Vertically Numbered		
10	1–10 ①	XBMZB8V/1
10	11–20	XBMZB8V/11
10	21–30	XBMZB8V/21
10	31–40	XBMZB8V/31
10	41–50	XBMZB8V/41
10	51–60	XBMZB6V/51
10	61–70	XBMZB8V/61
10	71–80	XBMZB8V/71
10	81–90	XBMZB8V/81
10	91–100	XBMZB8V/91
ZBF8 Tags Vertically Numbered		
10	1–10 ①	XBMZBF8V/1
10	11–20	XBMZBF8V/11
10	21–30	XBMZBF8V/21
10	31–40	XBMZBF8V/31
10	41–50	XBMZBF8V/41
10	51–60	XBMZBF8V/51
10	61–70	XBMZBF8V/61
10	71–80	XBMZBF8V/71
10	81–90	XBMZBF8V/81
10	91–100	XBMZBF8V/91

Marking Tags for 10.2 mm Wide Terminal Blocks

Standard Pack	Number Sequence	Catalogue Number
ZB10 Tags Vertically Numbered		
10	1–10 ①	XBMZB10V/1
10	11–20	XBMZB10V/11
10	21–30	XBMZB10V/21
ZBF10 Tags Vertically Numbered		
10	1–10 ①	XBMZBF10V/1
10	11–20	XBMZBF10V/11
10	21–30	XBMZBF10V/21

Marking Tags for 12 mm Wide Terminal Blocks

Standard Pack	Number Sequence	Catalogue Number
ZB12 Tags Vertically Numbered		
10	1–10 ①	XBMZB12V/1
10	11–20	XBMZB12V/11
10	21–30	XBMZB12V/21
ZBF12 Tags Vertically Numbered		
10	1–10 ①	XBMZBF12V/1
10	11–20	XBMZBF12V/11
10	21–30	XBMZBF12V/21

Marking Tags for 16 mm Wide Terminal Blocks

Standard Pack	Number Sequence	Catalogue Number
ZB15 Tags Vertically Numbered		
10	1–10 ①	XBMZB15V/1
10	11–20	XBMZB15V/11
10	21–30	XBMZB15V/21
ZBF15 Tags Vertically Numbered		
10	1–10 ①	XBMZBF15V/1
10	11–20	XBMZBF15V/11
10	21–30	XBMZBF15V/21

Note

① For text printed horizontally, change “V” in catalogue number to “H.”

Pre-Printed Marking Tags**Terminal Blocks Marking Tags**

The tags are made of white self-extinguishing polyamide 6.6 and the imprint is hot stamped with rubproof black ink.

- White marking strip available preprinted. Strip covers 10 terminals. Marking 1 – 10, 11–20, up to 991–999. Contact Eaton for more options.
- XBMZB5 or XBMZBF5 for terminal blocks 5.2 mm wide
- XBMZB6 or XBMZBF6 for terminal blocks 6.2 mm wide
- XBMZB8 or XBMZBF8 for terminal blocks 8.2 mm wide
- XBMZB10 or XBMZBF10 for terminal blocks 10.2 mm wide
- XBMZB12 or XBMZBF12 for terminal blocks 12 mm wide
- XBMZB15 or XBMZBF15 for terminal blocks 16 mm wide

Marking Tag Sizes

Note: Marking Tag Sizes are for all catalogue numbers starting with given prefix, EXCEPT FUSE TERMINAL Blocks.

Proper Marking Tag Size

XBMZB5	XBMZBF5	XBMZB6	XBMZBF6	XBMZB8	XBMZBF8	XBMZB10	XBMZBF10	XBMZB12	XBMZBF12	XBMZB15	XBMZBF15	XBMSSZB
XBUT25	XBPT25 ^②	XBUT4	XBPT4 ^②	XBUT6	XBPT6 ^②	XBUT10	XBPT10 ^②	XBPT16 ^①	XBPT16 ^②	XBUT35	XBPT35 ^②	XBMKLMZ
XBUT4FBE ^①	XBPTT25	XBUTT4	XBPTT4	XBPT6 ^①	XBPT4FBN ^②	XBUT16	—	—	—	XBPT35 ^①	—	—
XBUT6FBN ^①	XBPTK	XB3UKA	XBPT4FBE ^②	XBUK6	XBPT4FSI ^②	XBTK	—	—	—	—	—	—
XBPT25 ^①	XBPU25 ^②	XB3UKF	XBQT25 ^③	XBPT4FSI ^①	—	XBUK50	—	—	—	—	—	—
XBPT4FBE ^①	XBAP ...	XBUT4FBE ^②	XBQT25FBE ^③	—	—	XBUK150	—	—	—	—	—	—
XBPU25 ^①	XBQT15 ^③	XBUT6FBN ^②	XBQU25 ^⑤	—	—	XBUK95	—	—	—	—	—	—
XBQT15 ^①	XBQT15	XBUK10	—	—	—	XBPT10 ^①	—	—	—	—	—	—
XBQT25FBE ^④	XBQU15 ^③	XBUK4	—	—	—	XBMKLMZ ^⑤	—	—	—	—	—	—
XBQU15 ^①	XBMPK15	XBPT4 ^①	—	—	—	—	—	—	—	—	—	—
XBMUK25	XBMPKK15	XBPT4FBN ^①	—	—	—	—	—	—	—	—	—	—
—	XBATCP...	XBQT25 ^①	—	—	—	—	—	—	—	—	—	—
—	—	XBQT25FBE ^①	—	—	—	—	—	—	—	—	—	—
—	—	XBQU25 ^①	—	—	—	—	—	—	—	—	—	—
—	—	XBMUK4	—	—	—	—	—	—	—	—	—	—

Notes

- ① For centre labeling.
- ② For external labeling.
- ③ For centre and outside labeling.
- ④ For lever labeling.
- ⑤ Two (2) XBMZB10 tags fit in one (1) XBMKLMZ.

Marker Strips and Sheets (for use with XBAPLT2006K1 plotter)

The **XB** Series marking system provides logical and clear identification of the modular terminal blocks and interface modules.

Product Selection**XBMZB_****Marker Strips (Strip of 10)**

Terminal Width	Standard Pack	Catalogue Number
Blank Strips		
5.2 mm	10	XBMZB5
6.2 mm	10	XBMZB6
8.2 mm	10	XBMZB8
10.2 mm	10	XBMZB10
12 mm	10	XBMZB12
16 mm	10	XBMZB15 ①
Flat Strips		
5.2 mm	10	XBMZBF5
6.2 mm	10	XBMZBF6
8.2 mm	10	XBMZBF8
10.2 mm	10	XBMZBF10
12 mm	10	XBMZBF12
16 mm	10	XBMZBF15

Marker Sheets (Strip of 10)

Terminal Width)	Colour	Std. Pack	Catalogue Number
Marker Sheets (10 rows of 12)			
5.2 mm	White	50	XBMPZB5
	Blue	50	XBMPZB5BU
	Red	50	XBMPZB5RD
	Yellow	50	XBMPZB5YE
	Green	50	XBMPZB5GN
Marker Sheets (10 rows of 10)			
6.2 mm	White	50	XBMPZB6
	Blue	50	XBMPZB6BU
	Red	50	XBMPZB6RD
	Yellow	50	XBMPZB6YE
	Green	50	XBMPZB6GN
Flat Marker Sheets (10 rows of 10)			
5.2 mm	White	10	XBMPZBF5
	Orange	10	XBMPZBF5OG
	White	10	XBMPZBF6
	Orange	10	XBMPZBF6OG
	White	10	XBMPZBF8

XBMPZB_**XBMPZBF_****Label Sheets for Laser Printers**

The XBM labels have been specially developed for laser printers and have considerable advantages:

- Can be printed on all commercially available laser printers
- Or can use plotter or pen for printing
- Good adhesive properties
- A4 size
- XBMKL25X12WH designed to fit XGBS2512 group marker
- XBMLMAL447 is perforated for terminal strip marker XBMGLMA and is 44 x 7 mm

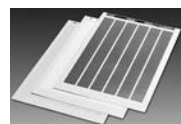
Product Selection**XBM_****Label Sheets**

Standard Pack	Catalogue Number
10	XBMKL25X12WH
10	XBMLMAL447

Note

① All markers are strips of 10, except XBMZB15, which is a strip of 5.

42.1

Terminal Blocks, Fuse Blocks and Fuse Holders

IEC—XB Series

Terminal Block Group Marking

Terminal block groups are marked using marking labels that are snapped into the marker strip groove of the terminal blocks. The group is marked using either labels or insert markers.

Product Selection

XGBS2512



Terminal Block Group Marking ^①

Standard Pack	Catalogue Number
100	XGBS2512

Insert Markers for Laser Printers

One sheet = 56 labels. Lettering field is 40 x 17 mm.

Product Selection

XBMUBEL4017



Insert Markers for XBMUBE(D)

Standard Pack	Catalogue Number
10	XBMUBEL4017

42

Terminal Strip Markers

Adjustable height for end bracket labeling.

Product Selection

XBM_



Terminal Strip Markers ^①

Standard Pack	Catalogue Number
20 x 8 mm Wide	
10	XBMKLM2
44 x 7 mm Wide	
10	XBMGLMA

Refillable Marker Pen

Refillable marker pen for manual labeling, line thickness 0.35 mm.

Product Selection

XBMXPEN



Terminal Strip Markers ^①

Standard Pack	Catalogue Number
Pen	
1	XBMXPEN
Ink Cartridge	
1	XBMINK

Terminal Strip Marker Carriers

For labeling terminal groups, for mounting on DIN rail. Lettering field is 40 x 17 mm.

Product Selection

XBMUB_



Terminal Strip Marker Carriers

Standard Pack	Catalogue Number
10	XBMUBE
10	XBMUBED

Non-Refillable Marker Pen

For manual labeling, line thickness 0.5 mm.

Product Selection

XBMUBE



Non-Refillable Marker Pen

Standard Pack	Catalogue Number
1	XBMBSTIFT

Note

^① See Page T42-101 for insert labels.

Marking Plotter

The automatic Prepare Pen function ensures optimum marking results right from the first character.

Custom Marking Tag System

This plotter system uses Windows®-based software to interface with a PC, allowing custom printing on standard terminal blocks marking tags. These standard marking tags provide circuit identification for Eaton DIN rail mount terminal blocks.

Pens can remain in the pen station even for prolonged intervals without drying out.

Features

- Enter tag text directly into EMARK software program or import file from AutoCAD or Excel®
- Selectable font sizes, types and colors including common symbols for circuit identification (ground, ~ etc.)
- Various text formatting options including copy, paste, increment functions, text alignment, etc.
- Durable templates allow printing of four different tag sizes at the same time
- Automatic prepare pen function for optimum results

Technical Data and Specifications**Marking Plotter**

Description	Specification
Plotter	
Plotter type	Flatbed plotter
Maximum plotting surface	440 mm x 296 mm
Maximum material height	10.5 mm
Maximum plotting speed	40 cm/sec
Pen station	Four depots with double sealing
Drive	Two-phase impulse-driven motor
Interfaces	Parallel (Centronics)/USB Level 1.1
Electronics	
Command language	Based on HP-GL 7475A
Data buffer	16 MB
Addressable resolution	0.01 mm
Repeat accuracy	0.05 mm
Repeat accuracy on pen change	0.05 mm with optimum pen
Power Supply	
Power supply	Via separate power supply unit with exchangeable mains feeder cable
Power supply unit input voltage	100–240 Vac/50–60 Hz
Power supply unit input current (maximum)	0.3A at 230V~
Power supply unit output voltage	24 Vdc
Power supply unit output current (maximum)	1.4A
Environmental conditions	
Operation	50° to 95°F (10° to 35°C) 35% to 75% relative humidity
Storage	14° to 122°F (–10° to 50°C) 10% to 90% relative humidity

Dimensions

Approximate Dimensions in Inches (mm)

Marking Plotter

L	W	H	Approx. Weight In Lbs (kg)
25.98 (660)	17.32 (440)	4.92 (125)	18 (8)

Marking Plotter

Description	Standard Pack	Catalogue Number
Plotter kit ^①	1	XBAPLT2006K1
Pen station sealing set	1	XBMP1PENDEPOT
Plotter pen preparation plate	1	XBMP1PREPLATES
Template for marker strips	1	XBMP1MZB
Template for flat marker strips	1	XBMP1MZBF
Template for XBMPZB marker sheets	1	XBMP1MPZB
Template for XBMPZBF marker sheets	1	XBMP1MPZBF
Template for Weidmuller multiscard sheet	1	XBMP1MCSF46
Template for Weidmuller multiscard sheet universal	1	XBMP1MCU
Template for Entrelec sheets	1	XBMP1MRC
0.25 mm disposal pen	1	XBMDPEN25R
0.35 mm disposal pen	1	XBMDPEN35R
0.25 mm pen	1	XBMPEN25
0.35 mm pen	1	XBMPEN35
Ink Cartridge	2	XBMINK
Pen cleaning set	1	XBMRSET
Cleaning cartridges	2	XBMRMEKFC2

EMARK Software

Eaton's EMARK software makes labeling your terminal blocks quick and simple. You can import your data from ECHART, any other CAD/CAE program, or enter text directly into EMARK. The software allows marking tags to be printed on the PLT2006 plotter in a professional manner.

Note

^① Plotter kit includes PLT2006 plotter system with EMARK software and user manual, starter ink and cleaning sets, and templates for marking all XBMZB and XBMZBF tags.

Testing Accessories

Test Adapter

For 4 mm diameter test plug and 4 mm diameter safety test plug. Makes contact in the bridge shaft.

Product Selection

XBATSPA14



Test Adapter

Standard Pack	Catalogue Number
1	XBATSPA14

Modular Test Plugs

For individual assembly of test plug strips.

Product Selection

XBATS_

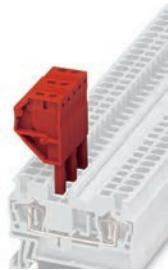

Modular Test Plugs

Standard Pack	Catalogue Number
Test Plugs	
10	XBATSPS5
10	XBATSPS6
10	XBATSPS8
Spacer Plate	
10	XBATSDPPS5
10	XBATSDPPS6
10	XBATSDPPS8

Test Plugs

Consisting of metal part for socket hole and insulating sleeve.

Product Selection

Test Plugs

Standard Pack		Catalogue Number
2.3 mm		
10	—	XBATSMPSMT
10	Blue	XBATSMPSIHBU
10	White	XBATSMPSIHHW
10	Red	XBATSMPSIHRD
10	Black	XBATSMPSIHBK
4 mm		
10	—	XBATSPSMT
10	Blue	XBATSPSIHBU
10	White	XBATSPSIHHW
10	Red	XBATSPSIHRD
10	Black	XBATSPSIHBK

XBATSMP_



XBATSMP_



Separating Plates, Covers and Bridges

End Cover

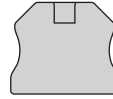

Used to cover an open end of terminal block when changing sizes within an assembly and/or for last terminal block in a row.

Partition Plate

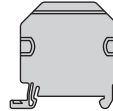

Protrudes over the terminal block and is used to increase electrical clearance between terminals. Also provides visual indications of the functions of terminal blocks. For example, terminal blocks between two partition plates may provide an exact location for test points.

End Cover Segment



Covers protruding terminal block segments of three- and four-wire terminal blocks when next to a two-wire blocks. This ensures that all is touch-proof and saves space over using a standard end cover.

Jumper/Bridge

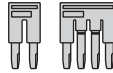

Provides the ability to electrically connect terminal blocks. Non-adjacent blocks may be bridged by snapping off the contact tabs of the standard bridge. The reducing bridge permits simple connection of terminal blocks with different nominal cross-sections.

Note

See these accessories as listed with terminal blocks for more information.

42.2

Terminal Blocks, Fuse Blocks and Fuse Holders

NEMA

NEMA



Contents

Description

Page

NEMA

C381 Series Terminal Blocks, Rail Mounted	T42-107
TB Series Terminal Blocks, Modular	T42-111



42

NEMA Overview

Product Description

NEMA terminal blocks provide a panel or DIN rail mount block that can be assembled from modular pieces. These blocks accommodate wire from 22 to 1/0 AWG and up to 175A and 600V.

Standards and Certifications

- UL File #E67464 and #E56797

C381 Series Terminal Blocks, Rail Mounted



Contents

Description	Page
C381 Series Terminal Blocks, Rail Mounted	
Product Selection	T42-108
Accessories	T42-109
Modifications	T42-109
Technical Data and Specifications	T42-110
Dimensions	T42-110
TB Series Terminal Blocks, Modular	T42-111

C381 Series Terminal Blocks, Rail Mounted

Product Description

- 600V
- Snap-fit nylon sections
 - Control circuit blocks
 - Power circuit blocks
 - Fuse blocks
 - Switch blocks
- Sections can be interlocked in any quantity and any mixture for direct panel mounting or channel mounting
- Three terminal choices in control circuit blocks, up to 32 circuits per foot
- Power circuit blocks for heavy-duty applications, up to 16 circuits per foot
- Fuse blocks accommodate any 0.406 x 1.5 in (10.3 x 38.1 mm) ferrule type cartridge fuse up to 30A
- Switch blocks have removable blade for extra safety

Standards and Certifications

- UL File #E67464



A Typical Mixture of Control Circuit Blocks, Power Blocks, Switch and Fuse Blocks in a Mounting Channel

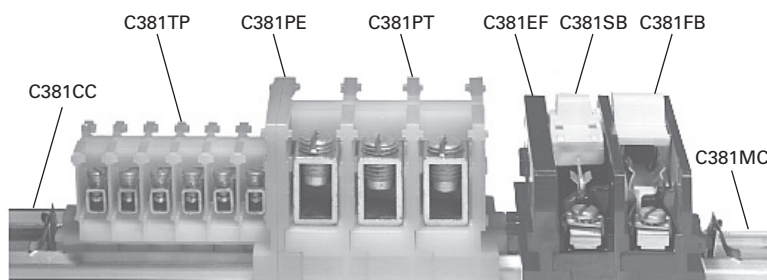

42.2

Terminal Blocks, Fuse Blocks and Fuse Holders

NEMA

Product Selection

When Ordering Specify

Catalogue number and quantity, which must be in a multiple of the available minimum standard package.

Examples:









- 200 Cat. No. C381ST
- 20 Cat. No. C381PT
- 100 Cat. No. C381CC

Catalogue number and quantity of end sections also in minimum quantity standard package.

Example:

- 25 Cat. No. C381ES.

Control, Power, Switch and Fuse Blocks ^①

	Description	AWG Wire Size	Standard Pack ^②	Catalogue Number
Control Circuit Terminal Blocks—Rated 50A				
	C381ST Type ST (screw terminal)	22–14 AWG	100	C381ST
	C381TP Type TP (tubular pressure plt)	22–10	100	C381TP
	C381TS Type TS (tubular screw) end section	18–8	100	C381TS
	C381ES End section	—	25	C381ES
Power Circuit Terminal Blocks—Rated 155A				
	C381PT Type PT (tubular screw)	10–1/0	10	C381PT
	C381PE End section	—	10	C381PE
Switch Blocks—Rated 15A and Fuse Blocks—Rated 30A				
	C381SB Switch blocks	18–8	10	C381SB
	C381FB Fuse blocks	18–8	10	C381FB
	C381EF End section	—	10	C381EF

Notes

- ① Available only in minimum quantity standard packages.
- ② Must be ordered in standard package quantity or in multiples of these quantities.

Accessories

C381 Series Terminal Blocks, Rail Mounted ^①

Description	Standard Pack ^②	Catalogue Number
Aluminum mounting channel—6 ft (1.8m) lengths	25	C381MC
Screw type channel clamp (one required each end) ^③	100	C381VC
Spring type channel clamp (one required each end) ^③	100	C381CC
Vinyl marking strip—3/8 in x 25 ft (9.5 mm x 7.6m) coil	1	C381MS
Marking paper—pressure sensitive—5/16 x 11-11/16 in (7.9 x 296.9 mm), 24 strips/sheet	5 sheets	C381MP
Marking strip retainer (one required/grouping)		
For use on control circuit blocks	100	C381SR
For use on power circuit blocks	100	C381SP
Fanning strip—for type TP and/or TS	50	C381TF
Fanning strip—for type ST	50	C381SF
Terminal jumper (two-pole) ^④	100	C381TJ
Ganging rod—1/8 in x 6 in (3.2 mm x 152.4 mm) ^⑤	10	C381GR

Modifications

Pull Apart Terminal Blocks ^①

Description	AWG Wire Size	Standard Pack ^②	Catalogue Number
One-pole stationary section (tubular pressure plt)	22–10	100	C381PS
Three-pole movable section (tubular pressure plt)	22–10	12	C381PM
End section	—	25	C381ES
Polarizing plug (promotes alignment of poles) ^⑥	—	100	C381PP

Pull Apart Terminal Blocks

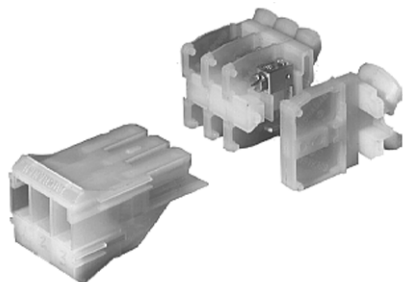

Illustrates: One–Three-Pole Movable Section, Three–One-Pole Stationary Sections and One–End Piece

Notes

- ① Available only in minimum quantity standard packages.
- ② Must be ordered in standard package quantity or in multiples of these quantities.
- ③ C381CC is a snap-in, one time use disposable type. C381VC can be readjusted or reused as desired.
- ④ For use on adjacent Type TP and/or TS control circuit sections.
- ⑤ May be used on section covers or to gang fuse and/or switch blocks.
- ⑥ L shaped plug installs in end of stationary section, Catalogue Number C381PS, and prevents incorrect installation of movable section, Catalogue Number C381PM.

Technical Data and Specifications

Formulas for Calculating Blocks and Channel Lengths

N = Number of Blocks

C381 Series Terminal Blocks, Rail Mounted

Description	Blocks Length
Control blocks and pull apart blocks	$0.762 + (0.375 \times N)$
Power circuit blocks	$0.812 + (0.750 \times N)$
Fuse and switch blocks	$0.812 + (0.755 \times N)$
Mounting channel (minimum channel length)	$0.75 + \text{blocks length}$

42

Dimensions

Approximate Dimensions in Inches (mm)

C381 Series Terminal Blocks, Rail Mounted

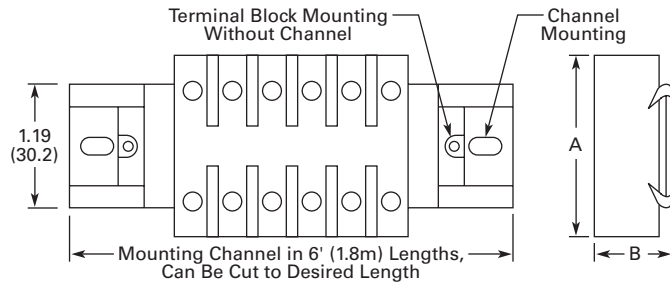

Block	A	B
Control circuit blocks	1.25 (31.8)	1.55 (39.4)
Power circuit blocks	1.75 (44.5)	2.00 (50.8)
Fuse blocks	2.75 (69.9)	2.00 (50.8)
Switch blocks	2.75 (69.9)	2.00 (50.8)
Pull apart blocks	1.88 (47.8)	2.75 (69.9)

TB Series Terminal Blocks, Modular



Contents

<i>Description</i>	<i>Page</i>
C381 Series Terminal Blocks, Rail Mounted	T42-107
TB Series Terminal Blocks, Modular	
Product Selection	T42-112
Accessories	T42-113
Technical Data and Specifications	T42-114
Dimensions	T42-115

TB Series Terminal Blocks, Modular

Product Description

TBA and TBD modular terminal blocks are designed to conserve space, while allowing maximum flexibility and ease of installation. Available as one-, two- and three-pole circuits, simple and uniform installation is possible because their design is based on 5/8 in (15.9 mm) modules. Standard blocks are white nylon.

Breathing Action Clamping Collar

The unique design of the clamping collar permits the collar to breathe as the wire expands and contracts, maintaining a constant and permanent clamping pressure. This eliminates loose connections resulting from the gradual flattening of conductors and joint deterioration caused by heating and cooling cycles.

Features**Blocks—Design Features**

- Compact design permits mounting 48–600V or 90–300V terminals per foot
- Fully shielded construction, 600V spacings
- Nylon construction provides anti-tracking and impact resistance
- TBA types are available in rail mounted, base mounted and power distribution types
- Terminal blocks easily snap on or off mounting rails; not necessary to disturb adjacent units
- No end pieces or backing plates are needed when rail mounting
- A 12 circuit subminiature blocks, rated 20A at 300V, is available for “high density” applications
- Popular blocks are also available in dual mount for use with standard TBA or 35 mm DIN rails

Terminals—Design Features

- Insulated walls of lug guide wire into lug
- Blocks are shipped with clamping screw backed out
- Constant locking torque keeps terminal screws in position
- Terminal screws are captive; cannot be lost in shipment or handling
- Hardened stainless steel clamping collar eliminates stripped threads
- Large opening in clamping collar accommodates oversized conductors; smallest collar will accept three 14 AWG stranded conductors

Standards and Certifications

- UL recognized: File No. E56797
- CE approved



Product Selection

TBA Modular Terminal Blocks

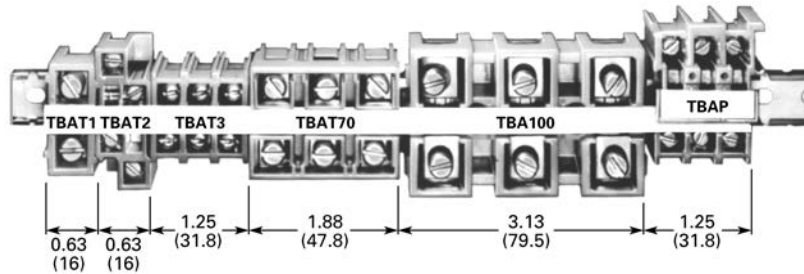

Rail and Base Mounted Terminal Blocks

Description	AWG Wire Size	Number of Poles	Ampacity (per Circuit) ^①	Carton Quantity ^②	TBA Rail Catalogue Number	DIN Rail ^③ Catalogue Number
Rail Mounted—600V						
Subminiature blocks	(2) 14–12	12	5A	100	TBDSM12 ^④	TBDSM12 ^④
Miniature blocks	22–10	4	30A	100	TBDV4	TBDV4
Standard blocks—screw terminals with tang clamping collars	18–2	1	90A	100	—	TBDT1
	22–8	2	40A	100	TBAT2	—
	22–8	3	40A	20	TBAT3-20	TBDT3-20
	18–4	3	90A	100	TBDT70	TBDT70
High current blocks	14–2/0	3	175A	12	TBA100 ^⑤	—
Standard blocks—plug-in terminals	22–8	3	40A	20	TBAP	—
	18–4	3	70A	20	TBAP70	—
	14–8	3	40A	20	TBAPL70	—
Panel mount blocks	22–10	3	30A	100	TBAL30	—
	8–4	3	115A	12	TBAL90	—
Disconnect blocks—for 1/4 in (6.4 mm) dia. by 1–1/16 in (25.4–36.5 mm) fuse	22–8	1	30A	50	TBAD	—
Fuse blocks—for 13/32 in (10.3 mm) dia. by 1-1/2 in (38.1 mm) fuse	22–8	1	30A	50	TBDTF	TBDTF
Base Mounted—600V						
Miniature blocks—screw terminals with tang clamping collars	22–10	4	30A (600V)	90	TBBT4	—
Standard blocks—standard screw terminals	22–8	3	40A	80	TBAPT3	—
Universal mounting blocks	8 maximum	4	50A ^⑥	25	TBU4	—
	8 maximum	6	50A ^⑥	60	TBU6	—
	8 maximum	8	50A ^⑥	45	TBU8	—
	8 maximum	12	50A ^⑥	35	TBU12	—

Notes

- ① Based on 50°C rise, test at 25°C ambient while using maximum wire size.
- ② Must be ordered in standard package quantity or in multiples of these quantities.
- ③ Dual mounting blocks—mount on either TMR/TBA rail or 35 mm DIN rail.
- ④ May also be mounted on mini-DIN rail (15 mm). Catalogue Number C383TS15.
- ⑤ May also be base mounted.
- ⑥ TBU Series = 60A with crimped wire.

Accessories**TB Series Terminal Blocks, Modular**

Description	Length ^①	Number of Poles	Carton Quantity ^②	Catalogue Number
Mounting Rail				
Aluminum	12.5 (317.5)	—	25	TMR12
	37.5 (952.5)	—	25	TMR37
	72.0 (1828.8)	—	25	TBATR72
35 mm DIN—steel	1m	—	20	MC382MA1-20
Marking Strips				
Miniature blocks—TBDV4 and TBBT4	6.0 (152.4)	—	50	TMS6
TBU Series—matte finish	7.5 (190.5)	—	25	TMSU
All other blocks	12.5 (317.5)	—	50	TMS
Jumpers				
TBAT1 and TBAP70	—	2-pole	100	TJ1
TBAT2	—	2-pole	100	TJ2
TBAT3, TBABT3, TBAP and TBBP	—	2-pole	100	TJ3
TBDV4 and TBBT4	—	4-pole	100	TJ4
TBAD and TBATF	—	2-pole	100	TJ5
TBAL30	—	2-pole	100	TJ6
TBU	—	12-pole	10	TJ7
TBDT3	—	2-pole	100	TJ8
Miscellaneous				
End piece for TBABT3 and TBBP	—	—	50	TAD
Lug shield for TBA100 and TBAL90	—	—	50	TAS
Fuse puller	—	—	50	TBP
Lighted fuse puller—blown fuse indication	—	—	25	TBLP

Notes

- ① Length in inches (mm) except as noted.
 ② Must be ordered in standard package quantity or in multiples of these quantities.

Technical Data and Specifications

TB Series Terminal Blocks, Modular

Description	Specification
Continuous temperature	212°F (100°C)
Tensile strength	10,000–12,000 psi
Impact resistance	2.0 ft-lb/in (arc)
Arc resistance	140 seconds

- Chemical resistance to:
 - Acetone
 - Ammonia gas
 - Benzene
 - Gasoline
 - Mineral oil
 - Sodium bisulfate
 - Sodium chloride
 - Sodium nitrate
 - Water up to 50°C

Flashover Voltages

Catalogue Number	Vac rms, 60 Hz	
	Opposite Polarity	To Ground
TBAT1	9100	6600
TBAT2	9600	7300
TBAT3	8600	7300

Recommended Terminal Tightening Torque

Wire Size	Torque
Up to 8 AWG	20 lb-in
Up to 4 AWG	35 lb-in
Up to 2/0 AWG	50 lb-in

42

To find a current rating, place a straight edge horizontally at the value of anticipated maximum internal panel ambient (scale on the left), and read the current rating for the device on the bottom scale. *Example:* at 60°C, TBAT3 is rated 54 amperes.

Ampere rating is based on maximum allowable temperature—ambient temperature plus temperature rise due to current.

Ratings based on 90°C total temperature of a three-pole block with each pole carrying current and wired with largest size conductors.

Temperature Rating

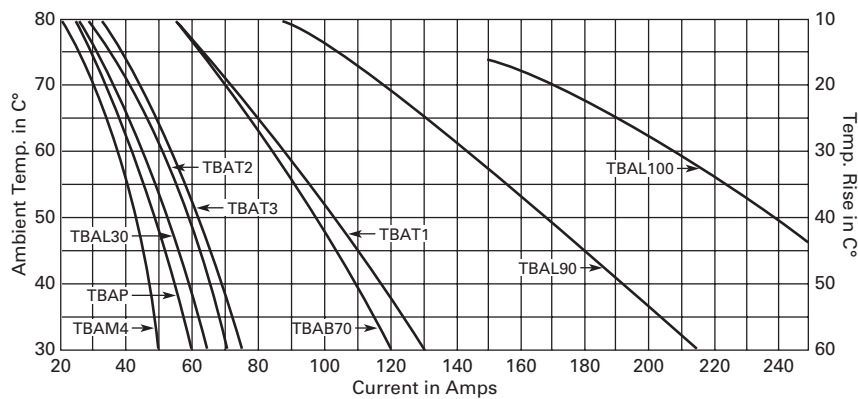

Dimensions

Approximate Dimensions in Inches (mm)

TB Series Terminal Blocks, Modular

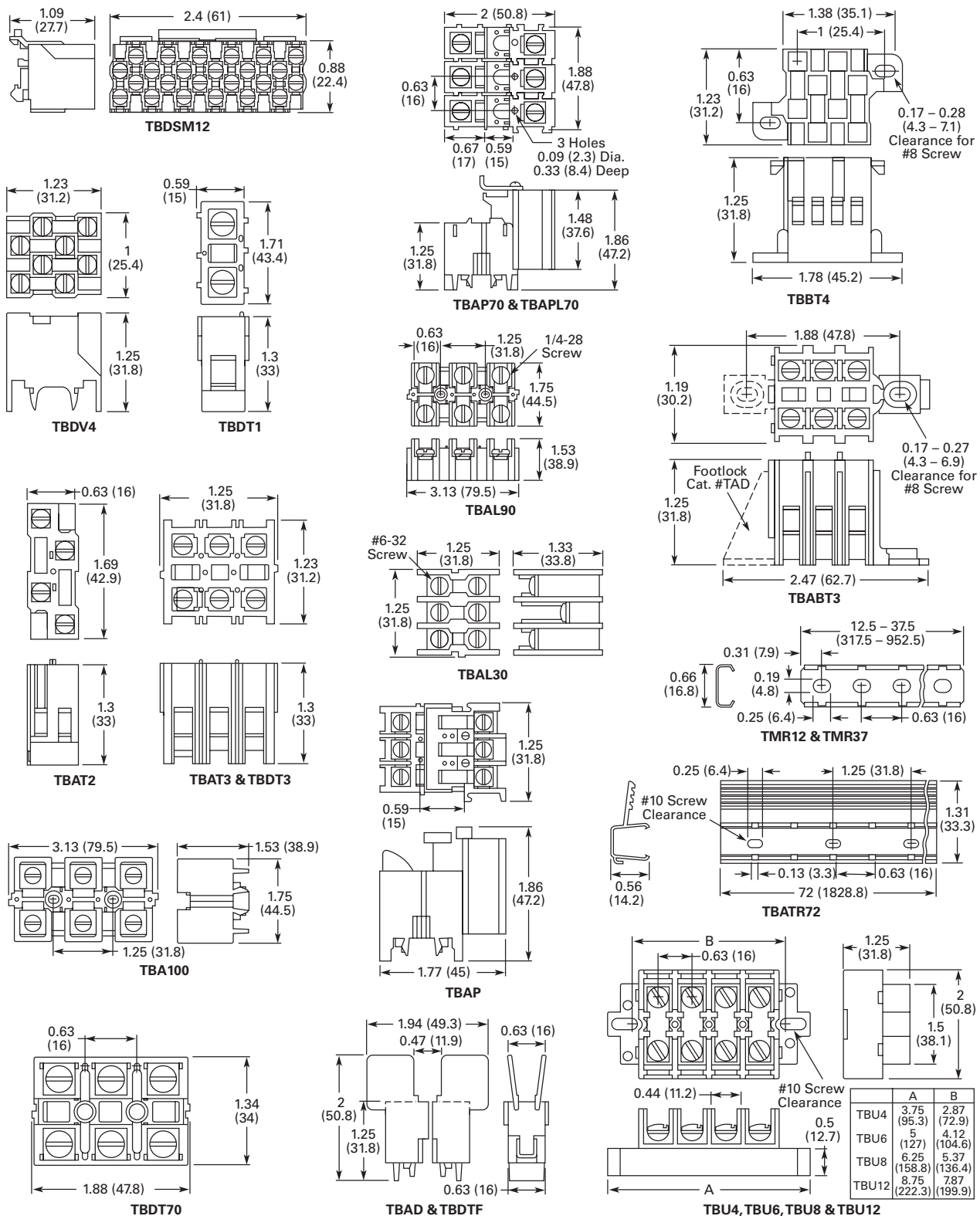

42.3

Terminal Blocks, Fuse Blocks and Fuse Holders

Power Distribution

Power Distribution Products



42

Contents

<i>Description</i>	<i>Page</i>
Power Distribution	
CHDB Series—Power Distribution Blocks	T42-117
CH160 Series—Power Terminal Blocks	T42-123
Power Terminal Block Accessories	T42-126

Power Distribution Overview

Product Selection Guide

Series	Current Range	UL Certification	High Short Circuit Current Rating ^①	UL 508A Approved for Industrial Control Panels		
				Branch Circuits	Feeder Circuits	HVAC UL 1995
CH162	115–175A	UL 1059 Recognized	No	Yes	No ^②	Yes
CH163	175–420A	UL 1059 Recognized	No	Yes	No ^②	Yes
CH165	620–840A	UL 1059 Recognized	No	Yes	No ^②	Yes
CHDB	175–570A	UL 1953 Listed	Yes	Yes	Yes	Yes

Notes

- ① Refer to **Page T42-118** to determine short circuit current ratings with fuses and **Pages T42-119** and **T42-120** to determine short circuit current ratings in conjunction with specific Eaton circuit breakers.
- ② Single-pole units, when installed with proper spacings, may meet requirements for UL 508A feeder circuits.

CHDB Series—Power Distribution Blocks, Enclosed and Open**Contents**

Description	Page
CHDB Series—Power Distribution Blocks	
Product Selection	T42-118
Technical Data and Specifications	T42-118
Dimensions	T42-121
CH160 Series—Power Terminal Blocks	T42-123
Power Terminal Block Accessories	T42-126

CHDB Series—Power Distribution Blocks**Product Description**

Eaton's CHDB Series of Power Distribution Blocks was designed for high short circuit current rating (SCCR) applications up to 200,000 amperes. They are assembled with the minimum spacing to meet UL 1953 requirements for feeder circuits in UL 508A industrial control panels, and provide significant wiring flexibility.

Available in three-pole open style and single-pole enclosed style with a variety of terminal arrangements and current-carrying capability up to 570 amperes.

Features and Benefits**Enclosed Style**

- IP20 finger-safe enclosure
- 600 Vac or Vdc (UL 1953), 690 Vac or Vdc
- DIN rail or panel mount
- Captive termination screws prevent lost screws
- Single-pole, gang mountable for multi-pole applications
- Tin plated Al connections suitable for Cu conductors
- Flammability, UL 94V-0

Open Style

- 600 Vac or Vdc (UL 1953)
- Panel mount
- Three-pole open design for easy wiring
- Tin-plated Al connections suitable for Cu conductors
- Flammability, UL 94V-0
- Available covers for additional protection (does not meet IP20)











Standards and Certifications

- UL Listed 1953, Guide QPOS, File E256146
- CSA Certified, Class 6228-01, File 15364 (enclosed style)
- CE Component IEC 60947-7-1 (enclosed style)
- IEC 60529, IP20 (finger-safe) under specific wiring conditions (enclosed style)



Product Selection

CHDB Series—Power Distribution Blocks

	Line Connection	Load Connection	Configuration	Amperes	Style	Poles	Catalogue Number
	2/0-#8 AWG	(4) #4-#14 AWG		175	Open	3	CHDB2203
	2/0-#8 AWG	(6) #4-#14 AWG		175	Open	3	CHDB3213
	300 kcmil-#4 AWG	(6) #4-#12 AWG		310	Open	3	CHDB3233
	300 kcmil-#4 AWG	(12) #4-#14 AWG		310	Open	3	CHDB3703
	300 kcmil-#4 AWG	(6) #2-#12 AWG (3) 1/0-#12 AWG		310 310	Open Open	3 3	CHDB3713 CHDB3713
	2/0-#8 AWG	2/0-#8 AWG		175	Enclosed ①	1	CHDB204F
	500 kcmil-#6 AWG	(6) #2-#14 AWG		380	Enclosed ①	1	CHDB330F
	300 kcmil-#4 AWG	(12) #4-#14 AWG		570	Enclosed ①	1	CHDB377F

Technical Data and Specifications







































Power Terminal Block Short-Circuit Current Ratings (SCCR) with Fuses

Catalogue Number	Terminal Copper Conductors		Maximum Fuse Class and Amperes				SCCR (kA)
			J	T	RK-1	RK-5	
Line	Load	LPJ	JJS/JJN	LPS-RK/LPN-RK	FRS-R/FRN-R		
CHDB2203	2/0-#8 AWG	#4-#12 AWG	200	200	200	60	200
		#4-#14 AWG	175	175	100	60	100
			200	200	100	60	50
CHDB3213	2/0-#8 AWG	#4-#12 AWG	400	400	200	100	200
			400	400	400	100	100
		#4-#14 AWG	175	175	100	60	100
CHDB3233	300 kcmil-#4 AWG	#4-#8 AWG	400	400	200	100	200
			400	400	400	100	100
		#4-#12 AWG	175	175	100	60	100
CHDB3703	300 kcmil-#4 AWG	#4-#8 AWG	400	400	200	100	200
		#4-#14 AWG	400	400	400	100	100
			175	175	100	60	100
CHDB3713	300 kcmil-#4 AWG	1/0-#6 AWG	400	400	200	100	200
		#4-#12 AWG	400	400	400	100	100
			175	175	100	60	100
CHDB204F	2/0-#8 AWG	2/0-#8 AWG	200	200	100	60	200
CHDB330F	500 kcmil-#6 AWG	#2-#6 AWG	400	400	200	100	200
		#2-#14 AWG	200	200	100	30	50
			175	175	100	30	100
CHDB377F	300 kcmil	#4-#8 AWG	600	600	400	200	200
	300 kcmil-#4 AWG	#4 AWG	600	600	400	200	50
		#4-#14 AWG	200	200	100	30	50

Note

① Finger-safe.

Power Terminal Block Short-Circuit Ratings (SCCR) for UL 508A Applications with Circuit Breakers

Catalogue Number	Description	Enclosure Size in Inches (mm)	Current Rating	Opening per Pole		Line Conductors Cu	Load Conductors Cu	SCCR @ 480V (Load Side)	Eaton Breaker	Available Breaker Current Ratings
				Line	Load					
CHDB2203	Feeder Listed Open PDB	16.00 x 16.00 x 6.75 (406.4 x 406.4 x 171.5)	175			2/0-#8	#4-#10 #12 #14	18 kA 18 kA 14 kA	EGB125	15, 20, 25, 30, 35, 40, 45, 50, 60, 70, 80, 90, 100, 125
CHDB2203	Feeder Listed Open PDB	16.00 x 16.00 x 6.75 (406.4 x 406.4 x 171.5)	175			2/0-#8	#4-#10 #12 #14	25 kA 22 kA 14 kA	EGE125	15, 20, 25, 30, 35, 40, 45, 50, 60, 70, 80, 90, 100, 125
CHDB2203	Feeder Listed Open PDB	16.00 x 16.00 x 6.75 (406.4 x 406.4 x 171.5)	175			2/0-#8	#4-#10 #12 #14	50 kA 22 kA 14 kA	EGS125	15, 20, 25, 30, 35, 40, 45, 50, 60, 70, 80, 90, 100, 125
CHDB2203	Feeder Listed Open PDB	16.00 x 16.00 x 6.75 (406.4 x 406.4 x 171.5)	175			2/0-#8	#4-#10 #12 #14	65 kA 22 kA 14 kA	EGH125	15, 20, 25, 30, 35, 40, 45, 50, 60, 70, 80, 90, 100, 125
CHDB2203	Feeder Listed Open PDB	16.00 x 16.00 x 6.75 (406.4 x 406.4 x 171.5)	175			2/0-#8	#4-#10 #12 #14	65 kA 22 kA 14 kA	EGC125 ^①	15, 20, 25, 30, 35, 40, 45, 50, 60, 70, 80, 90, 100, 125
CHDB3213	Feeder Listed Open PDB	24.00 x 20.00 x 6.75 (609.6 x 508.0 x 171.5)	175			2/0-#8	#4-#10 #12 #14	18 kA 18 kA 18 kA	EGB125	15, 20, 25, 30, 35, 40, 45, 50, 60, 70, 80, 90, 100, 125
CHDB3213	Feeder Listed Open PDB	24.00 x 20.00 x 6.75 (609.6 x 508.0 x 171.5)	175			2/0-#8	#4-#10 #12 #14	25 kA 22 kA 18 kA	EGE125	15, 20, 25, 30, 35, 40, 45, 50, 60, 70, 80, 90, 100, 125
CHDB3213	Feeder Listed Open PDB	24.00 x 20.00 x 6.75 (609.6 x 508.0 x 171.5)	175			2/0-#8	#4-#10 #12 #14	50 kA 22 kA 18 kA	EGS125	15, 20, 25, 30, 35, 40, 45, 50, 60, 70, 80, 90, 100, 125
CHDB3213	Feeder Listed Open PDB	24.00 x 20.00 x 6.75 (609.6 x 508.0 x 171.5)	175			2/0-#8	#4-#10 #12 #14	65 kA 22 kA 18 kA	EGH125	15, 20, 25, 30, 35, 40, 45, 50, 60, 70, 80, 90, 100, 125
CHDB3213	Feeder Listed Open PDB	24.00 x 20.00 x 6.75 (609.6 x 508.0 x 171.5)	175			2/0-#8	#4-#10 #12 #14	65 kA 22 kA 18 kA	EGC125 ^①	15, 20, 25, 30, 35, 40, 45, 50, 60, 70, 80, 90, 100, 125
CHDB204F	Feeder Listed Enclosed PDB	16.00 x 16.00 x 6.75 (406.4 x 406.4 x 171.5)	175			2/0-#8	2/0-#8	18 kA	EGB125	15, 20, 25, 30, 35, 40, 45, 50, 60, 70, 80, 90, 100, 125
CHDB204F	Feeder Listed Enclosed PDB	16.00 x 16.00 x 6.75 (406.4 x 406.4 x 171.5)	175			2/0-#8	2/0-#8	25 kA	EGE125	15, 20, 25, 30, 35, 40, 45, 50, 60, 70, 80, 90, 100, 125
CHDB204F	Feeder Listed Enclosed PDB	16.00 x 16.00 x 6.75 (406.4 x 406.4 x 171.5)	175			2/0-#8	2/0-#8	35 kA	EGS125	15, 20, 25, 30, 35, 40, 45, 50, 60, 70, 80, 90, 100, 125
CHDB204F	Feeder Listed Enclosed PDB	16.00 x 16.00 x 6.75 (406.4 x 406.4 x 171.5)	175			2/0-#8	2/0-#8	65 kA	EGH125	15, 20, 25, 30, 35, 40, 45, 50, 60, 70, 80, 90, 100, 125
CHDB204F	Feeder Listed Enclosed PDB	16.00 x 16.00 x 6.75 (406.4 x 406.4 x 171.5)	175			2/0-#8	2/0-#8	65 kA	EGC125 ^①	15, 20, 25, 30, 35, 40, 45, 50, 60, 70, 80, 90, 100, 125
CHDB3233	Feeder Listed Open PDB	24.00 x 20.00 x 6.75 (609.6 x 508.0 x 171.5)	310			350 kmil-#4	#4-#6 #8 #10	25 kA 25 kA 14 kA	JGE250	70, 90, 100, 125, 150, 175, 200, 225, 250
CHDB3233	Feeder Listed Open PDB	24.00 x 20.00 x 6.75 (609.6 x 508.0 x 171.5)	310			350 kmil-#4	#4-#6 #8 #10	35 kA 35 kA 14 kA	JGS250	70, 90, 100, 125, 150, 175, 200, 225, 250
CHDB3233	Feeder Listed Open PDB	24.00 x 20.00 x 6.75 (609.6 x 508.0 x 171.5)	310			350 kmil-#4	#4-#6 #8 #10	65 kA 42 kA 14 kA	JGH250	70, 90, 100, 125, 150, 175, 200, 225, 250
CHDB3233	Feeder Listed Open PDB	24.00 x 20.00 x 6.75 (609.6 x 508.0 x 171.5)	310			350 kmil-#4	#4-#6 #8 #10	65 kA 42 kA 25 kA	JGC250 ^①	70, 90, 100, 125, 150, 175, 200, 225, 250

Note

① This breaker frame is marked current limiting and suitable for use as current limiting per UL 508A SB.4.3.2.

Power Terminal Block Short-Circuit Ratings (SCCR) for UL 508A Applications with Circuit Breakers, continued

Catalogue Number	Description	Enclosure Size in Inches (mm)	Current Rating	Opening per Pole		Line Conductors Cu	Load Conductors Cu	SCCR at 480V (Load Side)	Eaton Breaker	Available Breaker Current Ratings
				Line	Load					
CHDB3703	Feeder Listed Open PDB	24.00 x 20.00 x 6.75 (609.6 x 508.0 x 171.5)	310			350 kmil-#4	#4-#6 #8 #10	25 kA 25 kA 14 kA	JGE250	70, 90, 100, 125, 150, 175, 200, 225, 250
CHDB3703	Feeder Listed Open PDB	24.00 x 20.00 x 6.75 (609.6 x 508.0 x 171.5)	310			350 kmil-#4	#4-#6 #8 #10	35 kA 35 kA 14 kA	JGS250	70, 90, 100, 125, 150, 175, 200, 225, 250
CHDB3703	Feeder Listed Open PDB	24.00 x 20.00 x 6.75 (609.6 x 508.0 x 171.5)	310			350 kmil-#4	#4-#6 #8 #10	65 kA 42 kA 14 kA	JGH250	70, 90, 100, 125, 150, 175, 200, 225, 250
CHDB3703	Feeder Listed Open PDB	24.00 x 20.00 x 6.75 (609.6 x 508.0 x 171.5)	310			350 kmil-#4	#4-#6 #8 #10	65 kA 42 kA 25 kA	JGC250 ①	70, 90, 100, 125, 150, 175, 200, 225, 250
CHDB3713	Feeder Listed Open PDB	24.00 x 20.00 x 6.75 (609.6 x 508.0 x 171.5)	310			350 kmil-#4	#4-#6 #8 #10	25 kA 25 kA 14 kA	JGE250	70, 90, 100, 125, 150, 175, 200, 225, 250
CHDB3713	Feeder Listed Open PDB	24.00 x 20.00 x 6.75 (609.6 x 508.0 x 171.5)	310			350 kmil-#4	#4-#6 #8 #10	35 kA 35 kA 14 kA	JGS250	70, 90, 100, 125, 150, 175, 200, 225, 250
CHDB3713	Feeder Listed Open PDB	24.00 x 20.00 x 6.75 (609.6 x 508.0 x 171.5)	310			350 kmil-#4	#4-#6 #8 #10	50 kA 42 kA 14 kA	JGH250	70, 90, 100, 125, 150, 175, 200, 225, 250
CHDB3713	Feeder Listed Open PDB	24.00 x 20.00 x 6.75 (609.6 x 508.0 x 171.5)	310			350 kmil-#4	#4-#6 #8 #10	65 kA 50 kA 25 kA	JGC250 ①	70, 90, 100, 125, 150, 175, 200, 225, 250
CHDB330F	Feeder Listed Enclosed PDB	24.00 x 20.00 x 6.75 (609.6 x 508.0 x 171.5)	380			500 kmil-#3	#2-#8	14 kA	LGE400	250, 300, 350, 400
CHDB330F	Feeder Listed Enclosed PDB	24.00 x 20.00 x 6.75 (609.6 x 508.0 x 171.5)	380			500 kmil-#3	#2-#8	14 kA	LGS400	250, 300, 350, 400
CHDB330F	Feeder Listed Enclosed PDB	24.00 x 20.00 x 6.75 (609.6 x 508.0 x 171.5)	380			500 kmil-#3	#2-#8	14 kA	LGH400	250, 300, 350, 400
CHDB330F	Feeder Listed Enclosed PDB	24.00 x 20.00 x 6.75 (609.6 x 508.0 x 171.5)	380			500 kmil-#3	#2-#8	25 kA	LGC400 ①	250, 300, 350, 400
CHDB377F	Feeder Listed Enclosed PDB	24.00 x 20.00 x 6.75 (609.6 x 508.0 x 171.5)	570			(2) 300 kmil-#2	#4 #6 #8	30 kA 18 kA 14 kA	LGE600	250, 300, 350, 400, 500, 600
CHDB377F	Feeder Listed Enclosed PDB	24.00 x 20.00 x 6.75 (609.6 x 508.0 x 171.5)	570			(2) 300 kmil-#2	#4 #6 #8	30 kA 18 kA 14 kA	LGS600	250, 300, 350, 400, 500, 600
CHDB377F	Feeder Listed Enclosed PDB	24.00 x 20.00 x 6.75 (609.6 x 508.0 x 171.5)	570			(2) 300 kmil-#2	#4 #6 #8	30 kA 18 kA 14 kA	LGH600	250, 300, 350, 400, 500, 600
CHDB377F	Feeder Listed Enclosed PDB	24.00 x 20.00 x 6.75 (609.6 x 508.0 x 171.5)	570			(2) 300 kmil-#2	#4 #6 #8	42 kA 35 kA 14 kA	LGC600 ①	250, 300, 350, 400, 500, 600

Note

① This breaker frame is marked current limiting and suitable for use as current limiting per UL 508A SB.4.3.2.

Dimensions

Approximate Dimensions in Inches (mm)

CHDB2203

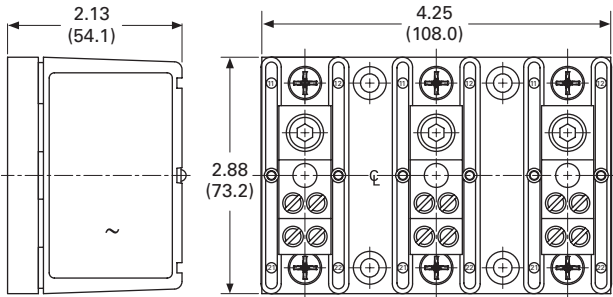

CHDB3713

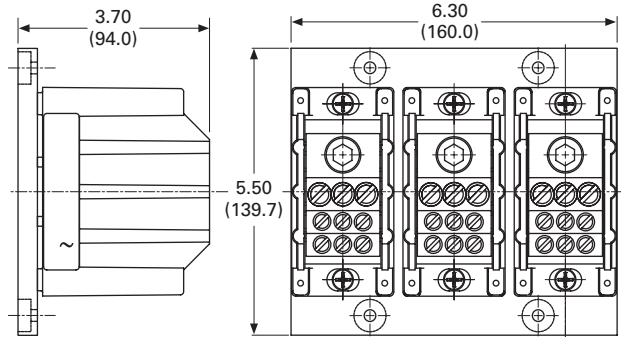

CHDB3213

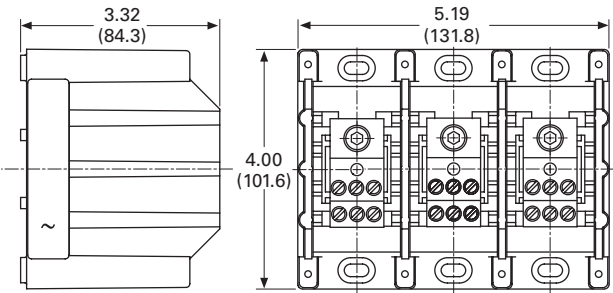

CHDB204F

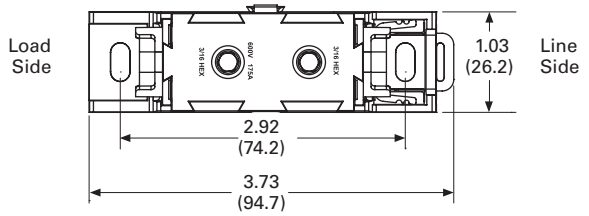

CHDB3233

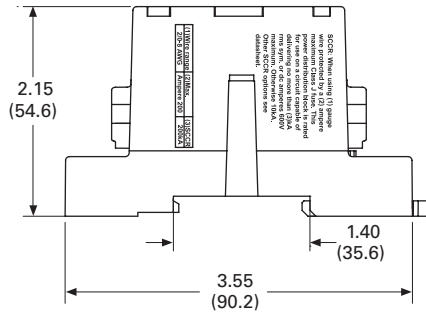
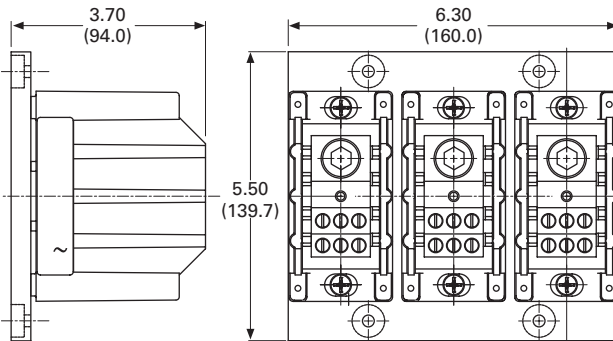

CHDB3703

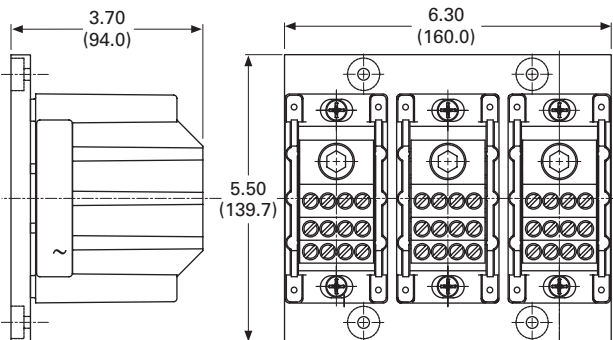

42.3

Terminal Blocks, Fuse Blocks and Fuse Holders

Power Distribution

Approximate Dimensions in Inches (mm)

CHDB330F

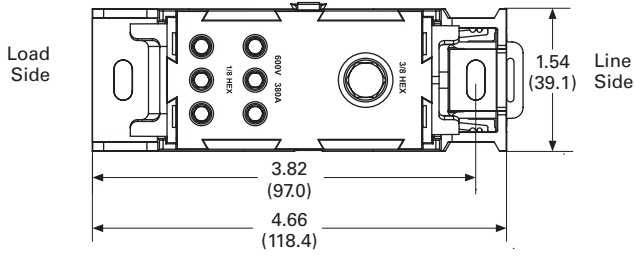

CHDB377F

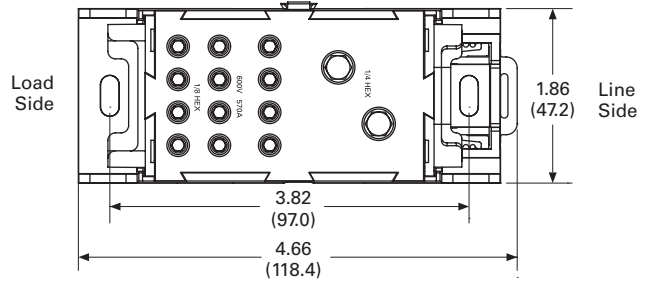

42

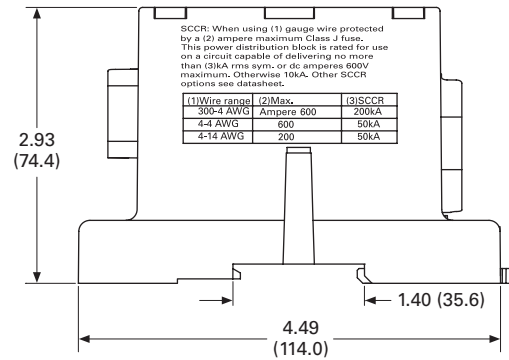
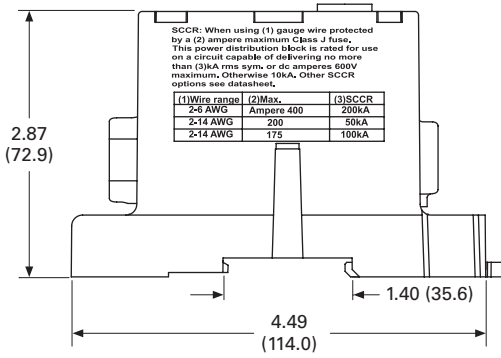

CH160 Series—Power Terminal Blocks**Contents**

Description	Page
CHDB Series—Power Distribution Blocks	T42-117
CH160 Series—Power Terminal Blocks	
Product Selection	T42-124
Technical Data and Specifications	T42-125
Dimensions	T42-125
Power Terminal Block Accessories	T42-126

CH160 Series—Power Terminal Blocks**Product Description**

The CH160 Series of Power Terminal Blocks are UL 1059 recognized power terminal blocks for branch circuit applications. All short circuit current ratings (SCCR) are 10 kA per UL 508A Table SB4.1. The blocks are available in a wide variety of wiring configurations, providing excellent flexibility.

Features and Benefits

- Ratings: To 840A, 600V
- Materials
 - Molded material; black, UL rated 94V-0 thermoplastic
- Operating temperature: 302°F (150°C)
- Optional cover:
See **Page T42-126**

Standards and Certifications

- UL Recognized
- CSA Certified



Product Selection**When Ordering, Specify**

- Catalogue number
- Number of poles (up to three-pole available)

CH160 Power Terminal Blocks—CH162 Series

Line Connection	Load Connection	Connector Material and Ampacity	Catalogue Number ^①
#2-#14 Cu/#8 Al	#2-#14 Cu/#8 Al	Al 115A	CH16200_
1/0-#14 Cu	1/0-#14 Cu	Cu 150A	CH16201_
2/0-#8 Cu/Al	2/0-#8 Cu/Al	Al 175A	CH16204_
2/0-#14 Cu/#8 Al	(4) #4-#14 Cu/#8 Al	Al 175A	CH16220_

CH160 Power Terminal Blocks—CH163 Series

Line Connection	Load Connection	Connector Material and Ampacity	Catalogue Number ^①
250 kcmil-#6 Cu	250 kcmil-#6 Cu	Cu 255A	CH16301_
350 kcmil-#6 Cu/Al	350 kcmil-#6 Cu/Al	Al 310A	CH16303_
500 kcmil-#6 Cu/Al	500 kcmil-#6 Cu/Al	Al 380A	CH16306_
2/0-#14 Cu/Al	(6) #4-#14 Cu/#8 Al	Al 175A	CH16321_
350 kcmil-#6 Cu/Al	(6) #4-#14 Cu/#8 Al	Al 310A	CH16323_
(2) 2/0-#14 Cu/#8 Al	(6) #4-#14 Cu/#8 Al	Al 350A	CH16325_
500 kcmil-#6 Cu/Al	(6) #2-#14 Cu/#8 Al	Al 380A	CH16330_
350 kcmil-#6 Cu/Al	(3) #2-#14 Cu/#8 Al	Al 310A	CH16332_
	(2) 1/0-#14 Cu/#8 Al	Al 310A	CH16332_
350 kcmil-#6 Cu/Al	(12) #4-#14 Cu/#8 Al	Al 310A	CH16370_
350 kcmil-#6 Cu/Al	(6) #2-#14 Cu/#8 Al	Al 310A	CH16371_
	(3) 1/0-#14 Cu/#8 Al	Al 310A	CH16371_
350 kcmil-#6 Cu/Al	(21) #10-#14 Cu/#10 Al	Al 310A	CH16372_
350 kcmil-#6 Cu/Al	(3) 1/0-#14 Cu/#8 Al	Al 310A	CH16373_
	(14) #10-#14 Cu/#8 Al	Al 310A	CH16373_
600 kcmil-#2 Cu/Al	(12) #4-#14 Cu/#8 Al	Al 420A	CH16375_
600 kcmil-#2 Cu/Al	(6) #2-#14 Cu/#8 Al	Al 420A	CH16376_
	(3) 1/0-#14 Cu/#8 Al	Al 420A	CH16376_

CH160 Power Terminal Blocks—CH165 Series

Line Connection	Load Connection	Connector Material and Ampacity	Catalogue Number ^①
(2) 350 kcmil-4 Cu/Al	(2) 350 kcmil-4 Cu/Al	Al 620A	CH16500_
(2) 500 kcmil-#6 Cu/Al	(2) 500 kcmil-#6 Cu/Al	Al 760A	CH16504_
(2) 600 kcmil-#2 Cu/Al	(4) 3/0-#8 Cu/Al	Al 840A	CH16528_
	(4) #4-#14 Cu/#8 Al	Al 840A	CH16528_
(2) 500 kcmil-#6 Cu/Al	(12) #4-#14 Cu/#8 Al	Al 760A	CH16530_

Note

- ^① Incomplete catalogue number—add code suffix **-1**, **-2**, **-3** for number of poles.
Example: For a 150A 1/0-#14 Cu to 1/0-#14 Cu three-pole PDB, order CH16201-3.

Technical Data and Specifications

CH160 Power Terminal Blocks

Description	Specification
Ratings	To 840A, 600V
Materials	Molded material; black, UL rated 94V-0 thermoplastic
Operating temperature	302°F (150°C)

Note: For optional cover, see Power Terminal Block Accessories, **Page T42-126**.

Dimensions

Approximate Dimensions in Inches (mm)

Series CH163 (Single-, Two- and Three-Pole Available)

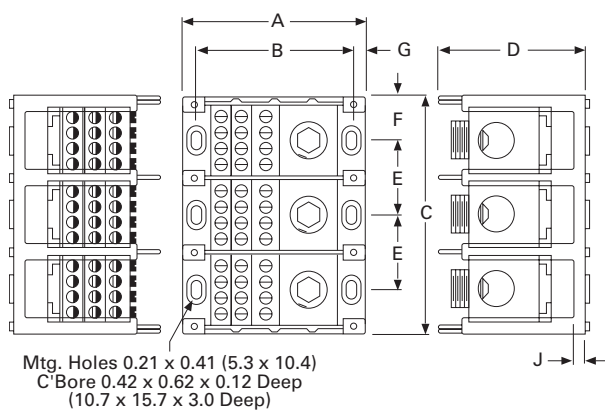

Series CH162 and CH165 (Single-, Two- and Three-Pole Available)

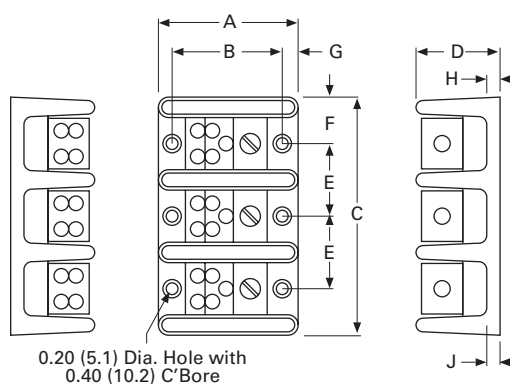

CH160 Power Terminal Block Dimensions

Series	A	B	C			D	E4	F	G	H	J
			Single-Pole	Two-Pole	Three-Pole						
CH162	2.87 (72.9)	2.25 (57.2)	1.06 (26.9)	1.87 (47.5)	2.68 (68.1)	1.75 (44.5)	0.81 (20.6)	0.53 (13.5)	0.31 (7.9)	0.84 (21.3)	0.31 (7.9)
CH163	4.00 (101.6)	3.37 (85.6)	1.96 (49.8)	3.58 (90.9)	5.20 (132.1)	3.32 (84.3)	1.62 (41.1)	0.97 (24.6)	0.31 (7.9)	0.87 (22.1)	0.35 (8.9)
CH165	5.50 (139.7)	4.75 (120.7)	3.12 (79.2)	5.81 (147.6)	8.50 (215.9)	3.12 (79.2)	2.68 (68.1)	1.56 (39.6)	0.37 (9.4)	1.37 (34.8)	0.62 (15.7)

Power Terminal Block Accessories



42

Contents

<i>Description</i>	<i>Page</i>
CHDB Series—Power Distribution Blocks	T42-117
CH160 Series—Power Terminal Blocks	T42-123
Power Terminal Block Accessories	
Technical Data and Specifications	T42-127
Dimensions	T42-127

Power Terminal Block Accessories

Product Description

Protective Cover

- Guards against accidental contact
- Clear with write-on surface for field termination identification
- Available in single-, two- and three-pole

Standards and Certifications

TB Series Power Blocks

- Contact Eaton for the latest UL 508A short circuit ratings on terminal blocks
- UL Recognized: File No. E62622
- CSA Certified: File No. LR15364



Product Selection

When Ordering, Specify

- Catalogue number

CH163 Series Cover

Description	Catalogue Number
Single-pole cover	CHCPDB-1 ①
Two-pole cover	CHCPDB-2 ①
Three-pole cover	CHCPDB-3 ①

TB Series Power Blocks

Line Connection	Load Connection	Catalogue Number
#300 kcmil-#6 Cu/Al	(6) #6-#14 Cu/#8Al	TBAN63

Note

① Standard pack, five pieces.

Technical Data and Specifications

TB Series Power Blocks

Description	Specification
Ratings	285A, 600V; UL/CSA
Materials	Molded material; black, UL rated 94V-2 thermoplastic
Operating temperature	257°F (125°C)

Dimensions

Approximate Dimensions in Inches (mm)

CH163 Series Cover

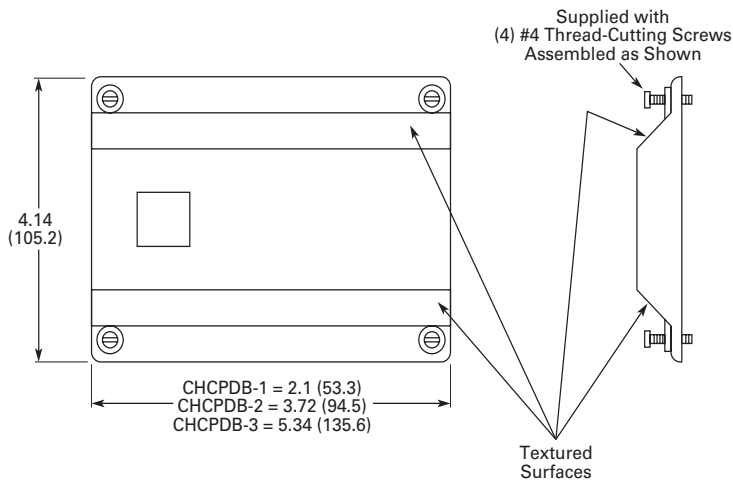

TB Series Power Blocks

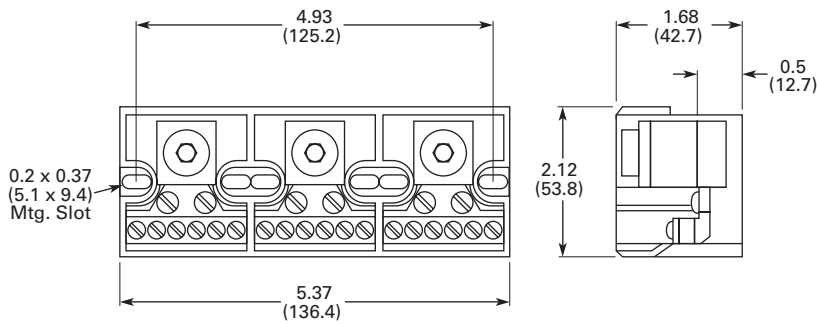

42.4

Terminal Blocks, Fuse Blocks and Fuse Holders

Fuse Blocks and Fuse Holders

Fuse Blocks and Fuse Holders



42

Contents

<i>Description</i>	<i>Page</i>
Fuse Blocks and Fuse Holders	
C383 Series Disconnect Fuse Holders	T42-129
C350 Series Fuse Blocks and W Series Fuse Holders	T42-131

Fuse Blocks and Fuse Holders Overview

Product Description

Available in compact finger safe (C383) and an open (C350) design. Eaton's fuse blocks and holders provide a simple DIN mounting device for protection in control circuits.

Application Description

Fuse holders and blocks available for Class CC, midget, H, M and R.

Standards and Certifications

- UL listed
- CSA certified (may not apply to all styles)



C383 Series Fuse Holders**Contents**

Description	Page
C383 Series Disconnect Fuse Holders	
Product Selection	T42-130
Accessories	T42-130
Technical Data and Specifications	T42-130
Dimensions	T42-130
C350 Series Fuse Blocks and W Series Fuse Holders	T42-131

C383 Series Disconnect Fuse Holders**Product Description**

Eaton's C383 Series disconnect fuse holders offer 600V fused circuit protection and subsequently "no load" switching.

These compact disconnects are designed as components in switchboards, panels and control consoles where positive and safe circuit protection is required and where space is at a premium.

The C383 fuse holders mount directly on standard TS35 DIN rails.

Features

- "Finger-Safe" design— Recessed termination screws and a fuse extraction door afford you IP20 grade protection and qualify as "finger-safe" per IEC standards
- Easy to adjust position on rail—Simply unlatch the DIN rail adapter, slide the holder to desired position and relock
- Quick change of fuse— A permanently attached pivoting fuse door simplifies and speeds fuse extraction. No tools or accessories needed
- Class CC model is UL listed and CSA certified for branch circuit protection. Midget models are UL Recognized and CSA certified for supplementary and high-speed protection
- Runs cool—The vented design provides adequate air flow around the holders at all times
- Self-extinguishing UL 94-VO rated polyester material

Standards and Certifications

Rated voltage:

- CSA/UL: 600 Vac/Vdc, 30A
- IEC (midget only): 690 Vac, 32A



42.4

Terminal Blocks, Fuse Blocks and Fuse Holders

Fuse Blocks and Fuse Holders

Product Selection

C383FH_



Disconnect Fuse Holders

Description	Standard Pack	Catalogue Number
For Class CC Fuse		
Single-pole fuse holder	12	C383FHCC
For Midget Fuse (1-1/2 in x 13/32 in)		
Single-pole fuse holder	12	C383FHMD

42

Accessories

Disconnect Fuse Holders

Description	Standard Pack	Catalogue Number
Midget or Class CC Fuse Holder		
Multi-pole connection links	100	C383MPCL
Multi-pole handle pins	100	C383MPHP

Accessory Details

C383MPCL

Multi-pole connection links can be used to connect fuse holders together for multi-pole applications. Use two per connection.

C383MPHP

Handle pins can be used to connect handles in multi-pole applications.

Technical Data and Specifications

Disconnect Fuse Holders ①

Description	Specification
Housing	Polyester UL 94-V0 rated
Colour	White
Wire size	8–18 AWG ②
Torque	22 lb-in (2.5 Nm)
Fuse size	0.41 x 1.5 in

Dimensions

Approximate Dimensions in Inches (mm)

CH163 Series Cover

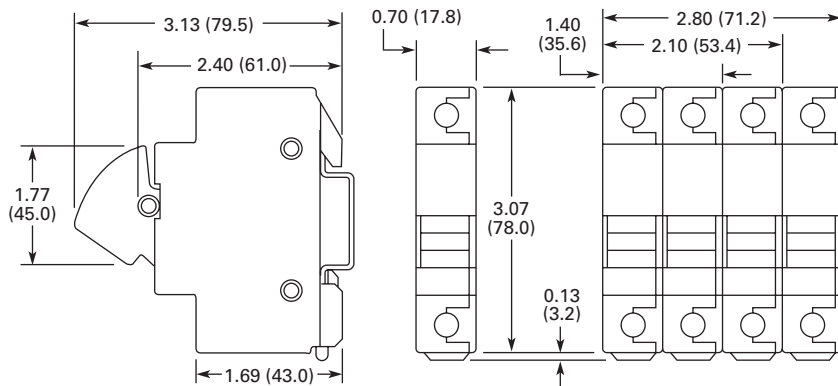

Notes

- ① For additional technical information, consult the Eaton web site or Customer Support Centre.
- ② UL recognizes both solid and stranded wire. Ferrules are not required. CSA requires ferrules on stranded wire to achieve approval.

C350 Series Fuse Blocks and W Series Fuse Holders



Contents

Description	Page
C383 Series Disconnect Fuse Holders	T42-129
C350 Series Fuse Blocks and W Series Fuse Holders	
Product Selection	T42-132
Accessories	T42-133
Technical Data and Specifications	T42-133
Dimensions	T42-133

C350 Series Fuse Blocks and W Series Fuse Holders

Product Description

Fuse Blocks

These space-saving Type C350 Fuse Blocks are UL approved for motor loads and are rated 600V, 30A.

Fuse Holders

- Class H, M and R

Features

Fuse Blocks

- Mount to 35 mm flat and 32 mm asymmetrical DIN rails
- 600V, 30A rated captive pressure plate terminals with copper alloy fuse clips
- Interlocking fuse blocks permit single, double or three-pole application—reduce inventory
- Class CC fuses have an interrupting rating of 200,000A
- Rejection feature prevents insertion of fuses with lower interrupting or voltage ratings

Fuse Holders

- Break-resistant: molded of heat-stabilized nylon
- Fuse clips: spring-reinforced for cool operation
- Fuse clip terminations: one-piece construction
- Universal mounting dimensions, for easy assembly and retrofit
- Breathing action collar: maintenance-free
- Pressure wire connectors: vibration resistant

Standards and Certifications

Contact Eaton for the latest UL 508A short circuit ratings on terminal blocks.

Fuse Blocks

- UL listed
- CSA certified



Fuse Holders

- UL tested for OEM subfeed applications



Fuse Blocks and Adapters

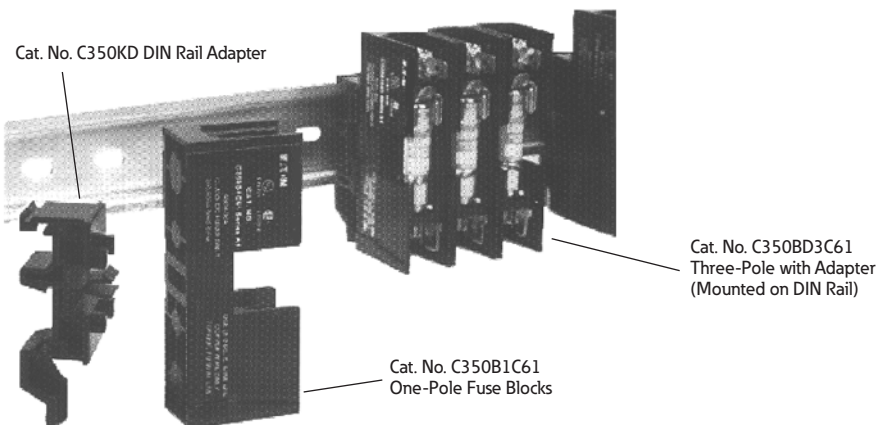

42.4

Terminal Blocks, Fuse Blocks and Fuse Holders



Fuse Blocks and Fuse Holders

Product Selection







Class CC Fuse Blocks

Type	Catalogue Number
Three-pole ^①	C350BD3C61
Single-pole	C350B1C61
DIN adapter	C350KD

Fuse Holders—250V

Wire Termination		Number of Poles	Carton Qty.	30A Catalogue Number	Carton Qty.	60A Catalogue Number
Class H Fuse Holders						
Single collar (box lug)—sized to ampere rating		1	10	W231HA	10	W261HA
		2	5	W232HA	5	W262HA
		3	5	W233HA	5	W263HA
Class R Fuse Holders						
Single collar (box lug)—sized to ampere rating		1	10	WR231HA	—	—
		2	—	—	—	—
		3	5	WR233HA	1	WR263HA

Fuse Holders—600V

Wire Termination		Number of Poles	Carton Qty.	30A Catalogue Number	Carton Qty.	60A Catalogue Number
Class H Fuse Holders						
Single collar (box lug)—sized to ampere rating		1	10	W631HA	1	W661HA
		2	5	W632HA	1	W662HA
		3	1	W633HA	2	W663HA
Class M Fuse Holders						
Combination of double quick-connect, 20A max., and binding head screw, #10 max., Cu/Al		1	10	WM631F	—	—
		2	8	WM632F	—	—
		3	6	WM633F	—	—
Combination of double quick-connect, 20A max., and pressure plate screw, #10 max., Cu only		1	10	WM631G	—	—
		2	8	WM632G	—	—
		3	6	WM633G	—	—
Class R Fuse Holders						
Single collar (box lug)—sized to ampere rating		1	10	WR631HA	—	—
		2	5	WR632HA	—	—
		3	5	WR633HA	5	WR663HA
Combination of double quick-connect, 20A max., and binding head screw, #10 max., Cu/Al		1	—	—	—	—
		2	1	WMR632F	—	—
		3	6	WMR633F	—	—
Combination of double quick-connect, 20A max., and pressure plate screw, #10 max., Cu only		1	10	WMR631G	—	—
		3	6	WMR633G	—	—
Class R Fuse Holder, Type WRR Control Transformer Fuse Blocks						
Combination of double quick-connect, 20A max., and pressure plate screw, #14–#10 Cu only		3	6	WRR633G	—	—

Note

^① Three-pole device is supplied with DIN rail adapter.

42

Class R, Three-Pole Fuse Holder



Accessories

Fuse Holder Accessories

Description	Catalogue Number
Fuse puller	TBP
Lighted fuse puller (120 Vac)	TBLP

Technical Data and Specifications

Fuse Blocks

Description	Specification
Voltage rating	600V
Ampere rating	Pressure plate terminals rated for 30A
Dielectric strength	1200V maximum
Ambient temperature	221°F (105°C) maximum
Clip/terminals	Tin-plated copper alloy
Screw and captive pressure plate	Zinc-plated steel
Base	Thermoplastic UL 94V0 flammability rating
DIN rail adapter	Thermoplastic UL 94V0 flammability rating

Dimensions

Approximate Dimensions in Inches (mm)

Fuse Blocks

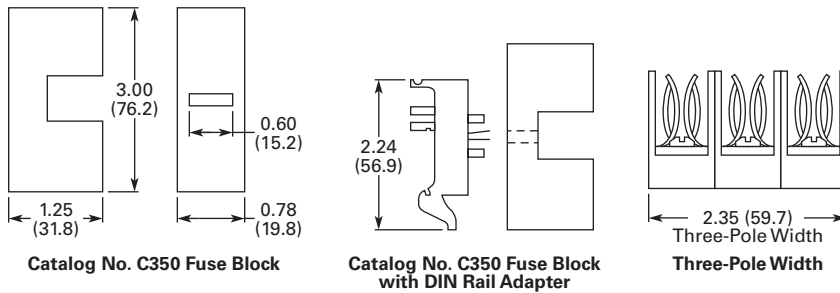

Fuse Holders

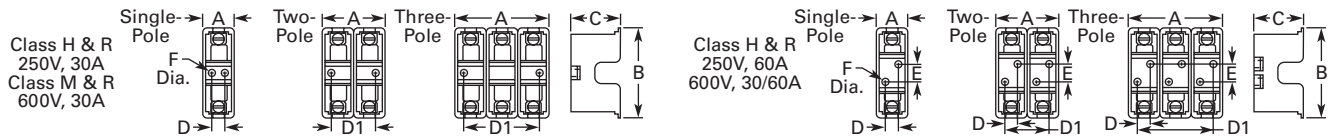

Class	Volts/ Amperes	Width A			Height B	Depth C	Mounting Holes			Diameter F	Number of Mounting Holes			
		Single- Pole	Two- Pole	Three- Pole			D	Two-Pole D1	Three-Pole D1		E	Single- Pole	Two- Pole	Three- Pole
H, R	250V, 30A	1.00 (25.4)	2.00 (50.8)	3.00 (76.2)	3.13 (79.5)	1.56 (39.6)	0.38 (9.7)	1.25 (31.8)	2.50 (63.5)	—	0.22 (5.6)	2	2	2
	250V, 60A	1.44 (36.6)	2.88 (73.2)	4.31 (109.5)	4.75 (120.7)	2.06 (52.3)	0.50 (12.7)	1.81 (46.0)	3.13 (79.5)	1.25 (31.8)	0.22 (5.6)	2	4	4
	600V, 30/60A	1.69 (42.9)	3.38 (85.9)	5.06 (128.5)	6.94 (176.3)	2.63 (66.8)	0.63 (16.0)	2.19 (55.6)	3.75 (95.3)	3.13 (79.5)	0.28 (7.1)	2	4	4
M, R	600V, 30A	0.84 (21.3)	1.63 (41.4)	2.41 (61.2)	3.00 (76.2)	1.28 (32.5)	0.38 (9.7)	0.75 (19.1)	1.50 (38.1)	—	0.17 (4.3)	2	2	2

42.4

Terminal Blocks, Fuse Blocks and Fuse Holders

Fuse Blocks and Fuse Holders

This page left intentionally blank