

WLRS, WLRD and WLGf Wet Location Covers

For NEMA Configuration Receptacle Interiors For FS and FD Cast Device Boxes Flush Device Boxes

Applications:

WLRS, WLRD and WLGf series covers are suitable for use in wet and damp locations. WLGf is suitable for damp and wet locations only when cover is closed. WLRS and WLRD series wiring device covers are designed to meet the total NEC Code requirements for wet locations – Article 410-57:

"A receptacle installed outdoors where exposed to weather or in other wet locations shall be in a weatherproof enclosure, the integrity of which is not affected when the receptacle is in use (attachment plug cap inserted)."

Use WLRS, WLRD and WLGf:

- Wherever portable equipment is required
- As general purpose utility receptacle covers
- For industrial, commercial or residential use
- In areas where electrical requirements do not exceed medium duty ratings
- To mount FS and FD single-gang or multi-gang boxes having individual cover openings (see Sect. 2F for listings)
- To mount on most flush device boxes (see Accessories)

Features:

WLRS, WLRD and WLGf covers:

- Self-closing spring door assures protection of wiring device at all times, in wet and damp locations
- One piece EPDM gasket provides environmental protection of wiring device at all times
- Specially formulated elastomeric gasketing material offers excellent resistance to ozone, weather and temperature extremes of -50°F to 260°F
- Die cast, copper-free aluminum construction with aluminum lacquer finish provides maximum corrosion resistance
- Positive ground path ensured for all exposed metal parts

NEMA configuration receptacle interiors:

- Comply with NEMA Standards WD-1 and WD-5
- Grounded through an extra contact in all types except 3-phase applications; self-grounded in duplex variety
- Back and side wired
- Offered in single and duplex configurations for use with standard plugs
- Specification grade

Certifications and Compliances:

- ANSI/UL Standard: 514A
- NEC Code 410-57
- NEMA Standards: WD-1, 1983 (Straight Blade) and WD-5, 1982 (Locking Type)

Standard Materials:

- WLRS, WLRD and WLGf face plate and cover – die cast copper-free aluminum
- Cover hinge spring – stainless steel
- Cover screws – corrosion resistant metal
- Gasket – WLRS and WLRD – ethylene propylene rubber (EPDM)
- Gasket – WLGf – neoprene

Standard Finishes:

- Copper-free aluminum

Electrical Rating Ranges:

- 15 amperes; 125, 250, or 277 volts
- 20 and 30 amperes; 125, 250, 277, 480, 600, 125/250, 208/120, 480/277 or 600/347 volts

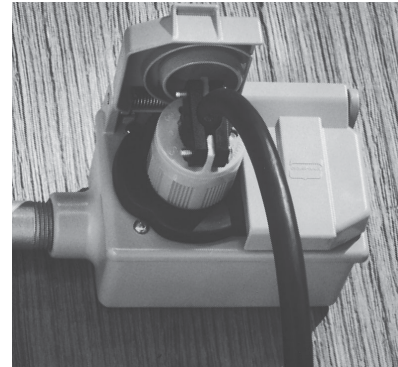

Typical Installation

Accessories:

- Flush mounting adapter – WLRA-1 required for mounting on device boxes (not required with WLGf)

Spring Door Covers – with Gasket*

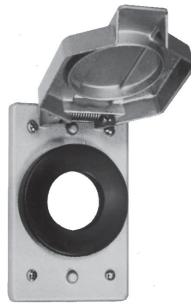

Single Cover

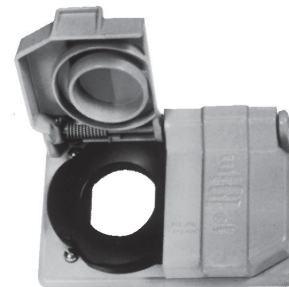

Duplex Cover

Cat. #	Description	Opening Dia.
WLRS1	Single cover	1 3/8" "
WLRS2	Single cover	1 1/2" "
WLRD1	Duplex cover	1 3/8" "

*Patent Number 4,058,358



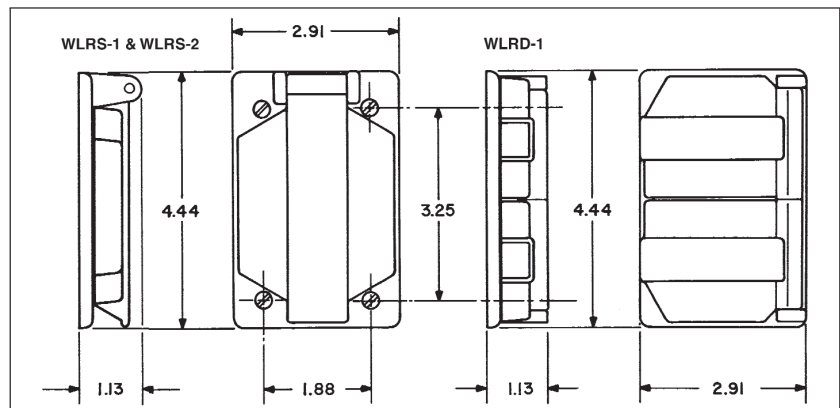





Dimensions In Inches:







WLRS, WLRD and WLGf Wet Location Covers

6P

Covers with and without NEMA Configuration Receptacles Single Device

Type	Volts	NEMA Configuration	Complete Cover with Receptacle Assy. Cat. #	Spring Door Cover & Gasket Only Cat. #‡
For Non-locking Blade Plugs				
2-Pole 3-Wire Grounding 15 Amp	125V	 5-15R	WLRS 5 15	WLRs1
	250V	 6-15R	WLRS 6 15	WLRs1
2-Pole 3-Wire Grounding 20 Amp	125V	 5-20R	WLRS 5 20	WLRs1
	250V	 6-20R	WLRS 6 20	WLRs1
For Locking Blade Plugs				
2-Pole 3-Wire Grounding 15 Amp	125V	 L5-15R	WLRS L5 15	WLRs1
	250V	 L6-15R	WLRS L6 15	WLRs1
2-Pole 3-Wire Grounding 20 Amp	125V	 L5-20R	WLRS L5 20	WLRs2
	250V	 L6-20R	WLRS L6 20	WLRs2

Duplex Device

Type	Volts	NEMA Configuration	Complete Cover with Receptacle Assy. Cat. #	Spring Door Cover & Gasket Only Cat. #‡
For Non-locking Blade Plugs				
2-Pole 3-Wire Grounding 15 Amp	125V	 5-15R	WLRD 5 15	WLRD1
	250V	 6-15R	WLRD 6 15	WLRD1
2-Pole 3-Wire Grounding 20 Amp	125V	 5-20R	WLRD 5 20	WLRD1
	250V	 6-20R	WLRD 6 20	WLRD1
For Locking Blade Plugs				
2-Pole 3-Wire Grounding 15 Amp	125V	 L5-15R	WLRD L5 15	WLRD1

Wet Location Covers for GFCI Duplex Receptacles:



WLGF - horizontal mount for flush device boxes.



WLGf FS - horizontal mount for FS and FD device boxes.



WLGf FSV - vertical mount for FS and FD device boxes.

Dimensions In Inches:

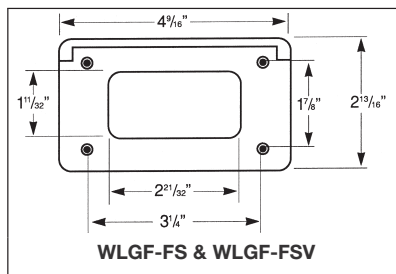
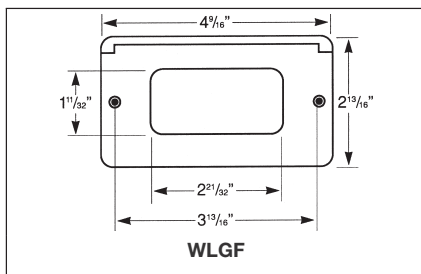

‡ Must be used with a wet locations rated wiring device.

WLRS, WLRD and WLGf Wet Location Covers

For NEMA Configuration Receptacle Interiors For FS and FD Cast Device Boxes Flush Device Boxes

Applications:

WLRS, WLRD and WLGf series covers are suitable for use in wet and damp locations. WLGf is suitable for damp and wet locations only when cover is closed. WLRS and WLRD series wiring device covers are designed to meet the total NEC Code requirements for wet locations – Article 410-57:

"A receptacle installed outdoors where exposed to weather or in other wet locations shall be in a weatherproof enclosure, the integrity of which is not affected when the receptacle is in use (attachment plug cap inserted)."

Use WLRS, WLRD and WLGf:

- Wherever portable equipment is required
- As general purpose utility receptacle covers
- For industrial, commercial or residential use
- In areas where electrical requirements do not exceed medium duty ratings
- To mount FS and FD single-gang or multi-gang boxes having individual cover openings (see Sect. 2F for listings)
- To mount on most flush device boxes (see Accessories)

Features:

WLRS, WLRD and WLGf covers:

- Self-closing spring door assures protection of wiring device at all times, in wet and damp locations
- One piece EPDM gasket provides environmental protection of wiring device at all times
- Specially formulated elastomeric gasketing material offers excellent resistance to ozone, weather and temperature extremes of -50°F to 260°F
- Die cast, copper-free aluminum construction with aluminum lacquer finish provides maximum corrosion resistance
- Positive ground path ensured for all exposed metal parts

NEMA configuration receptacle interiors:

- Comply with NEMA Standards WD-1 and WD-5
- Grounded through an extra contact in all types except 3-phase applications; self-grounded in duplex variety
- Back and side wired
- Offered in single and duplex configurations for use with standard plugs
- Specification grade

Certifications and Compliances:

- ANSI/UL Standard: 514A
- NEC Code 410-57
- NEMA Standards: WD-1, 1983 (Straight Blade) and WD-5, 1982 (Locking Type)

Standard Materials:

- WLRS, WLRD and WLGf face plate and cover – die cast copper-free aluminum
- Cover hinge spring – stainless steel
- Cover screws – corrosion resistant metal
- Gasket – WLRS and WLRD – ethylene propylene rubber (EPDM)
- Gasket – WLGf – neoprene

Standard Finishes:

- Copper-free aluminum

Electrical Rating Ranges:

- 15 amperes; 125, 250, or 277 volts
- 20 and 30 amperes; 125, 250, 277, 480, 600, 125/250, 208/120, 480/277 or 600/347 volts

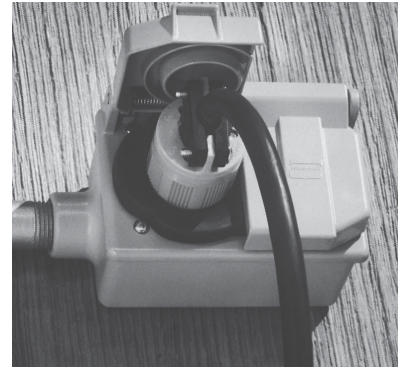

Typical Installation

Accessories:

- Flush mounting adapter – WLRA-1 required for mounting on device boxes (not required with WLGf)

Spring Door Covers – with Gasket*

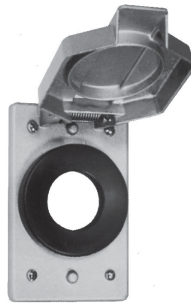

Single Cover

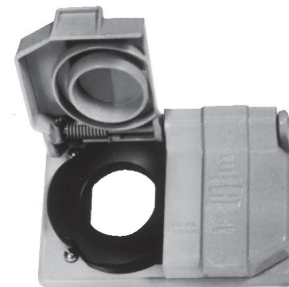

Duplex Cover

Cat. #	Description	Opening Dia.
WLRS1	Single cover	1 3/8"
WLRS2	Single cover	1 1/2"
WLRD1	Duplex cover	1 3/8"

*Patent Number 4,058,358



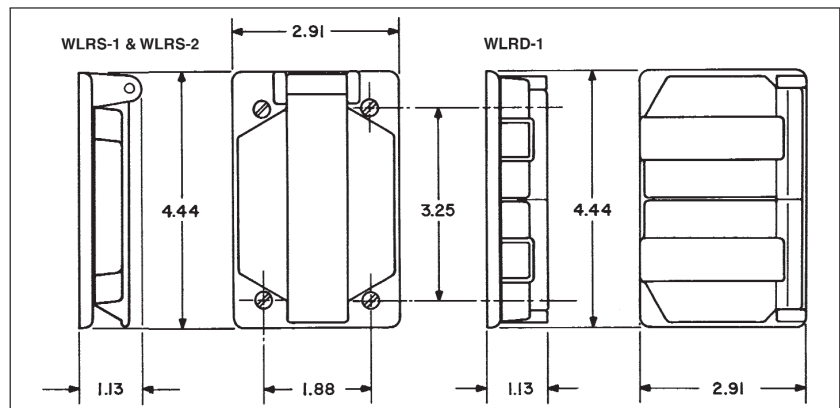





Dimensions In Inches:







WLRS, WLRD and WLGf Wet Location Covers

6P

Covers with and without NEMA Configuration Receptacles Single Device

Type	Volts	NEMA Configuration	Complete Cover with Receptacle Assy. Cat. #	Spring Door Cover & Gasket Only Cat. #‡
For Non-locking Blade Plugs				
2-Pole 3-Wire Grounding 15 Amp	125V		WLRS 5 15	WLRs1
	250V		WLRS 6 15	WLRs1
2-Pole 3-Wire Grounding 20 Amp	125V		WLRS 5 20	WLRs1
	250V		WLRS 6 20	WLRs1
For Locking Blade Plugs				
2-Pole 3-Wire Grounding 15 Amp	125V		WLRS L5 15	WLRs1
	250V		WLRS L6 15	WLRs1
2-Pole 3-Wire Grounding 20 Amp	125V		WLRS L5 20	WLRs2
	250V		WLRS L6 20	WLRs2

Duplex Device

Type	Volts	NEMA Configuration	Complete Cover with Receptacle Assy. Cat. #	Spring Door Cover & Gasket Only Cat. #‡
For Non-locking Blade Plugs				
2-Pole 3-Wire Grounding 15 Amp	125V		WLRD 5 15	WLRD1
	250V		WLRD 6 15	WLRD1
2-Pole 3-Wire Grounding 20 Amp	125V		WLRD 5 20	WLRD1
	250V		WLRD 6 20	WLRD1
For Locking Blade Plugs				
2-Pole 3-Wire Grounding 15 Amp	125V		WLRD L5 15	WLRD1

Wet Location Covers for GFCI Duplex Receptacles:



WLGF - horizontal mount for flush device boxes.

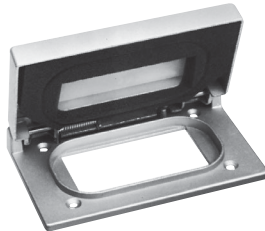

WLGf FS - horizontal mount for FS and FD device boxes.



WLGf FSV - vertical mount for FS and FD device boxes.

Dimensions In Inches:

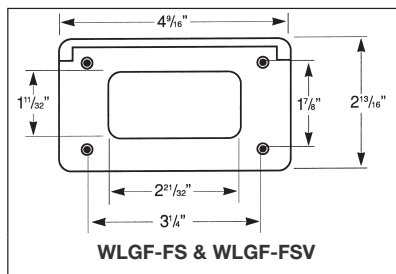
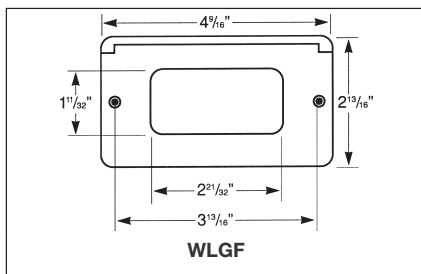

‡ Must be used with a wet locations rated wiring device.