

Steel Plugmold Raceway & Multioutlet Assemblies

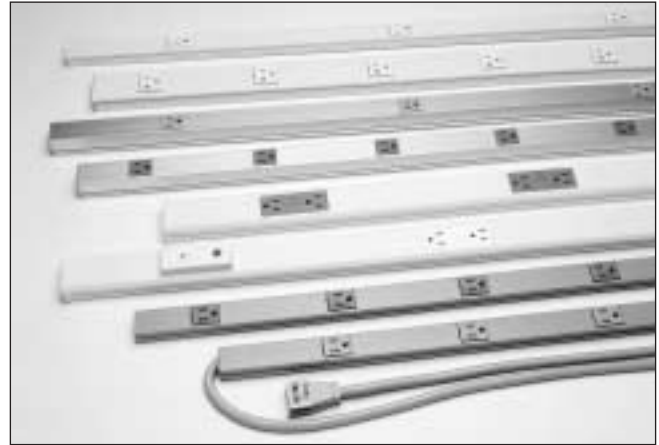

The selection of lengths and fittings in a variety of finishes provides a versatile solution for many applications. Plugmold sections offer single or alternating circuits, standard, or isolated ground receptacles, Snapicoil® harnesses of prewired receptacles, and cord ended units.

Steel Plugmold comes in black or ivory ScuffCoat™ finish and white or gray enamel finish. The ScuffCoat finish is scratch resistant and protects against nicks and chips while preventing color from fading. The enamel finishes are neutral colors that work with many decors or can be painted to integrate with most color schemes. Select Plugmold sections and fittings are now available in a durable stainless steel.



Plugmold Systems come in a variety of finishes and configurations.

Features & Benefits

- **Steel construction.** Provides superior strength and durability for any dry location installation.
- **Many finishes.** Black or ivory ScuffCoat finish, white or gray enamel and select sections and fittings in stainless steel.
- **Compact, low profile appearance.** Requires minimal space.
- **Full range of fittings.** Provides a complete wiring solution.
- **Single, alternating circuit, and isolated ground receptacles available.** Meets virtually any job requirement.
- **Variety of lengths.** Ideal for different spaces.
- **Choose receptacle spacing.** Suits many applications.
- **Snapicoil harnesses with different lengths and receptacle spacing.** Offers a solution for many electrical requirements.
- **Duplex receptacle.** Aesthetically pleasing, functional 20A duplex for the 24S (2400) Series.
- **Single- and dual-gang boxes available.** Wire devices into the raceway system.
- **Customization available.** All products can be modified to accommodate virtually any application.
- **cULus Listed.** Safety and reliability in the applications.

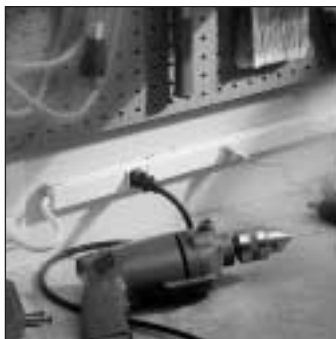

Plugmold Systems shown in typical applications.

Plugmold 2000 System Layout

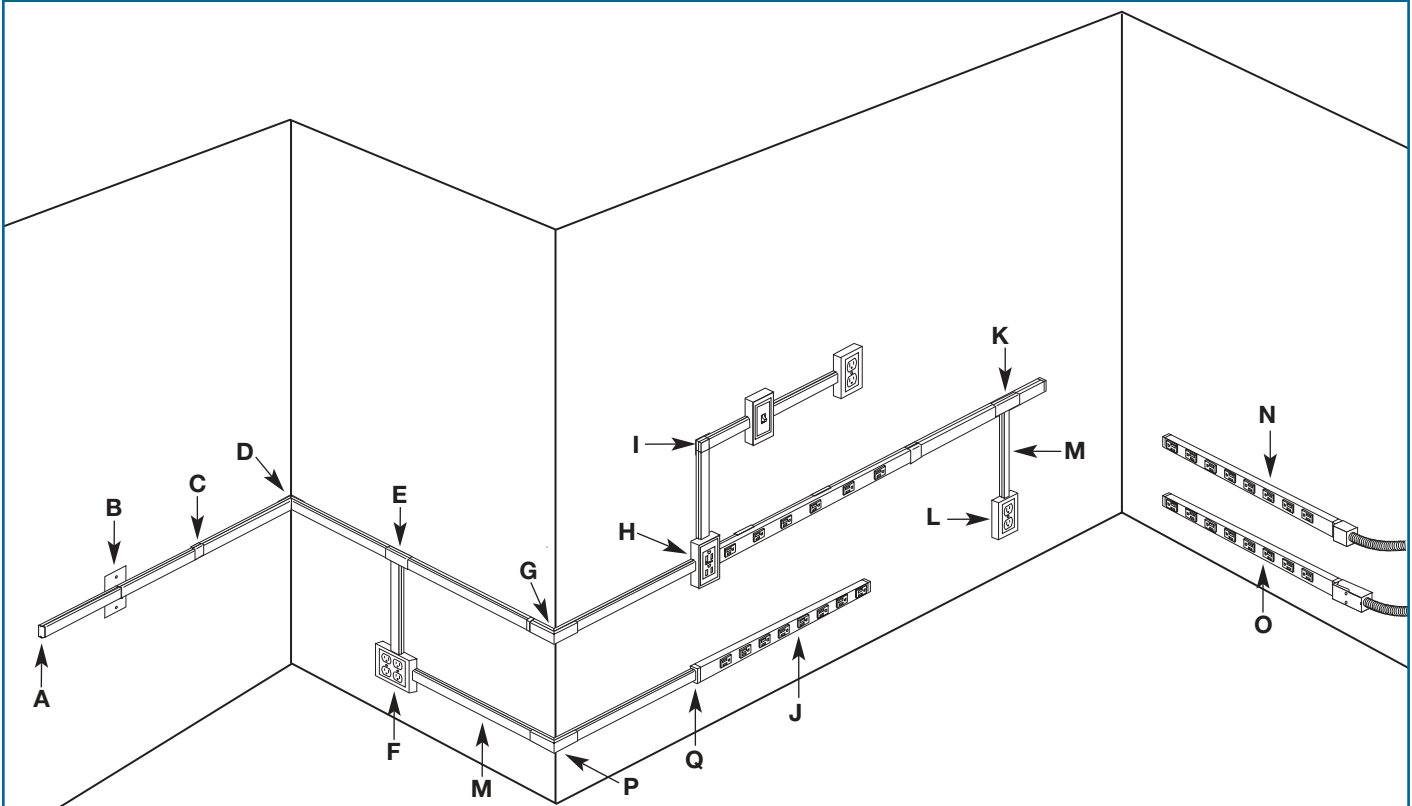

- A — 2010B Blank End Fitting
- B — 2051H Flush Plate Adapter
- C — 2006 Cover Clip
- D — 2017TC Internal Corner Coupling
- E — 2015 Tee Fitting
- F — 2048-2 Two-Gang Device Box
- G — 2018C External Elbow Cover
- H — 2048 Single-Gang Device Box
- I — 2011 90° Flat Elbow

- J — 20GB506 Plugmold Strip
- K — 2089A Side-Reducing Fitting
- L — 5748 Single-Gang Device Box
- M — 500 Raceway
- N — 2010A2 Entrance End Fitting
- O — 2010A3 Entrance End Fitting
- P — 518 External Elbow
- Q — 2089E End-Reducing Connector



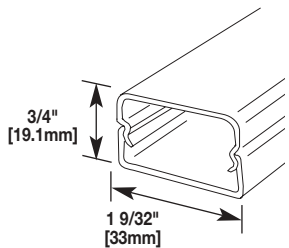
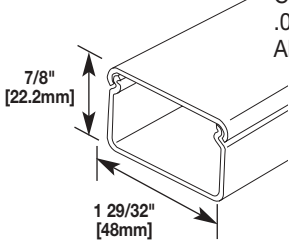

NOTE: Illustration is for showing product applications only.

Cross Section

| Catalog No./Item | Description/Specifications | Catalog No./Item | Description/Specifications |
|-------------------------------------------------------------------------------------|---------------------------------------------------------------------------------------------------|--------------------------------------------------------------------------------------|--------------------------------------------------------------------------------------------------------------------------------------------------------------------|
| 2000* | Base and Cover – Base – 2000B .040" [1.0mm] steel. Cover – 2000C .025" [.6mm] steel. | G2400 V2400 | Base and Cover – Base – G2400B or V2400B .040" [1.0mm] steel. Cover – G2400C or V2400C .040" [1.0mm] steel. Also available in custom colors. |
|  | Cross-Sectional Area: 0.80in ² [516mm ²] |  | Cross-Sectional Area: 1.39in ² [897mm ²] |

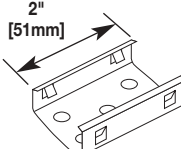
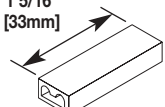
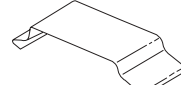
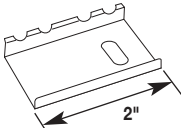
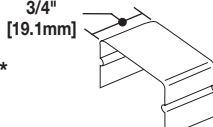
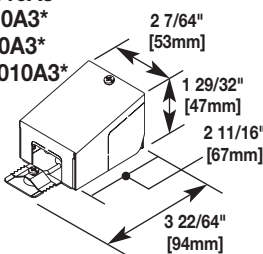
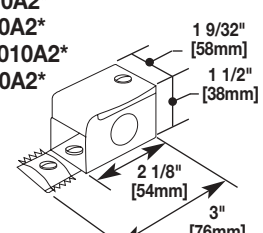
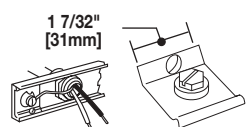
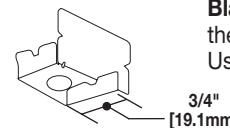
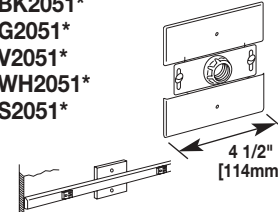
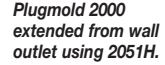
* Use "V" prefix for Ivory ScuffCoat™ finish, "G" prefix for Gray enamel finish, "BK" for Black ScuffCoat™ finish, "WH" for white enamel finish, and "S" for stainless steel.

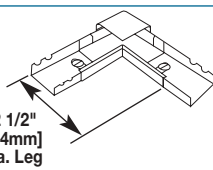
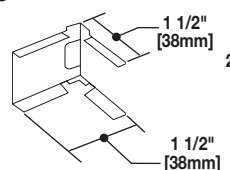
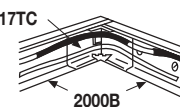
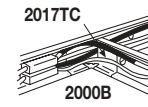
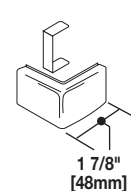
V/G 2000 Series

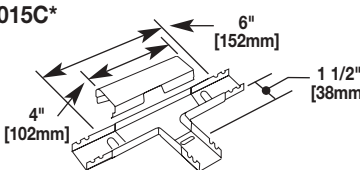
| Catalog No./Item | Description/Specifications | | | | | | | | | | | | | | | | |
|-----------------------------------------------------------------------------------------------------------------------------------------------------------------------------------------------------------------------------------------------------------------------------------------------------------------------------------------------------------------------------------------------------------------------------------------------------------------------|---------------------------------------------------------------------------------------------------------------------------------------------------------------------------------------------------------------------------------------------------------|-----------|------------|----------|------|--------------|-----------|------------|-------|------------|-----------|------------|--------------|-------------|-----------|------------|--|
| Base and Cover | | | | | | | | | | | | | | | | | |
| <table border="1" style="width: 100%; border-collapse: collapse;"> <thead> <tr> <th>ITEM</th> <th>CAT NO.</th> <th>LENGTH</th> <th>MATERIAL</th> </tr> </thead> <tbody> <tr> <td>Base</td> <td>V/G 2000B-5*</td> <td>5' [1.5m]</td> <td>.040 Steel</td> </tr> <tr> <td>Cover</td> <td>V/G 2000C*</td> <td>5' [1.5m]</td> <td>.025 Steel</td> </tr> <tr> <td>Base & Cover</td> <td>V/G 2000BC*</td> <td>5' [1.5m]</td> <td>.025 Steel</td> </tr> </tbody> </table> | ITEM | CAT NO. | LENGTH | MATERIAL | Base | V/G 2000B-5* | 5' [1.5m] | .040 Steel | Cover | V/G 2000C* | 5' [1.5m] | .025 Steel | Base & Cover | V/G 2000BC* | 5' [1.5m] | .025 Steel | |
| ITEM | CAT NO. | LENGTH | MATERIAL | | | | | | | | | | | | | | |
| Base | V/G 2000B-5* | 5' [1.5m] | .040 Steel | | | | | | | | | | | | | | |
| Cover | V/G 2000C* | 5' [1.5m] | .025 Steel | | | | | | | | | | | | | | |
| Base & Cover | V/G 2000BC* | 5' [1.5m] | .025 Steel | | | | | | | | | | | | | | |
| V2003 2003  | Supporting Clip – For temporary support, while positioning lengths of raceway base. Use with V/G 2000 Series. V2003 has ivory finish, 2003 has plated finish. | | | | | | | | | | | | | | | | |
| W30  | Pressure-Type Wire Connector – For common connection of two, three, or four No. 12 or No.14 solid copper conductors. Not for connection of equipment grounding conductor. 300V maximum; 20A 60° C maximum. Not for use with aluminum conductors. | | | | | | | | | | | | | | | | |
| 2000WC  | Wire Clip – Holds conductors in place in raceway. | | | | | | | | | | | | | | | | |
| 2001  | Coupling – For joining lengths of 2000 Series Raceway Base. | | | | | | | | | | | | | | | | |
| BK2006* G2006* V2006* WH2006* S2006*  | Cover Clip – For covering joint where lengths of cover or base adjoin. Use with V/G 2000 Series. | | | | | | | | | | | | | | | | |
| BK2010A3* G2010A3* V2010A3* WH2010A3*  | Entrance End – Offers larger capacity than V2010A2. 1/2" trade size KOs on end, each side and bottom. 3/4" trade size KOs on bottom and rear. Includes ground screw. Use with V/G 2000 Series. | | | | | | | | | | | | | | | | |
| BK2010A2* G2010A2* V2010A2* WH2010A2* S2010A2*  | Entrance End – For connecting V2000 with 1/2" conduit and armored cable connectors. 1/2" trade size KOs on end, each side and bottom. Includes ground screw. Use with V/G 2000 Series. | | | | | | | | | | | | | | | | |
| 2009  | Ground Clamp – For connection of equipment grounding conductor to provide additional ground to raceway. Use with V/G2000 Series. | | | | | | | | | | | | | | | | |
| BK2010B* G2010B* V2010B* WH2010B* S2010B*  | Blank End Fitting – For closing the open end of raceway. Use with V/G 2000 Series. | | | | | | | | | | | | | | | | |
| BK2051* G2051* V2051* WH2051* S2051*  | Flush Plate Adapter – For feeding 2000 from an existing wall outlet. Equipped with 1/2" [12.7mm] threaded stud, toothed lockwasher for grounding, and conduit bushing. | | | | | | | | | | | | | | | | |
|  <i>Plugmold 2000 extended from wall outlet using 2051H.</i> |  <i>2051H fastened to horizontally mounted wall box.</i> | | | | | | | | | | | | | | | | |
|  <i>2051H fastened to vertically mounted wall box.</i> | | | | | | | | | | | | | | | | | |
| BK2011* G2011* V2011* WH2011* S2011*  | 90° Flat Elbow – For right angle turns on same surface. Cover stop permits neat butting of 2000C Cover. Two couplings furnished. | | | | | | | | | | | | | | | | |
| 2017TC  | Internal Corner Coupling – Furnished with one fiber bushing. | | | | | | | | | | | | | | | | |
|  <i>2017TC used as a corner coupling.</i> | | | | | | | | | | | | | | | | | |
|  <i>2017TC used as a corner coupling and a straight-through fitting.</i> | | | | | | | | | | | | | | | | | |
| BK2018C* G2018C* V2018C* WH2018C* S2018C*  | External Elbow – To continue raceway runs around outside corner. Fills the gap when external corner is made by notching and bending the 2000 Base. | | | | | | | | | | | | | | | | |
|  <i>Cover gap filler snapped into place in 2018C.</i> | | | | | | | | | | | | | | | | | |
| BK2015* G2015* V2015* WH2015* S2015*  | Tee – For branches at right angles. Couplings furnished. | | | | | | | | | | | | | | | | |

* Use "V" prefix for Ivory ScuffCoat™ finish, "G" prefix for Gray enamel finish, "BK" for Black ScuffCoat™ finish, "WH" for white enamel finish, and "S" for stainless steel.

V/G 2000 Series (continued)

| Catalog No./Item | Description/Specifications |
|-------------------------------------------------------------------------------------|-------------------------------------------------------------------------------------------------------------------------------------------------------------------------------------------------------------------|
| BK2048* G2048* V2048* WH2048* S2048* | Single Gang Device Box – Cover has twistouts for 2000, V500, and V700 Raceway. Base has 1/2" trade KO and rectangular KO for extension to wall box. Base has #10 threaded hole for ground connection. |
| | |
| V2048-2 | Two-Gang Device Box – Cover has G2048-2 Twistouts for 2000, V500, and V700 Raceway. Base has 1/2" trade KO and rectangular KO for extension to wall box. Base has #10 threaded hole for ground connection. |
| | |
| V2089 | Side Reducing Connector – For connecting V2000 with V500 Raceway through side of V2000. |
| | |

| Catalog No./Item | Description/Specifications |
|------------------|---------------------------------------------------------------------------------------------------------------------------------------------------------------------------------|
| V2089E | End Reducing Connector – For connecting V2000 with V500 Raceway through end of V2000. |
| | |
| 620 | 2000 Raceway Base and Cover Cutter – Portable cutter for 2000 Cover and Base. Tool steel construction for clean and easy square cuts every time. Total manual operation. |
| | |
| 620BCK | Replacement Blade Kit – Replacement blades and die set for 620 Cutter. |

* Use "V" prefix for Ivory ScuffCoat™ finish, "G" prefix for Gray enamel finish, "BK" for Black ScuffCoat™ finish, "WH" for white enamel finish, and "S" for stainless steel.

V2400 Series

| Catalog No./Item | Description/Specifications | | | | | | | | | | | | | | | | |
|-----------------------|---------------------------------------------------------------------------------------------------------------------------------------------------------------------------------------------------------------------------------------------------------------------------------------------------------------------------------------------------------------------------------------------------------------------------------------------------------|-----------|------------|--------|----------|------|--------|-----------|------------|-------|--------|-----------|------------|--------------|---------|-----------|------------|
| Base and Cover | | | | | | | | | | | | | | | | | |
| | <table border="1" style="width: 100%; border-collapse: collapse;"> <thead> <tr> <th>ITEM</th> <th>CAT NO.</th> <th>LENGTH</th> <th>MATERIAL</th> </tr> </thead> <tbody> <tr> <td>Base</td> <td>V2400B</td> <td>5' [1.5m]</td> <td>.040 Steel</td> </tr> <tr> <td>Cover</td> <td>V2400C</td> <td>5' [1.5m]</td> <td>.040 Steel</td> </tr> <tr> <td>Base & Cover</td> <td>V2400BC</td> <td>5' [1.5m]</td> <td>.040 Steel</td> </tr> </tbody> </table> | ITEM | CAT NO. | LENGTH | MATERIAL | Base | V2400B | 5' [1.5m] | .040 Steel | Cover | V2400C | 5' [1.5m] | .040 Steel | Base & Cover | V2400BC | 5' [1.5m] | .040 Steel |
| ITEM | CAT NO. | LENGTH | MATERIAL | | | | | | | | | | | | | | |
| Base | V2400B | 5' [1.5m] | .040 Steel | | | | | | | | | | | | | | |
| Cover | V2400C | 5' [1.5m] | .040 Steel | | | | | | | | | | | | | | |
| Base & Cover | V2400BC | 5' [1.5m] | .040 Steel | | | | | | | | | | | | | | |
| 2401 | Coupling – For joining lengths of raceway. Use with V2400 Series. | | | | | | | | | | | | | | | | |
| | | | | | | | | | | | | | | | | | |
| 2400WC | Wire Clip – Holds conductors in place in raceway. | | | | | | | | | | | | | | | | |
| | | | | | | | | | | | | | | | | | |
| V2406 | Cover Clip – For covering joint where lengths of cover or base adjoin. Use with V2400 Series (nonmetallic). | | | | | | | | | | | | | | | | |
| | | | | | | | | | | | | | | | | | |

| Catalog No./Item | Description/Specifications |
|------------------|---------------------------------------------------------------------------------------------------------------------------|
| 2409 | Ground Clamp – No. 10 ground screw provided. Use with V2400 Series. |
| | |
| V2410A | Entrance End – For connecting V2400 with 1/2" trade size conduit and armored cable. Use with V2400 Series. |
| | |
| V2410B | Blank End – For closing open end of V2400 Series. |
| | |
| V2410C | Entrance End Fitting – Has 1/2" and 3/4" trade size KOs on end and bottom. Additional 1/2" trade size KO on sides. |
| | |

NEW!

V2400 Series (continued)

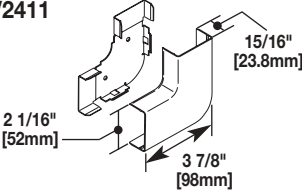
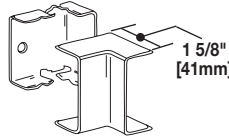
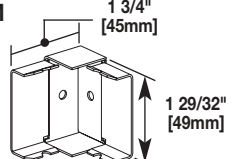
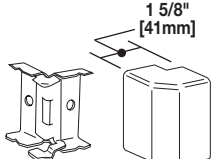
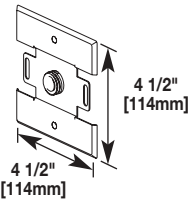
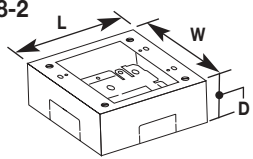
| Catalog No./Item | Description/Specifications |
|-----------------------------------------------------------------------------------------------------------------------|--------------------------------------------------------------------------------------------------------------------------------------------------------------------------------------------------------------|
| V2411  | 90° Flat Elbow – For right angle turns on the same surface (nonmetallic cover). Dimensions: 15/16" [23.8mm], 3 7/8" [98mm], 2 1/16" [52mm] |
| V2417  | Internal Elbow – For making internal corners (nonmetallic cover). Dimension: 1 5/8" [41mm] |
| V2417M  | Internal Elbow – For making internal 90° corners. All steel construction. Dimensions: 1 3/4" [45mm], 1 29/32" [49mm] |
| V2418  | External Elbow – For covering outside corners (nonmetallic cover). Dimension: 1 5/8" [41mm] |
| V2451H  | Back Feed Fitting – For feeding V2400 Raceway from an existing outlet box. Equipped with 1/2" trade size male bushing and locknut washer for grounding. Dimensions: 4 1/2" [114mm], 4 1/2" [114mm] |
| V2448 V2448-2  | Device Box – Cover has one twistout for 2400 on each side and ends. Base has 1/2" trade KO and rectangular KO for extension to wall box. Base has #10 threaded hole for ground connection. |

| CAT NO. | L | W | D | GANG # |
|---------|----------------|----------------|---------------|--------|
| V2448 | 4 5/8" [117mm] | 2 7/8" [73mm] | 1 3/4" [44mm] | 1 |
| V2448-2 | 4 3/4" [121mm] | 4 3/4" [121mm] | 1 3/4" [44mm] | 2 |

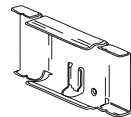
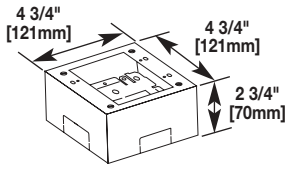
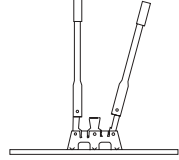
| Catalog No./Item | Description/Specifications | | | | | | | | | | | | | | | |
|----------------------------------------------------------------------------------------------------------------------|---------------------------------------------------------------------------------------------------------------------------------------------------------------------------------------------------------------------------------------------------------------------------------------------------------------------------------------------------------------------------------------------------------------------|----------------|---------------|--------|---|--------|-------|----------------|---------------|---------------|---|---------|----------------|----------------|---------------|---|
| V2489  | Side Reducing Connector – For connecting V2400 with V500 Raceway. | | | | | | | | | | | | | | | |
| V2444 V2444-2  | Extra Deep Device Box – Base has rectangular knockout to enable extension from existing single-gang flush wall box and 1/2" and 1" concentric KOs. V2444 Cover has two twistouts for 500 and 700, and two twistouts for 2400. V2444-2 Cover has four 2400 Series twistouts. | | | | | | | | | | | | | | | |
| | <table border="1" style="width: 100%; border-collapse: collapse;"> <thead> <tr> <th>CAT NO.</th> <th>L</th> <th>W</th> <th>D</th> <th>GANG #</th> </tr> </thead> <tbody> <tr> <td>V2444</td> <td>4 5/8" [117mm]</td> <td>2 7/8" [73mm]</td> <td>1 3/4" [44mm]</td> <td>1</td> </tr> <tr> <td>V2444-2</td> <td>4 3/4" [121mm]</td> <td>4 3/4" [121mm]</td> <td>1 3/4" [44mm]</td> <td>2</td> </tr> </tbody> </table> | CAT NO. | L | W | D | GANG # | V2444 | 4 5/8" [117mm] | 2 7/8" [73mm] | 1 3/4" [44mm] | 1 | V2444-2 | 4 3/4" [121mm] | 4 3/4" [121mm] | 1 3/4" [44mm] | 2 |
| CAT NO. | L | W | D | GANG # | | | | | | | | | | | | |
| V2444 | 4 5/8" [117mm] | 2 7/8" [73mm] | 1 3/4" [44mm] | 1 | | | | | | | | | | | | |
| V2444-2 | 4 3/4" [121mm] | 4 3/4" [121mm] | 1 3/4" [44mm] | 2 | | | | | | | | | | | | |
| 624  | 2400 and 2400BD Raceway & Cover Cutter – Portable cutter for 2400B and 2400BD Raceway and Cover. Tool steel construction for clean and easy square cuts. Total manual operation. | | | | | | | | | | | | | | | |
| 624BCK | Replacement Blade Kit – Replacement blades and die set for 624 Cutter. | | | | | | | | | | | | | | | |

Plugmold with Snapicoil Harness

| CATALOG NO. | LENGTH | | WIRING CONFIG | OUTLETS (15A 120V NEMA 5-15SR) | | HOLE CUT COVER | | HOUSING | | |
|-------------|--------|----------|---------------|--------------------------------|------------------|----------------|------------------|---------|--------|---------------------|
| | Feet | [meters] | | CENTER DISTANCE Inches | QUANTITY [mm] | QUANTITY | LENGTH Inches | | [mm] | |
| 20GB12 | 48' | [14.63] | GB | 12" | [305mm] | 48 Single | 8 | 6' | [1.8m] | Steel – Ivory, Gray |
| 20GB18 | 48' | [14.63] | GB | 18" | [457mm] | 32 Single | 8 | 6' | [1.8m] | Steel – Ivory, Gray |
| V20GB30 | 50' | [15.25] | GB | 30" | [760mm] | 20 Single | 10 | 5' | [1.5m] | Steel – Ivory |
| 20GBA12 | 48' | [15.24] | GBA | 12" | [305mm] | 48 Single | 8 | 6' | [1.8m] | Steel – Ivory, Gray |

Cord-Ended Plugmold Series

| CAT NO. | UNIT LENGTH | OUTLETS QUANTITY | CORD SET LENGTH | TYPE | SWITCH | CIRCUIT BREAKER | FINISH |
|---------|-------------|------------------|-----------------|----------|--------|-----------------|---------------------|
| 20-C2 | 3' 4" [1m] | 6 Single | 6' [1.8m] | 12/3 SJT | No | Yes | Steel – Gray, Ivory |

Plugmold Wire Fill Capacities for Power

| CABLE TYPE | WIRE SIZE THHN/THWN | O.D. | | NO. OF CONDUCTORS (40% FILL) | |
|--------------------------------------------|------------------------|--------|-------|---------------------------------|-------|
| | | Inches | [mm] | V2000 | V2400 |
| POWER WIRING WITHOUT DEVICES | 8 AWG | 0.216 | [5.5] | – | – |
| | 10 AWG | 0.166 | [4.2] | – | 26 |
| | 12 AWG | 0.130 | [3.3] | 7* | 41 |
| | 14 AWG | 0.111 | [2.8] | 7* | 57 |
| POWER WIRING WITH DEVICES (PLUGMOLD) | 8 AWG | 0.218 | [5.5] | – | 2 |
| | 10 AWG | 0.153 | [3.9] | – | 6 |
| | 12 AWG | 0.122 | [3.1] | 5* | 10 |
| | 14 AWG | 0.105 | [2.7] | 5* | – |

*Wire capacity limited to maximum of seven conductors due to .025" [.6mm] material thickness of cover.

**Including one hot, neutral, and ground wire from the receptacle.

Wiring Configuration

| | | | With Snapicoil | |
|----------------------------------------------------------------------------------------------------------------------|--------------------------------------------------------------------------------------------------------------------------------------------------|---------------------------------------------------------------------------------------------------------------------------------------------------|----------------------------------------------------------------------------------------------------------------------|--------------------------------------------------------------------------------------------------------------------------------------------------|
| | | | | |
| GB Series: 3-wire, #12 THHN (1 hot, 1 neutral and 1 ground), 1 circuit; has insulated grounding conductor. | GBA Series: 4-wire, #12 THHN (2 hot, 1 neutral and 1 ground), 2 circuit; outlets wired alternately; has insulated grounding conductor. | IG Series: 3-wire, #12 THHN (1 hot, 1 neutral and 1 ground), 1 circuit; has insulated-isolated grounding conductor. Orange receptacles. | GB Series: 3-wire, #12 THHN (1 hot, 1 neutral and 1 ground), 1 circuit; has insulated grounding conductor. | GBA Series: 4-wire, #12 THHN (2 hot, 1 neutral and 1 ground), 2 circuit; outlets wired alternately; has insulated grounding conductor. |

NOTE: SNAPICOIL REELS on custom order. Snapicoil is available on reels if lengths greater than 50' are needed, or if multiple lengths are required for production-type jobs. The maximum length per reel is 240' for Snapicoil with outlets 12" and 18" on centers; 500' with outlets 30" on center. Packaging includes the necessary number of lengths of base, holecut cover, wire clips, and couplings for complete installation. Price and delivery information should be obtained prior to specifying or ordering. To specify or order, add R to the Snapicoil number. Ex: V20GB12R. **Other outlet spacings available on custom order.**

Receptacles are made from high impact thermoplastic. V2000 Plugmold is supplied with two (2) V2010B Blank End Fittings and (1) 2001 Base Coupling. NM2000 Plugmold strips are supplied with two (2) NM2010B Blank End Fittings.

Plugmold Multi Outlet Strip

| CATALOG NO. | LENGTH | | WIRING CONFIG | OUTLETS | | FINISH |
|----------------|--------|---------|---------------|------------------------|---------|---------------------------------------|
| | Feet | [mm] | | CENTER DISTANCE Inches | [mm] | |
| 20GB206 | 2' | [610mm] | GB | 6" | [152mm] | 4 Single 15A Steel - S |
| 20GB306 | 3' | [915mm] | GB | 6" | [152mm] | 6 Single 15A Steel - WH, BK, V, G, S |
| V24GB306 | 3' | [915mm] | GB | 6" | [152mm] | 6 Single 20A Steel - V |
| 24S3612GBX99IV | 3' | [915mm] | GB | 12" | [305mm] | 3 Duplex 20A Steel - V, G |
| 24S3612GBA99IV | 3' | [915mm] | GBA | 12" | [305mm] | 3 Duplex 20A Steel - V, G |
| 20GB506 | 5' | [1.5m] | GB | 6" | [152mm] | 10 Single 15A Steel - WH, BK, V, G, S |
| V24GB506 | 5' | [1.5m] | GB | 6" | [152mm] | 10 Single 20A Steel - WH, BK, V, G, S |
| 20GB512 | 5' | [1.5m] | GB | 12" | [305mm] | 5 Single 15A Steel - WH, BK, V, G, S |
| V24GB512 | 5' | [1.5m] | GB | 12" | [305mm] | 5 Single 20A Steel - V |
| 20IG512 | 5' | [1.5m] | IG | 12" | [305mm] | 5 Single 15A Steel - V, G |
| 20GBA512 | 5' | [1.5m] | GBA | 12" | [305mm] | 5 Single 15A Steel - V, G |
| V24GBA512 | 5' | [1.5m] | GBA | 12" | [305mm] | 5 Single 20A Steel - V |
| 24S6012GBX99IV | 5' | [1.5m] | GB | 12" | [305mm] | 5 Duplex 20A Steel - V, G |
| 24S6012GBA99IV | 5' | [1.5m] | GBA | 12" | [305mm] | 5 Duplex 20A Steel - V, G |
| 24S6012IGX99IV | 5' | [1.5m] | IG | 12" | [305mm] | 5 Duplex 20A Steel - V, G |
| 20GB606 | 6 | [1.8m] | GB | 6" | [152mm] | 12 Single 15A Steel - WH, BK, V, G, S |
| V24GB606 | 6 | [1.8m] | GB | 6" | [152mm] | 12 Single 20A Steel - V |
| 20IG606 | 6 | [1.8m] | IG | 6" | [152mm] | 12 Single 15A Steel - V, G |
| 20GB609 | 6 | [1.8m] | GB | 9" | [229mm] | 8 Single 15A Steel - V, G |
| 20GBA609 | 6 | [1.8m] | GBA | 9" | [229mm] | 8 Single 15A Steel - V, G |
| 20GB612 | 6' | [1.8m] | GB | 12" | [305mm] | 6 Single 15A Steel - WH, BK, V, G, S |
| 20GBA612 | 6 | [1.8m] | GBA | 12" | [305mm] | 6 Single 15A Steel - V, G |
| V24GB612 | 6' | [1.8m] | GB | 12" | [305mm] | 6 Single 20A Steel - V |
| V24GBA612 | 6' | [1.8m] | GBA | 12" | [305mm] | 6 Single 20A Steel - V |
| V24GB618 | 6' | [1.8m] | GB | 12" | [305mm] | 6 Single 20A Steel - V |
| 20GB618 | 6 | [1.8m] | GB | 18" | [457mm] | 4 Single 15A Steel - V, G |
| 20GBA618 | 6 | [1.8m] | GBA | 18" | [457mm] | 4 Single 15A Steel - V, G |
| V24GBA618 | 6' | [1.8m] | GBA | 18" | [457mm] | 4 Single 20A Steel - V |
| 24S7212GBX99IV | 6 | [1.8m] | GB | 12" | [305mm] | 6 Duplex 20A Steel - V, G |
| 24S7224GBA99IV | 6 | [1.8m] | GBA | 24" | [608mm] | 3 Duplex 20A Steel - V, G |
| 24S7218GBX99IV | 6 | [1.8m] | GB | 18" | [457mm] | 4 Duplex 20A Steel - V, G |
| 24S7224GBX99IV | 6 | [1.8m] | GB | 24" | [608mm] | 5 Duplex 20A Steel - V, G |
| 24S7218IGX99IV | 6 | [1.8m] | IG | 18" | [457mm] | 5 Duplex 20A Steel - V, G |
| 24S7212IGX99IV | 6 | [1.8m] | IG | 12" | [305mm] | 6 Duplex 20A Steel - V, G |
| 24S7224IGX99IV | 6 | [1.8m] | IG | 24" | [608mm] | 3 Duplex 20A Steel - V, G |
| 24S7212GBA99IV | 6 | [1.8m] | GBA | 12" | [305mm] | 6 Duplex 20A Steel - V, G |
| 24S7218GBA99IV | 6' | [1.8m] | GBA | 18" | [457mm] | 4 Duplex 20A Steel - V, G |

NOTE: "V" indicates Ivory ScuffCoat™ finish, "G" indicates Gray ScuffCoat™ finish, "WH" indicates White enamel finish, "BK" indicates Black enamel finish, and "S" indicates Stainless Steel finish.

Datacom Connectivity Options

Now you have a wide range of options for providing datacom connectivity into Wiremold® Cable Management Systems. They are:

- Ortronics® TracJack® and Series II Modular Connectivity Solutions
- Pass & Seymour Activate™ Modular Inserts
- Open System Communication Modules

| | | |
|------|------|------|
| ORT | ORT | ORT |
| P&S | P&S | P&S |
| OPEN | OPEN | OPEN |

Use these icons to determine connectivity options for each Wiremold System component:

| |
|------|
| ORT |
| P&S |
| OPEN |

Ortronics® Connectivity

TracJack® Individual Jack System

- Front-loading, snap-in design supports future moves adds and changes
- Inserts for voice, data, audio, and video
- Available Category 3, 5e, 6, USOC 6-position, and other media
- Flat or angled 45° exit configurations
- Choice of 13 colors and color matched to Wiremold Systems
- Universal T568A/B wiring format



Series II Front-Loading, Module System

- Module design features easy snap-in front-loading design
- Linear 110 punch down format for easy termination
- Inserts for voice, data, audio, and video
- Available Category 3, 5e, 6, USOC 6-position, and other media
- Available in flat or angled 45° exit configurations
- Color matched to Wiremold Systems



For detailed product selection refer to the Ortronics Catalog or visit www.ortronics.com.

| |
|------|
| ORT |
| P&S |
| OPEN |

Pass & Seymour Legrand Network Wiring

Activate™ Series Front-Loading Inserts

- Modular inserts for voice, data, audio and video applications
- Front-load, snap-in design
- Color and texture matched to Wiremold Systems
- Available Category 3, 5e, 6, as well as 6-position USOC
- Universal T568A/B wiring format



For detailed product selection refer to the Pass & Seymour Network Wiring Catalog or visit www.passandseymour.com.

| |
|------|
| ORT |
| P&S |
| OPEN |

Open Connectivity Solutions

Wiremold Open System Communications Modules

- Accommodate a wide range of manufacturers' communications outlets including keystone jacks, as well as proprietary solutions from Avaya (Systemax) and NORDX
- Modules insert into a wide range of Wiremold Systems
- Pre-punched faceplates accept common communication devices



NOTE: For more information on integrating connectivity into Wiremold Cable Management Systems contact the Wiremold Applications Engineering Team or your local Wiremold Sales Representative.

WIREMOLD



Wiremold / Legrand

U.S. and International:

60 Woodlawn Street • West Hartford, CT 06110

1-800-621-0049 • FAX 860-232-2062 • Outside U.S. 860-233-6251

Canada:

570 Applewood Crescent • Vaughan, Ontario L4K 4B4

1-800-723-5175 • FAX 905-738-9721

ED1412 – May 2006 – For latest specs visit www.wiremold.com



Steel Plugmold Raceway & Multioutlet Assemblies



The selection of lengths and fittings in a variety of finishes provides a versatile solution for many applications. Plugmold sections offer single or alternating circuits, standard, or isolated ground receptacles, Snapicoil® harnesses of prewired receptacles, and cord ended units.

Steel Plugmold comes in black or ivory ScuffCoat™ finish and white or gray enamel finish. The ScuffCoat finish is scratch resistant and protects against nicks and chips while preventing color from fading. The enamel finishes are neutral colors that work with many decors or can be painted to integrate with most color schemes. Select Plugmold sections and fittings are now available in a durable stainless steel.

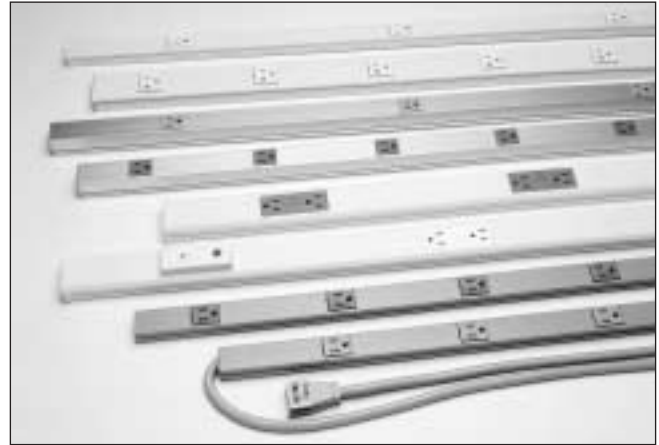

Plugmold Systems come in a variety of finishes and configurations.

Features & Benefits

- **Steel construction.** Provides superior strength and durability for any dry location installation.
- **Many finishes.** Black or ivory ScuffCoat finish, white or gray enamel and select sections and fittings in stainless steel.
- **Compact, low profile appearance.** Requires minimal space.
- **Full range of fittings.** Provides a complete wiring solution.
- **Single, alternating circuit, and isolated ground receptacles available.** Meets virtually any job requirement.
- **Variety of lengths.** Ideal for different spaces.
- **Choose receptacle spacing.** Suits many applications.
- **Snapicoil harnesses with different lengths and receptacle spacing.** Offers a solution for many electrical requirements.
- **Duplex receptacle.** Aesthetically pleasing, functional 20A duplex for the 24S (2400) Series.
- **Single- and dual-gang boxes available.** Wire devices into the raceway system.
- **Customization available.** All products can be modified to accommodate virtually any application.
- **cULus Listed.** Safety and reliability in the applications.

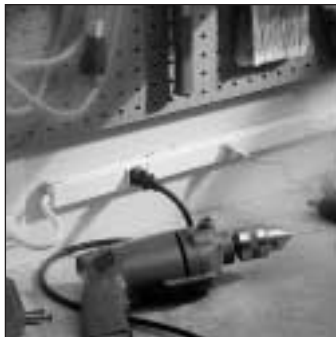

Plugmold Systems shown in typical applications.

Plugmold 2000 System Layout

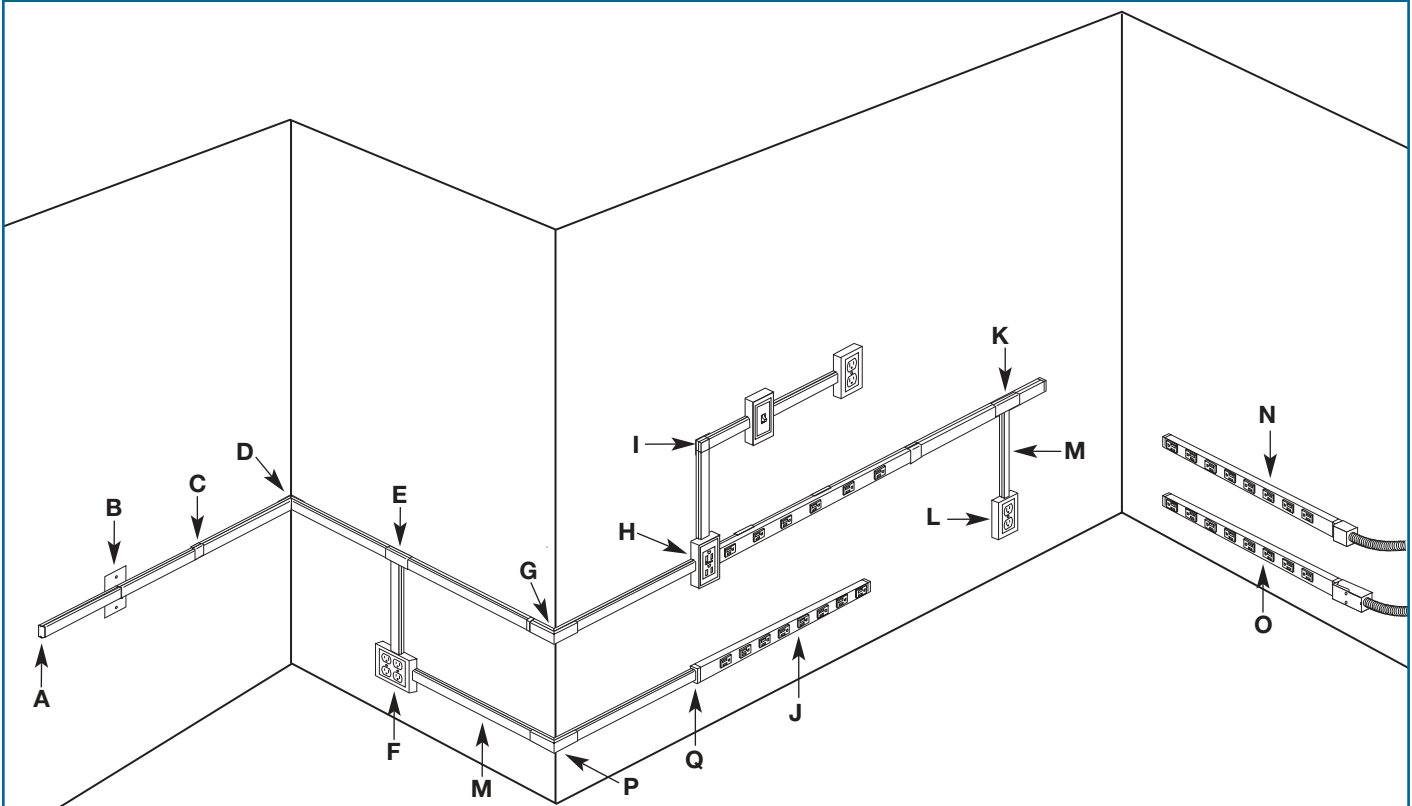

- | | | | |
|------------|--------------------------|-------------|------------------------|
| A — 2010B | Blank End Fitting | J — 20GB506 | Plugmold Strip |
| B — 2051H | Flush Plate Adapter | K — 2089A | Side-Reducing Fitting |
| C — 2006 | Cover Clip | L — 5748 | Single-Gang Device Box |
| D — 2017TC | Internal Corner Coupling | M — 500 | Raceway |
| E — 2015 | Tee Fitting | N — 2010A2 | Entrance End Fitting |
| F — 2048-2 | Two-Gang Device Box | O — 2010A3 | Entrance End Fitting |
| G — 2018C | External Elbow Cover | P — 518 | External Elbow |
| H — 2048 | Single-Gang Device Box | Q — 2089E | End-Reducing Connector |
| I — 2011 | 90° Flat Elbow | | |







NOTE: Illustration is for showing product applications only.

Cross Section

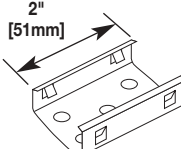
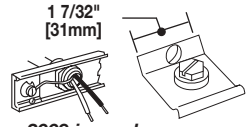
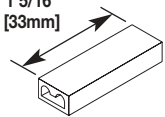
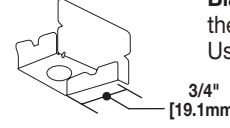
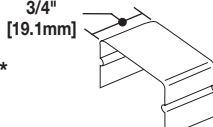
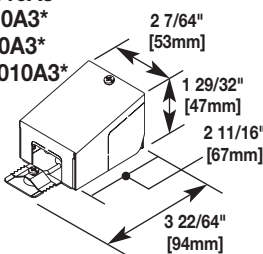
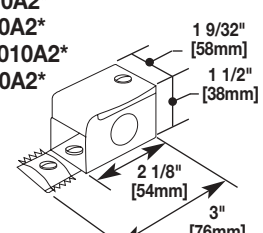
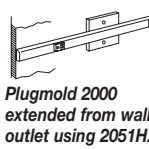
| Catalog No./Item | Description/Specifications | Catalog No./Item | Description/Specifications |
|-----------------------------------------------------------------------------------------------------|-----------------------------------------------------------------------------------------------------|------------------|--------------------------------------------------------------------------------------------------------------------------------------------------------------------|
| 2000* | Base and Cover – Base – 2000B .040" [1.0mm] steel. Cover – 2000C .025" [.6mm] steel. | G2400 V2400 | Base and Cover – Base – G2400B or V2400B .040" [1.0mm] steel. Cover – G2400C or V2400C .040" [1.0mm] steel. Also available in custom colors. |
| <p style="text-align: center;">Cross-Sectional Area: 0.80in² [516mm²]</p> | <p style="text-align: center;">Cross-Sectional Area: 1.39in² [897mm²]</p> | | |

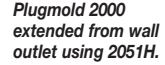
* Use "V" prefix for Ivory ScuffCoat™ finish, "G" prefix for Gray enamel finish, "BK" for Black ScuffCoat™ finish, "WH" for white enamel finish, and "S" for stainless steel.

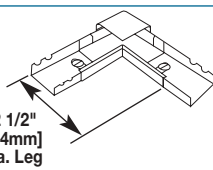
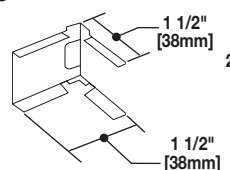
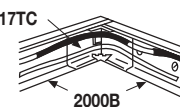
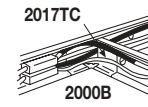
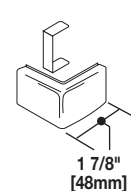
V/G 2000 Series

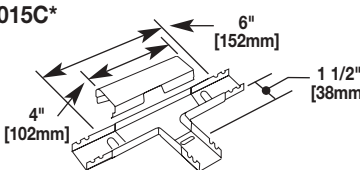
| Catalog No./Item | Description/Specifications | | | | | | | | | | | | | | | | |
|-----------------------------------------------------------------------------------------------------------------------------------------------------------------------------------------------------------------------------------------------------------------------------------------------------------------------------------------------------------------------------------------------------------------------------------------------------------------------|---------------------------------------------------------------------------------------------------------------------------------------------------------------------------------------------------------------------------------------------------------|-----------|------------|----------|------|--------------|-----------|------------|-------|------------|-----------|------------|--------------|-------------|-----------|------------|--|
| Base and Cover | | | | | | | | | | | | | | | | | |
| <table border="1" style="width: 100%; border-collapse: collapse;"> <thead> <tr> <th>ITEM</th> <th>CAT NO.</th> <th>LENGTH</th> <th>MATERIAL</th> </tr> </thead> <tbody> <tr> <td>Base</td> <td>V/G 2000B-5*</td> <td>5' [1.5m]</td> <td>.040 Steel</td> </tr> <tr> <td>Cover</td> <td>V/G 2000C*</td> <td>5' [1.5m]</td> <td>.025 Steel</td> </tr> <tr> <td>Base & Cover</td> <td>V/G 2000BC*</td> <td>5' [1.5m]</td> <td>.025 Steel</td> </tr> </tbody> </table> | ITEM | CAT NO. | LENGTH | MATERIAL | Base | V/G 2000B-5* | 5' [1.5m] | .040 Steel | Cover | V/G 2000C* | 5' [1.5m] | .025 Steel | Base & Cover | V/G 2000BC* | 5' [1.5m] | .025 Steel | |
| ITEM | CAT NO. | LENGTH | MATERIAL | | | | | | | | | | | | | | |
| Base | V/G 2000B-5* | 5' [1.5m] | .040 Steel | | | | | | | | | | | | | | |
| Cover | V/G 2000C* | 5' [1.5m] | .025 Steel | | | | | | | | | | | | | | |
| Base & Cover | V/G 2000BC* | 5' [1.5m] | .025 Steel | | | | | | | | | | | | | | |
| V2003 2003  | Supporting Clip – For temporary support, while positioning lengths of raceway base. Use with V/G 2000 Series. V2003 has ivory finish, 2003 has plated finish. | | | | | | | | | | | | | | | | |
| W30  | Pressure-Type Wire Connector – For common connection of two, three, or four No. 12 or No.14 solid copper conductors. Not for connection of equipment grounding conductor. 300V maximum; 20A 60° C maximum. Not for use with aluminum conductors. | | | | | | | | | | | | | | | | |
| 2000WC  | Wire Clip – Holds conductors in place in raceway. | | | | | | | | | | | | | | | | |
| 2001  | Coupling – For joining lengths of 2000 Series Raceway Base. | | | | | | | | | | | | | | | | |
| BK2006* G2006* V2006* WH2006* S2006*  | Cover Clip – For covering joint where lengths of cover or base adjoin. Use with V/G 2000 Series. | | | | | | | | | | | | | | | | |
| BK2010A3* G2010A3* V2010A3* WH2010A3*  | Entrance End – Offers larger capacity than V2010A2. 1/2" trade size KOs on end, each side and bottom. 3/4" trade size KOs on bottom and rear. Includes ground screw. Use with V/G 2000 Series. | | | | | | | | | | | | | | | | |
| BK2010A2* G2010A2* V2010A2* WH2010A2* S2010A2*  | Entrance End – For connecting V2000 with 1/2" conduit and armored cable connectors. 1/2" trade size KOs on end, each side and bottom. Includes ground screw. Use with V/G 2000 Series. | | | | | | | | | | | | | | | | |
| 2009  | Ground Clamp – For connection of equipment grounding conductor to provide additional ground to raceway. Use with V/G2000 Series. | | | | | | | | | | | | | | | | |
| BK2010B* G2010B* V2010B* WH2010B* S2010B*  | Blank End Fitting – For closing the open end of raceway. Use with V/G 2000 Series. | | | | | | | | | | | | | | | | |
| BK2051* G2051* V2051* WH2051* S2051*  | Flush Plate Adapter – For feeding 2000 from an existing wall outlet. Equipped with 1/2" [12.7mm] threaded stud, toothed lockwasher for grounding, and conduit bushing. | | | | | | | | | | | | | | | | |
|  Plugmold 2000 extended from wall outlet using 2051H. |  2051H fastened to horizontally mounted wall box. | | | | | | | | | | | | | | | | |
|  2051H fastened to vertically mounted wall box. | | | | | | | | | | | | | | | | | |
| BK2011* G2011* V2011* WH2011* S2011*  | 90° Flat Elbow – For right angle turns on same surface. Cover stop permits neat butting of 2000C Cover. Two couplings furnished. | | | | | | | | | | | | | | | | |
| 2017TC  | Internal Corner Coupling – Furnished with one fiber bushing. | | | | | | | | | | | | | | | | |
|  2017TC used as a corner coupling. | | | | | | | | | | | | | | | | | |
|  2017TC used as a corner coupling and a straight-through fitting. | | | | | | | | | | | | | | | | | |
| BK2018C* G2018C* V2018C* WH2018C* S2018C*  | External Elbow – To continue raceway runs around outside corner. Fills the gap when external corner is made by notching and bending the 2000 Base. | | | | | | | | | | | | | | | | |
|  Cover gap filler snapped into place in 2018C. | | | | | | | | | | | | | | | | | |
| BK2015* G2015* V2015* WH2015* S2015*  | Tee – For branches at right angles. Couplings furnished. | | | | | | | | | | | | | | | | |

* Use "V" prefix for Ivory ScuffCoat™ finish, "G" prefix for Gray enamel finish, "BK" for Black ScuffCoat™ finish, "WH" for white enamel finish, and "S" for stainless steel.

V/G 2000 Series (continued)

| Catalog No./Item | Description/Specifications |
|-------------------------------------------------------------------------------------|-------------------------------------------------------------------------------------------------------------------------------------------------------------------------------------------------------------------|
| BK2048* G2048* V2048* WH2048* S2048* | Single Gang Device Box – Cover has twistouts for 2000, V500, and V700 Raceway. Base has 1/2" trade KO and rectangular KO for extension to wall box. Base has #10 threaded hole for ground connection. |
| | |
| V2048-2 | Two-Gang Device Box – Cover has G2048-2 Twistouts for 2000, V500, and V700 Raceway. Base has 1/2" trade KO and rectangular KO for extension to wall box. Base has #10 threaded hole for ground connection. |
| | |
| V2089 | Side Reducing Connector – For connecting V2000 with V500 Raceway through side of V2000. |
| | |

| Catalog No./Item | Description/Specifications |
|------------------|---------------------------------------------------------------------------------------------------------------------------------------------------------------------------------|
| V2089E | End Reducing Connector – For connecting V2000 with V500 Raceway through end of V2000. |
| | |
| 620 | 2000 Raceway Base and Cover Cutter – Portable cutter for 2000 Cover and Base. Tool steel construction for clean and easy square cuts every time. Total manual operation. |
| | |
| 620BCK | Replacement Blade Kit – Replacement blades and die set for 620 Cutter. |

* Use "V" prefix for Ivory ScuffCoat™ finish, "G" prefix for Gray enamel finish, "BK" for Black ScuffCoat™ finish, "WH" for white enamel finish, and "S" for stainless steel.

V2400 Series

| Catalog No./Item | Description/Specifications | | | | | | | | | | | | | | | | |
|-----------------------|---------------------------------------------------------------------------------------------------------------------------------------------------------------------------------------------------------------------------------------------------------------------------------------------------------------------------------------------------------------------------------------------------------------------------------------------------------------------------------------------------------------------------------------------------------|-----------|------------|--------|----------|------|--------|-----------|------------|-------|--------|-----------|------------|--------------|---------|-----------|------------|
| Base and Cover | | | | | | | | | | | | | | | | | |
| | <table border="1" style="width: 100%; border-collapse: collapse; margin: 0 auto;"> <thead> <tr> <th style="width: 15%;">ITEM</th> <th style="width: 15%;">CAT NO.</th> <th style="width: 20%;">LENGTH</th> <th style="width: 50%;">MATERIAL</th> </tr> </thead> <tbody> <tr> <td>Base</td> <td>V2400B</td> <td>5' [1.5m]</td> <td>.040 Steel</td> </tr> <tr> <td>Cover</td> <td>V2400C</td> <td>5' [1.5m]</td> <td>.040 Steel</td> </tr> <tr> <td>Base & Cover</td> <td>V2400BC</td> <td>5' [1.5m]</td> <td>.040 Steel</td> </tr> </tbody> </table> | ITEM | CAT NO. | LENGTH | MATERIAL | Base | V2400B | 5' [1.5m] | .040 Steel | Cover | V2400C | 5' [1.5m] | .040 Steel | Base & Cover | V2400BC | 5' [1.5m] | .040 Steel |
| ITEM | CAT NO. | LENGTH | MATERIAL | | | | | | | | | | | | | | |
| Base | V2400B | 5' [1.5m] | .040 Steel | | | | | | | | | | | | | | |
| Cover | V2400C | 5' [1.5m] | .040 Steel | | | | | | | | | | | | | | |
| Base & Cover | V2400BC | 5' [1.5m] | .040 Steel | | | | | | | | | | | | | | |
| 2401 | Coupling – For joining lengths of raceway. Use with V2400 Series. | | | | | | | | | | | | | | | | |
| | | | | | | | | | | | | | | | | | |
| 2400WC | Wire Clip – Holds conductors in place in raceway. | | | | | | | | | | | | | | | | |
| | | | | | | | | | | | | | | | | | |
| V2406 | Cover Clip – For covering joint where lengths of cover or base adjoin. Use with V2400 Series (nonmetallic). | | | | | | | | | | | | | | | | |
| | | | | | | | | | | | | | | | | | |

| Catalog No./Item | Description/Specifications |
|------------------|---------------------------------------------------------------------------------------------------------------------------|
| 2409 | Ground Clamp – No. 10 ground screw provided. Use with V2400 Series. |
| | |
| V2410A | Entrance End – For connecting V2400 with 1/2" trade size conduit and armored cable. Use with V2400 Series. |
| | |
| V2410B | Blank End – For closing open end of V2400 Series. |
| | |
| V2410C | Entrance End Fitting – Has 1/2" and 3/4" trade size KOs on end and bottom. Additional 1/2" trade size KO on sides. |
| | |

NEW!

V2400 Series (continued)

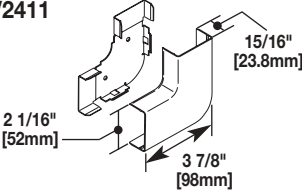
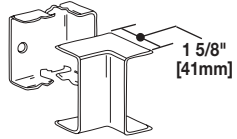
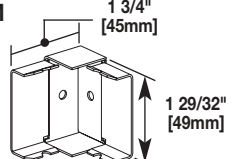
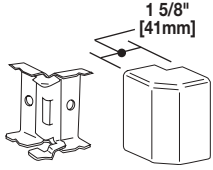
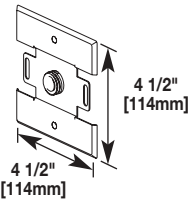
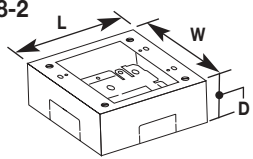
| Catalog No./Item | Description/Specifications |
|-----------------------------------------------------------------------------------------------------------------------|--------------------------------------------------------------------------------------------------------------------------------------------------------------------------------------------------------------------------|
| V2411  | 90° Flat Elbow – For right angle turns on the same surface (nonmetallic cover). Dimensions: 15/16" [23.8mm], 2 1/16" [52mm], 3 7/8" [98mm] |
| V2417  | Internal Elbow – For making internal corners (nonmetallic cover). Dimension: 1 5/8" [41mm] |
| V2417M  | Internal Elbow – For making internal 90° corners. All steel construction. Dimensions: 1 3/4" [45mm], 1 29/32" [49mm] |
| V2418  | External Elbow – For covering outside corners (nonmetallic cover). Dimension: 1 5/8" [41mm] |
| V2451H  | Back Feed Fitting – For feeding V2400 Raceway from an existing outlet box. Equipped with 1/2" trade size male bushing and locknut washer for grounding. Dimensions: 4 1/2" [114mm] |
| V2448 V2448-2  | Device Box – Cover has one twistout for 2400 on each side and ends. Base has 1/2" trade KO and rectangular KO for extension to wall box. Base has #10 threaded hole for ground connection. Dimensions: L, W, D |

| CAT NO. | L | W | D | GANG # |
|---------|----------------|----------------|---------------|--------|
| V2448 | 4 5/8" [117mm] | 2 7/8" [73mm] | 1 3/4" [44mm] | 1 |
| V2448-2 | 4 3/4" [121mm] | 4 3/4" [121mm] | 1 3/4" [44mm] | 2 |

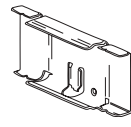
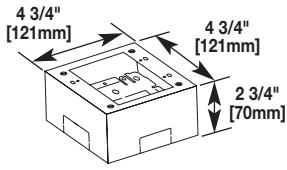
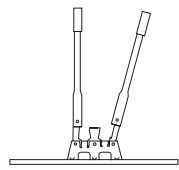
| Catalog No./Item | Description/Specifications | | | | | | | | | | | | | | | |
|----------------------------------------------------------------------------------------------------------------------|---------------------------------------------------------------------------------------------------------------------------------------------------------------------------------------------------------------------------------------------------------------------------------------------------------------------------------------------------------------------------------------------------------------------|----------------|---------------|--------|---|--------|-------|----------------|---------------|---------------|---|---------|----------------|----------------|---------------|---|
| V2489  | Side Reducing Connector – For connecting V2400 with V500 Raceway. | | | | | | | | | | | | | | | |
| V2444 V2444-2  | Extra Deep Device Box – Base has rectangular knockout to enable extension from existing single-gang flush wall box and 1/2" and 1" concentric KOs. V2444 Cover has two twistouts for 500 and 700, and two twistouts for 2400. V2444-2 Cover has four 2400 Series twistouts. Dimensions: 4 3/4" [121mm], 2 3/4" [70mm] | | | | | | | | | | | | | | | |
| | <table border="1" style="width: 100%; border-collapse: collapse;"> <thead> <tr> <th>CAT NO.</th> <th>L</th> <th>W</th> <th>D</th> <th>GANG #</th> </tr> </thead> <tbody> <tr> <td>V2444</td> <td>4 5/8" [117mm]</td> <td>2 7/8" [73mm]</td> <td>1 3/4" [44mm]</td> <td>1</td> </tr> <tr> <td>V2444-2</td> <td>4 3/4" [121mm]</td> <td>4 3/4" [121mm]</td> <td>1 3/4" [44mm]</td> <td>2</td> </tr> </tbody> </table> | CAT NO. | L | W | D | GANG # | V2444 | 4 5/8" [117mm] | 2 7/8" [73mm] | 1 3/4" [44mm] | 1 | V2444-2 | 4 3/4" [121mm] | 4 3/4" [121mm] | 1 3/4" [44mm] | 2 |
| CAT NO. | L | W | D | GANG # | | | | | | | | | | | | |
| V2444 | 4 5/8" [117mm] | 2 7/8" [73mm] | 1 3/4" [44mm] | 1 | | | | | | | | | | | | |
| V2444-2 | 4 3/4" [121mm] | 4 3/4" [121mm] | 1 3/4" [44mm] | 2 | | | | | | | | | | | | |
| 624  | 2400 and 2400BD Raceway & Cover Cutter – Portable cutter for 2400B and 2400BD Raceway and Cover. Tool steel construction for clean and easy square cuts. Total manual operation. | | | | | | | | | | | | | | | |
| 624BCK | Replacement Blade Kit – Replacement blades and die set for 624 Cutter. | | | | | | | | | | | | | | | |

Plugmold with Snapicoil Harness

| CATALOG NO. | LENGTH | | WIRING CONFIG | OUTLETS (15A 120V NEMA 5-15SR) | | HOLE CUT COVER | | HOUSING | | |
|-------------|--------|----------|---------------|--------------------------------|------------------|----------------|------------------|---------|--------|---------------------|
| | Feet | [meters] | | CENTER DISTANCE Inches | QUANTITY [mm] | QUANTITY | LENGTH Inches | | [mm] | |
| 20GB12 | 48' | [14.63] | GB | 12" | [305mm] | 48 Single | 8 | 6' | [1.8m] | Steel – Ivory, Gray |
| 20GB18 | 48' | [14.63] | GB | 18" | [457mm] | 32 Single | 8 | 6' | [1.8m] | Steel – Ivory, Gray |
| V20GB30 | 50' | [15.25] | GB | 30" | [760mm] | 20 Single | 10 | 5' | [1.5m] | Steel – Ivory |
| 20GBA12 | 48' | [15.24] | GBA | 12" | [305mm] | 48 Single | 8 | 6' | [1.8m] | Steel – Ivory, Gray |

Cord-Ended Plugmold Series

| CAT NO. | UNIT LENGTH | OUTLETS QUANTITY | CORD SET LENGTH | TYPE | SWITCH | CIRCUIT BREAKER | FINISH |
|---------|-------------|------------------|-----------------|----------|--------|-----------------|---------------------|
| 20-C2 | 3' 4" [1m] | 6 Single | 6' [1.8m] | 12/3 SJT | No | Yes | Steel – Gray, Ivory |

Plugmold Wire Fill Capacities for Power

| CABLE TYPE | WIRE SIZE THHN/THWN | O.D. | | NO. OF CONDUCTORS (40% FILL) | |
|--------------------------------------------|------------------------|--------|-------|---------------------------------|-------|
| | | Inches | [mm] | V2000 | V2400 |
| POWER WIRING WITHOUT DEVICES | 8 AWG | 0.216 | [5.5] | – | – |
| | 10 AWG | 0.166 | [4.2] | – | 26 |
| | 12 AWG | 0.130 | [3.3] | 7* | 41 |
| | 14 AWG | 0.111 | [2.8] | 7* | 57 |
| POWER WIRING WITH DEVICES (PLUGMOLD) | 8 AWG | 0.218 | [5.5] | – | 2 |
| | 10 AWG | 0.153 | [3.9] | – | 6 |
| | 12 AWG | 0.122 | [3.1] | 5* | 10 |
| | 14 AWG | 0.105 | [2.7] | 5* | – |

*Wire capacity limited to maximum of seven conductors due to .025" [.6mm] material thickness of cover.

**Including one hot, neutral, and ground wire from the receptacle.

Wiring Configuration

| | | | With Snapicoil | |
|----------------------------------------------------------------------------------------------------------------------|--------------------------------------------------------------------------------------------------------------------------------------------------|---------------------------------------------------------------------------------------------------------------------------------------------------|----------------------------------------------------------------------------------------------------------------------|--------------------------------------------------------------------------------------------------------------------------------------------------|
| | | | | |
| GB Series: 3-wire, #12 THHN (1 hot, 1 neutral and 1 ground), 1 circuit; has insulated grounding conductor. | GBA Series: 4-wire, #12 THHN (2 hot, 1 neutral and 1 ground), 2 circuit; outlets wired alternately; has insulated grounding conductor. | IG Series: 3-wire, #12 THHN (1 hot, 1 neutral and 1 ground), 1 circuit; has insulated-isolated grounding conductor. Orange receptacles. | GB Series: 3-wire, #12 THHN (1 hot, 1 neutral and 1 ground), 1 circuit; has insulated grounding conductor. | GBA Series: 4-wire, #12 THHN (2 hot, 1 neutral and 1 ground), 2 circuit; outlets wired alternately; has insulated grounding conductor. |

NOTE: SNAPICOIL REELS on custom order. Snapicoil is available on reels if lengths greater than 50' are needed, or if multiple lengths are required for production-type jobs. The maximum length per reel is 240' for Snapicoil with outlets 12" and 18" on centers; 500' with outlets 30" on center. Packaging includes the necessary number of lengths of base, holecut cover, wire clips, and couplings for complete installation. Price and delivery information should be obtained prior to specifying or ordering. To specify or order, add R to the Snapicoil number. Ex: V20GB12R. **Other outlet spacings available on custom order.**

Receptacles are made from high impact thermoplastic. V2000 Plugmold is supplied with two (2) V2010B Blank End Fittings and (1) 2001 Base Coupling. NM2000 Plugmold strips are supplied with two (2) NM2010B Blank End Fittings.

Plugmold Multi Outlet Strip

| CATALOG NO. | LENGTH | | WIRING CONFIG | OUTLETS | | FINISH |
|----------------|--------|---------|---------------|------------------------|---------|---------------------------------------|
| | Feet | [mm] | | CENTER DISTANCE Inches | [mm] | |
| 20GB206 | 2' | [610mm] | GB | 6" | [152mm] | 4 Single 15A Steel - S |
| 20GB306 | 3' | [915mm] | GB | 6" | [152mm] | 6 Single 15A Steel - WH, BK, V, G, S |
| V24GB306 | 3' | [915mm] | GB | 6" | [152mm] | 6 Single 20A Steel - V |
| 24S3612GBX99IV | 3' | [915mm] | GB | 12" | [305mm] | 3 Duplex 20A Steel - V, G |
| 24S3612GBA99IV | 3' | [915mm] | GBA | 12" | [305mm] | 3 Duplex 20A Steel - V, G |
| 20GB506 | 5' | [1.5m] | GB | 6" | [152mm] | 10 Single 15A Steel - WH, BK, V, G, S |
| V24GB506 | 5' | [1.5m] | GB | 6" | [152mm] | 10 Single 20A Steel - WH, BK, V, G, S |
| 20GB512 | 5' | [1.5m] | GB | 12" | [305mm] | 5 Single 15A Steel - WH, BK, V, G, S |
| V24GB512 | 5' | [1.5m] | GB | 12" | [305mm] | 5 Single 20A Steel - V |
| 20IG512 | 5' | [1.5m] | IG | 12" | [305mm] | 5 Single 15A Steel - V, G |
| 20GBA512 | 5' | [1.5m] | GBA | 12" | [305mm] | 5 Single 15A Steel - V, G |
| V24GBA512 | 5' | [1.5m] | GBA | 12" | [305mm] | 5 Single 20A Steel - V |
| 24S6012GBX99IV | 5' | [1.5m] | GB | 12" | [305mm] | 5 Duplex 20A Steel - V, G |
| 24S6012GBA99IV | 5' | [1.5m] | GBA | 12" | [305mm] | 5 Duplex 20A Steel - V, G |
| 24S6012IGX99IV | 5' | [1.5m] | IG | 12" | [305mm] | 5 Duplex 20A Steel - V, G |
| 20GB606 | 6 | [1.8m] | GB | 6" | [152mm] | 12 Single 15A Steel - WH, BK, V, G, S |
| V24GB606 | 6 | [1.8m] | GB | 6" | [152mm] | 12 Single 20A Steel - V |
| 20IG606 | 6 | [1.8m] | IG | 6" | [152mm] | 12 Single 15A Steel - V, G |
| 20GB609 | 6 | [1.8m] | GB | 9" | [229mm] | 8 Single 15A Steel - V, G |
| 20GBA609 | 6 | [1.8m] | GBA | 9" | [229mm] | 8 Single 15A Steel - V, G |
| 20GB612 | 6' | [1.8m] | GB | 12" | [305mm] | 6 Single 15A Steel - WH, BK, V, G, S |
| 20GBA612 | 6 | [1.8m] | GBA | 12" | [305mm] | 6 Single 15A Steel - V, G |
| V24GB612 | 6' | [1.8m] | GB | 12" | [305mm] | 6 Single 20A Steel - V |
| V24GBA612 | 6' | [1.8m] | GBA | 12" | [305mm] | 6 Single 20A Steel - V |
| V24GB618 | 6' | [1.8m] | GB | 12" | [305mm] | 6 Single 20A Steel - V |
| 20GB618 | 6 | [1.8m] | GB | 18" | [457mm] | 4 Single 15A Steel - V, G |
| 20GBA618 | 6 | [1.8m] | GBA | 18" | [457mm] | 4 Single 15A Steel - V, G |
| V24GBA618 | 6' | [1.8m] | GBA | 18" | [457mm] | 4 Single 20A Steel - V |
| 24S7212GBX99IV | 6 | [1.8m] | GB | 12" | [305mm] | 6 Duplex 20A Steel - V, G |
| 24S7224GBA99IV | 6 | [1.8m] | GBA | 24" | [608mm] | 3 Duplex 20A Steel - V, G |
| 24S7218GBX99IV | 6 | [1.8m] | GB | 18" | [457mm] | 4 Duplex 20A Steel - V, G |
| 24S7224GBX99IV | 6 | [1.8m] | GB | 24" | [608mm] | 5 Duplex 20A Steel - V, G |
| 24S7218IGX99IV | 6 | [1.8m] | IG | 18" | [457mm] | 5 Duplex 20A Steel - V, G |
| 24S7212IGX99IV | 6 | [1.8m] | IG | 12" | [305mm] | 6 Duplex 20A Steel - V, G |
| 24S7224IGX99IV | 6 | [1.8m] | IG | 24" | [608mm] | 3 Duplex 20A Steel - V, G |
| 24S7212GBA99IV | 6 | [1.8m] | GBA | 12" | [305mm] | 6 Duplex 20A Steel - V, G |
| 24S7218GBA99IV | 6' | [1.8m] | GBA | 18" | [457mm] | 4 Duplex 20A Steel - V, G |

NOTE: "V" indicates Ivory ScuffCoat™ finish, "G" indicates Gray ScuffCoat™ finish, "WH" indicates White enamel finish, "BK" indicates Black enamel finish, and "S" indicates Stainless Steel finish.

Datacom Connectivity Options

Now you have a wide range of options for providing datacom connectivity into Wiremold® Cable Management Systems. They are:

- Ortronics® TracJack® and Series II Modular Connectivity Solutions
- Pass & Seymour Activate™ Modular Inserts
- Open System Communication Modules

| | | |
|------|------|------|
| ORT | ORT | ORT |
| P&S | P&S | P&S |
| OPEN | OPEN | OPEN |

Use these icons to determine connectivity options for each Wiremold System component:

| |
|------|
| ORT |
| P&S |
| OPEN |

Ortronics® Connectivity

TracJack® Individual Jack System

- Front-loading, snap-in design supports future moves adds and changes
- Inserts for voice, data, audio, and video
- Available Category 3, 5e, 6, USOC 6-position, and other media
- Flat or angled 45° exit configurations
- Choice of 13 colors and color matched to Wiremold Systems
- Universal T568A/B wiring format



Series II Front-Loading, Module System

- Module design features easy snap-in front-loading design
- Linear 110 punch down format for easy termination
- Inserts for voice, data, audio, and video
- Available Category 3, 5e, 6, USOC 6-position, and other media
- Available in flat or angled 45° exit configurations
- Color matched to Wiremold Systems



For detailed product selection refer to the Ortronics Catalog or visit www.ortronics.com.

| |
|------|
| ORT |
| P&S |
| OPEN |

Pass & Seymour Legrand Network Wiring

Activate™ Series Front-Loading Inserts

- Modular inserts for voice, data, audio and video applications
- Front-load, snap-in design
- Color and texture matched to Wiremold Systems
- Available Category 3, 5e, 6, as well as 6-position USOC
- Universal T568A/B wiring format



For detailed product selection refer to the Pass & Seymour Network Wiring Catalog or visit www.passandseymour.com.

| |
|------|
| ORT |
| P&S |
| OPEN |

Open Connectivity Solutions

Wiremold Open System Communications Modules

- Accommodate a wide range of manufacturers' communications outlets including keystone jacks, as well as proprietary solutions from Avaya (Systemax) and NORDX
- Modules insert into a wide range of Wiremold Systems
- Pre-punched faceplates accept common communication devices



NOTE: For more information on integrating connectivity into Wiremold Cable Management Systems contact the Wiremold Applications Engineering Team or your local Wiremold Sales Representative.

WIREMOLD



Wiremold / Legrand

U.S. and International:

60 Woodlawn Street • West Hartford, CT 06110

1-800-621-0049 • FAX 860-232-2062 • Outside U.S. 860-233-6251

Canada:

570 Applewood Crescent • Vaughan, Ontario L4K 4B4

1-800-723-5175 • FAX 905-738-9721

ED1412 – May 2006 – For latest specs visit www.wiremold.com

