

Catalog #		Date		Prepared by	
Project		Type		Notes	



# Metalux

## VHB

### LED High Bay Luminaire

#### Typical Applications

- Industrial
- Commercial Manufacturing
- Gymnasium

#### Product Certification



#### Product Features



#### Interactive Menu

- Order Information [page 2](#)
- Photometric Data [page 3](#)
- Control Systems [page 5](#)
- Integrated Sensors [page 6](#)
- Product Warranty

#### Top Product Features

- Compact, lightweight design for ease of installation
- High Impact Polycarbonate optical lens
- 5 lumen packages available (9,000, 12,000, 15,000, 18,000 and 24,000)
- High-Performance efficacy up to 133 lm/W
- Occupancy and daylight sensor for added savings

#### Dimensional and Mounting Details

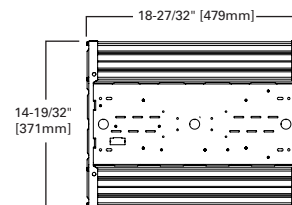
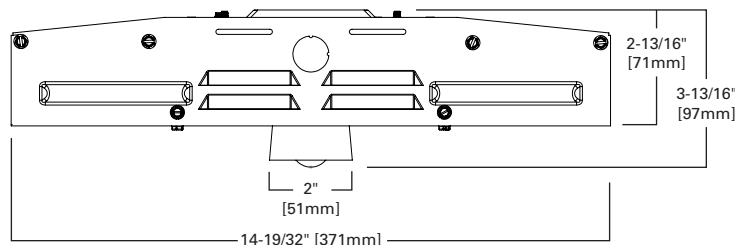

## Order Information

SAMPLE ORDER NUMBER: **VHBLED-LD1-12-W-UNV-L840-CD1-U** Includes V Hangers for rapid installation

Series	Lamp Type	LED Lumen Output	Distribution	Shielding	Voltage	CCT	Options
<b>VHBLED=LED High Bay</b>	<b>LD1=LED 1.0</b>	9=9,000 Lumens 12=12,000 Lumens 15=15,000 Lumens 18=18,000 Lumens 24=24,000 Lumens <sup>(13)</sup>	<b>N=Narrow (Aisle)</b> <b>W=Wide (General)</b>	<b>[Blank]=High Impact Polycarbonate Lens</b>	<b>UNV=Universal Voltage 120-277</b> <b>UNC=Universal Voltage 347/480</b> <sup>(13)</sup>	<b>L835=3500K</b> <b>L840=4000K</b> <b>L850=5000</b>	<b>Emergency EL20W-REM=20-watt,120V-277V emergency battery pack remote mounted</b> <sup>(4)</sup>
<b>Notes</b> <small>(10) DesignLights Consortium® Qualified and classified for DLC Standard, refer to www.designlights.org for details.</small>		<b>Notes</b> <small>(13) Y-toggle mounting is required when installing the VHB 24K lumen combined with UNC, 347V, 480V, and a motion sensor.</small>			<b>Notes</b> <small>(1) Voltage must be specified when ordering accessory cord and plug (13) Y-toggle mounting is required when installing the VHB 24K lumen combined with UNC, 347V, 480V, and a motion sensor.</small>		<b>Notes</b> <small>(4) EL20EM-REM requires remote mount only.</small>

Driver Type	Number of Drivers	Options	Motion Sensors	Packaging	Accessories
<b>CD=0-10V Dimming Driver</b> <b>5LTD=5th Light DALI</b> (not available in 24,000 lumens)	<b>1=1 Driver</b>	<b>MP=Modular Power Receptacle</b> (used for all Cord or Cord and Plug options) <sup>(7)</sup> <b>PAF=Painted After Fabrication</b>	<b>MS=360° or 180° Motion Sensor Installed</b> , (specify voltage) <sup>(6), (12)</sup> <b>SVPD3=Integrated occupancy and daylight dimming sensor</b> , 1200 sq. ft. coverage <sup>(6), (12), (13)</sup> <b>LWR=LumaWatt Wireless Sensor system</b> <sup>(6), (13)</sup> <b>ZW-SWPD3=Integrated WaveLinX Wireless Sensor</b> , 1200 sq ft. coverage <b>ZW=WaveLinX Wireless Enabled</b> (does not include sensor)	<b>U=Unit Pack</b> <b>PALC=Job Pack</b> , in carton	<b>VHB-SPM=Single Point Mount Adapter Kit</b> <sup>(2), (3), (8)</sup> <b>LOOP-10=Ten Foot Loop Hanger, #2 Cable</b> <sup>(9)</sup> <b>LOOP-30=Thirty Foot Loop Hanger, #2 Cable</b> <sup>(9)</sup> <b>FL-1=Fixture Loop</b> <sup>(11)</sup> <b>SHK=Fixture Hook</b> <sup>(11)</sup> <b>Y-TOGGLE=Y Mounting Toggle, #2 Cable</b> (Specify 10" or 30") (order two per fixture) <sup>(13)</sup> <b>HBAYC-CHAIN/SET/U=(2) V-Hook Hangers, 36" Chain Sets w/S-Hooks</b> <b>VHB-WG=Field Installable, Wireguard for VHB</b> <sup>(5)</sup> <b>MPC3=3' Modular Power Cord &amp; Plug</b> (Specify Voltage) <b>MC6=6' Modular Power Cord</b> <b>MPC6=6' Modular Power Cord &amp; Plug</b> (Specify Voltage) <b>ISHH-01=Programming Remote for Integrated Sensor</b> <b>ISHH-02=Personal Control Remote for Integrated Sensor</b> <b>SWPD3=WaveLinX Sensor</b> (for field installation into WaveLinX enabled fixture)
		<b>Notes</b> <small>(7) Requires use of MC or MPC cord accessories.</small>	<b>Notes</b> <small>(6) When ordering MS, SVPD3, or LWR option, specify as UNV (for 120 or 277V), or 347V, or 480V. (12) SVPD3 sensor rated for -25°C to 55°C ambient. (13) Y-toggle mounting is required when installing the VHB 24K lumen combined with UNC, 347V, 480V, and a motion sensor.</small>		<b>Notes</b> <small>(2) Fixture cannot be surfaced mounted and must be a minimum of 18 inches below ceiling surface. (3) Single point mounting requires counterbalance weight which is included in the VHB-SPM kit. (5) Wireguard option is field installable only. (8) Rigid mount not for use in gymnasiums. (9) The accessory Loop Hanger shall be utilized only as a secondary safety and not the primary means of mounting. (11) Must be used in conjunction with VHB-SPM accessory for proper attachment to fixture. (13) Y-toggle mounting is required when installing the VHB 24K lumen combined with UNC, 347V, 480V, and a motion sensor.</small>

## Product Specifications

### Construction

- Durable CRS and extruded aluminum housing provides added protection for LED components and optimal performance
- Compact 15in x 18in low-profile design for a less obtrusive installation

### Electrical

- Long-life LED system coupled with electrical driver to deliver optimal performance
- LED's available in 3500K, 4000K and 5000K with a CRI ≥ 80
- cULus listed
- Electronic drivers are available for 120-277V, 347V and 480V applications
- Standard 0-10V dimming
- Or, specify the Digital Addressable Lighting Interface (DALI) drivers for use with Fifth Light controls

### Finish

- White enamel finish preceded by a multistage cleaning cycle, iron phosphate coating with rust inhibitor to protect against contaminants and oxidation

### Optics

- Precision designed, high-impact polycarbonate optics deliver even illumination
- Narrow and wide distribution ensures superior performance to key areas within an application

### Options

- Integral Occupancy Sensor available and provides 1200 sq. ft. of coverage in a maximum mounting height of 30'

### Mounting

- The VHB LED series is ideally suited for suspension mounting with standard V Hangers (included) and optional chain set, or cable mounting
- Single-point mounting is also available with SPM adapter kit

### Compliance

- Luminaires are cULus listed for damp locations -40°C to 40°C ambient environments with 0-10V drivers (see chart)
- RoHS compliant, and LED modules comply with IESNA LM-79 and LM-80 standards
- DesignLights Consortium® Qualified and classified for DLC Standard, refer to www.designlights.org for details

### Warranty

- Five-year warranty

## Photometric Data

[View IES files](#)

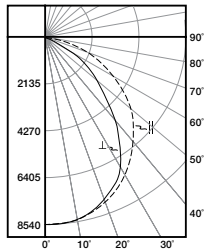

**VHBLED-LD1-18-N-UNV-L840-CD-U**  
 Electronic Driver  
 Linear LED 4000K  
 Spacing criterion: (II) 1.29 x mounting height,  
 (⊥) 0.77 x mounting height  
 Lumens: 18322  
 Input Watts: 159.8W  
 Efficacy: 114.7 lm/W  
 Test Report:  
 VHBLED-LD1-18-N-UNV-L840-CD-U.IES

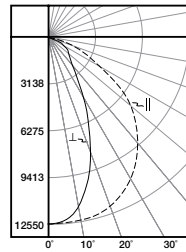

**VHBLED-LD1-18-W-UNV-L850-CD-U**  
 Electronic Driver  
 Linear LED 500K  
 Spacing criterion: (II) 1.26 x mounting height,  
 (⊥) 1.19 x mounting height  
 Lumens: 19263  
 Input Watts: 159.5W  
 Efficacy: 121 lm/W  
 Test Report:  
 VHBLED-LD1-18-W-UNV-L850-CD-U.IES

## Energy and Performance Data by Catalog Number

Catalog Number	Description	Delivered Lumens	Watts	Efficacy (lm/W)
<b>Narrow</b>				
VHBLED-LD1-9-N-UNV-L835-CD1-U	Value High Bay, 9K Lumen, Narrow Dist, 120-277V, 3500K, Dim	8508	70	122
VHBLED-LD1-9-N-UNV-L840-CD1-U	Value High Bay, 9K Lumen, Narrow Dist, 120-277V, 4000K, Dim	8885	70	127
VHBLED-LD1-9-N-UNV-L850-CD1-U	Value High Bay, 9K Lumen, Narrow Dist, 120-277V, 5000K, Dim	8999	70	129
VHBLED-LD1-12-N-UNV-L835-CD1-U	Value High Bay, 12K Lumen, Narrow Dist, 120-277V, 3500K, Dim	11849	100	118
VHBLED-LD1-12-N-UNV-L840-CD1-U	Value High Bay, 12K Lumen, Narrow Dist, 120-277V, 4000K, Dim	12374	100	124
VHBLED-LD1-12-N-UNV-L850-CD1-U	Value High Bay, 12K Lumen, Narrow Dist, 120-277V, 5000K, Dim	12533	100	125
VHBLED-LD1-15-N-UNV-L835-CD1-U	Value High Bay, 15K Lumen, Narrow Dist, 120-277V, 3500K, Dim	14383	124	116
VHBLED-LD1-15-N-UNV-L840-CD1-U	Value High Bay, 15K Lumen, Narrow Dist, 120-277V, 4000K, Dim	15020	124	121
VHBLED-LD1-15-N-UNV-L850-CD1-U	Value High Bay, 15K Lumen, Narrow Dist, 120-277V, 5000K, Dim	15213	124	123
VHBLED-LD1-18-N-UNV-L835-CD1-U	Value High Bay, 18K Lumen, Narrow Dist, 120-277V, 3500K, Dim	17546	160	110
VHBLED-LD1-18-N-UNV-L840-CD1-U	Value High Bay, 18K Lumen, Narrow Dist, 120-277V, 4000K, Dim	18323	160	115
VHBLED-LD1-18-N-UNV-L850-CD1-U	Value High Bay, 18K Lumen, Narrow Dist, 120-277V, 5000K, Dim	18559	160	116
VHBLED-LD1-24-N-UNV-L835-CD1-U	Value High Bay, 24K Lumen, Narrow Dist, 120-277V, 3500K, Dim	22304	213	105
VHBLED-LD1-24-N-UNV-L840-CD1-U	Value High Bay, 24K Lumen, Narrow Dist, 120-277V, 4000K, Dim	23292	213	109
VHBLED-LD1-24-N-UNV-L850-CD1-U	Value High Bay, 24K Lumen, Narrow Dist, 120-277V, 5000K, Dim	23592	213	111
<b>Wide</b>				
VHBLED-LD1-9-W-UNV-L835-CD1-U	Value High Bay, 9K Lumen, Wide Dist, 120-277V, 3500K, Dim	8677	70	124
VHBLED-LD1-9-W-UNV-L840-CD1-U	Value High Bay, 9K Lumen, Wide Dist, 120-277V, 4000K, Dim	9004	70	129
VHBLED-LD1-9-W-UNV-L850-CD1-U	Value High Bay, 9K Lumen, Wide Dist, 120-277V, 5000K, Dim	9341	70	133
VHBLED-LD1-12-W-UNV-L835-CD1-U	Value High Bay, 12K Lumen, Wide Dist, 120-277V, 3500K, Dim	12084	100	121
VHBLED-LD1-12-W-UNV-L840-CD1-U	Value High Bay, 12K Lumen, Wide Dist, 120-277V, 4000K, Dim	12540	100	125
VHBLED-LD1-12-W-UNV-L850-CD1-U	Value High Bay, 12K Lumen, Wide Dist, 120-277V, 5000K, Dim	13009	100	130
VHBLED-LD1-15-W-UNV-L835-CD1-U	Value High Bay, 15K Lumen, Wide Dist, 120-277V, 3500K, Dim	14576	124	118
VHBLED-LD1-15-W-UNV-L840-CD1-U	Value High Bay, 15K Lumen, Wide Dist, 120-277V, 4000K, Dim	15221	124	123
VHBLED-LD1-15-W-UNV-L850-CD1-U	Value High Bay, 15K Lumen, Wide Dist, 120-277V, 5000K, Dim	15417	124	124
VHBLED-LD1-18-W-UNV-L835-CD1-U	Value High Bay, 18K Lumen, Wide Dist, 120-277V, 3500K, Dim	17894	160	112
VHBLED-LD1-18-W-UNV-L840-CD1-U	Value High Bay, 18K Lumen, Wide Dist, 120-277V, 4000K, Dim	18568	160	116
VHBLED-LD1-18-W-UNV-L850-CD1-U	Value High Bay, 18K Lumen, Wide Dist, 120-277V, 5000K, Dim	19263	160	120
VHBLED-LD1-24-W-UNV-L835-CD1-U	Value High Bay, 24K Lumen, Wide Dist, 120-277V, 3500K, Dim	22603	213	106
VHBLED-LD1-24-W-UNV-L840-CD1-U	Value High Bay, 24K Lumen, Wide Dist, 120-277V, 4000K, Dim	23604	213	111
VHBLED-LD1-24-W-UNV-L850-CD1-U	Value High Bay, 24K Lumen, Wide Dist, 120-277V, 5000K, Dim	23908	213	112

## Energy and Performance Data

### Lumen Maintenance

Ambient Temperature	TM-21 Lumen Maintenance (60,000 hours)	Theoretical L70 (Hours)
40°C	> 83%	> 114,000

### Ambient Ratings

Lumen Package	Ambient Rating	EM Battery (Remote)
VHBLED-LD1-9	40°C	40°C
VHBLED-LD1-12	40°C	40°C
VHBLED-LD1-15	40°C	40°C
VHBLED-LD1-18	40°C	40°C
VHBLED-LD1-24	40°C	40°C

### Shipping Data

Catalog No.	Wt.
VHBLED-LD1-9	15 lbs.
VHBLED-LD1-12	15 lbs.
VHBLED-LD1-15	15 lbs.
VHBLED-LD1-18	15 lbs.
VHBLED-LD1-24	15 lbs.

## Modular F-Bay Power Supply Option

Cooper Lighting's F-Bay Modular Power Supply option is available for use with all F-Bay products. The modular power supply allows external fixture access for safe and easy servicing. There is no need to remove lamps or reflectors to disconnect fixture power with F-Bay Modular Power Supply. Access to the individual fixture's power supply allows servicing without turning off all the fixtures, disrupting occupants. F-Bay Modular Power Supply is a time saver in installation – **simply plug & power.**

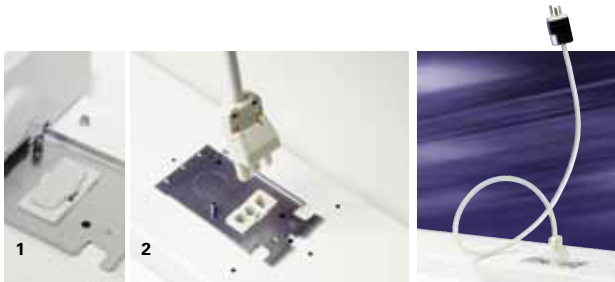

1. Modular Power Supply Receptacle supplied mounted into fixture Access Plate
2. Modular Power Cord & Plugs in 120, 277, 347, & 480V configurations for easy plug & power into existing supply

No internal fixture access required for installation or disconnecting power

### Code Compliance

- UL/cUL Certified for Make/Break under load (UL2549)
- Meets NEC requirements for ballast disconnect (NEC 410.73G)
- Allows for addition of Occupancy Sensor without hard connections
- Receptacles complete with insulating/dust cap

## Control Systems

- WaveLinx
- DLVP
- LumaWatt Pro
- iLumin Plus
- VividTune

## We make connections work

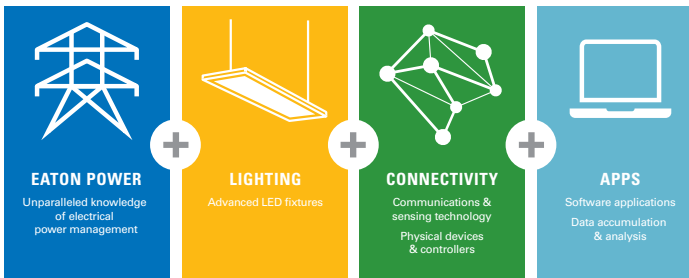

## Systems comparison chart

Eaton provides many lighting system solutions designed to satisfy code requirements and meet the unique needs of any project.

	Distributed Low-Voltage Power System	WaveLinx	LumaWatt Pro
Space type	Interior	Interior/Outdoor	Any
Stand-alone or Network	Stand-alone	Both	Network
Need-based feature progression			
Basic compliance only	●	●	●
Occupancy sensing	●	●	●
Daylight harvesting	●	●	●
Zone control	●	●	●
Scheduling	●	●	●
0-10V dimming	●	●	●
Individual fixture control	●	●	●
Retrofit+Building Integration	●	●	●
Total wireless connectivity		●	●
AV integration		●	●
BMS integration		●	●
UI options (touchscreen, apps, etc.)		●	●
Enterprise level building integration		●	●
Facility management & tools		●	●
Floor plan & reporting tools			●
Value-added services			●
Asset tracking			●
API integration		●	●
Analytics/higher problem solving			●



## Integrated Sensor

The VHB with Integrated Sensor technology provides automatic energy savings without sacrificing performance. Traditionally, these types of energy savings required coordination between the luminaire and a lighting control system.

The VHB delivers superior lighting with integrated occupancy and daylighting controls.

Capture the benefits of traditional lighting controls, without complicated coverage planning or special wiring.

Ideal for new construction or retrofit, the VHB delivers automatic ON to an energy saving light level, while ensuring lighting is turned OFF when the space is unoccupied.

The integral daylight sensor reduces the need for special daylight zone planning. Each luminaire will automatically adjust the light level based on reflected light beneath the sensor in a closed loop method.

Occupied daylight light levels and unoccupied light levels can be adjusted using the integrated sensor

programming remote (Catalog Number: ISHH-01). The integrated sensor personal remote (Catalog Number: ISHH-02) provides code compliant manual raise, lower, ON, OFF control.

The VHB with Integrated Sensor is easy to install with no special wiring and ensures energy savings out-of-the-box with default control settings.

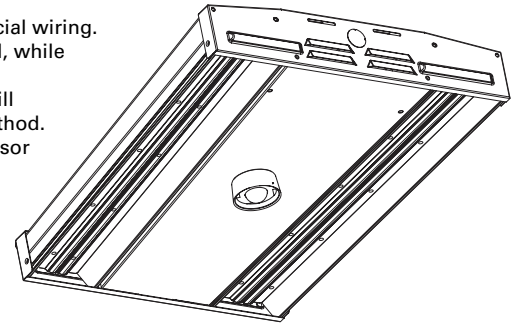

### How it works:

- As the user enters the space controlled by the integral sensor, the lighting turns ON to the default daylight level.
- Lighting will remain at that the daylight level until the space is unoccupied. This will start the occupancy timeout period (default 20 minutes).
- If the space remains unoccupied for half of the timeout period, the lighting will automatically reduce to the Energy Saver light level. This adjustable light level is typically half of the occupied daylight level.
- At the end of the timeout period the lighting will go to the unoccupied light level. This adjustable light level uses the OFF default setting.

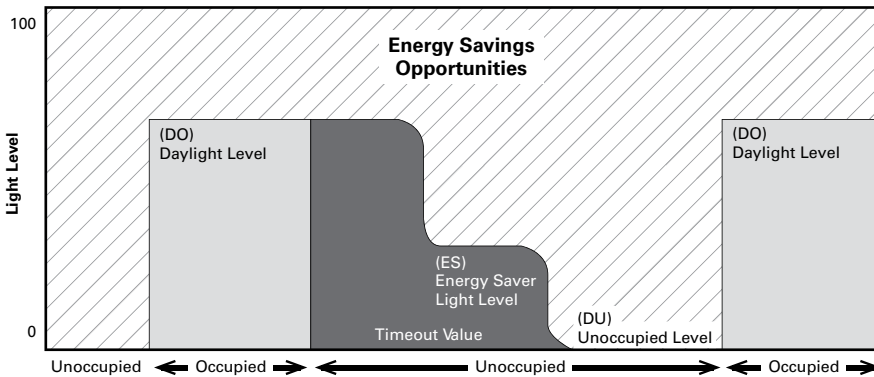

Default daylight harvesting set using 36,000 lumen unit at 30 ft. mounting height, 20 ft. spacing for 50 footcandles.

### SVPD3 Coverage Pattern

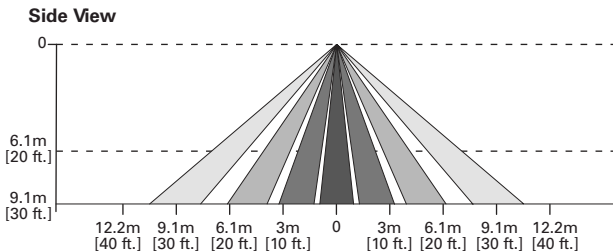

### Optional Remote Controls



ISHH-01 Remote



ISHH-02 Remote

Catalog #		Date		Prepared by	
Project		Type		Notes	



# Metalux

## VHB

### LED High Bay Luminaire

#### Typical Applications

- Industrial • Commercial Manufacturing • Gymnasium

#### Interactive Menu

- Order Information [page 2](#)
- Photometric Data [page 3](#)
- Control Systems [page 5](#)
- Integrated Sensors [page 6](#)
- Product Warranty

#### Product Certification



#### Product Features



#### Top Product Features

- Compact, lightweight design for ease of installation
- High Impact Polycarbonate optical lens
- 5 lumen packages available (9,000, 12,000, 15,000, 18,000 and 24,000)
- High-Performance efficacy up to 133 lm/W
- Occupancy and daylight sensor for added savings

#### Dimensional and Mounting Details

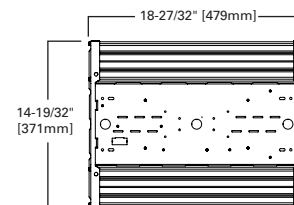
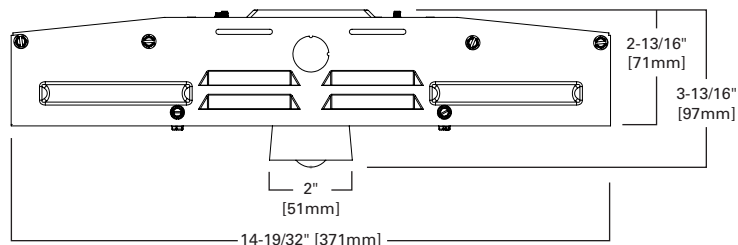

## Order Information

SAMPLE ORDER NUMBER: **VHBLED-LD1-12-W-UNV-L840-CD1-U** Includes V Hangers for rapid installation

Series	Lamp Type	LED Lumen Output	Distribution	Shielding	Voltage	CCT	Options
<b>VHBLED=LED High Bay</b>	<b>LD1=LED 1.0</b>	9=9,000 Lumens 12=12,000 Lumens 15=15,000 Lumens 18=18,000 Lumens 24=24,000 Lumens <sup>(13)</sup>	<b>N</b> =Narrow (Aisle) <b>W</b> =Wide (General)	<b>[Blank]</b> =High Impact Polycarbonate Lens	<b>UNV</b> =Universal Voltage 120-277 <b>UNC</b> =Universal Voltage 347/480 <sup>(13)</sup>	<b>L835</b> =3500K <b>L840</b> =4000K <b>L850</b> =5000	<b>Emergency EL20W-REM</b> =20-watt,120V-277V emergency battery pack remote mounted <sup>(4)</sup>
<b>Notes</b> <small>(10) DesignLights Consortium® Qualified and classified for DLC Standard, refer to www.designlights.org for details.</small>		<b>Notes</b> <small>(13) Y-toggle mounting is required when installing the VHB 24K lumen combined with UNC, 347V, 480V, and a motion sensor.</small>			<b>Notes</b> <small>(1) Voltage must be specified when ordering accessory cord and plug (13) Y-toggle mounting is required when installing the VHB 24K lumen combined with UNC, 347V, 480V, and a motion sensor.</small>		<b>Notes</b> <small>(4) EL20EM-REM requires remote mount only.</small>

Driver Type	Number of Drivers	Options	Motion Sensors	Packaging	Accessories
<b>CD-0-10V Dimming Driver</b> <b>5LTD</b> =Fifth Light DALI (not available in 24,000 lumens)	<b>1=1 Driver</b>	<b>MP</b> =Modular Power Receptacle (used for all Cord or Cord and Plug options) <sup>(7)</sup> <b>PAF</b> =Painted After Fabrication	<b>MS</b> =360° or 180° Motion Sensor Installed, (specify voltage) <sup>(6), (12)</sup> <b>SVPD3</b> =Integrated occupancy and daylight dimming sensor, 1200 sq. ft. coverage <sup>(6), (12), (13)</sup> <b>LWR</b> =LumaWatt Wireless Sensor system <sup>(6), (13)</sup> <b>ZW-SWPD3</b> =Integrated WaveLinX Wireless Sensor, 1200 sq ft. coverage <b>ZW</b> =WaveLinX Wireless Enabled (does not include sensor)	<b>U</b> =Unit Pack <b>PALC</b> =Job Pack, in carton	<b>VHB-SPM</b> =Single Point Mount Adapter Kit <sup>(2), (3), (8)</sup> <b>LOOP-10</b> =Ten Foot Loop Hanger, #2 Cable <sup>(9)</sup> <b>LOOP-30</b> =Thirty Foot Loop Hanger, #2 Cable <sup>(9)</sup> <b>FL-1</b> =Fixture Loop <sup>(11)</sup> <b>SHK</b> =Fixture Hook <sup>(11)</sup> <b>Y-TOGGLE</b> =Y Mounting Toggle, #2 Cable (Specify 10" or 30") (order two per fixture) <sup>(13)</sup> <b>HBAYC-CHAIN/SET/U</b> =(2) V-Hook Hangers, 36" Chain Sets w/S-Hooks <b>VHB-WG</b> =Field Installable, Wireguard for VHB <sup>(5)</sup> <b>MPC3</b> =3' Modular Power Cord & Plug (Specify Voltage) <b>MC6</b> =6' Modular Power Cord <b>MPC6</b> =6' Modular Power Cord & Plug (Specify Voltage) <b>ISHH-01</b> =Programming Remote for Integrated Sensor <b>ISHH-02</b> =Personal Control Remote for Integrated Sensor <b>SWPD3</b> =WaveLinX Sensor (for field installation into WaveLinX enabled fixture)
		<b>Notes</b> <small>(7) Requires use of MC or MPC cord accessories.</small>	<b>Notes</b> <small>(6) When ordering MS, SVPD3, or LWR option, specify as UNV (for 120 or 277V), or 347V, or 480V. (12) SVPD3 sensor rated for -25°C to 55°C ambient. (13) Y-toggle mounting is required when installing the VHB 24K lumen combined with UNC, 347V, 480V, and a motion sensor.</small>		<b>Notes</b> <small>(2) Fixture cannot be surfaced mounted and must be a minimum of 18 inches below ceiling surface. (3) Single point mounting requires counterbalance weight which is included in the VHB-SPM kit. (5) Wireguard option is field installable only. (8) Rigid mount not for use in gymnasiums. (9) The accessory Loop Hanger shall be utilized only as a secondary safety and not the primary means of mounting. (11) Must be used in conjunction with VHB-SPM accessory for proper attachment to fixture. (13) Y-toggle mounting is required when installing the VHB 24K lumen combined with UNC, 347V, 480V, and a motion sensor.</small>

## Product Specifications

### Construction

- Durable CRS and extruded aluminum housing provides added protection for LED components and optimal performance
- Compact 15in x 18in low-profile design for a less obtrusive installation

### Electrical

- Long-life LED system coupled with electrical driver to deliver optimal performance
- LED's available in 3500K, 4000K and 5000K with a CRI ≥ 80
- cULus listed
- Electronic drivers are available for 120-277V, 347V and 480V applications
- Standard 0-10V dimming
- Or, specify the Digital Addressable Lighting Interface (DALI) drivers for use with Fifth Light controls

### Finish

- White enamel finish preceded by a multistage cleaning cycle, iron phosphate coating with rust inhibitor to protect against contaminants and oxidation

### Optics

- Precision designed, high-impact polycarbonate optics deliver even illumination
- Narrow and wide distribution ensures superior performance to key areas within an application

### Options

- Integral Occupancy Sensor available and provides 1200 sq. ft. of coverage in a maximum mounting height of 30'

### Mounting

- The VHB LED series is ideally suited for suspension mounting with standard V Hangers (included) and optional chain set, or cable mounting
- Single-point mounting is also available with SPM adapter kit

### Compliance

- Luminaires are cULus listed for damp locations -40°C to 40°C ambient environments with 0-10V drivers (see chart)
- RoHS compliant, and LED modules comply with IESNA LM-79 and LM-80 standards
- DesignLights Consortium® Qualified and classified for DLC Standard, refer to www.designlights.org for details

### Warranty

- Five-year warranty



## Photometric Data

[View IES files](#)

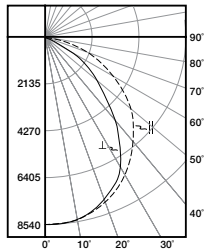

**VHBLED-LD1-18-N-UNV-L840-CD-U**  
 Electronic Driver  
 Linear LED 4000K  
 Spacing criterion: (II) 1.29 x mounting height,  
 (⊥) 0.77 x mounting height  
 Lumens: 18322  
 Input Watts: 159.8W  
 Efficacy: 114.7 lm/W  
 Test Report:  
 VHBLED-LD1-18-N-UNV-L840-CD-U.IES

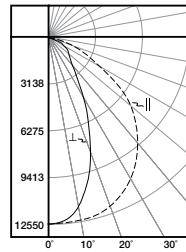

**VHBLED-LD1-18-W-UNV-L850-CD-U**  
 Electronic Driver  
 Linear LED 500K  
 Spacing criterion: (II) 1.26 x mounting height,  
 (⊥) 1.19 x mounting height  
 Lumens: 19263  
 Input Watts: 159.5W  
 Efficacy: 121 lm/W  
 Test Report:  
 VHBLED-LD1-18-W-UNV-L850-CD-U.IES

## Energy and Performance Data by Catalog Number

Catalog Number	Description	Delivered Lumens	Watts	Efficacy (lm/W)
<b>Narrow</b>				
VHBLED-LD1-9-N-UNV-L835-CD1-U	Value High Bay, 9K Lumen, Narrow Dist, 120-277V, 3500K, Dim	8508	70	122
VHBLED-LD1-9-N-UNV-L840-CD1-U	Value High Bay, 9K Lumen, Narrow Dist, 120-277V, 4000K, Dim	8885	70	127
VHBLED-LD1-9-N-UNV-L850-CD1-U	Value High Bay, 9K Lumen, Narrow Dist, 120-277V, 5000K, Dim	8999	70	129
VHBLED-LD1-12-N-UNV-L835-CD1-U	Value High Bay, 12K Lumen, Narrow Dist, 120-277V, 3500K, Dim	11849	100	118
VHBLED-LD1-12-N-UNV-L840-CD1-U	Value High Bay, 12K Lumen, Narrow Dist, 120-277V, 4000K, Dim	12374	100	124
VHBLED-LD1-12-N-UNV-L850-CD1-U	Value High Bay, 12K Lumen, Narrow Dist, 120-277V, 5000K, Dim	12533	100	125
VHBLED-LD1-15-N-UNV-L835-CD1-U	Value High Bay, 15K Lumen, Narrow Dist, 120-277V, 3500K, Dim	14383	124	116
VHBLED-LD1-15-N-UNV-L840-CD1-U	Value High Bay, 15K Lumen, Narrow Dist, 120-277V, 4000K, Dim	15020	124	121
VHBLED-LD1-15-N-UNV-L850-CD1-U	Value High Bay, 15K Lumen, Narrow Dist, 120-277V, 5000K, Dim	15213	124	123
VHBLED-LD1-18-N-UNV-L835-CD1-U	Value High Bay, 18K Lumen, Narrow Dist, 120-277V, 3500K, Dim	17546	160	110
VHBLED-LD1-18-N-UNV-L840-CD1-U	Value High Bay, 18K Lumen, Narrow Dist, 120-277V, 4000K, Dim	18323	160	115
VHBLED-LD1-18-N-UNV-L850-CD1-U	Value High Bay, 18K Lumen, Narrow Dist, 120-277V, 5000K, Dim	18559	160	116
VHBLED-LD1-24-N-UNV-L835-CD1-U	Value High Bay, 24K Lumen, Narrow Dist, 120-277V, 3500K, Dim	22304	213	105
VHBLED-LD1-24-N-UNV-L840-CD1-U	Value High Bay, 24K Lumen, Narrow Dist, 120-277V, 4000K, Dim	23292	213	109
VHBLED-LD1-24-N-UNV-L850-CD1-U	Value High Bay, 24K Lumen, Narrow Dist, 120-277V, 5000K, Dim	23592	213	111
<b>Wide</b>				
VHBLED-LD1-9-W-UNV-L835-CD1-U	Value High Bay, 9K Lumen, Wide Dist, 120-277V, 3500K, Dim	8677	70	124
VHBLED-LD1-9-W-UNV-L840-CD1-U	Value High Bay, 9K Lumen, Wide Dist, 120-277V, 4000K, Dim	9004	70	129
VHBLED-LD1-9-W-UNV-L850-CD1-U	Value High Bay, 9K Lumen, Wide Dist, 120-277V, 5000K, Dim	9341	70	133
VHBLED-LD1-12-W-UNV-L835-CD1-U	Value High Bay, 12K Lumen, Wide Dist, 120-277V, 3500K, Dim	12084	100	121
VHBLED-LD1-12-W-UNV-L840-CD1-U	Value High Bay, 12K Lumen, Wide Dist, 120-277V, 4000K, Dim	12540	100	125
VHBLED-LD1-12-W-UNV-L850-CD1-U	Value High Bay, 12K Lumen, Wide Dist, 120-277V, 5000K, Dim	13009	100	130
VHBLED-LD1-15-W-UNV-L835-CD1-U	Value High Bay, 15K Lumen, Wide Dist, 120-277V, 3500K, Dim	14576	124	118
VHBLED-LD1-15-W-UNV-L840-CD1-U	Value High Bay, 15K Lumen, Wide Dist, 120-277V, 4000K, Dim	15221	124	123
VHBLED-LD1-15-W-UNV-L850-CD1-U	Value High Bay, 15K Lumen, Wide Dist, 120-277V, 5000K, Dim	15417	124	124
VHBLED-LD1-18-W-UNV-L835-CD1-U	Value High Bay, 18K Lumen, Wide Dist, 120-277V, 3500K, Dim	17894	160	112
VHBLED-LD1-18-W-UNV-L840-CD1-U	Value High Bay, 18K Lumen, Wide Dist, 120-277V, 4000K, Dim	18568	160	116
VHBLED-LD1-18-W-UNV-L850-CD1-U	Value High Bay, 18K Lumen, Wide Dist, 120-277V, 5000K, Dim	19263	160	120
VHBLED-LD1-24-W-UNV-L835-CD1-U	Value High Bay, 24K Lumen, Wide Dist, 120-277V, 3500K, Dim	22603	213	106
VHBLED-LD1-24-W-UNV-L840-CD1-U	Value High Bay, 24K Lumen, Wide Dist, 120-277V, 4000K, Dim	23604	213	111
VHBLED-LD1-24-W-UNV-L850-CD1-U	Value High Bay, 24K Lumen, Wide Dist, 120-277V, 5000K, Dim	23908	213	112

## Energy and Performance Data

### Lumen Maintenance

Ambient Temperature	TM-21 Lumen Maintenance (60,000 hours)	Theoretical L70 (Hours)
40°C	> 83%	> 114,000

### Ambient Ratings

Lumen Package	Ambient Rating	EM Battery (Remote)
VHBLED-LD1-9	40°C	40°C
VHBLED-LD1-12	40°C	40°C
VHBLED-LD1-15	40°C	40°C
VHBLED-LD1-18	40°C	40°C
VHBLED-LD1-24	40°C	40°C

### Shipping Data

Catalog No.	Wt.
VHBLED-LD1-9	15 lbs.
VHBLED-LD1-12	15 lbs.
VHBLED-LD1-15	15 lbs.
VHBLED-LD1-18	15 lbs.
VHBLED-LD1-24	15 lbs.

## Modular F-Bay Power Supply Option

Cooper Lighting's F-Bay Modular Power Supply option is available for use with all F-Bay products. The modular power supply allows external fixture access for safe and easy servicing. There is no need to remove lamps or reflectors to disconnect fixture power with F-Bay Modular Power Supply. Access to the individual fixture's power supply allows servicing without turning off all the fixtures, disrupting occupants. F-Bay Modular Power Supply is a time saver in installation – **simply plug & power.**



1. Modular Power Supply Receptacle supplied mounted into fixture Access Plate
2. Modular Power Cord & Plugs in 120, 277, 347, & 480V configurations for easy plug & power into existing supply

No internal fixture access required for installation or disconnecting power

### Code Compliance

- UL/cUL Certified for Make/Break under load (UL2549)
- Meets NEC requirements for ballast disconnect (NEC 410.73G)
- Allows for addition of Occupancy Sensor without hard connections
- Receptacles complete with insulating/dust cap

## Control Systems

- WaveLinx
- DLVP
- LumaWatt Pro
- iLumin Plus
- VividTune

## We make connections work

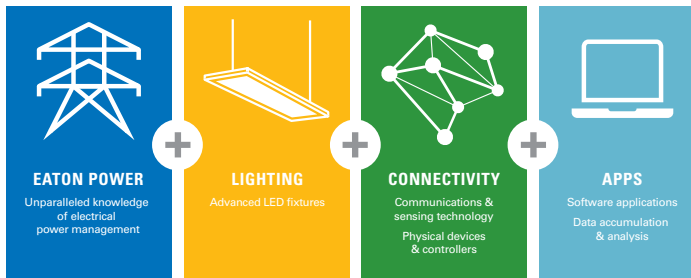

## Systems comparison chart

Eaton provides many lighting system solutions designed to satisfy code requirements and meet the unique needs of any project.

	Distributed Low-Voltage Power System	WaveLinx	LumaWatt Pro
Space type	Interior	Interior/Outdoor	Any
Stand-alone or Network	Stand-alone	Both	Network
Need-based feature progression			
Basic compliance only	●	●	●
Occupancy sensing	●	●	●
Daylight harvesting	●	●	●
Zone control	●	●	●
Scheduling	●	●	●
0-10V dimming	●	●	●
Individual fixture control	●	●	●
Retrofit+Building Integration	●	●	●
Total wireless connectivity		●	●
AV integration		●	●
BMS integration		●	●
UI options (touchscreen, apps, etc.)		●	●
Enterprise level building integration		●	●
Facility management & tools		●	●
Floor plan & reporting tools			●
Value-added services			●
Asset tracking			●
API integration		●	●
Analytics/higher problem solving			●



## Integrated Sensor

The VHB with Integrated Sensor technology provides automatic energy savings without sacrificing performance. Traditionally, these types of energy savings required coordination between the luminaire and a lighting control system.

The VHB delivers superior lighting with integrated occupancy and daylighting controls.

Capture the benefits of traditional lighting controls, without complicated coverage planning or special wiring.

Ideal for new construction or retrofit, the VHB delivers automatic ON to an energy saving light level, while ensuring lighting is turned OFF when the space is unoccupied.

The integral daylight sensor reduces the need for special daylight zone planning. Each luminaire will automatically adjust the light level based on reflected light beneath the sensor in a closed loop method.

Occupied daylight light levels and unoccupied light levels can be adjusted using the integrated sensor

programming remote (Catalog Number: ISHH-01). The integrated sensor personal remote (Catalog Number: ISHH-02) provides code compliant manual raise, lower, ON, OFF control.

The VHB with Integrated Sensor is easy to install with no special wiring and ensures energy savings out-of-the-box with default control settings.

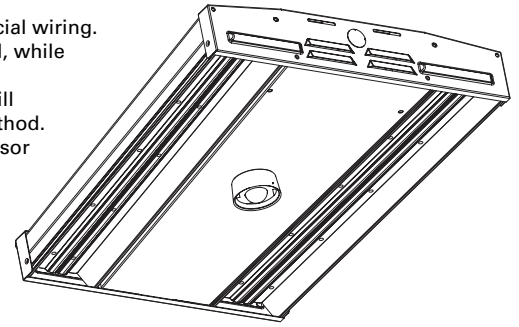

### How it works:

- As the user enters the space controlled by the integral sensor, the lighting turns ON to the default daylight level.
- Lighting will remain at that the daylight level until the space is unoccupied. This will start the occupancy timeout period (default 20 minutes).
- If the space remains unoccupied for half of the timeout period, the lighting will automatically reduce to the Energy Saver light level. This adjustable light level is typically half of the occupied daylight level.
- At the end of the timeout period the lighting will go to the unoccupied light level. This adjustable light level uses the OFF default setting.

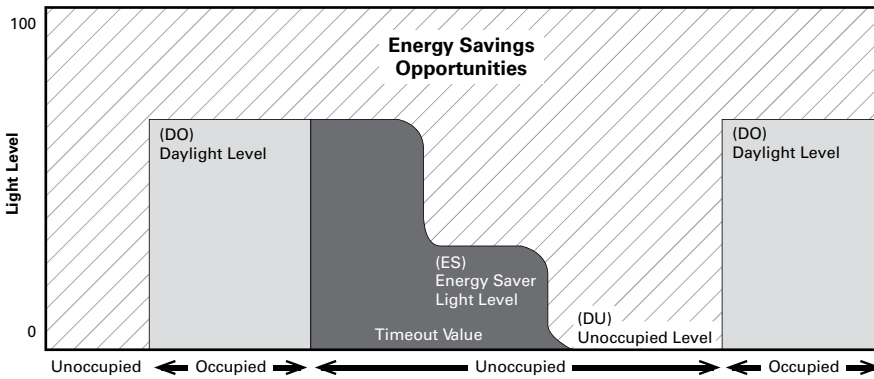

Default daylight harvesting set using 36,000 lumen unit at 30 ft. mounting height, 20 ft. spacing for 50 footcandles.

### SVPD3 Coverage Pattern

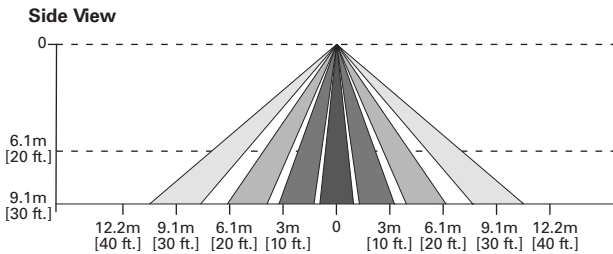

### Optional Remote Controls



ISHH-01 Remote



ISHH-02 Remote