



**MILBANK**<sup>®</sup>  
ENERGY AT WORK



# Western Region

*Product Catalog*



# Milbank Overview

*Energy At Work since 1927*

Milbank designs and manufactures electrical solutions that move and manage power for the residential, commercial, industrial, utility and transportation sectors. With 90 years of expertise in electrical engineering design and manufacturing, Milbank's portfolio includes metering equipment, enclosures and enclosed controls. Founded in 1927, Milbank is a family-owned, American manufacturer headquartered in Kansas City, Mo. For more information, please visit [milbankworks.com](http://milbankworks.com).

---

## METERING

---



As a market leader in electrical metering equipment, Milbank has set the standard for quality since 1927. Hundreds of configurations are available, including many sizes, knockout configurations, terminal configurations, bypass options, hubs, locks and connectors. Milbank has the socket you need with thousands of active products to meet your utility's requirements.

---

## ENCLOSURES

---



Milbank's line of enclosures include commercial junction boxes, panel mount enclosures, transformer cabinets, wireway, trough and industrial panel mount and push-button enclosures. Built with high-quality craftsmanship and materials which meet or exceed industry standards, Milbank enclosures are made to protect controls and equipment from dust, dirt and other harmful elements found in a wide variety of environments.

---

## ENCLOSED CONTROLS

---



Milbank doesn't just build empty enclosures. We can deliver the entire package, complete with custom control equipment built to your exact specifications by our engineers. Milbank commercial pedestals are an attractive, secure, easy to install and cost-effective solution when underground remote site power distribution and control equipment is required, replacing unsightly and inefficient strut and backboard structures. Milbank's manual and automatic transfer switches are durable, easy to install and compatible with most generators.



Please consult serving utility for their requirements prior to ordering or installing, as specifications and approvals vary by utility, and may require local electrical inspector approval. All installations must be installed by a licensed electrician and must comply with all national and local codes, laws and regulations. Milbank reserves the right to make changes in specifications and features shown without notice or obligation.

## Air Conditioner Disconnects

---

|  |   |
|--|---|
| 30-60 amp AC disconnects .....                         | 7 |
| 60 amp AC disconnect with 20 amp GFCI receptacle ..... | 8 |
| Hot tub disconnects.....                               | 9 |

## Single Position Sockets

---

|  |       |
|--|-------|
| 30-100 amp, 4 terminal, ring type .....                            | 10    |
| 100 amp, solar sockets, 4 terminal .....                           | 11    |
| 125 amp, 4 & 7 terminal, ringless & ring type .....                | 12    |
| 200 amp, 4 & 7 terminal, ringless & ring type .....                | 13-14 |
| 200 amp, 4 terminal, ring type .....                               | 15    |
| 125-200 amp, 4 & 7 terminal, ring type, link bypass .....          | 16    |
| 200 amp, 4 & 5 terminal, lever bypass, ringless, lever bypass..... | 17    |
| 125-200 amp, 4,5 & 7 terminal, ringless, lever bypass .....        | 18-19 |
| 320 amp, 4 terminal, lever & non-lever bypass, ringless.....       | 20    |
| 320 amp, 4 terminal, link bypass, ring type.....                   | 21    |
| 320 amp, 7 terminal, lever bypass, ringless.....                   | 22    |
| 100-200 amp, 4 terminal, main breaker.....                         | 23    |

## Meter Mains

---

|  |       |
|--|-------|
| 200 amp, 4 & 7 terminal, ring type.....                        | 24    |
| 100-200 amp, 4 & 5 terminal, ringless & ring type .....        | 25    |
| 400-320 amp continuous, 4 terminal, ringless & ring type ..... | 26-30 |

## Safety Sockets

---

|   |       |
|---|-------|
| 100 & 200 amp, 4, 5 & 7 terminal, ring type, test block bypass..... | 31-32 |
| 100 amp, 4, 5 & 7 terminal, ring type, test block bypass .....      | 33-35 |
| 200 amp, 4, 5 & 7 terminal, ring type, test block bypass .....      | 36-39 |
| 100 & 200 amp, all-in-one series, test block bypass .....           | 40-41 |
| Replacement Parts.....  | 42-44 |

## Underground Termination Boxes

---

|                               |       |
|-------------------------------|-------|
| 100-800 amp.....              | 45    |
| Bussed gutters, type 3R ..... | 46-47 |

## Multi-Position Sockets

---

|   |       |
|---|-------|
| 100-125 amp, 4 terminal, ringless .....               | 48    |
| 200 amp, 4 terminal, ringless.....                    | 49    |
| 125 & 200 amp, 4 terminal, meter mains, ringless..... | 50-53 |

Please consult serving utility for their requirements prior to ordering or installing, as specifications and approvals vary by utility, and may require local electrical inspector approval. All installations must be installed by a licensed electrician and must comply with all national and local codes, laws and regulations. Milbank reserves the right to make changes in specifications and features shown without notice or obligation.



**Miscellaneous**

|  |       |
|--|-------|
| Current transformer enclosures .....     | 54-55 |
| Current transformer test switches .....  | 56-57 |
| Test switch worksheet .....              | 58    |
| Current transformer cabinets.....        | 59-62 |
| Service pedestals, mobile home .....     | 63-64 |
| Power pedestals .....                    | 65    |
| Replacement parts.....                   | 66-67 |
| Mobile home pedestals.....               | 68    |
| Service pedestals.....                   | 69-74 |
| Temporary power .....                    | 75-79 |
| Surface mount power .....                | 80    |
| Power outlet pedestals.....              | 81    |
| Replacement receptacle plates.....       | 82    |
| Lighting accessories.....                | 83-84 |
| Telecom and pedestal accessories.....    | 85    |
| Pedestal mounting accessories .....      | 86    |
| Metering and receptacle accessories..... | 87    |
| Replacement parts and accessories .....  | 88-89 |
| Recreational vehicle products.....       | 90-91 |
| Dry type transformers.....               | 92    |

**Commercial Pedestals**

|   |         |
|---|---------|
| Commercial pedestal overview.....                                       | 93-94   |
| 100-200 amp, 4 terminal ringless & ring type.....                       | 95      |
| 100-200 amp, Switch load center, 4 terminal, ringless & ring type ..... | 96      |
| 400 amp, class 320 4 terminal, ringless & ring type .....               | 97      |
| 100 amp, irrigation, 4 terminal, ring type.....                         | 98      |
| Battery backup series .....   | 99      |
| Power transfer series .....   | 100     |
| CT metered series.....  | 101     |
| Slim line series .....  | 102     |
| Commercial pedestal accessories .....                                   | 103     |
| Commercial pedestal reference information.....                          | 104-113 |

**Miscellaneous**

|  |         |
|--|---------|
| Commercial & industrial enclosures ..... | 114     |
| Accessories .....                        | 115-119 |
| Reference information .....              | 120-123 |
| Index.....                               | 124-128 |



Please consult serving utility for their requirements prior to ordering or installing, as specifications and approvals vary by utility, and may require local electrical inspector approval. All installations must be installed by a licensed electrician and must comply with all national and local codes, laws and regulations. Milbank reserves the right to make changes in specifications and features shown without notice or obligation.

# Catalog Number Logic

How our product catalog numbers are derived

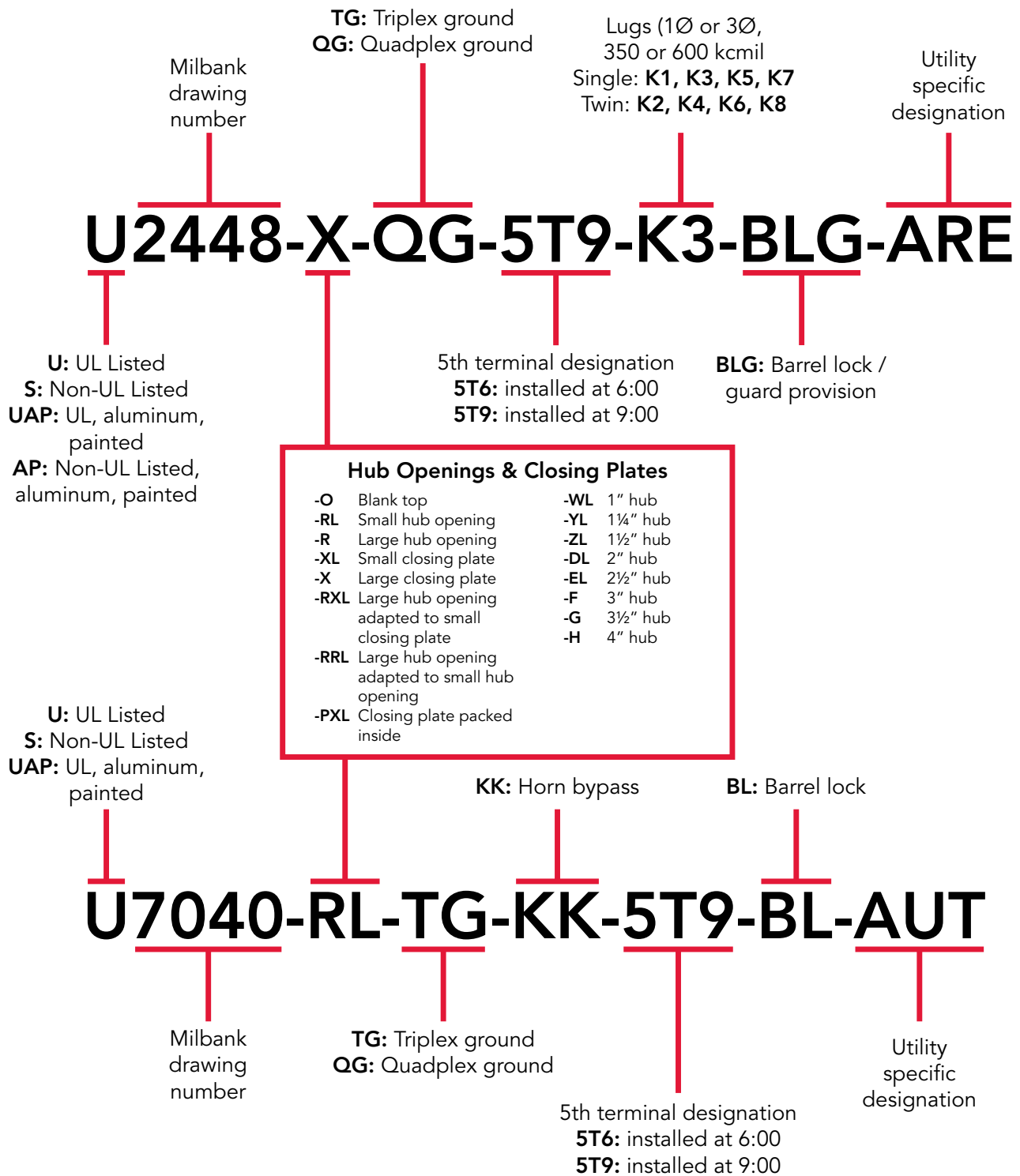

Please consult serving utility for their requirements prior to ordering or installing, as specifications and approvals vary by utility, and may require local electrical inspector approval. All installations must be installed by a licensed electrician and must comply with all national and local codes, laws and regulations. Milbank reserves the right to make changes in specifications and features shown without notice or obligation.



| Catalog Number    | EUSERC Drawing Number | Catalog Page | Catalog Number | EUSERC Drawing Number | Catalog Page | Catalog Number    | EUSERC Drawing Number | Catalog Page |
|-------------------|-----------------------|--------------|----------------|-----------------------|--------------|-------------------|-----------------------|--------------|
| U3574-RL-200      | 301                   | 24           | 215MTB-P48     | 305A, 311             | 35           | PB-034            | 343                   | 45           |
| U3577-RL-200      | 301                   | 24           | 217MTB-P48     | 305A, 311             | 35           | PB-034-NK         | 343                   | 45           |
| U3584-O-200       | 301                   | 24           | U214MTB-P48    | 305A, 311             | 35           | PB-038            | 343                   | 45           |
| U3597-O-200       | 301                   | 24           | U215MTB-P48    | 305A, 311             | 35           | U3320-R           | 313                   | 62           |
| U4015-O           | 301A                  | 14           | U217MTB-P48    | 305A, 311             | 35           | MPRV-BLANK-78     | 307                   | 63           |
| UF4015-KO         | 301A                  | 15           | 224MTB         | 305A, 311             | 36           | MPRV-BLANK-78-R5T | 307                   | 63           |
| U3548-X           | 302B                  | 21           | 225MTB         | 305A, 311             | 36           | MPRV-100-78       | 307                   | 63           |
| M400-UG-APS-F     | 302A                  | 28           | 227MTB         | 305A, 311             | 37           | MPRV-100-MB-78    | 307                   | 63           |
| M400-UG-APS-F-BS  | 302                   | 28           | U224MTB        | 305A, 311             | 36           | MPRV-50-78        | 307                   | 63           |
| M400-UG-APS-P     | 302A                  | 28           | U225MTB        | 305A, 311             | 36           | MPRV-503020GR-78  | 307                   | 63           |
| M400-UG-APS-LC    | 302A                  | 28           | U227MTB        | 305A, 311             | 36           | MPAP-BLANK-78     | 307                   | 64           |
| M400-UG-APS-LC-BS | 302A                  | 28           | U224MTB        | 305A, 311             | 36           | MPAP-BLANK-78R    | 307                   | 64           |
| U3251-O-200-CB    | 302                   | 28           | U225MTB        | 305A, 311             | 36           | MPAP-100-78       | 307                   | 64           |
| M401-UG           | 302A                  | 29           | U227MTB        | 305A, 311             | 36           | MPAP-100-MB-78    | 307                   | 64           |
| M401-UG-BS        | 302                   | 29           | 224MTB/22      | 305A, 311             | 37           | MPAP-200-78       | 307                   | 64           |
| M404-UG-LC        | 302A                  | 30           | 227MTB/22      | 305A, 311             | 37           | MPAP-200-MB-78    | 307                   | 64           |
| M404-UG-LC-BS     | 302                   | 30           | U224MTB/22     | 305A, 311             | 37           | MPAP-200-20GR-78  | 307                   | 64           |
| 114TB             | 304, 311              | 31           | U227MTB/22     | 305A, 311             | 37           | MPAPD-BLANK-78    | 307                   | 64           |
| 115TB             | 304, 311              | 31           | 227MTB-48      | 305A, 311             | 38           | MPAPD-BLANK-78R   | 307                   | 64           |
| 117TB             | 304, 311              | 31           | U224MTB-48     | 305A, 311             | 38           | U3322-R           | 313                   | 62           |
| 124TB             | 305, 311              | 31           | U227MTB-48     | 305A, 311             | 38           | U3355-R           | 313                   | 62           |
| 125TB             | 305, 311              | 31           | 224MTB-P       | 305A, 311             | 39           | U3340-O           | 314                   | 62           |
| 127TB             | 305, 311              | 31           | 225MTB-P       | 305A, 311             | 39           | U3342-O           | 314                   | 62           |
| 214MTB            | 305A, 311             | 32           | 227MTB-P       | 305A, 311             | 39           | U3565-O           | 314                   | 62           |
| 215MTB            | 305A, 311             | 32           | U224MTB-P      | 305A, 311             | 39           | CT244811-SC       | 316, 317              | 61           |
| 217MTB            | 305A, 311             | 32           | U227MTB-P      | 305A, 311             | 39           | CT364811-SC       | 316, 317, 318         | 61           |
| U214MTB           | 305A, 311             | 32           | 224MTB-P48     | 305A, 311             | 39           | CT364814-SC       | 316, 317, 318         | 61           |
| U215MTB           | 305A, 311             | 32           | 225MTB-P48     | 305A, 311             | 39           | CT484811-SC       | 316, 317              | 61           |
| U217MTB           | 305A, 311             | 32           | 227MTB-P48     | 305A, 311             | 39           | CT244811-HC       | 316, 317              | 61           |
| 214MTB/22         | 305A, 311             | 33           | U224MTB-P48    | 305A, 311             | 39           | CT304811-HC       | 316, 317              | 61           |
| 217MTB/22         | 305A, 311             | 33           | U227MTB-P48    | 305A, 311             | 39           | CT364811-HC       | 316, 317, 318         | 61           |
| U214MTB/22        | 305A, 311             | 33           | U214MTBL       | 305A, 311             | 40           | CT484811-HC       | 316, 317, 318         | 61           |
| U217MTB/22        | 305A, 311             | 33           | U214MTBPL      | 305A, 311             | 40           | CT484814-HC       | 316, 317, 318         | 61           |
| 214MTB-48         | 305A, 311             | 34           | U217MTBL       | 305A, 311             | 40           | K4903             | 328B                  | 60           |
| 215MTB-48         | 305A, 311             | 34           | U217MTBPL      | 305A, 311             | 40           | K4904             | 329B                  | 60           |
| 217MTB-48         | 305A, 311             | 34           | U224MTBL       | 305A, 311             | 40           | K4722             | 329B                  | 60           |
| U214MTB-48        | 305A, 311             | 34           | U224MTBPL      | 305A, 311             | 40           | K4729             | 328B                  | 60           |
| U215MTB-48        | 305A, 311             | 34           | U227MTBL       | 305A, 311             | 40           | K4797             | 328A                  | 60           |
| U217MTB-48        | 305A, 311             | 34           | U227MTBPL      | 305A, 311             | 40           | K4798             | 339A                  | 60           |
| 214MTB-P          | 305A, 311             | 35           | PB-011         | 305A, 311             | 45           | UC3435-XL         | 339                   | 54           |
| 215MTB-P          | 305A, 311             | 35           | PB-012         | 343A                  | 45           | UC3436-XL         | 339                   | 54           |
| 217MTB-P          | 305A, 311             | 35           | PB-014         | 343                   | 45           | UC3438-XL         | 339                   | 54           |
| U214MTB-P         | 305A, 311             | 35           | PB-014-NK      | 343                   | 45           | UC3433-XL         | 339                   | 54           |
| U215MTB-P         | 305A, 311             | 35           | PB-018         | 343                   | 45           | UC3434-XL         | 339                   | 54           |
| U217MTB-P         | 305A, 311             | 35           | PB-034-NK      | 343                   | 45           |                   |                       |              |
| 214MTB-P48        | 305A, 311             | 35           | PB-032         | 343A                  | 45           |                   |                       |              |



Please consult serving utility for their requirements prior to ordering or installing, as specifications and approvals vary by utility, and may require local electrical inspector approval. All installations must be installed by a licensed electrician and must comply with all national and local codes, laws and regulations. Milbank reserves the right to make changes in specifications and features shown without notice or obligation.

# Air Conditioner Disconnects

30-60 Amp | Fusible & Non-Fusible



**U3802**

**U3812**

**U3832**

Milbank's air conditioner disconnect has a removable hinged cover for ease of installation. Our compact design meets NEC wiring space requirements and also complies with NEC article 440-14. For safe working conditions, our disconnect pullers may be removed and reinstalled in the OFF position. Additionally, padlock provisions are included on the front cover. As with other Milbank products, our enclosure is constructed of G90U galvanized steel and electrostatically finished with an attractive, light gray, baked powder coating. Our epoxy/polyester resin blend offers a finish that is both durable and fade-resistant.

## 30-60 Amp | 1Ø 240 VAC | Air Conditioner Disconnects

| Catalog Number | Amp | Type        | Max H.P. | Weight (lbs.) | Line/Load Wire Range |        | Ground Wire Range CU/AL | Dimensions |    |    | Wire Rating |         |
|----------------|-----|-------------|----------|---------------|----------------------|--------|-------------------------|------------|----|----|-------------|---------|
|                |     |             |          |               | CU                   | AL     |                         | D"         | W" | H" | CU °C       | AL °C   |
| <b>U3802</b>   | 60  | Non-Fusible | 10       | 3.25          | #14-#2               | #12-#2 | #14-4                   | 2½         | 5  | 7½ | 60°/75°     | 60°/75° |
| <b>U3812</b>   | 60  | Non-Auto    | 10       | 3.25          | #14-#2               | #12-#2 | #14-4                   | 2½         | 5  | 7½ | 60°/75°     | 60°/75° |
| <b>U3832</b>   | 30  | Fusible     | 3        | 2.5           | #14-#3               | #14-#3 | #14-3                   | 2½         | 5  | 7  | 60°/75°     | 60°/75° |
| <b>U3862</b>   | 60  | Fusible     | 10       | 3.3           | #14-#3               | #14-#3 | #14-3                   | 2½         | 5  | 9  | 60°/75°     | 60°/75° |

### Notes

- UL listed as Enclosed Pullout Switch
- Type 3R rain resistant
- One-inch concentric knockouts

Please consult serving utility for their requirements prior to ordering or installing, as specifications and approvals vary by utility, and may require local electrical inspector approval. All installations must be installed by a licensed electrician and must comply with all national and local codes, laws and regulations. Milbank reserves the right to make changes in specifications and features shown without notice or obligation.



# Air Conditioner Disconnects

## 60 Amp | With 20 Amp GFCI Receptacle



**U3822-20GWR**

### Specifications

- Meets NEC #210.63 requirements
- UL listed as Power Outlet
- Type 3R enclosure
- In-use cover\*
- Duplex ground connector
- 1" concentric knockouts
- 1Ø, 240 volt
- 60 amp, non-fused
- 20 amp GFCI receptacle
- Reset/test button
- Weather and tamper resistant
- Meets NEC #406.8 requirements

### 60 Amp | 1Ø, 240 VAC | Air Conditioner Disconnect with GFCI Receptacle

| Catalog Number | Type        | Max H.P. | Weight (lbs.) | Line/Load Wire Range |        | Ground Wire Range CU/AL | Dimensions      |                 |                 | Wire Rating |         |
|----------------|-------------|----------|---------------|----------------------|--------|-------------------------|-----------------|-----------------|-----------------|-------------|---------|
|                |             |          |               | CU                   | AL     |                         | D"              | W"              | H"              | CU °C       | AL °C   |
| U3822-20GWR    | Non-Fusible | 10       | 6             | #14-#2               | #12-#2 | #14-4                   | 4 $\frac{1}{2}$ | 5 $\frac{1}{4}$ | 7 $\frac{1}{2}$ | 60°/75°     | 60°/75° |

### Notes

- **Disconnect Pullouts:** To ensure the safest conditions, Milbank disconnect pullouts are reversible so they may be reinstalled in the OFF position.
- **Padlock Provision:** All units are designed with a padlock provision on the cover for security.
- **\*In-Use Cover:** Cover is rated as an in-use cover (cover may be closed with cords plugged into receptacle).



# Hot Tub Disconnects

## Type 3R Enclosures



**U4881-O-50GB**



**U4881-O-60GB**

### Specifications

- 240 volt ground fault protection
- UL listed, Type 3R rain resistant enclosure
- 2-pole, 50 amp GFCI breaker protection
- Compact size
- Three or four wire installation
- 1Ø, 120/240 VAC
- Standard package of 12
- Two extra one-pole breaker spaces
- 100 amp overall rating
- Easy to install

### 100 Amp | Hot Tub Disconnect or Sub Panel Breaker Enclosure | Type 3R

| Catalog Number      | Breaker Amp | Type              | Weight (lbs.) | Line/Load Wire Range |         | Ground Wire Range CU/AL | Dimensions |    |    |
|---------------------|-------------|-------------------|---------------|----------------------|---------|-------------------------|------------|----|----|
|                     |             |                   |               | CU                   | AL      |                         | D"         | W" | H" |
| <b>U4881-O</b>      | —           | Breaker Provision | 7             | #14-1/0              | #14-1/0 | #14-1/0                 | 3¾         | 7½ | 8½ |
| <b>U4881-O-50GB</b> | 50          | Breaker           | 8             | #14-1/0              | #14-1/0 | #14-1/0                 | 3¾         | 7½ | 8½ |
| <b>U4881-O-60GB</b> | 60          | Breaker           | 8             | #14-1/0              | #14-1/0 | #14-1/0                 | 3¾         | 7½ | 8½ |

Please consult serving utility for their requirements prior to ordering or installing, as specifications and approvals vary by utility, and may require local electrical inspector approval. All installations must be installed by a licensed electrician and must comply with all national and local codes, laws and regulations. Milbank reserves the right to make changes in specifications and features shown without notice or obligation.



# Single Position Sockets

30-100 Amp | 4 Terminal | Ring Type

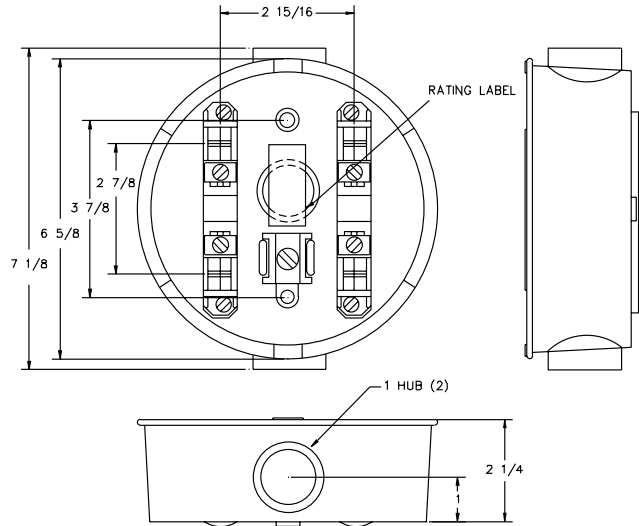

## Applications

100 amp max rated is ideal for use on:

- Temporary service
- Outdoor advertising
- Small customer service
- Other low amp requirements

## 30-100 Amp | 4 Terminal | Economy Cast Socket | Ring Type | Single Position

| Catalog Number | Terminal | Service | Hub               | Connectors CU/AL |         | Quantity Per Package | Concentric Knockouts |
|----------------|----------|---------|-------------------|------------------|---------|----------------------|----------------------|
|                |          |         |                   | Line             | Load    |                      |                      |
| AP2300-03      | 4        | OH/UG   | 1"                | #12-1/0          | #12-1/0 | 12                   | $\frac{3}{4}$ ", 1"  |
| AP2300-04      | 4        | OH/UG   | 1 $\frac{1}{4}$ " | #12-1/0          | #12-1/0 | 12                   | $\frac{3}{4}$ ", 1"  |

## Notes

- **Fifth & Sixth Terminal:** Contact factory.
- **Sealing Ring:** Supplied with a snap action sealing ring.
- **Hub:** Units supplied with cast in hub on top and bottom. Consult factory for availability of other hub sizes.
- **Bypass:** Also available with auto bypass. Contact factory.



Please consult serving utility for their requirements prior to ordering or installing, as specifications and approvals vary by utility, and may require local electrical inspector approval. All installations must be installed by a licensed electrician and must comply with all national and local codes, laws and regulations. Milbank reserves the right to make changes in specifications and features shown without notice or obligation.

# Single Position Solar Sockets

100 Amp | 4 Terminal | 600 VAC

**1 1**  
100 AMP  
SINGLE  
POSITION  
SOCKETS



U5934-XL-BLG



U6087-XL-INS



U4175-RL-BLG

## 100 Amp | 4 Terminal | Residential Solar Sockets | Standard Neutral

| Catalog Number | Socket Type | Service | Hub  | Connectors CU/AL |         | Dimensions                     |    |                                | Knockouts |                               |                               |                               |
|----------------|-------------|---------|------|------------------|---------|--------------------------------|----|--------------------------------|-----------|-------------------------------|-------------------------------|-------------------------------|
|                |             |         |      | Line             | Load    | D"                             | W" | H"                             | 1         | 2                             | 3                             | 4                             |
| U4175-RL-BLG*  | Ringless    | OH/UG   | H.O. | #12-1/0          | #12-1/0 | 3 <sup>5</sup> / <sub>16</sub> | 8  | 11 <sup>1</sup> / <sub>2</sub> | 2         | 1 <sup>1</sup> / <sub>2</sub> | 1 <sup>1</sup> / <sub>4</sub> | 1 <sup>1</sup> / <sub>4</sub> |
| U6087-XL*      | Ring Type   | OH/UG   | C.P. | #12-1/0          | #12-1/0 | 3 <sup>5</sup> / <sub>16</sub> | 8  | 11 <sup>1</sup> / <sub>2</sub> | 2         | 1 <sup>1</sup> / <sub>2</sub> | 1 <sup>1</sup> / <sub>4</sub> | 1 <sup>1</sup> / <sub>4</sub> |
| U6087-XL-INS*  | Ring type   | OH/UG   | C.P. | #12-1/0          | #12-1/0 | 3 <sup>5</sup> / <sub>16</sub> | 8  | 11 <sup>1</sup> / <sub>2</sub> | 2         | 1 <sup>1</sup> / <sub>2</sub> | 1 <sup>1</sup> / <sub>4</sub> | 1 <sup>1</sup> / <sub>4</sub> |

## 100 Amp | 4 Terminal | Residential Solar Sockets | Integral Isolated Neutral Option

| Catalog Number | Socket Type | Service | Hub  | Connectors CU/AL |         | Dimensions                     |    |                                | Knockouts |                               |                               |                               |
|----------------|-------------|---------|------|------------------|---------|--------------------------------|----|--------------------------------|-----------|-------------------------------|-------------------------------|-------------------------------|
|                |             |         |      | Line             | Load    | D"                             | W" | H"                             | 1         | 2                             | 3                             | 4                             |
| U5929-XL-INS   | Ring Type   | OH/UG   | C.P. | #12-1/0          | #12-1/0 | 3 <sup>5</sup> / <sub>16</sub> | 8  | 11 <sup>1</sup> / <sub>2</sub> | 2         | 1 <sup>1</sup> / <sub>2</sub> | 1 <sup>1</sup> / <sub>4</sub> | 1 <sup>1</sup> / <sub>4</sub> |
| U5934-XL-BLG   | Ringless    | OH/UG   | C.P. | #12-1/0          | #12-1/0 | 3 <sup>5</sup> / <sub>16</sub> | 8  | 11 <sup>1</sup> / <sub>2</sub> | 2         | 1 <sup>1</sup> / <sub>2</sub> | 1 <sup>1</sup> / <sub>4</sub> | 1 <sup>1</sup> / <sub>4</sub> |

### Notes

- **BLG:** Barrel lock guard knockout provision.
- **Hubs:** Accepts standard meter socket hubs.
- **Construction:** Units are Type 3R for durable outdoor use, lockable and sealable.
- **\*Application:** The standard bonded neutral units are applicable in areas where utility does not require an isolated neutral.

Please consult serving utility for their requirements prior to ordering or installing, as specifications and approvals vary by utility, and may require local electrical inspector approval. All installations must be installed by a licensed electrician and must comply with all national and local codes, laws and regulations. Milbank reserves the right to make changes in specifications and features shown without notice or obligation.



# 12

125 AMP  
SINGLE  
POSITION  
SOCKETS

# Single Position Sockets

125 Amp | 4 & 7 Terminal | Ringless & Ring Type



U7487-RL

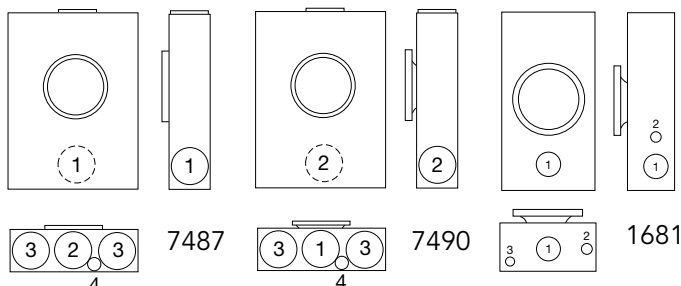

U7490-O

## 125 Amp | 4 Terminal | Ringless | Single Position

| Catalog Number | Terminal | Service | Hub   | Connectors CU/AL |        | Bypass | Dimensions                     |    |                                | Knockouts                     |   |                               |                               |
|----------------|----------|---------|-------|------------------|--------|--------|--------------------------------|----|--------------------------------|-------------------------------|---|-------------------------------|-------------------------------|
|                |          |         |       | Line             | Load   |        | D"                             | W" | H"                             | 1                             | 2 | 3                             | 4                             |
| U7487-O        | 4        | UG      | Blank | #6-2/0           | #6-2/0 | None   | 3 <sup>5</sup> / <sub>16</sub> | 8  | 11 <sup>1</sup> / <sub>2</sub> | 1 <sup>1</sup> / <sub>2</sub> | 2 | 1 <sup>1</sup> / <sub>4</sub> | 1 <sup>1</sup> / <sub>4</sub> |
| U7487-RL       | 4        | OH/UG   | H.O.  | #6-2/0           | #6-2/0 | None   | 3 <sup>5</sup> / <sub>16</sub> | 8  | 11 <sup>1</sup> / <sub>2</sub> | 1 <sup>1</sup> / <sub>2</sub> | 2 | 1 <sup>1</sup> / <sub>4</sub> | 1 <sup>1</sup> / <sub>4</sub> |

## 125 Amp | 4 Terminal | Ring Type | Single Position

| Catalog Number | Terminal | Service | Hub   | Connectors CU/AL |        | Bypass | Dimensions                     |    |                                | Knockouts                     |                               |   |                               |   |                               |
|----------------|----------|---------|-------|------------------|--------|--------|--------------------------------|----|--------------------------------|-------------------------------|-------------------------------|---|-------------------------------|---|-------------------------------|
|                |          |         |       | Line             | Load   |        | D"                             | W" | H"                             | 1                             | 2                             | 3 | 4                             | 5 | 6                             |
| U7490-O        | 4        | UG      | Blank | #6-2/0           | #6-2/0 | None   | 3 <sup>5</sup> / <sub>16</sub> | 8  | 11 <sup>1</sup> / <sub>2</sub> | 1 <sup>1</sup> / <sub>2</sub> | 1 <sup>1</sup> / <sub>2</sub> | 2 | 1 <sup>1</sup> / <sub>2</sub> | — | 1 <sup>1</sup> / <sub>4</sub> |
| U7490-RL       | 4        | OH/UG   | H.O.  | #6-2/0           | #6-2/0 | None   | 3 <sup>5</sup> / <sub>16</sub> | 8  | 11 <sup>1</sup> / <sub>2</sub> | 1 <sup>1</sup> / <sub>2</sub> | 1 <sup>1</sup> / <sub>2</sub> | 2 | 1 <sup>1</sup> / <sub>2</sub> | — | 1 <sup>1</sup> / <sub>4</sub> |

## 125 Amp | 7 Terminal | Ring Type | Single Position

| Catalog Number | Terminal | Service | Hub  | Connectors CU/AL |        | Bypass | Dimensions                     |    |                                | Knockouts |                                |                               |   |   |                                |
|----------------|----------|---------|------|------------------|--------|--------|--------------------------------|----|--------------------------------|-----------|--------------------------------|-------------------------------|---|---|--------------------------------|
|                |          |         |      | Line             | Load   |        | D"                             | W" | H"                             | 1         | 2                              | 3                             | 4 | 5   | 6                              |
| U1681-RL       | 7        | OH      | H.O. | #6-2/0           | #6-2/0 | None   | 4 <sup>7</sup> / <sub>16</sub> | 10 | 18 <sup>1</sup> / <sub>2</sub> | 2         | 3 <sup>4</sup> / <sub>16</sub> | 1 <sup>1</sup> / <sub>2</sub> | — | 1 <sup>1</sup> / <sub>4</sub> , 1 <sup>1</sup> / <sub>2</sub> | 3 <sup>4</sup> / <sub>16</sub> |

### Notes

- **Fifth Terminal:** For field mounted fifth terminal on the **U7487 & U7490** order catalog number **5T8K2** to fit into round opening at the 9 o'clock position.
- **Hubs:** For proper hub selection see the hub suffix chart on the accessory page.
- **Connectors:** Extruded aluminum connectors are tin plated.
- **Sealing Rings:** Ring type units supplied with an **MR-2** snap action sealing ring as standard.



Please consult serving utility for their requirements prior to ordering or installing, as specifications and approvals vary by utility, and may require local electrical inspector approval. All installations must be installed by a licensed electrician and must comply with all national and local codes, laws and regulations. Milbank reserves the right to make changes in specifications and features shown without notice or obligation.

# Single Position Sockets

200 Amp | 4 Terminal | Ringless

**13**  
200 AMP  
SINGLE  
POSITION  
SOCKETS



U7040-XL-TG



U1060-RL



U1980-O

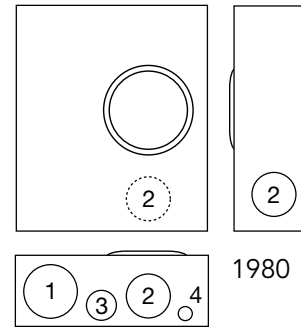
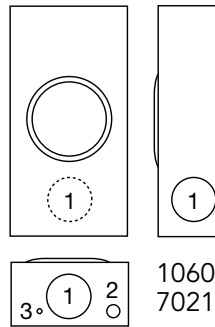
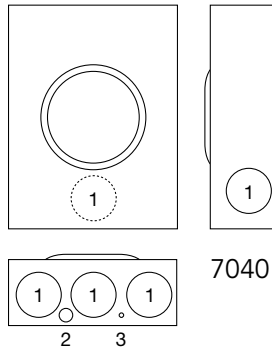

## 200 Amp | 4 Terminal | Ringless | Single Position

| Catalog Number | Terminal | Service | Hub   | Connectors CU/AL |        | Bypass | Dimensions      |    |                  | Knockouts       |                 |                 |                 |                               |               |
|----------------|----------|---------|-------|------------------|--------|--------|-----------------|----|------------------|-----------------|-----------------|-----------------|-----------------|-------------------------------|---------------|
|                |          |         |       | Line             | Load   |        | D"              | W" | H"               | 1               | 2               | 3               | 4               | 5                             | 6             |
| U1060-RL       | 4        | OH      | H.O.  | #2-350           | #2-350 | None   | 4 $\frac{1}{8}$ | 8  | 15 $\frac{1}{2}$ | 2               | $\frac{3}{4}$   | $\frac{1}{4}$   | —               | —                             | $\frac{1}{4}$ |
| U1527-O        | 4        | UG      | Blank | #2-350           | #2-350 | None   | 4 $\frac{1}{8}$ | 11 | 15 $\frac{1}{2}$ | 2               | $\frac{1}{2}$   | $\frac{1}{4}$   | 2 $\frac{1}{2}$ | $\frac{1}{4}$ , $\frac{1}{2}$ | $\frac{1}{4}$ |
| U1980-O        | 4        | UG      | Blank | #6-350           | #6-350 | None   | 4 $\frac{1}{8}$ | 13 | 15 $\frac{1}{2}$ | 3               | 2 $\frac{1}{2}$ | $\frac{1}{4}$   | $\frac{1}{2}$   | —                             | —             |
| U7021-RL-TG    | 4        | OH      | H.O.  | #6-350           | #6-350 | None   | 4 $\frac{1}{8}$ | 8  | 15 $\frac{1}{2}$ | 2 $\frac{1}{2}$ | $\frac{1}{2}$   | $\frac{1}{4}$   | —               | —                             | —             |
| U7040-XL-TG    | 4        | OH/UG   | C.P.  | #6-350           | #6-350 | None   | 4 $\frac{1}{8}$ | 11 | 15 $\frac{1}{2}$ | $\frac{1}{2}$   | $\frac{1}{4}$   | 2 $\frac{1}{2}$ | —               | —                             | —             |
| U7043-XL-TG    | 4        | OH/UG   | C.P.  | #6-350           | #6-350 | None   | 4 $\frac{1}{8}$ | 13 | 15 $\frac{1}{2}$ | 2 $\frac{1}{2}$ | $\frac{1}{2}$   | $\frac{1}{4}$   | —               | —                             | —             |

## Notes

- **Fifth Terminal:** For field mounted fifth terminal order catalog number **K5T** to fit into square opening at the 9 o'clock position.
- **Hubs:** For proper hub selection see the hub suffix chart on accessory page.
- **Connectors:** Extruded aluminum connectors are tin plated.

Please consult serving utility for their requirements prior to ordering or installing, as specifications and approvals vary by utility, and may require local electrical inspector approval. All installations must be installed by a licensed electrician and must comply with all national and local codes, laws and regulations. Milbank reserves the right to make changes in specifications and features shown without notice or obligation.



# 14

200 AMP  
SINGLE  
POSITION  
SOCKETS

# Single Position Sockets

200 Amp | 4 & 7 Terminal | Ring Type



U3328-RXL



U4518-O-W

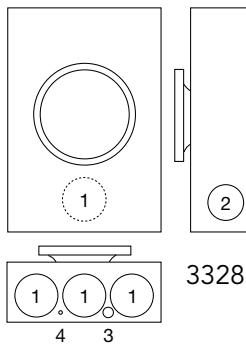

3328

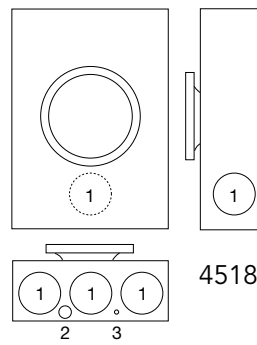

4518

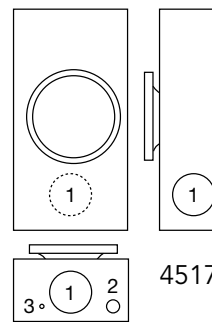

4517

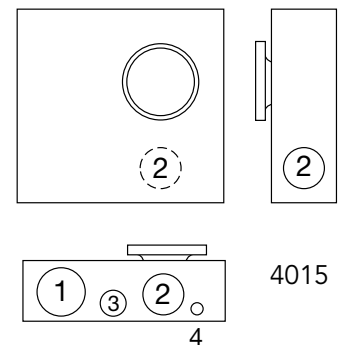

4015

## 200 Amp | Ring Type | Single Position

| Catalog Number | Terminal | Service | Hub   | Connectors CU/AL |        | Bypass | Dimensions |    |     | Knockouts |    |    |   |
|----------------|----------|---------|-------|------------------|--------|--------|------------|----|-----|-----------|----|----|---|
|                |          |         |       | Line             | Load   |        | D"         | W" | H"  | 1         | 2  | 3  | 4 |
| U4517-DL-M4    | 4        | OH      | 2"    | #6-350           | #6-350 | None   | 4½         | 8  | 15½ | 2½        | ½  | ¼  | — |
| U4518-XL-W     | 4        | OH/UG   | C.P.  | #6-350           | #6-350 | None   | 4½         | 11 | 15½ | 2½        | ½  | ¼  | — |
| U4518-O-W      | 4        | UG      | Blank | #6-350           | #6-350 | None   | 4½         | 11 | 15½ | 2½        | ½  | ¼  | — |
| U4015-O        | 4        | UG      | Blank | #6-350           | #6-350 | None   | 6          | 14 | 16¼ | 3         | 2½ | 1½ | ½ |
| U3328-RXL      | 7        | OH/UG   | C.P.  | #6-350           | #6-350 | None   | 4¾         | 13 | 19  | 3         | 2½ | ½  | ¼ |

## Notes

- **Fifth Terminal:** For field mounted fifth terminal order catalog number **K5T** to fit into square opening at the 9 o'clock position.
- **Hubs:** For proper hub selection see the hub suffix chart on accessory page.
- **Connectors:** Extruded aluminum connectors are tin plated.
- **Sealing Rings:** The above ring type units are supplied with a **MR-4** screw type sealing ring as standard.



Please consult serving utility for their requirements prior to ordering or installing, as specifications and approvals vary by utility, and may require local electrical inspector approval. All installations must be installed by a licensed electrician and must comply with all national and local codes, laws and regulations. Milbank reserves the right to make changes in specifications and features shown without notice or obligation.

# Single Position Sockets

200 Amp | 4 Terminal | Flush Mount | Ring Type

**15**  
200 AMP  
SINGLE  
POSITION  
SOCKETS



UF4518-KO



UF4015-KO

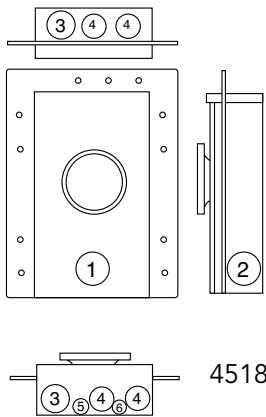

4518

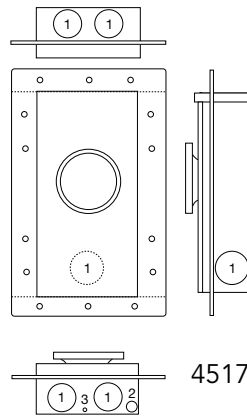

4517

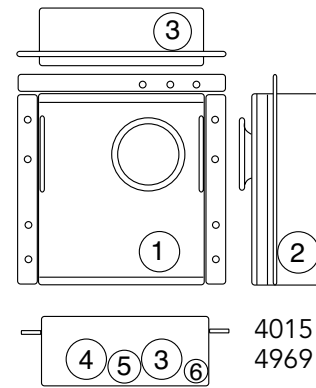

4015  
4969

## 200 Amp | 4 Terminal | Flush Mount | Ring Type | Single Position

| Catalog Number | Terminal | Service | Hub  | Connectors CU/AL |        | Bypass | Dimensions |    |     | Knockouts |    |    |    |    |   |
|----------------|----------|---------|------|------------------|--------|--------|------------|----|-----|-----------|----|----|----|----|---|
|                |          |         |      | Line             | Load   |        | D"         | W" | H"  | 1         | 2  | 3  | 4  | 5  | 6 |
| UF4517-KO      | 4        | OH      | K.O. | #6-350           | #6-350 | None   | 5½         | 8  | 15½ | 2         | ½  | ¼  | —  | —  | — |
| UF4518-KO      | 4        | OH/UG   | K.O. | #6-350           | #6-350 | None   | 5½         | 11 | 15½ | 2         | 2  | 2½ | 2½ | ½  | ¼ |
| UF4015-KO      | 4        | UG      | K.O. | #6-350           | #6-350 | None   | 5          | 14 | 16¼ | 2½        | 2½ | 2½ | 2½ | 1½ | ½ |
| UF4969-KO*     | 4        | UG      | K.O. | #6-350           | #6-350 | None   | 7½         | 14 | 16¼ | 2½        | 2½ | 2½ | 3  | 1½ | ½ |

### Notes

- **Fifth Terminal:** For field mounted fifth terminal order catalog number **K5T** to fit into square opening at the 9 o'clock position.
- **Connectors:** Extruded aluminum connectors are tin plated.
- **Sealing Rings:** Ring type units are supplied with a **MR-4** screw type sealing ring as standard.
- \* **UF4969** can only be used in a 2 x 6 wall.

Please consult serving utility for their requirements prior to ordering or installing, as specifications and approvals vary by utility, and may require local electrical inspector approval. All installations must be installed by a licensed electrician and must comply with all national and local codes, laws and regulations. Milbank reserves the right to make changes in specifications and features shown without notice or obligation.



# 16

125-200 AMP  
LINK BYPASS  
SINGLE  
POSITION

# Link Bypass Single Position

125-200 Amp | 4 & 7 Terminal | Ring Type



U3504-XL

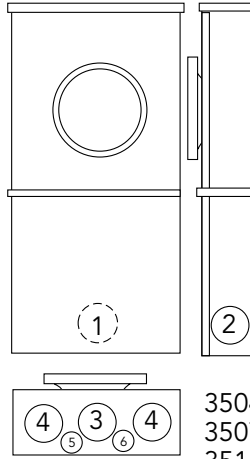

3504  
3507  
3514  
3517



U3517-XL

## 125 Amp | 4 & 7 Terminal | Ring Type | Link Bypass | Single Position

| Catalog Number | Terminal | Service | Hub  | Connectors CU/AL |        | Dimensions                    |    |                                | Knockouts |   |   |   |     |   |
|----------------|----------|---------|------|------------------|--------|-------------------------------|----|--------------------------------|-----------|---|---|---|-----|---|
|                |          |         |      | Line             | Load   | D"                            | W" | H"                             | 1         | 2 | 3 | 4 | 5   | 6 |
| U3504-XL       | 4        | OH/UG   | C.P. | #6-2/0           | #6-2/0 | 4 <sup>7</sup> / <sub>8</sub> | 10 | 18 <sup>1</sup> / <sub>2</sub> | 2         | 2 | 2 | 2 | 1/4 | — |
| U3507-XL       | 7        | OH/UG   | C.P. | #6-2/0           | #6-2/0 | 4 <sup>7</sup> / <sub>8</sub> | 10 | 21                             | 2         | 2 | 2 | 2 | 1/4 | — |

## 200 Amp | 4 & 7 Terminal | Ring Type | Link Bypass | Single Position

| Catalog Number | Terminal | Service | Hub  | Connectors CU/AL |        | Dimensions                    |    |                                | Knockouts                     |                               |                               |                               |     |     |
|----------------|----------|---------|------|------------------|--------|-------------------------------|----|--------------------------------|-------------------------------|-------------------------------|-------------------------------|-------------------------------|-----|-----|
|                |          |         |      | Line             | Load   | D"                            | W" | H"                             | 1                             | 2                             | 3                             | 4                             | 5   | 6   |
| U3514-XL       | 4        | OH/UG   | C.P. | #6-350           | #6-350 | 4 <sup>7</sup> / <sub>8</sub> | 13 | 21                             | 2 <sup>1</sup> / <sub>2</sub> | 2 <sup>1</sup> / <sub>2</sub> | 3                             | 3                             | 1/4 | 1/2 |
| U3517-XL       | 7        | OH/UG   | C.P. | #6-350           | #6-350 | 4 <sup>7</sup> / <sub>8</sub> | 13 | 24 <sup>1</sup> / <sub>2</sub> | 2 <sup>1</sup> / <sub>2</sub> | 2 <sup>1</sup> / <sub>2</sub> | 2 <sup>1</sup> / <sub>2</sub> | 2 <sup>1</sup> / <sub>2</sub> | 1/4 | 1/2 |

## Notes

- **Fifth Terminal:** For field mounted fifth terminal, order catalog number **5T8K2** for the **U3504**; order **K5T** for the **U3514**.
- **Connectors:** Extruded aluminum connectors are tin plated.
- **Sealing Rings:** Ring type units supplied with an **MR-4** screw type sealing ring as standard.
- **Link Bypass:** Links provided by utility.



Please consult serving utility for their requirements prior to ordering or installing, as specifications and approvals vary by utility, and may require local electrical inspector approval. All installations must be installed by a licensed electrician and must comply with all national and local codes, laws and regulations. Milbank reserves the right to make changes in specifications and features shown without notice or obligation.



# Lever Bypass Single Position

200 Amp | 4 & 5 Terminal | Ringless

**17**  
200 AMP  
LEVER BYPASS  
SINGLE  
POSITION

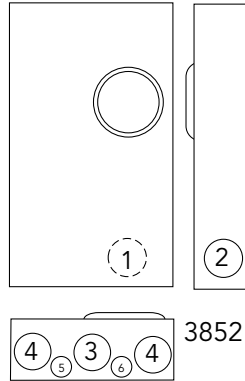

U3852-XL

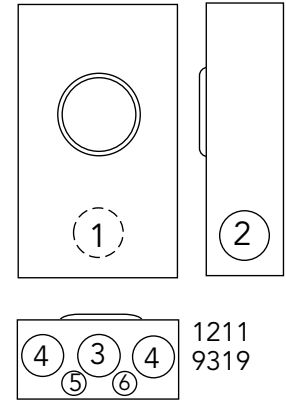

U9319-XL

200 Amp | 4 Terminal | Ringless | Non-Jaw Clamping Lever Bypass | Single Position | 1Ø3W

| Catalog Number | Terminal | Service | Hub  | Connectors CU/AL |        | Bypass | Dimensions                    |    |    | Knockouts |                               |                               |                               |                               |   |   |
|----------------|----------|---------|------|------------------|--------|--------|-------------------------------|----|----|-----------|-------------------------------|-------------------------------|-------------------------------|-------------------------------|---|---|
|                |          |         |      | Line             | Load   |        | D"                            | W" | H" | 1         | 2                             | 3                             | 4                             | 5                             | 6 |   |
| U3852-XL       | 4        | OH/UG   | C.P. | #2-350           | #2-350 | Lever  | 4 <sup>7</sup> / <sub>8</sub> | 13 | 19 | 3         | 2 <sup>1</sup> / <sub>2</sub> | 2 <sup>1</sup> / <sub>2</sub> | 2 <sup>1</sup> / <sub>2</sub> | 2 <sup>1</sup> / <sub>2</sub> | ¼ | ½ |

## Notes

- **Fifth Terminal:** Fifth terminal is not available for this unit.
- **Triplex Ground:** Factory installed as standard.

200 Amp | 4 & 5 Terminal | Ringless | Non-Jaw Clamping Lever Bypass | Single Position | 1Ø3W or 3Ø3W

| Catalog Number | Terminal | Service | Hub  | Connectors CU/AL |        | Bypass | Dimensions                    |    |    | Knockouts |                               |   |   |   |   |
|----------------|----------|---------|------|------------------|--------|--------|-------------------------------|----|----|-----------|-------------------------------|---|---|---|---|
|                |          |         |      | Line             | Load   |        | D"                            | W" | H" | 1         | 2                             | 3 | 4 | 5 | 6 |
| U1211-RXL      | 4        | OH/UG   | C.P. | #6-350           | #6-350 | Lever  | 4 <sup>7</sup> / <sub>8</sub> | 13 | 19 | 3         | 2 <sup>1</sup> / <sub>2</sub> | 3 | 3 | ¼ | ½ |
| U9319-XL       | 5        | OH/UG   | C.P. | #6-350           | #6-350 | Lever  | 4 <sup>7</sup> / <sub>8</sub> | 13 | 19 | 3         | 2 <sup>1</sup> / <sub>2</sub> | 3 | 3 | ¼ | ½ |

## Notes

- **Fifth Terminal:** For field mounted fifth terminal, order as extra **K3866** for the **U1211**.
- **Hubs:** For proper hub selection see the hub suffix chart on accessory page.
- **Bypass:** 200 amp continuous duty bypass. Lever operates bypass only. Not jaw clamping.
- **Connectors:** Units are supplied with extruded aluminum connectors and bonded, triplex neutral.

Please consult serving utility for their requirements prior to ordering or installing, as specifications and approvals vary by utility, and may require local electrical inspector approval. All installations must be installed by a licensed electrician and must comply with all national and local codes, laws and regulations. Milbank reserves the right to make changes in specifications and features shown without notice or obligation.



# Lever Bypass Single Position

125-200 Amp | 7 Terminal | Ringless



U7573-RL

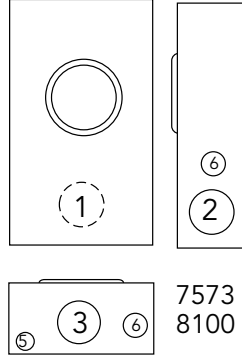

U7422-RXL

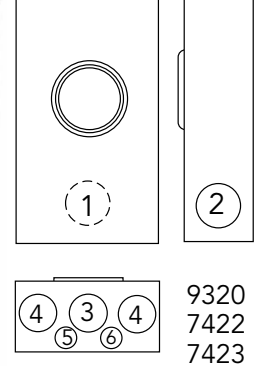

## 7 Terminal | Ringless | No Bypass | Single Position | 3Ø4W

| Catalog Number | Amp | Terminal | Service | Hub  | Connectors CU/AL |        | Bypass | Dimensions      |    |                  | Knockouts |                 |   |   |               |               |
|----------------|-----|----------|---------|------|------------------|--------|--------|-----------------|----|------------------|-----------|-----------------|---|---|---------------|---------------|
|                |     |          |         |      | Line             | Load   |        | D"              | W" | H"               | 1         | 2               | 3 | 4 | 5             | 6             |
| U8100-RL       | 125 | 7        | OH      | H.O  | #6-2/0           | #6-2/0 | None   | 4 $\frac{7}{8}$ | 10 | 18 $\frac{1}{2}$ | 2         | 2               | 2 | — | $\frac{1}{2}$ | $\frac{3}{4}$ |
| U7422-RXL      | 200 | 7        | OH/UG   | C.P. | #6-350           | #6-350 | None   | 4 $\frac{7}{8}$ | 13 | 19               | 3         | 2 $\frac{1}{2}$ | 3 | 3 | $\frac{1}{4}$ | $\frac{1}{2}$ |

## 7 Terminal | Ringless | Non-Jaw Clamping Lever Bypass | Single Position | 3Ø4W

| Catalog Number | Amp | Terminal | Service | Hub  | Connectors CU/AL |        | Bypass | Dimensions      |    |                  | Knockouts |                 |   |   |               |               |
|----------------|-----|----------|---------|------|------------------|--------|--------|-----------------|----|------------------|-----------|-----------------|---|---|---------------|---------------|
|                |     |          |         |      | Line             | Load   |        | D"              | W" | H"               | 1         | 2               | 3 | 4 | 5             | 6             |
| U7573-RL       | 125 | 7        | OH      | H.O. | #6-2/0           | #6-2/0 | Lever  | 4 $\frac{7}{8}$ | 10 | 18 $\frac{1}{2}$ | 2         | 2               | 2 | — | $\frac{1}{2}$ | $\frac{3}{4}$ |
| U9320-RXL      | 125 | 7        | OH/UG   | C.P. | #6-2/0           | #6-2/0 | Lever  | 4 $\frac{7}{8}$ | 10 | 19               | 3         | 2 $\frac{1}{2}$ | 3 | 3 | $\frac{1}{4}$ | $\frac{1}{2}$ |
| U7423-RXL      | 200 | 7        | OH/UG   | C.P. | #6-350           | #6-350 | Lever  | 4 $\frac{7}{8}$ | 13 | 19               | 3         | 2 $\frac{1}{2}$ | 3 | 3 | $\frac{1}{4}$ | $\frac{1}{2}$ |

### Notes

- **Hubs:** For proper hub selection see the hub suffix chart on accessory page.
- **Bypass:** 200 amp continuous duty bypass. Lever operates bypass only. Not jaw clamping.
- **Connectors:** Extruded aluminum connectors are tin plated. Units supplied with bonded, duplex neutral.



Please consult serving utility for their requirements prior to ordering or installing, as specifications and approvals vary by utility, and may require local electrical inspector approval. All installations must be installed by a licensed electrician and must comply with all national and local codes, laws and regulations. Milbank reserves the right to make changes in specifications and features shown without notice or obligation.

# Lever Bypass Single Position

200 Amp | 4, 5 & 7 Terminal | Ringless

**19**  
200 AMP  
LEVER BYPASS  
SINGLE  
POSITION



U9701-RXL

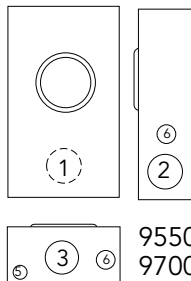

U9800-RRL

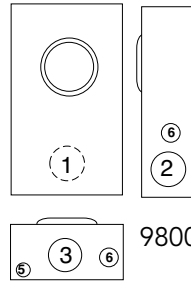

U9551-RXL

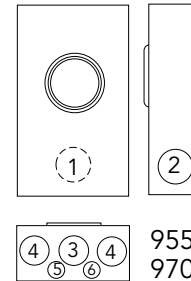

**200 Amp | 4 Terminal | Ringless | Jaw Clamping Lever Bypass | Single Position | 1Ø3W or 3Ø3W**

| Catalog Number | Terminal | Service | Hub  | Connectors CU/AL |        | Bypass | Dimensions      |    |                  | Knockouts |                 |   |   |               |               |
|----------------|----------|---------|------|------------------|--------|--------|-----------------|----|------------------|-----------|-----------------|---|---|---------------|---------------|
|                |          |         |      | Line             | Load   |        | D"              | W" | H"               | 1         | 2               | 3 | 4 | 5             | 6             |
| U9800-RRL*     | 4        | OH      | H.O. | #6-350           | #6-350 | Lever  | 4 $\frac{7}{8}$ | 10 | 18 $\frac{1}{2}$ | 3         | 2 $\frac{1}{2}$ | 3 | — | $\frac{1}{2}$ | $\frac{3}{4}$ |
| U9801-RXL*     | 4        | OH/UG   | C.P. | #6-350           | #6-350 | Lever  | 4 $\frac{7}{8}$ | 13 | 19               | 3         | 2 $\frac{1}{2}$ | 3 | 3 | $\frac{1}{4}$ | $\frac{1}{2}$ |

**200 Amp | 5 Terminal | Ringless | Jaw Clamping Lever Bypass | Single Position | 1Ø3W or 3Ø3W**

| Catalog Number | Terminal | Service | Hub  | Connectors CU/AL |        | Bypass | Dimensions      |    |                  | Knockouts |                 |   |   |               |               |
|----------------|----------|---------|------|------------------|--------|--------|-----------------|----|------------------|-----------|-----------------|---|---|---------------|---------------|
|                |          |         |      | Line             | Load   |        | D"              | W" | H"               | 1         | 2               | 3 | 4 | 5             | 6             |
| U9550-RRL      | 5        | OH      | H.O. | #6-350           | #6-350 | Lever  | 4 $\frac{7}{8}$ | 10 | 18 $\frac{1}{2}$ | 3         | 2 $\frac{1}{2}$ | 3 | — | $\frac{1}{2}$ | $\frac{3}{4}$ |
| U9551-RXL      | 5        | OH/UG   | C.P. | #6-350           | #6-350 | Lever  | 4 $\frac{7}{8}$ | 13 | 19               | 3         | 2 $\frac{1}{2}$ | 3 | 3 | $\frac{1}{4}$ | $\frac{1}{2}$ |

**200 Amp | 7 Terminal | Ringless | Jaw Clamping Lever Bypass | Single Position | 3Ø4W**

| Catalog Number | Terminal | Service | Hub  | Connectors CU/AL |        | Bypass | Dimensions      |    |                  | Knockouts |                 |   |   |               |               |
|----------------|----------|---------|------|------------------|--------|--------|-----------------|----|------------------|-----------|-----------------|---|---|---------------|---------------|
|                |          |         |      | Line             | Load   |        | D"              | W" | H"               | 1         | 2               | 3 | 4 | 5             | 6             |
| U9700-RRL      | 7        | OH      | H.O. | #6-350           | #6-350 | Lever  | 4 $\frac{7}{8}$ | 10 | 18 $\frac{1}{2}$ | 3         | 2 $\frac{1}{2}$ | 3 | — | $\frac{1}{2}$ | $\frac{3}{4}$ |
| U9701-RXL      | 7        | OH/UG   | C.P. | #6-350           | #6-350 | Lever  | 4 $\frac{7}{8}$ | 13 | 19               | 3         | 2 $\frac{1}{2}$ | 3 | 3 | $\frac{1}{4}$ | $\frac{1}{2}$ |

## Notes

- **Hubs:** For proper hub selection see the hub suffix chart on accessory page.
- **Bypass:** Lever supplies clamping action and also operates bypass device.
- **Connectors:** Extruded aluminum connectors are tin plated. **U9550** and **U9551** units are supplied with duplex neutral, with removable bonding strap for insulated neutral. **U9700** series units are supplied with duplex neutral.
- \* Internal Hex Connectors. For main and/or service disconnect, use with **U5484-O** enclosed circuit breaker.

Please consult serving utility for their requirements prior to ordering or installing, as specifications and approvals vary by utility, and may require local electrical inspector approval. All installations must be installed by a licensed electrician and must comply with all national and local codes, laws and regulations. Milbank reserves the right to make changes in specifications and features shown without notice or obligation.



# Lever Bypass Single Position

320 Amp | 4 Terminal | Ringless



U1797-O-K3L-K2L

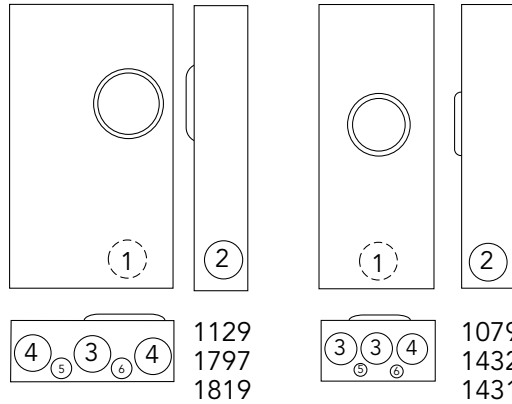

U1129-O-K3L-K2L

## 320 Amp | 4 Terminal | Ringless | Lever Bypass | Single Position

| Catalog Number  | Terminal | Service | Hub   | Connectors CU/AL             |                | Bypass | Dimensions |    |        | Knockouts |       |   |   |     |     |
|-----------------|----------|---------|-------|------------------------------|----------------|--------|------------|----|--------|-----------|-------|---|---|-----|-----|
|                 |          |         |       | Line                         | Load           |        | D"         | W" | H"     | 1         | 2     | 3 | 4 | 5   | 6   |
| U1079-R         | 4        | OH      | H.O.  | 3/8" x 16 Studs              |                | Lever  | 4 7/8      | 13 | 38 3/4 | 3 1/2     | 2 1/2 | 3 | 3 | 1/4 | 1/2 |
| U1431-R*        | 4        | OH/UG   | H.O.  | 3/8" x 16 Studs              |                | None   | 4 7/8      | 13 | 38 3/4 | 3 1/2     | 2 1/2 | 3 | 3 | 1/4 | 1/2 |
| U1129-O-K3L-K2L | 4        | UG      | Blank | (1) #4-600 or<br>(2) 1/0-250 | Twin<br>#6-350 | Lever  | 4 7/8      | 15 | 30     | 3         | 2 1/2 | 3 | 3 | 1/4 | 1/2 |
| U1432-O*        | 4        | UG      | Blank | 3/8" x 16 Studs              |                | None   | 4 7/8      | 13 | 29 3/4 | 3 1/2     | 2 1/2 | 3 | 3 | 1/4 | 1/2 |
| U1819-X*        | 4        | UG      | C.P.  | 3/8" x 16 Studs              |                | None   | 4 7/8      | 15 | 30     | 3         | 3     | 3 | 3 | 1/4 | 1/2 |
| U1797-O-K3L-K2L | 4        | UG      | Blank | (1) #4-600 or<br>(2) 1/0-250 | Twin<br>#6-35  | Lever  | 4 7/8      | 15 | 30     | 3         | 3     | 3 | 3 | 1/4 | 1/2 |

### Notes

- **Hubs:** For proper hub selection, see the hub suffix chart on the accessory page.
- **\*Bypass:** Lever supplies clamping action on meter spades only on the **U1431**, **U1432** and **U1819**. Lever supplies clamping action and also operates bypass device on the **U1079**, **U1129** & **U1797**.
- **Connector Kits:** Stud type units are supplied with 3/8" x 16 hex head nuts with Belleville washers. Order two connector kits to cover both line and load. Order **K1539** (single #350), **K1540** (single #600) or **K1350** (twin #350). See accessories page.  
**Note:** The **U1129** unit has a single connector on the line side only.
- **Fifth Terminal:** For field mounted fifth terminal, order as extra **K3866** for the **U1079** & **U1431**. Order as extra K3865 for units **U1129**, **U1432**, **U1819**, and **U1797**.
- **Lug Size Range:** See accessories page for lug size range for the U1129 & U1797 units.



Please consult serving utility for their requirements prior to ordering or installing, as specifications and approvals vary by utility, and may require local electrical inspector approval. All installations must be installed by a licensed electrician and must comply with all national and local codes, laws and regulations. Milbank reserves the right to make changes in specifications and features shown without notice or obligation.

# Link Bypass Single Position

320 Amp | 4 Terminal | Ring Type

**21**  
320 AMP  
LINK BYPASS  
SINGLE  
POSITION



U3548-X

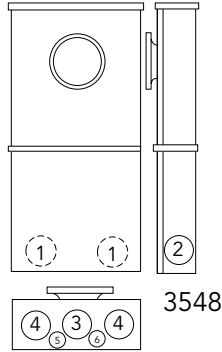

U5056-O

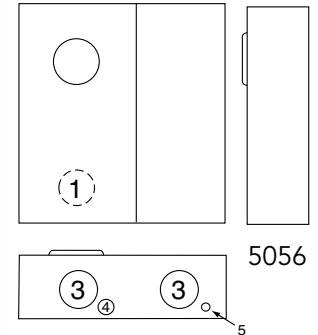

320 Amp | 4 Terminal | Ring Type | Link Bypass | Single Position | 1Ø3W

| Catalog Number | Terminal | Service | Hub   | Connectors CU/AL                     |                           | Bypass | Dimensions |    |    | Knockouts |   |   |   |   |   |
|----------------|----------|---------|-------|--------------------------------------|---------------------------|--------|------------|----|----|-----------|---|---|---|---|---|
|                |          |         |       | Line                                 | Load                      |        | D"         | W" | H" | 1         | 2 | 3 | 4 | 5 | 6 |
| U3548-X*       | 4        | OH/UG   | C.P.  | Single = 4-600<br>Parallel = 1/0-250 |                           | Link   | 6          | 14 | 33 | 3         | 3 | 3 | 3 | ¼ | ½ |
| U5056-O        | 4        | UG      | Blank | 1/2"x13 Studs                        | #4-600 or<br>Twin 1/0-250 | Link   | 6          | 24 | 32 | 3         | — | 4 | ½ | ¼ | — |

## Notes

- **Sealing Ring:** Ring type units are supplied with an **MR-4**, screw type, sealing ring as standard.
- **Triple Tap Lug:** For triple tap lug kit order **K5049**, wire range **#6-250** kcmil.
- **Link Bypass:** Links provided by utility.
- \* **Flush Mount Kit:** For field mounted flush mount kit order **K4086**.

Please consult serving utility for their requirements prior to ordering or installing, as specifications and approvals vary by utility, and may require local electrical inspector approval. All installations must be installed by a licensed electrician and must comply with all national and local codes, laws and regulations. Milbank reserves the right to make changes in specifications and features shown without notice or obligation.



# Lever Bypass Single Position

320 Amp | 7 Terminal | Ringless



U2120-X

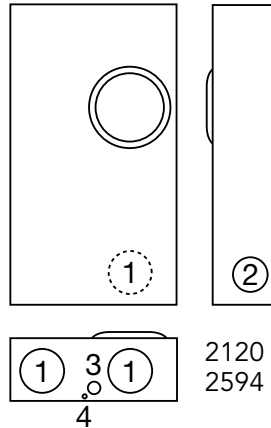

2120  
2594



U2827-X

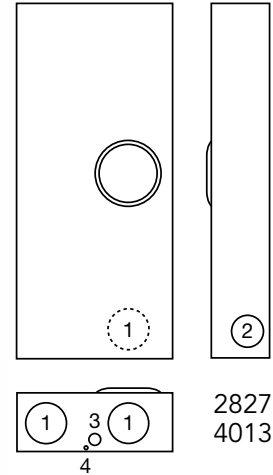

2827  
4013

320 Amp | 7 Terminal | Ringless | Lever Bypass | Single Position | Side Wireway

| Catalog Number | Terminal | Service | Hub  | Connectors CU/AL |      | Bypass     | Dimensions |     |     | Knockouts |   |   |   |
|----------------|----------|---------|------|------------------|------|------------|------------|-----|-----|-----------|---|---|---|
|                |          |         |      | Line             | Load |            | D"         | W"  | H"  | 1         | 2 | 3 | 4 |
| U4013-X        | 7        | OH/UG   | C.P. | 3/8"x16 Studs    |      | Lever      | 6½         | 19  | 34½ | 4         | 3 | 1 | ¼ |
| U2594-X        | 7        | OH/UG   | C.P. | 3/8"x16 Studs    |      | Lever      | 6½         | 19¾ | 34½ | 4         | 3 | 1 | ¼ |
| U2827-X*       | 7        | OH/UG   | C.P. | 3/8"x16 Studs    |      | non-bypass | 6½         | 17¾ | 31  | 4         | 3 | 1 | ¼ |
| U2120-X        | 7        | UG      | C.P. | 3/8"x16 Studs    |      | Lever      | 6½         | 17¾ | 31¾ | 4         | 3 | 1 | ¼ |

## Notes

- **Bypass:** Lever supplies clamping action on meter spades and operates bypass device.
- \*U2827 has lever with jaw clamping capabilities but no bypass.
- **Connector Kits:** Stud type units are supplied with 3/8"x16 hex head nuts with Belleville washers. Order two connector kits to cover both line and load. For single lug connector kits for the U2120 and U2594 units, order as extra K3082 (350 kcmil) or K3441 (600 kcmil). For twin lug connectors order as extra: K3442 (350 kcmil). Separate kits are required for both line and load.



Please consult serving utility for their requirements prior to ordering or installing, as specifications and approvals vary by utility, and may require local electrical inspector approval. All installations must be installed by a licensed electrician and must comply with all national and local codes, laws and regulations. Milbank reserves the right to make changes in specifications and features shown without notice or obligation.

# Service Entrance

100-200 Amp | 4 Terminal | Main Breaker

**23**  
SERVICE  
ENTRANCE



USE-AP-200-ML

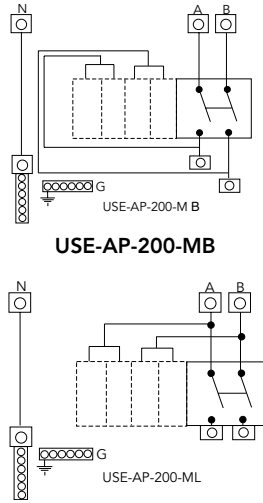
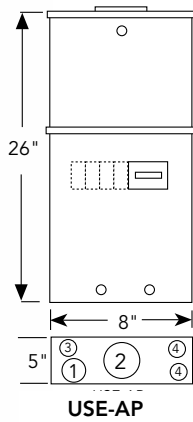

USE-AP-200-ML

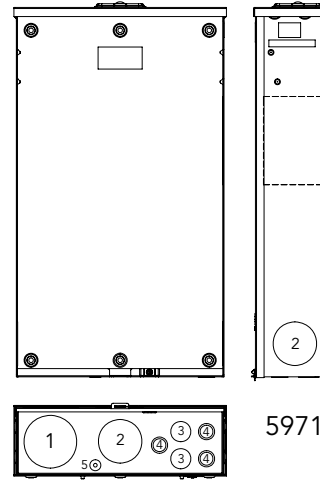

U5971-XL-100



U5971-XL-200

200 Amp | Breaker Enclosure | 1Ø3W | 120/240 Volt | 10K AIC Rating

| Catalog Number | Terminal | Service | Hub | Connectors CU/AL |        | Dimensions |    |    | Knockouts |   |   |   |
|----------------|----------|---------|-----|------------------|--------|------------|----|----|-----------|---|---|---|
|                |          |         |     | Line             | Load   | D"         | W" | H" | 1         | 2 | 3 | 4 |
| USE-AP-200-MB  | 4        | OH      | 2"  | #4-250           | #4-250 | 5          | 8  | 26 | 1         | 2 | ¾ | ¾ |
| USE-AP-200-ML  | 4        | OH      | 2"  | #4-250           | #4-250 | 5          | 8  | 26 | 1         | 2 | ¾ | ¾ |

## Notes

- **USE-AP-200-MB:** 200 amp main wired in series with plug-in style bus. **UQFP-M-200** factory installed. Additional 4 branch circuits available for (1) two-pole and (2) one-pole, or (4) one pole breakers. **One 2" hub included.**
- **USE-AP-200-ML:** 200 amp main wired in series with plug-in style bus. **UQFP-200** factory installed. Additional 4 branch circuits available for (1) two-pole and (2) one-pole, or (4) one pole breakers. **One 2" hub included.**

100-200 Amp | Load Center with Main Breaker | 120/240V

| Catalog Number | Main Breaker Amp | Branch Circuits | Service | Hub  | Dimensions |     |     | Knockouts |    |   |     |     |
|----------------|------------------|-----------------|---------|------|------------|-----|-----|-----------|----|---|-----|-----|
|                |                  |                 |         |      | D"         | W"  | H"  | 1         | 2  | 3 | 4   | 5   |
| U5971-XL-100   | 100              | 10              | OH/UG   | C.P. | 4½         | 14⅞ | 25⅙ | 3         | 2½ | 1 | ½,¾ | ¼,½ |
| U5971-XL-200   | 200              | 8               | OH/UG   | C.P. | 4½         | 14⅞ | 25⅙ | 3         | 2½ | 1 | ½,¾ | ¼,½ |

## Notes

- **AIC Rating:** 22K AIC rating.
- **Line Terminals:** As specified on circuit breaker (300 kcmil max).
- **Load Terminals:** As specified on circuit breakers (#1 AWG max).
- **Breaker Interlock:** Order **K5815** for 200A or 150A to 100A breakers (large frame to small frame). Order **K5820** for 200A or 150A to 200A or 150A breakers (large frame to large frame). Order **K5830** for 100A to 100A (small frame to small frame).

Please consult serving utility for their requirements prior to ordering or installing, as specifications and approvals vary by utility, and may require local electrical inspector approval. All installations must be installed by a licensed electrician and must comply with all national and local codes, laws and regulations. Milbank reserves the right to make changes in specifications and features shown without notice or obligation.





**U3574-RL-200**

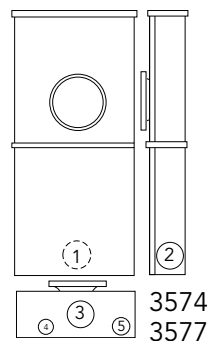
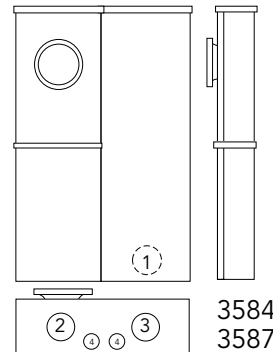

**200 Amp | 4 Terminal | Ring Type | 240 Volt**

| Catalog Number | Terminal | Service | Breaker | Connectors CU/AL |        | Dimensions      |                  |    | Knockouts |   |                 |               |               |   |
|----------------|----------|---------|---------|------------------|--------|-----------------|------------------|----|-----------|---|-----------------|---------------|---------------|---|
|                |          |         |         | Line             | Load   | D"              | W"               | H" | 1         | 2 | 3               | 4             | 5             | 6 |
| U3574-RL-200   | 4        | OH      | 200A-2P | #2-350           | #3-300 | 4 $\frac{1}{8}$ | 8                | 30 | 2         | 2 | 2 $\frac{1}{2}$ | $\frac{1}{4}$ | $\frac{1}{2}$ | — |
| U3584-O-200    | 4        | UG      | 200A-2P | #6-350           | #3-300 | 5 $\frac{1}{2}$ | 14 $\frac{1}{8}$ | 26 | 3         | 3 | 3               | $\frac{1}{2}$ | —             | — |

**200 Amp | 7 Terminal | Ring Type | 240 Volt**

| Catalog Number | Terminal | Service | Breaker | Connectors CU/AL |        | Dimensions      |                  |    | Knockouts |   |                 |               |               |   |
|----------------|----------|---------|---------|------------------|--------|-----------------|------------------|----|-----------|---|-----------------|---------------|---------------|---|
|                |          |         |         | Line             | Load   | D"              | W"               | H" | 1         | 2 | 3               | 4             | 5             | 6 |
| U3577-RL-200   | 7        | OH      | 200A-3P | #2-350           | #3-300 | 4 $\frac{7}{8}$ | 10               | 34 | 2         | 2 | 2 $\frac{1}{2}$ | $\frac{1}{4}$ | $\frac{1}{2}$ | — |
| U3587-O-200    | 7        | UG      | 200A-3P | #6-350           | #3-300 | 5 $\frac{1}{2}$ | 14 $\frac{1}{8}$ | 26 | 3         | 3 | 3               | $\frac{1}{2}$ | —             | — |

**Notes**

- **Breakers:** Units are supplied with bolt-on 200 amp circuit breakers where specified above.
- **Sealing Rings:** Units are supplied with an **MR-4** screw type sealing ring.



Please consult serving utility for their requirements prior to ordering or installing, as specifications and approvals vary by utility, and may require local electrical inspector approval. All installations must be installed by a licensed electrician and must comply with all national and local codes, laws and regulations. Milbank reserves the right to make changes in specifications and features shown without notice or obligation.



# Meter Main with Load Center

100–200 Amp | 4 & 5 Terminal | Ringless & Ring Type

**25**  
100-200 AMP  
METER MAINS

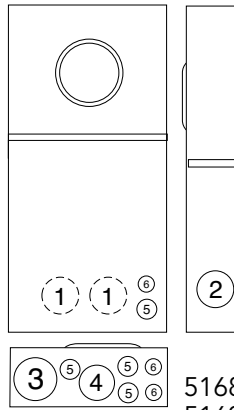

5168 5268  
5169 5269



## Generator Interlock

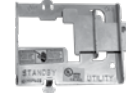

**K5815** - large QN with small frame Q

**K5820** - large frame QN with large frame QN

**K5830** - small frame Q to small frame Q

U5168-XTL-200

U5268-XTL-200-KK

100–200 Amp | Meter Mains | 120/240 Volts | 1Ø3W | Overhead/Underground

| Catalog Number       | Terminal | Amp | Circuits | Hub  | Connectors<br>Line | Bypass | Dimensions |     |    | Knockouts |   |   |    |   |   |
|----------------------|----------|-----|----------|------|--------------------|--------|------------|-----|----|-----------|---|---|----|---|---|
|                      |          |     |          |      |                    |        | D"         | W"  | H" | 1         | 2 | 3 | 4  | 5 | 6 |
| U5168-XTL-100*       | 4        | 100 | 10       | C.P. | #6-350             | None   | 4½         | 14⅞ | 32 | 2         | 2 | 3 | 2½ | 1 | ¾ |
| U5168-XTL-150*       | 4        | 150 | 8        | C.P. | #6-350             | None   | 4½         | 14⅞ | 32 | 2         | 2 | 3 | 2½ | 1 | ¾ |
| U5168-XTL-200*       | 4        | 200 | 8        | C.P. | #6-350             | None   | 4½         | 14⅞ | 32 | 2         | 2 | 3 | 2½ | 1 | ¾ |
| U5168-XTL-100-KK*    | 4        | 100 | 10       | C.P. | #6-350             | Horn   | 4½         | 14⅞ | 32 | 2         | 2 | 3 | 2½ | 1 | ¾ |
| U5168-XTL-150-KK*    | 4        | 150 | 8        | C.P. | #6-350             | Horn   | 4½         | 14⅞ | 32 | 2         | 2 | 3 | 2½ | 1 | ¾ |
| U5168-XTL-200-KK*    | 4        | 200 | 8        | C.P. | #6-350             | Horn   | 4½         | 14⅞ | 32 | 2         | 2 | 3 | 2½ | 1 | ¾ |
| U5168-XTL-100-KK-5T* | 5        | 100 | 10       | C.P. | #6-350             | Horn   | 4½         | 14⅞ | 32 | 2         | 2 | 3 | 2½ | 1 | ¾ |
| U5168-XTL-150-KK-5T* | 5        | 150 | 8        | C.P. | #6-350             | Horn   | 4½         | 14⅞ | 32 | 2         | 2 | 3 | 2½ | 1 | ¾ |
| U5169-XTL-100        | 4        | 100 | 10       | C.P. | #6-350             | None   | 4½         | 14⅞ | 32 | 2         | 2 | 3 | 2½ | 1 | ¾ |
| U5169-XTL-150        | 4        | 150 | 8        | C.P. | #6-350             | None   | 4½         | 14⅞ | 32 | 2         | 2 | 3 | 2½ | 1 | ¾ |
| U5169-XTL-200        | 4        | 200 | 8        | C.P. | #6-350             | None   | 4½         | 14⅞ | 32 | 2         | 2 | 3 | 2½ | 1 | ¾ |
| U5268-XTL-150*       | 4        | 150 | 20       | C.P. | #6-350             | None   | 4½         | 14⅞ | 32 | 2         | 2 | 3 | 2½ | 1 | ¾ |
| U5268-XTL-200*       | 4        | 200 | 20       | C.P. | #6-350             | None   | 4½         | 14⅞ | 32 | 2         | 2 | 3 | 2½ | 1 | ¾ |
| U5268-XTL-150-KK*    | 4        | 150 | 20       | C.P. | #6-350             | Horn   | 4½         | 14⅞ | 32 | 2         | 2 | 3 | 2½ | 1 | ¾ |
| U5268-XTL-200-KK*    | 4        | 200 | 20       | C.P. | #6-350             | Horn   | 4½         | 14⅞ | 32 | 2         | 2 | 3 | 2½ | 1 | ¾ |
| U5269-XTL-200        | 4        | 200 | 20       | C.P. | #6-350             | None   | 4½         | 14⅞ | 32 | 2         | 2 | 3 | 2½ | 1 | ¾ |

## Notes

- **Hubs:** Supplied with (2) closing plates packed inside. Order hubs as a separate item. See accessory page for hub options.
- **Interior:** U5168 units have 8-circuit interior; U5268 units have 20-circuit interior
- **Fifth Terminal:** Order K5T and field install for 208Y/120 network systems. Installs in the 9 o'clock position only.
- **Branch Breakers:** Series rated 22K AIC with Milbank QNR2200H main installed.
- **Interlock Kit:** For generator auxiliary circuit breaker interlock, order K5815 for large QN with small frame Q; order K5820 for large frame QN with large frame QN; order K5830 for small frame Q with small frame Q.
- **Sub-Feed Lugs:** #6-350 kcmil sub-feed lugs provided on 8 and 10 circuit interior. **Not available on 20 circuit interior.**
- Amp rating limited to main breaker rating.

### \* Ringless

Please consult serving utility for their requirements prior to ordering or installing, as specifications and approvals vary by utility, and may require local electrical inspector approval. All installations must be installed by a licensed electrician and must comply with all national and local codes, laws and regulations. Milbank reserves the right to make changes in specifications and features shown without notice or obligation.



# Heavy Duty Lever Bypass Meter Mains

320 Amp | 4 Terminal | Ringless



U5059-X-2/200

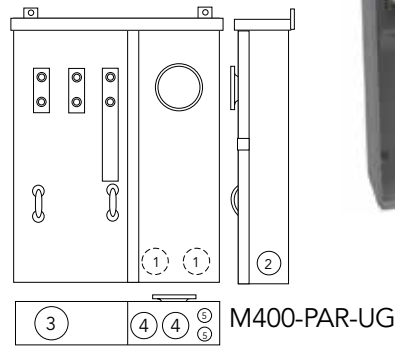
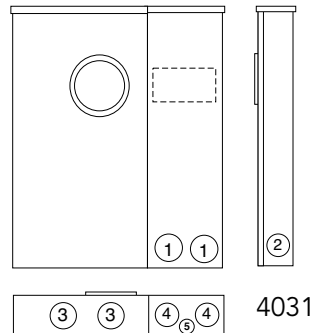
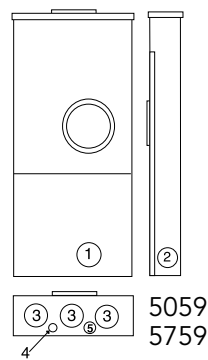

U4031-O-2/200

320 Amp | 4 Terminal | Ringless | 1Ø3W | 22K AIC Rating

| Catalog Number             | Terminal | Service | Primary Disconnect             | Secondary Disconnect           | Bypass | Dimensions                    |                                |    | Knockouts                     |                               |   |   |   |
|----------------------------|----------|---------|--------------------------------|--------------------------------|--------|-------------------------------|--------------------------------|----|-------------------------------|-------------------------------|---|---|---|
|                            |          |         |                                |                                |        | D"                            | W"                             | H" | 1                             | 2                             | 3 | 4 | 5 |
| U5759-X-2/200*2            | 4        | OH/UG   | 200 Amp/2 Pole Circuit Breaker | 200 Amp/2 Pole Circuit Breaker | None   | 4 <sup>7</sup> / <sub>8</sub> | 15                             | 42 | 2 <sup>1</sup> / <sub>2</sub> | 2 <sup>1</sup> / <sub>2</sub> | 3 | ¼ | ½ |
| U5059-X-2/200 <sup>2</sup> | 4        | OH/UG   | 200 Amp/2 Pole Circuit Breaker | 200 Amp/2 Pole Circuit Breaker | Lever  | 4 <sup>7</sup> / <sub>8</sub> | 15                             | 42 | 2 <sup>1</sup> / <sub>2</sub> | 2 <sup>1</sup> / <sub>2</sub> | 3 | ¼ | ½ |
| U4031-O-2/200 <sup>2</sup> | 4        | UG      | 200 Amp/2 Pole Circuit Breaker | 200 Amp/2 Pole Circuit Breaker | Lever  | 5 <sup>3</sup> / <sub>4</sub> | 25                             | 30 | 3                             | 3                             | 4 | 3 | ½ |
| M400-PAR-UG**1             | 4        | UG      | 200 Amp/2 Pole Circuit Breaker | <b>See Note<sup>1</sup></b>    | Lever  | 6 <sup>1</sup> / <sub>8</sub> | 22 <sup>1</sup> / <sub>8</sub> | 36 | 2                             | 2                             | 4 | 2 | ¾ |

## Notes

- **Amperage Rating:** 400 amp, 320 amp continuous.
- **Neutral:** Bonded neutral and ground factory installed.
- **Flush Mount:** Flush mounting available on underground units. Order catalog number **FK-M400-UG** separately.
- **Short Circuit Current Withstand Rating:** 22K AIC Standard.
- **Bypass:** Lever supplies clamping action and operates bypass device.
- **Fifth Terminal:** For field installed fifth terminal for the **U5059** & **U5759**, order separately catalog number **K3866**.
- **Conversion Kit:** To field convert **M400** UG units to OH, order **K4787-F**. Includes connectors (#2-600).

<sup>1</sup> 200 amp primary disconnect factory installed. Order secondary disconnect separately. Specify **UQFPH-100, 125, 150, 175** or **200**.

<sup>2</sup> **Line Side Connector Kits:** Two 1/2" studs per phase on 1-3/4" centers. Factory installed for the **U5759**, for the **U5059** order anti-rotation connector kit **K1540L** to accommodate #4-600 kcmil single or **K1350L** for twin 350 kcmil connectors.

\* Lever supplies clamping action only—does NOT operate bypass on the **U5759**.

\*\* **Lug Kit:** Mechanical lug kit available for **M400-APS-UG**, order **K4920** (#2-500).



Please consult serving utility for their requirements prior to ordering or installing, as specifications and approvals vary by utility, and may require local electrical inspector approval. All installations must be installed by a licensed electrician and must comply with all national and local codes, laws and regulations. Milbank reserves the right to make changes in specifications and features shown without notice or obligation.

# Meter Main with Split Load

320 Amp | 4 Terminal | Ring Type

**27**  
320 AMP  
METER MAINS



M400-APS-BS

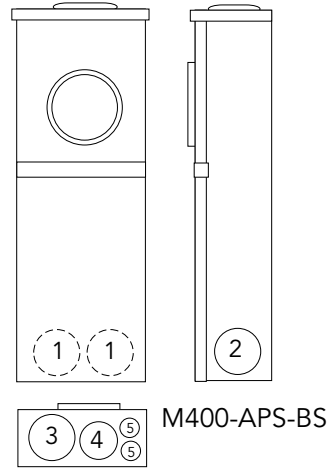

320 Amp | 4 Terminal | Ring Type | 1Ø3W | Type 3R | 120/240 Volt

| Catalog Number | Terminal | Service | Primary Disconnect             | Secondary Disconnect  | Bypass | Dimensions                    |                                |                                | Knockouts                     |                               |   |                               |     |   |
|----------------|----------|---------|--------------------------------|-----------------------|--------|-------------------------------|--------------------------------|--------------------------------|-------------------------------|-------------------------------|---|-------------------------------|-----|---|
|                |          |         |                                |                       |        | D"                            | W"                             | H"                             | 1                             | 2                             | 3 | 4                             | 5   | 6 |
| M400-APS       | 4        | OH      | 200 Amp/2 Pole Circuit Breaker | See Note <sup>1</sup> | None   | 6 <sup>1</sup> / <sub>8</sub> | 9 <sup>1</sup> / <sub>2</sub>  | 47 <sup>1</sup> / <sub>8</sub> | 2                             | 2                             | 2 | 1 <sup>1</sup> / <sub>2</sub> | 3/4 | — |
| M400-APS-BS    | 4        | OH      | 200 Amp/2 Pole Circuit Breaker | See Note <sup>1</sup> | Link   | 6                             | 11 <sup>1</sup> / <sub>2</sub> | 47                             | 2 <sup>1</sup> / <sub>2</sub> | 2 <sup>1</sup> / <sub>2</sub> | 3 | 3                             | 3/4 | — |

## Notes

- **Amperage Rating:** 400 amp, 320 amp continuous.
- **Neutral:** Bonded neutral and ground factory Installed.
- **Line Side Connectors:** Connectors provided for 4-600 or twin 1/0-250.
- **Overhead:** Overhead units include one 3" hub.

<sup>1</sup> 200 amp primary disconnect factory installed. Order secondary disconnect separately. Specify **UQFPH-100, 125, 150, 175** or **200**.

Please consult serving utility for their requirements prior to ordering or installing, as specifications and approvals vary by utility, and may require local electrical inspector approval. All installations must be installed by a licensed electrician and must comply with all national and local codes, laws and regulations. Milbank reserves the right to make changes in specifications and features shown without notice or obligation.



# Meter Main with Split Load

320 Amp | 4 Terminal | Ring Type



M400-UG-APS-F

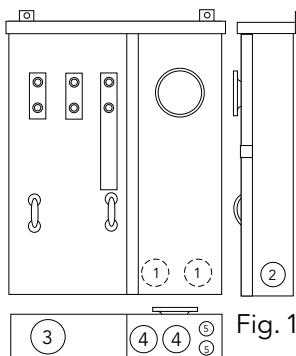

Fig. 1

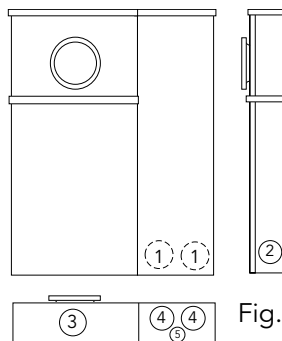

Fig. 2



U3251-O-200-CB

320 Amp | 4 Terminal | Ring Type | 1Ø3W | Type 3R | 120/240 VAC

| Catalog Number                 | Terminal | Service | Primary Disconnect             | Secondary Disconnect           | Bypass | Dimensions |     |     | Knockouts |   |   |    |   | Fig. |
|--------------------------------|----------|---------|--------------------------------|--------------------------------|--------|------------|-----|-----|-----------|---|---|----|---|------|
|                                |          |         |                                |                                |        | D"         | W"  | H"  | 1         | 2 | 3 | 4  | 5 |      |
| M400-UG-APS-F <sup>1</sup>     | 4        | UG      | 200 Amp/2 Pole Circuit Breaker | See Note <sup>1</sup>          | None   | 6½         | 22½ | 36  | 2         | 2 | 4 | 2  | ¾ | 1    |
| M400-UG-APS-F-BS <sup>1</sup>  | 4        | UG      | 200 Amp/2 Pole Circuit Breaker | See Note <sup>1</sup>          | Link   | 6          | 29  | 41⅞ | 2         | 2 | 4 | 2  | ¾ | 1    |
| M400-UG-APS-P <sup>2</sup>     | 4        | UG      | 200 Amp 2 Pole-T-Fuse          | 200 Amp 2 Pole-T-Fuse          | None   | 6½         | 22½ | 36  | 2         | 2 | 4 | 2  | ¾ | 1    |
| M400-UG-APS-LC <sup>4</sup>    | 4        | UG      | 200 Amp/2 Pole Circuit Breaker | 200 Amp/2 Pole Circuit Breaker | None   | 6          | 29  | 41⅞ | 2½        | 1 | 4 | 2½ | ¾ | 2    |
| M400-UG-APS-LC-BS <sup>4</sup> | 4        | UG      | 200 Amp/2 Pole Circuit Breaker | 200 Amp/2 Pole Circuit Breaker | Link   | 6          | 29  | 41⅞ | 2½        | 1 | 4 | 2½ | ¾ | 2    |
| U3251-O-200-CB <sup>3</sup>    | 4        | UG      | 200 Amp/2 Pole Circuit Breaker | 200 Amp/2 Pole Circuit Breaker | Link   | 6¾         | 24  | 40¼ | 3         | 3 | 4 | 3  | ⅞ | 2    |

## Notes

- **Amperage Rating:** 400 amp, 320 amp continuous.
- **EUSERC:** Meets EUSERC requirements. Consult local utility for acceptability before ordering or installing.
- **Neutral:** Bonded neutral and ground factory Installed.
- **Line Side Connectors:** Two 1/2" studs per phase on 1-3/4" centers.
- **Load Side Connectors:** 1/0-300
- **Flush Mount:** Flush mount kit included with **M400-UG-APS-F**, **M400-UG-APS-FBS**, **M400-UG-APS-LC** and **M400-UG-APS-LC-BS**. Available for other underground units. Order catalog number **FK-M400-UG** separately.
- **Short Circuit Current Withstand Rating:** 22K AIC standard, 200k aic standard on T-fuse models.
- **Lug Kit:** Mechanical lug kit available, order **K4920** (#2-500).
- **Conversion Kit:** To field convert **M400** UG units to OH, order **K4787-F**.

<sup>1</sup> 200 amp primary disconnect factory installed. Order secondary disconnect separately. Specify **UQFPH-100, 125, 150, 175** or **200**.

<sup>2</sup> Two 200 amp T-fuse pull-outs factory installed as primary and secondary disconnects.

<sup>3</sup> Two 200 amp 2-pole bolt-on **UQFBH** main breakers factory installed.

<sup>4</sup> **Breakers:** Two 200 amp 2-pole main breakers factory installed, and semi-flush flange kit packed inside meter section. Universal Copper 24/40 Circuit interior accepts Challenger, GE, Murray, Siemens/ITE, and Cutler-Hammer/Westinghouse universal type plug-in branch circuit breakers.



Please consult serving utility for their requirements prior to ordering or installing, as specifications and approvals vary by utility, and may require local electrical inspector approval. All installations must be installed by a licensed electrician and must comply with all national and local codes, laws and regulations. Milbank reserves the right to make changes in specifications and features shown without notice or obligation.

# Meter Main Combination

320 Amp | 4 Terminal | Ring Type

**29**  
320 AMP  
METER MAINS



**M401-UG**

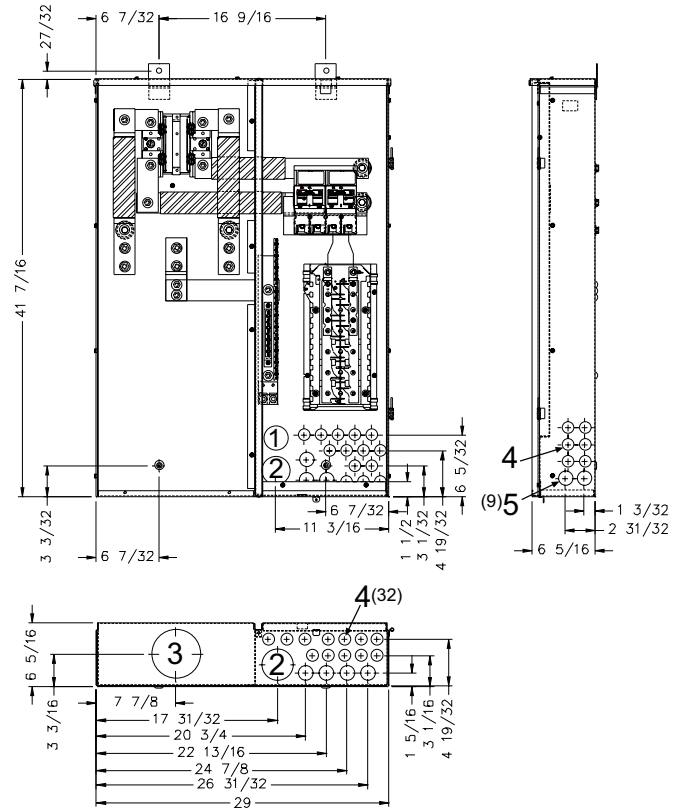
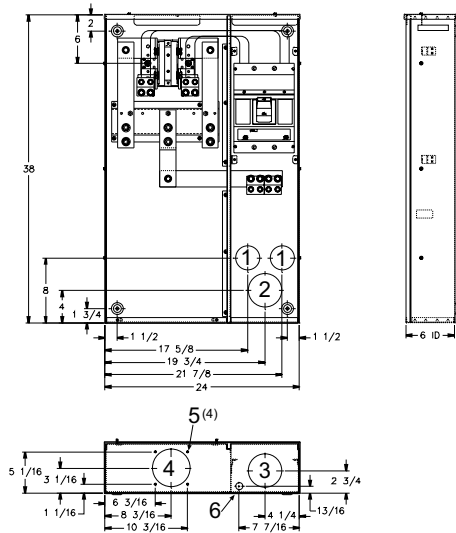

**M400-UG-APS-LC**  
(see previous page for details)

## 320 Amp Main Breaker | 4 Terminal | Ring Type | 1Ø3W | Type 3R | 120/240 Volt

| Catalog Number | Terminal | Service | Main Disconnect               | Bypass | Connectors CU/AL |       | Dimensions |    |    | Knockouts |    |    |   |   |   |
|----------------|----------|---------|-------------------------------|--------|------------------|-------|------------|----|----|-----------|----|----|---|---|---|
|                |          |         |                               |        | Line             | Load  | D"         | W" | H" | 1         | 2  | 3  | 4 | 5 | 6 |
| M401-UG        | 4        | UG      | (1) 400 Amp<br>2 Pole Breaker | None   | Studs            | C.B.* | 6          | 24 | 38 | 2½        | 3½ | 3½ | 4 | ¼ | ½ |
| M401-UG-BS     | 4        | UG      | (1) 400 Amp<br>2 Pole Breaker | Link   | Studs            | C.B.* | 6          | 24 | 38 | 2½        | 3½ | 3½ | 4 | ¼ | ½ |

### Notes

- **Amperage Rating:** 400 amp, 320 amp continuous.
  - **Neutral:** Bonded neutral and ground factory installed.
  - **Load Side Connectors:** Two 1/2" studs per phase on 1-3/4" centers.
  - **Lug Kit:** Mechanical lug kit available, order **K4920** (#2-500).
  - **Flush Mount:** Flush mounting available on underground units. Order catalog number **FK-M400-UG** separately.
  - **Short Circuit Current Withstand Rating:** 22K AIC standard.
- \* C.B. load side (1) or (2) copper conductors 3/0-500, (2) aluminum conductors 4/0-500 or (1) aluminum conductor 250-500.

Please consult serving utility for their requirements prior to ordering or installing, as specifications and approvals vary by utility, and may require local electrical inspector approval. All installations must be installed by a licensed electrician and must comply with all national and local codes, laws and regulations. Milbank reserves the right to make changes in specifications and features shown without notice or obligation.



# Meter Main Combination

320 Amp | 4 Terminal | Ring Type



**M404-UG-LC**

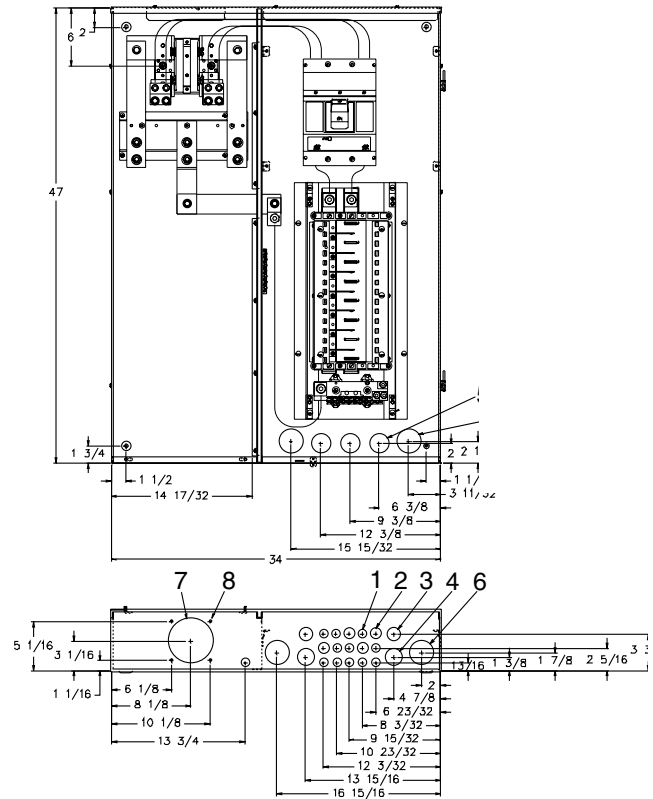

### Knockouts

- 1 = (12) 1/2"
- 2 = (4) 1/2, 3/4"
- 3 = (4) 3/4, 1"
- 4 = (2) 1/2, 3/4, 1, 1-1/4"
- 5 = (3) 3/4, 1, 1-1/4, 1-1/2"
- 6 = (4) 1, 1 1/4, 1-1/2, 2"
- 7 = (1) 3, 3-1/2, 4"
- 8 = (4) 1/4" diameter hole

### 320 Amp Main With Circuit Load Center | 4 Terminal | Ring Type | 1Ø3W | 120/240 Volt

| Catalog Number | Terminal | Service | Primary Disconnect        | Secondary Disconnect | Bypass | Dimensions |    |    | Knockouts |     |   |       |       |   |   |     |
|----------------|----------|---------|---------------------------|----------------------|--------|------------|----|----|-----------|-----|---|-------|-------|---|---|-----|
|                |          |         |                           |                      |        | D"         | W" | H" | 1         | 2   | 3 | 4     | 5     | 6 | 7 | 8   |
| M404-UG-LC*    | 4        | UG      | 400 Amp<br>2 Pole Breaker | NA                   | None   | 6          | 34 | 47 | 1/2       | 3/4 | 1 | 1 1/4 | 1 1/2 | 2 | 4 | 1/4 |
| M404-UG-LC-BS* | 4        | UG      | 400 Amp<br>2 Pole Breaker | NA                   | Link   | 6          | 34 | 47 | 1/2       | 3/4 | 1 | 1 1/4 | 1 1/2 | 2 | 4 | 1/4 |

### Notes

- **Amperage Rating:** 400 amp, 320 amp continuous.
- **Neutral:** Bonded neutral and ground factory installed.
- **Line Side Connectors:** Two 1/2" studs per phase on 1-3/4" centers.
- **Flush Mount:** Flush mounting available on underground units. Order catalog number **FK-M404-UGLC** separately.
- **Short Circuit Current Withstand Rating:** 22K AIC standard.
- **Lug Kit:** Mechanical lug kit available, order **K4920** (#2-500).
- **Branch Breakers:** Use Siemens, Cutler-Hammer, GE or Siemens/Murray breakers to maintain 22K rating.
- \* Includes a 30-circuit load center.



Please consult serving utility for their requirements prior to ordering or installing, as specifications and approvals vary by utility, and may require local electrical inspector approval. All installations must be installed by a licensed electrician and must comply with all national and local codes, laws and regulations. Milbank reserves the right to make changes in specifications and features shown without notice or obligation.

# Test Block Bypass/Safety Sockets

100 & 200 Amp | 4, 5 & 7 Terminal | Ring Type

**31**  
100 & 200 AMP  
SAFETY SOCKETS

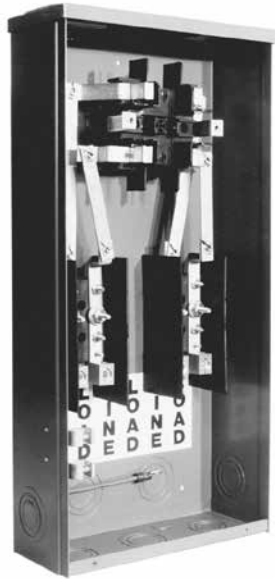

114TB

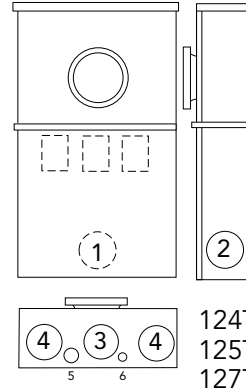
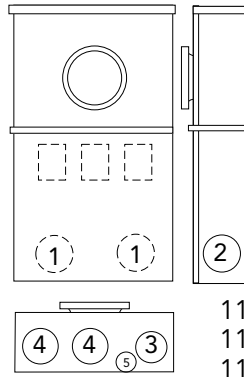

127TB

## 100 Amp | 4, 5 & 7 Terminal | Ring Type | 600 Volt Self-Contained | Socket Only

| Catalog Number | Terminal | Service | Type of Service | Connectors CU/AL |  | Dimensions                    |    |    | Knockouts |   |    |   |   |   |
|----------------|----------|---------|-----------------|------------------|--|-------------------------------|----|----|-----------|---|----|---|---|---|
|                |          |         |                 | Line & Load      |  | D"                            | W" | H" | 1         | 2 | 3  | 4 | 5 | 6 |
| 114TB*         | 4        | OH/UG   | 1Ø3W*           | #6-1/0           |  | 4 <sup>5</sup> / <sub>8</sub> | 12 | 25 | 2         | 2 | 1½ | 2 | ½ | — |
| 115TB          | 5        | OH/UG   | 3Ø3W            | #6-1/0           |  | 4 <sup>5</sup> / <sub>8</sub> | 12 | 25 | 2         | 2 | 1½ | 2 | ½ | — |
| 117TB          | 7        | OH/UG   | 3Ø4W            | #6-1/0           |  | 4 <sup>5</sup> / <sub>8</sub> | 12 | 25 | 2         | 2 | 1½ | 2 | ½ | — |

## 200 Amp | 4, 5 & 7 Terminal | Ring Type | 600 Volt Self-Contained | Socket Only

| Catalog Number | Terminal | Service | Type of Service | Connectors CU/AL |  | Dimensions |    |    | Knockouts |    |   |   |   |      |
|----------------|----------|---------|-----------------|------------------|--|------------|----|----|-----------|----|---|---|---|------|
|                |          |         |                 | Line & Load      |  | D"         | W" | H" | 1         | 2  | 3 | 4 | 5 | 6    |
| 124TB*         | 4        | OH/UG   | 1Ø3W*           | #1/0-250         |  | 6          | 14 | 30 | 2½        | 2½ | 3 | 3 | ¼ | ½, ¼ |
| 125TB          | 5        | OH/UG   | 3Ø3W            | #1/0-250         |  | 6          | 14 | 30 | 2½        | 2½ | 3 | 3 | ¼ | ½, ¼ |
| 127TB          | 7        | OH/UG   | 3Ø4W            | #1/0-250         |  | 6          | 14 | 30 | 2½        | 2½ | 3 | 3 | ¼ | ½, ¼ |

### Notes

- **Hubs:** OH units use hub up to 2-1/2" (see accessory page). Units provided with closing plates.
- **Sealing Rings:** Units furnished with MR-2 snap style sealing rings.
- **Ring Protector:** Add suffix **-RP** to catalog number for factory installed ring protector (ex. 117TB becomes 117TB-RP).
- \* For 3W (208Y/120) network service, install field mounted fifth terminal catalog number 105J. See accessories page.

**SHORT CIRCUIT CURRENT WITHSTAND RATING UP TO 200K AIC  
DEPENDENT ON OVERCURRENT PROTECTION DEVICE USED**

Please consult serving utility for their requirements prior to ordering or installing, as specifications and approvals vary by utility, and may require local electrical inspector approval. All installations must be installed by a licensed electrician and must comply with all national and local codes, laws and regulations. Milbank reserves the right to make changes in specifications and features shown without notice or obligation.



# Test Block Bypass/MTB Series

100 Amp | 4, 5 & 7 Terminal | Ring Type | 10K AIC



U214MTB

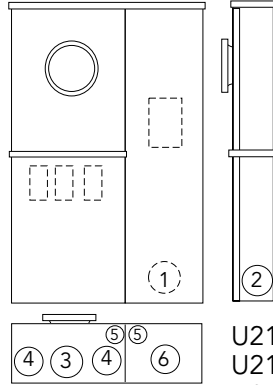

U214MTB  
U215MTB  
U217MTB

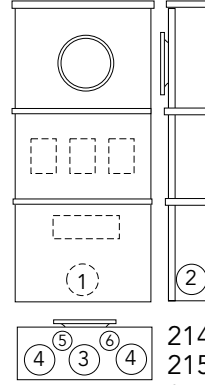

214MT  
215MT  
217MT



217MTB

100 Amp | 4, 5 & 7 Terminal | Ring Type | 240 Volt Self-Contained | Circuit Breaker

| Catalog Number | Terminal | Service | Type of Service | Connectors CU/AL |         | Dimensions                    |    |    | Knockouts |   |    |    |   |    |
|----------------|----------|---------|-----------------|------------------|---------|-------------------------------|----|----|-----------|---|----|----|---|----|
|                |          |         |                 | Line             | Load    | D"                            | W" | H" | 1         | 2 | 3  | 4  | 5 | 6  |
| 214MTB*        | 4        | OH      | 1Ø3W*           | #6-2/0           | #14-1/0 | 4 <sup>5</sup> / <sub>8</sub> | 12 | 34 | 2         | 2 | 2  | 1½ | — | ½  |
| 215MTB         | 5        | OH      | 3Ø3W            | #6-2/0           | #14-1/0 | 4 <sup>5</sup> / <sub>8</sub> | 12 | 34 | 2         | 2 | 2  | 1½ | — | ½  |
| 217MTB         | 7        | OH      | 3Ø4W            | #6-2/0           | #14-1/0 | 4 <sup>5</sup> / <sub>8</sub> | 12 | 34 | 2         | 2 | 2  | 1½ | — | ½  |
| U214MTB*       | 4        | OH/UG   | 1Ø3W*           | #6-2/0           | #14-1/0 | 4 <sup>5</sup> / <sub>8</sub> | 18 | 25 | 2         | 2 | 2½ | 1½ | ¾ | 1½ |
| U215MTB        | 5        | OH/UG   | 3Ø3W            | #6-2/0           | #14-1/0 | 4 <sup>5</sup> / <sub>8</sub> | 18 | 25 | 2         | 2 | 2½ | 1½ | ¾ | 1½ |
| U217MTB        | 7        | OH/UG   | 3Ø4W            | #6-2/0           | #14-1/0 | 4 <sup>5</sup> / <sub>8</sub> | 18 | 25 | 2         | 2 | 2½ | 1½ | ¾ | 1½ |

## Notes

- **Replacement Main Disconnects:** For replacement main disconnect see pages 42-43.
- **Hubs:** OH units use hub up to 2-1/2" (see accessory page). Units provided with closing plates.
- **Sealing Rings:** Units furnished with MR-2 snap style sealing rings.
- \* For 3W (208Y/120) network service, install field mounted fifth terminal catalog number 105J. See accessories page.

*These UL listed products are for use in areas requiring Electrical Utility Service Equipment Requirements Committee (EUSERC) compliance.*



Please consult serving utility for their requirements prior to ordering or installing, as specifications and approvals vary by utility, and may require local electrical inspector approval. All installations must be installed by a licensed electrician and must comply with all national and local codes, laws and regulations. Milbank reserves the right to make changes in specifications and features shown without notice or obligation.



# Test Block Bypass/MTB Series

100 Amp | 4 & 7 Terminal | Ring Type | 22K AIC

**33**  
100 AMP  
TEST BLOCK  
BYPASS



U214MTB/22

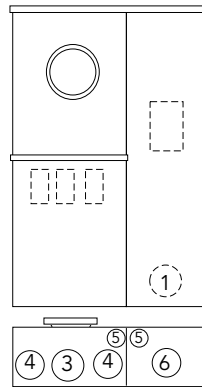

U214MTB/22  
U217MTB/22

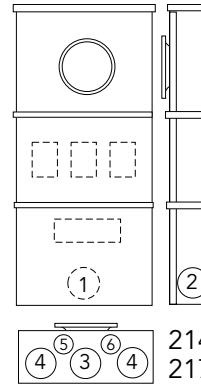

214MTB/2  
217MTB/2



217MTB/2

100 Amp | 4 & 7 Terminal | Ring Type | 240 Volt Self-Contained | Circuit Breaker

| Catalog Number | Terminal | Service | Type of Service | Connectors CU/AL |         | Dimensions      |    |    | Knockouts |   |                 |                 |               |                 |
|----------------|----------|---------|-----------------|------------------|---------|-----------------|----|----|-----------|---|-----------------|-----------------|---------------|-----------------|
|                |          |         |                 | Line             | Load    | D"              | W" | H" | 1         | 2 | 3               | 4               | 5             | 6               |
| 214MTB/22*     | 4        | OH      | 1Ø3W*           | #6-2/0           | #14-1/0 | 4 $\frac{5}{8}$ | 12 | 34 | 2         | 2 | 2               | 1 $\frac{1}{2}$ | —             | $\frac{1}{2}$   |
| 217MTB/22      | 7        | OH      | 3Ø4W            | #6-2/0           | #14-1/0 | 4 $\frac{5}{8}$ | 12 | 34 | 2         | 2 | 2               | 1 $\frac{1}{2}$ | —             | $\frac{1}{2}$   |
| U214MTB/22*    | 4        | OH/UG   | 1Ø3W*           | #6-2/0           | #14-1/0 | 4 $\frac{5}{8}$ | 18 | 25 | 2         | 2 | 2 $\frac{1}{2}$ | 1 $\frac{1}{2}$ | $\frac{3}{4}$ | 1 $\frac{1}{2}$ |
| U217MTB/22     | 7        | OH/UG   | 3Ø4W            | #6-2/0           | #14-1/0 | 4 $\frac{5}{8}$ | 18 | 25 | 2         | 2 | 2 $\frac{1}{2}$ | 1 $\frac{1}{2}$ | $\frac{3}{4}$ | 1 $\frac{1}{2}$ |

## Notes

- **Replacement Main Disconnects:** For replacement main disconnect see pages 42-43.
  - **Hubs:** OH units use hub up to 2-1/2" (see accessory page). Units provided with closing plates.
  - **Sealing Rings:** Units furnished with MR-2 snap style sealing rings.
- \* For 3W (208Y/120) network service, install field mounted fifth terminal catalog number 105J. See accessories page.

*These UL listed products are for use in areas requiring  
Electrical Utility Service Equipment Requirements Committee (EUSERC) compliance.*

Please consult serving utility for their requirements prior to ordering or installing, as specifications and approvals vary by utility, and may require local electrical inspector approval. All installations must be installed by a licensed electrician and must comply with all national and local codes, laws and regulations. Milbank reserves the right to make changes in specifications and features shown without notice or obligation.



# 34

100 AMP  
TEST BLOCK  
BYPASS

# Test Block Bypass/MTB Series

100 Amp | 4, 5 & 7 Terminal | Ring Type | 14K AIC | 480 Volt



217MTB-48

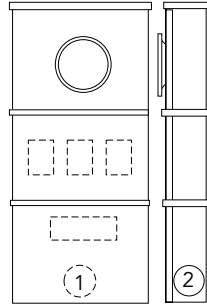

214MTB-48  
215MTB-48  
217MTB-48

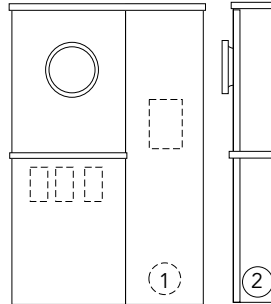

U214MTB-48  
U215MTB-48  
U217MTB-48



U214MTB-48

100 Amp | 4, 5 & 7 Terminal | Ring Type | 480 Volt Self-Contained | Circuit Breaker

| Catalog Number | Terminal | Service | Type of Service | Connectors CU/AL |         | Dimensions |    |    | Knockouts |    |    |    |      |    |
|----------------|----------|---------|-----------------|------------------|---------|------------|----|----|-----------|----|----|----|------|----|
|                |          |         |                 | Line             | Load    | D"         | W" | H" | 1         | 2  | 3  | 4  | 5    | 6  |
| 214MTB-48*     | 4        | OH      | 1Ø3W*           | #6-2/0           | #14-1/0 | 6          | 14 | 48 | 2½        | 2½ | 3  | 3  | ¼    | ½  |
| 215MTB-48      | 5        | OH      | 3Ø3W            | #6-2/0           | #14-1/0 | 6          | 14 | 48 | 2½        | 2½ | 3  | 3  | ¼    | ½  |
| 217MTB-48      | 7        | OH      | 3Ø4W            | #6-2/0           | #14-1/0 | 6          | 14 | 48 | 2½        | 2½ | 3  | 3  | ¼    | ½  |
| U214MTB-48*    | 4        | OH/UG   | 1Ø3W*           | #6-2/0           | #14-1/0 | 4⅝         | 18 | 25 | 2         | 2  | 2½ | 1½ | ½, ¾ | 1½ |
| U217MTB-48     | 7        | OH/UG   | 3Ø4W            | #6-2/0           | #14-1/0 | 4⅝         | 18 | 25 | 2         | 2  | 2½ | 1½ | ½, ¾ | 1½ |

## Notes

- **Replacement Main Disconnects:** For replacement main disconnect see pages 42-43.
  - **Hubs:** OH units use hub up to 2-1/2" (see accessory page). Units provided with closing plates.
  - **Sealing Rings:** Units furnished with MR-2 snap style sealing rings.
- \* For 3W (208Y/120) network service, install field mounted fifth terminal catalog number 105J. See accessories page.

**These UL listed products are for use in areas requiring Electrical Utility Service Equipment Requirements Committee (EUSERC) compliance.**



Please consult serving utility for their requirements prior to ordering or installing, as specifications and approvals vary by utility, and may require local electrical inspector approval. All installations must be installed by a licensed electrician and must comply with all national and local codes, laws and regulations. Milbank reserves the right to make changes in specifications and features shown without notice or obligation.

# Test Block Bypass/MTB-P & MTB-P48 Series

# 35

100 AMP  
TEST BLOCK  
BYPASS

100 Amp | 4, 5 & 7 Terminal | Ring Type | 200K AIC



214MTB-P

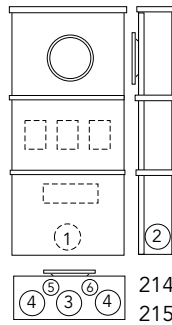

- 214MTB-P
- 215MTB-P
- 217MTB-P
- 214MTB-P48
- 215MTB-P48
- 217MTB-P48

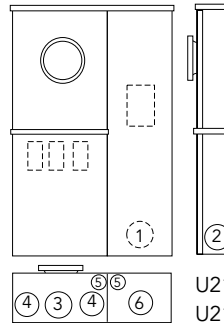

- U214MTB-P
- U215MTB-P
- U217MTB-P
- U214MTB-P48
- U215MTB-P48
- U217MTB-P48



U217MTB-P

## 100 Amp | 4, 5 & 7 Terminal | Ring Type | 240 Volt Self-Contained | T-Fuse Pullout

| Catalog Number | Terminal | Service | Type of Service | Connectors CU/AL |         | Dimensions |    |    | Knockouts |    |    |    |      |    |
|----------------|----------|---------|-----------------|------------------|---------|------------|----|----|-----------|----|----|----|------|----|
|                |          |         |                 | Line             | Load    | D"         | W" | H" | 1         | 2  | 3  | 4  | 5    | 6  |
| 214MTB-P*      | 4        | OH      | 1Ø3W*           | #1/0-250         | #14-1/0 | 6          | 14 | 48 | 2½        | 2½ | 3  | 3  | ¼    | ½  |
| 215MTB-P       | 5        | OH      | 3Ø3W            | #1/0-250         | #14-1/0 | 6          | 14 | 48 | 2½        | 2½ | 3  | 3  | ¼    | ½  |
| 217MTB-P       | 7        | OH      | 3Ø4W            | #1/0-250         | #14-1/0 | 6          | 14 | 48 | 2½        | 2½ | 3  | 3  | ¼    | ½  |
| U214MTB-P*     | 4        | OH/UG   | 1Ø3W*           | #6-2/0           | #14-1/0 | 4½         | 18 | 25 | 2         | 2  | 2½ | 1½ | ½, ¾ | 1½ |
| U215MTB-P      | 5        | OH/UG   | 3Ø3W            | #6-2/0           | #14-1/0 | 4½         | 18 | 25 | 2         | 2  | 2½ | 1½ | ½, ¾ | 1½ |
| U217MTB-P      | 7        | OH/UG   | 3Ø4W            | #6-2/0           | #14-1/0 | 4½         | 18 | 25 | 2         | 2  | 2½ | 1½ | ½, ¾ | 1½ |

## 100 Amp | 4, 5 & 7 Terminal | Ring Type | 480 Volt Self-Contained | T-Fuse Pullout

| Catalog Number | Terminal | Service | Type of Service | Connectors CU/AL |         | Dimensions |    |    | Knockouts |    |    |    |      |    |
|----------------|----------|---------|-----------------|------------------|---------|------------|----|----|-----------|----|----|----|------|----|
|                |          |         |                 | Line             | Load    | D"         | W" | H" | 1         | 2  | 3  | 4  | 5    | 6  |
| 214MTB-P48*    | 4        | OH      | 1Ø3W*           | #6-2/0           | #14-1/0 | 6          | 14 | 48 | 2½        | 2½ | 3  | 3  | ¼    | ½  |
| 215MTB-P48     | 5        | OH      | 3Ø3W            | #6-2/0           | #14-1/0 | 6          | 14 | 48 | 2½        | 2½ | 3  | 3  | ¼    | ½  |
| 217MTB-P48     | 7        | OH      | 3Ø4W            | #6-2/0           | #14-1/0 | 6          | 14 | 48 | 2½        | 2½ | 3  | 3  | ¼    | ½  |
| U214MTB-P48*   | 4        | OH/UG   | 1Ø3W*           | #6-2/0           | #14-1/0 | 4½         | 18 | 25 | 2         | 2  | 2½ | 1½ | ½, ¾ | 1½ |
| U215MTB-P48    | 5        | OH/UG   | 3Ø3W            | #6-2/0           | #14-1/0 | 4½         | 18 | 25 | 2         | 2  | 2½ | 1½ | ½, ¾ | 1½ |
| U217MTB-P48    | 7        | OH/UG   | 3Ø4W            | #6-2/0           | #14-1/0 | 4½         | 18 | 25 | 2         | 2  | 2½ | 1½ | ½, ¾ | 1½ |

### Notes

- **Replacement Main Disconnects:** For replacement main disconnect see pages 42-43.
  - **Hubs:** OH units use hub up to 2-1/2" (see accessory page). Units provided with closing plates.
  - **Sealing Rings:** Units furnished with MR-2 snap style sealing rings.
  - **Pull-Outs:** For use with T-fuses only. Fuses are included with fused safety sockets.
- \* For 3W (208Y/120) network service, install field mounted fifth terminal catalog number 105J. See accessories page.

*These UL listed products are for use in areas requiring  
Electrical Utility Service Equipment Requirements Committee (EUSERC) compliance.*

Please consult serving utility for their requirements prior to ordering or installing, as specifications and approvals vary by utility, and may require local electrical inspector approval. All installations must be installed by a licensed electrician and must comply with all national and local codes, laws and regulations. Milbank reserves the right to make changes in specifications and features shown without notice or obligation.



# Test Block Bypass/MTB Series

200 Amp | 4, 5 & 7 Terminal | Ring Type | 10K AIC



227MTB

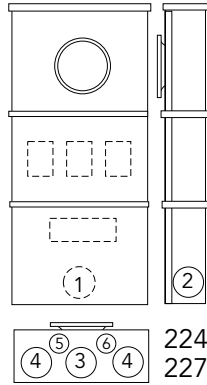

224MTB  
227MTB

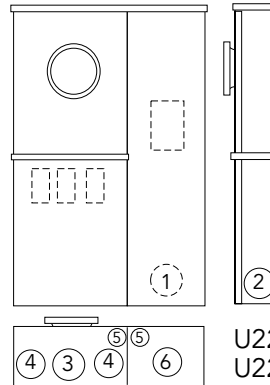

U224MTB  
U227MTB



U224MTB

200 Amp | 4 & 7 Terminal | Ring Type | 240 Volt Self-Contained | Circuit Breaker

| Catalog Number | Terminal | Service | Type of Service | Connectors CU/AL |          | Dimensions |     |    | Knockouts |    |    |    |     |    |
|----------------|----------|---------|-----------------|------------------|----------|------------|-----|----|-----------|----|----|----|-----|----|
|                |          |         |                 | Line             | Load     | D"         | W"  | H" | 1         | 2  | 3  | 4  | 5   | 6  |
| 224MTB*        | 4        | OH      | 1Ø3W*           | #6-250           | #2/0-250 | 6          | 14  | 48 | 2½        | 2½ | 3  | 3  | ½   | ¼  |
| 227MTB         | 7        | OH      | 3Ø4W            | #6-250           | #2/0-250 | 6          | 14  | 48 | 2½        | 2½ | 3  | 3  | ½   | ¼  |
| U224MTB*       | 4        | OH/UG   | 1Ø3W*           | #6-250           | #2/0-250 | 6          | 22¾ | 30 | 2½        | 2½ | 2½ | 1½ | ½,¾ | 1½ |
| U227MTB        | 7        | OH/UG   | 3Ø4W            | #6-250           | #2/0-250 | 6          | 22¾ | 30 | 2½        | 2½ | 2½ | 1½ | ½,¾ | 1½ |

## Notes

- **Replacement Main Disconnects:** For replacement main disconnect see pages 42-43.
- **Hubs:** OH units use hub up to 2-1/2" (see accessory page). Units provided with closing plates.
- **Sealing Rings:** Units furnished with MR-2 snap style sealing rings.
- \* For 3W (208Y/120) network service, install field mounted fifth terminal catalog number 105J. See accessories page.

**These UL listed products are for use in areas requiring Electrical Utility Service Equipment Requirements Committee (EUSERC) compliance.**



Please consult serving utility for their requirements prior to ordering or installing, as specifications and approvals vary by utility, and may require local electrical inspector approval. All installations must be installed by a licensed electrician and must comply with all national and local codes, laws and regulations. Milbank reserves the right to make changes in specifications and features shown without notice or obligation.

# Test Block Bypass/MTB Series

200 Amp | 4 & 7 Terminal | Ring Type | 22K AIC

**37**  
200 AMP  
TEST BLOCK  
BYPASS



227MTB/22

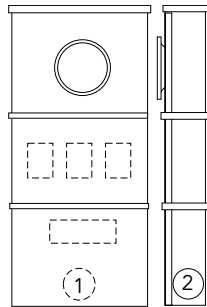

224MTB/22  
227MTB/22

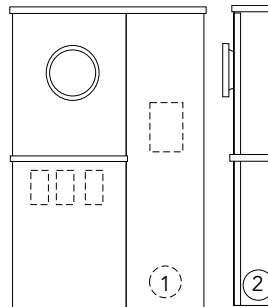

U224MTB/22  
U227MTB/22



U224MTB/22

200 Amp | 4 & 7 Terminal | Ring Type | 240 Volt Self-Contained | Circuit Breaker

| Catalog Number | Terminal | Service | Type of Service | Connectors CU/AL |          | Dimensions |     |    | Knockouts |    |    |    |     |    |
|----------------|----------|---------|-----------------|------------------|----------|------------|-----|----|-----------|----|----|----|-----|----|
|                |          |         |                 | Line             | Load     | D"         | W"  | H" | 1         | 2  | 3  | 4  | 5   | 6  |
| 224MTB/22*     | 4        | OH      | 1Ø3W*           | #6-250           | #2/0-250 | 6          | 14  | 48 | 2½        | 2½ | 3  | 3  | ½   | ¼  |
| 227MTB/22      | 7        | OH      | 3Ø4W            | #6-250           | #2/0-250 | 6          | 14  | 48 | 2½        | 2½ | 3  | 3  | ½   | ¼  |
| U224MTB/22*    | 4        | OH/UG   | 1Ø3W*           | #6-250           | #2/0-250 | 6          | 22¾ | 30 | 2½        | 2½ | 2½ | 1½ | ½,¾ | 1½ |
| U227MTB/22     | 7        | OH/UG   | 3Ø4W            | #6-250           | #2/0-250 | 6          | 22¾ | 30 | 2½        | 2½ | 2½ | 1½ | ½,¾ | 1½ |

## Notes

- **Replacement Main Disconnects:** For replacement main disconnect see pages 42-43.
  - **Hubs:** OH units use hub up to 2-1/2" (see accessory page). Units provided with closing plates.
  - **Sealing Rings:** Units furnished with MR-2 snap style sealing rings.
- \* For 3W (208Y/120) network service, install field mounted fifth terminal catalog number 105J. See accessories page.

Please consult serving utility for their requirements prior to ordering or installing, as specifications and approvals vary by utility, and may require local electrical inspector approval. All installations must be installed by a licensed electrician and must comply with all national and local codes, laws and regulations. Milbank reserves the right to make changes in specifications and features shown without notice or obligation.



# Test Block Bypass/MTB Series

200 Amp | 4 & 7 Terminal | Ring Type | 35K AIC | 480 Volt



227MTB-48

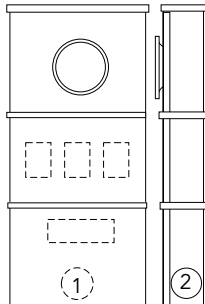

224MTB-48  
227MTB-48

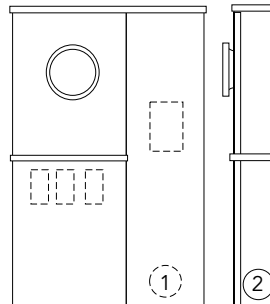

U224MTB-48  
U227MTB-48



U224MTB-48

## 200 Amp | 4 & 7 Terminal | Ring Type | 480 Volt Self-Contained | Circuit Breaker

| Catalog Number | Terminal | Service | Type of Service | Connectors CU/AL |          | Dimensions |     |    | Knockouts |    |    |    |    |    |
|----------------|----------|---------|-----------------|------------------|----------|------------|-----|----|-----------|----|----|----|----|----|
|                |          |         |                 | Line             | Load     | D"         | W"  | H" | 1         | 2  | 3  | 4  | 5  | 6  |
| 224MTB-48*     | 4        | OH      | 1Ø3W*           | #6-250           | #2/0-250 | 6          | 22¾ | 30 | 2½        | 2½ | 3  | 2½ | ½  | ¼  |
| U224MTB-48     | 4        | OH/UG   | 1Ø3W*           | #6-250           | #2/0-250 | 6          | 22¾ | 30 | 2½        | 2½ | 3  | 2½ | ½  | ¼  |
| 227MTB-48      | 7        | OH      | 3Ø4W            | #6-250           | #2/0-250 | 6          | 14  | 48 | 2½        | 2½ | 3  | 3  | ½  | ¼  |
| U227MTB-48     | 7        | OH/UG   | 3Ø4W            | #6-250           | #2/0-250 | 6          | 22¾ | 30 | 2½        | 2½ | 2½ | 1½ | ½¾ | 1½ |

### Notes

- **Replacement Main Disconnects:** For replacement main disconnect see pages 42-43.
  - **Hubs:** OH units use hub up to 2-1/2" (see accessory page). Units provided with closing plates.
  - **Sealing Rings:** Units furnished with MR-2 snap style sealing rings.
- \* For 3W (208Y/120) network service, install field mounted fifth terminal catalog number 105J. See accessories page.



Please consult serving utility for their requirements prior to ordering or installing, as specifications and approvals vary by utility, and may require local electrical inspector approval. All installations must be installed by a licensed electrician and must comply with all national and local codes, laws and regulations. Milbank reserves the right to make changes in specifications and features shown without notice or obligation.

# Test Block Bypass/MTB-P & MTB-P48

200 Amp | Ring Type | 200K AIC

**39**  
200 AMP  
TEST BLOCK  
BYPASS



224MTB-P

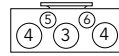
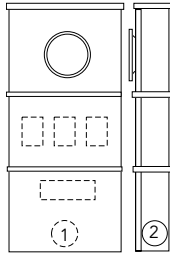

224MTB-P  
225MTB-P  
227MTB-P  
224MTB-P48  
225MTB-P48  
227MTB-P48

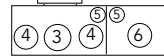
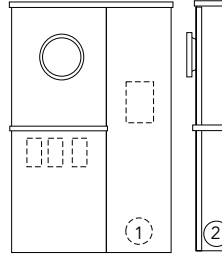

U224MTB-P  
U227MTB-P  
U224MTB-P48  
U227MTB-P48



U227MTB-P

200 Amp | 4, 5 & 7 Terminal | Ring Type | 240 Volt Self-Contained | T-Fuse Pullout

| Catalog Number | Terminal | Service | Type of Service | Connectors CU/AL |          | Dimensions |     |    | Knockouts |    |   |    |     |    |
|----------------|----------|---------|-----------------|------------------|----------|------------|-----|----|-----------|----|---|----|-----|----|
|                |          |         |                 | Line             | Load     | D"         | W"  | H" | 1         | 2  | 3 | 4  | 5   | 6  |
| 224MTB-P*      | 4        | OH      | 1Ø3W*           | #6-250           | #1/0-250 | 6          | 14  | 48 | 2½        | 2½ | 3 | 3  | ¼   | ½  |
| 225MTB-P       | 5        | OH      | 3Ø3W            | #6-250           | #1/0-250 | 6          | 14  | 48 | 2½        | 2½ | 3 | 3  | ¼   | ½  |
| 227MTB-P       | 7        | OH      | 3Ø4W            | #6-250           | #1/0-250 | 6          | 14  | 48 | 2½        | 2½ | 3 | 3  | ¼   | ½  |
| U224MTB-P*     | 4        | OH/UG   | 1Ø3W*           | #6-250           | #1/0-250 | 6          | 22¾ | 30 | 2½        | 2½ | 3 | 2½ | ½,¾ | 2½ |
| U227MTB-P      | 7        | OH/UG   | 3Ø4W            | #6-250           | #1/0-250 | 6          | 22¾ | 30 | 2½        | 2½ | 3 | 2½ | ½,¾ | 2½ |

200 Amp | 4, 5 & 7 Terminal | Ring Type | 480 Volt Self-Contained | T-Fuse Pullout

| Catalog Number | Terminal | Service | Type of Service | Connectors CU/AL |          | Dimensions |     |    | Knockouts |    |   |    |     |    |
|----------------|----------|---------|-----------------|------------------|----------|------------|-----|----|-----------|----|---|----|-----|----|
|                |          |         |                 | Line             | Load     | D"         | W"  | H" | 1         | 2  | 3 | 4  | 5   | 6  |
| 224MTB-P48*    | 4        | OH      | 1Ø3W*           | #6-250           | #1/0-250 | 6          | 14  | 48 | 2½        | 2½ | 3 | 3  | ¼   | ½  |
| 225MTB-P48     | 5        | OH      | 3Ø3W            | #6-250           | #1/0-250 | 6          | 14  | 48 | 2½        | 2½ | 3 | 3  | ¼   | ½  |
| 227MTB-P48     | 7        | OH      | 3Ø4W            | #6-250           | #1/0-250 | 6          | 14  | 48 | 2½        | 2½ | 3 | 3  | ¼   | ½  |
| U224MTB-P48*   | 4        | OH/UG   | 1Ø3W*           | #6-250           | #1/0-250 | 6          | 22¾ | 30 | 2½        | 2½ | 3 | 2½ | ½,¾ | 2½ |
| U227MTB-P48    | 7        | OH/UG   | 3Ø4W            | #6-250           | #1/0-250 | 6          | 22¾ | 30 | 2½        | 2½ | 3 | 2½ | ½,¾ | 2½ |

## Notes

- **Replacement Main Disconnects:** For replacement main disconnect see pages 42-43.
  - **Hubs:** OH units use hub up to 2-1/2" (see accessory page). Units provided with closing plates.
  - **Sealing Rings:** Units furnished with MR-2 snap style sealing rings.
  - **Pull-Outs:** For use with T-fuses only. Fuses are included with fused safety sockets.
- \* For 3W (208Y/120) network service, install field mounted fifth terminal catalog number 105J. See accessories page.

Please consult serving utility for their requirements prior to ordering or installing, as specifications and approvals vary by utility, and may require local electrical inspector approval. All installations must be installed by a licensed electrician and must comply with all national and local codes, laws and regulations. Milbank reserves the right to make changes in specifications and features shown without notice or obligation.



# Test Block Bypass/MTBL

All-In-One Series | 100 & 200 Amp | 10K & 200K AIC



U227MTBL

100 & 200 Amp | 240 Volt Meter Main | Circuit Breaker/T-Fuse Pullout

| Catalog Number | Rating                            | No. Internal Circuits | Main Circuit Breaker Or Fuse Pullout | Dimensions      |    |                  | Bottom Knockouts  | Back Knockouts  |
|----------------|-----------------------------------|-----------------------|--------------------------------------|-----------------|----|------------------|---|---|
|                |                                   |                       |                                      | D"              | W" | H"               |   |   |
| U214MTBL*      | 100A, 120/240 VAC 1Ø3W            | 12/24                 | 100A, 2P, 10K Milbank Q2100          | 4 $\frac{5}{8}$ | 25 | 24 $\frac{3}{4}$ | <b>Utility Section</b><br>(1) ½"<br>(3) 1¼", 1½", 2", 2½"<br><br><b>Customer Section</b><br>(3) ½", ¾"<br>(1) ½", ¾", 1", 1¼"<br>(2) ¾", 1", 1¼", 1½"                               | <b>Customer Section</b><br>(7) ½"<br>(4) ½", ¾"<br>(1) ¾", 1", 1¼", 1½" |
| U214MTBPL*     | 100A, 120/240 VAC 1Ø3W            | 12/24                 | 100A, 2P, 200K Boltswitch PT223      | 4 $\frac{5}{8}$ | 25 | 24 $\frac{3}{4}$ |   |   |
| U217MTBL       | 100A, 240Δ/120; 208Y/120 VAC 3Ø4W | 18/36                 | 100A, 3P, 10K Siemens BQ3100         | 4 $\frac{5}{8}$ | 25 | 24 $\frac{3}{4}$ |   |   |
| U217MTBPL      | 100A, 240Δ/120; 208Y/120 VAC 3Ø4W | 18/36                 | 100A, 3P, 200K Boltswitch PT323      | 4 $\frac{5}{8}$ | 25 | 24 $\frac{3}{4}$ |   |   |
| U224MTBL*      | 200A, 120/240 VAC 1Ø3W            | 20/40                 | 200A, 2P, 10K Milbank UQFP-200       | 6               | 27 | 30               | <b>Utility Section</b><br>(1) ½", ¾"<br>(2) 1¼", 1½", 2", 2½"<br>(1) 2½", 3"<br><br><b>Customer Section</b><br>(11) ½"<br>(2) ½", ¾"<br>(1) ½", ¾", 1", 1¼"<br>(2) ¾", 1", 1¼", 1½" | <b>Customer Section</b><br>(6) ½"<br>(4) ½", ¾"<br>(1) ¾", 1", 1¼", 1½" |
| U224MTBPL*     | 200A, 120/240 VAC 1Ø3W            | 20/40                 | 200A, 2P, 200K Boltswitch PT224      | 6               | 27 | 30               |   |   |
| U227MTBL       | 200A, 240Δ/120; 208Y/120 VAC 3Ø4W | 24/42                 | 200A, 3P, 10K Siemens QJ23B200       | 6               | 27 | 30               |   |   |
| U227MTBPL      | 200A, 240Δ/120; 208Y/120 VAC 3Ø4W | 24/42                 | 200A, 3P, 200K Boltswitch PT324      | 6               | 27 | 30               |   |   |

**Notes**

- **Line:** Underground or overhead service. Line Lug: 100A, 14-1/0 and 200A 1/0-250.
  - **Load:** Exit below load center only
  - **Branch Breakers:** Single phase units—approved for Siemens/ITE Type Q, Challenger, Cutler-Hammer/Westinghouse, General Electric, Murray. Three phase units—approved for Siemens/ITE Type Q.
  - **Hubs:** OH units use hub up to 2-1/2" (see accessory page). Units provided with closing plate.
  - **Pull-Outs:** For use with T-fuses only. Fuses are included with fused safety sockets.
- \* For 208Y/120 applications, order field kit **105J** separately and install.



Please consult serving utility for their requirements prior to ordering or installing, as specifications and approvals vary by utility, and may require local electrical inspector approval. All installations must be installed by a licensed electrician and must comply with all national and local codes, laws and regulations. Milbank reserves the right to make changes in specifications and features shown without notice or obligation.



# Test Block Bypass/MTBL

## Knockout Information

| Catalog Number | Knockouts |    |    |    |   |
|----------------|-----------|----|----|----|---|
|                | 1         | 2  | 3  | 4  | 5 |
| U214MTBL       | 2½        | 1½ | 1¼ | ¾  | ½ |
| U217MTBL       | 2½        | 1½ | 1¼ | ¾  | ½ |
| U227MTBL       | 3         | 2½ | 1½ | ¾  | ½ |
| U227MTBPL      | 3         | 2½ | 1½ | 1¼ | ¾ |

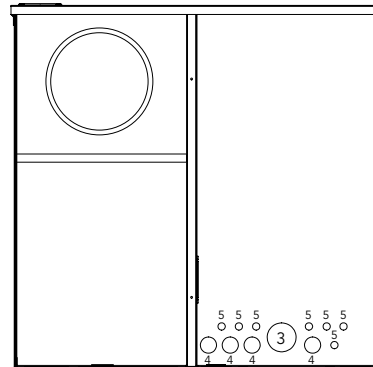

U214MTBL  
U217MTBL

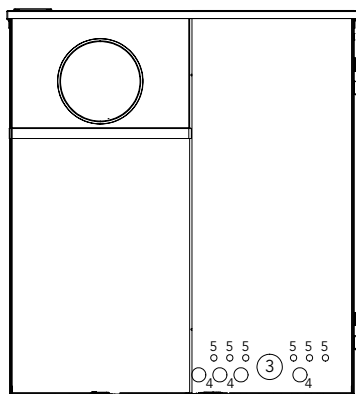

U227MTBL

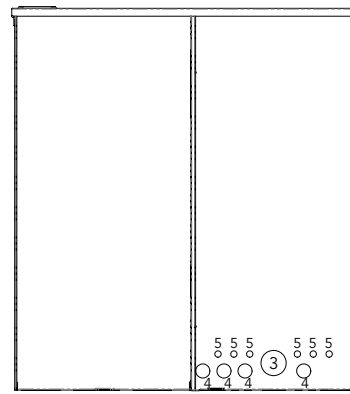

U227MTBPL

Please consult serving utility for their requirements prior to ordering or installing, as specifications and approvals vary by utility, and may require local electrical inspector approval. All installations must be installed by a licensed electrician and must comply with all national and local codes, laws and regulations. Milbank reserves the right to make changes in specifications and features shown without notice or obligation.



# Safety Socket Replacement

## Circuit Breakers

### Replacement Circuit Breakers

| Catalog Number | Circuit Breaker |
|----------------|-----------------|
| 214MTB         | BQ2B100L        |
| 214MTB-48      | ED42B100        |
| 214MTB/22      | BQ2B100HL       |
| U214MTB        | BQ2B100L        |
| U214MTB-48     | ED42B100        |
| U214MTB/22     | BQ2B100HL       |
| U214MTBL       | Q2100           |
|                |                 |
| 215MTB         | BQ3B100L        |
| 215MTB-48      | ED43B100L       |
| U215MTB        | BQ3B100L        |
| U215MTB-48     | ED43B100L       |
|                |                 |
| 217MTB         | BQ3B100L        |
| 217MTB48       | ED43B100L       |
| 217MTB/22      | BQ3B100HL       |
| U217MTB        | BQ3B100L        |
| U217MTB-48     | ED43B100L       |
| U217MTB/22     | BQ3B100HL       |
| U217MTBL       | BQ3B100L        |
|                |                 |
| 224MTB         | UQFB-200        |
| 224MTB/22      | UQFBH-200       |
| U224MTB        | UQFB-200        |
| U224MTB-48     | FXD62B200       |
| U224MTB/22     | UQFBH-200       |
| U224MTBL       | UQFB-200        |
|                |                 |
| U225MTB        | UQFB-3200       |

| Catalog Number | Circuit Breaker |
|----------------|-----------------|
| 227MTB         | UQFB-3200       |
| 227MTB-125     | UQFB-3125       |
| 227MTB-150     | UQFB-3150       |
| 227MTB-175     | UQFB-3175       |
| 227MTB-48      | FXD63B200L      |
| 227MTB/22      | QJH23B200L      |
| U227MTB        | UQFB-3200       |
| U227MTB-125    | UQFB-3125       |
| U227MTB-150    | UQFB-3150       |
| U227MTB-175    | UQFB-3175       |
| U227MTB-48     | FXD63B200L      |
| U227MTB/22     | QJH23B200L      |
| U227MTBL       | QJ23B200        |

### Lug Kits for Circuit Breakers

| Siemens Circuit Breaker | Number of Lug Collars Required |
|-------------------------|--------------------------------|
| ED42B100                | (2) LN13100                    |
| ED43B100                | (3) LN1E100                    |
| FXD62B200               | (4) TA1FD350                   |
| FXD63B200               | (6) TA1FD350                   |
| QJ22B200H               | (2) TA1Q300                    |
| QJ23B200                | (1) TA1Q300                    |
| QJH23B200L              | (1) TA1Q300                    |

### Note

When replacing Siemens Circuit Breaker (FXD,ED,QJ) in safety sockets, lug collars must be ordered from Siemens separately.



Please consult serving utility for their requirements prior to ordering or installing, as specifications and approvals vary by utility, and may require local electrical inspector approval. All installations must be installed by a licensed electrician and must comply with all national and local codes, laws and regulations. Milbank reserves the right to make changes in specifications and features shown without notice or obligation.

# Safety Socket Replacement

## T-Fuse Pullouts

### Replacement T-Fuse Pullouts

| Catalog Number | Circuit Breaker | Mfg.       | Part Number |
|----------------|-----------------|------------|-------------|
| 214MTB-P       | PT223           | Boltswitch | 707674-MO   |
| 214MTB-P48     | PT263           | Boltswitch | 708564-MO   |
| U214MTB-P      | PT223           | Boltswitch | 707674-MO   |
| U214MTB-P48    | PT263           | Boltswitch | 708564-MO   |
| U214MTBPL      | PT223           | Boltswitch | 707674-MO   |
| 215MTB-P       | PT323           | Boltswitch | 708565-MO   |
| 215MTB-P48     | PT363           | Boltswitch | 708566-MO   |
| U215MTB-P      | PT323           | Boltswitch | 708565-MO   |
| U215MTB-P48    | PT363           | Boltswitch | 708566-MO   |
| 217MTB-P       | PT323           | Boltswitch | 708565-MO   |
| 217MTB-P48     | PT363           | Boltswitch | 708566-MO   |
| U217MTB-P      | PT323           | Boltswitch | 708565-MO   |
| U217MTB-P48    | PT363           | Boltswitch | 708566-MO   |
| U217MTBPL      | PT323           | Boltswitch | 708565-MO   |
| 224MTB-P       | PT224           | Boltswitch | 707684-MO   |
| 224MTB-P48     | PT264           | Boltswitch | 708567-MO   |
| U224MTB-P      | PT224           | Boltswitch | 707684-MO   |
| U224MTB-P48    | PT264           | Boltswitch | 708567-MO   |
| U224MTBPL      | PT224           | Boltswitch | 707684-MO   |
| 225MTB-P48     | PT364           | Boltswitch | 708569-MO   |
| U225MTBPL      | PT324           | Boltswitch | 708568-MO   |
| 227MTB-P       | PT323           | Boltswitch | 708568-MO   |
| 227MTB-P48     | PT364           | Boltswitch | 708569-MO   |
| U227MTB-P      | PT324           | Boltswitch | 708568-MO   |
| U227MTB-P48    | PT364           | Boltswitch | 708569-MO   |
| U227MTBPL      | PT324           | Boltswitch | 708568-MO   |

### Lug Kits for T-Fuse Pullouts

| Part Number | Number of Lug Collars Required |
|-------------|--------------------------------|
| 707682-AC   | (2) TK100P                     |
| 708570-AC   | (2) TK200P                     |
| 707682-AC   | (2) TK100P                     |
| 708570-AC   | (2) TK200P                     |
| 707682-AC   | (3) TK100P                     |
| 708570-AC   | (3) TK200P                     |
| 707682-AC   | (3) TK100P                     |
| 708570-AC   | (3) TK200P                     |

### Note

T-Fuse pullouts provided with load side lugs. Order line side lugs separately from above chart.

Please consult serving utility for their requirements prior to ordering or installing, as specifications and approvals vary by utility, and may require local electrical inspector approval. All installations must be installed by a licensed electrician and must comply with all national and local codes, laws and regulations. Milbank reserves the right to make changes in specifications and features shown without notice or obligation.



# 44

SAFETY SOCKET  
& T-FUSE  
REPLACEMENT

# Safety Socket & T-Fuse Replacement



MS-27-TB



TB200-47

### Tenant Meter Sockets

| Catalog Number | Amp | Voltage/System |
|----------------|-----|----------------|
| MS-24-TB       | 200 | 600V/1Ø3W      |
| MS-25-TB       | 200 | 600V/3Ø3W      |
| MS-27-TB       | 200 | 600V/3Ø4W      |

### Replacement Test Blocks

| Catalog Number               | Amp | Phase          |
|------------------------------|-----|----------------|
| TB100-47                     | 100 | Phase A, B & C |
| TB100-5<br>Center Block Only | 100 | Phase B – 3Ø3W |
| TB200-47                     | 200 | Phase A, B & C |
| TB200-5<br>Center Block Only | 200 | Phase B – 3Ø3W |
| TB200-LL                     | 200 | Lug – Lug      |



PT324

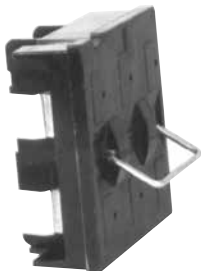

### 240 Volt Main Disconnects Pullout Switch (Uses Type "T" Fuse)

| Catalog Number | Amp | Rating            |
|----------------|-----|-------------------|
| PT223          | 100 | 2 Pole – 240 Volt |
| PT224          | 200 | 2 Pole – 240 Volt |
| PT323          | 100 | 3 Pole – 240 Volt |
| PT324          | 200 | 3 Pole – 240 Volt |

### 480 Volt Main Disconnects Pullout Switch (Uses Type "T" Fuse)

| Catalog Number | Amp | Rating            |
|----------------|-----|-------------------|
| PT263          | 100 | 2 Pole – 480 Volt |
| PT264          | 200 | 2 Pole – 480 Volt |
| PT363          | 100 | 3 Pole – 480 Volt |
| PT364          | 200 | 3 Pole – 480 Volt |

*These UL listed products are for use in areas requiring  
Electrical Utility Service Equipment Requirements Committee (EUSERC) compliance.*



Please consult serving utility for their requirements prior to ordering or installing, as specifications and approvals vary by utility, and may require local electrical inspector approval. All installations must be installed by a licensed electrician and must comply with all national and local codes, laws and regulations. Milbank reserves the right to make changes in specifications and features shown without notice or obligation.

# Underground Termination Boxes

600 VAC

**45**  
UNDERGROUND  
TERMINATION  
BOXES



PB-012



PB-038



PB-011



PB-032

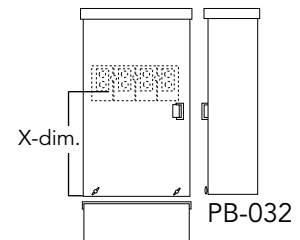
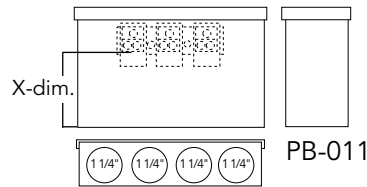
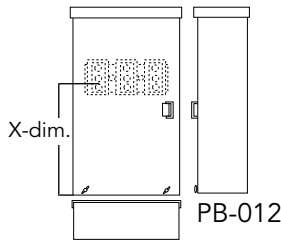

## Underground Termination Boxes | 600 VAC

| Catalog Number        | Amp | Type of Service | Connectors CU/AL |                        | Dimensions |    |    |       | Short Circuit Current Withstand Rating |
|-----------------------|-----|-----------------|------------------|------------------------|------------|----|----|-------|--|
|                       |     |                 | Line             | Load                   | D"         | W" | H" | X"    |  |
| PB-011*               | 100 | 1Ø3W            | #14-1/0          | #14-1/0                | 4          | 12 | 8½ | 3¾    | 10K Amp                                |
| PB-012                | 200 | 1Ø3W            | #6-250           | #6-250                 | 6          | 12 | 26 | 14¼   | 10K Amp                                |
| PB-014**<br>PB-014-NK | 400 | 1Ø3W            | ½"x13 Studs      | #4-600<br>Twin 1/0-250 | 6          | 16 | 36 | 22    | 50K Amp                                |
| PB-018**<br>PB-018-NK | 800 | 1Ø3W            | ½"x13 Studs**    | #4-600<br>Twin 1/0-250 | 11         | 24 | 48 | 26    | 50K Amp                                |
| PB-032                | 200 | 3Ø4W            | #6-250           | #6-250                 | 6          | 16 | 26 | 14¼/6 | 10K Amp                                |
| PB-034**<br>PB-034-NK | 400 | 3Ø4W            | ½"x13 Studs**    | #4-600<br>Twin 1/0-250 | 6          | 16 | 36 | 22    | 50K Amp                                |
| PB-038**              | 800 | 3Ø4W            | ½"x13 Studs**    | #4-600<br>Twin 1/0-250 | 11         | 24 | 48 | 26    | 50K Amp                                |

### Notes

- **Connectors and Bussing:** Extruded aluminum connectors and bus bars are tin plated.
- For no knockouts, add suffix -NK to the above catalog numbers.
- \* No lift handles provided on the **PB-011**.
- \*\* 2 studs per lug position provided for 400 amp units. 4 studs per lug position provided for 800 amp units.

Please consult serving utility for their requirements prior to ordering or installing, as specifications and approvals vary by utility, and may require local electrical inspector approval. All installations must be installed by a licensed electrician and must comply with all national and local codes, laws and regulations. Milbank reserves the right to make changes in specifications and features shown without notice or obligation.



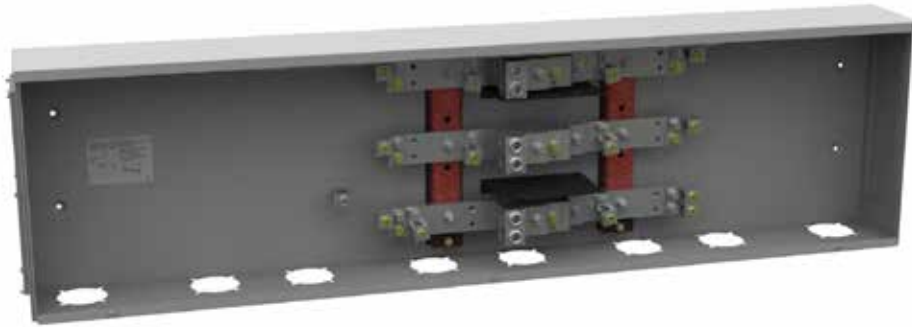

## For Commercial Safety Socket Applications

### Bussed Gutters | Type 3R | 1Ø3W | 600 VAC

| Catalog Number | Meter Position | Amp | Dimensions |                  |                  | Length of Bus | Line Lugs Per Each Bus | Load Lugs Per Bus |
|----------------|----------------|-----|------------|------------------|------------------|---------------|------------------------|-------------------|
|                |                |     | D"         | W"               | H"               |               |                        |                   |
| BC214          | 2              | 400 | 6          | 28 $\frac{5}{8}$ | 15 $\frac{1}{2}$ | 20" Bar       | (1) 600                | (2) 6-250         |
| BC318          | 3              | 800 | 6          | 43               | 15 $\frac{1}{2}$ | (2) 20" Bars  | (2) 600                | (3) 6-250         |
| BC418          | 4              | 800 | 6          | 57 $\frac{1}{4}$ | 15 $\frac{1}{2}$ | (2) 20" Bars  | (2) 600                | (4) 6-250         |
| BC518          | 5              | 800 | 6          | 71 $\frac{5}{8}$ | 15 $\frac{1}{2}$ | (2) 20" Bars  | (2) 600                | (5) 6-250         |
| BC618          | 6              | 800 | 6          | 85 $\frac{7}{8}$ | 15 $\frac{1}{2}$ | (2) 20" Bars  | (2) 600                | (6) 6-250         |

### Bussed Gutters | Type 3R | 3Ø4W | 600 VAC

| Catalog Number | Meter Position | Amp | Dimensions |                  |                  | Length of Bus | Line Lugs Per Each Bus | Load Lugs Per Bus |
|----------------|----------------|-----|------------|------------------|------------------|---------------|------------------------|-------------------|
|                |                |     | D"         | W"               | H"               |               |                        |                   |
| BC234          | 2              | 400 | 6          | 28 $\frac{5}{8}$ | 15 $\frac{1}{2}$ | 20" Bar       | (1) 600                | (2) 6-250         |
| BC338          | 3              | 800 | 6          | 43               | 15 $\frac{1}{2}$ | (2) 20" Bars  | (2) 600                | (3) 6-250         |
| BC438          | 4              | 800 | 6          | 57 $\frac{1}{4}$ | 15 $\frac{1}{2}$ | (2) 20" Bars  | (2) 600                | (4) 6-250         |
| BC538          | 5              | 800 | 6          | 71 $\frac{5}{8}$ | 15 $\frac{1}{2}$ | (2) 20" Bars  | (2) 600                | (5) 6-250         |
| BC638          | 6              | 800 | 6          | 85 $\frac{7}{8}$ | 15 $\frac{1}{2}$ | (2) 20" Bars  | (2) 600                | (6) 6-250         |

### Notes

- **Short Circuit Current Withstanding Rating:** Standard bracing is 42K AIC.
- **Connectors and Bussing:** Extruded aluminum connectors and bus bars are tin plated.
- **Cover:** Lift handles provided along with a cover sealing provision. A removable, sealable cover is provided at both ends for pull box assembly.
- **Hardware:** Meter socket mounting hardware included.
- Suitable for use on line side of service equipment.



Please consult serving utility for their requirements prior to ordering or installing, as specifications and approvals vary by utility, and may require local electrical inspector approval. All installations must be installed by a licensed electrician and must comply with all national and local codes, laws and regulations. Milbank reserves the right to make changes in specifications and features shown without notice or obligation.

# Bussed Gutters

Type 3R | 3Ø4W | 600 VAC



- Enclosure without knockouts
- Tin plated aluminum bus bars
- Furnished with line lugs only
- Bus is drilled and tapped for easy installation of load lugs

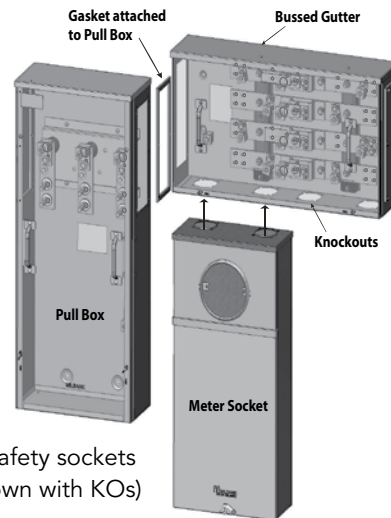

Typical application of safety sockets with multi-metering (shown with KOs)

## Bussed Gutters | Type 3R | 1Ø4W | 600 VAC

| Catalog Number | Meter Position | Amp | Dimensions |    |    | Length of Bus | Line Lugs Per Each Bus |
|----------------|----------------|-----|------------|----|----|---------------|------------------------|
|                |                |     | D"         | W" | H" |               |                        |
| U3412-O        | 2              | 400 | 6          | 24 | 24 | 17" Bar       | (1) 600                |
| U3413-O        | 3              | 600 | 6          | 36 | 24 | 24" Bars      | (2) 600                |
| U3414-O        | 4              | 800 | 6          | 48 | 24 | 32" Bars      | (3) 600                |
| U3415-O        | 5              | 800 | 6          | 60 | 24 | 40" Bars      | (3) 600                |
| U3416-O        | 6              | 800 | 6          | 72 | 24 | 56" Bars      | (3) 600                |

## Bussed Gutters | Type 3R | 3Ø4W | 600 VAC

| Catalog Number | Meter Position | Amp | Dimensions |    |    | Length of Bus | Line Lugs Per Each Bus |
|----------------|----------------|-----|------------|----|----|---------------|------------------------|
|                |                |     | D"         | W" | H" |               |                        |
| U3462-O        | 2              | 400 | 6          | 24 | 24 | 17" Bar       | (1) 600                |
| U3463-O        | 3              | 600 | 6          | 36 | 24 | 24" Bars      | (2) 600                |
| U3464-O        | 4              | 800 | 6          | 48 | 24 | 32" Bars      | (3) 600                |
| U3465-O        | 5              | 800 | 6          | 60 | 24 | 40" Bars      | (3) 600                |
| U3466-O        | 6              | 800 | 6          | 72 | 24 | 56" Bars      | (3) 600                |

### Notes

- **Short Circuit Current Withstanding Rating:** The 400 and 600 amp units have a withstand rating of 50K amp, and the 800 amp units have a rating of 65K amp.
- Suitable for use on line side of service equipment.

Please consult serving utility for their requirements prior to ordering or installing, as specifications and approvals vary by utility, and may require local electrical inspector approval. All installations must be installed by a licensed electrician and must comply with all national and local codes, laws and regulations. Milbank reserves the right to make changes in specifications and features shown without notice or obligation.



# 48

100-125 AMP  
MULTI-POSITION  
SOCKETS

# Multi-Position Sockets

100-125 Amp | 4 Terminal | Ringless | 300 VAC



U8032-XL

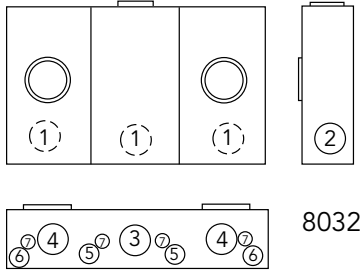

8032



U3522-XL-K1

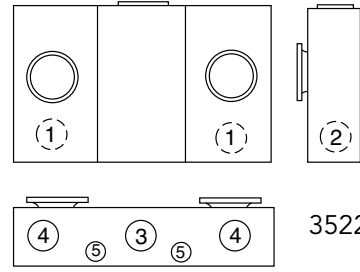

3522

100 Amp per Position | 4 Terminal | Multi-Position | Horizontal Gangs | Ringless

| Catalog Number | Positions | Service | Hub  | Connectors CU/AL |        | Dimensions |     |    | Knockouts |   |    |       |   |   |   |
|----------------|-----------|---------|------|------------------|--------|------------|-----|----|-----------|---|----|-------|---|---|---|
|                |           |         |      | Line             | Load   | D"         | W"  | H" | 1         | 2 | 3  | 4     | 5 | 6 | 7 |
| U8032-XL       | 2         | OH/UG   | C.P. | #2-350           | #6-2/0 | 4½         | 24½ | 16 | 2         | 2 | 2½ | 2     | ½ | ½ | ⅝ |
| U8033-XL       | 3         | OH/UG   | C.P. | #2-350           | #6-2/0 | 4½         | 32¾ | 16 | 2         | 2 | 2½ | (3) 2 | ½ | ½ | ⅝ |
| U8034-XL       | 4         | OH/UG   | C.P. | #2-350           | #6-2/0 | 4½         | 40⅞ | 16 | 2         | 2 | 2½ | (4) 2 | ½ | ½ | ⅝ |
| U8035-XL       | 5         | OH/UG   | C.P. | #2-350           | #6-2/0 | 4½         | 49⅙ | 16 | 2         | 2 | 2½ | (5) 2 | ½ | ½ | ⅝ |
| U8036-XL       | 6         | OH/UG   | C.P. | #2-350           | #6-2/0 | 4½         | 57¼ | 16 | 2         | 2 | 2½ | (6) 2 | ½ | ½ | ⅝ |

125 Amp per Position | 4 Terminal | Multi-Position | Horizontal Gangs | Ring Type

| Catalog Number | Positions | Service | Hub  | Connectors CU/AL |        | Dimensions |     |    | Knockouts |    |    |        |      |   |
|----------------|-----------|---------|------|------------------|--------|------------|-----|----|-----------|----|----|--------|------|---|
|                |           |         |      | Line             | Load   | D"         | W"  | H" | 1         | 2  | 3  | 4      | 5    | 6 |
| U3522-XL-K1    | 2         | OH/UG   | C.P. | #2-350           | #6-2/0 | 4½         | 24½ | 14 | 1½        | 1½ | 2½ | 2½     | ¼, ½ | ½ |
| U3523-XL-K1    | 3         | OH/UG   | C.P. | #2-350           | #6-2/0 | 4½         | 32¾ | 14 | 1½        | 1½ | 2½ | (3) 2½ | ¼, ½ | ½ |
| U3524-XL-K2    | 4         | OH/UG   | C.P. | #2-350           | #6-2/0 | 4½         | 40⅞ | 14 | 1½        | 1½ | 2½ | (4) 2½ | ¼, ½ | ½ |
| U3525-XL-K2    | 5         | UG      | C.P. | #2-350           | #6-2/0 | 4½         | 49⅙ | 14 | 1½        | 1½ | 2½ | (5) 2½ | ¼, ½ | ½ |

## Notes

- **Fifth Terminal:** For field mounted fifth terminal, order catalog number **5T8K2** (6 o'clock only on 100 amp units, 9 o'clock only on 125 amp units).
- **Hubs:** For proper hub selection, see the hub suffix chart on the accessory page.
- **Sealing Rings:** Ring type units are supplied with one **MR-4** screw type sealing ring per position.



Please consult serving utility for their requirements prior to ordering or installing, as specifications and approvals vary by utility, and may require local electrical inspector approval. All installations must be installed by a licensed electrician and must comply with all national and local codes, laws and regulations. Milbank reserves the right to make changes in specifications and features shown without notice or obligation.



# Multi-Position Sockets

200 Amp | 4 Terminal | Ringless | 300 VAC

**49**  
200 AMP  
MULTI-POSITION  
SOCKETS



U1252-X-K1

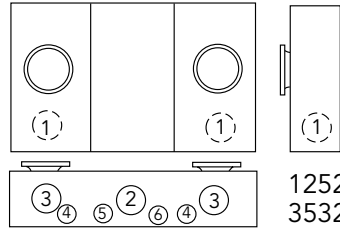

1252  
3532

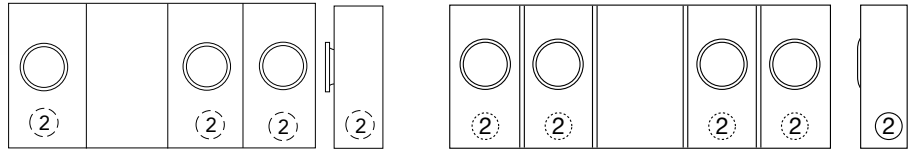

1253-6  
3533-6

1254  
3534

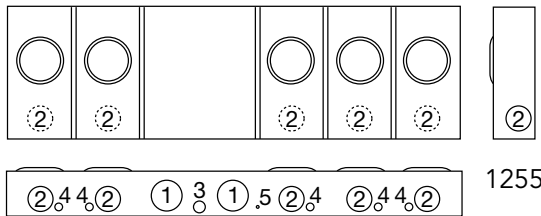

1255

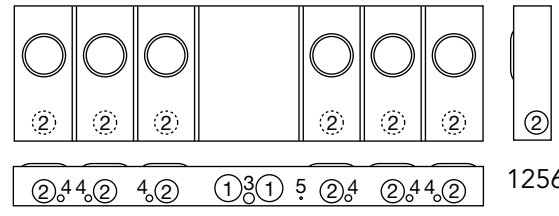

1256

200 Amp per Position | 4 Terminal | Multi-Position | Horizontal Gangs | Ringless

| Catalog Number | Positions | Service | Hub  | Connectors CU/AL |        | Dimensions      |                  |    | Knockouts       |                 |                 |               |               |  |
|----------------|-----------|---------|------|------------------|--------|-----------------|------------------|----|-----------------|-----------------|-----------------|---------------|---------------|--|
|                |           |         |      | Line             | Load   | D"              | W"               | H" | 1               | 2               | 3               | 4             | 5             |  |
| U1252-X-K1     | 2         | OH/UG   | C.P. | #6-350           | #2-350 | 5 $\frac{1}{8}$ | 26 $\frac{1}{2}$ | 14 | 2 $\frac{1}{2}$ | 3               | 2 $\frac{1}{2}$ | $\frac{1}{2}$ | $\frac{1}{4}$ |  |
| U1253-X-K3     | 3         | OH/UG   | C.P. | #4-600           | #2-350 | 5 $\frac{1}{8}$ | 34 $\frac{3}{4}$ | 14 | 3               | 2 $\frac{1}{2}$ | $\frac{1}{2}$   | $\frac{1}{4}$ | 1             |  |
| U1254-X-K3     | 4         | OH/UG   | C.P. | #4-600           | #2-350 | 5 $\frac{1}{8}$ | 42 $\frac{7}{8}$ | 16 | 3               | 2 $\frac{1}{2}$ | 1               | $\frac{1}{2}$ | $\frac{1}{4}$ |  |
| U1255-X-K4     | 5         | OH/UG   | C.P. | (2) #2-600       | #2-350 | 5 $\frac{1}{8}$ | 54 $\frac{7}{8}$ | 16 | 3               | 2 $\frac{1}{2}$ | 1               | $\frac{1}{2}$ | $\frac{1}{4}$ |  |
| U1256-X-K4     | 6         | OH/UG   | C.P. | (2) #2-600       | #2-350 | 5 $\frac{1}{8}$ | 63 $\frac{1}{6}$ | 18 | 3               | 2 $\frac{1}{2}$ | 1               | $\frac{1}{2}$ | $\frac{1}{4}$ |  |

200 Amp per Position | 4 Terminal | Multi-Position | Horizontal Gangs | Ring Type

| Catalog Number | Positions | Service | Hub  | Connectors CU/AL |        | Dimensions      |                  |    | Knockouts       |                 |                 |               |               |   |
|----------------|-----------|---------|------|------------------|--------|-----------------|------------------|----|-----------------|-----------------|-----------------|---------------|---------------|---|
|                |           |         |      | Line             | Load   | D"              | W"               | H" | 1               | 2               | 3               | 4             | 5             | 6 |
| U3532-X-K1     | 2         | OH/UG   | C.P. | #6-350           | #2-350 | 5 $\frac{1}{8}$ | 26 $\frac{1}{2}$ | 16 | 2 $\frac{1}{2}$ | 3               | 2 $\frac{1}{2}$ | —             | $\frac{1}{2}$ | 1 |
| U3533-X-K3     | 3         | OH/UG   | C.P. | #4-600           | #2-350 | 5 $\frac{1}{8}$ | 34 $\frac{1}{2}$ | 16 | 3               | 2 $\frac{1}{2}$ | —               | $\frac{1}{4}$ | $\frac{1}{2}$ | — |
| U3534-X-K3     | 4         | OH/UG   | C.P. | #4-600           | #2-350 | 5 $\frac{1}{8}$ | 42 $\frac{7}{8}$ | 16 | 3               | 2 $\frac{1}{2}$ | 1               | —             | $\frac{1}{2}$ | — |

## Notes

- **Fifth Terminal:** For field mounted fifth terminal, order catalog number **5T8K2** (6 o'clock only on 100 amp units, 9 o'clock only on 125 amp units).
- **Hubs:** For proper hub selection, see the hub suffix chart on the accessory page.
- **Sealing Rings:** Ring type units are supplied with one **MR-4** screw type sealing ring per position.

Please consult serving utility for their requirements prior to ordering or installing, as specifications and approvals vary by utility, and may require local electrical inspector approval. All installations must be installed by a licensed electrician and must comply with all national and local codes, laws and regulations. Milbank reserves the right to make changes in specifications and features shown without notice or obligation.



# 50

125-200 AMP  
MULTI-POSITION  
METER MAINS

# Multi-Position Meter Mains

125-200 Amp | 4 Terminal | Ringless | 120/240 VAC



U2854-X

125 Amp | Position

| Catalog Number | Positions | Main Bus Rating | Connectors CU/AL |
|----------------|-----------|-----------------|------------------|
|                |           |                 | Line             |
| U2852-X        | 2         | 200 Amp         | *3/8"-16 STUD    |
| U2853-X        | 3         | 200 Amp         | *3/8"-16 STUD    |



U2866-X

200 Amp | Position

| Catalog Number | Positions | Main Bus Rating | Connectors CU/AL |
|----------------|-----------|-----------------|------------------|
|                |           |                 | Line             |
| U2862-X        | 2         | 250 Amp         | *3/8"-16 STUD    |
| U2863-X        | 3         | 300 Amp         | *3/8"-16 STUD    |

## VERTICAL

125 Amp | Position

| Catalog Number | Positions | Main Bus Rating | Connectors CU/AL |
|----------------|-----------|-----------------|------------------|
|                |           |                 | Line             |
| U2854-X        | 4         | 400 Amp         | *3/8"-16 STUD    |
| U2855-X        | 5         | 400 Amp         | *3/8"-16 STUD    |
| U2856-X        | 6         | 400 Amp         | *3/8"-16 STUD    |

200 Amp | Position

| Catalog Number | Positions | Main Bus Rating | Connectors CU/AL |
|----------------|-----------|-----------------|------------------|
|                |           |                 | Line             |
| U2864-X        | 4         | 400 Amp         | *3/8"-16 STUD    |
| U2865-X        | 5         | 400 Amp         | *3/8"-16 STUD    |
| U2866-X        | 6         | 400 Amp         | *3/8"-16 STUD    |

## RECTANGULAR

### Connector Kits

| Size   | Suffix | Kit Number | Compatible With      | Wire Range |
|--------|--------|------------|----------------------|------------|
| SINGLE | -K1    | K1539      | U2852-56<br>U2862-66 | #6-350     |
|        | -K3    | K1540      | U2854-56<br>U2864-66 | #4-600     |
| TWIN   | -K2    | K1350      | U2854-56<br>U2863-66 | #6-350     |
|        | -K4    | K1541      | U2864-66             | #2-600     |

**Connectors:** For line wire connector kits, order separately.

**Fifth Terminal:** For field mounted fifth terminal order catalog number **K2381**. Order one per meter position (9 o'clock position only).

**Breakers:** Units have provision for one double pole main per meter position. Breakers not included. Order as extra Milbank.

\*To add lugs, refer to the connector kits available in the Connector Kits table.

| Amp     | Cutler-Hammer (Westinghouse) | Simens (ITE) | Siemens Murray/ Crouse-Hinds | G.E. | SQ-D     |
|---------|------------------------------|--------------|------------------------------|------|----------|
| 150-200 | HQP/BR/WBJ                   | QN           | MD                           | THQ  |          |
| ≤125    | QP/BR/HQP                    | QP           | MP                           | THQ  | Homeline |



Please consult serving utility for their requirements prior to ordering or installing, as specifications and approvals vary by utility, and may require local electrical inspector approval. All installations must be installed by a licensed electrician and must comply with all national and local codes, laws and regulations. Milbank reserves the right to make changes in specifications and features shown without notice or obligation.

# Multi-Position Meter Mains

125-200 Amp | 22K AIC Rated | 240 VAC

# 51

125-200 AMP  
MULTI-POSITION  
METER MAINS



U2852-X

## CONDOMINIUM METERING BANKS

### VERTICAL

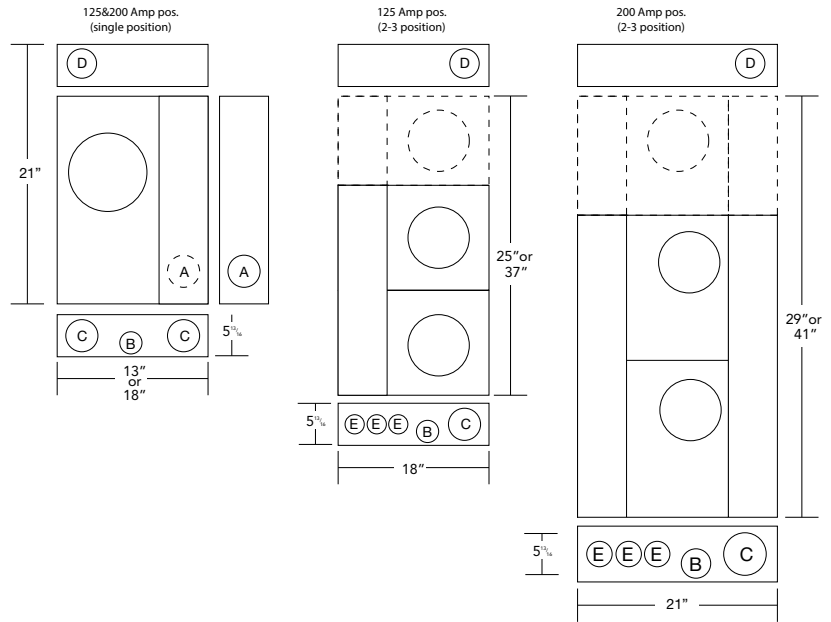

### RECTANGULAR

| Knockouts |           |
|-----------|-----------|
| A         | 1 1/4"    |
| B         | 1/4, 1/2" |
| C         | 3"        |
| D         | 4"        |
| E         | 2"        |

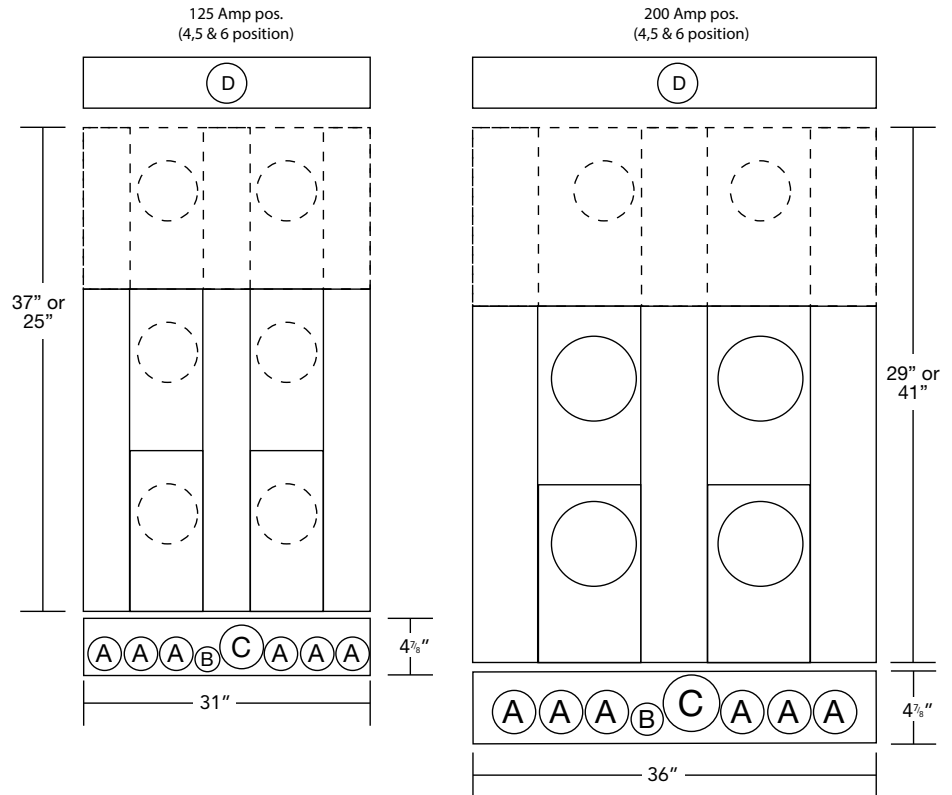

Please consult serving utility for their requirements prior to ordering or installing, as specifications and approvals vary by utility, and may require local electrical inspector approval. All installations must be installed by a licensed electrician and must comply with all national and local codes, laws and regulations. Milbank reserves the right to make changes in specifications and features shown without notice or obligation.



# 52

125-200 AMP  
MULTI-POSITION  
METER MAINS

# Multi-Position Meter Mains

125-200 Amp | 22K AIC Rated | 240 VAC



U5882-X



U5884-X

## 4 Terminal | Multi-Position Meter Main | Ringless

| Catalog Number | Amp | Positions | Service | Hub  | Connectors CU/AL | Bypass | Dimensions |          |     | Weight (lbs.) |
|----------------|-----|-----------|---------|------|------------------|--------|------------|----------|-----|---------------|
|                |     |           |         |      | Line             |        | D"         | W"       | H"  |               |
| U5902-X        | 125 | 2         | OH/UG   | C.P. | 3/8" x 16 Stud   | None   | 5 1/8"     | 26 1/2"  | 30" | 58            |
| U5903-X        | 125 | 3         | OH/UG   | C.P. | 3/8" x 16 Stud   | None   | 5 1/8"     | 34 5/8"  | 30" | 88            |
| U5904-X        | 125 | 4         | OH/UG   | C.P. | 3/8" x 16 Stud   | None   | 5 1/8"     | 42 5/8"  | 30" | 107           |
| U5905-X        | 125 | 5         | OH/UG   | C.P. | 3/8" x 16 Stud   | None   | 5 1/8"     | 51 1/20" | 30" | 128           |
| U5906-X        | 125 | 6         | OH/UG   | C.P. | 3/8" x 16 Stud   | None   | 5 1/8"     | 59 3/10" | 30" | 146           |
| U5882-X        | 200 | 2         | OH/UG   | C.P. | 3/8" x 16 Stud   | None   | 5 1/8"     | 26 1/2"  | 30" | 58            |
| U5883-X        | 200 | 3         | OH/UG   | C.P. | 3/8" x 16 Stud   | None   | 5 1/8"     | 34 5/8"  | 30" | 88            |
| U5884-X        | 200 | 4         | OH/UG   | C.P. | 3/8" x 16 Stud   | None   | 5 1/8"     | 42 5/8"  | 30" | 107           |
| U5885-X        | 200 | 5         | OH/UG   | C.P. | 3/8" x 16 Stud   | None   | 5 1/8"     | 51 1/20" | 30" | 128           |
| U5886-X        | 200 | 6         | OH/UG   | C.P. | 3/8" x 16 Stud   | None   | 5 1/8"     | 59 3/10" | 30" | 146           |

## Notes

- **Knockouts:** See drawings on the next page.
- **Optional:** Factory installed breakers are available—consult factory.
- **AIC Rating:** All models are rated 22K AIC when used with approved breakers rated at 22K.
- **Hub:** Units supplied with one (1) closing plate. Order hubs separately, see accessories page.
- **Fifth Terminal:** For field installed fifth terminal, order **K5T**.
- **Connectors:** Socket is supplied with 3/8" - 16 hex head nuts with Belleville washers. For connector lug kits, order as extra from chart on the accessories page. Separate lug kits are required for line and load.

## Breaker Chart - 10K AIC (unless noted 22K)

| Manufacturer    | Cutler Hammer | Siemens       | G.E. (50 Amp Max) | Square D |
|-----------------|---------------|---------------|-------------------|----------|
| 125 Amp or Less | BR, HQP, QPGF | QP, QPH (22K) | THQL, THQL-GF     | Homeline |
| 150-200 Amp     |               | QN, QNH (22K) | —                 | —        |



Please consult serving utility for their requirements prior to ordering or installing, as specifications and approvals vary by utility, and may require local electrical inspector approval. All installations must be installed by a licensed electrician and must comply with all national and local codes, laws and regulations. Milbank reserves the right to make changes in specifications and features shown without notice or obligation.

# Multi-Position Meter Mains

U5902 & U5882 Series | Dimensional Information

**53**  
125-200 AMP  
MULTI-POSITION  
METER MAINS

| Knockouts |    |   |     |   |
|-----------|----|---|-----|---|
| 1         | 2  | 3 | 4   | 5 |
| 3         | 2½ | 1 | 7/8 | ¼ |

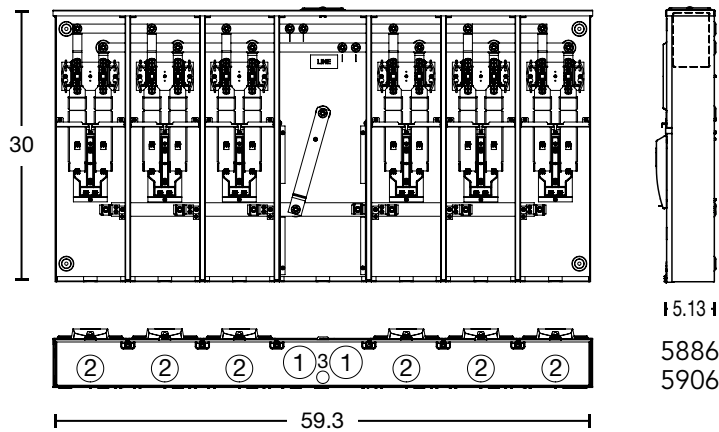
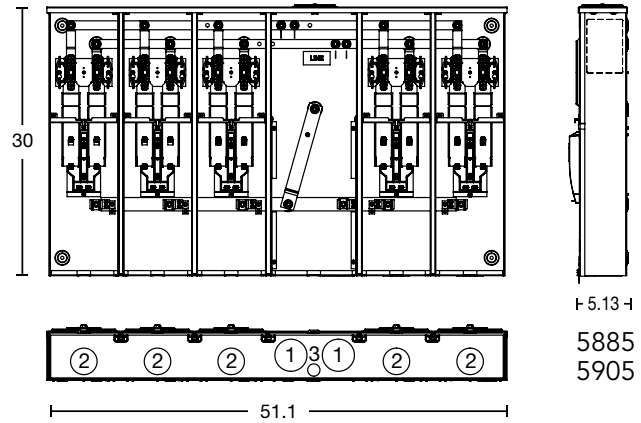
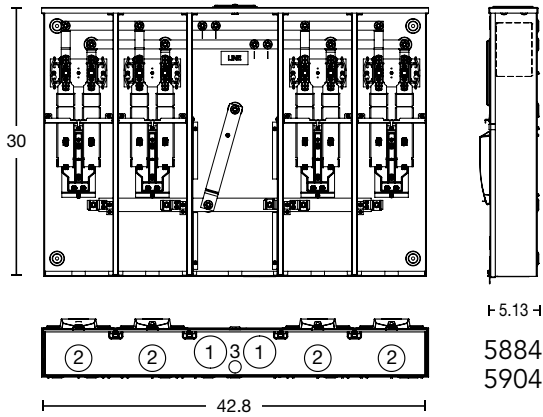
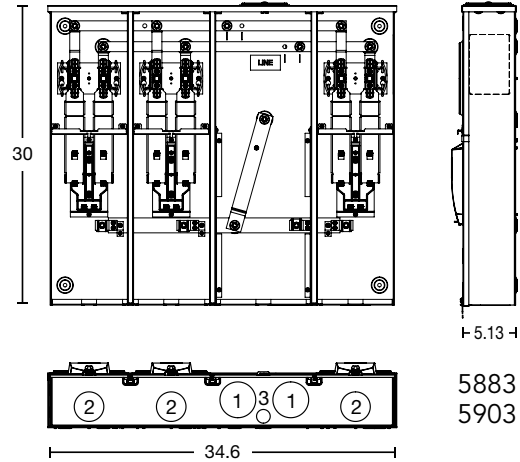
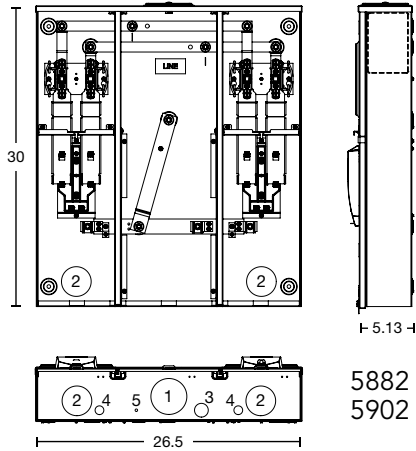

Please consult serving utility for their requirements prior to ordering or installing, as specifications and approvals vary by utility, and may require local electrical inspector approval. All installations must be installed by a licensed electrician and must comply with all national and local codes, laws and regulations. Milbank reserves the right to make changes in specifications and features shown without notice or obligation.





UC7582-XL

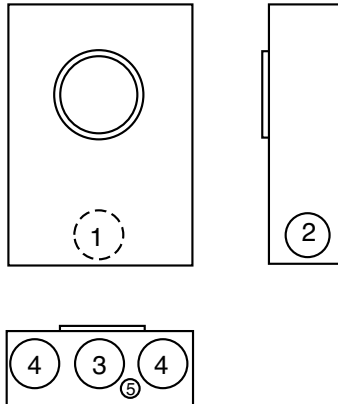

UC7237-RL

**20 Amp | Ringless | Plunger Type Bypass | Overhead/Underground**

| Catalog Number | Terminal | Meter Form           | Hub  | Bypass   | Connectors CU/AL |      | Dimensions                     |    |    | Knockouts                     |                               |   |                               |                               |
|----------------|----------|----------------------|------|----------|------------------|------|--------------------------------|----|----|-------------------------------|-------------------------------|---|-------------------------------|-------------------------------|
|                |          |                      |      |          | Line             | Load | D"                             | W" | H" | 1                             | 2                             | 3 | 4                             | 5                             |
| UC1290-XL      | 5        | 3S                   | C.P. | Plunger* | #14 - #10        |      | 3 <sup>5</sup> / <sub>16</sub> | 8  | 14 | 1 <sup>1</sup> / <sub>2</sub> | 1 <sup>1</sup> / <sub>2</sub> | 2 | 1 <sup>1</sup> / <sub>4</sub> | 1 <sup>1</sup> / <sub>4</sub> |
| UC1299-XL      | 6        | 4S                   | C.P. | Plunger* | #14 - #10        |      | 3 <sup>5</sup> / <sub>16</sub> | 8  | 14 | 1 <sup>1</sup> / <sub>2</sub> | 1 <sup>1</sup> / <sub>2</sub> | 2 | 1 <sup>1</sup> / <sub>4</sub> | 1 <sup>1</sup> / <sub>4</sub> |
| UC7233-XL      | 7        | 7, 14, 15 & 24 S     | C.P. | Plunger* | #14 - #10        |      | 3 <sup>5</sup> / <sub>16</sub> | 8  | 14 | 1 <sup>1</sup> / <sub>2</sub> | 1 <sup>1</sup> / <sub>2</sub> | 2 | 1 <sup>1</sup> / <sub>4</sub> | 1 <sup>1</sup> / <sub>4</sub> |
| UC7235-XL      | 8        | 5S                   | C.P. | Plunger* | #14 - #10        |      | 3 <sup>5</sup> / <sub>16</sub> | 8  | 14 | 1 <sup>1</sup> / <sub>2</sub> | 1 <sup>1</sup> / <sub>2</sub> | 2 | 1 <sup>1</sup> / <sub>4</sub> | 1 <sup>1</sup> / <sub>4</sub> |
| UC7237-XL      | 13       | 6, 8, 9S & (ALT) 10S | C.P. | Plunger* | #14 - #10        |      | 3 <sup>5</sup> / <sub>16</sub> | 8  | 14 | 1 <sup>1</sup> / <sub>2</sub> | 1 <sup>1</sup> / <sub>2</sub> | 2 | 1 <sup>1</sup> / <sub>4</sub> | 1 <sup>1</sup> / <sub>4</sub> |

**20 Amp | Ring Type | Plunger Type Bypass | Overhead/Underground**

| Catalog Number | Terminal | Meter Form           | Hub  | Bypass   | Connectors CU/AL |      | Dimensions                     |    |    | Knockouts                     |                               |                               |                               |                               |
|----------------|----------|----------------------|------|----------|------------------|------|--------------------------------|----|----|-------------------------------|-------------------------------|-------------------------------|-------------------------------|-------------------------------|
|                |          |                      |      |          | Line             | Load | D"                             | W" | H" | 1                             | 2                             | 3                             | 4                             | 5                             |
| UC1291-RL      | 5        | 3S                   | H.O. | Plunger* | #14 - #10 Max    |      | 3 <sup>5</sup> / <sub>16</sub> | 8  | 14 | 1 <sup>1</sup> / <sub>2</sub> | 1 <sup>1</sup> / <sub>2</sub> | 1 <sup>1</sup> / <sub>4</sub> | 1 <sup>1</sup> / <sub>4</sub> | 1 <sup>1</sup> / <sub>4</sub> |
| UC1300-RL      | 6        | 4S                   | H.O. | Plunger* | #14 - #10 Max    |      | 3 <sup>5</sup> / <sub>16</sub> | 8  | 14 | 1 <sup>1</sup> / <sub>2</sub> | 1 <sup>1</sup> / <sub>2</sub> | 1 <sup>1</sup> / <sub>4</sub> | 1 <sup>1</sup> / <sub>4</sub> | 1 <sup>1</sup> / <sub>4</sub> |
| UC7544-RL      | 7        | 5S                   | H.O. | Plunger* | #14 - #10 Max    |      | 3 <sup>5</sup> / <sub>16</sub> | 8  | 14 | 1 <sup>1</sup> / <sub>2</sub> | 1 <sup>1</sup> / <sub>2</sub> | 1 <sup>1</sup> / <sub>4</sub> | 1 <sup>1</sup> / <sub>4</sub> | 1 <sup>1</sup> / <sub>4</sub> |
| UC7545-RL      | 8        | 6, 8, 9S & (ALT) 10S | H.O. | Plunger* | #14 - #10 Max    |      | 3 <sup>5</sup> / <sub>16</sub> | 8  | 14 | 1 <sup>1</sup> / <sub>2</sub> | 1 <sup>1</sup> / <sub>2</sub> | 1 <sup>1</sup> / <sub>4</sub> | 1 <sup>1</sup> / <sub>4</sub> | 1 <sup>1</sup> / <sub>4</sub> |
| UC7582-RL      | 13       | 6, 8, 9S & (ALT) 10S | C.P. | None     | #14 - #10 Max    |      | 3 <sup>5</sup> / <sub>16</sub> | 8  | 14 | 1 <sup>1</sup> / <sub>2</sub> | 1 <sup>1</sup> / <sub>2</sub> | 1 <sup>1</sup> / <sub>4</sub> | 1 <sup>1</sup> / <sub>4</sub> | 1 <sup>1</sup> / <sub>4</sub> |

**Notes**

- **Hubs:** For proper hub selection see the hub suffix chart on the accessory page.
- **Connectors:** Units are supplied with sleeve type connectors (#14-#2).
- \* **Bypass:** Plunger type bypass automatically closes when meter is removed.



Please consult serving utility for their requirements prior to ordering or installing, as specifications and approvals vary by utility, and may require local electrical inspector approval. All installations must be installed by a licensed electrician and must comply with all national and local codes, laws and regulations. Milbank reserves the right to make changes in specifications and features shown without notice or obligation.

# Current Transformer

20 Amp | 5, 6, 8, 13, & 15 Terminal | 600 VAC

**55**  
CURRENT  
TRANSFORMER



UC3438-XL



UC3426-XL

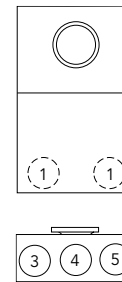
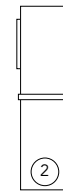
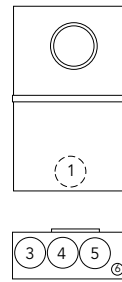

3425  
3426  
3428  
3423  
7636  
7461

3435  
3436  
3438  
3433  
3434

## 20 Amp | Ringless | With Provision for Test Switch | Two-Piece Front

| Catalog Number | Terminal | Meter Form           | Service | Hub  | Bypass | Connectors CU/AL |      | Dimensions |    |    | Knockouts |    |    |    |    |      |
|----------------|----------|----------------------|---------|------|--------|------------------|------|------------|----|----|-----------|----|----|----|----|------|
|                |          |                      |         |      |        | Line             | Load | D"         | W" | H" | 1         | 2  | 3  | 4  | 5  | 6    |
| UC3425-XL      | 5        | 3S                   | OH/UG   | C.P. | None   | #14 - #2         |      | 5½         | 12 | 20 | 1¼        | 1¼ | 1¼ | 1¼ | 1¼ | ¼, ½ |
| UC3426-XL      | 6        | 4S                   | OH/UG   | C.P. | None   | #14 - #2         |      | 5½         | 12 | 20 | 1¼        | 1¼ | 1¼ | 1¼ | 1¼ | ¼, ½ |
| UC3428-XL      | 8        | 5S                   | OH/UG   | C.P. | None   | #14 - #2         |      | 5½         | 12 | 20 | 1¼        | 1¼ | 1¼ | 1¼ | 1¼ | ¼, ½ |
| UC3423-XL      | 13       | 6, 8, 9S & (ALT) 10S | OH/UG   | C.P. | None   | #14 - #2         |      | 5½         | 12 | 20 | 1¼        | 1¼ | 1¼ | 1¼ | 1¼ | ¼, ½ |

## 20 Amp | Ring Type | Test Switch Factory Prewired | Two-Piece Front Approved for Tucson Electric Power

| Catalog Number    | Terminal | Service | Hub | Bypass      | Connectors CU/AL |      | Dimensions |    |    | Knockouts |    |    |    |    |    |      |
|-------------------|----------|---------|-----|-------------|------------------|------|------------|----|----|-----------|----|----|----|----|----|------|
|                   |          |         |     |             | Line             | Load | D"         | W" | H" | 1         | 2  | 3  | 4  | 5  | 6  |      |
| UC7636-YL-TGE-DES | 6        | OH      | 1¼  | Test Switch | #14 - #2         |      | 4½         | 12 | 20 | 1¼        | 1¼ | 1¼ | 1¼ | 1¼ | 1¼ | ¼, ½ |
| UC7461-YL-TGE-DES | 13       | OH      | 1¼  | Test Switch | #14 - #2         |      | 4½         | 12 | 20 | 1¼        | 1¼ | 1¼ | 1¼ | 1¼ | 1¼ | ¼, ½ |

## 20 Amp | Ring Type | With Provision for Test Switch | EUSERC Compliant | Two-Piece Front

| Catalog Number | Terminal | Service | Hub  | Bypass | Connectors CU/AL |      | Dimensions |    |    | Knockouts |   |   |   |   |   |   |
|----------------|----------|---------|------|--------|------------------|------|------------|----|----|-----------|---|---|---|---|---|---|
|                |          |         |      |        | Line             | Load | D"         | W" | H" | 1         | 2 | 3 | 4 | 5 | 6 |   |
| UC3435-XL      | 5        | OH/UG   | C.P. | None   | #14 - #2         |      | 5½         | 12 | 20 | 2         | 2 | 2 | 2 | 2 | 2 | - |
| UC3436-XL      | 6        | OH/UG   | C.P. | None   | #14 - #2         |      | 5½         | 12 | 20 | 2         | 2 | 2 | 2 | 2 | 2 | - |
| UC3438-XL      | 8        | OH/UG   | C.P. | None   | #14 - #2         |      | 5½         | 12 | 20 | 2         | 2 | 2 | 2 | 2 | 2 | - |
| UC3433-XL      | 13       | OH/UG   | C.P. | None   | #14 - #2         |      | 5½         | 12 | 20 | 2         | 2 | 2 | 2 | 2 | 2 | - |
| UC3434-XL      | 15       | OH/UG   | C.P. | None   | #14 - #2         |      | 5½         | 12 | 20 | 2         | 2 | 2 | 2 | 2 | 2 | - |

### Notes

- **Prewiring:** If factory prewiring is required consult factory before ordering. Please include meter socket catalog number, test switch number, meter form number, and a copy of your wiring diagram.
- **Test Switch Covers:** Units on this page can be used with clear lexan cover (except units **7636** and **7461**).
- **Connectors:** Units are supplied with sleeve type connectors (#14-#2).
- **Hubs:** For proper hub selection see the hub suffix chart in accessory section.

Please consult serving utility for their requirements prior to ordering or installing, as specifications and approvals vary by utility, and may require local electrical inspector approval. All installations must be installed by a licensed electrician and must comply with all national and local codes, laws and regulations. Milbank reserves the right to make changes in specifications and features shown without notice or obligation.



# Current Transformer Test Switches

4, 7, & 10 Pole

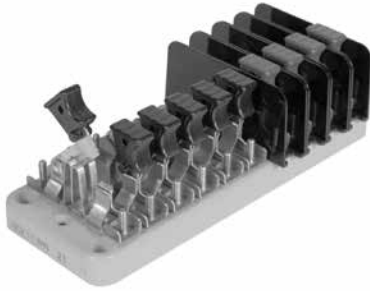

## SWITCH BLADES

Two dimples coined into one side of the switch blade ensure positive contact in corrosive, sooty environments – even after years of inactivity.

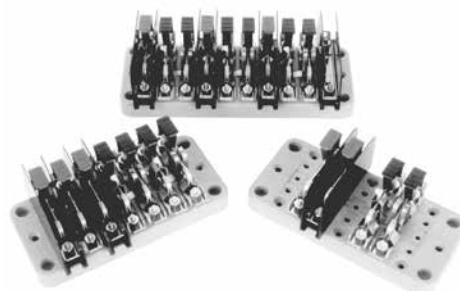

## TEST SWITCH BASE

The base is molded from a high strength, fiberglass reinforced, thermoset polyester. This material is track resistant, flame retardant and has low water absorption qualities. Bases are available in 7 pole and 10 pole sizes.



## POLARITY BARRIER

For maximum protection potential circuits are supplied with permanently mounted, rigid barriers made from high tensile strength, polycarbonate.

## TEST SWITCH COVERS

Standard test switch covers are made from break resistant, clear, thermal plastic which has excellent tracking and moisture resistant properties. If covers are required, add suffix "-WC" (with cover) to the catalog number or order separately catalog number **K3388**. Black flush mount covers are also available. Order catalog number **K3388-BLK-FL**. 10 pole base only.

## SWITCH JAWS

The switch blade jaw clips are constructed from spring grade copper alloy. The material and design ensure excellent contact which prevents overheating.

## CURRENT CARRYING PARTS

Highly conductive copper and copper alloy materials are used on all current carrying parts. This ensures conductivity and deters corrosion. Spring grades are used where appropriate. Plating is available if required. Contact general offices to special order.

## STANDARD COVER



**K3388**

Units must be  
5-1/8" deep  
for Cover

## FLUSH MOUNT COVER BLACK



**K3388-BLK-FL**

## Notes

- **Factory Installed:** For cover installed add the suffix **-WC** or **-WCFL** to the catalog number of desired test switch
- **Field Installed:** For field installed cover order kit number **K3388** or **K3388-BLK-FL**.

The MILBANK test switch is designed to meet the critical requirements of the electric utility industry. Not only do they meet EEI, ANSI C12.9, and UL standards but they combine several special features giving the MILBANK test switch increased safety, durability and reliability. One such feature is our unique switch blade contact points which cut through residue that builds up after years of service. Another distinction is our polarity barrier which is designed to be flexible as well as offer exceptional insulating qualities. Our test switches are constructed from the latest materials available using modern fabricating and assembly methods.



Please consult serving utility for their requirements prior to ordering or installing, as specifications and approvals vary by utility, and may require local electrical inspector approval. All installations must be installed by a licensed electrician and must comply with all national and local codes, laws and regulations. Milbank reserves the right to make changes in specifications and features shown without notice or obligation.



# Current Transformer Test Switches

4, 7, & 10 Pole | 600 VAC | Per Ansi C12.9 Standard

**57**  
CURRENT  
TRANSFORMER  
TEST SWITCHES

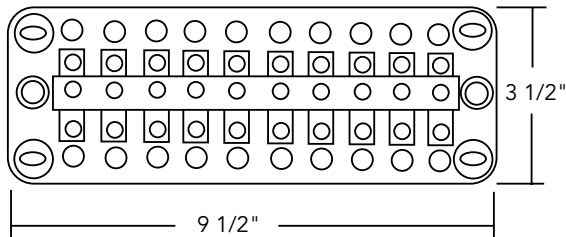
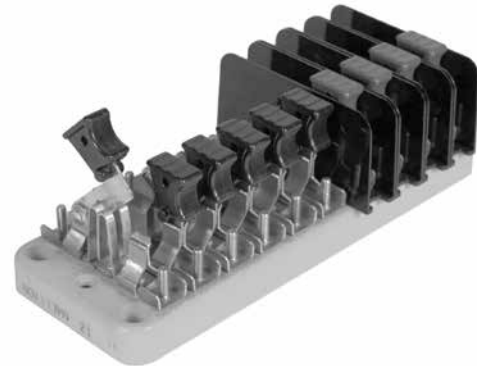
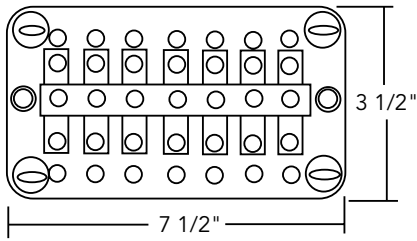

| Catalog Number | 4-POLE |    |    |   |    |    |   |
|----------------|--------|----|----|---|----|----|---|
| TS04-0101      | X      | P  | Pn | X | C+ | C  | X |
| TS04-0104      | X      | C+ | C  | X | P  | Pn | X |

| KEY |  |
|-----|--|
| P   | Potential Switch                                     |
| C+  | Line side current switch with short circuit assembly |
| C   | Load side current switch with test jack assembly     |
| N   | Neutral bar (no switch)                              |
| Pn  | Neutral potential switch                             |
| X   | Unused position on base                              |
|     | Line side current switch with short circuit assembly |

| Catalog Number | 7-POLE |   |    |    |   |    |   |
|----------------|--------|---|----|----|---|----|---|
| TS07-0105      | P      | P | Pn | C+ | C | C+ | C |

| Catalog Number | 7-POLE ON A 10-POLE BASE |   |    |   |    |    |    |    |   |    |
|----------------|--------------------------|---|----|---|----|----|----|----|---|----|
| TS07-0049      | P                        | X | P  | X | Pn | X  | C+ | C  | C | C+ |
| TS07-0106      | X                        | P | C+ | C | P  | C+ | C  | Pn | X | X  |

## CUSTOM POLE ARRANGEMENTS

The key may be used to diagram your own pole arrangement. Be sure to specify base size and whether all C+ line side, current switch/shunt circuit assemblies are to be bussed together. The catalog numbers shown above are connected in line-load pairs; therefore, if bussed is required, different catalog numbers will apply.

| Catalog Number | 10-POLE |    |    |    |    |    |    |    |    |    |
|----------------|---------|----|----|----|----|----|----|----|----|----|
| TS10-0109      | P       | P  | P  | Pn | C+ | C  | C+ | C  | C+ | C  |
| TS10-0110      | P       | C+ | C  | P  | C+ | C  | P  | C+ | C  | Pn |
| TS10-0111      | P       | P  | P  | Pn | C  | C+ | C  | C+ | C  | C+ |
| TS10-0112      | C+      | C  | C+ | C  | C+ | C  | P  | P  | P  | Pn |
| TS10-0016      | P       | P  | P  | PN | C  | C+ | C  | C+ | C  | C+ |

Please consult serving utility for their requirements prior to ordering or installing, as specifications and approvals vary by utility, and may require local electrical inspector approval. All installations must be installed by a licensed electrician and must comply with all national and local codes, laws and regulations. Milbank reserves the right to make changes in specifications and features shown without notice or obligation.



# Milbank Test Switch Worksheet



### TEST SWITCH BASE

The base is molded from a high strength, fiberglass reinforced, thermoset polyester. This material is track-resistant, flame-retardant and has low water absorption qualities. Bases are available in two standard sizes following NEMA mounting classifications.

Customer Name: \_\_\_\_\_

Email: \_\_\_\_\_

Phone: \_\_\_\_\_

| Handle Color Key |       |    |        |   |        |     |           |
|------------------|-------|----|--------|---|--------|-----|-----------|
| BK               | Black | P  | Purple | Y | Yellow | GN  | Green     |
| R                | Red   | BL | Blue   | W | White  | BKS | BK/Stripe |
| BR               | Brown | GR | Gray   | O | Orange | WS  | W/Stripe  |

### Pole Position Chart

| 1 | 2 | 3 | 4 | 5 | 6 | 7 | 8 | 9 | 10 |
|---|---|---|---|---|---|---|---|---|----|
|   |   |   |   |   |   |   |   |   |    |

### Special Features

| Features | 1 | 2 | 3 | 4 | 5 | 6 | 7 | 8 | 9 | 10 |
|----------|---|---|---|---|---|---|---|---|---|----|
|          |   |   |   |   |   |   |   |   |   |    |
|          |   |   |   |   |   |   |   |   |   |    |
|          |   |   |   |   |   |   |   |   |   |    |

Engineering Information: \_\_\_\_\_

\_\_\_\_\_

\_\_\_\_\_

| KEY                      |  |
|--------------------------|--|
| P                        | Potential Switch                                     |
| C+                       | Line side current switch with short circuit assembly |
| C                        | Load side current switch with test jack assembly     |
| N                        | Neutral bar (no switch)                              |
| Pn                       | Neutral potential switch                             |
| X                        | Unused position on base                              |
| <input type="checkbox"/> | Line side current switch with short circuit assembly |

**Custom Pole Arrangements:** The key may be used to diagram your own pole arrangement. Be sure to specify base size and whether all C+ line side, current switch/shunt circuit assemblies are to be bussed together. The catalog numbers shown above are connected in line-load pairs; therefore, if bussed is required, different catalog numbers will apply.

#### Number of Poles

- 4
- 7
- 10
- Other \_\_\_\_\_

#### Test Switch Cover\*

- Yes    \_\_\_ Clear    \_\_\_ Black
- No

#### Base Size

- 7-Pole
- 10-Pole

\* Test switch covers are only available for 10-pole bases.



Please consult serving utility for their requirements prior to ordering or installing, as specifications and approvals vary by utility, and may require local electrical inspector approval. All installations must be installed by a licensed electrician and must comply with all national and local codes, laws and regulations. Milbank reserves the right to make changes in specifications and features shown without notice or obligation.

# Current Transformer Cabinets

## Door Mount CT Rated Socket & Type 3R

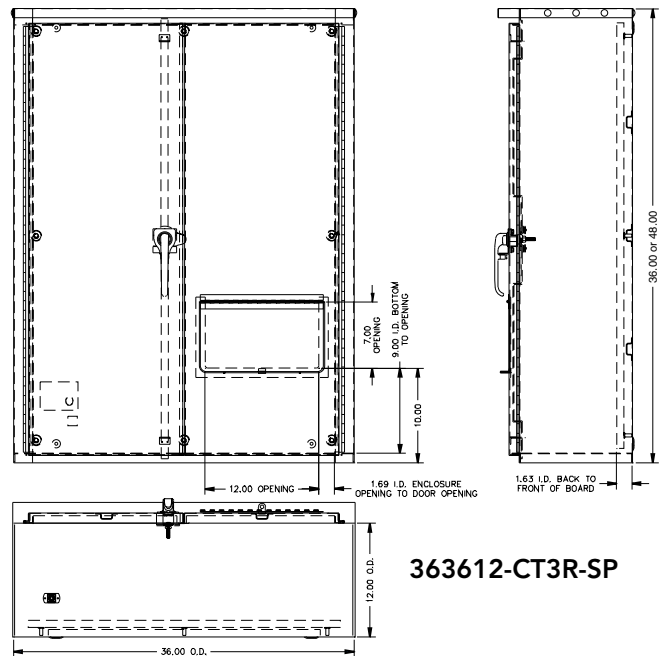
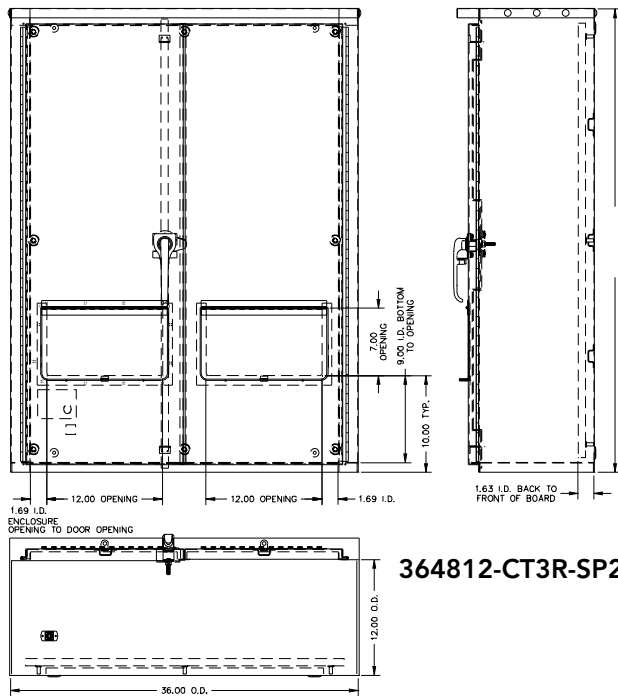

### Door Mount C.T. Rated Socket

| Catalog Number | Terminal | Bypass  | Amp  | Connectors | Dimensions |    |    |
|----------------|----------|---------|------|------------|------------|----|----|
|                |          |         |      |            | D"         | W" | H" |
| K4806-BP       | 13       | Plunger | 20 A | #14-4 Max  | 2½         | 7⅞ | 7½ |

### Note

BP: The -BP suffix indicates plunger bypass.

### Current Transformer Rated Cabinets – Type 3R

| Catalog Number  | Gauge of Steel | Dimensions |    |    | Panel Size |                     | Panel & Backboard Catalog Numbers |                   |
|-----------------|----------------|------------|----|----|------------|---------------------|-----------------------------------|-------------------|
|                 |                | D"         | W" | H" | W" x H"    | Painted Steel Panel | Wood Backboard                    |                   |
| 243210-LC3R-SP  | 14             | 10         | 24 | 32 | 21         | 29                  | A-24P32                           | A-24P32W          |
| 323610-LC3R-SP  | 14             | 10         | 32 | 36 | 29         | 33                  | A-32P36                           | A-32P36W          |
| 363016-CT3R     | 14             | 16         | 36 | 30 | 33         | 27                  | A-36P30                           | A-36P30W          |
| 363612-CT3R-SP  | 14             | 12         | 36 | 36 | 33         | 33                  | A-36P36                           | A-36P36W Included |
| 364812-CT3R-SP2 | 14             | 12         | 36 | 48 | 33         | 45                  | A-48P36                           | A-48P36W Included |

Please consult serving utility for their requirements prior to ordering or installing, as specifications and approvals vary by utility, and may require local electrical inspector approval. All installations must be installed by a licensed electrician and must comply with all national and local codes, laws and regulations. Milbank reserves the right to make changes in specifications and features shown without notice or obligation.



# Current Transformer Cabinets

## Mounting Racks

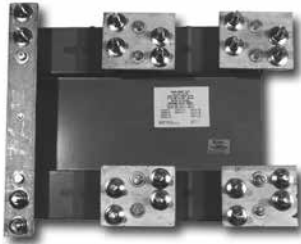

**K4797**



**K4722**

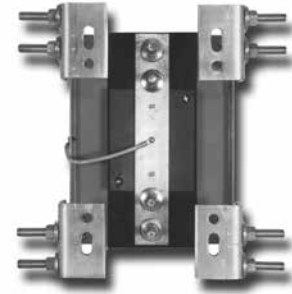

**K4793/K4795**

### Current Transformer Enclosure Mounting Racks

| Catalog Number | Code | AIC Rating | Amp     | Volts | Type of Service | Termination Type   |
|----------------|------|------------|---------|-------|-----------------|--|
| K4797          | A4   | 50K        | 400     | 600   | 1Ø3W            | 1/2 x 13 Studs on 1-3/4" Centers   |
| K4797          | A    | 50K        | 800     | 600   | 1Ø3W            | 1/2 x 13 Studs on 1-3/4" Centers   |
| K4798          | B4   | 50K        | 400     | 600   | 3Ø4W            | 1/2 x 13 Studs on 1-3/4" Centers   |
| K4798          | B    | 50K        | 800     | 600   | 3Ø4W            | 1/2 x 13 Studs on 1-3/4" Centers   |
| K4793          | C    | 10K        | 201-400 | 600   | 1Ø3W            | 1/2 x 13 Studs on 1-3/4" Centers   |
| K4795          | D    | 10K        | 401-800 | 600   | 1Ø3W            | 1/2 x 13 Studs on 1-3/4" Centers   |
| K4794          | E    | 10K        | 201-400 | 600   | 3Ø4W            | 1/2 x 13 Studs on 1-3/4" Centers   |
| K4796          | F    | 10K        | 401-800 | 600   | 3Ø4W            | 1/2 x 13 Studs on 1-3/4" Centers   |
| K4729          | G    | 50K        | 800     | 600   | 1Ø3W            | (3) #4 - 600 or (6) #1 - 250   |
| K4722          | H    | 50K        | 800     | 600   | 3Ø4W            | (3) #4 - 600 or (6) #1 - 250   |
| K4903          | J    | 50K        | 400     | 600   | 1Ø3W            | (1) #4 - 600 or (2) #1 - 250   |
| K4904          | K    | 50K        | 400     | 600   | 3Ø4W            | (1) #4 - 600 or (2) #1 - 250   |
| K5747          | L    | 50K        | 800     | 600   | 3Ø4W            | Line: 1/2 x 13 Studs on 1-3/4" Centers<br>Load: (3) #4 - 600 or (6) #1 - 250 |
| K5752          | M    | 50K        | 800     | 600   | 1Ø3W            | Line: 1/2 x 13 Studs on 1-3/4" Centers<br>Load: (3) #4 - 600 or (6) #1 - 250 |

### Note

- Match red code letter with the applicable CT Cabinet on pages 61 & 62.
- 1/2" Lug Kit: order **K4200** (single, #4-600) or **K4223** (double, #6-350). Each Kit contains four connectors.



Please consult serving utility for their requirements prior to ordering or installing, as specifications and approvals vary by utility, and may require local electrical inspector approval. All installations must be installed by a licensed electrician and must comply with all national and local codes, laws and regulations. Milbank reserves the right to make changes in specifications and features shown without notice or obligation.

# Current Transformer Cabinets

## Screw Cover & Hinge Cover



CT363611-SC



CT203611-HC

### Screw Cover

| Catalog Number | C.T. Racks                           | Dimensions |    |    | Front Cover |
|----------------|--------------------------------------|------------|----|----|-------------|
|                |                                      | D"         | W" | H" |             |
| CT24329-SC     | A4, C, D, G, J, M                    | 9          | 24 | 32 | 1 Piece     |
| CT242411-SC    | G                                    | 11         | 24 | 24 | 1 Piece     |
| CT243011-SC    | A4, C, D, G, J, M                    | 11         | 24 | 30 | 1 Piece     |
| CT243611-SC    | A4, C, D, G, J, M                    | 11         | 24 | 36 | 1 Piece     |
| CT244811-SC    | A, C, D, G, J                        | 11         | 24 | 48 | 1 Piece     |
| CT303011-SC    | A4, B4, C, D, E, F, G, H, J, K, L, M | 11         | 30 | 30 | 1 Piece     |
| CT303611-SC    | A4, B4, C, D, E, F, G, H, J, K, L, M | 11         | 30 | 36 | 1 Piece     |
| CT363611-SC    | A4, B4, C, D, E, F, G, H, J, K, L, M | 11         | 36 | 36 | 1 Piece     |
| CT364211-SC    | A, B, C, D, E, F, G, H, J, K, L, M   | 11         | 36 | 42 | 2 Pieces    |
| CT364811-SC    | A, B, C, D, E, F, G, H, J, K, L, M   | 11         | 36 | 48 | 2 Pieces    |
| CT424211-SC    | A, B, C, D, E, F, G, H, J, K, L, M   | 11         | 42 | 42 | 2 Pieces    |
| CT484811-SC    | A, B, C, D, G, J, M                  | 11         | 48 | 48 | 2 Pieces    |
| CT303614-SC    | A4, B4, C, D, E, F, G, H, J, K, L, M | 14         | 30 | 36 | 2 Pieces    |
| CT364814-SC    | A, B, C, D, E, F, G, H, J, K, L, M   | 14         | 36 | 48 | 2 Pieces    |
| CT484814-SC    | A, B, C, D, E, F, G, H, J, K, L, M   | 14         | 48 | 48 | 2 Pieces    |

### Hinge Cover

| Catalog Number | C.T. Racks                             | Dimensions |    |    | Front Cover |
|----------------|--|------------|----|----|-------------|
|                |  | D"         | W" | H" |             |
| CT203611-HC    | A4, C, D, J                            | 11         | 20 | 36 | 1 Piece     |
| CT243011-HC    | A4, C, D, G, J, M                      | 11         | 24 | 30 | 1 Piece     |
| CT243611-HC    | A4, C, D, G, J, M                      | 11         | 24 | 36 | 1 Piece     |
| CT244811-HC    | A, C, D, G, J, M                       | 11         | 24 | 48 | 1 Piece     |
| CT303611-HC    | A4, B4, C, D, E, F, G, H, J, K, L, M   | 11         | 30 | 36 | 1 Piece     |
| CT304811-HC    | A, B, B4, C, D, E, F, G, H, J, K, L, M | 11         | 30 | 48 | 1 Piece     |
| CT363611-HC    | A4, B4, C, D, E, F, G, H, J, K, L, M   | 11         | 36 | 36 | 1 Piece     |
| CT364811-HC    | A, B, B4, C, D, E, F, G, H, J, K, L, M | 11         | 36 | 48 | 1 Piece     |
| CT484811-HC    | A, B, C, D, J, M                       | 11         | 48 | 48 | 2 Pieces    |
| CT484814-HC    | A, B, B4, C, D, E, F, G, H, J, K, L, M | 14         | 48 | 48 | 2 Pieces    |

### Note

- **Enclosure:** These units are rated Type 3R, powder coated, and constructed of galvanized steel.
- **Mounting Rack:** Select CT mounting rack by matching the appropriate letter in **CT rack column** on page 61 with applicable letter in **Code column** on page 60.
- **Mounting:** 1/4-20 welded studs.

Please consult serving utility for their requirements prior to ordering or installing, as specifications and approvals vary by utility, and may require local electrical inspector approval. All installations must be installed by a licensed electrician and must comply with all national and local codes, laws and regulations. Milbank reserves the right to make changes in specifications and features shown without notice or obligation.





U3565-O

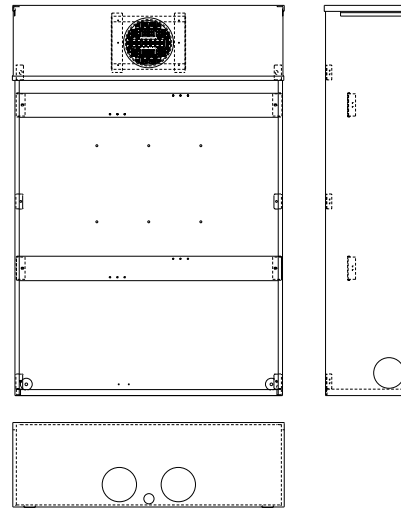

## Metered Transformer Cabinets | Ring Type

| Catalog Number | Terminal | Service | Meter Form           | Hub  | Dimensions |    |    | CT Racks                           |
|----------------|----------|---------|----------------------|------|------------|----|----|------------------------------------|
|                |          |         |                      |      | D"         | W" | H" |                                    |
| U3319-R        | 5        | OH      | 3S                   | H.O. | 11         | 24 | 42 | A, C, D, G, J, M                   |
| U3320-R        | 6        | OH      | 4S                   | H.O. | 11         | 24 | 42 | A, C, D, G, J, M                   |
| U3321-R        | 8        | OH      | 5S                   | H.O. | 11         | 24 | 42 | A, C, D, G, J, M                   |
| U3322-R        | 13       | OH      | 6, 8, 9S & (ALT) 10S | H.O. | 11         | 36 | 42 | A, B, C, D, E, F, G, H, J, K, L, M |
| U3323-R        | 8        | OH      | 5S                   | H.O. | 11         | 36 | 42 | A, B, C, D, E, F, G, H, J, K, L, M |
| U3555-R        | 15       | OH      | 39S, 76S             | H.O. | 11         | 36 | 42 | A, B, C, D, E, F, G, H, J, K, L, M |
| U3339-O        | 5        | UG      | 3S                   | none | 11         | 24 | 52 | A, C, D, G, J, M                   |
| U3340-O        | 6        | UG      | 4S                   | none | 11         | 24 | 52 | A, C, D, G, J, M                   |
| U3341-O        | 8        | UG      | 5S                   | none | 11         | 24 | 52 | A, C, D, G, J, M                   |
| U3342-O        | 13       | UG      | 6, 8, 9S & (ALT) 10S | none | 11         | 36 | 52 | A, B, C, D, E, F, G, H, J, K, L, M |
| U3343-O        | 8        | UG      | 5S                   | none | 11         | 36 | 52 | A, B, C, D, E, F, G, H, J, K, L, M |
| U3565-O        | 15       | UG      | 39S, 76S             | none | 11         | 36 | 52 | A, B, C, D, E, F, G, H, J, K, L, M |

### Note

- **Meter Socket:** 20 amp current transformer meter socket built in.
- **Enclosure:** NEMA Type 3R with screw cover.
- **Current Transformer Mounting:** 1/4-20 welded studs.
- **Hubs:** For proper hub selection, see hub suffix chart in the accessory section.
- **Sealing Rings:** Supplied with **MR-4** screw type sealing ring.
- **Mounting Racks:** For mounting rack information refer to previous page. Select CT mounting rack by matching the appropriate letter in **CT rack column** on page 62 with applicable letter in **Code column** on page 60.



Please consult serving utility for their requirements prior to ordering or installing, as specifications and approvals vary by utility, and may require local electrical inspector approval. All installations must be installed by a licensed electrician and must comply with all national and local codes, laws and regulations. Milbank reserves the right to make changes in specifications and features shown without notice or obligation.

# Service Pedestals

125 Amp | Mobile Home Metered | 120/240 VAC

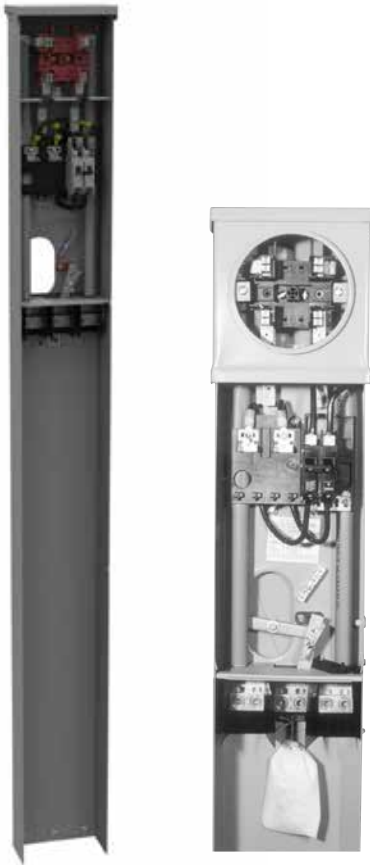

**MPRV-100-MB-78**

## Standard Configurations

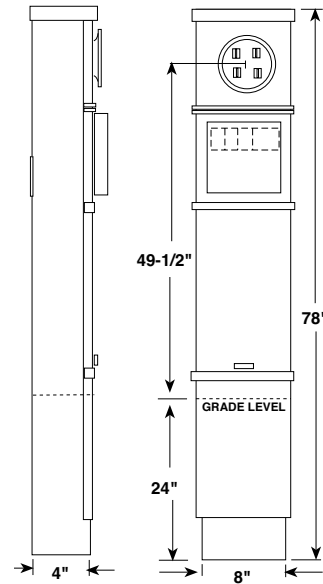
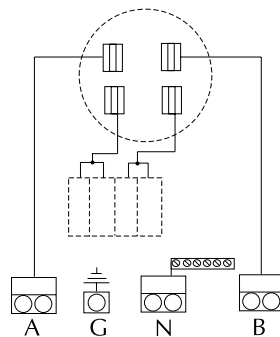
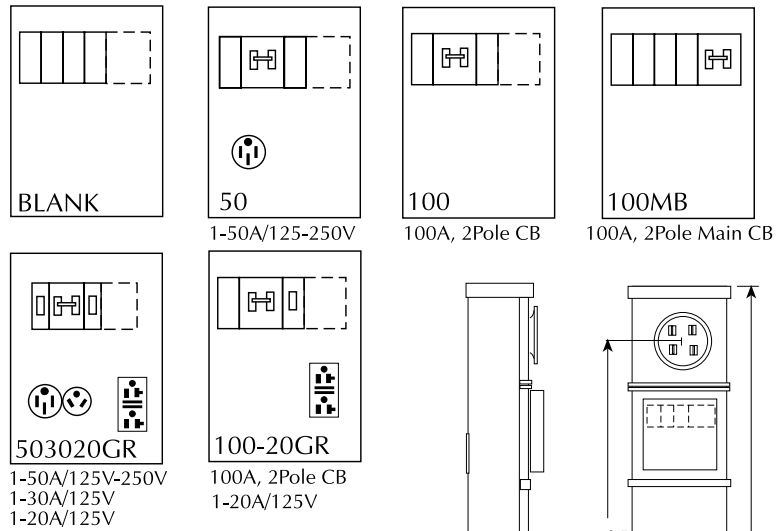

**Single**

## Specifications

- UL listed 100 amp continuous duty meter socket.
- 120/240 volt single phase service.
- Twin line termination lugs #6-350 kcmil CU/AL per phase for looping.
- Space for four (4) single, or one double (240V C/B center- positions only) and two (2) single pole universal style, plug-in circuit breakers.
- Ringless version equipped with horn bypass as standard.
- For fifth terminal field installed order kit **105J** in the 3 o'clock or 9 o'clock position.
- Direct rear feed kit **PF-KR** included.
- For optional stabilizer foot, order **K5763**.
- Specify **MPRV-100-78** for 100 amp service pedestal with direct feed kit and 100 amp CB wired in parallel. Space for two additional single pole CBs provided. Series wiring available; specify **MPRV-100-MB-78**.
- **MR-2** sealing ring standard with ring type cover.
- No knockouts.

| Catalog Number            | Description               |
|---------------------------|---------------------------|
| <b>MPRV-BLANK-78</b>      | Ring type, parallel wired |
| <b>MPRV-BLANK-78-R-5T</b> | Ringless, horn bypass     |
| <b>MPRV-100-78</b>        | Ring type, parallel wired |
| <b>MPRV-100-MB-78</b>     | Ring type, series wired   |
| <b>MPRV-100-20GR-78</b>   | Ring type, parallel wired |
| <b>MPRV-50-78</b>         | Ring type                 |
| <b>MPRV-503020GR-78</b>   | Ring type                 |

Please consult serving utility for their requirements prior to ordering or installing, as specifications and approvals vary by utility, and may require local electrical inspector approval. All installations must be installed by a licensed electrician and must comply with all national and local codes, laws and regulations. Milbank reserves the right to make changes in specifications and features shown without notice or obligation.



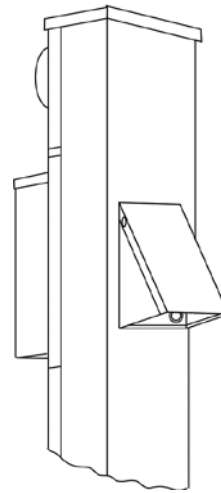
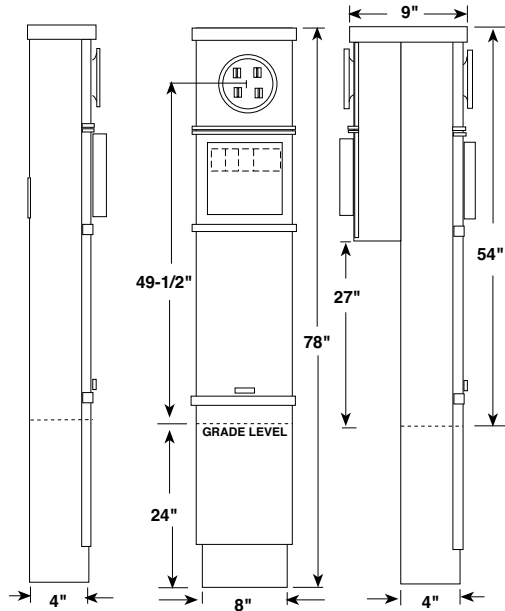

**MPAP-200-78**

### Standard Configurations

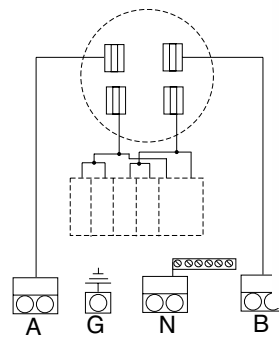
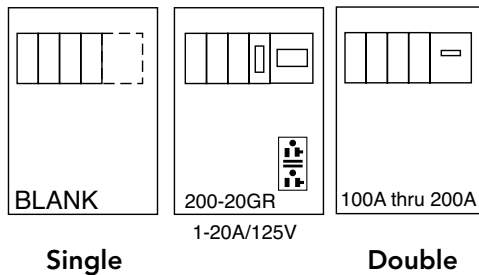

| Catalog Number   | Description                           |
|------------------|---------------------------------------|
| MPAP-BLANK-78    | Ring type, parallel wired             |
| MPAP-BLANK-78R   | Ringless, horn bypass, parallel wired |
| MPAP-100-78      | Ring type, parallel wired             |
| MPAP-100-MB-78   | Ring type, series wired               |
| MPAP-200-78      | Ring type, parallel wired             |
| MPAP-200-MB-78   | Ring type, series wired               |
| MPAP-200-20GR-78 | Ring type, parallel wired             |
| MPAPD-BLANK-78   | Ring type, parallel wired             |
| MPAPD-BLANK-78R  | Ringless, horn bypass, parallel wired |

### Specifications

- 120/240 volt single phase service.
- Twin line termination lugs #6-350 CU/AL per phase for looping.
- **UQFP** breaker provisions factory wired in parallel with branch breaker bus. Series wiring available. Specify **MB** after breaker rating, ex. **MPAP-200-MB**.
- Furnished with space for four single or one double (240V C/B center-positions only) and two single pole universal style, plug-in circuit breakers in addition to main.
- Ringless version equipped with horn bypass as standard.
- For fifth terminal field installed order kit **105J** in the 3 o'clock or 9 o'clock position.
- Direct rear feed kit **PF-KR** included.
- **MR-2** sealing ring standard with ring type cover.
- Series conversion kit order K4714

### Notes

- Order K4714 for series wire kit.
- Order K5194 for parallel to series field conversion kit.
- Order K5193 for series to parallel field conversion kit.



Please consult serving utility for their requirements prior to ordering or installing, as specifications and approvals vary by utility, and may require local electrical inspector approval. All installations must be installed by a licensed electrician and must comply with all national and local codes, laws and regulations. Milbank reserves the right to make changes in specifications and features shown without notice or obligation.



# Power Pedestals with Load Center

100 & 200 Amp Series MPRV & MPAP | Ring Type

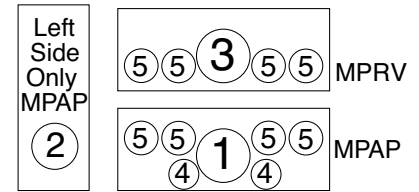
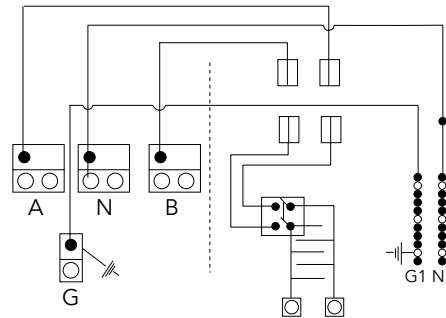
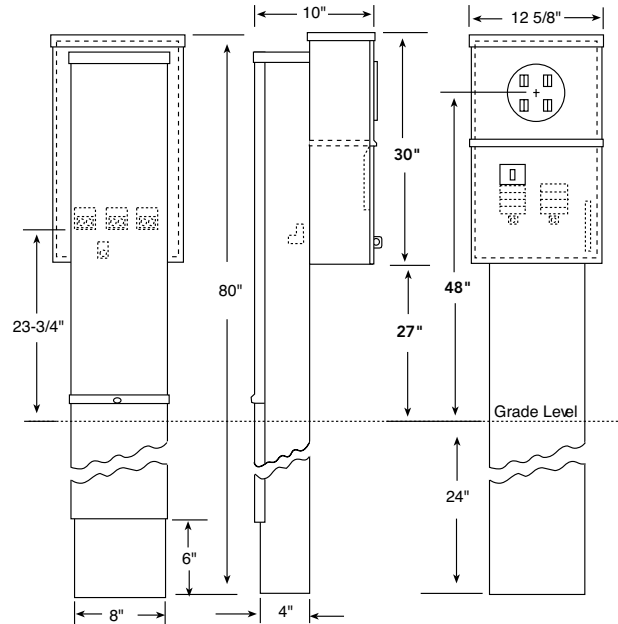

MPAP-200-MBLC-80

## 100 & 200 Amp | Load Center Power Outlets

| Catalog Number   | Description   | Knockouts |   |   |    |      |
|------------------|---|-----------|---|---|----|------|
|                  |   | 1         | 2 | 3 | 4  | 5    |
| MPRV-100-MBLC-80 | 100 Amp Metered Pedestal with (8) Circuit Load Center | 2½        | 2 | - | 1¼ | ½, ¾ |
| MPAP-200-MBLC-80 | 200 Amp Metered Pedestal with (8) Circuit Load Center | 2½        | 2 | - | 1¼ | ½, ¾ |

## Specifications

- UL listed 100/200 amp continuous duty meter socket.
- Approved for 120/240 volt single phase service.
- Twin line termination lugs #6-350 CU/AL per phase for looping. Rear termination.
- Space for (8) single, or (4) double and two single pole universal style plug-in circuit breakers.
- Series main breaker factory installed.
- Direct feed lugs standard.

Please consult serving utility for their requirements prior to ordering or installing, as specifications and approvals vary by utility, and may require local electrical inspector approval. All installations must be installed by a licensed electrician and must comply with all national and local codes, laws and regulations. Milbank reserves the right to make changes in specifications and features shown without notice or obligation.



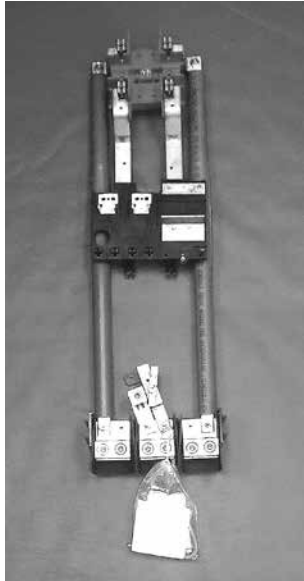

**Catalog Number Z020-148-00-00-0**  
MPAP 200A interior rebuild kit

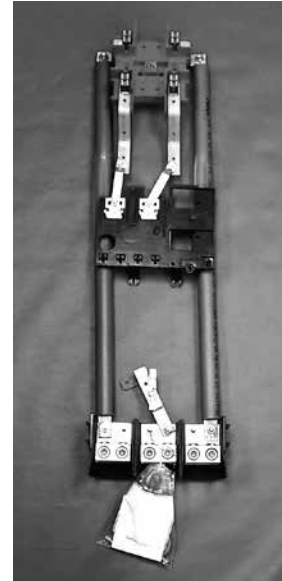

**Catalog Number 020-147-00-00-0**  
MPRV 100A interior rebuild kit

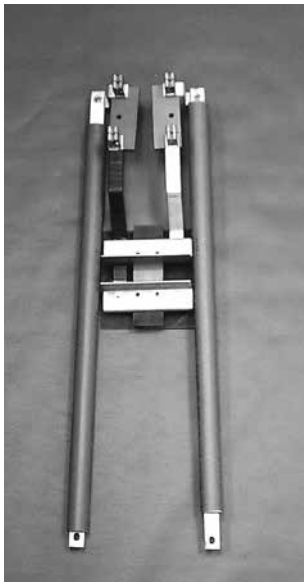

**Catalog Number RBK-1**  
Unicorn MPP (pre-1969)  
interior rebuild kit

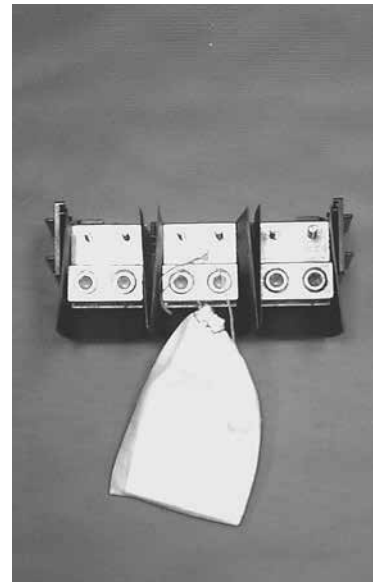

**Catalog Number Z1050596**  
MPAP, MPRV & Unicorn MPP  
lug landing assembly with grounding kit

**Above items sold as complete assemblies only.  
Individual components not available.**



Please consult serving utility for their requirements prior to ordering or installing, as specifications and approvals vary by utility, and may require local electrical inspector approval. All installations must be installed by a licensed electrician and must comply with all national and local codes, laws and regulations. Milbank reserves the right to make changes in specifications and features shown without notice or obligation.

# Replacement Parts

Mobile Home Rebuild Kits

**67**  
REPLACEMENT  
PARTS



**Catalog Number PF-BL**  
MPAP/MPRV blank deadfront  
with hinged cover

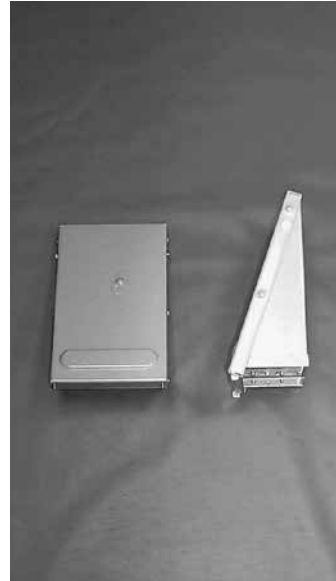

**Catalog Number PF-KR**  
MPAP/MPRV rear connector kit

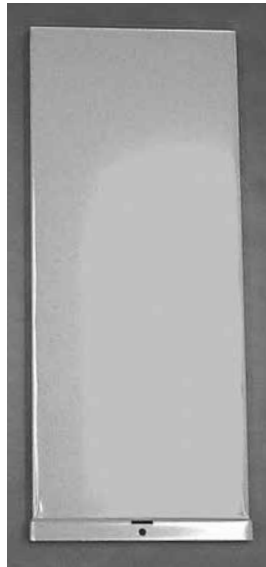

**Lug Cover for MPAP/MPRV**  
Order Catalog Number **403456-SC**  
(8-1/2" W X 20-1/2" H) for 72" pedestals  
and Catalog Number **403457-SC** (8-1/2" W X 26-1/2" H)  
for 78" pedestals.

Please consult serving utility for their requirements prior to ordering or installing, as specifications and approvals vary by utility, and may require local electrical inspector approval. All installations must be installed by a licensed electrician and must comply with all national and local codes, laws and regulations. Milbank reserves the right to make changes in specifications and features shown without notice or obligation.



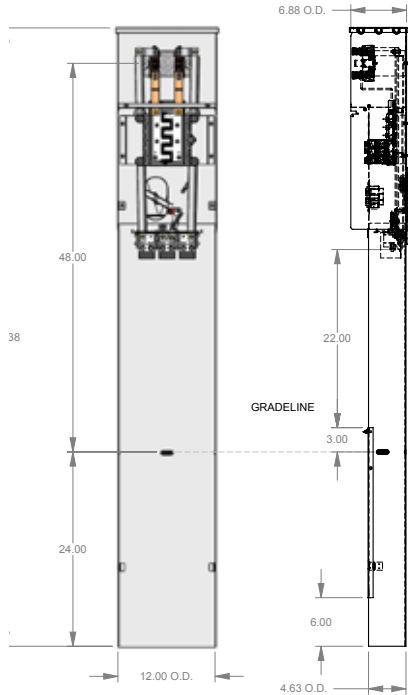

## Features and Benefits

- Circuit breaker interior has provisions for twelve full one-inch poles (including main).
- Rating: 100 Amp, 120/240 VAC.
- Interiors will accept plug-in breakers. (GE, Cutler-Hammer, Siemens, SQD)
- Suitable for use as service equipment and mobile home service equipment.
- Rear Feed Kit included in Pedestal
- Twin 350 MCM line terminals (installed) provide optional loop-feed installation.
- 14 gauge corrosion resistant steel construction.
- Type 3R Raintight enclosure.
- Padlock provision.
- Total unit height is 76". Burial depth is 24". Installed height from ground is 48" to meter center.
- Standard color: gray powder coat finish.
- EUSERC compliant drawing number 307
- Pad Mount version available

| Catalog Number | Configuration   |
|----------------|---|
| U6276-O-10GR   | (1) 20 amp 5-20R Duplex                                   |
| U6276-O-54     | (1) 50 amp 14-50R Duplex                                  |
| U6276-O-41     | (1) 20 amp 5-20R Duplex (1) 30 amp TT-30R                 |
| U6276-O-55     | (1) 20 amp 5-20R Duplex (1) 50 amp 14-50GR                |
| U6276-O-75     | (1) 50 amp 14-50R (1) 30 amp TT30 (1) 20amp 5-20GR Duplex |
| U6276-O-100    | (1) 100 amp breaker installed                             |
| U6276-O-100MB  | (1) 100 Main Breaker series wired                         |

## Notes

- Contact Factory for additional options
- Extension Kit and Stabilizer Foot Available
- Replacement Parts available (covers, dead-fronts, receptacles, breakers).



Please consult serving utility for their requirements prior to ordering or installing, as specifications and approvals vary by utility, and may require local electrical inspector approval. All installations must be installed by a licensed electrician and must comply with all national and local codes, laws and regulations. Milbank reserves the right to make changes in specifications and features shown without notice or obligation.

# Service Pedestals

200 Amp | U5240 & U5241 Series | Ring Type

**69**  
SERVICE  
PEDESTALS



U5240-O-200S

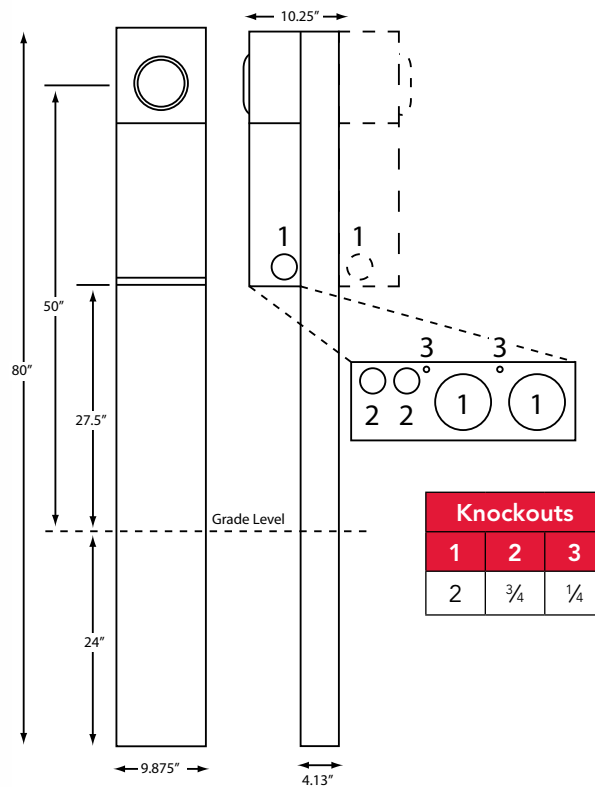

## Specifications

- Twin line termination lugs #6-350 CU/AL per phase for looping.
- 200 amp maximum, 120/240 volt, single phase, three wire meter socket.
- Ring type meter socket with stainless steel screw-type sealing ring.
- Short circuit withstand rating 22K AIC.
- Type 3R construction for durable outdoor use, one piece post – lockable and sealable.
- ANSI 61 gray polyester powder coat finish.
- Wire terminations accept copper or aluminum conductors.
- Line & neutral: (2) #6-350 kcmil per phase
- Line ground: (4) #14-1/0
- Load: See Circuit Breaker
- Load neutral: (1) #6-350 kcmil.
- Load ground: (2) #14-1/0, (4) #14/6
- Milbank plug-in main circuit breaker. Available in 100, 125, 150 & 200 amp. Type **UQFPH-M**.
- Four-circuit plated copper interior accepts (2) 2-pole or (4) 1-pole standard plug-in type circuit breakers up to a total of 125 amp maximum. Acceptable manufacturers: Cutler-Hammer, GE or Siemens
- Factory or field-installable receptacle bridge and receptacle/circuit breaker kits available. See accessories.

Please consult serving utility for their requirements prior to ordering or installing, as specifications and approvals vary by utility, and may require local electrical inspector approval. All installations must be installed by a licensed electrician and must comply with all national and local codes, laws and regulations. Milbank reserves the right to make changes in specifications and features shown without notice or obligation.



### 200 Amp | 4 Terminal | Service Pedestals | Ring Type

| Catalog Number | Powerheads | Mounting      | Main Breaker                     | Main CB | Circuits | Dimensions |    |    |
|----------------|------------|---------------|----------------------------------|---------|----------|------------|----|----|
|                |            |               |                                  |         |          | D"         | W" | H" |
| U5240-O-100S   | Single     | Direct Burial | UQFPH-M-100                      | 100     | 4        | 10¼        | 10 | 80 |
| U5240-O-200S   | Single     | Direct Burial | UQFPH-M-200                      | 200     | 4        | 10¼        | 10 | 80 |
| U5240-O        | Single     | Direct Burial | Provision for UQFPH-M series     | —       | 4        | 10¼        | 10 | 80 |
| U5242-O-200S   | Single     | Pad Mount     | UQFPH-M-200                      | 200     | 4        | 10¼        | 10 | 56 |
| U5242-O        | Single     | Pad Mount     | Provision for UQFPH-M series     | —       | 4        | 10¼        | 10 | 56 |
| U5241-O-100S   | Double     | Direct Burial | (2) UQFPH-M-100                  | 100     | 4        | 16         | 10 | 80 |
| U5241-O-200S   | Double     | Direct Burial | (2) UQFPH-M-200                  | 200     | 4        | 16         | 10 | 80 |
| U5241-O        | Double     | Direct Burial | Provision for (2) UQFPH-M series | —       | 4        | 16         | 10 | 80 |
| U5243-O        | Double     | Pad Mount     | Provision for (2) UQFPH-M series | —       | 4        | 16         | 10 | 56 |

### Accessories

| Catalog Number | Description   |
|----------------|---|
| K5415          | Stabilizer foot with hardware                             |
| K5035          | Pad mount kit with hardware for U5242 & U5243             |
| K5T            | 5th terminal for 208y/120V 3-wire service                 |
| K5193          | Bus kit to convert series-wired main breaker to parallel  |
| K5194          | Wire kit to convert parallel-wired main breaker to series |
| K3450          | Telephone/CATV mounting bracket (mounts left or right)    |
| K5039          | Penta bolt utility cover                                  |

### Notes

- Up to two receptacle/circuit breaker kits can be field-installed in each powerhead. Order mounting bridge and receptacle kits separately from above. For three receptacles or factory-installed kits, contact factory.
- **K5415** Stabilizer Foot sold separately. Recommended for double pedestals.
- Pad mount pedestals require **K5035** pad mount kit. Order separately.
- Receptacles and circuit breakers can be found in the accessories section.

# Service Pedestals

200 Amp | Ringless

**71**  
SERVICE  
PEDESTAL



U5136-O-200S

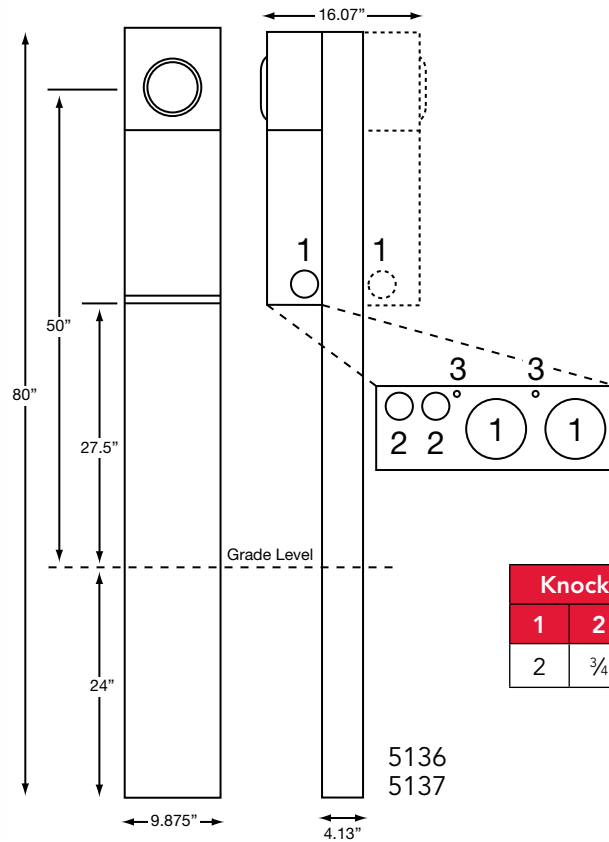

| Knockouts |     |     |
|-----------|-----|-----|
| 1         | 2   | 3   |
| 2         | 3/4 | 1/4 |

## Specifications

- UL listed
- 200 amp maximum, 120/240 V, 1Ø3W
- Ringless type meter socket with stainless steel latch
- Short circuit withstand rating 22 KAIC
- Type 3R construction for durable outdoor use
- ANSI 61 gray polyester powder coat finish
- Wire terminations accept copper or aluminum conductors
- Line & Neutral: (2) #6-350 kcmil per phase, Line Ground: (4) #14-1/0
- Load (CB): 2/0 to 300 kcmil per pole
- Load neutral: (1) #6-350 kcmil
- Load ground: (2) #14-1/0, (4) #14/6
- Commercial grade, plug-in main circuit breaker. Available in 100, 125, 150 & 200 AMP. Type UQFP-H-M.
- 4 circuit plated copper interior accepts (2) 2-pole or (4) 1-pole standard plug-in type circuit breakers. Branch circuit rated to 125 amp max. Acceptable manufacturers: Milbank, Cutler-Hammer, GE or Siemens
- Twin line termination lugs #6-350 CU/AL per phase for looping.

Please consult serving utility for their requirements prior to ordering or installing, as specifications and approvals vary by utility, and may require local electrical inspector approval. All installations must be installed by a licensed electrician and must comply with all national and local codes, laws and regulations. Milbank reserves the right to make changes in specifications and features shown without notice or obligation.



### 100–200 Amp | Meter Main with Load Center Pedestals | Ringless

| Catalog Number | Powerheads | Mounting      | Amp | Main Breaker                     | Interior  | Dimensions |    |    | Knockouts |     |   |
|----------------|------------|---------------|-----|----------------------------------|-----------|------------|----|----|-----------|-----|---|
|                |            |               |     |                                  |           | D"         | W" | H" | 1         | 2   | 3 |
| U5136-O-100S   | Single     | Direct Burial | 100 | UQFPH-M-100                      | 4 circuit | 10¼        | 10 | 80 | 2         | ½,¾ | ¼ |
| U5136-O-200S   | Single     | Direct Burial | 200 | UQFPH-M-200                      | 4 circuit | 10¼        | 10 | 80 | 2         | ½,¾ | ¼ |
| U5136-O        | Single     | Direct Burial | —   | Provision for UQFPH-M series     | 4 circuit | 10¼        | 10 | 80 | 2         | ½,¾ | ¼ |
| U5137-O-100S   | Double     | Direct Burial | 100 | (2) UQFPH-M-100                  | 4 circuit | 16⅙        | 10 | 80 | 2         | ½,¾ | ¼ |
| U5137-O-200S   | Double     | Direct Burial | 200 | (2) UQFPH-M-200                  | 4 circuit | 16⅙        | 10 | 80 | 2         | ½,¾ | ¼ |
| U5137-O        | Double     | Direct Burial | —   | Provision for (2) UQFPH-M series | 4 circuit | 16⅙        | 10 | 80 | 2         | ½,¾ | ¼ |
| U5138-O-200S   | Single     | Pad Mount     | 200 | UQFPH-M-200                      | 4 circuit | 10¼        | 10 | 56 | 2         | ½,¾ | ¼ |
| U5138-O        | Single     | Pad Mount     | —   | Provision for UQFPH-M series     | 4 circuit | 10¼        | 10 | 56 | 2         | ½,¾ | ¼ |
| U5139-O        | Double     | Pad Mount     | —   | Provision for UQFPH-M series     | 4 circuit | 16⅙        | 10 | 56 | 2         | ½,¾ | ¼ |

### Accessories

| Catalog Number | Description   |
|----------------|---|
| K5415          | Stabilizer foot with hardware                             |
| K5035          | Pad mount kit with hardware for <b>U5138</b>              |
| K5T            | 5th terminal for 208y/120V 3-wire service                 |
| K5193          | Bus kit to convert series-wired main breaker to parallel  |
| K5194          | Wire kit to convert parallel-wired main breaker to series |
| K3450          | Telephone/CATV mounting bracket (mounts left or right)    |
| K5039          | Penta bolt utility cover                                  |

### Notes

- **Parallel to Series Conversion:** For field converting from parallel wired to series wired order **K5194**.
- **Fifth Terminal:** For field installed fifth terminal, order **K5T**.
- **Stabilizer Foot:** For field installed stabilizer foot, order **K5415**.
- **Penta Bolt Locking:** For field installed pedestal fronts penta bolt locking, order **K5039**.
- **Pad Mount Units:** Pad mount pedestals require **K5035** pad mount kit. Order separately.
- Receptacles and circuit breakers can be found in the accessories section.



Please consult serving utility for their requirements prior to ordering or installing, as specifications and approvals vary by utility, and may require local electrical inspector approval. All installations must be installed by a licensed electrician and must comply with all national and local codes, laws and regulations. Milbank reserves the right to make changes in specifications and features shown without notice or obligation.



# Service Pedestals

U5706 Series | Ringless

**73**  
SERVICE  
PEDESTALS



U5706-O-200S

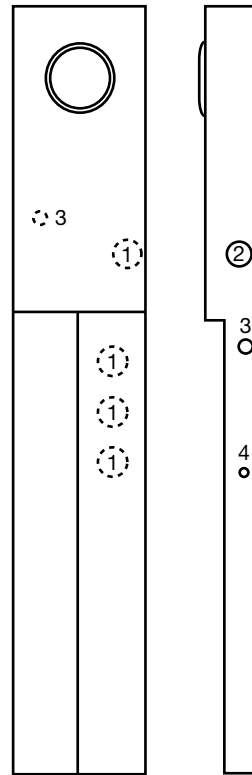

5706  
5707

## Specifications

- 200 amp, 1Ø, 120/240 volt, 22K AIC, underground service only.
  - U5706 has ringless meter socket available with or without horn bypass (-KK).
  - U5707 has ring type meter socket with MR-4 screw type meter ring.
  - Suitable for use as service equipment, mobile home service equipment and temporary power service equipment.
  - Direct burial pedestal suitable for free standing or structure mounted installation.
  - Separate line and load wireways are removable, lockable and sealable for security.
  - Left side is for utility connection. Right side is for customer underground load exit.
  - Convenient knockouts in post for through-wall load exit requirements.
  - Type 3R enclosure constructed with type G90 galvanized steel.
  - Repaintable light gray polyester powder coat finish.
  - Wire terminations accept copper or aluminum conductors: Line & Neutral: #6-350 Ground: (4) #14-1/0.
  - Main circuit breaker can be series or parallel connected.
  - Universal 4 circuit branch 125 amp interior (up to (2) 2-pole) accepts most manufacturers plug-in type circuit breakers. See wiring diagram.
- \*Provisions for up to two Type 3R in-use receptacle.  
\*Order receptacle and bridge separately. See ordering information.

Please consult serving utility for their requirements prior to ordering or installing, as specifications and approvals vary by utility, and may require local electrical inspector approval. All installations must be installed by a licensed electrician and must comply with all national and local codes, laws and regulations. Milbank reserves the right to make changes in specifications and features shown without notice or obligation.



### 200 Amp | 4 Terminal | Meter Main Pedestal | Ringless

| Catalog Number  | Service | Bypass | Connectors CU/AL |      | Dimensions |    |    | Knockouts |   |   |     |
|-----------------|---------|--------|------------------|------|------------|----|----|-----------|---|---|-----|
|                 |         |        | Line             | Load | D"         | W" | H" | 1         | 2 | 3 | 4   |
| U5706-O-200S    | UG      | None   | #6-350           | CB   | 5½         | 14 | 80 | 2½        | 2 | 1 | ¼,½ |
| U5706-O-200S-KK | UG      | Horn   | #6-350           | CB   | 5½         | 14 | 80 | 2½        | 2 | 1 | ¼,½ |

### 200 Amp | 4 Terminal | Meter Main Pedestal | Ring Type

| Catalog Number | Service | Bypass | Connectors CU/AL |      | Dimensions |    |    | Knockouts |   |   |     |
|----------------|---------|--------|------------------|------|------------|----|----|-----------|---|---|-----|
|                |         |        | Line             | Load | D"         | W" | H" | 1         | 2 | 3 | 4   |
| U5707-O-200S   | UG      | None   | #6-350           | CB   | 5½         | 14 | 80 | 2½        | 2 | 1 | ¼,½ |

### Notes

- **Fifth Terminal:** For field installed fifth terminal, order **K5T**.
- **Receptacles:** Maximum of two receptacles can be added. Contact Milbank for details.
- **Post Extension Kit:** To increase pedestal height, order field-installed post extension kit **K5708**.
- **Series-to-Parallel Field Conversion:** For field conversion from series to parallel wired, order kit **K5193**.
- **Branch Circuit Breakers (Four Additional Single Pole Spaces):** Branch interior accepts most manufacturers' small frame plug-in type circuit breakers (GE, Siemens, Cutler Hammer). Load center's four left stabs are rated up to 125 amp total.

### Accessories



K5400-BRIDGE-1POS



K5400-BRIDGE-2POS



UQFPH-M-200

# Temporary Power

## U4908 & U4909 Underground Service Power Outlet

**75**  
TEMPORARY  
POWER



U4909-O-11GR

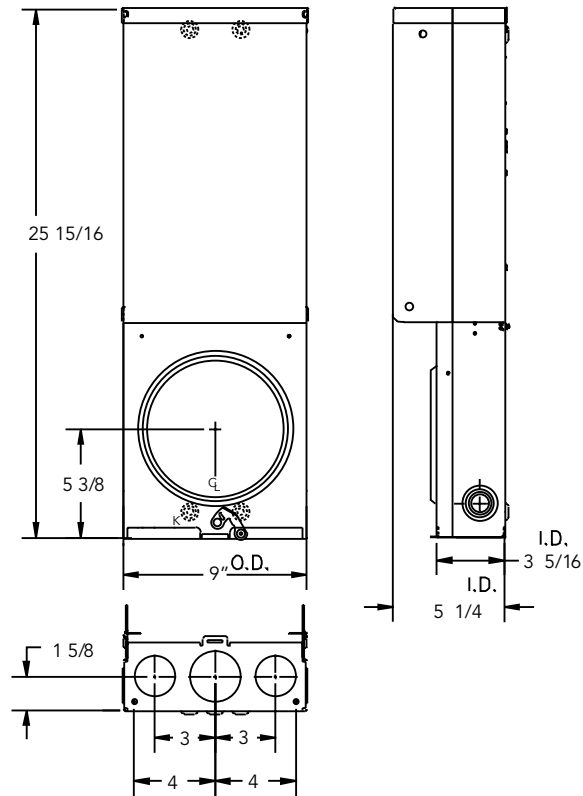

### Specifications

- Available in ringless style (**U4908** series) or ring type (**U4909** series).
- UL listed 100 amp, 120/240 Volt – 1Ø Underground Service Power Outlets.
- Short circuit current withstand rating 10K RMS symmetrical amperes.
- Type 3R welded enclosure for durable outdoor use.
- Enclosure constructed with galvanized 16 gauge steel.
- ANSI 61 gray polyester powder coat finish.
- Convenient concentric knock-out configurations and mounting embosses.
- Wire terminations accept copper or aluminum conductors.  
Service – Line & Neutral: (1) #6-2/0 Load Ground: (2) 1/0-#14 & (4) #6-#14  
Load Neutral: (2) 1/0-#14 & (4) #6-#14 Service Ground: #2-#8
- Six circuit plated copper interior accepts standard plug-in type circuit breakers.
- Three position **self-grounded** receptacle bridge accepts most standard NEMA receptacles with mounting plates.
- Four terminal, ringless meter socket with stainless steel locking hasp. Ring type socket has aluminum **MR-2** snap action sealing ring.
- Lockable hinge cover and deadfront are removable for installation and maintenance. Stay-open hinge cover has safety interlock on deadfront. Deadfront must be removed before hinge cover can be removed.
- Tamper proof fastening available.

Please consult serving utility for their requirements prior to ordering or installing, as specifications and approvals vary by utility, and may require local electrical inspector approval. All installations must be installed by a licensed electrician and must comply with all national and local codes, laws and regulations. Milbank reserves the right to make changes in specifications and features shown without notice or obligation.



### U4908 & U4909 Standard Configurations

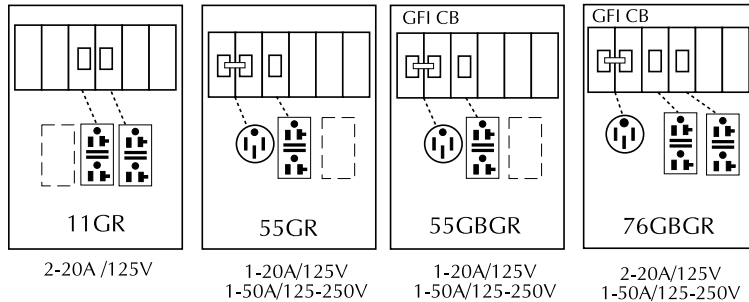

### Ordering Information

| Catalog Number   | Socket Type | Description  |
|------------------|-------------|--|
| • U4908-O        | Ringless    | Order base model and up to three factory installed receptacle/breaker kit separately from list below. Other kits available. Consult factory. |
| • U4908-O-11GR   | Ringless    |  |
| • U4908-O-55GBGR | Ringless    |  |
| • U4909-O        | Ring type   | Order base model and up to three factory installed receptacle/breaker kit separately from list below. Other kits available. Consult factory. |
| • U4909-O-11GR   | Ring type   |  |
| • U4909-O-55GBGR | Ring type   |  |

**Note:** Flat cover may not close completely with twist locking devices in use.

Order slope-front 3R cover #1107681 separately to use with twist lock type receptacles.

- Stock item – availability subject to prior sale.
- Non-stock items – minimum order quantity required.

# Temporary Power

## Series U5001 Unmetered Service Mount Power Outlet

**77**  
TEMPORARY  
POWER



**U5001-RL-01**

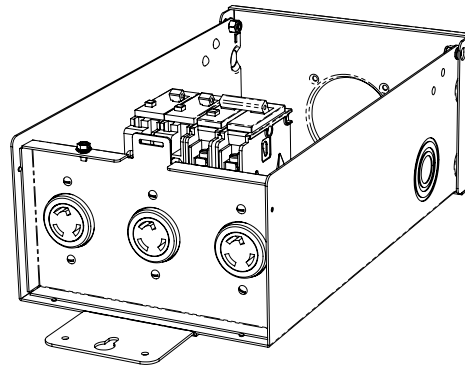

### Specifications

- UL listed 125 amp, 120/240 Volt, 1Ø Power Outlet.
- Short circuit current withstand rating 10K RMS symmetrical amperes.
- Type 3R welded enclosure for durable outdoor use.
- ANSI 61 gray polyester powder coat finish.
- Wire terminations accept copper or aluminum conductors.  
Line: 1/0-#4    Ground/Neutral: (4) 1/0-#14 & (11) #14-#6
- Six circuit plated copper interior accepts standard plug-in type circuit breakers.
- Components factory wired with stranded copper wire.
- Lockable hinge cover and deadfront are removable for installation and maintenance.
- U5001-RL-01 includes:
  - (1) L6-30    (1) 30 Amp, 2P, 240V GFI Breaker
  - (2) L5-20    (2) 20 Amp, 1P, 120V GFI Breaker

Please consult serving utility for their requirements prior to ordering or installing, as specifications and approvals vary by utility, and may require local electrical inspector approval. All installations must be installed by a licensed electrician and must comply with all national and local codes, laws and regulations. Milbank reserves the right to make changes in specifications and features shown without notice or obligation.





**U5865-XL-38GBGRW**

### Specifications

- UL listed 125 amp, 120/240 Volt, 1Ø Power Outlet.
- Short circuit current withstand rating 10K RMS symmetrical amperes.
- Type 3R welded enclosure for durable outdoor use.
- ANSI 61 gray polyester powder coat finish.
- Wire terminations accept copper or aluminum conductors.  
Line & Line Neutral: 250-#6
- Six circuit plated copper interior accepts standard plug-in type circuit breakers.
- Components factory wired with stranded copper wire.
- Lockable hinge cover and deadfront are removable for installation and maintenance.
- **U5865-XL-38GBGRW** includes:
  - (1) L6-30 (1) 30A, 2P, 240V GFI Breaker
  - (2) L5-20 GFI receptacles (2) 20A, IP, 120V Breaker

# Temporary Power

## Series U5001 Unmetered Service Mount Power Outlet

| Catalog Number | Circuit Breaker Description                                |
|----------------|--|
| Q115           | 15 Amp – 1 Pole – 120/240 – Plug-In Circuit Breaker        |
| Q120           | 20 Amp – 1 Pole – 120/240 – Plug-In Circuit Breaker        |
| Q130           | 30 Amp – 1 Pole – 120/240 – Plug-In Circuit Breaker        |
| Q220           | 20 Amp – 1 Pole – 120/240 – Plug-In Circuit Breaker        |
| Q250           | 50 Amp – 2 Pole – 120/240 – Plug-In Circuit Breaker        |
| Q2100          | 100 Amp – 2 Pole – 120/240 – Plug-In Circuit Breaker       |
| 708784-MO      | 20 Amp – GFCI – 1 Pole – 120/240 – Plug-In Circuit Breaker |
| 708785-MO      | 30 Amp – GFCI – 1 Pole – 120/240 – Plug-In Circuit Breaker |
| 707915-MO      | 50 Amp – GFCI – 1 Pole – 120/240 – Plug-In Circuit Breaker |
| 703997-MO      | 50 Amp – Quad – 2 Pole – 120/240 – Circuit Breaker         |

| Catalog Number | Receptacle Description   |
|----------------|--|
| 708777-MO      | 20 Amp – 120V – NEMA 5-20R – Duplex Receptacle                 |
| 708080-MO      | 20 Amp – 120V – NEMA 5-20 – GFCI Duplex Receptacle             |
| 704995-MO      | 20 Amp – 250V – NEMA 6-20R – Single Receptacle                 |
| 701776-MO      | 30 Amp – 120V – NEMA TT-30R – Travel Trailer Receptacle        |
| 706761-MO      | 50 Amp – 120V – 3 Pole – 3 Wire – NEMA 10-50R – Receptacle     |
| Z700911-MO     | 50 Amp – 120/250V – 3 Pole – 4 Wire – NEMA 14-50R – Receptacle |

| Catalog Number   | Lug Landings & Breaker Base Description     |
|------------------|---|
| Z1050596         | MPRV/MPAP – Lug Landing (Twin #6-350 KCMIL) |
| Z020-148-00-00-0 | MPAP – Complete Interior Assembly           |

### Note

- The following brand names may be supplied when replacement circuit breakers are ordered:  
Cutler-Hammer/ Westinghouse – QP, BQC, BD, BR. Siemens/ITE – Q, QT. General Electric – TQ, THQ, THQL.  
Challenger – C, Q, QC, QP. Contact sales office for brand specific requirements.

Please consult serving utility for their requirements prior to ordering or installing, as specifications and approvals vary by utility, and may require local electrical inspector approval. All installations must be installed by a licensed electrician and must comply with all national and local codes, laws and regulations. Milbank reserves the right to make changes in specifications and features shown without notice or obligation.



# Surface Mount Power Outlets

Millennium Series | 120/240 VAC



U5000-XL-75

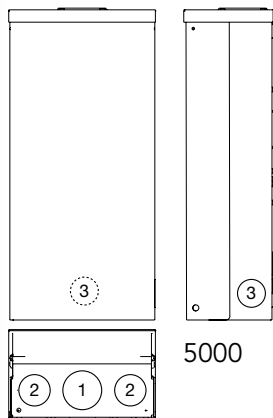

U5100-XL-75

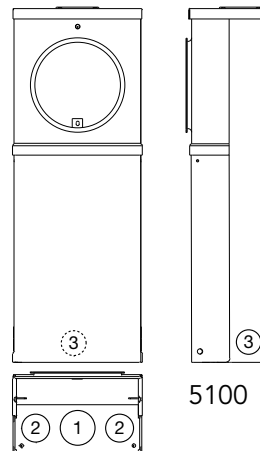

## 125 Amp | Surface Mount Power Outlets

| Catalog Number | Metered/<br>Unmetered | Receptacle Configuration | Circuit Breaker Configuration | Loop Feed | Connectors Line | Dimensions |    |     | Knockouts |    |    |
|----------------|-----------------------|--------------------------|-------------------------------|-----------|-----------------|------------|----|-----|-----------|----|----|
|                |                       |                          |                               |           |                 | D"         | W" | H"  | 1         | 2  | 3  |
| U5000-XL       | Unmetered             | —                        | —                             | Yes       | (2) 1/0-#12     | 5½         | 9⅞ | 19¼ | 2         | 1½ | 1¼ |
| U5000-XL-41    | Unmetered             | A                        | X                             | Yes       | (2) 1/0-#12     | 5½         | 9⅞ | 19¼ | 2         | 1½ | 1¼ |
| U5000-XL-55    | Unmetered             | B                        | Y                             | Yes       | (2) 1/0-#12     | 5½         | 9⅞ | 19¼ | 2         | 1½ | 1¼ |
| U5000-XL-75    | Unmetered             | C                        | Z                             | Yes       | (2) 1/0-#12     | 5½         | 9⅞ | 19¼ | 2         | 1½ | 1¼ |
| U5100-XL       | Metered               | —                        | —                             | No        | #6-250          | 5½         | 9⅞ | 25  | 2         | 1½ | 1¼ |
| U5100-XL-41    | Metered               | A                        | X                             | No        | #6-250          | 5½         | 9⅞ | 25  | 2         | 1½ | 1¼ |
| U5100-XL-55    | Metered               | B                        | Y                             | No        | #6-250          | 5½         | 9⅞ | 25  | 2         | 1½ | 1¼ |
| U5100-XL-75    | Metered               | C                        | Z                             | No        | #6-250          | 5½         | 9⅞ | 25  | 2         | 1½ | 1¼ |

### Receptacle Configurations

| A                        | B                         | C                                    |
|--------------------------|---------------------------|--------------------------------------|
|                          |                           |                                      |
| (1) TT30R, (1) 5-20R GFI | (1) 14-50R, (1) 5-20R GFI | (1) 14-50R, (1) TT30R, (1) 5-20R GFI |

### Circuit Breaker Configurations

| X                                      | Y  | Z   |
|--|--|---|
|  |  |   |
| (1) 30A, 1P, 120V<br>(1) 20A, 1P, 120V | (1) 50A, 2P, 120/240V<br>(1) 20A, 1P, 120V | (1) 50A, 2P, 120/240V<br>(1) 30A, 1P, 120V<br>(1) 20A, 1P, 120V |

### NOTE

These units are typically used for submetering applications.

Contact factory for additional configurations not shown here.



Please consult serving utility for their requirements prior to ordering or installing, as specifications and approvals vary by utility, and may require local electrical inspector approval. All installations must be installed by a licensed electrician and must comply with all national and local codes, laws and regulations. Milbank reserves the right to make changes in specifications and features shown without notice or obligation.



# Power Outlet Pedestals

Millennium Series | 120/240 VAC

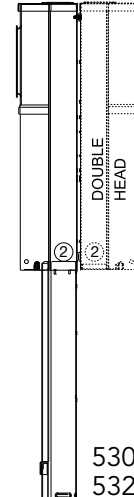
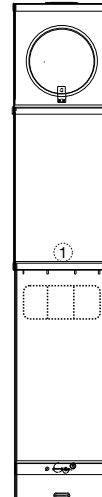
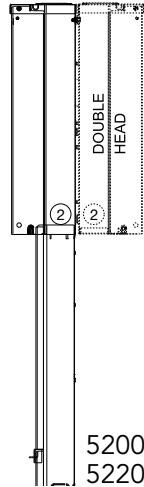
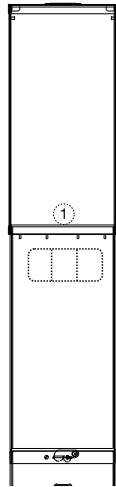

U5200-XL-75

U5300-O-75

## 125 Amp | Power Outlet Pedestals

| Catalog Number | Double Head Catalog Number | Metered/Unmetered | Receptacle Configuration | Circuit Breaker Configuration | Dimensions                     |                               |                                | Mounting Type |
|----------------|----------------------------|-------------------|--------------------------|-------------------------------|--------------------------------|-------------------------------|--------------------------------|---------------|
|                |                            |                   |                          |                               | D"                             | W"                            | H"                             |               |
| U5200-XL       | U5220-XL                   | Unmetered         | —                        | —                             | 5 <sup>5</sup> / <sub>16</sub> | 9 <sup>7</sup> / <sub>8</sub> | 64 <sup>1</sup> / <sub>2</sub> | Direct Burial |
| U5200-XL-41    | U5220-XL-41                | Unmetered         | A                        | X                             | 5 <sup>5</sup> / <sub>16</sub> | 9 <sup>7</sup> / <sub>8</sub> | 64 <sup>1</sup> / <sub>2</sub> | Direct Burial |
| U5200-XL-55    | U5220-XL-55                | Unmetered         | B                        | Y                             | 5 <sup>5</sup> / <sub>16</sub> | 9 <sup>7</sup> / <sub>8</sub> | 64 <sup>1</sup> / <sub>2</sub> | Direct Burial |
| U5200-XL-75    | U5220-XL-75                | Unmetered         | C                        | Z                             | 5 <sup>5</sup> / <sub>16</sub> | 9 <sup>7</sup> / <sub>8</sub> | 64 <sup>1</sup> / <sub>2</sub> | Direct Burial |
| U5300-O        | U5320-O                    | Metered           | —                        | —                             | 5 <sup>5</sup> / <sub>16</sub> | 9 <sup>7</sup> / <sub>8</sub> | 70 <sup>1</sup> / <sub>4</sub> | Direct Burial |
| U5300-O-41     | U5320-O-41                 | Metered           | A                        | X                             | 5 <sup>5</sup> / <sub>16</sub> | 9 <sup>7</sup> / <sub>8</sub> | 70 <sup>1</sup> / <sub>4</sub> | Direct Burial |
| U5300-O-55     | U5320-O-55                 | Metered           | B                        | Y                             | 5 <sup>5</sup> / <sub>16</sub> | 9 <sup>7</sup> / <sub>8</sub> | 70 <sup>1</sup> / <sub>4</sub> | Direct Burial |
| U5300-O-75     | U5320-O-75                 | Metered           | C                        | Z                             | 5 <sup>5</sup> / <sub>16</sub> | 9 <sup>7</sup> / <sub>8</sub> | 70 <sup>1</sup> / <sub>4</sub> | Direct Burial |

## Notes

- **Receptacle Configurations** - Reference chart on page 79.

### NOTE

These units are typically used for submetering applications. Contact factory for additional configurations not shown here. Pad mount is available. Contact factory for information.

Please consult serving utility for their requirements prior to ordering or installing, as specifications and approvals vary by utility, and may require local electrical inspector approval. All installations must be installed by a licensed electrician and must comply with all national and local codes, laws and regulations. Milbank reserves the right to make changes in specifications and features shown without notice or obligation.



# Replacement Receptacle Plates

*For Millennium Series Products*

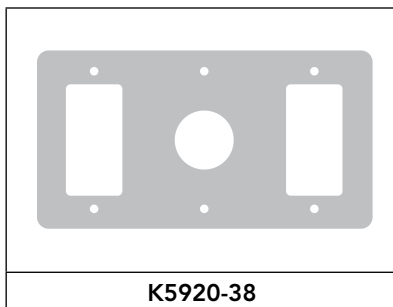
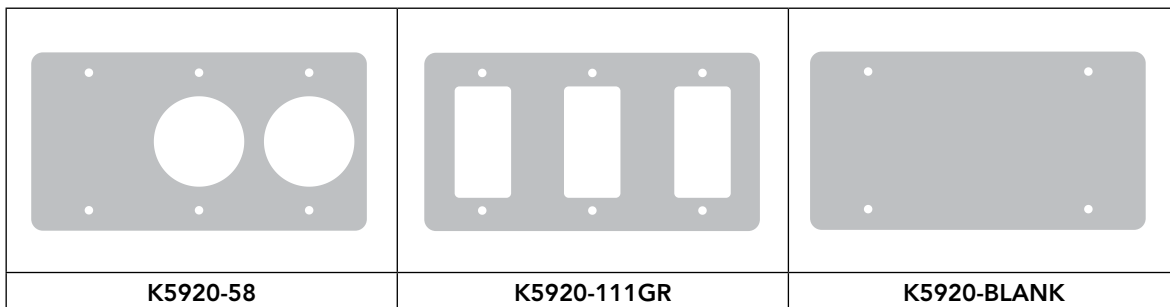
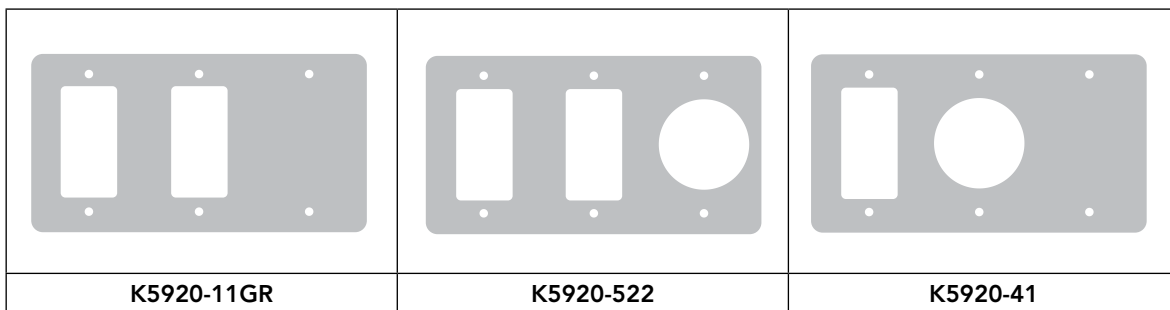
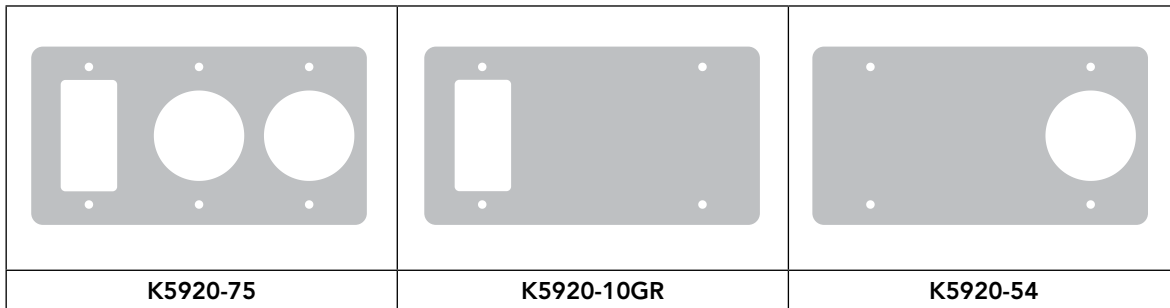

## Notes

- For application details, consult factory.



Please consult serving utility for their requirements prior to ordering or installing, as specifications and approvals vary by utility, and may require local electrical inspector approval. All installations must be installed by a licensed electrician and must comply with all national and local codes, laws and regulations. Milbank reserves the right to make changes in specifications and features shown without notice or obligation.

# Lighting Accessories

For Millennium Series Products

## Internal LED Light Kits for Unmetered Power Outlets (U5000 & U5200)

|                     |  |   |
|---------------------|--|---|
| <b>Application</b>  | Internal light kit for unmetered power outlets   |  |
| <b>LED Features</b> | Includes new LED light, lamp shield and opaque hinge cover lens. Factory wired to 20 amp GFI circuit. May be wired to separate 20 amp circuit breaker. Order <b>Q120</b> separately.<br><br>Cover on unmetered power outlet is 19 $\frac{1}{8}$ " in height. |   |
| <b>Ordering</b>     | Order with <b>-LD</b> suffix (after catalog number) for factory installed.<br><br>Order catalog number <b>K6212</b> for field installed.   |   |

## Internal Fluorescent Light Kits for Unmetered Power Outlets (U5000 & U5200)

|                             |  |  |
|-----------------------------|--|--|
| <b>Application</b>          | Internal light kit for unmetered power outlets   |  |
| <b>Fluorescent Features</b> | Includes 5-watt fluorescent lamp socket, ballast, lamp shield and opaque hinge cover lens. Factory wired to 20 amp GFI circuit. May be wired to separate 20 amp circuit breaker. Order <b>Q120</b> separately.<br><br>Cover on unmetered power outlet is 19 $\frac{1}{8}$ " in height. |  |
| <b>Ordering</b>             | Order with <b>-L</b> suffix (after catalog number) for factory installed.<br><br>Order catalog number <b>K5411</b> for field installed.  |  |

## Photoelectric Light Control Kit

|                    |   |   |
|--------------------|---|---|
| <b>Application</b> | Photoelectric light control kit for <b>K5411</b> light kits.  |  |
| <b>Features</b>    | 2.5 amp, 120 volt photo electrical control wired in series with <b>K5411</b> light kits.  |   |
| <b>Ordering</b>    | Order with <b>-LPC</b> suffix for factory installed light and PE control.<br><br>Order catalog number <b>K5413</b> for field installed. |   |

**WARNING!**

Always disconnect power prior to installing these devices.

Please consult serving utility for their requirements prior to ordering or installing, as specifications and approvals vary by utility, and may require local electrical inspector approval. All installations must be installed by a licensed electrician and must comply with all national and local codes, laws and regulations. Milbank reserves the right to make changes in specifications and features shown without notice or obligation.



### Internal Light Kits for Metered Power Outlets (U5100 & U5300)

|                     |  |   |
|---------------------|--|---|
| <b>Application</b>  | Internal light kit for metered power outlets   |  |
| <b>LED Features</b> | Includes new <b>LED light</b> , lamp shield and opaque hinge cover lens. Factory wired to 20 amp GFI circuit. May be wired to separate 20 amp circuit breaker. Order <b>Q120</b> separately.<br><br>Cover on metered power outlet is 15¼" in height. |   |
| <b>Ordering</b>     | Order with <b>-LD</b> suffix (after catalog number) for factory installed.<br><br>Order catalog number <b>K6213</b> for field installed.   |   |

|                             |  |  |
|-----------------------------|--|--|
| <b>Application</b>          | Internal light kit for metered power outlets   |  |
| <b>Fluorescent Features</b> | Includes 5-watt fluorescent lamp socket, ballast, lamp shield and opaque hinge cover lens. Factory wired to 20 amp GFI circuit. May be wired to separate 20 amp circuit breaker. Order <b>Q120</b> separately.<br><br>Cover on metered power outlet is 15¼" in height. |  |
| <b>Ordering</b>             | Order with <b>-L</b> suffix (after catalog number) for factory installed.<br><br>Order catalog number <b>K5412</b> for field installed.  |  |

### Photoelectric Light Control Kit

|                    |   |   |
|--------------------|---|---|
| <b>Application</b> | Photoelectric light control kit for <b>K5412</b> light kits.  |  |
| <b>Features</b>    | 2.5 amp, 120 volt photo electrical control wired in series with <b>K5412</b> light kits.  |   |
| <b>Ordering</b>    | Order with <b>-LPC</b> suffix for factory installed light and PE control.<br><br>Order catalog number <b>K5413</b> for field installed. |   |

**WARNING!**

Always disconnect power prior to installing these devices.

# Telecom and Pedestal Accessories

For Millennium Series Products

85

TELECOM AND  
PEDESTAL  
ACCESSORIES

## Telephone and Cable TV Kit

|                    |   |  |
|--------------------|---|--|
| <b>Application</b> | Mounts to rear of pedestal series <b>U5200</b> and <b>U5300</b> . May also be adaptable to a wooden or similar structure.   |  <p><b>K4709-02-3R</b>    <b>K4709-02</b></p> |
| <b>Features</b>    | Single: 16" galvanized raceway, (1) RJ11 telephone jack and (1) Type F coaxial CATV jack.<br><br>Dual: 16" galvanized raceway, (2) RJ11 telephone jacks and (1) Type F coaxial CATV jack.<br><br>Includes mounting hardware and instructions. |  |
| <b>Ordering</b>    | Single line telephone and cable TV kit order <b>K4709-02</b> .  |  |
| <b>Note</b>        | Confirm acceptability with Cable TV and Telephone provider before ordering or installing these devices.   |  |

## Water Shroud with Hardware

|                    |  |  |
|--------------------|--|--|
| <b>Application</b> | Used to cover water pipe and provide means to mount hose bib to rear of pedestal.                        |  |
| <b>Features</b>    | Includes mounting hardware and instructions.<br><br>Matches <b>K4709</b> kits when mounted side-by-side. |  |
| <b>Ordering</b>    | Order catalog number <b>K4709-WS</b> .   |  |

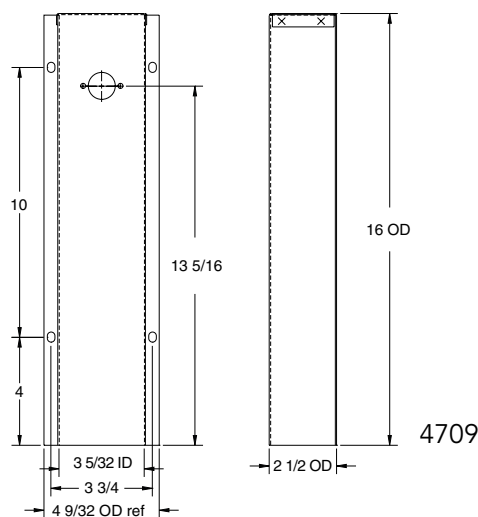

Please consult serving utility for their requirements prior to ordering or installing, as specifications and approvals vary by utility, and may require local electrical inspector approval. All installations must be installed by a licensed electrician and must comply with all national and local codes, laws and regulations. Milbank reserves the right to make changes in specifications and features shown without notice or obligation.



# Pedestal Mounting Accessories

*For Millennium Series Products*

## Field-Installed Pad Mount Kit

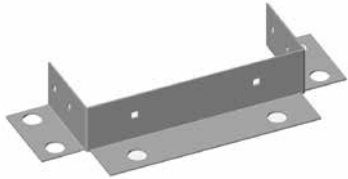
|                    |   |  |
|--------------------|---|--|
| <b>Application</b> | Field installed pad mount kit with (6) ¾" mounting holes.   |  |
| <b>Features</b>    | Includes ¼-20 stainless steel hardware to attach pad mount base to post.<br><br>Anchor bolt kit sold separately (order catalog number <b>K5421</b> ). |  |
| <b>Ordering</b>    | Order catalog number <b>K5410</b> .   |  |

## Stabilizer Foot with Hardware

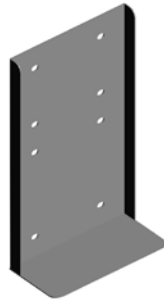
|                    |  |  |
|--------------------|--|--|
| <b>Application</b> | Stabilizes direct burial type posts in unstable soil conditions.             |  |
| <b>Features</b>    | Includes ¼-20 hardware to attach to <b>U5200</b> and <b>U5300</b> pedestals. |  |
| <b>Ordering</b>    | Order catalog number <b>K5415</b> .  |  |

## Anchor Bolt Kit

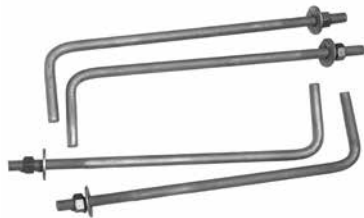
|                    |   |  |
|--------------------|---|--|
| <b>Application</b> | Concrete anchor bolt kit designed to attach pad mount base to concrete.                   |  |
| <b>Features</b>    | (4) sets of zinc-plated ⅝-11 x 10" bolt with 2" toe.<br><br>Includes nut and flat washer. |  |
| <b>Ordering</b>    | Order catalog number <b>K5421</b> .   |  |

# Metering & Receptacle Accessories

For Millennium Series Products

## Field-Installed Meter Kits





|                    |   |   |
|--------------------|---|---|
| <b>Application</b> | Field installed meter kit for <b>U5000</b> and <b>U5200</b> power outlets.  |  |
| <b>Features</b>    | 100 amp cast meter socket, CL200 E-Z Read Meter, sealing ring, security seal, 1" Milbank hub, nipple and mounting screws.<br><br>See CL200 for Watt-hour meter specification. |   |
| <b>Ordering</b>    | Order catalog number <b>K4800-01 mechanical meter kit</b> , or <b>K4800-D digital meter kit</b> .   |   |

## E-Z Read Watt-Hour Meter

|                    |   |  |
|--------------------|---|--|
| <b>Application</b> | 200 amp E-Z read watt-hour meter designed to be field installed on the U5100 and U5300 metered power outlets.   |  |
| <b>Features</b>    | 200 amp form 2S 120/240 volt.<br><br>Numeric readout in full kilowatt increments. No "tenths" dial; digital readout option available.<br><br>Remanufactured within 1% accuracy. |  |
| <b>Ordering</b>    | Order catalog number <b>CL200-D</b> .   |  |

**CL200-D**  
Digital

## Single Receptacle Only Power Outlet

|                           |   |  |  |  |
|---------------------------|---|--|--|--|
| <b>Application</b>        | Overhead/underground power outlet receptacle, suitable for RV, temporary service, campground, marina and boatyard equipment.    |  |  |  |
| <b>Features</b>           | Type 3R, 120/240 volt single phase.<br><br>Lockable cover.<br><br>Breaker not included (in receptacle box).                     |  |  |  |
| <b>Ordering</b>           | Order catalog number from chart below.  |  |  |  |
| <b>Receptacle Options</b> | <br><b>P-10GWR</b><br>20A 5-20GR<br>120V GFI | <br><b>P-13</b><br>30A TT-30R<br>120V | <br><b>P-54</b><br>50A 14-50R<br>120/240V |  |

### WARNING!

Always disconnect power prior to installing these devices.

Please consult serving utility for their requirements prior to ordering or installing, as specifications and approvals vary by utility, and may require local electrical inspector approval. All installations must be installed by a licensed electrician and must comply with all national and local codes, laws and regulations. Milbank reserves the right to make changes in specifications and features shown without notice or obligation.





# Replacement Parts & Accessories

For Millennium Series Products

|   |   |   |   |
|---|---|---|---|
|  |  |  |  |
| <b>Q120</b><br>20 Amp, 1 pole<br>circuit breaker                                  | <b>708784-MO</b><br>20 Amp, 1 pole<br>GFI circuit breaker                         | <b>Q130</b><br>30 Amp, 1 pole<br>circuit breaker                                  | <b>Q250</b><br>50 Amp, 2 pole<br>circuit breaker                                    |

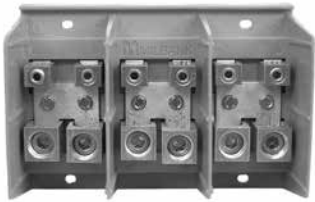
| Main Breaker Kit<br>Part number | Metered/Unmetered<br>Surface Mount/ Pedestal | Amp |
|---------------------------------|--|-----|
| K5400-100MBM                    | Metered                                      | 100 |
| K5400-100MBU                    | Unmetered                                    | 100 |

|   |   |   |
|---|---|---|
|  |  |  |
| <b>Z918466-AC</b><br>Lug landing base   | <b>Z917602-AC</b><br>Circuit breaker base<br>(6-circuit)                            | <b>Z915141-AC</b><br>Left or right meter block<br>assembly                            |









Please consult serving utility for their requirements prior to ordering or installing, as specifications and approvals vary by utility, and may require local electrical inspector approval. All installations must be installed by a licensed electrician and must comply with all national and local codes, laws and regulations. Milbank reserves the right to make changes in specifications and features shown without notice or obligation.



# Replacement Parts & Accessories

For Millennium Series Products

|  |  |  |
|--|--|--|
|                 |               |  |
| <b>Z918449-AC</b><br>(19" unmetered)<br><b>Z918447-AC</b><br>(15" metered)<br><i>Hinge cover</i> | <b>Z818052-SC</b><br>(19" unmetered)<br><b>Z818480-SC</b><br>(15" metered)<br><i>Deadfront</i> | <b>MR-2</b><br><i>Snap action sealing ring</i>                                     |

|  |  |  |
|--|--|--|
|  |  |  |
| <b>Z708080-MO</b><br><i>20 Amp GFI receptacle</i><br>NEMA 5-20GR                   | <b>Z701776-MO</b><br><i>30 Amp receptacle</i><br>NEMA TT-30                        | <b>Z708767-MO</b><br><i>50 Amp receptacle</i><br>NEMA 14-50R                         |

Please consult serving utility for their requirements prior to ordering or installing, as specifications and approvals vary by utility, and may require local electrical inspector approval. All installations must be installed by a licensed electrician and must comply with all national and local codes, laws and regulations. Milbank reserves the right to make changes in specifications and features shown without notice or obligation.





### Specifications

- 600 to 1200 amp, 120/240 Volt, 1Ø distribution bus accepts up to (6) 2 pole, 200 amp circuit breakers. Order from chart below.
- Costly main breaker not required per NEC 230-71.
- Economical alternative to costly wall hung or strut-mounted panel boards and load centers.
- Low profile, aesthetic design can be located near utility transformers or fed from a main service to a convenient location.
- Pad mounted Type 3R powder coated aluminum enclosure – standard color is gray.
- Hinge door and lift off rear service door are lockable and sealable for security.

**NOTE:** Consult local code enforcement for pad size requirements. Order catalog number **CP-24-PDMNT-CALT** pad mount base or catalog number **CP-ABK5/8** anchor bolt kit separately.

### Circuit Breakers

| Catalog Number | Amp  | Phase | Volts   | Connectors CU/AL                          |                     | Dimensions |    |    |
|----------------|------|-------|---------|---|---------------------|------------|----|----|
|                |      |       |         | Line                                      | Load                | D"         | W" | H" |
| CP3B-AUX-1200  | 1200 | 1Ø    | 120/240 | (3) 1-600 kcmil/Ø or<br>(3) 2-250 kcmil/Ø | See Circuit Breaker | 17         | 24 | 41 |

### Circuit Breakers

200 Amp Frame | Plug-In | 10K AIC | Two-Pole | Common Trip



| 2-Pole Rating | 10K AIC Plug-In | Package Quantity | Connectors CU/AL |         |
|---------------|-----------------|------------------|------------------|---------|
|               |                 |                  | Line             | Load    |
| 100           | UQFP-100        | 1                | #3-#1            | #1-1/0  |
| 125           | UQFP-125        | 1                | #3-#1            | #1-1/0  |
| 150           | UQFP-150        | 1                | 1/0-300          | 2/0-300 |
| 175           | UQFP-175        | 1                | 1/0-300          | 2/0-300 |
| 200           | UQFP-200        | 1                | 1/0-300          | 2/0-300 |
| 225           | UQFP-225        | 1                | 1/0-300          | 2/0-300 |

# Recreational Vehicle

600-1200 Amp | Pad mounted Panel Board



U4540-XL

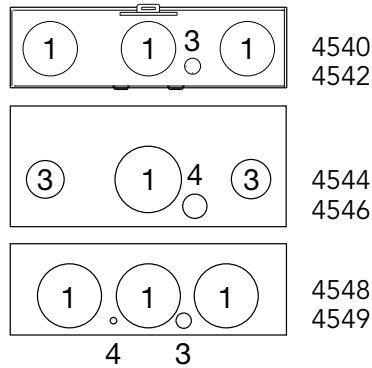
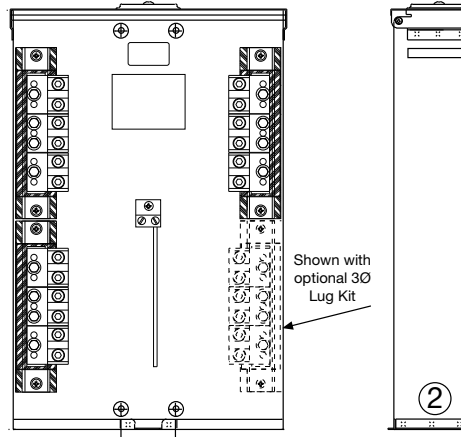

## Terminal Boxes | 1Ø & 3Ø | 120/240 Volt

| Catalog Number | Amp | Phase | Volts   | Hub  | 1Ø to 3Ø Kit | Connectors CU7AL         | Dimensions |          |    | Knockouts |       |       |          |          |
|----------------|-----|-------|---------|------|--------------|--------------------------|------------|----------|----|-----------|-------|-------|----------|----------|
|                |     |       |         |      |              |                          | D"         | W"       | H" | 1         | 2     | 3     | 4        | 5        |
| U4544-XL       | 100 | 1     | 120/240 | C.P. | K4543        | (6) #12-1/0              | 4 1/8      | 9 13/16  | 18 | —         | 2     | 2     | 1        | 1/4, 1/2 |
| U4546-XL       | 100 | 3     | 600     | C.P. | N/A          | (6) #12-1/0              | 4 1/8      | 9 13/16  | 18 | —         | 2     | 2     | 1        | 1/4, 1/2 |
| U4540-XL       | 200 | 1     | 120/240 | C.P. | K4539        | (6) #6-350               | 4 1/8      | 14 13/16 | 23 | —         | 1 1/4 | 2 1/2 | 2 1/2    | 1/4, 1/2 |
| U4542-XL       | 200 | 3     | 600     | C.P. | N/A          | (6) #6-350               | 4 1/8      | 14 13/16 | 23 | —         | 1 1/4 | 2 1/2 | 2 1/2    | 1/4, 1/2 |
| U4548-RXL      | 400 | 1     | 120/240 | C.P. | K4547        | (3) #6-350 or (2) #4-600 | 5          | 15 1/2   | 27 | 3         | 3     | 3     | 1/4, 1/2 | 1/4      |
| U4549-RXL      | 400 | 3     | 600     | C.P. | N/A          | (3) #6-350 or (2) #4-600 | 5          | 15 1/2   | 27 | 3         | 3     | 3     | 1/4, 1/2 | 1/4      |

## Notes

- **Hub:** Standard hub opening on top with closing plate attached.
- **Features:** UL listed pad lockable Type 3R enclosure.
- **3Ø 120/240V application:** Field-installable 3Ø lug kit converts 1Ø unit to 3Ø unit.

Please consult serving utility for their requirements prior to ordering or installing, as specifications and approvals vary by utility, and may require local electrical inspector approval. All installations must be installed by a licensed electrician and must comply with all national and local codes, laws and regulations. Milbank reserves the right to make changes in specifications and features shown without notice or obligation.



# Dry Type Transformers

*With Distribution for RV & Mobile Home Park Applications*



| 480 Volts to 120/240 Single Phase |      |           |
|-----------------------------------|------|-----------|
| Catalog Number                    | KVA  | Weight    |
| 10URMD*                           | 100  | 1050 lbs. |
| 16URMD*                           | 167½ | 1400 lbs. |
| 20URMD*                           | 200  | 1650 lbs. |
| 25URMD                            | 250  | 1950 lbs. |

\* UL listed

| 2400 Volts to 120/240 Single Phase |      |           |
|------------------------------------|------|-----------|
| Catalog Number                     | KVA  | Weight    |
| 10URMD24                           | 100  | 1050 lbs. |
| 16URMD24                           | 167½ | 1400 lbs. |
| 20URMD24                           | 200  | 1650 lbs. |
| 25URMD24                           | 250  | 1950 lbs. |

| Voltage  | Dimensions |     |     |
|----------|------------|-----|-----|
|          | A          | B   | C   |
| 480V, A  | 48"        | 38" | 40" |
| 2400V, A | 48"        | 41" | 53" |

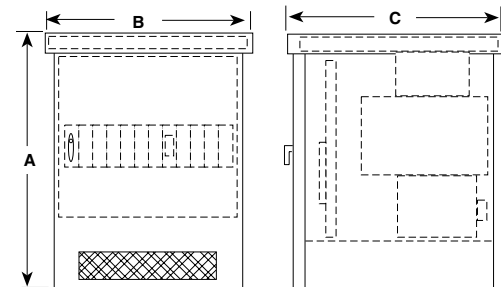
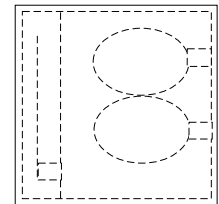

## Specifications

- Built in accordance with NEMA, ASA and AIEEE standards. Designed and tested to withstand 150% of rated load for two continuous hours. Consult local utility for acceptance of this product.
- Integrated design of the enclosure, core and coil, and secondary distribution panel permits convenient vertical line and load terminations.
- Primary and/or secondary main circuit breaker protection available. Consult local utility for 480 volt overcurrent protection requirements. Single fuse primary overcurrent protection provided on 2400 volt and above units.
- Other primary voltages available: 4160, 4800, 7200, 7960, & 12,470. Consult factory. Not UL listed.

## Core and Coil

- Aluminum wound (Copper available)
- Standard voltage taps @ 2FCAN and 4FCBN
- Rated at 150° C temperature rise

## Distribution Bus

- 1600 amp tin plated aluminum
- Space available for up to (12) circuit breakers – 1600 amp maximum
- Uses Milbank type UQFP-100 through 200 amp circuit breakers (See page 117-118)

## Enclosure

- Type 3R enclosure
- Powder coated galvanized steel (aluminum available)
- Lockable primary and secondary doors
- Lifting hooks and fork lift slots provided



Please consult serving utility for their requirements prior to ordering or installing, as specifications and approvals vary by utility, and may require local electrical inspector approval. All installations must be installed by a licensed electrician and must comply with all national and local codes, laws and regulations. Milbank reserves the right to make changes in specifications and features shown without notice or obligation.

# Commercial Pedestals

Attractive | Easy to Install | Secure | Cost-Effective

**Milbank Commercial Pedestals** are pad-mounted, weatherproof electrical enclosures consisting of a utility pull section with optional meter socket, and a customer section containing distribution and control equipment. Milbank Commercial Pedestals are an attractive, secure, easy to install and cost-effective solution when underground remote site power distribution and control equipment is required, replacing unsightly and inefficient strut and backboard structures.



Strut and backboard



Commercial pedestal

## UL Listed as Industrial Control Equipment (File E113855)

### Standard Features

- Type 3R rain resistant, vandal-resistant cabinet of polyurethane powder coated steel (aluminum or stainless steel also available)
- UL listed as enclosed industrial control equipment (UL508)
- Isolated lockable & sealable utility metering and lug landing sections
- Lockable customer section for distribution and control equipment with internal deadfront
- Print pocket inside customer section door contains wiring schematics and installation instructions
- Most load centers are UL listed for use with various manufacturers' circuit breakers
- All stainless steel external hardware (screws, bolts, hinges, handles, hasps and sealing screws)

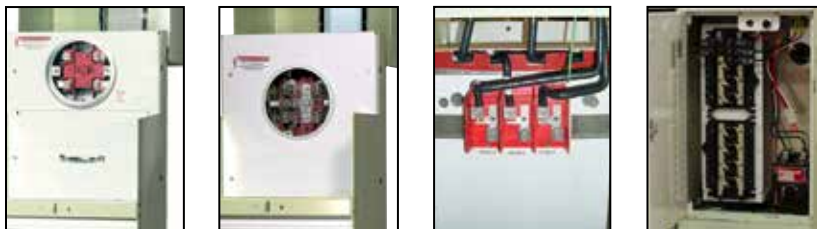

Please consult serving utility for their requirements prior to ordering or installing, as specifications and approvals vary by utility, and may require local electrical inspector approval. All installations must be installed by a licensed electrician and must comply with all national and local codes, laws and regulations. Milbank reserves the right to make changes in specifications and features shown without notice or obligation.





## Applications

These units are ideal for controlling and metering:

- Traffic signals
- Street lighting
- Power distribution for EV charging stations
- Irrigation and sprinkler systems
- Cell towers and telephone vaults
- Pump stations
- Temporary power for fairgrounds, swap meets, outdoor markets, portable offices, holiday lights, etc.
- Outdoor lighting for athletic fields, tennis and basketball courts, parking lots, landscaping and subdivision entrances, etc.

## Available Factory-Installed Options

- Meter sockets: ring type or ringless, up to 400 amp
- Main and branch breakers or T fuses
- Distribution: copper load centers and panel boards
- Clocks, timers and relays
- Photoelectric cells and controls
- Power receptacles: pin and sleeve, twist lock or straight blade
- Contactors: definite purpose, electrical or mechanically held, IEC and mercury types
- Surge protection and lightning arrestors
- Reserve inlet generator receptacle with interlocked circuit breakers
- Motor starters and relays
- Push button controls
- Thermostat controls, fans and heating strips
- Power blocks and terminal blocks
- Steel, aluminum and plywood backboards
- Transformers
- Interlock devices for circuit breakers
- Available in steel, aluminum (raw painted or anodized) or stainless steel construction with powder coated finish available in eight standard colors or special-ordered RAL colors
- Available for applications up to 400 amp, 120V, 208V, 240V, 277V, 480V - 1Ø or 3Ø

## Accessories



**K3865**  
Fifth terminal kit for use with ringless meter sockets

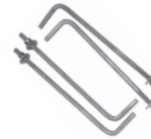

**CP-ABK5/8**  
Anchor bolt kit (includes four 5/8 - 13 x 18" anchor bolts)



**105J**  
Fifth terminal kit for use with ring-type meter sockets



**CP-TC7D**  
7-day time clock kit  
**CP-TC24H**  
24-hour time clock kit  
**CP-TCWIRE**  
Male 4-pin connector and wiring harness for use with time clocks other than above

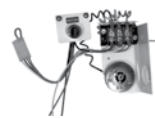

**CP-PE-HOA-3POS**  
HOA switch for field installation



**CP-16PDMNT-CALT**  
16" pedestal mounting base  
**CP-24PDMNT-CALT**  
24" pedestal mounting base (includes mounting hardware)



Please consult serving utility for their requirements prior to ordering or installing, as specifications and approvals vary by utility, and may require local electrical inspector approval. All installations must be installed by a licensed electrician and must comply with all national and local codes, laws and regulations. Milbank reserves the right to make changes in specifications and features shown without notice or obligation.

# Commercial Pedestals

Main Load Center Series | Custom Designs Available

## CP3B "ML" Series

Main Load Center Series

1Ø3 wire 120/240V or 208Y/120V

Application: remote site service for multiple loads

**Milbank Main Load Center Commercial Pedestals** are designed to handle the vast majority of all requirements in a standard, stocked configuration.

- All units feature a load center with a plug-on, back-fed main breaker.
- Load center has 16 positions for the 100 amp pedestals and 24 circuits for the 200 amp pedestals.
- Both sizes include sub-feed lugs to allow feeding an external panel.

If your application requires turning loads on based on "dusk-to-dawn" requirements, be sure to see the Milbank Switched Load Center Commercial Pedestal products on the following page.

### Features

These units include everything required for remote site service:

- NEMA 3R construction.
- Expandable: load centers allow for future expansion without costly modifications.
- All units feature 200 amp meter socket with optional field-installable fifth terminal kit available.
- 22K amp interrupting capacity (AIC) standard.
- Optional mounting base can be embedded in concrete for fast, easy installation.
- Separate sealable and lockable utility termination section.
- Separate sealable and lockable metering section.
- Separate sealable and lockable customer section with a load center for "always on" loads that include a main circuit breaker, 20 (125 or 200 amp model) or 14 (100 amp model) blank breaker spaces and a circuit directory to document configuration.

**Note**  
All meter form and bypass options available to meet utility requirements.



**Typical Applications**  
Remote site service for multiple loads.

| Standard Pedestals | Optional Fifth Terminal Kit | Main CB |         | Load Center Circuits | Meter Socket Type                 |
|--------------------|-----------------------------|---------|---------|----------------------|-----------------------------------|
|                    |                             | Amp     | Spaces  |                      |                                   |
| CP3B11115A22       | 105J                        | 100     | 1,2     | 16                   | Ring type with test/bypass blocks |
| CP3B12119A22       | 105J                        | 200     | 1,2,3 4 | 24                   | Ring type with test/bypass blocks |
| CP3B51115A22       | K3865                       | 100     | 1,2     | 16                   | Ringless socket with lever bypass |
| CP3B52119A22       | K3865                       | 200     | 1,2,3,4 | 24                   | Ringless socket with lever bypass |

### Notes

- Chart shows standard, stocked items. Other options and features are available. Contact factory for options, details and availability.

Please consult serving utility for their requirements prior to ordering or installing, as specifications and approvals vary by utility, and may require local electrical inspector approval. All installations must be installed by a licensed electrician and must comply with all national and local codes, laws and regulations. Milbank reserves the right to make changes in specifications and features shown without notice or obligation.



## CP3B "SL" Series

Switched Load Center Series  
1Ø3 wire 120/240V or 208Y/120V

**Milbank Switched Load Center Commercial Pedestals** are designed not only to provide power for various loads, but also to switch specific loads on and off under certain conditions. A photoelectric cell is used for these controlled loads, and an optional time clock is also available.

### Features

These units include everything required for remote site service:

- NEMA 3R construction.
- Expandable: load centers allow for future expansion without costly modifications.
- All units feature 200 amp meter socket with optional field-installable fifth terminal kit available.
- 22K amp interrupting capacity (AIC) standard.
- Optional mounting base can be embedded in concrete for fast, easy installation.
- Separate sealable and lockable utility termination section.
- Separate sealable and lockable metering section.
- Separate sealable and lockable customer section with a control circuit including PE receptacle, Lexan® window, glare shield, Hand-Off-Auto (HOA) switch, contractor controlling a 16-circuit load center for controlled loads, a pre-mounted DIN rail and pre-wired connector to add an optional "plug-and-play" time clock kit for PE on and TC off operation and a circuit directory to document configuration.
- A load center for "always on" loads that includes a main circuit breaker, a control power circuit breaker, a switched load center main breaker, nine (125 or 200 amp model) or 11 (100 amp model) blank breaker spaces and a circuit directory to document configuration.

**Note**  
All meter form and bypass options available to meet utility requirements.



**Typical Applications**  
Traffic signals, parking lots, highways & athletic field lighting

| Standard Pedestals | Optional Fifth Terminal Kit | Main CB |         | Contactor amperage | Meter Socket Type                 |
|--------------------|-----------------------------|---------|---------|--------------------|-----------------------------------|
|                    |                             | Amp     | Spaces  |                    |                                   |
| CP3B11110A22SL1    | 105J                        | 100     | 1,3     | 60                 | Ring type with test/bypass blocks |
| CP3B12110A22SL1    | 150J                        | 200     | 1,2,3,4 | 100                | Ring type with test/bypass blocks |
| CP3B51110A22SL1    | K3865                       | 100     | 1,3     | 60                 | Ringless socket with lever bypass |
| CP3B52110A22SL1    | K3865                       | 200     | 1,2,3,4 | 100                | Ringless socket with lever bypass |

### Notes

- Chart shows standard, stocked items. Other options and features are available. Contact factory for options, details and availability.



Please consult serving utility for their requirements prior to ordering or installing, as specifications and approvals vary by utility, and may require local electrical inspector approval. All installations must be installed by a licensed electrician and must comply with all national and local codes, laws and regulations. Milbank reserves the right to make changes in specifications and features shown without notice or obligation.



# Commercial Pedestals

## 400 Amp Series



**Milbank 400 Amp Commercial Pedestals** are designed to provide a weather and vandal resistant metered enclosure for various loads and distribution. Each pedestal has been designed to handle a wide range of applications using standard, stocked configurations.

- Choice of a single main breaker or twin service disconnect breakers gives flexibility to the pedestal design.
- Optional distribution with feed-through lugs below the service disconnect breakers allows the pedestal to handle numerous applications.
- Typical applications include remote homes where the metering is best located at the curb side or other remote area. The pedestal can also provide power to secondary residence, on-site business, workshop, irrigation, lighting, security or other secondary load.
- Available in custom colors to match home or landscaping.

### Features

These units include everything required for remote service:

- Type 3R construction
- Main circuit breaker or dual service disconnects
- Expandable: load center units allow for future expansion without costly modifications
- Optional mounting base can be embedded in concrete for fast, easy installation
- Separate sealable and lockable utility termination section with lug termination
- Separate sealable and lockable metering section
- A separate sealable and lockable customer section with a circuit directory and a print pocket to hold all documentation
- Meter socket options include ring type with bypass studs, ringless with heavy duty lever bypass, or K-Type bolt-on

#### Typical Applications

Remote site service for residential and commercial job sites.

| Standard Pedestals  | Optional fifth Terminal Kit | Main CB           | Load Center Circuits        | Meter Socket Type                |
|---------------------|-----------------------------|-------------------|-----------------------------|----------------------------------|
| <b>CP3B1411JB</b>   | N/A                         | 320 Amp (400 max) | 0                           | Ring-type with test/bypass studs |
| <b>CP3B14120B</b>   | N/A                         | 2-200 Amp         | (2) 12 circuit <sup>1</sup> | Ring-type with test/bypass studs |
| <b>CP3B54120B22</b> | K3865                       | 2-200 Amp         | (2) 12 circuit <sup>1</sup> | Ringless with lever bypass       |
| <b>CP3B5411JB22</b> | K3865                       | 320 Amp (400 max) | 0                           | Ringless with lever bypass       |

### Notes

- Chart shows standard, stocked items. Other options and features are available. Contact factory for options, details and availability.
- Stud utility landing is standard. Lug kits are available from factory.
- Units with load centers have (2) #6-250 sub-feed lugs on each load center. (Each load center is 200 amp rated and UL listed with: Siemens, General Electric and Cutler-Hammer plug-in style circuit breakers.)

Please consult serving utility for their requirements prior to ordering or installing, as specifications and approvals vary by utility, and may require local electrical inspector approval. All installations must be installed by a licensed electrician and must comply with all national and local codes, laws and regulations. Milbank reserves the right to make changes in specifications and features shown without notice or obligation.



# Commercial Pedestals

## CP3B "IR" Irrigation Control Series



**Milbank "IR" Series Irrigation Pedestals** install quickly and simply—often in less than an hour with a single technician—a fraction of the time typically needed for strut farm and other installation set ups. Additionally, the pedestal comes pre-wired, so the technician simply drops in the pre-drilled concrete box pad, fastens the pedestal and runs the wires. Prewired landing lugs are provided in a separate utility side so that there is no more need to wrestle with hard-to-bend wires. Simply run the utility wire up and land on the lugs. With both the motor starter and disconnect in the same enclosure, all the controls are housed in a safe, lockable pedestal that protects against vandalism and energy theft.

### Features

- 3Ø4W, 480Y/277 volt
- One technician can install in under an hour with use of Milbank's pre-drilled box pad
- All units are UL listed and service entrance rated
- Fused disconnect with accessible handle through the deadfront
- HOA and push button start
- Separate accessible utility side with pre-wired landing lugs
- NEMA rated starters (sizes 1-5)
- Soft start units sizes 30HP-150HP
- 30 amp fuse block for pivot pre-wired in the unit
- White powder coated paint finish helps keep components cooler
  - Options include:
    - Hour meter
    - Chemical injection receptacle
    - Multiple injection receptacle
    - Multiple 30 amp fuse blocks possible

### Typical Applications

Power pedestal for irrigation systems or other pump control applications.

| Standard Pedestals | Exterior Cabinet | NEMA Rating |
|--------------------|------------------|-------------|
| CP3B0281UMWIR04    | White            | 4           |
| CP3B0281UMWIR03    | White            | 3           |
| CP3B0181UMWIR02    | White            | 2           |

### Notes

- Chart shows standard, stocked items. Other options and features are available. Contact factory for options, details and availability.



Please consult serving utility for their requirements prior to ordering or installing, as specifications and approvals vary by utility, and may require local electrical inspector approval. All installations must be installed by a licensed electrician and must comply with all national and local codes, laws and regulations. Milbank reserves the right to make changes in specifications and features shown without notice or obligation.

# Commercial Pedestals

## CP3B "BBS" Battery Backup Series



**Milbank BBS Series Commercial Pedestals** are designed to provide battery backup power for various loads, and to switch specific loads on and off under certain conditions; a photoelectric cell or time clock to control lighting circuits, as an example. Metered and unmetered power distribution options are available. The back-up power pedestal is designed to handle the vast majority of today's back-up power requirements. By using 19" rack design, shelves can be adjusted to accommodate the required batteries and manufactures DC to AC inverters, transfer switches and other related equipment. This design gives the user a wide range of design and configuration options. Complete turnkey, ready to power-up pedestals are offered along with basic units ready to accept batteries and inverters supplied by others.

### Features

- Type 3R construction
- 100 through 320 amp meter socket with the option of either a ring type socket (conforms to EUSERC 308) with or without test/bypass blocks or a heavy duty ringless socket with lever bypass
- Separate sealable utility termination compartment
- An isolated separate customer section with service disconnects, power distribution options and power control
- 19" wide rack in customer compartment for easy layout of equipment
- Battery trays
- Thermostat with cooling fan
- Filtered louvers for heat rise flow through ventilation
- Three point door latch (key or pad lockable)

### Typical Applications

Metered emergency uninterrupted power for traffic intersections, wireless, phone and communications equipment, parking lots, camera and security locations

### Options

- Manual bypass switch
- Transfer switch for generator power back-up
- Generator inlet receptacles 30 through 200 amp
- Pad lockable provision for receptacles
- Police access door
- Metered load center distribution
- Unmetered load center distribution
- Photo electric controls (for street lighting)
- Time clocks
- HOA switches
- Contactors
- GFI duplex receptacles
- Thermostat for heating control
- Heating pads or elements
- Roll out shelves for batteries
- Surge arrestors and lighting arrestors

Please consult serving utility for their requirements prior to ordering or installing, as specifications and approvals vary by utility, and may require local electrical inspector approval. All installations must be installed by a licensed electrician and must comply with all national and local codes, laws and regulations. Milbank reserves the right to make changes in specifications and features shown without notice or obligation.



# Commercial Pedestals

## CP3B "Power Transfer" Series



**Milbank Power Transfer Series Pedestals** provide unmetered AC power, distribution, surge suppression, mechanical interlock and stand-by generator receptacle—all in a neat, compact pedestal.

### Features

- 120/240V 1Ø3W through 277/480V 3Ø4W ratings
- Metered or unmetered units
- Choice of EUSERC ring type or ringless meter sockets
- 60 amp through 400 amp ratings
- UL listed Type 3R rated
- Pad lockable, isolated utility compartments
- 20 amp GFI convenience receptacle
- Lockable recessed generator receptacle door
- Utility and generator indicator light options
- All stainless steel hardware
- Galvanized steel, aluminum or stainless steel cabinet options
- Custom designs available



### Typical Applications

Traffic intersections, cell sites, cable TV, pump and lift stations requiring utility power with backup generator power

### Typical Applications

Traffic intersections, cell sites, cable TV, pump and lift stations requiring utility power with backup generator power



Please consult serving utility for their requirements prior to ordering or installing, as specifications and approvals vary by utility, and may require local electrical inspector approval. All installations must be installed by a licensed electrician and must comply with all national and local codes, laws and regulations. Milbank reserves the right to make changes in specifications and features shown without notice or obligation.

# Commercial Pedestals

CP3BB "CT Metered" Series

101  
COMMERCIAL  
PEDESTALS



**Milbank CT Metered Series Commercial Pedestals** are designed to be used where a smaller service package would be a better choice over large 3R rated combination switchboards. These pedestals have amperage ratings of 400 to 800 amp at voltages up through 480 volt three phase.

## Features

- UL listed, freestanding Type 3R service
- A low profile CT pedestal
- All utility equipment is isolated in separated pad lockable and sealable compartments
- Separate customer compartment designed to hold distribution and control equipment
- Dead front customer construction
- Optional mounting base
- Optional construction in steel, aluminum and stainless steel.
- Wide choice of powder paint colors

## Typical Applications

Large homes, pumping & lift stations, motor control, water treatment plants, EV charging stations, commercial buildings, large remote service requirements, commercial and industrial control systems

Please consult serving utility for their requirements prior to ordering or installing, as specifications and approvals vary by utility, and may require local electrical inspector approval. All installations must be installed by a licensed electrician and must comply with all national and local codes, laws and regulations. Milbank reserves the right to make changes in specifications and features shown without notice or obligation.





**Milbank Slimline Series Commercial Pedestals** provide a sleeker, smaller footprint, with wireway access on the side of the unit rather than the back, allowing maximum flexibility to place the pedestal in tighter spaces.

### Features

- UL listed as service equipment
- 100 or 200 amp
- Vandal-resistant, secure and attractive design
- Customer compartment with distribution and control equipment with swing dead front door, secured with both a hasp/latch and draw latch outer door
- Utility metering compartment protected with a hinged hood, increasing resistance to meter vandalism
- Small footprint
- Wireway located on left side of pedestal for utility incoming wire, allowing pedestal to be mounted with back very close to a wall (14")
- Available in 12" and 20" widths and 50" and 63" (metered) and 43" (unmetered) heights
- Includes a print pocket for plans and drawings
- 200 amp main available
- Voltage range: 120V–480V
- Compatible with both ringless and ring type meter sockets, 4–7 terminals
- Available in a wide array of colors, including but not limited too all ANSI powder coated paint colors upon request
- Pedestal mounting base option saves time and labor to install on a cement pad—no anchor bolts required
- Powder coated G90 galvanized steel, raw, anodized or powder coated aluminum and stainless steel exterior options

### "Slimline" Series Direct Bury Extension



- No need for concrete
- Bolts directly to unit
- Easy, modular design
- Ships in a smaller package
- Increases project flexibility
- Easier to handle and install
- Utilizes stabilizer feet to prevent leaning over time
- Pedestal and extension can be installed within 45 minutes

### Notes

- 14 gauge steel
- Only available for 12" pedestals

### Typical Applications



Roadway lighting and signage, wastewater treatment facilities, parks and landscaping, and any application where physical space is at a premium



Please consult serving utility for their requirements prior to ordering or installing, as specifications and approvals vary by utility, and may require local electrical inspector approval. All installations must be installed by a licensed electrician and must comply with all national and local codes, laws and regulations. Milbank reserves the right to make changes in specifications and features shown without notice or obligation.

# Commercial Pedestals

## Accessories

|  |   |  |   |
|--|---|--|---|
|   |            |    |  |
| <p><b>CP-ABK5/8</b><br/>Anchor bolt kit (includes four 5/8-13" x 18" anchor bolts)</p>   | <p><b>K3865</b><br/>Fifth terminal kit for use with ringless lever bypass meter sockets</p> | <p><b>CP-TC7D</b><br/>7-day time clock kit<br/><b>CP-TC24H</b><br/>24-hour time clock kit<br/><b>CP-TCWIRE</b><br/>Male 4-pin connector and wiring harness for use with time clocks other than shown</p> | <p><b>105J</b><br/>Fifth terminal kit for use with ring type meter sockets</p>      |
|   |          |    |   |
| <p><b>CP-16PDMNT-CALT</b><br/>Pedestal mounting base for 16" pedestal<br/><b>CP-24PDMNT-CALT</b><br/>Pedestal mounting base for 24" pedestal (includes mounting hardware)<br/><b>CP-32PDMNT</b><br/>Pedestal mounting base for 32" pedestal (includes mounting hardware)</p> | <p><b>CP-PE-HOA-3POS</b><br/>HOA (Hand-Off-Auto) switch for field installation</p>          | <p><b>CP-PE-TYP5-2POS</b><br/>Two position PE control kit</p>  |   |

Please consult serving utility for their requirements prior to ordering or installing, as specifications and approvals vary by utility, and may require local electrical inspector approval. All installations must be installed by a licensed electrician and must comply with all national and local codes, laws and regulations. Milbank reserves the right to make changes in specifications and features shown without notice or obligation.



# Commercial Pedestals

## 16" Metered & Unmetered Drawings

### "A" Style 16" Metered Commercial Pedestal

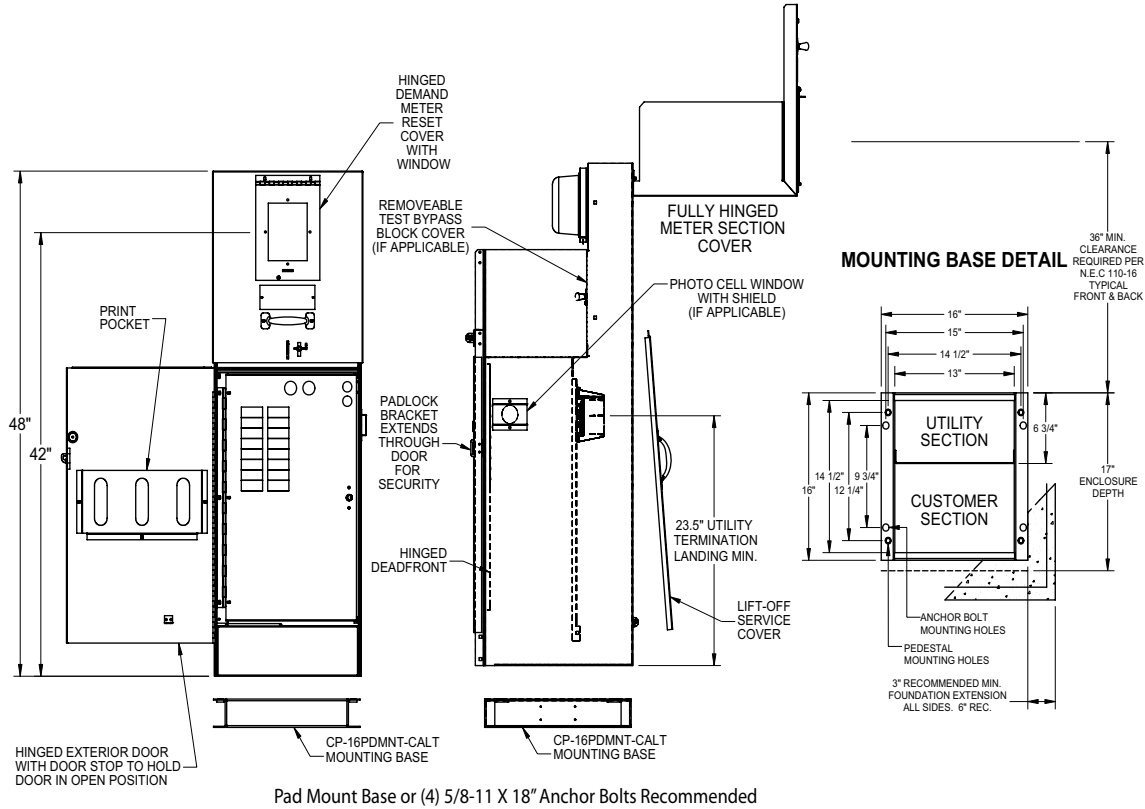

### "E" Style 16" Unmetered Commercial Pedestal | Low Profile

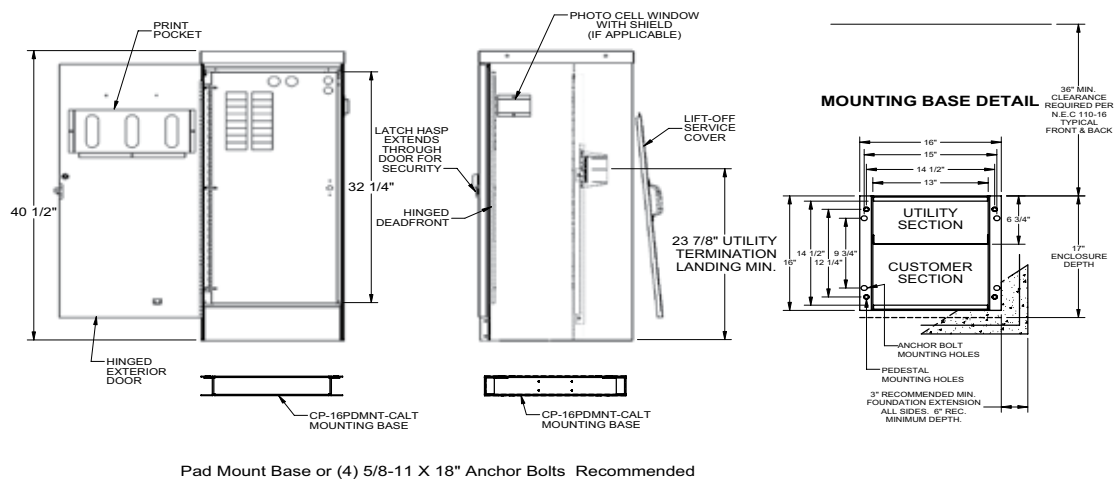

Please consult serving utility for their requirements prior to ordering or installing, as specifications and approvals vary by utility, and may require local electrical inspector approval. All installations must be installed by a licensed electrician and must comply with all national and local codes, laws and regulations. Milbank reserves the right to make changes in specifications and features shown without notice or obligation.



# Commercial Pedestals

## 24" Metered & Unmetered Drawings

### "B" Style 24" Metered Commercial Pedestal (with one or two meters)

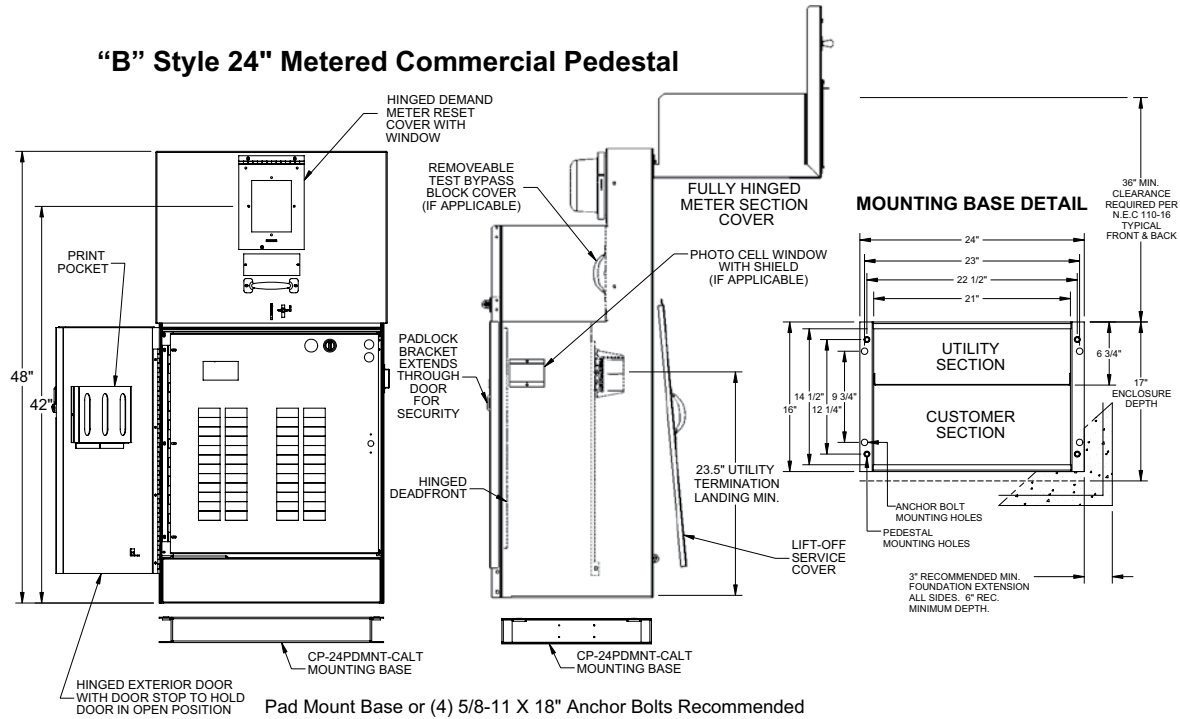

### "M" Style 24" Unmetered Commercial Pedestal

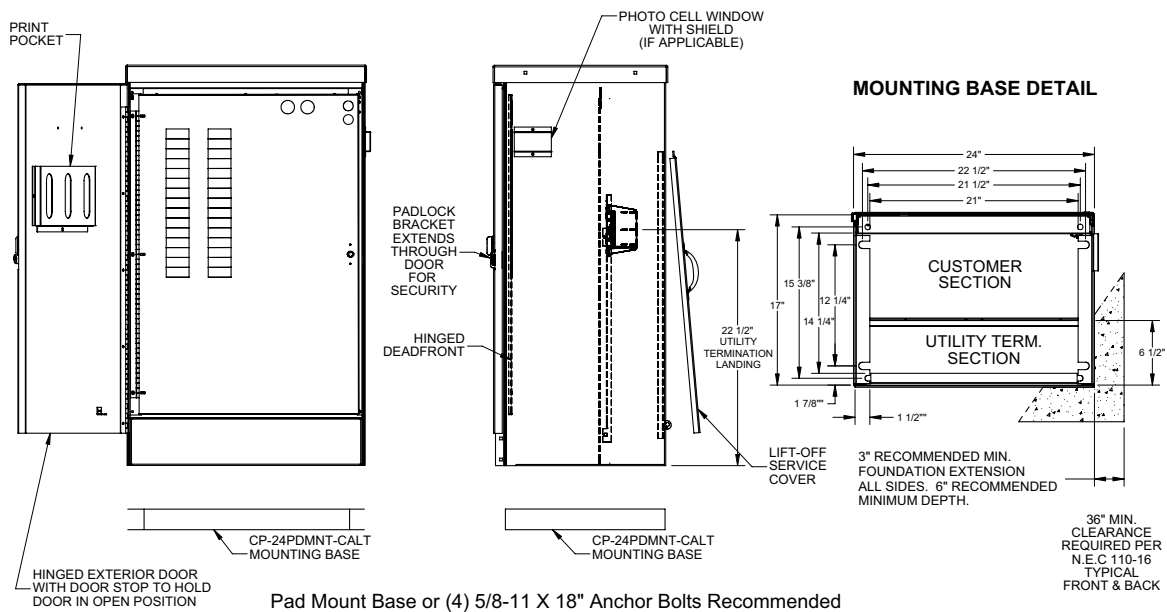

Please consult serving utility for their requirements prior to ordering or installing, as specifications and approvals vary by utility, and may require local electrical inspector approval. All installations must be installed by a licensed electrician and must comply with all national and local codes, laws and regulations. Milbank reserves the right to make changes in specifications and features shown without notice or obligation.



### "K" Style 32" Metered Commercial Pedestal (with one or two meters)

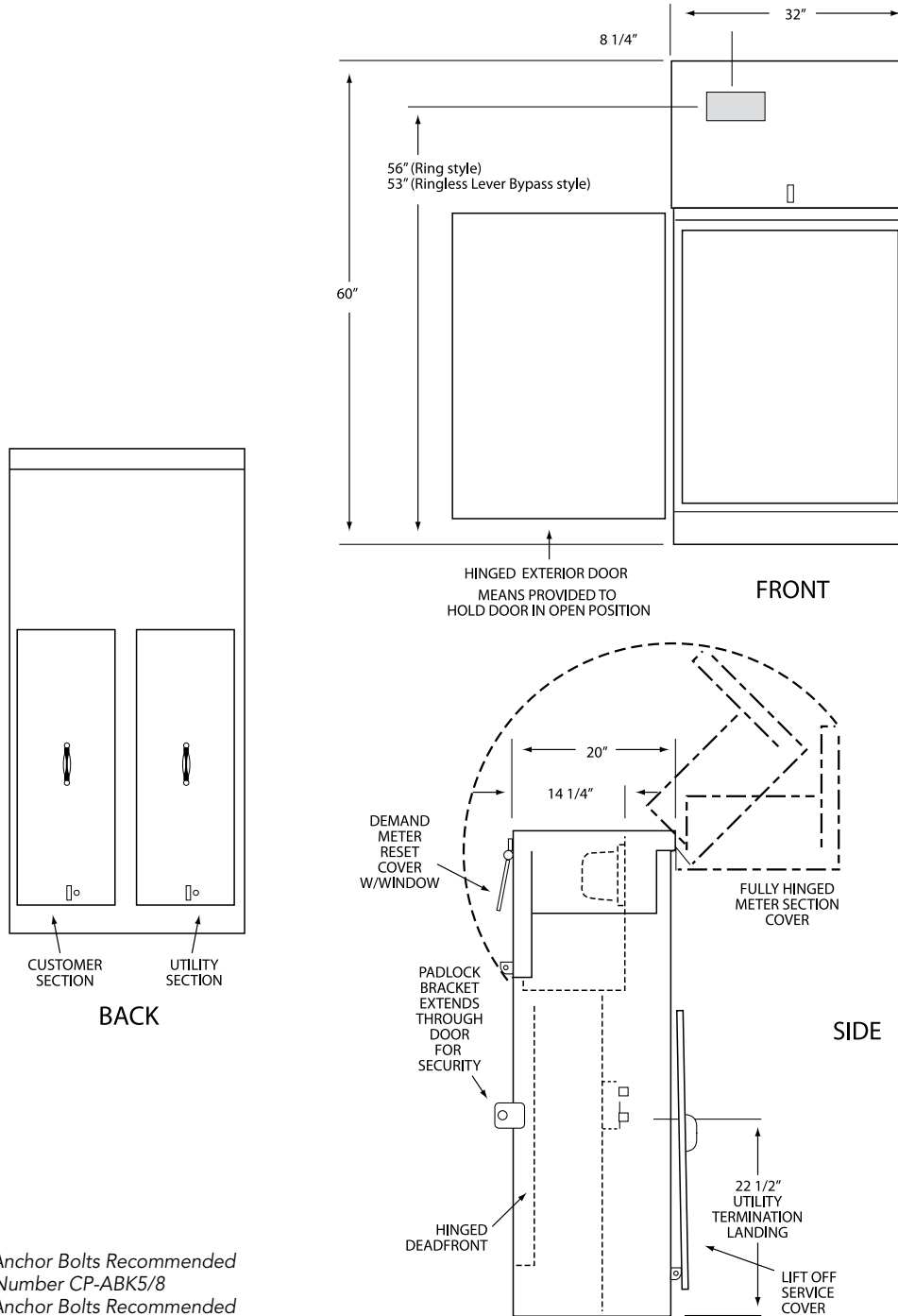

(4) 5/8-11 X 18" Anchor Bolts Recommended  
Catalog Number CP-ABK5/8  
(4) 5/8-11 X 18" Anchor Bolts Recommended



Please consult serving utility for their requirements prior to ordering or installing, as specifications and approvals vary by utility, and may require local electrical inspector approval. All installations must be installed by a licensed electrician and must comply with all national and local codes, laws and regulations. Milbank reserves the right to make changes in specifications and features shown without notice or obligation.

# Commercial Pedestals

## 32" Unmetered Drawings

**107**  
COMMERCIAL  
PEDESTALS

### "Q" Style 32" Unmetered Commercial Pedestal

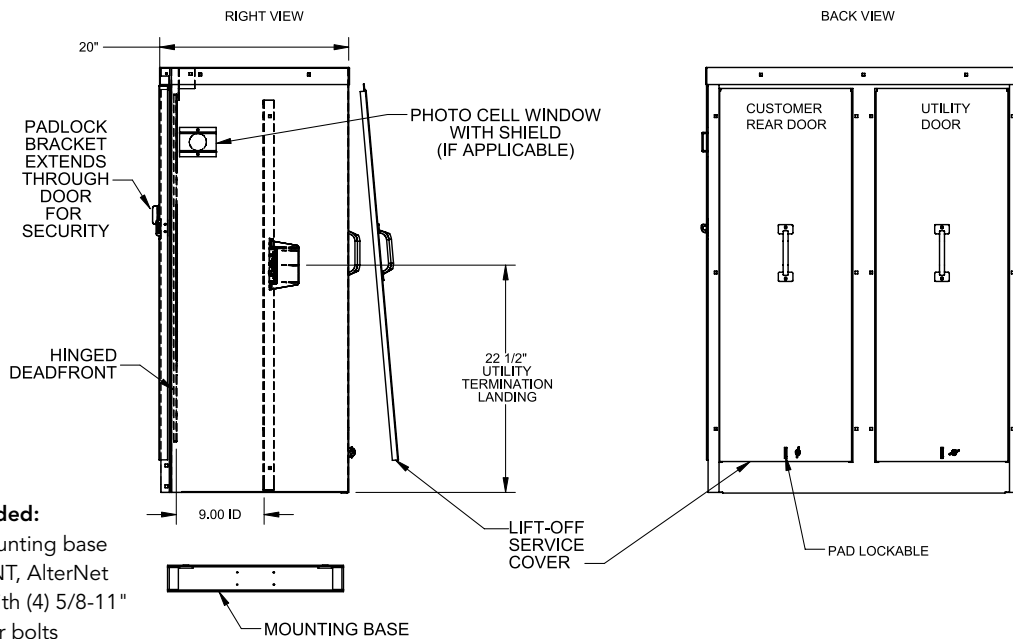
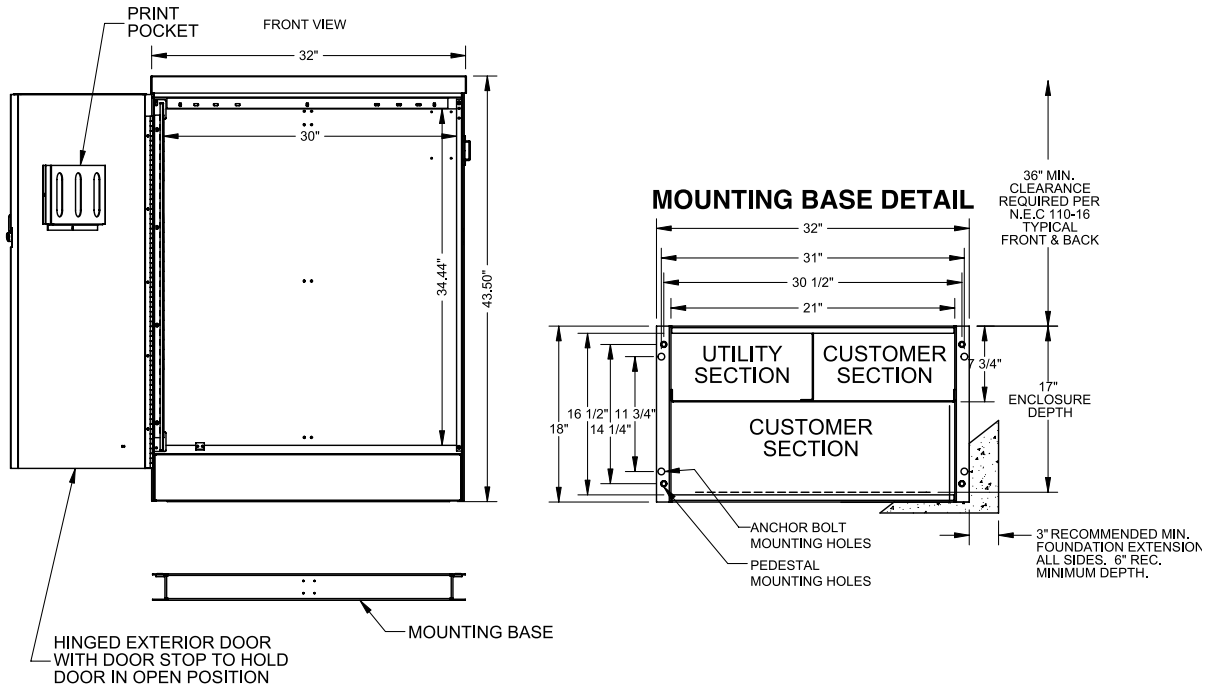

**Recommended:**  
Milbank mounting base  
CP-32PDMNT, AlterNet  
mounting with (4) 5/8-11"  
x 18" anchor bolts

Please consult serving utility for their requirements prior to ordering or installing, as specifications and approvals vary by utility, and may require local electrical inspector approval. All installations must be installed by a licensed electrician and must comply with all national and local codes, laws and regulations. Milbank reserves the right to make changes in specifications and features shown without notice or obligation.



### "D" Style Metered Commercial Pedestal

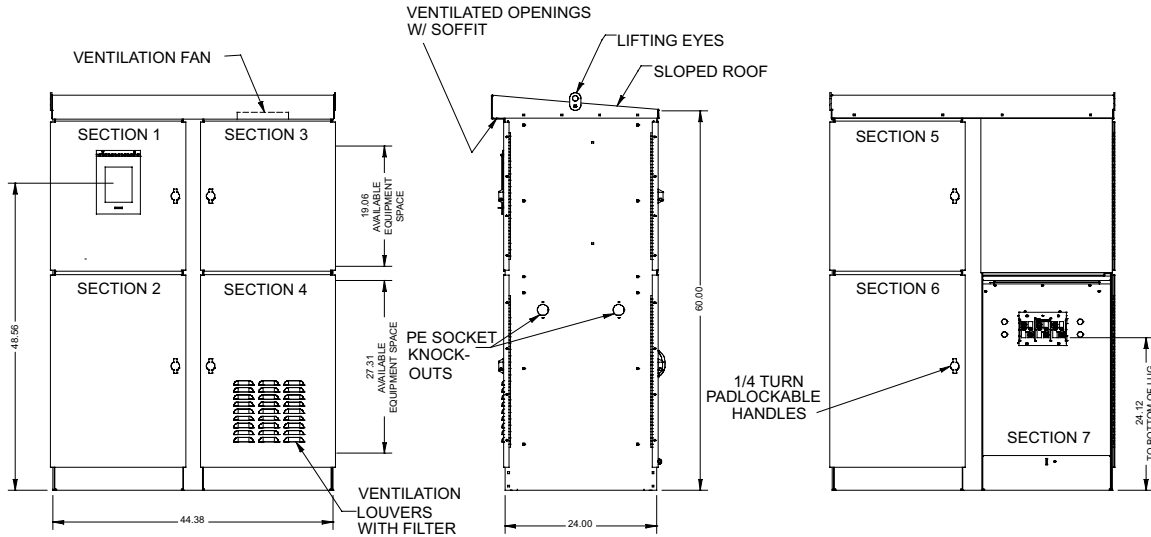

### "C" Style 54" Metered Commercial Pedestal

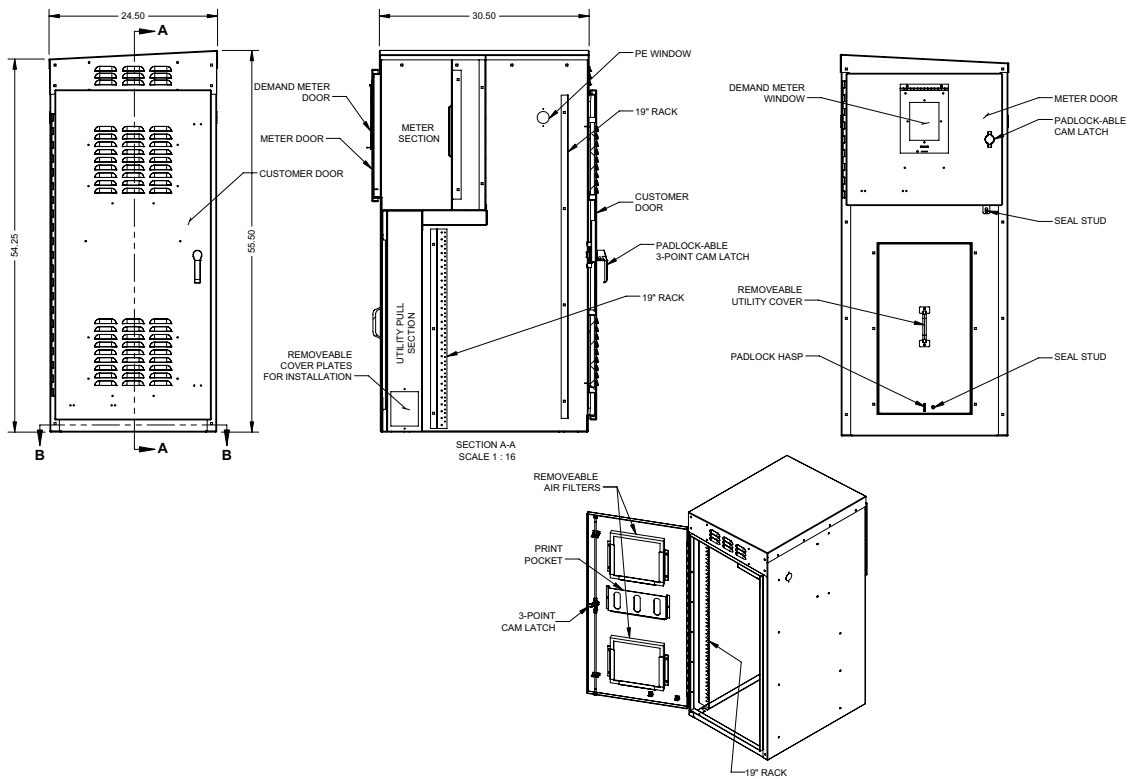

Please consult serving utility for their requirements prior to ordering or installing, as specifications and approvals vary by utility, and may require local electrical inspector approval. All installations must be installed by a licensed electrician and must comply with all national and local codes, laws and regulations. Milbank reserves the right to make changes in specifications and features shown without notice or obligation.

# Commercial Pedestals

## Slimline "A" Style Drawing

109  
COMMERCIAL  
PEDESTALS

### "A" Style Slimline Metered Commercial Pedestal

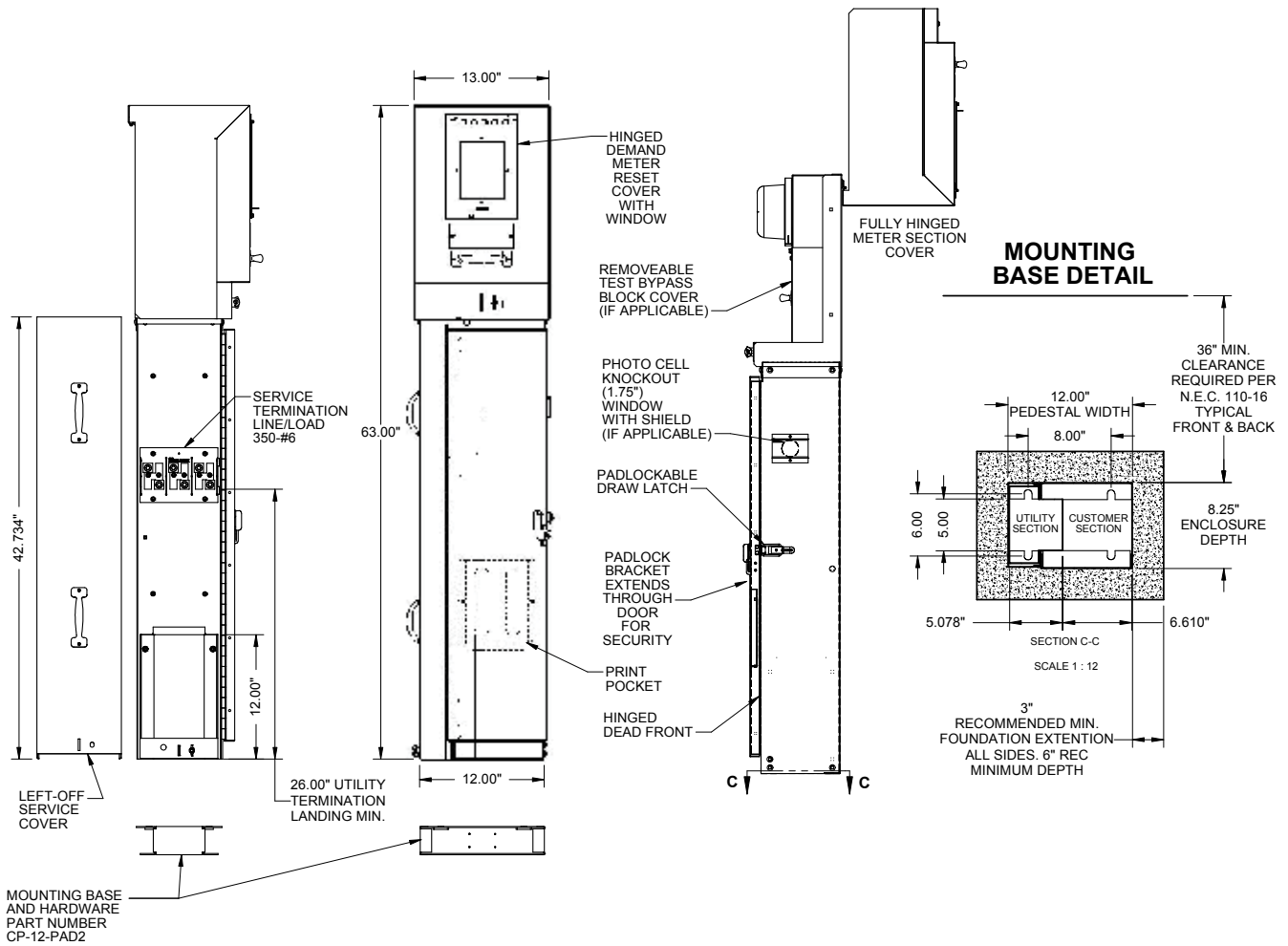

Please consult serving utility for their requirements prior to ordering or installing, as specifications and approvals vary by utility, and may require local electrical inspector approval. All installations must be installed by a licensed electrician and must comply with all national and local codes, laws and regulations. Milbank reserves the right to make changes in specifications and features shown without notice or obligation.



### "B" Style Slimline Metered Commercial Pedestal

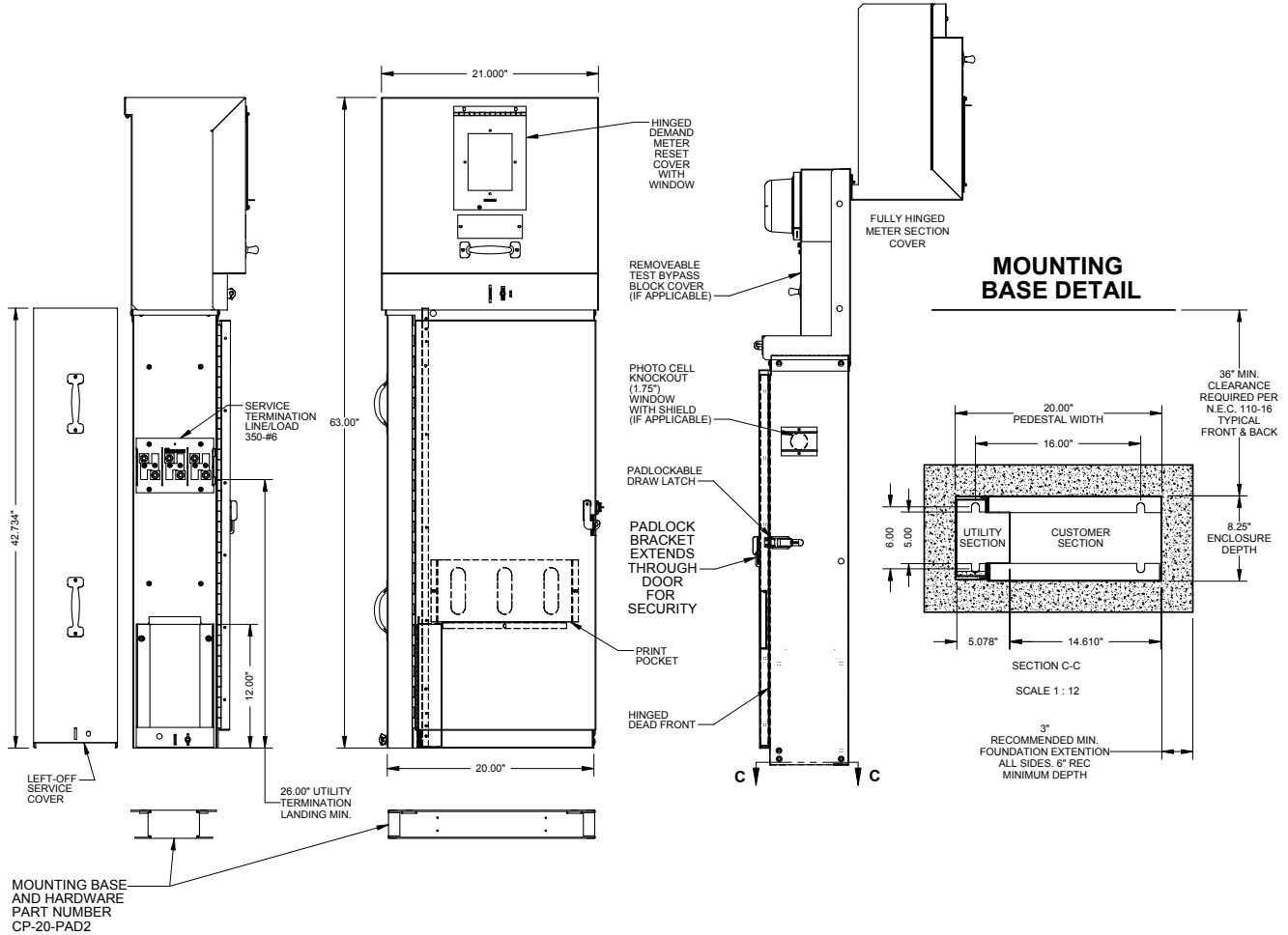

Please consult serving utility for their requirements prior to ordering or installing, as specifications and approvals vary by utility, and may require local electrical inspector approval. All installations must be installed by a licensed electrician and must comply with all national and local codes, laws and regulations. Milbank reserves the right to make changes in specifications and features shown without notice or obligation.

# Commercial Pedestals

## Slimline "I" Style Drawing

111  
COMMERCIAL  
PEDESTALS

### "I" Style Slimline Metered Commercial Pedestal

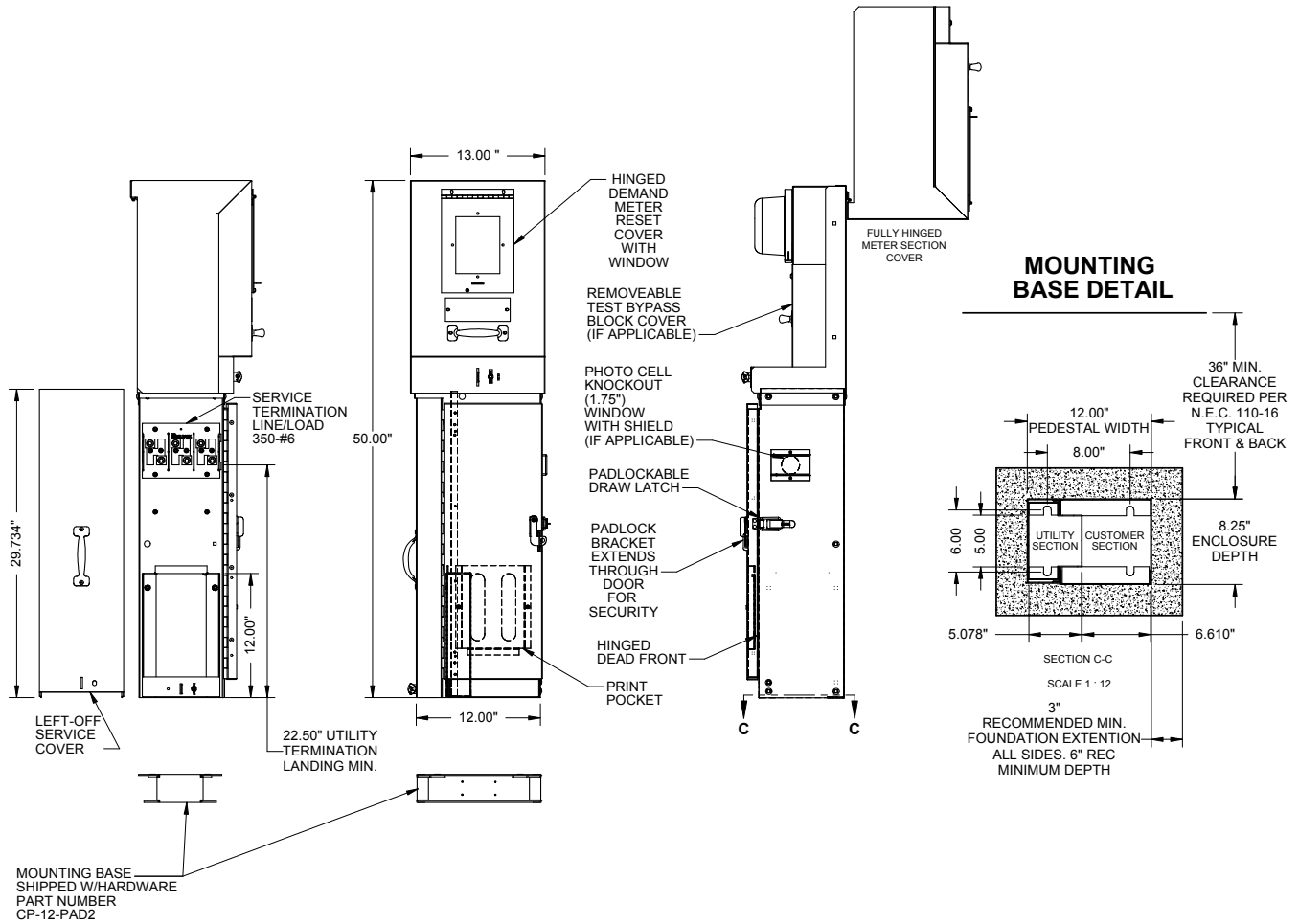

Please consult serving utility for their requirements prior to ordering or installing, as specifications and approvals vary by utility, and may require local electrical inspector approval. All installations must be installed by a licensed electrician and must comply with all national and local codes, laws and regulations. Milbank reserves the right to make changes in specifications and features shown without notice or obligation.



### "J" Style Slimline Metered Commercial Pedestal

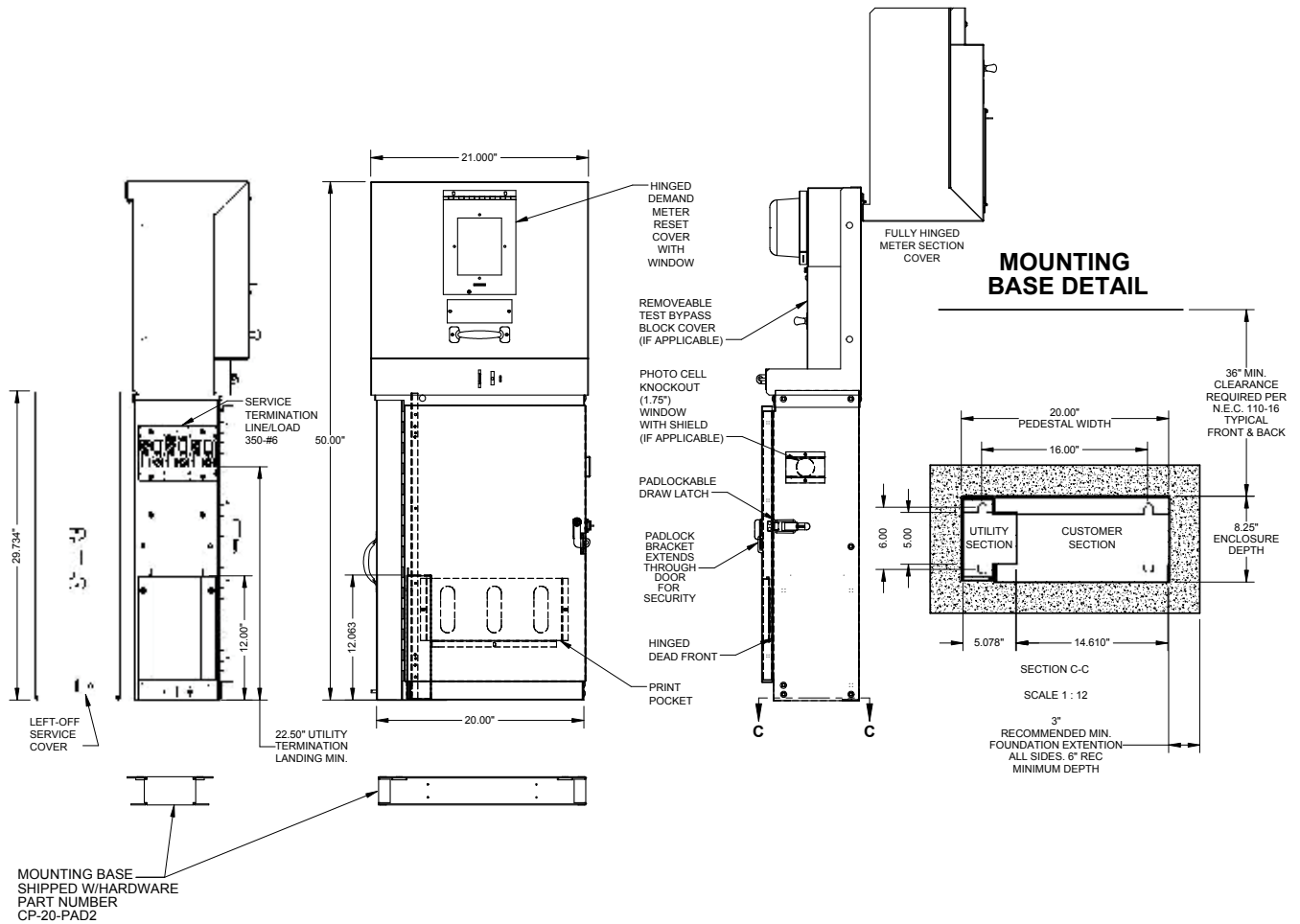

Please consult serving utility for their requirements prior to ordering or installing, as specifications and approvals vary by utility, and may require local electrical inspector approval. All installations must be installed by a licensed electrician and must comply with all national and local codes, laws and regulations. Milbank reserves the right to make changes in specifications and features shown without notice or obligation.



# Commercial Pedestals

## Product Worksheet

Please answer all of the questions listed below. Any additional information regarding application and/or future requirements will enable Milbank to configure the best product for your project.

Distributor: \_\_\_\_\_ Phone: \_\_\_\_\_ Fax: \_\_\_\_\_

Contact Name: \_\_\_\_\_ Application: \_\_\_\_\_

Milbank Representative: \_\_\_\_\_ Salesmen: \_\_\_\_\_

Project Name & Location: \_\_\_\_\_

Agency Specifications: (DOT-City-Other) \_\_\_\_\_

Unit amperage: \_\_\_\_\_ Voltage: \_\_\_\_\_ Phase: \_\_\_\_\_ Wire: \_\_\_\_\_

Meter socket (200 Amp) RING-TYPE RINGLESS Fifth Terminal? NO YES (at \_\_\_\_\_ o'clock)

Meter socket (200 Amp) RING-TYPE RINGLESS Fifth Terminal? NO YES (at \_\_\_\_\_ o'clock)

Main breaker requirements: Amp: \_\_\_\_\_ Poles: \_\_\_\_\_ KAIC: \_\_\_\_\_

Main breaker requirements: Amp: \_\_\_\_\_ Poles: \_\_\_\_\_ KAIC: \_\_\_\_\_

Interior #1 0-42 circuits \_\_\_\_\_ Load center \_\_\_\_\_ Panel board \_\_\_\_\_ Metered? YES NO

Interior #2 0-42 circuits \_\_\_\_\_ Load center \_\_\_\_\_ Panel board \_\_\_\_\_ Metered? YES NO

**Branch breakers:** Amp: \_\_\_\_\_ Poles: \_\_\_\_\_ KAIC: \_\_\_\_\_ Label & Special Requirements: \_\_\_\_\_

Qty \_\_\_\_\_ Breakers \_\_\_\_\_

Qty \_\_\_\_\_ Breakers \_\_\_\_\_

Qty \_\_\_\_\_ Breakers \_\_\_\_\_

Qty \_\_\_\_\_ Breakers \_\_\_\_\_

Qty \_\_\_\_\_ Breakers \_\_\_\_\_

Qty \_\_\_\_\_ Breakers \_\_\_\_\_

### Controls:

Qty \_\_\_\_\_ Time Clock: 24 Hr \_\_\_\_\_ 7 Day \_\_\_\_\_ 365 Day Astro \_\_\_\_\_ Description: \_\_\_\_\_

Qty \_\_\_\_\_ Photo Electric Control Receptacle

Qty \_\_\_\_\_ Test switch: 2 Pos. \_\_\_\_\_ 3 Pos. \_\_\_\_\_ HOA Type \_\_\_\_\_ Other \_\_\_\_\_

Qty \_\_\_\_\_ Control Transformer \_\_\_\_\_ Voltage \_\_\_\_\_ VA Size (required for all 277/480v)

### Contractors:

Type: Lighting - LT/Definite Purpose - DP/Mechanical Held - MH/Mercury - MV/IEC - IC

Qty \_\_\_\_\_ Type \_\_\_\_\_ Amp \_\_\_\_\_ Poles \_\_\_\_\_ Coil voltage \_\_\_\_\_ Other \_\_\_\_\_

Qty \_\_\_\_\_ Type \_\_\_\_\_ Amp \_\_\_\_\_ Poles \_\_\_\_\_ Coil voltage \_\_\_\_\_ Other \_\_\_\_\_

Qty \_\_\_\_\_ Type \_\_\_\_\_ Amp \_\_\_\_\_ Poles \_\_\_\_\_ Coil voltage \_\_\_\_\_ Other \_\_\_\_\_

**Cabinet/Finish requirements:** Alum - Untreated = AO/Alum Anodized = AL/Stainless Steel = SS

Aluminum - Painted = A / GALVANIZED STEEL PAINTED (standard) \_\_\_\_\_ (specify paint below):

MINT GREEN (standard) = G / PINE GREEN = PG / Dark Green = DG / Black = BK / Desert Tan = DT

White = W / Gray = P / Summerland Gray = SG / Other: (RAL finish number) \_\_\_\_\_

Other Requirements: \_\_\_\_\_

*Please send any drawings, plans, specifications, and load/panel board schedules with worksheet.*

Please consult serving utility for their requirements prior to ordering or installing, as specifications and approvals vary by utility, and may require local electrical inspector approval. All installations must be installed by a licensed electrician and must comply with all national and local codes, laws and regulations. Milbank reserves the right to make changes in specifications and features shown without notice or obligation.



## NEMA Commercial Enclosures

Milbank's line of commercial enclosures includes the full gamut of styles and sizes; everything from junction boxes to transformer cabinets, telephone cabinets to wireway.

### Type 1 Enclosures

Milbank's Type 1 enclosures are designed for indoor use to provide a degree of protection to personnel against access to hazardous parts and to provide a degree of protection of the equipment inside the enclosure against ingress of solid foreign objects, such as falling dirt.

### Type 3R Enclosures

Milbank's Type 3R enclosures are designed for either indoor or outdoor use to provide a degree of protection from harmful effects on the equipment due to the ingress of water (rain, sleet, snow) and that will be undamaged by the external formation of ice on the enclosure.

### Wireway

Milbank's wide range of wireway is available in many styles and sizes and its wide range of fittings allows it to smoothly transition to and from competitors' products.

## NEMA Industrial Enclosures

Milbank's line of industrial enclosures include junction boxes, wiring trough, push-button enclosures and modular enclosures. Milbank also excels in special designs; nearly any type, size or color of enclosure you need, we can make!

### Type 12 Enclosures

Enclosures constructed without knockouts for indoor use to provide a degree of protection to personnel against access to hazardous parts, and protect components against falling dirt, circulating dust and lint, and dripping or splashing water.

### Type 4 Enclosures

Enclosures constructed for either indoor or outdoor use to provide a degree of protection to personnel against access to hazardous parts; protect equipment against falling dirt and windblown dust; protect against rain, sleet, snow, splashing water, and hose directed water; and is resistant to damage by the external formation of ice on the enclosure.

### Industrial Enclosure Specials

Milbank specializes in custom enclosure projects, offering an almost limitless amount of styles, options, colors and sizes. Milbank will meet your needs and specifications and deliver a custom enclosure that protects your crucial electric equipment.

### Thermal Management

Protect components housed in enclosures from damage caused by overheating, freezing, humidity and condensation with these thermal management products.



Please consult serving utility for their requirements prior to ordering or installing, as specifications and approvals vary by utility, and may require local electrical inspector approval. All installations must be installed by a licensed electrician and must comply with all national and local codes, laws and regulations. Milbank reserves the right to make changes in specifications and features shown without notice or obligation.

# Accessories

## Hubs and Closing Plates

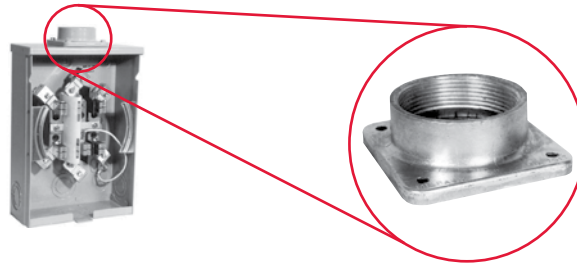
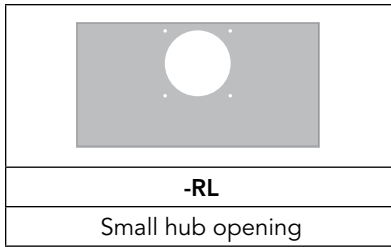

|                           |                           |                           |                           |                           |                           |
|---------------------------|---------------------------|---------------------------|---------------------------|---------------------------|---------------------------|
|                           |                           |                           |                           |                           |                           |
| <b>-WL</b>   <b>A7514</b> | <b>-YL</b>   <b>A7515</b> | <b>-ZL</b>   <b>A7516</b> | <b>-DL</b>   <b>A7517</b> | <b>-EL</b>   <b>A7518</b> | <b>-XL</b>   <b>A7551</b> |
| 1" hub                    | 1¼" hub                   | 1½" hub                   | 2" hub                    | 2½" hub                   | Small closing plate       |

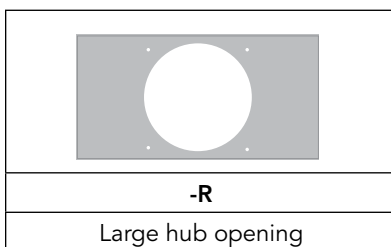

|                          |                          |                          |                          |  |
|--------------------------|--------------------------|--------------------------|--------------------------|--|
|                          |                          |                          |                          |  |
| <b>-F</b>   <b>A8110</b> | <b>-G</b>   <b>A8111</b> | <b>-H</b>   <b>A8112</b> | <b>-X</b>   <b>A9064</b> | <b>-RRL</b>   <b>S8324</b>                     |
| 3" hub                   | 3½" hub                  | 4" hub                   | Large closing plate      | Large hub opening adapted to small hub opening |

### Notes



- **Suffix:** Add to catalog number for factory installation of hub.
- **Packaging:** Individually packed units for field installation.
- **Abbreviations:** H.O. (hub opening), C.P. (closing plate).

Please consult serving utility for their requirements prior to ordering or installing, as specifications and approvals vary by utility, and may require local electrical inspector approval. All installations must be installed by a licensed electrician and must comply with all national and local codes, laws and regulations. Milbank reserves the right to make changes in specifications and features shown without notice or obligation.



## Connector Kits, Closing Kits & Generator Interlock

### Connector Kits — For Use with 3/8"-16 Stud Type Units Only

|  |        |                                     |  |        |                      |
|---|--------|-------------------------------------|---|--------|----------------------|
| Single  |        |                                     | Twin  |        |                      |
| Suffix  | Part # | (3 per set) - 1Ø                    | Suffix  | Part # | (3 per set) - 1Ø     |
| K1  | K1539  | 6-350                               | K2  | K1350  | 6-350                |
| K3  | K1540  | 4-600 or (2) 1/0-250                | K2L   | K1350L | 6-350 (non rotating) |
| K3L   | K1540L | 4-600 or (2) 1/0-250 (non rotating) | K4  | K1541  | 4-600                |
| Suffix  | Part # | (4 per set) - 3Ø                    | Suffix  | Part # | (4 per set) - 3Ø     |
| K5  | K3082  | 6-350                               | K6  | K3442  | 6-350                |
| K7  | K3441  | 4-600 or (2) 1/0-250                | K8  | K3083  | 4-600                |

### Bypass Link



### Closing Covers

|  |  |
|--|--|
|  |  |
| Meter Closing Plate (Ring Type/Ringless)   | Metal Closing Plate (For Ringless Sockets)   |
| 6003 - Gray Plastic  | CP-21  |
| 6116 - Clear Plastic   |  |

### Generator Interlock

|   |
|---|
|  |
| K5815 - large QN with small frame Q   |
| K5820 - large frame QN with large frame QN  |
| K5830 - small frame Q to small frame Q  |

### Disconnect Sleeve



### Anti-Inversion Clip





### Isolated Neutral Kit



# Accessories

## Fifth Terminal, Tap Connectors & Block Assemblies

### Fifth Terminal

|   |   |  |
|---|---|--|
|  |  |  |
| <b>5T8K2</b> - 100-200 Amp "Plug-In"  | <b>K5T</b> - 200 Amp (Block with Square Hole)                                     | <b>K3865</b> - Heavy Duty Jaw Clamping ( <b>K3866</b> without Neutral Wire)        |

### Tap Connectors (3 per set)

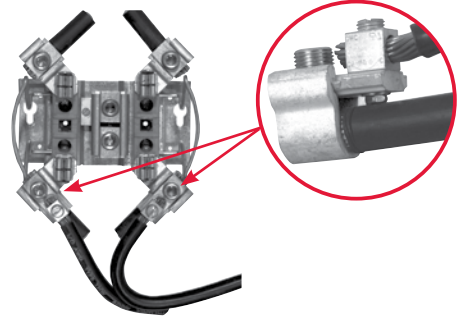
|  |  |
|--|--|
|  | Replaces the load or line side slide-in nut assembly on Milbank 200 amp sockets. Allows for a 100 amp tap location in addition to the #6-350 kcmil load-side connector. <b>K5022</b> includes safety barrier extensions for applications over 300 VAC. Three lugs per kit. |
| <b>K4977-INT</b> - Internal Hex  |  |
| <b>K4977-EXT</b> - External Hex  |  |
| <b>K5022-INT</b> - Internal Hex (set of 4 with barrier)                            |  |

### Triplex Ground

|  |
|--|
|       |
| <b>K1190</b><br>(For factory installed triplex ground, add suffix -TG to catalog number) |

### 100 Amp Blocks *(single sockets only)*

|   |
|---|
|  |
| <b>BL7474</b> - Block Assembly  |
| <b>BL7499</b> - Horn Bypass Block Assembly  |
| <b>Z904486-AO</b> - Nut Assembly  |
| <b>Z90327486-AO</b> - Horn Bypass Nut Assembly                                      |
| <b>Z802965-AC</b> - Neutral without Nut   |
| <b>Z901925-AC</b> - Hex Nut Set Screw   |

### 200 Amp Blocks *(single sockets only)*

|  |
|--|
|  |
| <b>K4527</b> - Internal Hex Block Assembly (with meter support)                      |
| <b>K4528</b> - External Hex Block Assembly (with meter support)                      |
| <b>K4529</b> - Internal Hex Horn Bypass Block Assembly (with meter support)          |
| <b>K4530</b> - External Hex Horn Bypass Block Assembly (with meter support)          |
| <b>Z916265-AO</b> - Internal Nut Assembly  |
| <b>Z916264-AO</b> - External Nut Assembly  |
| <b>Z814898-AC</b> - Neutral without Nut  |

Please consult serving utility for their requirements prior to ordering or installing, as specifications and approvals vary by utility, and may require local electrical inspector approval. All installations must be installed by a licensed electrician and must comply with all national and local codes, laws and regulations. Milbank reserves the right to make changes in specifications and features shown without notice or obligation.



## UQFP Plug-In Series Circuit Breakers



UQFP



UQFP-M

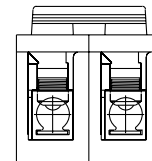
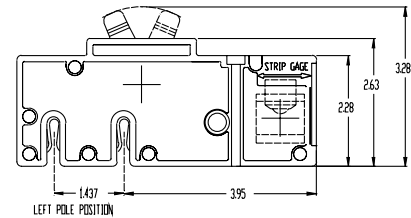
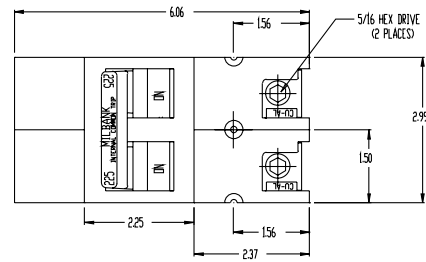

200 Amp Frame | Plug-In | 10K AIC & 22K AIC | Two-Pole | Common Trip

| Amp | 10K AIC Plug-In | 22K AIC Plug-In | 10K AIC Plug-In | 22K AIC Plug-In | Connectors CU/AL |         |
|-----|-----------------|-----------------|-----------------|-----------------|------------------|---------|
|     |                 |                 |                 |                 | Line             | Load    |
| 100 | UQFP-100        | UQFPH-100       | UQFP-M-100      | UQFPH-M-100     | #3-#1            | #1-1/0  |
| 125 | UQFP-125        | UQFPH-125       | UQFP-M-125      | UQFPH-M-125     | #3-#1            | #1-1/0  |
| 150 | UQFP-150        | UQFPH-150       | UQFP-M-150      | UQFPH-M-150     | 1/0-300          | 2/0-300 |
| 200 | UQFP-200        | UQFPH-200       | UQFP-M-200      | UQFPH-M-200     | 1/0-300          | 2/0-300 |

### Notes

- **UL listed:** For use with 60°C or 75°C wire.
- **UQFP:** For parallel main circuit breaker applications.
- **UQFP-M:** For series main circuit breaker applications. Split load tab features allow for feed through capability.
- **Standard Packaging:** 5 units per 16 lb. carton.



Please consult serving utility for their requirements prior to ordering or installing, as specifications and approvals vary by utility, and may require local electrical inspector approval. All installations must be installed by a licensed electrician and must comply with all national and local codes, laws and regulations. Milbank reserves the right to make changes in specifications and features shown without notice or obligation.

# Accessories

## UQFB Plug-In Series Circuit Breakers



UQFB-X1



UQFB-X



UQFB



UQFB-X-MOD

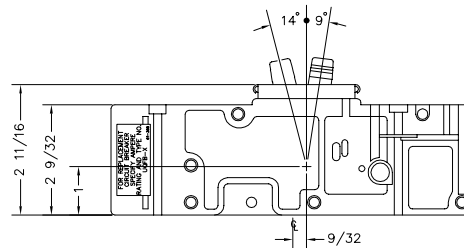
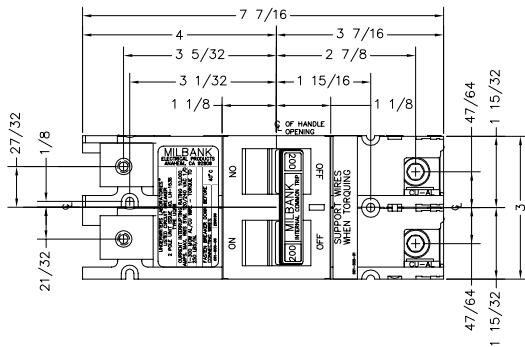

### 200 Amp Frame | Bolt-On | 10K AIC & 22K AIC | Two-Pole | Common Trip

| Amp | 10K AIC Bolt-On | 22K AIC Bolt-On | 10K AIC Bolt-On | Connectors CU/AL |         |
|-----|-----------------|-----------------|-----------------|------------------|---------|
|     |                 |                 |                 | Line             | Load    |
| 100 | UQFB-100        | UQFBH-100       | UQFB-100-X1     | #3-#1            | #1-1/0  |
| 125 | UQFB-125        | UQFBH-125       | UQFB-125-X1     | #3-#1            | #1-1/0  |
| 150 | UQFB-150        | UQFBH-150       | UQFB-150-X1     | 1/0-300          | 2/0-300 |
| 175 | UQFB-175        | UQFBH-175       | UQFB-175-X1     | 1/0-300          | 2/0-300 |
| 200 | UQFB-200        | UQFBH-200       | UQFB-200-X1     | 1/0-300          | 2/0-300 |

### Notes

- **UL listed:** For use with 60°C or 75°C wire.
- **UQFB:** (2) 1/0-300 kcmil lugs provided on load and line side (cable-in, cable-out).
- **UQFB3:** Three pole available. Consult factory.
- **UQFB-X:** (2) 1/0-300 kcmil lugs provided on load side and (2) line bar bus connections on line side.
- **UQFB-M:** For series main circuit breaker applications. Split load tab features allow for feed through capability.
- **UQFB-X-MOD:** Replacement circuit breaker with line barriers removed.
- **Standard Packaging:** 5 units per 16 lb. carton.

Please consult serving utility for their requirements prior to ordering or installing, as specifications and approvals vary by utility, and may require local electrical inspector approval. All installations must be installed by a licensed electrician and must comply with all national and local codes, laws and regulations. Milbank reserves the right to make changes in specifications and features shown without notice or obligation.



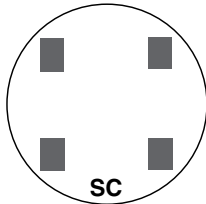

**SC**  
2 and 3-WIRE FORMS  
1S & 2S

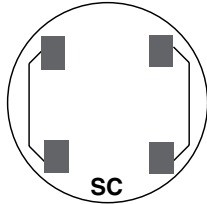

**SC**  
2 and 3-WIRE FORMS  
1S & 2S with BYPASS

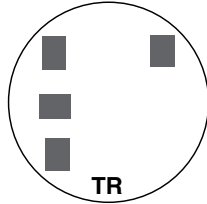

**TR**  
2-WIRE FORM 3S  
5th Term. 9 o'clock

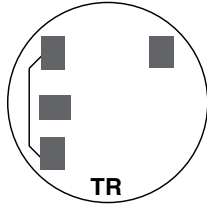

**TR**  
2-WIRE FORM 3S  
with BYPASS

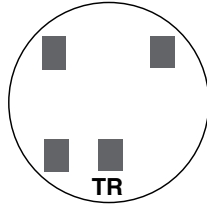

**TR**  
2-WIRE FORM 3S  
5th Term. 6 o'clock

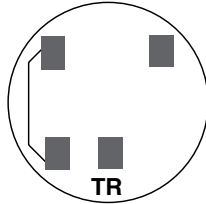

**TR**  
2-WIRE FORM 3S  
with BYPASS

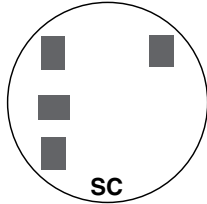

**SC**  
2 ELEMENT  
3-WIRE NETWORK  
FORM 12S 5th  
TERM. 9 o'clock

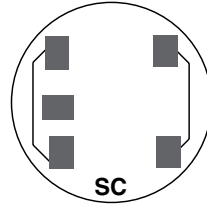

**SC**  
2 ELEMENT 3-WIRE  
NETWORK FORM 12S  
with BYPASS  
5th Term. 9 o'clock

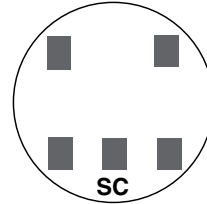

**SC**  
2 ELEMENT  
3-WIRE NETWORK  
FORM 12S 5th  
TERM. 6 o'clock

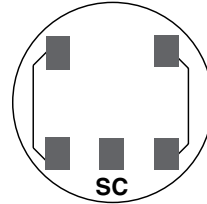

**SC**  
2 ELEMENT 3-WIRE  
NETWORK FORM 12S  
with BYPASS  
5th Term. 6 o'clock

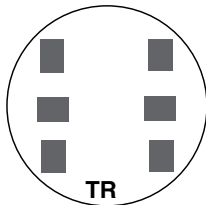

**TR**  
3-WIRE FORM 4S

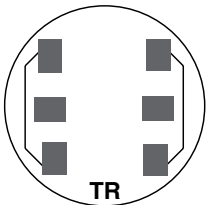

**TR**  
3-WIRE FORM 4S  
WITH BYPASS

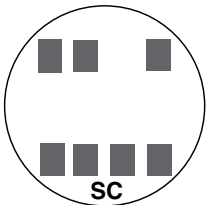

**SC**  
2 or 3 ELEMENT  
3Ø4W Y or  
Y FORM 14S  
FORM 15S  
Y FORM 16S

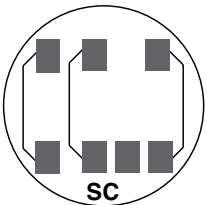

**SC**  
2 or 3 ELEMENT  
3Ø4W Y or  
FORMS 14S & 15S  
with BYPASS

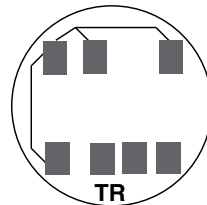

**TR**  
2 ELEMENT  
3Ø4W Y or  
Y FORM 7S  
FORM 24S  
with BYPASS

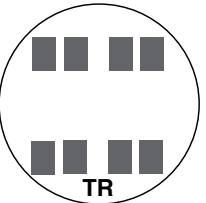

**TR**  
2 ELEMENT  
2Ø3W, 2Ø4W, 3Ø3W  
FORM 5S

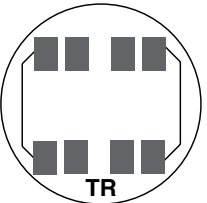

**TR**  
2 ELEMENT Ø3W,  
2Ø4W, 3Ø3W  
FORM 5S with  
BYPASS

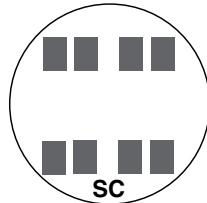

**SC**  
2 ELEMENT  
2Ø3W, 2Ø4W, 3Ø3W  
FORM 13S

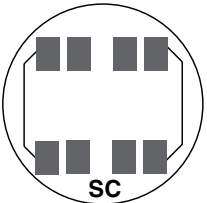

**SC**  
2 or 3 ELEMENT  
2Ø3W, 2Ø4W, 3Ø3W  
FORM 13S with  
BYPASS

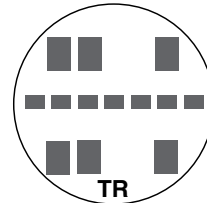

**TR**  
2 or 3 ELEMENT  
3Ø4W Y or  
Y FORM 9S  
FORM 8S

TR = TRANSFORMER RATED  
SC = SELF CONTAINED

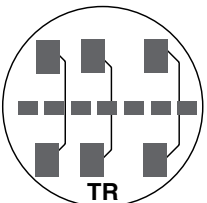

**TR**  
2 or 3 ELEMENT  
3Ø4W Y or  
FORMS 8S & 9S  
FORMS 8S & 9S  
with BYPASS

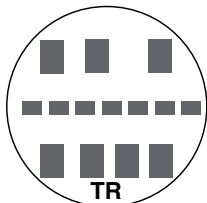

**TR**  
2 ELEMENT  
3Ø4W Y  
FORM 6S

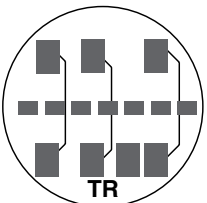

**TR**  
2 ELEMENT  
3Ø4W Y  
FORM 6S  
with BYPASS



# Meter Forms

## Reference Information

**DIAGRAM A**  
1Ø2W with 1 P.T. & 1 C.T.  
Single Stator Meter (2W1Ø) - Form 3S  
5T Socket, Test Switch #TS04-0101

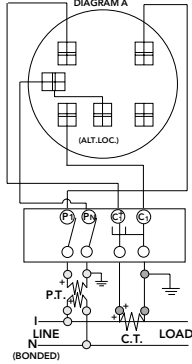

**DIAGRAM B**  
1Ø3W with 1 C.T.  
Single Stator Meter (2W1Ø) - Form 3S  
5T Socket, Test Switch #TS04-0101

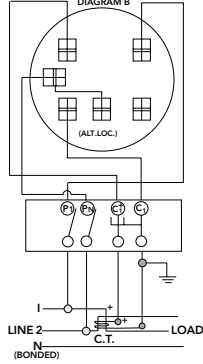

**DIAGRAM C**  
1Ø3W with 2 C.T.'s  
Single Stator Meter (3W1Ø) - Form 4S  
6T Socket, Test Switch #TS07-0105

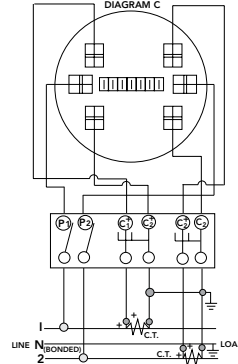

**DIAGRAM D**  
1Ø3W or 3W Network with 2 C.T.'s  
2 Stator Meter - Form 5S  
8T Socket, Test Switch #TS07-0105

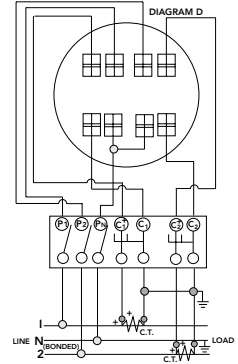

**DIAGRAM E**  
3Ø3W "A" with 2 P.T.'s & 2 C.T.'s  
2 Stator Meter - Form 5S  
8T Socket, Test Switch #TS07-0105

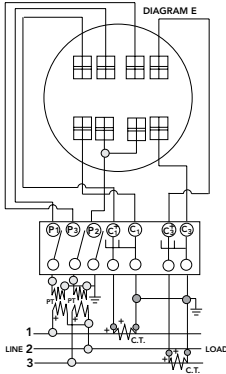

**DIAGRAM F**  
3Ø3W "A" with 2 C.T.'s  
2 Stator Meter - Form 5S  
8T Socket, Test Switch #TS07-0105

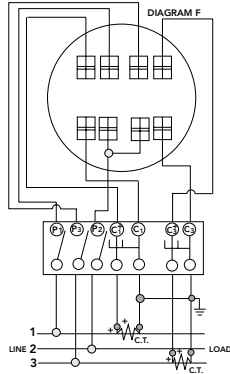

**DIAGRAM G**  
3Ø4W "Y" with 3 C.T.'s  
2 1/2 Stator Meter - Form 6S  
13T Socket, Test Switch #TS10-0109

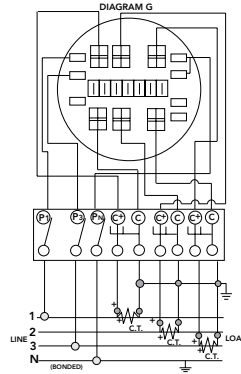

**DIAGRAM H**  
3Ø4W "Y" with 2 P.T.'s & 3 C.T.'s  
2 1/2 Stator Meter - Form 6S  
13T Socket, Test Switch #TS10-0109

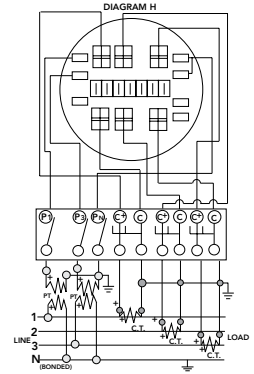

**DIAGRAM I**  
3Ø4W "Y" or "A" with 3 C.T.'s  
"Y" 3 Stator Meter - Form 9S  
"A" 2 Stator Meter - Form 8S  
13T Socket, Test Switch #TS10-0109

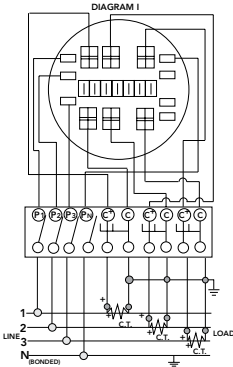

**DIAGRAM J**  
3Ø4W "Y" with 3 P.T.'s & 3 C.T.'s  
3 Stator Meter - Form 9S  
13T Socket, Test Switch #TS10-0109

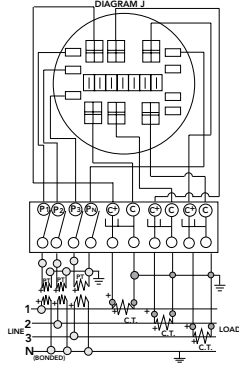

**Prewiring:** If standard factory prewiring is required, refer to wiring diagrams on this page. Determine appropriate diagram and send a copy with order. If custom factory prewiring is required, specify on order. Be sure to include meter socket catalog number, test switch make and catalog number, meter form number and provide a copy of your wiring diagram.

Please consult serving utility for their requirements prior to ordering or installing, as specifications and approvals vary by utility, and may require local electrical inspector approval. All installations must be installed by a licensed electrician and must comply with all national and local codes, laws and regulations. Milbank reserves the right to make changes in specifications and features shown without notice or obligation.



### Important Note

In addition to national and local electrical codes, many utilities have specific requirements for metering equipment. Always consult the serving utility for their specifications and requirements prior to ordering or installing Milbank meter mounting equipment.

### Before Energizing

1. Give equipment a thorough visual examination to determine that:
  - A. No shipping or installation damage exists.
  - B. Proper clearances have been maintained.
  - C. All connections have been made.
  - D. Equipment is clean and dry.
2. Make a thorough examination to:
  - A. Verify tightness of all bolted connections (see table below).
  - B. Manually operate all circuit breakers, switches, relays, etc.
  - C. Check rigidity of all mountings, bus bars and components.
  - D. Use test equipment to check continuity of circuitry and integrity of insulation.
3. All switches and circuit breakers should be in the "off" position.
4. Verify that manual meter bypass (if applicable) is in non-bypass position.
5. Install cover and/or close doors.
6. If installation is not being energized at this time, follow "after-energizing" steps listed below. These steps will secure the installation in case of accidental energization.

### When Energizing

Use caution and follow established safety procedures:

- 1) Wear safety apparel.
- 2) Use safety equipment.
- 3) Take action to prevent injury to yourself and others in the event of failure of the installation.
- 4) Take action to prevent/decrease damage to property in the event of failure of the installation.
- 5) If you are unsure how to safely energize the installation, get someone who is knowledgeable to do it.

### After Energizing

Secure the installation:

- 1) To prevent accidental contact with energized parts, cover all openings with approved filler devices.
- 2) To prevent unauthorized access, secure all covers and/or doors with approved security devices.
- 3) Attach/post information to advise others of potential hazards associated with the installation.

### Recommended Torque for General Applications\*

| Nominal Size | Joint Description |  | Head Type | Torque (Inch Lbs.) |
|--------------|-------------------|--|-----------|--------------------|
|              | Screw             | Nut  |           |                    |
| 10           | Brass             | Brass Nut or Extruded Hole                         | All       | 20-25 inch lbs.    |
| 10           | Steel             | Copper or Aluminum Busbar ≤ 1/8"                   | All       | 25-30 inch lbs.    |
| 10           | Steel             | Steel Nut or Extruded Hole; CU or AL Busbar > 1/8" | All       | 30-35 inch lbs.    |
| 12           | Steel             | Aluminum Extruded Hole                             | All       | 30-35 inch lbs.    |
| 12           | Steel             | Steel Nut or Extruded Hole                         | All       | 40-50 inch lbs.    |
| 1/4          | Steel             | Aluminum Extruded Hole                             | All       | 40-50 inch lbs.    |
| 1/4          | Steel             | Steel Nut or Extruded Hole; CU or AL Busbar        | All       | 50-60 inch lbs.    |
| 5/16         | Steel             | Aluminum Extruded Hole                             | Hex       | 60-70 inch lbs.    |
| 5/16         | Steel             | Steel Nut or Extruded Hole; CU or AL Busbar        | Hex       | 100-150 inch lbs.  |
| 3/8          | Steel             | Steel Nut  | Hex       | 150-200 inch lbs.  |
| 1/2          | Steel             | Steel Nut  | Hex       | 200-250 inch lbs.  |

\* Interior labels typically indicate the required torque for wire connectors and studs, and should be referenced first.  
**CU:** Copper  
**AL:** Aluminum



Please consult serving utility for their requirements prior to ordering or installing, as specifications and approvals vary by utility, and may require local electrical inspector approval. All installations must be installed by a licensed electrician and must comply with all national and local codes, laws and regulations. Milbank reserves the right to make changes in specifications and features shown without notice or obligation.

# Materials & Finishes

## Reference Information

### Materials

#### Steel Quality

---

The meter equipment listed in this catalog is made of galvanized steel (AISI\* G90) to afford the best possible weather proofing.  
\*American Iron and Steel Institute.

#### Steel Sheet

---

16 gauge, galvanized, sheet: 1 1/4 oz./ sq.ft. class zinc-coated. (AISI G90)  
14 gauge, galvanized, sheet: 1 1/4 oz./ sq.ft. class zinc-coated.

#### Aluminum Extrusion

---

Wire-Terminal: Alloy; 6061-T6, Tin-plated for CU/AL wire.  
Bus Bar: Alloy; 6101-O & 6063-O

#### Aluminum Sheet

---

3000 series aluminum sheet, H14, or 5052 series aluminum sheet, H32. Where applicable thicknesses range from .064-.125

#### Copper Sheet & Bus

---

Electrolytic copper with tin plating in most applications.

#### Insulating Materials

---

- In most units, support bases for current-carrying components are molded from fiberglass reinforced high-strength, track resistant, thermoset polyester molding compounds.
- Clear or black safety shields and polarity barriers are molded from high-strength, track resistant, polycarbonate molding compounds.
- Various sheet insulating materials, as appropriate for the application are utilized in the fabrication of flat, formed and punched component parts and barriers.

### Finish

#### Process

---

Light gray state-of-the-art electrostatically applied powder paint offers a durable, non-fading finish. For further information concerning the chemical analysis of the weather resistant finish, please contact the factory.

#### Metal Fasteners

---

Zinc-coated with a chromate dip.

### Ratings & Compliance

#### Ratings & Compliance

---

All Milbank electrical enclosures in this catalog are rated "Type 3R Enclosure" unless specified otherwise on the product's page. All enclosures with a UL designation are constructed per the appropriate UL Standard and may be installed per the National Electric Code. UL procedure files associated with the UL Standards are listed as follows: Meter Sockets (UL 414, File E30202), Test Switches (UL 414, File E62531), Power Outlets (UL 231, File E90945), Panelboards (UL 67, File E32628) and Pullout Switches (UL 1429, File E133062). Additional standards are utilized as applicable: Meter Sockets (ANSI C12.7), Test Switches (ANSI C12.9) and Panelboards (NEMA PB-1).

Please consult serving utility for their requirements prior to ordering or installing, as specifications and approvals vary by utility, and may require local electrical inspector approval. All installations must be installed by a licensed electrician and must comply with all national and local codes, laws and regulations. Milbank reserves the right to make changes in specifications and features shown without notice or obligation.



|                      |     |                      |     |                        |     |
|----------------------|-----|----------------------|-----|------------------------|-----|
| 6003.....            | 116 | BC214.....           | 46  | K3082.....             | 116 |
| 6116.....            | 116 | BC234.....           | 46  | K3083.....             | 116 |
| 020-147-00-00-0..... | 65  | BC318.....           | 46  | K3441.....             | 116 |
| 105J.....            | 103 | BC338.....           | 46  | K3442.....             | 116 |
| 10URMD.....          | 92  | BC418.....           | 46  | K3865.....             | 103 |
| 10URMD24.....        | 92  | BC438.....           | 46  | K3865.....             | 117 |
| 114TB.....           | 31  | BC518.....           | 46  | K3866.....             | 117 |
| 115TB.....           | 31  | BC538.....           | 46  | K4527.....             | 117 |
| 117TB.....           | 31  | BC618.....           | 46  | K4528.....             | 117 |
| 124TB.....           | 31  | BC638.....           | 46  | K4529.....             | 117 |
| 125TB.....           | 31  | BL7474.....          | 117 | K4530.....             | 117 |
| 127TB.....           | 31  | BL7499.....          | 117 | K4709-02.....          | 85  |
| 16URMD.....          | 92  | CL200-D.....         | 87  | K4709-02-3R.....       | 85  |
| 16URMD24.....        | 92  | CP-16PDMNT-CALT..... | 103 | K4722.....             | 60  |
| 20URMD.....          | 92  | CP-21.....           | 116 | K4729.....             | 60  |
| 20URMD24.....        | 92  | CP-24PDMNT-CALT..... | 103 | K4793.....             | 60  |
| 214MTB.....          | 32  | CP-32PDMNT.....      | 103 | K4794.....             | 60  |
| 214MTB/22.....       | 33  | CP3B0181UMWIR02..... | 98  | K4795.....             | 60  |
| 214MTB-48.....       | 34  | CP3B0281UMWIR03..... | 98  | K4796.....             | 60  |
| 214MTB-P.....        | 35  | CP3B0281UMWIR04..... | 98  | K4797.....             | 60  |
| 214MTB-P48.....      | 35  | CP3B11110A22SL1..... | 96  | K4797.....             | 60  |
| 215MTB.....          | 32  | CP3B11115A22.....    | 95  | K4798.....             | 60  |
| 215MTB-48.....       | 34  | CP3B12110A22SL1..... | 96  | K4798.....             | 60  |
| 215MTB-P.....        | 35  | CP3B12119A22.....    | 95  | K4800-D.....           | 87  |
| 215MTB-P48.....      | 35  | CP3B1411jb.....      | 97  | K4802.....             | 116 |
| 217MTB.....          | 32  | CP3B14120b.....      | 97  | K4806-BP.....          | 59  |
| 217MTB/22.....       | 33  | CP3B51110A22SL1..... | 96  | K4903.....             | 60  |
| 217MTB-48.....       | 34  | CP3B51115A22.....    | 95  | K4904.....             | 60  |
| 217MTB-P.....        | 35  | CP3B52110A22SL1..... | 96  | K4977-EXT.....         | 117 |
| 217MTB-P48.....      | 35  | CP3B52119A22.....    | 95  | K4977-INT.....         | 117 |
| 224MTB.....          | 36  | CP3B5411Jb22.....    | 97  | K5022-INT.....         | 117 |
| 224MTB/22.....       | 37  | CP3B54120b22.....    | 97  | K5400-100MBM.....      | 88  |
| 224MTB-48.....       | 38  | CP3B-AUX-1200.....   | 90  | K5400-100MBU.....      | 88  |
| 224MTB-P.....        | 39  | CP-ABK5/8.....       | 103 | K5410.....             | 86  |
| 224MTB-P48.....      | 39  | CP-PE-HOA-3POS.....  | 103 | K5411.....             | 83  |
| 225MTB-P.....        | 39  | CP-PE-TYP5-2POS..... | 103 | K5412.....             | 84  |
| 225MTB-P48.....      | 39  | CP-TC24H.....        | 103 | K5413.....             | 83  |
| 227MTB.....          | 36  | CP-TC7D.....         | 103 | K5415.....             | 86  |
| 227MTB/22.....       | 37  | CP-TCWIRE.....       | 103 | K5421.....             | 86  |
| 227MTB-48.....       | 38  | CT203611-HC.....     | 61  | K5747.....             | 60  |
| 227MTB-P.....        | 39  | CT242411-SC.....     | 61  | K5752.....             | 60  |
| 227MTB-P48.....      | 39  | CT243011-HC.....     | 61  | K5815.....             | 116 |
| 243210-LC3R-SP.....  | 59  | CT243011-SC.....     | 61  | K5820.....             | 116 |
| 25URMD.....          | 92  | CT24329-SC.....      | 61  | K5830.....             | 116 |
| 25URMD24.....        | 92  | CT243611-HC.....     | 61  | K5920-10GR.....        | 82  |
| 323610-LC3R-SP.....  | 59  | CT243611-SC.....     | 61  | K5920-111GR.....       | 82  |
| 363016-CT3R.....     | 59  | CT244811-HC.....     | 61  | K5920-11GR.....        | 82  |
| 363612-CT3R-SP.....  | 59  | CT244811-SC.....     | 61  | K5920-38.....          | 82  |
| 364812-CT3R-SP2..... | 59  | CT303011-SC.....     | 61  | K5920-41.....          | 82  |
| 403456-SC.....       | 67  | CT303611-HC.....     | 61  | K5920-522.....         | 82  |
| 518K2.....           | 117 | CT303611-SC.....     | 61  | K5920-54.....          | 82  |
| 701776-MO.....       | 89  | CT303614-SC.....     | 61  | K5920-58.....          | 82  |
| 703997-MO.....       | 79  | CT304811-HC.....     | 61  | K5920-75.....          | 82  |
| 704995-MO.....       | 79  | CT363611-HC.....     | 61  | K5920-BLANK.....       | 82  |
| 706761-MO.....       | 79  | CT363611-SC.....     | 61  | K5T.....               | 117 |
| 707915-MO.....       | 79  | CT364211-SC.....     | 61  | K6212.....             | 83  |
| 708080-MO.....       | 89  | CT364811-HC.....     | 61  | K6213.....             | 84  |
| 708777-MO.....       | 79  | CT364811-SC.....     | 61  | K8180.....             | 116 |
| 708784-MO.....       | 88  | CT364814-SC.....     | 61  | M400-aps.....          | 27  |
| 708785-MO.....       | 79  | CT424211-SC.....     | 61  | M400-aps-BS.....       | 27  |
| A7514.....           | 115 | CT484811-HC.....     | 61  | M400-PAR-UG.....       | 26  |
| A7515.....           | 115 | CT484811-SC.....     | 61  | M400-UG-APS-F.....     | 28  |
| A7516.....           | 115 | CT484814-HC.....     | 61  | M400-UG-APS-F-BS.....  | 28  |
| A7517.....           | 115 | CT484814-SC.....     | 61  | M400-UG-APS-LC.....    | 28  |
| A7518.....           | 115 | K1047.....           | 116 | M400-UG-APS-LC-BS..... | 28  |
| A7551.....           | 115 | K1190.....           | 117 | M400-UG-APS-P.....     | 28  |
| A8110.....           | 115 | K1350.....           | 116 | M401-UG.....           | 29  |
| A8111.....           | 115 | K1350L.....          | 116 | M401-UG-BS.....        | 29  |
| A8112.....           | 115 | K1539.....           | 116 | M404-UG-LC.....        | 30  |
| A9064.....           | 115 | K1540.....           | 116 | M404-UG-LC-BS.....     | 30  |
| AP2300-03.....       | 10  | K1540L.....          | 116 | M5-144.....            | 116 |
| AP2300-04.....       | 10  | K1541.....           | 116 | MPAP-100-78.....       | 64  |



Please consult serving utility for their requirements prior to ordering or installing, as specifications and approvals vary by utility, and may require local electrical inspector approval. All installations must be installed by a licensed electrician and must comply with all national and local codes, laws and regulations. Milbank reserves the right to make changes in specifications and features shown without notice or obligation.

|                         |     |                     |    |                          |    |
|-------------------------|-----|---------------------|----|--------------------------|----|
| MPAP-100-MB-78.....     | 64  | U214MTB/22.....     | 33 | U3532-X-K1.....          | 49 |
| MPAP-200-20GR-78.....   | 64  | U214MTB-48.....     | 34 | U3533-X-K3.....          | 49 |
| MPAP-200-78.....        | 64  | U214MTBL.....       | 40 | U3534-X-K3.....          | 49 |
| MPAP-200-MB-78.....     | 64  | U214MTB-P.....      | 35 | U3548-X.....             | 21 |
| MPAP-200-MBLC-80.....   | 65  | U214MTB-P48.....    | 35 | U3555-R.....             | 62 |
| MPAP-BLANK-78.....      | 64  | U214MTBPL.....      | 40 | U3565-O.....             | 62 |
| MPAP-BLANK-78R.....     | 64  | U215MTB.....        | 32 | U3574-RL-200.....        | 24 |
| MPAPD-BLANK-78.....     | 64  | U215MTB-P.....      | 35 | U3577-RL-200.....        | 24 |
| MPAPD-BLANK-78R.....    | 64  | U215MTB-P48.....    | 35 | U3584-O-200.....         | 24 |
| MPRV-100-20GR-78.....   | 63  | U217MTB.....        | 32 | U3587-O-200.....         | 24 |
| MPRV-100-78.....        | 63  | U217MTB/22.....     | 33 | U3802.....               | 7  |
| MPRV-100-MB-78.....     | 63  | U217MTB-48.....     | 34 | U3812.....               | 7  |
| MPRV-100-MBLC-80.....   | 65  | U217MTBL.....       | 40 | U3822-20GWR.....         | 8  |
| MPRV-503020GR-78.....   | 63  | U217MTB-P.....      | 35 | U3832.....               | 7  |
| MPRV-50-78.....         | 63  | U217MTB-P48.....    | 35 | U3852-XL.....            | 17 |
| MPRV-BLANK-78.....      | 63  | U217MTBPL.....      | 40 | U3862.....               | 7  |
| MPRV-BLANK-78-R-5T..... | 63  | U224MTB.....        | 36 | U4013-X.....             | 22 |
| MR-2.....               | 89  | U224MTB/22.....     | 37 | U4015-O.....             | 14 |
| MS-24-TB.....           | 44  | U224MTB-48.....     | 38 | U4031-O-2/200.....       | 26 |
| MS-25-TB.....           | 44  | U224MTBL.....       | 40 | U4175-RL-BLG.....        | 11 |
| MS-27-TB.....           | 44  | U224MTB-P.....      | 39 | U4517-DL-M4.....         | 14 |
| PB-011.....             | 45  | U224MTB-P48.....    | 39 | U4518-O-W.....           | 14 |
| PB-012.....             | 45  | U224MTBPL.....      | 40 | U4518-XL-W.....          | 14 |
| PB-014.....             | 45  | U227MTB.....        | 36 | U4540-XL.....            | 91 |
| PB-014-NK.....          | 45  | U227MTB/22.....     | 37 | U4542-XL.....            | 91 |
| PB-018.....             | 45  | U227MTB-48.....     | 38 | U4544-XL.....            | 91 |
| PB-018-NK.....          | 45  | U227MTBL.....       | 40 | U4546-XL.....            | 91 |
| PB-032.....             | 45  | U227MTB-P.....      | 39 | U4548-RXL.....           | 91 |
| PB-034.....             | 45  | U227MTB-P48.....    | 39 | U4549-RXL.....           | 91 |
| PB-034-NK.....          | 45  | U227MTBPL.....      | 40 | U4881-O.....             | 9  |
| PB-038.....             | 45  | U2594-X.....        | 22 | U4881-O-50GB.....        | 9  |
| PF-BL.....              | 67  | U2827-X.....        | 22 | U4881-O-60GB.....        | 9  |
| PF-KR.....              | 67  | U2852-X.....        | 50 | U4909-O-11GR.....        | 75 |
| PT223.....              | 44  | U2853-X.....        | 50 | U5000-XL.....            | 80 |
| PT224.....              | 44  | U2854-X.....        | 50 | U5000-XL-41.....         | 80 |
| PT263.....              | 44  | U2855-X.....        | 50 | U5000-XL-55.....         | 80 |
| PT264.....              | 44  | U2856-X.....        | 50 | U5000-XL-75.....         | 80 |
| PT323.....              | 44  | U2862-X.....        | 50 | U5001-RL-01.....         | 77 |
| PT324.....              | 44  | U2863-X.....        | 50 | U5056-O.....             | 21 |
| PT363.....              | 44  | U2864-X.....        | 50 | U5059-x-2/200.....       | 26 |
| PT364.....              | 44  | U2865-X.....        | 50 | U5100-XL.....            | 80 |
| Q115.....               | 79  | U2866-X.....        | 50 | U5100-XL-41.....         | 80 |
| Q120.....               | 79  | U3251-O-200-CB..... | 28 | U5100-XL-55.....         | 80 |
| Q130.....               | 79  | U3319-R.....        | 62 | U5100-XL-75.....         | 80 |
| Q2100.....              | 79  | U3320-R.....        | 62 | U5136-O.....             | 72 |
| Q220.....               | 79  | U3321-R.....        | 62 | U5136-O-100S.....        | 72 |
| Q250.....               | 79  | U3322-R.....        | 62 | U5136-O-200S.....        | 72 |
| RBK-1.....              | 65  | U3323-R.....        | 62 | U5137-O.....             | 72 |
| S8324.....              | 115 | U3328-RXL.....      | 14 | U5137-O-100S.....        | 72 |
| TB100-47.....           | 44  | U3339-O.....        | 62 | U5137-O-200S.....        | 72 |
| TB100-5.....            | 44  | U3340-O.....        | 62 | U5138-O.....             | 72 |
| TB200-47.....           | 44  | U3341-O.....        | 62 | U5138-O-200S.....        | 72 |
| TB200-5.....            | 44  | U3342-O.....        | 62 | U5139-O.....             | 72 |
| TB200-LL.....           | 44  | U3343-O.....        | 62 | U5168-XTL-100.....       | 25 |
| U1060-RL.....           | 13  | U3412-O.....        | 47 | U5168-XTL-100-KK.....    | 25 |
| U1079-R.....            | 20  | U3413-O.....        | 47 | U5168-XTL-100-KK-5T..... | 25 |
| U1129-O-K3L-K2L.....    | 20  | U3414-O.....        | 47 | U5168-XTL-150.....       | 25 |
| U1211-RXL.....          | 17  | U3415-O.....        | 47 | U5168-XTL-150-KK.....    | 25 |
| U1252-X-K1.....         | 49  | U3416-O.....        | 47 | U5168-XTL-150-KK-5T..... | 25 |
| U1253-X-K3.....         | 49  | U3462-O.....        | 47 | U5168-XTL-200.....       | 25 |
| U1254-X-K3.....         | 49  | U3463-O.....        | 47 | U5168-XTL-200-KK.....    | 25 |
| U1255-X-K4.....         | 49  | U3464-O.....        | 47 | U5169-XTL-100.....       | 25 |
| U1256-X-K4.....         | 49  | U3465-O.....        | 47 | U5169-XTL-150.....       | 25 |
| U1431-R.....            | 20  | U3466-O.....        | 47 | U5169-XTL-200.....       | 25 |
| U1432-O.....            | 20  | U3504-XL.....       | 16 | U5200-XL.....            | 81 |
| U1527-O.....            | 13  | U3507-XL.....       | 16 | U5200-XL-41.....         | 81 |
| U1681-RL.....           | 12  | U3514-XL.....       | 16 | U5200-XL-55.....         | 81 |
| U1797-O-K3L-K2L.....    | 20  | U3517-XL.....       | 16 | U5200-XL-75.....         | 81 |
| U1819-X.....            | 20  | U3522-XL-K1.....    | 48 | U5240-O.....             | 70 |
| U1980-O.....            | 13  | U3523-XL-K1.....    | 48 | U5240-O-100S.....        | 70 |
| U2120-X.....            | 22  | U3524-XL-K2.....    | 48 | U5240-O-200S.....        | 70 |
| U214MTB.....            | 32  | U3525-XL-K2.....    | 48 | U5241-O.....             | 70 |

Please consult serving utility for their requirements prior to ordering or installing, as specifications and approvals vary by utility, and may require local electrical inspector approval. All installations must be installed by a licensed electrician and must comply with all national and local codes, laws and regulations. Milbank reserves the right to make changes in specifications and features shown without notice or obligation.



|                       |    |                        |     |
|-----------------------|----|------------------------|-----|
| U5241-O-100S.....     | 70 | UC3426-XL.....         | 55  |
| U5241-O-200S.....     | 70 | UC3428-XL.....         | 55  |
| U5242-O.....          | 70 | UC3433-XL.....         | 55  |
| U5242-O-200S.....     | 70 | UC3434-XL.....         | 55  |
| U5243-O.....          | 70 | UC3435-XL.....         | 55  |
| U5268-XTL-150.....    | 25 | UC3436-XL.....         | 55  |
| U5268-XTL-150-KK..... | 25 | UC3438-XL.....         | 55  |
| U5268-XTL-200.....    | 25 | UC7233-XL.....         | 54  |
| U5268-XTL-200-KK..... | 25 | UC7235-XL.....         | 54  |
| U5269-XTL-200.....    | 25 | UC7237-XL.....         | 54  |
| U5300-O.....          | 81 | UC7461-YL-TGE-DES..... | 55  |
| U5300-O-41.....       | 81 | UC7544-RL.....         | 54  |
| U5300-O-55.....       | 81 | UC7545-RL.....         | 54  |
| U5300-O-75.....       | 81 | UC7582-RL.....         | 54  |
| U5706-O-200S.....     | 74 | UC7636-YL-TGE-DES..... | 55  |
| U5706-O-200S-KK.....  | 74 | UF4015-KO.....         | 15  |
| U5707-O-200S.....     | 74 | UF4517-KO.....         | 15  |
| U5759-x-2/200.....    | 26 | UF4518-KO.....         | 15  |
| U5865-XL-38GBGRW..... | 78 | UF4969-KO.....         | 15  |
| U5882-X.....          | 52 | UQFB-100.....          | 119 |
| U5883-X.....          | 52 | UQFB-100-X1.....       | 119 |
| U5884-X.....          | 52 | UQFB-125.....          | 119 |
| U5885-X.....          | 52 | UQFB-125-X1.....       | 119 |
| U5886-X.....          | 52 | UQFB-150.....          | 119 |
| U5902-X.....          | 52 | UQFB-150-X1.....       | 119 |
| U5903-X.....          | 52 | UQFB-175.....          | 119 |
| U5904-X.....          | 52 | UQFB-175-X1.....       | 119 |
| U5905-X.....          | 52 | UQFB-200.....          | 119 |
| U5906-X.....          | 52 | UQFB-200-X1.....       | 119 |
| U5929-XL-INS.....     | 11 | UQFBH-100.....         | 119 |
| U5934-XL-BLG.....     | 11 | UQFBH-125.....         | 119 |
| U5971-XL-100.....     | 23 | UQFBH-150.....         | 119 |
| U5971-XL-200.....     | 23 | UQFBH-175.....         | 119 |
| U6087-XL.....         | 11 | UQFBH-200.....         | 119 |
| U6087-XL-INS.....     | 11 | UQFP-100.....          | 118 |
| U6276-O-100.....      | 68 | UQFP-125.....          | 118 |
| U6276-O-100MB.....    | 68 | UQFP-150.....          | 118 |
| U6276-O-10GR.....     | 68 | UQFP-200.....          | 118 |
| U6276-O-41.....       | 68 | UQFPH-100.....         | 118 |
| U6276-O-54.....       | 68 | UQFPH-125.....         | 118 |
| U6276-O-55.....       | 68 | UQFPH-150.....         | 118 |
| U6276-O-75.....       | 68 | UQFPH-200.....         | 118 |
| U7021-RL-TG.....      | 13 | UQFPH-M-100.....       | 118 |
| U7040-XL-TG.....      | 13 | UQFPH-M-125.....       | 118 |
| U7043-XL-TG.....      | 13 | UQFPH-M-150.....       | 118 |
| U7422-RXL.....        | 18 | UQFPH-M-200.....       | 118 |
| U7423-RXL.....        | 18 | UQFP-M-100.....        | 118 |
| U7487-O.....          | 12 | UQFP-M-125.....        | 118 |
| U7487-RL.....         | 12 | UQFP-M-150.....        | 118 |
| U7490-O.....          | 12 | UQFP-M-200.....        | 118 |
| U7490-RL.....         | 12 | USE-AP-200-MB.....     | 23  |
| U7573-RL.....         | 18 | USE-AP-200-ML.....     | 23  |
| U8032-XL.....         | 48 | Z020-148-00-00-0.....  | 65  |
| U8033-XL.....         | 48 | Z020-148-00-00-0.....  | 79  |
| U8034-XL.....         | 48 | Z1050596.....          | 65  |
| U8035-XL.....         | 48 | Z1050596.....          | 79  |
| U8036-XL.....         | 48 | Z700911-MO.....        | 79  |
| U8100-RL.....         | 18 | Z708767-MO.....        | 89  |
| U9319-XL.....         | 17 | Z802965-AC.....        | 117 |
| U9320-RXL.....        | 18 | Z814898-AC.....        | 117 |
| U9550-RRL.....        | 19 | Z818052-SC.....        | 89  |
| U9551-RXL.....        | 19 | Z818480-SC.....        | 89  |
| U9700-RRL.....        | 19 | Z901925-AC.....        | 117 |
| U9701-RXL.....        | 19 | Z90327486-AO.....      | 117 |
| U9800-RRL.....        | 19 | Z904486-AO.....        | 117 |
| U9801-RXL.....        | 19 | Z915141-AC.....        | 88  |
| UC1290-XL.....        | 54 | Z916264-AO.....        | 117 |
| UC1291-RL.....        | 54 | Z916265-AO.....        | 117 |
| UC1299-XL.....        | 54 | Z917602-AC.....        | 88  |
| UC1300-RL.....        | 54 | Z918447-AC.....        | 89  |
| UC3423-XL.....        | 55 | Z918449-AC.....        | 89  |
| UC3425-XL.....        | 55 | Z918466-AC.....        | 88  |



Please consult serving utility for their requirements prior to ordering or installing, as specifications and approvals vary by utility, and may require local electrical inspector approval. All installations must be installed by a licensed electrician and must comply with all national and local codes, laws and regulations. Milbank reserves the right to make changes in specifications and features shown without notice or obligation.



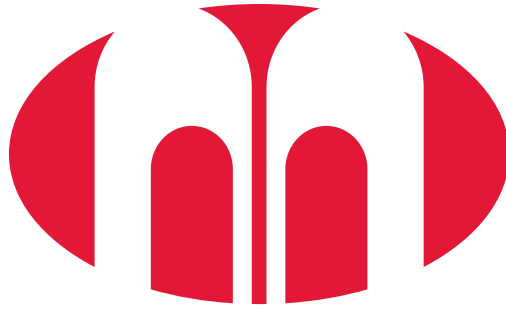

# MILBANK<sup>®</sup>

ENERGY AT WORK







**MILBANK**<sup>®</sup>  
ENERGY AT WORK



# Western Region

*Product Catalog*



# Milbank Overview

*Energy At Work since 1927*

Milbank designs and manufactures electrical solutions that move and manage power for the residential, commercial, industrial, utility and transportation sectors. With 90 years of expertise in electrical engineering design and manufacturing, Milbank's portfolio includes metering equipment, enclosures and enclosed controls. Founded in 1927, Milbank is a family-owned, American manufacturer headquartered in Kansas City, Mo. For more information, please visit [milbankworks.com](http://milbankworks.com).

---

## METERING

---



As a market leader in electrical metering equipment, Milbank has set the standard for quality since 1927. Hundreds of configurations are available, including many sizes, knockout configurations, terminal configurations, bypass options, hubs, locks and connectors. Milbank has the socket you need with thousands of active products to meet your utility's requirements.

---

## ENCLOSURES

---



Milbank's line of enclosures include commercial junction boxes, panel mount enclosures, transformer cabinets, wireway, trough and industrial panel mount and push-button enclosures. Built with high-quality craftsmanship and materials which meet or exceed industry standards, Milbank enclosures are made to protect controls and equipment from dust, dirt and other harmful elements found in a wide variety of environments.

---

## ENCLOSED CONTROLS

---



Milbank doesn't just build empty enclosures. We can deliver the entire package, complete with custom control equipment built to your exact specifications by our engineers. Milbank commercial pedestals are an attractive, secure, easy to install and cost-effective solution when underground remote site power distribution and control equipment is required, replacing unsightly and inefficient strut and backboard structures. Milbank's manual and automatic transfer switches are durable, easy to install and compatible with most generators.



Please consult serving utility for their requirements prior to ordering or installing, as specifications and approvals vary by utility, and may require local electrical inspector approval. All installations must be installed by a licensed electrician and must comply with all national and local codes, laws and regulations. Milbank reserves the right to make changes in specifications and features shown without notice or obligation.

## Air Conditioner Disconnects

|  |   |
|--|---|
| 30-60 amp AC disconnects .....                         | 7 |
| 60 amp AC disconnect with 20 amp GFCI receptacle ..... | 8 |
| Hot tub disconnects.....                               | 9 |

## Single Position Sockets

|  |       |
|--|-------|
| 30-100 amp, 4 terminal, ring type .....                            | 10    |
| 100 amp, solar sockets, 4 terminal .....                           | 11    |
| 125 amp, 4 & 7 terminal, ringless & ring type .....                | 12    |
| 200 amp, 4 & 7 terminal, ringless & ring type .....                | 13-14 |
| 200 amp, 4 terminal, ring type .....                               | 15    |
| 125-200 amp, 4 & 7 terminal, ring type, link bypass .....          | 16    |
| 200 amp, 4 & 5 terminal, lever bypass, ringless, lever bypass..... | 17    |
| 125-200 amp, 4,5 & 7 terminal, ringless, lever bypass .....        | 18-19 |
| 320 amp, 4 terminal, lever & non-lever bypass, ringless.....       | 20    |
| 320 amp, 4 terminal, link bypass, ring type.....                   | 21    |
| 320 amp, 7 terminal, lever bypass, ringless.....                   | 22    |
| 100-200 amp, 4 terminal, main breaker.....                         | 23    |

## Meter Mains

|  |       |
|--|-------|
| 200 amp, 4 & 7 terminal, ring type.....                        | 24    |
| 100-200 amp, 4 & 5 terminal, ringless & ring type .....        | 25    |
| 400-320 amp continuous, 4 terminal, ringless & ring type ..... | 26-30 |

## Safety Sockets

|   |       |
|---|-------|
| 100 & 200 amp, 4, 5 & 7 terminal, ring type, test block bypass..... | 31-32 |
| 100 amp, 4, 5 & 7 terminal, ring type, test block bypass .....      | 33-35 |
| 200 amp, 4, 5 & 7 terminal, ring type, test block bypass .....      | 36-39 |
| 100 & 200 amp, all-in-one series, test block bypass .....           | 40-41 |
| Replacement Parts.....  | 42-44 |

## Underground Termination Boxes

|                               |       |
|-------------------------------|-------|
| 100-800 amp.....              | 45    |
| Bussed gutters, type 3R ..... | 46-47 |

## Multi-Position Sockets

|   |       |
|---|-------|
| 100-125 amp, 4 terminal, ringless .....               | 48    |
| 200 amp, 4 terminal, ringless.....                    | 49    |
| 125 & 200 amp, 4 terminal, meter mains, ringless..... | 50-53 |

Please consult serving utility for their requirements prior to ordering or installing, as specifications and approvals vary by utility, and may require local electrical inspector approval. All installations must be installed by a licensed electrician and must comply with all national and local codes, laws and regulations. Milbank reserves the right to make changes in specifications and features shown without notice or obligation.



**Miscellaneous**

|  |       |
|--|-------|
| Current transformer enclosures .....     | 54-55 |
| Current transformer test switches .....  | 56-57 |
| Test switch worksheet .....              | 58    |
| Current transformer cabinets.....        | 59-62 |
| Service pedestals, mobile home .....     | 63-64 |
| Power pedestals .....                    | 65    |
| Replacement parts.....                   | 66-67 |
| Mobile home pedestals.....               | 68    |
| Service pedestals.....                   | 69-74 |
| Temporary power .....                    | 75-79 |
| Surface mount power .....                | 80    |
| Power outlet pedestals.....              | 81    |
| Replacement receptacle plates.....       | 82    |
| Lighting accessories.....                | 83-84 |
| Telecom and pedestal accessories.....    | 85    |
| Pedestal mounting accessories .....      | 86    |
| Metering and receptacle accessories..... | 87    |
| Replacement parts and accessories .....  | 88-89 |
| Recreational vehicle products.....       | 90-91 |
| Dry type transformers.....               | 92    |

**Commercial Pedestals**

|   |         |
|---|---------|
| Commercial pedestal overview.....                                       | 93-94   |
| 100-200 amp, 4 terminal ringless & ring type.....                       | 95      |
| 100-200 amp, Switch load center, 4 terminal, ringless & ring type ..... | 96      |
| 400 amp, class 320 4 terminal, ringless & ring type .....               | 97      |
| 100 amp, irrigation, 4 terminal, ring type.....                         | 98      |
| Battery backup series .....   | 99      |
| Power transfer series .....   | 100     |
| CT metered series.....  | 101     |
| Slim line series .....  | 102     |
| Commercial pedestal accessories .....                                   | 103     |
| Commercial pedestal reference information.....                          | 104-113 |

**Miscellaneous**

|  |         |
|--|---------|
| Commercial & industrial enclosures ..... | 114     |
| Accessories .....                        | 115-119 |
| Reference information .....              | 120-123 |
| Index.....                               | 124-128 |



Please consult serving utility for their requirements prior to ordering or installing, as specifications and approvals vary by utility, and may require local electrical inspector approval. All installations must be installed by a licensed electrician and must comply with all national and local codes, laws and regulations. Milbank reserves the right to make changes in specifications and features shown without notice or obligation.

# Catalog Number Logic

How our product catalog numbers are derived

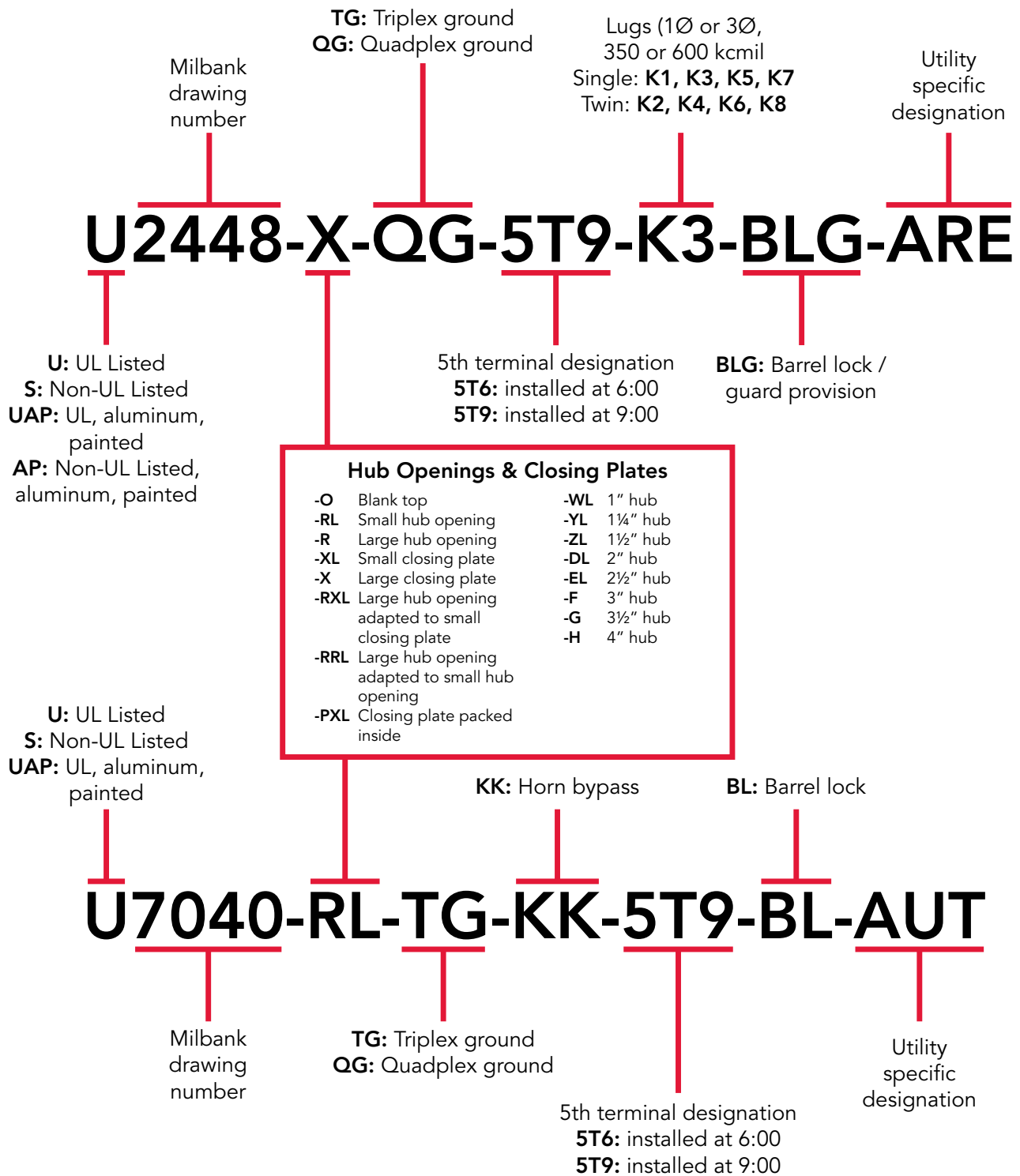

Please consult serving utility for their requirements prior to ordering or installing, as specifications and approvals vary by utility, and may require local electrical inspector approval. All installations must be installed by a licensed electrician and must comply with all national and local codes, laws and regulations. Milbank reserves the right to make changes in specifications and features shown without notice or obligation.



| Catalog Number    | EUSERC Drawing Number | Catalog Page | Catalog Number | EUSERC Drawing Number | Catalog Page | Catalog Number    | EUSERC Drawing Number | Catalog Page |
|-------------------|-----------------------|--------------|----------------|-----------------------|--------------|-------------------|-----------------------|--------------|
| U3574-RL-200      | 301                   | 24           | 215MTB-P48     | 305A, 311             | 35           | PB-034            | 343                   | 45           |
| U3577-RL-200      | 301                   | 24           | 217MTB-P48     | 305A, 311             | 35           | PB-034-NK         | 343                   | 45           |
| U3584-O-200       | 301                   | 24           | U214MTB-P48    | 305A, 311             | 35           | PB-038            | 343                   | 45           |
| U3597-O-200       | 301                   | 24           | U215MTB-P48    | 305A, 311             | 35           | U3320-R           | 313                   | 62           |
| U4015-O           | 301A                  | 14           | U217MTB-P48    | 305A, 311             | 35           | MPRV-BLANK-78     | 307                   | 63           |
| UF4015-KO         | 301A                  | 15           | 224MTB         | 305A, 311             | 36           | MPRV-BLANK-78-R5T | 307                   | 63           |
| U3548-X           | 302B                  | 21           | 225MTB         | 305A, 311             | 36           | MPRV-100-78       | 307                   | 63           |
| M400-UG-APS-F     | 302A                  | 28           | 227MTB         | 305A, 311             | 37           | MPRV-100-MB-78    | 307                   | 63           |
| M400-UG-APS-F-BS  | 302                   | 28           | U224MTB        | 305A, 311             | 36           | MPRV-50-78        | 307                   | 63           |
| M400-UG-APS-P     | 302A                  | 28           | U225MTB        | 305A, 311             | 36           | MPRV-503020GR-78  | 307                   | 63           |
| M400-UG-APS-LC    | 302A                  | 28           | U227MTB        | 305A, 311             | 36           | MPAP-BLANK-78     | 307                   | 64           |
| M400-UG-APS-LC-BS | 302A                  | 28           | U224MTB        | 305A, 311             | 36           | MPAP-BLANK-78R    | 307                   | 64           |
| U3251-O-200-CB    | 302                   | 28           | U225MTB        | 305A, 311             | 36           | MPAP-100-78       | 307                   | 64           |
| M401-UG           | 302A                  | 29           | U227MTB        | 305A, 311             | 36           | MPAP-100-MB-78    | 307                   | 64           |
| M401-UG-BS        | 302                   | 29           | 224MTB/22      | 305A, 311             | 37           | MPAP-200-78       | 307                   | 64           |
| M404-UG-LC        | 302A                  | 30           | 227MTB/22      | 305A, 311             | 37           | MPAP-200-MB-78    | 307                   | 64           |
| M404-UG-LC-BS     | 302                   | 30           | U224MTB/22     | 305A, 311             | 37           | MPAP-200-20GR-78  | 307                   | 64           |
| 114TB             | 304, 311              | 31           | U227MTB/22     | 305A, 311             | 37           | MPAPD-BLANK-78    | 307                   | 64           |
| 115TB             | 304, 311              | 31           | 227MTB-48      | 305A, 311             | 38           | MPAPD-BLANK-78R   | 307                   | 64           |
| 117TB             | 304, 311              | 31           | U224MTB-48     | 305A, 311             | 38           | U3322-R           | 313                   | 62           |
| 124TB             | 305, 311              | 31           | U227MTB-48     | 305A, 311             | 38           | U3355-R           | 313                   | 62           |
| 125TB             | 305, 311              | 31           | 224MTB-P       | 305A, 311             | 39           | U3340-O           | 314                   | 62           |
| 127TB             | 305, 311              | 31           | 225MTB-P       | 305A, 311             | 39           | U3342-O           | 314                   | 62           |
| 214MTB            | 305A, 311             | 32           | 227MTB-P       | 305A, 311             | 39           | U3565-O           | 314                   | 62           |
| 215MTB            | 305A, 311             | 32           | U224MTB-P      | 305A, 311             | 39           | CT244811-SC       | 316, 317              | 61           |
| 217MTB            | 305A, 311             | 32           | U227MTB-P      | 305A, 311             | 39           | CT364811-SC       | 316, 317, 318         | 61           |
| U214MTB           | 305A, 311             | 32           | 224MTB-P48     | 305A, 311             | 39           | CT364814-SC       | 316, 317, 318         | 61           |
| U215MTB           | 305A, 311             | 32           | 225MTB-P48     | 305A, 311             | 39           | CT484811-SC       | 316, 317              | 61           |
| U217MTB           | 305A, 311             | 32           | 227MTB-P48     | 305A, 311             | 39           | CT244811-HC       | 316, 317              | 61           |
| 214MTB/22         | 305A, 311             | 33           | U224MTB-P48    | 305A, 311             | 39           | CT304811-HC       | 316, 317              | 61           |
| 217MTB/22         | 305A, 311             | 33           | U227MTB-P48    | 305A, 311             | 39           | CT364811-HC       | 316, 317, 318         | 61           |
| U214MTB/22        | 305A, 311             | 33           | U214MTBL       | 305A, 311             | 40           | CT484811-HC       | 316, 317, 318         | 61           |
| U217MTB/22        | 305A, 311             | 33           | U214MTBPL      | 305A, 311             | 40           | CT484814-HC       | 316, 317, 318         | 61           |
| 214MTB-48         | 305A, 311             | 34           | U217MTBL       | 305A, 311             | 40           | K4903             | 328B                  | 60           |
| 215MTB-48         | 305A, 311             | 34           | U217MTBPL      | 305A, 311             | 40           | K4904             | 329B                  | 60           |
| 217MTB-48         | 305A, 311             | 34           | U224MTBL       | 305A, 311             | 40           | K4722             | 329B                  | 60           |
| U214MTB-48        | 305A, 311             | 34           | U224MTBPL      | 305A, 311             | 40           | K4729             | 328B                  | 60           |
| U215MTB-48        | 305A, 311             | 34           | U227MTBL       | 305A, 311             | 40           | K4797             | 328A                  | 60           |
| U217MTB-48        | 305A, 311             | 34           | U227MTBPL      | 305A, 311             | 40           | K4798             | 339A                  | 60           |
| 214MTB-P          | 305A, 311             | 35           | PB-011         | 305A, 311             | 45           | UC3435-XL         | 339                   | 54           |
| 215MTB-P          | 305A, 311             | 35           | PB-012         | 343A                  | 45           | UC3436-XL         | 339                   | 54           |
| 217MTB-P          | 305A, 311             | 35           | PB-014         | 343                   | 45           | UC3438-XL         | 339                   | 54           |
| U214MTB-P         | 305A, 311             | 35           | PB-014-NK      | 343                   | 45           | UC3433-XL         | 339                   | 54           |
| U215MTB-P         | 305A, 311             | 35           | PB-018         | 343                   | 45           | UC3434-XL         | 339                   | 54           |
| U217MTB-P         | 305A, 311             | 35           | PB-034-NK      | 343                   | 45           |                   |                       |              |
| 214MTB-P48        | 305A, 311             | 35           | PB-032         | 343A                  | 45           |                   |                       |              |



Please consult serving utility for their requirements prior to ordering or installing, as specifications and approvals vary by utility, and may require local electrical inspector approval. All installations must be installed by a licensed electrician and must comply with all national and local codes, laws and regulations. Milbank reserves the right to make changes in specifications and features shown without notice or obligation.

# Air Conditioner Disconnects

30-60 Amp | Fusible & Non-Fusible



**U3802**



**U3812**



**U3832**

Milbank's air conditioner disconnect has a removable hinged cover for ease of installation. Our compact design meets NEC wiring space requirements and also complies with NEC article 440-14. For safe working conditions, our disconnect pullers may be removed and reinstalled in the OFF position. Additionally, padlock provisions are included on the front cover. As with other Milbank products, our enclosure is constructed of G90U galvanized steel and electrostatically finished with an attractive, light gray, baked powder coating. Our epoxy/polyester resin blend offers a finish that is both durable and fade-resistant.

## 30-60 Amp | 1Ø 240 VAC | Air Conditioner Disconnects

| Catalog Number | Amp | Type        | Max H.P. | Weight (lbs.) | Line/Load Wire Range |        | Ground Wire Range CU/AL | Dimensions |    |    | Wire Rating |         |
|----------------|-----|-------------|----------|---------------|----------------------|--------|-------------------------|------------|----|----|-------------|---------|
|                |     |             |          |               | CU                   | AL     |                         | D"         | W" | H" | CU °C       | AL °C   |
| <b>U3802</b>   | 60  | Non-Fusible | 10       | 3.25          | #14-#2               | #12-#2 | #14-4                   | 2½         | 5  | 7½ | 60°/75°     | 60°/75° |
| <b>U3812</b>   | 60  | Non-Auto    | 10       | 3.25          | #14-#2               | #12-#2 | #14-4                   | 2½         | 5  | 7½ | 60°/75°     | 60°/75° |
| <b>U3832</b>   | 30  | Fusible     | 3        | 2.5           | #14-#3               | #14-#3 | #14-3                   | 2½         | 5  | 7  | 60°/75°     | 60°/75° |
| <b>U3862</b>   | 60  | Fusible     | 10       | 3.3           | #14-#3               | #14-#3 | #14-3                   | 2½         | 5  | 9  | 60°/75°     | 60°/75° |

### Notes

- UL listed as Enclosed Pullout Switch
- Type 3R rain resistant
- One-inch concentric knockouts

Please consult serving utility for their requirements prior to ordering or installing, as specifications and approvals vary by utility, and may require local electrical inspector approval. All installations must be installed by a licensed electrician and must comply with all national and local codes, laws and regulations. Milbank reserves the right to make changes in specifications and features shown without notice or obligation.



# Air Conditioner Disconnects

## 60 Amp | With 20 Amp GFCI Receptacle



**U3822-20GWR**

### Specifications

- Meets NEC #210.63 requirements
- UL listed as Power Outlet
- Type 3R enclosure
- In-use cover\*
- Duplex ground connector
- 1" concentric knockouts
- 1Ø, 240 volt
- 60 amp, non-fused
- 20 amp GFCI receptacle
- Reset/test button
- Weather and tamper resistant
- Meets NEC #406.8 requirements

### 60 Amp | 1Ø, 240 VAC | Air Conditioner Disconnect with GFCI Receptacle

| Catalog Number | Type        | Max H.P. | Weight (lbs.) | Line/Load Wire Range |        | Ground Wire Range CU/AL | Dimensions |    |    | Wire Rating |         |
|----------------|-------------|----------|---------------|----------------------|--------|-------------------------|------------|----|----|-------------|---------|
|                |             |          |               | CU                   | AL     |                         | D"         | W" | H" | CU °C       | AL °C   |
| U3822-20GWR    | Non-Fusible | 10       | 6             | #14-#2               | #12-#2 | #14-4                   | 4½         | 5¼ | 7½ | 60°/75°     | 60°/75° |

### Notes

- **Disconnect Pullouts:** To ensure the safest conditions, Milbank disconnect pullouts are reversible so they may be reinstalled in the OFF position.
- **Padlock Provision:** All units are designed with a padlock provision on the cover for security.
- **\*In-Use Cover:** Cover is rated as an in-use cover (cover may be closed with cords plugged into receptacle).



# Hot Tub Disconnects

## Type 3R Enclosures



U4881-O-50GB



U4881-O-60GB

### Specifications

- 240 volt ground fault protection
- UL listed, Type 3R rain resistant enclosure
- 2-pole, 50 amp GFCI breaker protection
- Compact size
- Three or four wire installation
- 1Ø, 120/240 VAC
- Standard package of 12
- Two extra one-pole breaker spaces
- 100 amp overall rating
- Easy to install

### 100 Amp | Hot Tub Disconnect or Sub Panel Breaker Enclosure | Type 3R

| Catalog Number | Breaker Amp | Type              | Weight (lbs.) | Line/Load Wire Range |         | Ground Wire Range CU/AL | Dimensions |    |    |
|----------------|-------------|-------------------|---------------|----------------------|---------|-------------------------|------------|----|----|
|                |             |                   |               | CU                   | AL      |                         | D"         | W" | H" |
| U4881-O        | —           | Breaker Provision | 7             | #14-1/0              | #14-1/0 | #14-1/0                 | 3¾         | 7½ | 8½ |
| U4881-O-50GB   | 50          | Breaker           | 8             | #14-1/0              | #14-1/0 | #14-1/0                 | 3¾         | 7½ | 8½ |
| U4881-O-60GB   | 60          | Breaker           | 8             | #14-1/0              | #14-1/0 | #14-1/0                 | 3¾         | 7½ | 8½ |

Please consult serving utility for their requirements prior to ordering or installing, as specifications and approvals vary by utility, and may require local electrical inspector approval. All installations must be installed by a licensed electrician and must comply with all national and local codes, laws and regulations. Milbank reserves the right to make changes in specifications and features shown without notice or obligation.



# Single Position Sockets

30-100 Amp | 4 Terminal | Ring Type

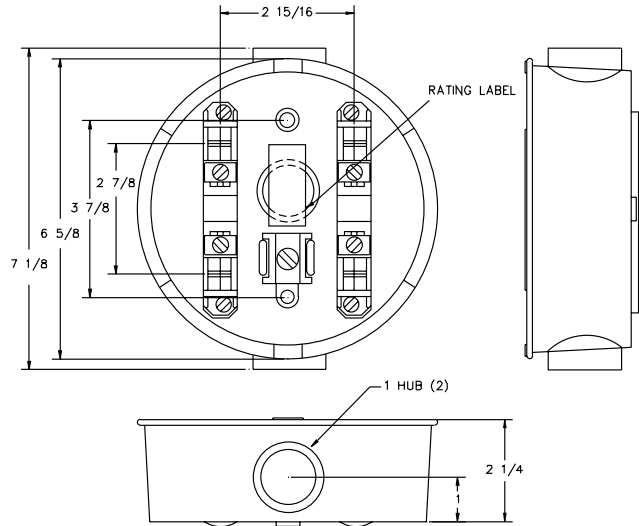

## Applications

100 amp max rated is ideal for use on:

- Temporary service
- Outdoor advertising
- Small customer service
- Other low amp requirements

## 30-100 Amp | 4 Terminal | Economy Cast Socket | Ring Type | Single Position

| Catalog Number | Terminal | Service | Hub    | Connectors CU/AL |         | Quantity Per Package | Concentric Knockouts |
|----------------|----------|---------|--------|------------------|---------|----------------------|----------------------|
|                |          |         |        | Line             | Load    |                      |                      |
| AP2300-03      | 4        | OH/UG   | 1"     | #12-1/0          | #12-1/0 | 12                   | 3/4", 1"             |
| AP2300-04      | 4        | OH/UG   | 1 1/4" | #12-1/0          | #12-1/0 | 12                   | 3/4", 1"             |

## Notes

- **Fifth & Sixth Terminal:** Contact factory.
- **Sealing Ring:** Supplied with a snap action sealing ring.
- **Hub:** Units supplied with cast in hub on top and bottom. Consult factory for availability of other hub sizes.
- **Bypass:** Also available with auto bypass. Contact factory.



Please consult serving utility for their requirements prior to ordering or installing, as specifications and approvals vary by utility, and may require local electrical inspector approval. All installations must be installed by a licensed electrician and must comply with all national and local codes, laws and regulations. Milbank reserves the right to make changes in specifications and features shown without notice or obligation.

# Single Position Solar Sockets

100 Amp | 4 Terminal | 600 VAC

**1 1**  
100 AMP  
SINGLE  
POSITION  
SOCKETS



U5934-XL-BLG



U6087-XL-INS



U4175-RL-BLG

## 100 Amp | 4 Terminal | Residential Solar Sockets | Standard Neutral

| Catalog Number | Socket Type | Service | Hub  | Connectors CU/AL |         | Dimensions                     |    |                                | Knockouts |                               |                               |                               |
|----------------|-------------|---------|------|------------------|---------|--------------------------------|----|--------------------------------|-----------|-------------------------------|-------------------------------|-------------------------------|
|                |             |         |      | Line             | Load    | D"                             | W" | H"                             | 1         | 2                             | 3                             | 4                             |
| U4175-RL-BLG*  | Ringless    | OH/UG   | H.O. | #12-1/0          | #12-1/0 | 3 <sup>5</sup> / <sub>16</sub> | 8  | 11 <sup>1</sup> / <sub>2</sub> | 2         | 1 <sup>1</sup> / <sub>2</sub> | 1 <sup>1</sup> / <sub>4</sub> | 1 <sup>1</sup> / <sub>4</sub> |
| U6087-XL*      | Ring Type   | OH/UG   | C.P. | #12-1/0          | #12-1/0 | 3 <sup>5</sup> / <sub>16</sub> | 8  | 11 <sup>1</sup> / <sub>2</sub> | 2         | 1 <sup>1</sup> / <sub>2</sub> | 1 <sup>1</sup> / <sub>4</sub> | 1 <sup>1</sup> / <sub>4</sub> |
| U6087-XL-INS*  | Ring type   | OH/UG   | C.P. | #12-1/0          | #12-1/0 | 3 <sup>5</sup> / <sub>16</sub> | 8  | 11 <sup>1</sup> / <sub>2</sub> | 2         | 1 <sup>1</sup> / <sub>2</sub> | 1 <sup>1</sup> / <sub>4</sub> | 1 <sup>1</sup> / <sub>4</sub> |

## 100 Amp | 4 Terminal | Residential Solar Sockets | Integral Isolated Neutral Option

| Catalog Number | Socket Type | Service | Hub  | Connectors CU/AL |         | Dimensions                     |    |                                | Knockouts |                               |                               |                               |
|----------------|-------------|---------|------|------------------|---------|--------------------------------|----|--------------------------------|-----------|-------------------------------|-------------------------------|-------------------------------|
|                |             |         |      | Line             | Load    | D"                             | W" | H"                             | 1         | 2                             | 3                             | 4                             |
| U5929-XL-INS   | Ring Type   | OH/UG   | C.P. | #12-1/0          | #12-1/0 | 3 <sup>5</sup> / <sub>16</sub> | 8  | 11 <sup>1</sup> / <sub>2</sub> | 2         | 1 <sup>1</sup> / <sub>2</sub> | 1 <sup>1</sup> / <sub>4</sub> | 1 <sup>1</sup> / <sub>4</sub> |
| U5934-XL-BLG   | Ringless    | OH/UG   | C.P. | #12-1/0          | #12-1/0 | 3 <sup>5</sup> / <sub>16</sub> | 8  | 11 <sup>1</sup> / <sub>2</sub> | 2         | 1 <sup>1</sup> / <sub>2</sub> | 1 <sup>1</sup> / <sub>4</sub> | 1 <sup>1</sup> / <sub>4</sub> |

### Notes

- **BLG:** Barrel lock guard knockout provision.
- **Hubs:** Accepts standard meter socket hubs.
- **Construction:** Units are Type 3R for durable outdoor use, lockable and sealable.
- **\*Application:** The standard bonded neutral units are applicable in areas where utility does not require an isolated neutral.

Please consult serving utility for their requirements prior to ordering or installing, as specifications and approvals vary by utility, and may require local electrical inspector approval. All installations must be installed by a licensed electrician and must comply with all national and local codes, laws and regulations. Milbank reserves the right to make changes in specifications and features shown without notice or obligation.



# 12

125 AMP  
SINGLE  
POSITION  
SOCKETS

# Single Position Sockets

125 Amp | 4 & 7 Terminal | Ringless & Ring Type



U7487-RL

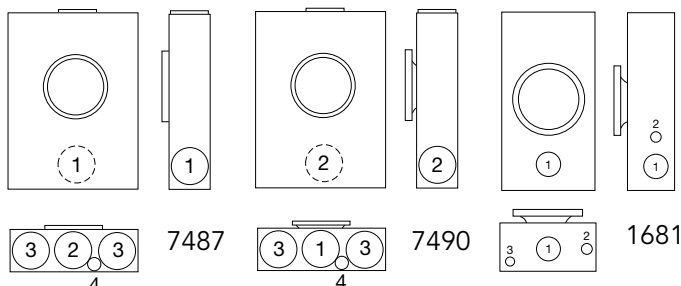

U7490-O

## 125 Amp | 4 Terminal | Ringless | Single Position

| Catalog Number | Terminal | Service | Hub   | Connectors CU/AL |        | Bypass | Dimensions                     |    |                                | Knockouts                     |   |                               |                               |
|----------------|----------|---------|-------|------------------|--------|--------|--------------------------------|----|--------------------------------|-------------------------------|---|-------------------------------|-------------------------------|
|                |          |         |       | Line             | Load   |        | D"                             | W" | H"                             | 1                             | 2 | 3                             | 4                             |
| U7487-O        | 4        | UG      | Blank | #6-2/0           | #6-2/0 | None   | 3 <sup>5</sup> / <sub>16</sub> | 8  | 11 <sup>1</sup> / <sub>2</sub> | 1 <sup>1</sup> / <sub>2</sub> | 2 | 1 <sup>1</sup> / <sub>4</sub> | 1 <sup>1</sup> / <sub>4</sub> |
| U7487-RL       | 4        | OH/UG   | H.O.  | #6-2/0           | #6-2/0 | None   | 3 <sup>5</sup> / <sub>16</sub> | 8  | 11 <sup>1</sup> / <sub>2</sub> | 1 <sup>1</sup> / <sub>2</sub> | 2 | 1 <sup>1</sup> / <sub>4</sub> | 1 <sup>1</sup> / <sub>4</sub> |

## 125 Amp | 4 Terminal | Ring Type | Single Position

| Catalog Number | Terminal | Service | Hub   | Connectors CU/AL |        | Bypass | Dimensions                     |    |                                | Knockouts                     |                               |   |                               |   |                               |
|----------------|----------|---------|-------|------------------|--------|--------|--------------------------------|----|--------------------------------|-------------------------------|-------------------------------|---|-------------------------------|---|-------------------------------|
|                |          |         |       | Line             | Load   |        | D"                             | W" | H"                             | 1                             | 2                             | 3 | 4                             | 5 | 6                             |
| U7490-O        | 4        | UG      | Blank | #6-2/0           | #6-2/0 | None   | 3 <sup>5</sup> / <sub>16</sub> | 8  | 11 <sup>1</sup> / <sub>2</sub> | 1 <sup>1</sup> / <sub>2</sub> | 1 <sup>1</sup> / <sub>2</sub> | 2 | 1 <sup>1</sup> / <sub>2</sub> | — | 1 <sup>1</sup> / <sub>4</sub> |
| U7490-RL       | 4        | OH/UG   | H.O.  | #6-2/0           | #6-2/0 | None   | 3 <sup>5</sup> / <sub>16</sub> | 8  | 11 <sup>1</sup> / <sub>2</sub> | 1 <sup>1</sup> / <sub>2</sub> | 1 <sup>1</sup> / <sub>2</sub> | 2 | 1 <sup>1</sup> / <sub>2</sub> | — | 1 <sup>1</sup> / <sub>4</sub> |

## 125 Amp | 7 Terminal | Ring Type | Single Position

| Catalog Number | Terminal | Service | Hub  | Connectors CU/AL |        | Bypass | Dimensions                     |    |                                | Knockouts |                                |                               |   |   |                                |
|----------------|----------|---------|------|------------------|--------|--------|--------------------------------|----|--------------------------------|-----------|--------------------------------|-------------------------------|---|---|--------------------------------|
|                |          |         |      | Line             | Load   |        | D"                             | W" | H"                             | 1         | 2                              | 3                             | 4 | 5   | 6                              |
| U1681-RL       | 7        | OH      | H.O. | #6-2/0           | #6-2/0 | None   | 4 <sup>7</sup> / <sub>16</sub> | 10 | 18 <sup>1</sup> / <sub>2</sub> | 2         | 3 <sup>4</sup> / <sub>16</sub> | 1 <sup>1</sup> / <sub>2</sub> | — | 1 <sup>1</sup> / <sub>4</sub> , 1 <sup>1</sup> / <sub>2</sub> | 3 <sup>4</sup> / <sub>16</sub> |

## Notes

- **Fifth Terminal:** For field mounted fifth terminal on the **U7487 & U7490** order catalog number **5T8K2** to fit into round opening at the 9 o'clock position.
- **Hubs:** For proper hub selection see the hub suffix chart on the accessory page.
- **Connectors:** Extruded aluminum connectors are tin plated.
- **Sealing Rings:** Ring type units supplied with an **MR-2** snap action sealing ring as standard.



Please consult serving utility for their requirements prior to ordering or installing, as specifications and approvals vary by utility, and may require local electrical inspector approval. All installations must be installed by a licensed electrician and must comply with all national and local codes, laws and regulations. Milbank reserves the right to make changes in specifications and features shown without notice or obligation.

# Single Position Sockets

200 Amp | 4 Terminal | Ringless

**13**  
200 AMP  
SINGLE  
POSITION  
SOCKETS



U7040-XL-TG



U1060-RL



U1980-O

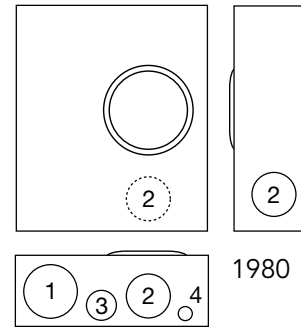
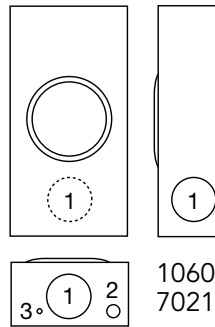
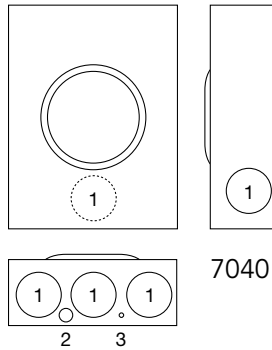

## 200 Amp | 4 Terminal | Ringless | Single Position

| Catalog Number | Terminal | Service | Hub   | Connectors CU/AL |        | Bypass | Dimensions      |    |                  | Knockouts       |                 |                 |                 |                               |               |
|----------------|----------|---------|-------|------------------|--------|--------|-----------------|----|------------------|-----------------|-----------------|-----------------|-----------------|-------------------------------|---------------|
|                |          |         |       | Line             | Load   |        | D"              | W" | H"               | 1               | 2               | 3               | 4               | 5                             | 6             |
| U1060-RL       | 4        | OH      | H.O.  | #2-350           | #2-350 | None   | 4 $\frac{1}{8}$ | 8  | 15 $\frac{1}{2}$ | 2               | $\frac{3}{4}$   | $\frac{1}{4}$   | —               | —                             | $\frac{1}{4}$ |
| U1527-O        | 4        | UG      | Blank | #2-350           | #2-350 | None   | 4 $\frac{1}{8}$ | 11 | 15 $\frac{1}{2}$ | 2               | $\frac{1}{2}$   | $\frac{1}{4}$   | 2 $\frac{1}{2}$ | $\frac{1}{4}$ , $\frac{1}{2}$ | $\frac{1}{4}$ |
| U1980-O        | 4        | UG      | Blank | #6-350           | #6-350 | None   | 4 $\frac{1}{8}$ | 13 | 15 $\frac{1}{2}$ | 3               | 2 $\frac{1}{2}$ | $\frac{1}{4}$   | $\frac{1}{2}$   | —                             | —             |
| U7021-RL-TG    | 4        | OH      | H.O.  | #6-350           | #6-350 | None   | 4 $\frac{1}{8}$ | 8  | 15 $\frac{1}{2}$ | 2 $\frac{1}{2}$ | $\frac{1}{2}$   | $\frac{1}{4}$   | —               | —                             | —             |
| U7040-XL-TG    | 4        | OH/UG   | C.P.  | #6-350           | #6-350 | None   | 4 $\frac{1}{8}$ | 11 | 15 $\frac{1}{2}$ | $\frac{1}{2}$   | $\frac{1}{4}$   | 2 $\frac{1}{2}$ | —               | —                             | —             |
| U7043-XL-TG    | 4        | OH/UG   | C.P.  | #6-350           | #6-350 | None   | 4 $\frac{1}{8}$ | 13 | 15 $\frac{1}{2}$ | 2 $\frac{1}{2}$ | $\frac{1}{2}$   | $\frac{1}{4}$   | —               | —                             | —             |

## Notes

- **Fifth Terminal:** For field mounted fifth terminal order catalog number **K5T** to fit into square opening at the 9 o'clock position.
- **Hubs:** For proper hub selection see the hub suffix chart on accessory page.
- **Connectors:** Extruded aluminum connectors are tin plated.

Please consult serving utility for their requirements prior to ordering or installing, as specifications and approvals vary by utility, and may require local electrical inspector approval. All installations must be installed by a licensed electrician and must comply with all national and local codes, laws and regulations. Milbank reserves the right to make changes in specifications and features shown without notice or obligation.



# 14

200 AMP  
SINGLE  
POSITION  
SOCKETS

# Single Position Sockets

200 Amp | 4 & 7 Terminal | Ring Type



U3328-RXL



U4518-O-W

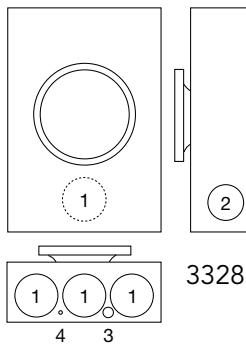

3328

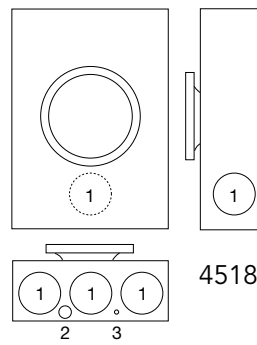

4518

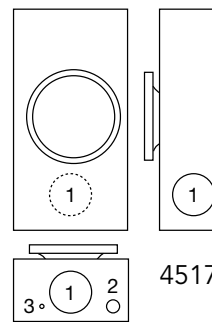

4517

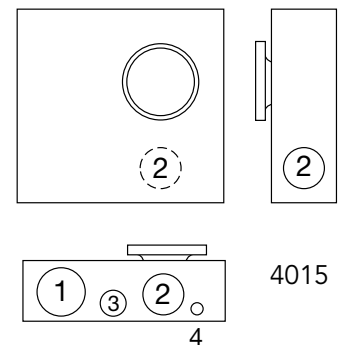

4015

## 200 Amp | Ring Type | Single Position

| Catalog Number | Terminal | Service | Hub   | Connectors CU/AL |        | Bypass | Dimensions |    |     | Knockouts |    |    |   |
|----------------|----------|---------|-------|------------------|--------|--------|------------|----|-----|-----------|----|----|---|
|                |          |         |       | Line             | Load   |        | D"         | W" | H"  | 1         | 2  | 3  | 4 |
| U4517-DL-M4    | 4        | OH      | 2"    | #6-350           | #6-350 | None   | 4½         | 8  | 15½ | 2½        | ½  | ¼  | — |
| U4518-XL-W     | 4        | OH/UG   | C.P.  | #6-350           | #6-350 | None   | 4½         | 11 | 15½ | 2½        | ½  | ¼  | — |
| U4518-O-W      | 4        | UG      | Blank | #6-350           | #6-350 | None   | 4½         | 11 | 15½ | 2½        | ½  | ¼  | — |
| U4015-O        | 4        | UG      | Blank | #6-350           | #6-350 | None   | 6          | 14 | 16¼ | 3         | 2½ | 1½ | ½ |
| U3328-RXL      | 7        | OH/UG   | C.P.  | #6-350           | #6-350 | None   | 4¾         | 13 | 19  | 3         | 2½ | ½  | ¼ |

## Notes

- **Fifth Terminal:** For field mounted fifth terminal order catalog number **K5T** to fit into square opening at the 9 o'clock position.
- **Hubs:** For proper hub selection see the hub suffix chart on accessory page.
- **Connectors:** Extruded aluminum connectors are tin plated.
- **Sealing Rings:** The above ring type units are supplied with a **MR-4** screw type sealing ring as standard.



Please consult serving utility for their requirements prior to ordering or installing, as specifications and approvals vary by utility, and may require local electrical inspector approval. All installations must be installed by a licensed electrician and must comply with all national and local codes, laws and regulations. Milbank reserves the right to make changes in specifications and features shown without notice or obligation.

# Single Position Sockets

200 Amp | 4 Terminal | Flush Mount | Ring Type

**15**  
200 AMP  
SINGLE  
POSITION  
SOCKETS



UF4518-KO



UF4015-KO

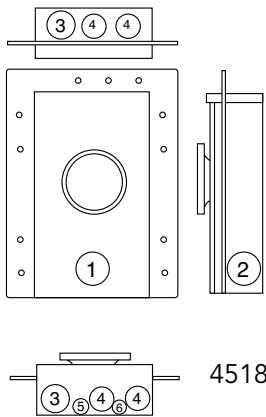

4518

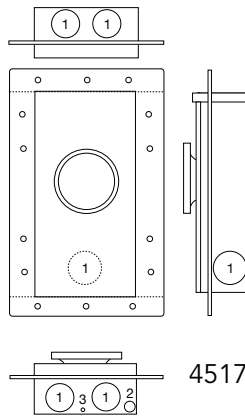

4517

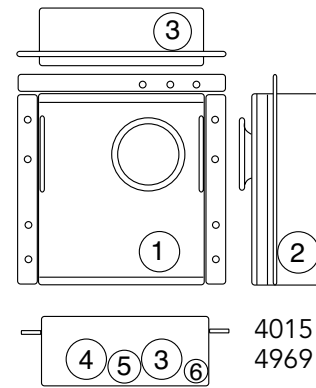

4015  
4969

## 200 Amp | 4 Terminal | Flush Mount | Ring Type | Single Position

| Catalog Number | Terminal | Service | Hub  | Connectors CU/AL |        | Bypass | Dimensions |    |     | Knockouts |    |    |    |    |   |
|----------------|----------|---------|------|------------------|--------|--------|------------|----|-----|-----------|----|----|----|----|---|
|                |          |         |      | Line             | Load   |        | D"         | W" | H"  | 1         | 2  | 3  | 4  | 5  | 6 |
| UF4517-KO      | 4        | OH      | K.O. | #6-350           | #6-350 | None   | 5½         | 8  | 15½ | 2         | ½  | ¼  | —  | —  | — |
| UF4518-KO      | 4        | OH/UG   | K.O. | #6-350           | #6-350 | None   | 5½         | 11 | 15½ | 2         | 2  | 2½ | 2½ | ½  | ¼ |
| UF4015-KO      | 4        | UG      | K.O. | #6-350           | #6-350 | None   | 5          | 14 | 16¼ | 2½        | 2½ | 2½ | 2½ | 1½ | ½ |
| UF4969-KO*     | 4        | UG      | K.O. | #6-350           | #6-350 | None   | 7½         | 14 | 16¼ | 2½        | 2½ | 2½ | 3  | 1½ | ½ |

### Notes

- **Fifth Terminal:** For field mounted fifth terminal order catalog number **K5T** to fit into square opening at the 9 o'clock position.
- **Connectors:** Extruded aluminum connectors are tin plated.
- **Sealing Rings:** Ring type units are supplied with a **MR-4** screw type sealing ring as standard.
- \* **UF4969** can only be used in a 2 x 6 wall.

Please consult serving utility for their requirements prior to ordering or installing, as specifications and approvals vary by utility, and may require local electrical inspector approval. All installations must be installed by a licensed electrician and must comply with all national and local codes, laws and regulations. Milbank reserves the right to make changes in specifications and features shown without notice or obligation.



# 16

125-200 AMP  
LINK BYPASS  
SINGLE  
POSITION

# Link Bypass Single Position

125-200 Amp | 4 & 7 Terminal | Ring Type



U3504-XL

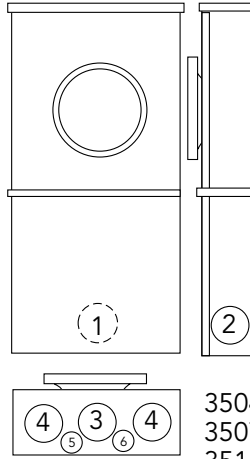

3504  
3507  
3514  
3517



U3517-XL

## 125 Amp | 4 & 7 Terminal | Ring Type | Link Bypass | Single Position

| Catalog Number | Terminal | Service | Hub  | Connectors CU/AL |        | Dimensions                    |    |                                | Knockouts |   |   |   |     |   |
|----------------|----------|---------|------|------------------|--------|-------------------------------|----|--------------------------------|-----------|---|---|---|-----|---|
|                |          |         |      | Line             | Load   | D"                            | W" | H"                             | 1         | 2 | 3 | 4 | 5   | 6 |
| U3504-XL       | 4        | OH/UG   | C.P. | #6-2/0           | #6-2/0 | 4 <sup>7</sup> / <sub>8</sub> | 10 | 18 <sup>1</sup> / <sub>2</sub> | 2         | 2 | 2 | 2 | 1/4 | — |
| U3507-XL       | 7        | OH/UG   | C.P. | #6-2/0           | #6-2/0 | 4 <sup>7</sup> / <sub>8</sub> | 10 | 21                             | 2         | 2 | 2 | 2 | 1/4 | — |

## 200 Amp | 4 & 7 Terminal | Ring Type | Link Bypass | Single Position

| Catalog Number | Terminal | Service | Hub  | Connectors CU/AL |        | Dimensions                    |    |                                | Knockouts                     |                               |                               |                               |     |     |
|----------------|----------|---------|------|------------------|--------|-------------------------------|----|--------------------------------|-------------------------------|-------------------------------|-------------------------------|-------------------------------|-----|-----|
|                |          |         |      | Line             | Load   | D"                            | W" | H"                             | 1                             | 2                             | 3                             | 4                             | 5   | 6   |
| U3514-XL       | 4        | OH/UG   | C.P. | #6-350           | #6-350 | 4 <sup>7</sup> / <sub>8</sub> | 13 | 21                             | 2 <sup>1</sup> / <sub>2</sub> | 2 <sup>1</sup> / <sub>2</sub> | 3                             | 3                             | 1/4 | 1/2 |
| U3517-XL       | 7        | OH/UG   | C.P. | #6-350           | #6-350 | 4 <sup>7</sup> / <sub>8</sub> | 13 | 24 <sup>1</sup> / <sub>2</sub> | 2 <sup>1</sup> / <sub>2</sub> | 2 <sup>1</sup> / <sub>2</sub> | 2 <sup>1</sup> / <sub>2</sub> | 2 <sup>1</sup> / <sub>2</sub> | 1/4 | 1/2 |

## Notes

- **Fifth Terminal:** For field mounted fifth terminal, order catalog number **5T8K2** for the **U3504**; order **K5T** for the **U3514**.
- **Connectors:** Extruded aluminum connectors are tin plated.
- **Sealing Rings:** Ring type units supplied with an **MR-4** screw type sealing ring as standard.
- **Link Bypass:** Links provided by utility.



Please consult serving utility for their requirements prior to ordering or installing, as specifications and approvals vary by utility, and may require local electrical inspector approval. All installations must be installed by a licensed electrician and must comply with all national and local codes, laws and regulations. Milbank reserves the right to make changes in specifications and features shown without notice or obligation.



# Lever Bypass Single Position

200 Amp | 4 & 5 Terminal | Ringless

**17**  
200 AMP  
LEVER BYPASS  
SINGLE  
POSITION

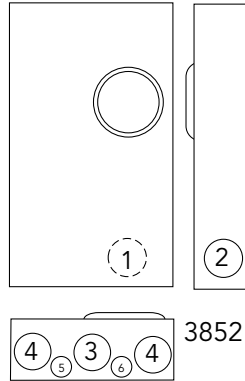

U3852-XL

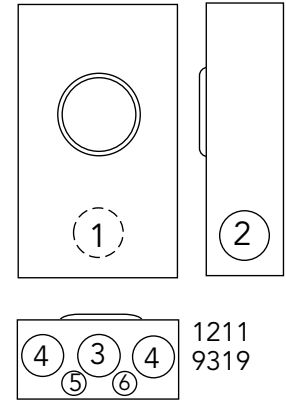

U9319-XL

200 Amp | 4 Terminal | Ringless | Non-Jaw Clamping Lever Bypass | Single Position | 1Ø3W

| Catalog Number | Terminal | Service | Hub  | Connectors CU/AL |        | Bypass | Dimensions      |    |    | Knockouts |                 |                 |                 |   |   |
|----------------|----------|---------|------|------------------|--------|--------|-----------------|----|----|-----------|-----------------|-----------------|-----------------|---|---|
|                |          |         |      | Line             | Load   |        | D"              | W" | H" | 1         | 2               | 3               | 4               | 5 | 6 |
| U3852-XL       | 4        | OH/UG   | C.P. | #2-350           | #2-350 | Lever  | 4 $\frac{7}{8}$ | 13 | 19 | 3         | 2 $\frac{1}{2}$ | 2 $\frac{1}{2}$ | 2 $\frac{1}{2}$ | ¼ | ½ |

## Notes

- **Fifth Terminal:** Fifth terminal is not available for this unit.
- **Triplex Ground:** Factory installed as standard.

200 Amp | 4 & 5 Terminal | Ringless | Non-Jaw Clamping Lever Bypass | Single Position | 1Ø3W or 3Ø3W

| Catalog Number | Terminal | Service | Hub  | Connectors CU/AL |        | Bypass | Dimensions      |    |    | Knockouts |                 |   |   |   |   |
|----------------|----------|---------|------|------------------|--------|--------|-----------------|----|----|-----------|-----------------|---|---|---|---|
|                |          |         |      | Line             | Load   |        | D"              | W" | H" | 1         | 2               | 3 | 4 | 5 | 6 |
| U1211-RXL      | 4        | OH/UG   | C.P. | #6-350           | #6-350 | Lever  | 4 $\frac{7}{8}$ | 13 | 19 | 3         | 2 $\frac{1}{2}$ | 3 | 3 | ¼ | ½ |
| U9319-XL       | 5        | OH/UG   | C.P. | #6-350           | #6-350 | Lever  | 4 $\frac{7}{8}$ | 13 | 19 | 3         | 2 $\frac{1}{2}$ | 3 | 3 | ¼ | ½ |

## Notes

- **Fifth Terminal:** For field mounted fifth terminal, order as extra **K3866** for the **U1211**.
- **Hubs:** For proper hub selection see the hub suffix chart on accessory page.
- **Bypass:** 200 amp continuous duty bypass. Lever operates bypass only. Not jaw clamping.
- **Connectors:** Units are supplied with extruded aluminum connectors and bonded, triplex neutral.

Please consult serving utility for their requirements prior to ordering or installing, as specifications and approvals vary by utility, and may require local electrical inspector approval. All installations must be installed by a licensed electrician and must comply with all national and local codes, laws and regulations. Milbank reserves the right to make changes in specifications and features shown without notice or obligation.



# Lever Bypass Single Position

125-200 Amp | 7 Terminal | Ringless



U7573-RL

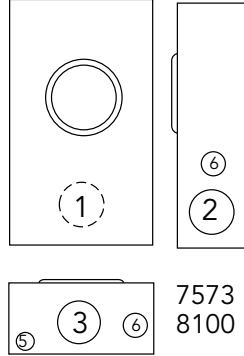

U7422-RXL

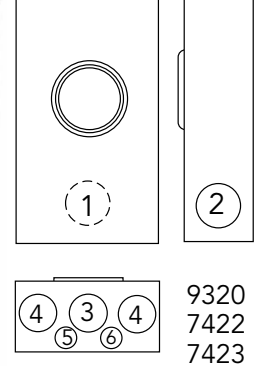

## 7 Terminal | Ringless | No Bypass | Single Position | 3Ø4W

| Catalog Number | Amp | Terminal | Service | Hub  | Connectors CU/AL |        | Bypass | Dimensions      |    |                  | Knockouts |                 |   |   |               |               |
|----------------|-----|----------|---------|------|------------------|--------|--------|-----------------|----|------------------|-----------|-----------------|---|---|---------------|---------------|
|                |     |          |         |      | Line             | Load   |        | D"              | W" | H"               | 1         | 2               | 3 | 4 | 5             | 6             |
| U8100-RL       | 125 | 7        | OH      | H.O  | #6-2/0           | #6-2/0 | None   | 4 $\frac{7}{8}$ | 10 | 18 $\frac{1}{2}$ | 2         | 2               | 2 | — | $\frac{1}{2}$ | $\frac{3}{4}$ |
| U7422-RXL      | 200 | 7        | OH/UG   | C.P. | #6-350           | #6-350 | None   | 4 $\frac{7}{8}$ | 13 | 19               | 3         | 2 $\frac{1}{2}$ | 3 | 3 | $\frac{1}{4}$ | $\frac{1}{2}$ |

## 7 Terminal | Ringless | Non-Jaw Clamping Lever Bypass | Single Position | 3Ø4W

| Catalog Number | Amp | Terminal | Service | Hub  | Connectors CU/AL |        | Bypass | Dimensions      |    |                  | Knockouts |                 |   |   |               |               |
|----------------|-----|----------|---------|------|------------------|--------|--------|-----------------|----|------------------|-----------|-----------------|---|---|---------------|---------------|
|                |     |          |         |      | Line             | Load   |        | D"              | W" | H"               | 1         | 2               | 3 | 4 | 5             | 6             |
| U7573-RL       | 125 | 7        | OH      | H.O. | #6-2/0           | #6-2/0 | Lever  | 4 $\frac{7}{8}$ | 10 | 18 $\frac{1}{2}$ | 2         | 2               | 2 | — | $\frac{1}{2}$ | $\frac{3}{4}$ |
| U9320-RXL      | 125 | 7        | OH/UG   | C.P. | #6-2/0           | #6-2/0 | Lever  | 4 $\frac{7}{8}$ | 10 | 19               | 3         | 2 $\frac{1}{2}$ | 3 | 3 | $\frac{1}{4}$ | $\frac{1}{2}$ |
| U7423-RXL      | 200 | 7        | OH/UG   | C.P. | #6-350           | #6-350 | Lever  | 4 $\frac{7}{8}$ | 13 | 19               | 3         | 2 $\frac{1}{2}$ | 3 | 3 | $\frac{1}{4}$ | $\frac{1}{2}$ |

### Notes

- **Hubs:** For proper hub selection see the hub suffix chart on accessory page.
- **Bypass:** 200 amp continuous duty bypass. Lever operates bypass only. Not jaw clamping.
- **Connectors:** Extruded aluminum connectors are tin plated. Units supplied with bonded, duplex neutral.



Please consult serving utility for their requirements prior to ordering or installing, as specifications and approvals vary by utility, and may require local electrical inspector approval. All installations must be installed by a licensed electrician and must comply with all national and local codes, laws and regulations. Milbank reserves the right to make changes in specifications and features shown without notice or obligation.

# Lever Bypass Single Position

200 Amp | 4, 5 & 7 Terminal | Ringless

**19**  
200 AMP  
LEVER BYPASS  
SINGLE  
POSITION



U9701-RXL

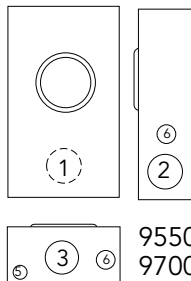

9550  
9700



U9800-RRL

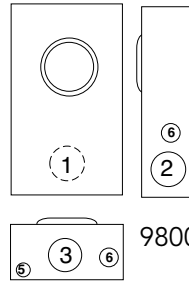

9800



U9551-RXL

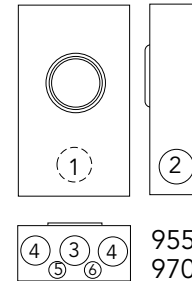

9551  
9701

200 Amp | 4 Terminal | Ringless | Jaw Clamping Lever Bypass | Single Position | 1Ø3W or 3Ø3W

| Catalog Number | Terminal | Service | Hub  | Connectors CU/AL |        | Bypass | Dimensions      |    |                  | Knockouts |                 |   |   |               |               |
|----------------|----------|---------|------|------------------|--------|--------|-----------------|----|------------------|-----------|-----------------|---|---|---------------|---------------|
|                |          |         |      | Line             | Load   |        | D"              | W" | H"               | 1         | 2               | 3 | 4 | 5             | 6             |
| U9800-RRL*     | 4        | OH      | H.O. | #6-350           | #6-350 | Lever  | 4 $\frac{7}{8}$ | 10 | 18 $\frac{1}{2}$ | 3         | 2 $\frac{1}{2}$ | 3 | — | $\frac{1}{2}$ | $\frac{3}{4}$ |
| U9801-RXL*     | 4        | OH/UG   | C.P. | #6-350           | #6-350 | Lever  | 4 $\frac{7}{8}$ | 13 | 19               | 3         | 2 $\frac{1}{2}$ | 3 | 3 | $\frac{1}{4}$ | $\frac{1}{2}$ |

200 Amp | 5 Terminal | Ringless | Jaw Clamping Lever Bypass | Single Position | 1Ø3W or 3Ø3W

| Catalog Number | Terminal | Service | Hub  | Connectors CU/AL |        | Bypass | Dimensions      |    |                  | Knockouts |                 |   |   |               |               |
|----------------|----------|---------|------|------------------|--------|--------|-----------------|----|------------------|-----------|-----------------|---|---|---------------|---------------|
|                |          |         |      | Line             | Load   |        | D"              | W" | H"               | 1         | 2               | 3 | 4 | 5             | 6             |
| U9550-RRL      | 5        | OH      | H.O. | #6-350           | #6-350 | Lever  | 4 $\frac{7}{8}$ | 10 | 18 $\frac{1}{2}$ | 3         | 2 $\frac{1}{2}$ | 3 | — | $\frac{1}{2}$ | $\frac{3}{4}$ |
| U9551-RXL      | 5        | OH/UG   | C.P. | #6-350           | #6-350 | Lever  | 4 $\frac{7}{8}$ | 13 | 19               | 3         | 2 $\frac{1}{2}$ | 3 | 3 | $\frac{1}{4}$ | $\frac{1}{2}$ |

200 Amp | 7 Terminal | Ringless | Jaw Clamping Lever Bypass | Single Position | 3Ø4W

| Catalog Number | Terminal | Service | Hub  | Connectors CU/AL |        | Bypass | Dimensions      |    |                  | Knockouts |                 |   |   |               |               |
|----------------|----------|---------|------|------------------|--------|--------|-----------------|----|------------------|-----------|-----------------|---|---|---------------|---------------|
|                |          |         |      | Line             | Load   |        | D"              | W" | H"               | 1         | 2               | 3 | 4 | 5             | 6             |
| U9700-RRL      | 7        | OH      | H.O. | #6-350           | #6-350 | Lever  | 4 $\frac{7}{8}$ | 10 | 18 $\frac{1}{2}$ | 3         | 2 $\frac{1}{2}$ | 3 | — | $\frac{1}{2}$ | $\frac{3}{4}$ |
| U9701-RXL      | 7        | OH/UG   | C.P. | #6-350           | #6-350 | Lever  | 4 $\frac{7}{8}$ | 13 | 19               | 3         | 2 $\frac{1}{2}$ | 3 | 3 | $\frac{1}{4}$ | $\frac{1}{2}$ |

## Notes

- **Hubs:** For proper hub selection see the hub suffix chart on accessory page.
- **Bypass:** Lever supplies clamping action and also operates bypass device.
- **Connectors:** Extruded aluminum connectors are tin plated. **U9550** and **U9551** units are supplied with duplex neutral, with removable bonding strap for insulated neutral. **U9700** series units are supplied with duplex neutral.
- \* Internal Hex Connectors. For main and/or service disconnect, use with **U5484-O** enclosed circuit breaker.

Please consult serving utility for their requirements prior to ordering or installing, as specifications and approvals vary by utility, and may require local electrical inspector approval. All installations must be installed by a licensed electrician and must comply with all national and local codes, laws and regulations. Milbank reserves the right to make changes in specifications and features shown without notice or obligation.



# Lever Bypass Single Position

320 Amp | 4 Terminal | Ringless



U1797-O-K3L-K2L

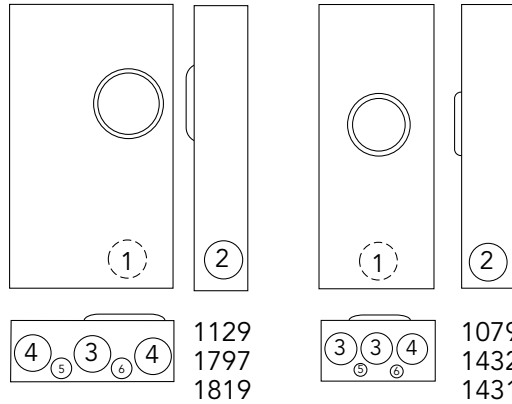

U1129-O-K3L-K2L

## 320 Amp | 4 Terminal | Ringless | Lever Bypass | Single Position

| Catalog Number  | Terminal | Service | Hub   | Connectors CU/AL             |                | Bypass | Dimensions |    |        | Knockouts |       |   |   |     |     |
|-----------------|----------|---------|-------|------------------------------|----------------|--------|------------|----|--------|-----------|-------|---|---|-----|-----|
|                 |          |         |       | Line                         | Load           |        | D"         | W" | H"     | 1         | 2     | 3 | 4 | 5   | 6   |
| U1079-R         | 4        | OH      | H.O.  | 3/8" x 16 Studs              |                | Lever  | 4 7/8      | 13 | 38 3/4 | 3 1/2     | 2 1/2 | 3 | 3 | 1/4 | 1/2 |
| U1431-R*        | 4        | OH/UG   | H.O.  | 3/8" x 16 Studs              |                | None   | 4 7/8      | 13 | 38 3/4 | 3 1/2     | 2 1/2 | 3 | 3 | 1/4 | 1/2 |
| U1129-O-K3L-K2L | 4        | UG      | Blank | (1) #4-600 or<br>(2) 1/0-250 | Twin<br>#6-350 | Lever  | 4 7/8      | 15 | 30     | 3         | 2 1/2 | 3 | 3 | 1/4 | 1/2 |
| U1432-O*        | 4        | UG      | Blank | 3/8" x 16 Studs              |                | None   | 4 7/8      | 13 | 29 3/4 | 3 1/2     | 2 1/2 | 3 | 3 | 1/4 | 1/2 |
| U1819-X*        | 4        | UG      | C.P.  | 3/8" x 16 Studs              |                | None   | 4 7/8      | 15 | 30     | 3         | 3     | 3 | 3 | 1/4 | 1/2 |
| U1797-O-K3L-K2L | 4        | UG      | Blank | (1) #4-600 or<br>(2) 1/0-250 | Twin<br>#6-35  | Lever  | 4 7/8      | 15 | 30     | 3         | 3     | 3 | 3 | 1/4 | 1/2 |

### Notes

- **Hubs:** For proper hub selection, see the hub suffix chart on the accessory page.
- **\*Bypass:** Lever supplies clamping action on meter spades only on the **U1431**, **U1432** and **U1819**. Lever supplies clamping action and also operates bypass device on the **U1079**, **U1129** & **U1797**.
- **Connector Kits:** Stud type units are supplied with 3/8" x 16 hex head nuts with Belleville washers. Order two connector kits to cover both line and load. Order **K1539** (single #350), **K1540** (single #600) or **K1350** (twin #350). See accessories page.  
**Note:** The **U1129** unit has a single connector on the line side only.
- **Fifth Terminal:** For field mounted fifth terminal, order as extra **K3866** for the **U1079** & **U1431**. Order as extra K3865 for units **U1129**, **U1432**, **U1819**, and **U1797**.
- **Lug Size Range:** See accessories page for lug size range for the U1129 & U1797 units.



Please consult serving utility for their requirements prior to ordering or installing, as specifications and approvals vary by utility, and may require local electrical inspector approval. All installations must be installed by a licensed electrician and must comply with all national and local codes, laws and regulations. Milbank reserves the right to make changes in specifications and features shown without notice or obligation.

# Link Bypass Single Position

320 Amp | 4 Terminal | Ring Type

**21**  
320 AMP  
LINK BYPASS  
SINGLE  
POSITION



U3548-X

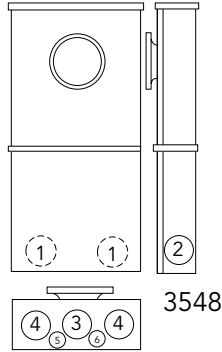

U5056-O

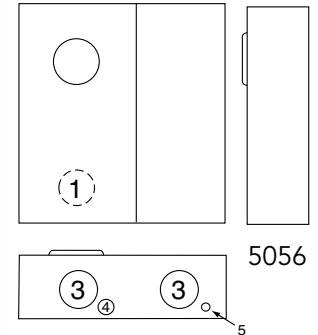

320 Amp | 4 Terminal | Ring Type | Link Bypass | Single Position | 1Ø3W

| Catalog Number | Terminal | Service | Hub   | Connectors CU/AL                     |                           | Bypass | Dimensions |    |    | Knockouts |   |   |   |   |   |
|----------------|----------|---------|-------|--------------------------------------|---------------------------|--------|------------|----|----|-----------|---|---|---|---|---|
|                |          |         |       | Line                                 | Load                      |        | D"         | W" | H" | 1         | 2 | 3 | 4 | 5 | 6 |
| U3548-X*       | 4        | OH/UG   | C.P.  | Single = 4-600<br>Parallel = 1/0-250 |                           | Link   | 6          | 14 | 33 | 3         | 3 | 3 | 3 | ¼ | ½ |
| U5056-O        | 4        | UG      | Blank | 1/2"x13 Studs                        | #4-600 or<br>Twin 1/0-250 | Link   | 6          | 24 | 32 | 3         | — | 4 | ½ | ¼ | — |

## Notes

- **Sealing Ring:** Ring type units are supplied with an **MR-4**, screw type, sealing ring as standard.
- **Triple Tap Lug:** For triple tap lug kit order **K5049**, wire range **#6-250** kcmil.
- **Link Bypass:** Links provided by utility.
- \* **Flush Mount Kit:** For field mounted flush mount kit order **K4086**.

Please consult serving utility for their requirements prior to ordering or installing, as specifications and approvals vary by utility, and may require local electrical inspector approval. All installations must be installed by a licensed electrician and must comply with all national and local codes, laws and regulations. Milbank reserves the right to make changes in specifications and features shown without notice or obligation.



# Lever Bypass Single Position

320 Amp | 7 Terminal | Ringless



U2120-X

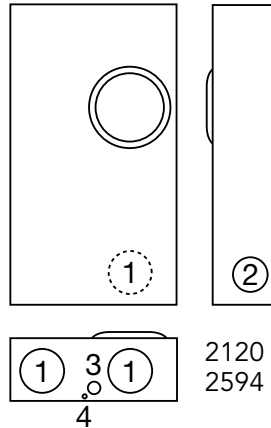

2120  
2594



U2827-X

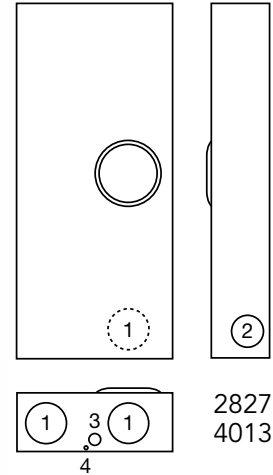

2827  
4013

320 Amp | 7 Terminal | Ringless | Lever Bypass | Single Position | Side Wireway

| Catalog Number | Terminal | Service | Hub  | Connectors CU/AL |      | Bypass     | Dimensions |     |     | Knockouts |   |   |   |
|----------------|----------|---------|------|------------------|------|------------|------------|-----|-----|-----------|---|---|---|
|                |          |         |      | Line             | Load |            | D"         | W"  | H"  | 1         | 2 | 3 | 4 |
| U4013-X        | 7        | OH/UG   | C.P. | 3/8"x16 Studs    |      | Lever      | 6½         | 19  | 34½ | 4         | 3 | 1 | ¼ |
| U2594-X        | 7        | OH/UG   | C.P. | 3/8"x16 Studs    |      | Lever      | 6½         | 19¾ | 34½ | 4         | 3 | 1 | ¼ |
| U2827-X*       | 7        | OH/UG   | C.P. | 3/8"x16 Studs    |      | non-bypass | 6½         | 17¾ | 31  | 4         | 3 | 1 | ¼ |
| U2120-X        | 7        | UG      | C.P. | 3/8"x16 Studs    |      | Lever      | 6½         | 17¾ | 31¾ | 4         | 3 | 1 | ¼ |

## Notes

- **Bypass:** Lever supplies clamping action on meter spades and operates bypass device.
- \*U2827 has lever with jaw clamping capabilities but no bypass.
- **Connector Kits:** Stud type units are supplied with 3/8"x16 hex head nuts with Belleville washers. Order two connector kits to cover both line and load. For single lug connector kits for the U2120 and U2594 units, order as extra K3082 (350 kcmil) or K3441 (600 kcmil). For twin lug connectors order as extra: K3442 (350 kcmil). Separate kits are required for both line and load.



Please consult serving utility for their requirements prior to ordering or installing, as specifications and approvals vary by utility, and may require local electrical inspector approval. All installations must be installed by a licensed electrician and must comply with all national and local codes, laws and regulations. Milbank reserves the right to make changes in specifications and features shown without notice or obligation.

# Service Entrance

100-200 Amp | 4 Terminal | Main Breaker

**23**  
SERVICE  
ENTRANCE



USE-AP-200-ML

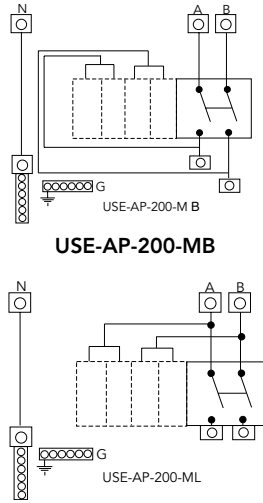
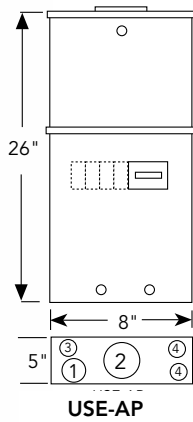

USE-AP-200-ML

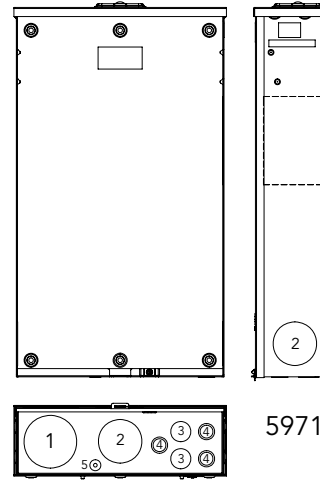

U5971-XL-100



U5971-XL-200

200 Amp | Breaker Enclosure | 1Ø3W | 120/240 Volt | 10K AIC Rating

| Catalog Number | Terminal | Service | Hub | Connectors CU/AL |        | Dimensions |    |    | Knockouts |   |   |   |
|----------------|----------|---------|-----|------------------|--------|------------|----|----|-----------|---|---|---|
|                |          |         |     | Line             | Load   | D"         | W" | H" | 1         | 2 | 3 | 4 |
| USE-AP-200-MB  | 4        | OH      | 2"  | #4-250           | #4-250 | 5          | 8  | 26 | 1         | 2 | ¾ | ¾ |
| USE-AP-200-ML  | 4        | OH      | 2"  | #4-250           | #4-250 | 5          | 8  | 26 | 1         | 2 | ¾ | ¾ |

## Notes

- **USE-AP-200-MB:** 200 amp main wired in series with plug-in style bus. **UQFP-M-200** factory installed. Additional 4 branch circuits available for (1) two-pole and (2) one-pole, or (4) one pole breakers. **One 2" hub included.**
- **USE-AP-200-ML:** 200 amp main wired in series with plug-in style bus. **UQFP-200** factory installed. Additional 4 branch circuits available for (1) two-pole and (2) one-pole, or (4) one pole breakers. **One 2" hub included.**

100-200 Amp | Load Center with Main Breaker | 120/240V

| Catalog Number | Main Breaker Amp | Branch Circuits | Service | Hub  | Dimensions |     |     | Knockouts |    |   |     |     |
|----------------|------------------|-----------------|---------|------|------------|-----|-----|-----------|----|---|-----|-----|
|                |                  |                 |         |      | D"         | W"  | H"  | 1         | 2  | 3 | 4   | 5   |
| U5971-XL-100   | 100              | 10              | OH/UG   | C.P. | 4½         | 14⅞ | 25⅙ | 3         | 2½ | 1 | ½,¾ | ¼,½ |
| U5971-XL-200   | 200              | 8               | OH/UG   | C.P. | 4½         | 14⅞ | 25⅙ | 3         | 2½ | 1 | ½,¾ | ¼,½ |

## Notes

- **AIC Rating:** 22K AIC rating.
- **Line Terminals:** As specified on circuit breaker (300 kcmil max).
- **Load Terminals:** As specified on circuit breakers (#1 AWG max).
- **Breaker Interlock:** Order **K5815** for 200A or 150A to 100A breakers (large frame to small frame). Order **K5820** for 200A or 150A to 200A or 150A breakers (large frame to large frame). Order **K5830** for 100A to 100A (small frame to small frame).

Please consult serving utility for their requirements prior to ordering or installing, as specifications and approvals vary by utility, and may require local electrical inspector approval. All installations must be installed by a licensed electrician and must comply with all national and local codes, laws and regulations. Milbank reserves the right to make changes in specifications and features shown without notice or obligation.





**U3574-RL-200**

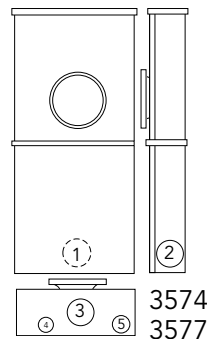
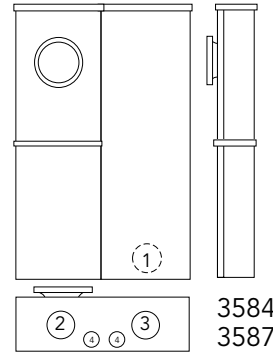

**200 Amp | 4 Terminal | Ring Type | 240 Volt**

| Catalog Number | Terminal | Service | Breaker | Connectors CU/AL |        | Dimensions      |                  |    | Knockouts |   |                 |               |               |   |
|----------------|----------|---------|---------|------------------|--------|-----------------|------------------|----|-----------|---|-----------------|---------------|---------------|---|
|                |          |         |         | Line             | Load   | D"              | W"               | H" | 1         | 2 | 3               | 4             | 5             | 6 |
| U3574-RL-200   | 4        | OH      | 200A-2P | #2-350           | #3-300 | 4 $\frac{1}{8}$ | 8                | 30 | 2         | 2 | 2 $\frac{1}{2}$ | $\frac{1}{4}$ | $\frac{1}{2}$ | — |
| U3584-O-200    | 4        | UG      | 200A-2P | #6-350           | #3-300 | 5 $\frac{1}{2}$ | 14 $\frac{1}{8}$ | 26 | 3         | 3 | 3               | $\frac{1}{2}$ | —             | — |

**200 Amp | 7 Terminal | Ring Type | 240 Volt**

| Catalog Number | Terminal | Service | Breaker | Connectors CU/AL |        | Dimensions      |                  |    | Knockouts |   |                 |               |               |   |
|----------------|----------|---------|---------|------------------|--------|-----------------|------------------|----|-----------|---|-----------------|---------------|---------------|---|
|                |          |         |         | Line             | Load   | D"              | W"               | H" | 1         | 2 | 3               | 4             | 5             | 6 |
| U3577-RL-200   | 7        | OH      | 200A-3P | #2-350           | #3-300 | 4 $\frac{7}{8}$ | 10               | 34 | 2         | 2 | 2 $\frac{1}{2}$ | $\frac{1}{4}$ | $\frac{1}{2}$ | — |
| U3587-O-200    | 7        | UG      | 200A-3P | #6-350           | #3-300 | 5 $\frac{1}{2}$ | 14 $\frac{1}{8}$ | 26 | 3         | 3 | 3               | $\frac{1}{2}$ | —             | — |

**Notes**

- **Breakers:** Units are supplied with bolt-on 200 amp circuit breakers where specified above.
- **Sealing Rings:** Units are supplied with an **MR-4** screw type sealing ring.



Please consult serving utility for their requirements prior to ordering or installing, as specifications and approvals vary by utility, and may require local electrical inspector approval. All installations must be installed by a licensed electrician and must comply with all national and local codes, laws and regulations. Milbank reserves the right to make changes in specifications and features shown without notice or obligation.



# Meter Main with Load Center

100–200 Amp | 4 & 5 Terminal | Ringless & Ring Type

**25**  
100-200 AMP  
METER MAINS

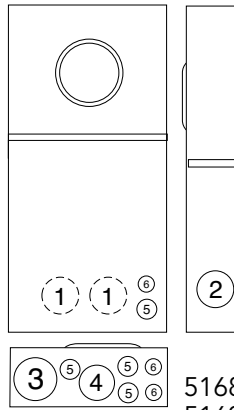

5168 5268  
5169 5269



U5268-XTL-200-KK

U5168-XTL-200

## Generator Interlock



**K5815** - large QN with small frame Q

**K5820** - large frame QN with large frame QN

**K5830** - small frame Q to small frame Q

100–200 Amp | Meter Mains | 120/240 Volts | 1Ø3W | Overhead/Underground

| Catalog Number       | Terminal | Amp | Circuits | Hub  | Connectors<br>Line | Bypass | Dimensions |     |    | Knockouts |   |   |    |   |   |
|----------------------|----------|-----|----------|------|--------------------|--------|------------|-----|----|-----------|---|---|----|---|---|
|                      |          |     |          |      |                    |        | D"         | W"  | H" | 1         | 2 | 3 | 4  | 5 | 6 |
| U5168-XTL-100*       | 4        | 100 | 10       | C.P. | #6-350             | None   | 4½         | 14⅞ | 32 | 2         | 2 | 3 | 2½ | 1 | ¾ |
| U5168-XTL-150*       | 4        | 150 | 8        | C.P. | #6-350             | None   | 4½         | 14⅞ | 32 | 2         | 2 | 3 | 2½ | 1 | ¾ |
| U5168-XTL-200*       | 4        | 200 | 8        | C.P. | #6-350             | None   | 4½         | 14⅞ | 32 | 2         | 2 | 3 | 2½ | 1 | ¾ |
| U5168-XTL-100-KK*    | 4        | 100 | 10       | C.P. | #6-350             | Horn   | 4½         | 14⅞ | 32 | 2         | 2 | 3 | 2½ | 1 | ¾ |
| U5168-XTL-150-KK*    | 4        | 150 | 8        | C.P. | #6-350             | Horn   | 4½         | 14⅞ | 32 | 2         | 2 | 3 | 2½ | 1 | ¾ |
| U5168-XTL-200-KK*    | 4        | 200 | 8        | C.P. | #6-350             | Horn   | 4½         | 14⅞ | 32 | 2         | 2 | 3 | 2½ | 1 | ¾ |
| U5168-XTL-100-KK-5T* | 5        | 100 | 10       | C.P. | #6-350             | Horn   | 4½         | 14⅞ | 32 | 2         | 2 | 3 | 2½ | 1 | ¾ |
| U5168-XTL-150-KK-5T* | 5        | 150 | 8        | C.P. | #6-350             | Horn   | 4½         | 14⅞ | 32 | 2         | 2 | 3 | 2½ | 1 | ¾ |
| U5169-XTL-100        | 4        | 100 | 10       | C.P. | #6-350             | None   | 4½         | 14⅞ | 32 | 2         | 2 | 3 | 2½ | 1 | ¾ |
| U5169-XTL-150        | 4        | 150 | 8        | C.P. | #6-350             | None   | 4½         | 14⅞ | 32 | 2         | 2 | 3 | 2½ | 1 | ¾ |
| U5169-XTL-200        | 4        | 200 | 8        | C.P. | #6-350             | None   | 4½         | 14⅞ | 32 | 2         | 2 | 3 | 2½ | 1 | ¾ |
| U5268-XTL-150*       | 4        | 150 | 20       | C.P. | #6-350             | None   | 4½         | 14⅞ | 32 | 2         | 2 | 3 | 2½ | 1 | ¾ |
| U5268-XTL-200*       | 4        | 200 | 20       | C.P. | #6-350             | None   | 4½         | 14⅞ | 32 | 2         | 2 | 3 | 2½ | 1 | ¾ |
| U5268-XTL-150-KK*    | 4        | 150 | 20       | C.P. | #6-350             | Horn   | 4½         | 14⅞ | 32 | 2         | 2 | 3 | 2½ | 1 | ¾ |
| U5268-XTL-200-KK*    | 4        | 200 | 20       | C.P. | #6-350             | Horn   | 4½         | 14⅞ | 32 | 2         | 2 | 3 | 2½ | 1 | ¾ |
| U5269-XTL-200        | 4        | 200 | 20       | C.P. | #6-350             | None   | 4½         | 14⅞ | 32 | 2         | 2 | 3 | 2½ | 1 | ¾ |

## Notes

- **Hubs:** Supplied with (2) closing plates packed inside. Order hubs as a separate item. See accessory page for hub options.
- **Interior:** U5168 units have 8-circuit interior; U5268 units have 20-circuit interior
- **Fifth Terminal:** Order K5T and field install for 208Y/120 network systems. Installs in the 9 o'clock position only.
- **Branch Breakers:** Series rated 22K AIC with Milbank QNR2200H main installed.
- **Interlock Kit:** For generator auxiliary circuit breaker interlock, order K5815 for large QN with small frame Q; order K5820 for large frame QN with large frame QN; order K5830 for small frame Q with small frame Q.
- **Sub-Feed Lugs:** #6-350 kcmil sub-feed lugs provided on 8 and 10 circuit interior. **Not available on 20 circuit interior.**
- Amp rating limited to main breaker rating.

### \* Ringless

Please consult serving utility for their requirements prior to ordering or installing, as specifications and approvals vary by utility, and may require local electrical inspector approval. All installations must be installed by a licensed electrician and must comply with all national and local codes, laws and regulations. Milbank reserves the right to make changes in specifications and features shown without notice or obligation.



# Heavy Duty Lever Bypass Meter Mains

320 Amp | 4 Terminal | Ringless



U5059-X-2/200

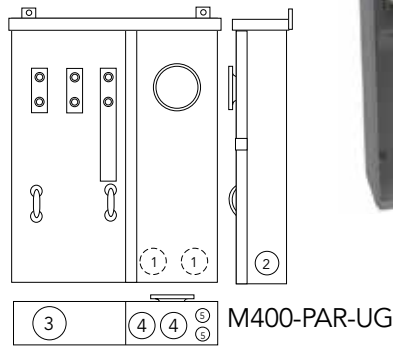
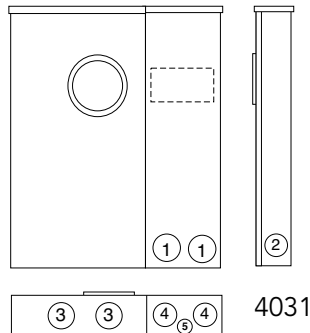
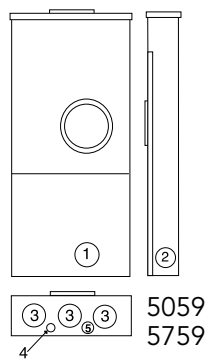

U4031-O-2/200

320 Amp | 4 Terminal | Ringless | 1Ø3W | 22K AIC Rating

| Catalog Number              | Terminal | Service | Primary Disconnect             | Secondary Disconnect           | Bypass | Dimensions                    |                                |    | Knockouts                     |                               |   |   |   |
|-----------------------------|----------|---------|--------------------------------|--------------------------------|--------|-------------------------------|--------------------------------|----|-------------------------------|-------------------------------|---|---|---|
|                             |          |         |                                |                                |        | D"                            | W"                             | H" | 1                             | 2                             | 3 | 4 | 5 |
| U5759-X-2/200* <sup>2</sup> | 4        | OH/UG   | 200 Amp/2 Pole Circuit Breaker | 200 Amp/2 Pole Circuit Breaker | None   | 4 <sup>7</sup> / <sub>8</sub> | 15                             | 42 | 2 <sup>1</sup> / <sub>2</sub> | 2 <sup>1</sup> / <sub>2</sub> | 3 | ¼ | ½ |
| U5059-X-2/200 <sup>2</sup>  | 4        | OH/UG   | 200 Amp/2 Pole Circuit Breaker | 200 Amp/2 Pole Circuit Breaker | Lever  | 4 <sup>7</sup> / <sub>8</sub> | 15                             | 42 | 2 <sup>1</sup> / <sub>2</sub> | 2 <sup>1</sup> / <sub>2</sub> | 3 | ¼ | ½ |
| U4031-O-2/200 <sup>2</sup>  | 4        | UG      | 200 Amp/2 Pole Circuit Breaker | 200 Amp/2 Pole Circuit Breaker | Lever  | 5 <sup>3</sup> / <sub>4</sub> | 25                             | 30 | 3                             | 3                             | 4 | 3 | ½ |
| M400-PAR-UG** <sup>1</sup>  | 4        | UG      | 200 Amp/2 Pole Circuit Breaker | <b>See Note<sup>1</sup></b>    | Lever  | 6 <sup>1</sup> / <sub>8</sub> | 22 <sup>1</sup> / <sub>8</sub> | 36 | 2                             | 2                             | 4 | 2 | ¾ |

## Notes

- **Amperage Rating:** 400 amp, 320 amp continuous.
- **Neutral:** Bonded neutral and ground factory installed.
- **Flush Mount:** Flush mounting available on underground units. Order catalog number **FK-M400-UG** separately.
- **Short Circuit Current Withstand Rating:** 22K AIC Standard.
- **Bypass:** Lever supplies clamping action and operates bypass device.
- **Fifth Terminal:** For field installed fifth terminal for the **U5059** & **U5759**, order separately catalog number **K3866**.
- **Conversion Kit:** To field convert **M400** UG units to OH, order **K4787-F**. Includes connectors (#2-600).

<sup>1</sup> 200 amp primary disconnect factory installed. Order secondary disconnect separately. Specify **UQFPH-100, 125, 150, 175** or **200**.

<sup>2</sup> **Line Side Connector Kits:** Two 1/2" studs per phase on 1-3/4" centers. Factory installed for the **U5759**, for the **U5059** order anti-rotation connector kit **K1540L** to accommodate #4-600 kcmil single or **K1350L** for twin 350 kcmil connectors.

\* Lever supplies clamping action only—does NOT operate bypass on the **U5759**.

\*\* **Lug Kit:** Mechanical lug kit available for **M400-APS-UG**, order **K4920** (#2-500).



Please consult serving utility for their requirements prior to ordering or installing, as specifications and approvals vary by utility, and may require local electrical inspector approval. All installations must be installed by a licensed electrician and must comply with all national and local codes, laws and regulations. Milbank reserves the right to make changes in specifications and features shown without notice or obligation.

# Meter Main with Split Load

320 Amp | 4 Terminal | Ring Type

**27**  
320 AMP  
METER MAINS



M400-APS-BS

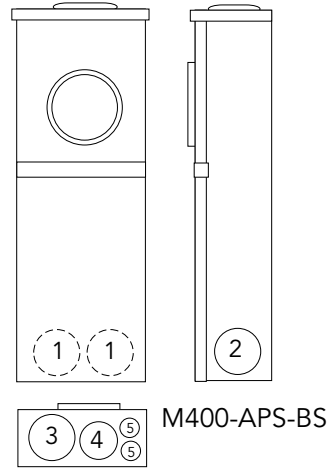

320 Amp | 4 Terminal | Ring Type | 1Ø3W | Type 3R | 120/240 Volt

| Catalog Number | Terminal | Service | Primary Disconnect             | Secondary Disconnect  | Bypass | Dimensions                    |                                |                                | Knockouts                     |                               |   |                               |     |   |
|----------------|----------|---------|--------------------------------|-----------------------|--------|-------------------------------|--------------------------------|--------------------------------|-------------------------------|-------------------------------|---|-------------------------------|-----|---|
|                |          |         |                                |                       |        | D"                            | W"                             | H"                             | 1                             | 2                             | 3 | 4                             | 5   | 6 |
| M400-APS       | 4        | OH      | 200 Amp/2 Pole Circuit Breaker | See Note <sup>1</sup> | None   | 6 <sup>1</sup> / <sub>8</sub> | 9 <sup>1</sup> / <sub>2</sub>  | 47 <sup>1</sup> / <sub>8</sub> | 2                             | 2                             | 2 | 1 <sup>1</sup> / <sub>2</sub> | 3/4 | — |
| M400-APS-BS    | 4        | OH      | 200 Amp/2 Pole Circuit Breaker | See Note <sup>1</sup> | Link   | 6                             | 11 <sup>1</sup> / <sub>2</sub> | 47                             | 2 <sup>1</sup> / <sub>2</sub> | 2 <sup>1</sup> / <sub>2</sub> | 3 | 3                             | 3/4 | — |

## Notes

- **Amperage Rating:** 400 amp, 320 amp continuous.
- **Neutral:** Bonded neutral and ground factory Installed.
- **Line Side Connectors:** Connectors provided for 4-600 or twin 1/0-250.
- **Overhead:** Overhead units include one 3" hub.

<sup>1</sup> 200 amp primary disconnect factory installed. Order secondary disconnect separately. Specify **UQFPH-100, 125, 150, 175** or **200**.

Please consult serving utility for their requirements prior to ordering or installing, as specifications and approvals vary by utility, and may require local electrical inspector approval. All installations must be installed by a licensed electrician and must comply with all national and local codes, laws and regulations. Milbank reserves the right to make changes in specifications and features shown without notice or obligation.



# Meter Main with Split Load

320 Amp | 4 Terminal | Ring Type



M400-UG-APS-F

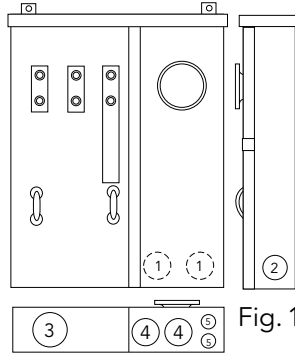

Fig. 1

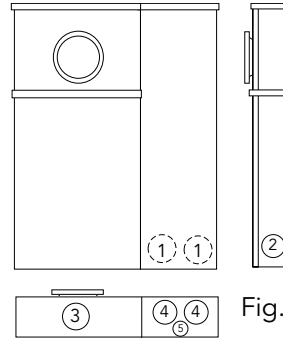

Fig. 2



U3251-O-200-CB

320 Amp | 4 Terminal | Ring Type | 1Ø3W | Type 3R | 120/240 VAC

| Catalog Number                 | Terminal | Service | Primary Disconnect             | Secondary Disconnect           | Bypass | Dimensions |     |     | Knockouts |   |   |    |   | Fig. |
|--------------------------------|----------|---------|--------------------------------|--------------------------------|--------|------------|-----|-----|-----------|---|---|----|---|------|
|                                |          |         |                                |                                |        | D"         | W"  | H"  | 1         | 2 | 3 | 4  | 5 |      |
| M400-UG-APS-F <sup>1</sup>     | 4        | UG      | 200 Amp/2 Pole Circuit Breaker | See Note <sup>1</sup>          | None   | 6½         | 22½ | 36  | 2         | 2 | 4 | 2  | ¾ | 1    |
| M400-UG-APS-F-BS <sup>1</sup>  | 4        | UG      | 200 Amp/2 Pole Circuit Breaker | See Note <sup>1</sup>          | Link   | 6          | 29  | 41⅞ | 2         | 2 | 4 | 2  | ¾ | 1    |
| M400-UG-APS-P <sup>2</sup>     | 4        | UG      | 200 Amp 2 Pole-T-Fuse          | 200 Amp 2 Pole-T-Fuse          | None   | 6½         | 22½ | 36  | 2         | 2 | 4 | 2  | ¾ | 1    |
| M400-UG-APS-LC <sup>4</sup>    | 4        | UG      | 200 Amp/2 Pole Circuit Breaker | 200 Amp/2 Pole Circuit Breaker | None   | 6          | 29  | 41⅞ | 2½        | 1 | 4 | 2½ | ¾ | 2    |
| M400-UG-APS-LC-BS <sup>4</sup> | 4        | UG      | 200 Amp/2 Pole Circuit Breaker | 200 Amp/2 Pole Circuit Breaker | Link   | 6          | 29  | 41⅞ | 2½        | 1 | 4 | 2½ | ¾ | 2    |
| U3251-O-200-CB <sup>3</sup>    | 4        | UG      | 200 Amp/2 Pole Circuit Breaker | 200 Amp/2 Pole Circuit Breaker | Link   | 6¾         | 24  | 40¼ | 3         | 3 | 4 | 3  | ⅞ | 2    |

## Notes

- **Amperage Rating:** 400 amp, 320 amp continuous.
- **EUSERC:** Meets EUSERC requirements. Consult local utility for acceptability before ordering or installing.
- **Neutral:** Bonded neutral and ground factory Installed.
- **Line Side Connectors:** Two 1/2" studs per phase on 1-3/4" centers.
- **Load Side Connectors:** 1/0-300
- **Flush Mount:** Flush mount kit included with M400-UG-APS-F, M400-UG-APS-FBS, M400-UG-APS-LC and M400-UG-APS-LC-BS. Available for other underground units. Order catalog number **FK-M400-UG** separately.
- **Short Circuit Current Withstand Rating:** 22K AIC standard, 200k aic standard on T-fuse models.
- **Lug Kit:** Mechanical lug kit available, order **K4920** (#2-500).
- **Conversion Kit:** To field convert M400 UG units to OH, order **K4787-F**.

<sup>1</sup> 200 amp primary disconnect factory installed. Order secondary disconnect separately. Specify **UQFPH-100, 125, 150, 175** or **200**.

<sup>2</sup> Two 200 amp T-fuse pull-outs factory installed as primary and secondary disconnects.

<sup>3</sup> Two 200 amp 2-pole bolt-on **UQFBH** main breakers factory installed.

<sup>4</sup> **Breakers:** Two 200 amp 2-pole main breakers factory installed, and semi-flush flange kit packed inside meter section. Universal Copper 24/40 Circuit interior accepts Challenger, GE, Murray, Siemens/ITE, and Cutler-Hammer/Westinghouse universal type plug-in branch circuit breakers.



Please consult serving utility for their requirements prior to ordering or installing, as specifications and approvals vary by utility, and may require local electrical inspector approval. All installations must be installed by a licensed electrician and must comply with all national and local codes, laws and regulations. Milbank reserves the right to make changes in specifications and features shown without notice or obligation.

# Meter Main Combination

320 Amp | 4 Terminal | Ring Type

**29**  
320 AMP  
METER MAINS



**M401-UG**

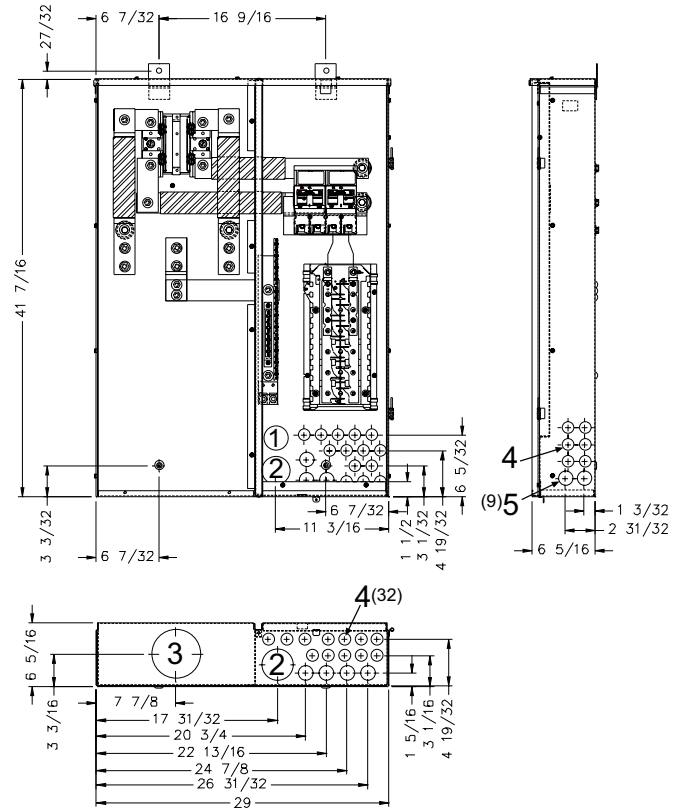
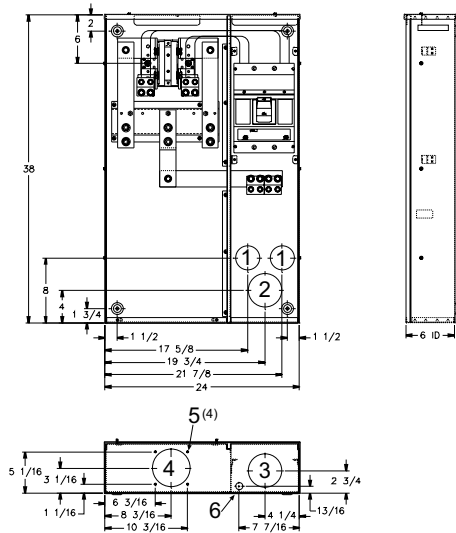

**M400-UG-APS-LC**  
(see previous page for details)

## 320 Amp Main Breaker | 4 Terminal | Ring Type | 1Ø3W | Type 3R | 120/240 Volt

| Catalog Number | Terminal | Service | Main Disconnect               | Bypass | Connectors CU/AL |       | Dimensions |    |    | Knockouts |    |    |   |   |   |
|----------------|----------|---------|-------------------------------|--------|------------------|-------|------------|----|----|-----------|----|----|---|---|---|
|                |          |         |                               |        | Line             | Load  | D"         | W" | H" | 1         | 2  | 3  | 4 | 5 | 6 |
| M401-UG        | 4        | UG      | (1) 400 Amp<br>2 Pole Breaker | None   | Studs            | C.B.* | 6          | 24 | 38 | 2½        | 3½ | 3½ | 4 | ¼ | ½ |
| M401-UG-BS     | 4        | UG      | (1) 400 Amp<br>2 Pole Breaker | Link   | Studs            | C.B.* | 6          | 24 | 38 | 2½        | 3½ | 3½ | 4 | ¼ | ½ |

### Notes

- **Amperage Rating:** 400 amp, 320 amp continuous.
  - **Neutral:** Bonded neutral and ground factory installed.
  - **Load Side Connectors:** Two 1/2" studs per phase on 1-3/4" centers.
  - **Lug Kit:** Mechanical lug kit available, order **K4920** (#2-500).
  - **Flush Mount:** Flush mounting available on underground units. Order catalog number **FK-M400-UG** separately.
  - **Short Circuit Current Withstand Rating:** 22K AIC standard.
- \* C.B. load side (1) or (2) copper conductors 3/0-500, (2) aluminum conductors 4/0-500 or (1) aluminum conductor 250-500.

Please consult serving utility for their requirements prior to ordering or installing, as specifications and approvals vary by utility, and may require local electrical inspector approval. All installations must be installed by a licensed electrician and must comply with all national and local codes, laws and regulations. Milbank reserves the right to make changes in specifications and features shown without notice or obligation.



# Meter Main Combination

320 Amp | 4 Terminal | Ring Type



**M404-UG-LC**

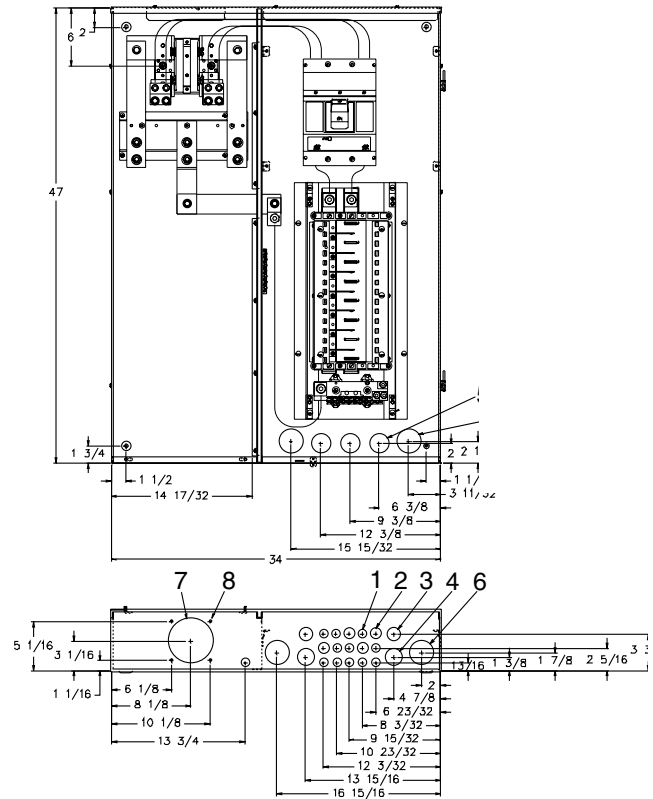

**Knockouts**

- 1 = (12) 1/2"
- 2 = (4) 1/2, 3/4"
- 3 = (4) 3/4, 1"
- 4 = (2) 1/2, 3/4, 1, 1-1/4"
- 5 = (3) 3/4, 1, 1-1/4, 1-1/2"
- 6 = (4) 1, 1 1/4, 1-1/2, 2"
- 7 = (1) 3, 3-1/2, 4"
- 8 = (4) 1/4" diameter hole

**320 Amp Main With Circuit Load Center | 4 Terminal | Ring Type | 1Ø3W | 120/240 Volt**

| Catalog Number | Terminal | Service | Primary Disconnect        | Secondary Disconnect | Bypass | Dimensions |    |    | Knockouts |     |   |       |       |   |   |     |
|----------------|----------|---------|---------------------------|----------------------|--------|------------|----|----|-----------|-----|---|-------|-------|---|---|-----|
|                |          |         |                           |                      |        | D"         | W" | H" | 1         | 2   | 3 | 4     | 5     | 6 | 7 | 8   |
| M404-UG-LC*    | 4        | UG      | 400 Amp<br>2 Pole Breaker | NA                   | None   | 6          | 34 | 47 | 1/2       | 3/4 | 1 | 1 1/4 | 1 1/2 | 2 | 4 | 1/4 |
| M404-UG-LC-BS* | 4        | UG      | 400 Amp<br>2 Pole Breaker | NA                   | Link   | 6          | 34 | 47 | 1/2       | 3/4 | 1 | 1 1/4 | 1 1/2 | 2 | 4 | 1/4 |

**Notes**

- **Amperage Rating:** 400 amp, 320 amp continuous.
- **Neutral:** Bonded neutral and ground factory installed.
- **Line Side Connectors:** Two 1/2" studs per phase on 1-3/4" centers.
- **Flush Mount:** Flush mounting available on underground units. Order catalog number **FK-M404-UGLC** separately.
- **Short Circuit Current Withstand Rating:** 22K AIC standard.
- **Lug Kit:** Mechanical lug kit available, order **K4920** (#2-500).
- **Branch Breakers:** Use Siemens, Cutler-Hammer, GE or Siemens/Murray breakers to maintain 22K rating.
- \* Includes a 30-circuit load center.



Please consult serving utility for their requirements prior to ordering or installing, as specifications and approvals vary by utility, and may require local electrical inspector approval. All installations must be installed by a licensed electrician and must comply with all national and local codes, laws and regulations. Milbank reserves the right to make changes in specifications and features shown without notice or obligation.

# Test Block Bypass/Safety Sockets

100 & 200 Amp | 4, 5 & 7 Terminal | Ring Type

**31**  
100 & 200 AMP  
SAFETY SOCKETS

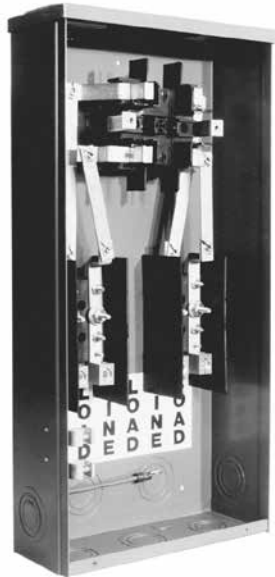

114TB

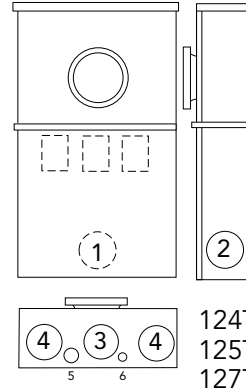
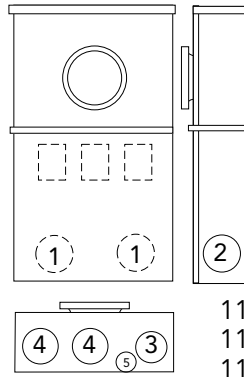

127TB

## 100 Amp | 4, 5 & 7 Terminal | Ring Type | 600 Volt Self-Contained | Socket Only

| Catalog Number | Terminal | Service | Type of Service | Connectors CU/AL |  | Dimensions                    |    |    | Knockouts |   |    |   |   |   |
|----------------|----------|---------|-----------------|------------------|--|-------------------------------|----|----|-----------|---|----|---|---|---|
|                |          |         |                 | Line & Load      |  | D"                            | W" | H" | 1         | 2 | 3  | 4 | 5 | 6 |
| 114TB*         | 4        | OH/UG   | 1Ø3W*           | #6-1/0           |  | 4 <sup>5</sup> / <sub>8</sub> | 12 | 25 | 2         | 2 | 1½ | 2 | ½ | — |
| 115TB          | 5        | OH/UG   | 3Ø3W            | #6-1/0           |  | 4 <sup>5</sup> / <sub>8</sub> | 12 | 25 | 2         | 2 | 1½ | 2 | ½ | — |
| 117TB          | 7        | OH/UG   | 3Ø4W            | #6-1/0           |  | 4 <sup>5</sup> / <sub>8</sub> | 12 | 25 | 2         | 2 | 1½ | 2 | ½ | — |

## 200 Amp | 4, 5 & 7 Terminal | Ring Type | 600 Volt Self-Contained | Socket Only

| Catalog Number | Terminal | Service | Type of Service | Connectors CU/AL |  | Dimensions |    |    | Knockouts |    |   |   |   |      |
|----------------|----------|---------|-----------------|------------------|--|------------|----|----|-----------|----|---|---|---|------|
|                |          |         |                 | Line & Load      |  | D"         | W" | H" | 1         | 2  | 3 | 4 | 5 | 6    |
| 124TB*         | 4        | OH/UG   | 1Ø3W*           | #1/0-250         |  | 6          | 14 | 30 | 2½        | 2½ | 3 | 3 | ¼ | ½, ¼ |
| 125TB          | 5        | OH/UG   | 3Ø3W            | #1/0-250         |  | 6          | 14 | 30 | 2½        | 2½ | 3 | 3 | ¼ | ½, ¼ |
| 127TB          | 7        | OH/UG   | 3Ø4W            | #1/0-250         |  | 6          | 14 | 30 | 2½        | 2½ | 3 | 3 | ¼ | ½, ¼ |

### Notes

- **Hubs:** OH units use hub up to 2-1/2" (see accessory page). Units provided with closing plates.
- **Sealing Rings:** Units furnished with MR-2 snap style sealing rings.
- **Ring Protector:** Add suffix **-RP** to catalog number for factory installed ring protector (ex. **117TB** becomes **117TB-RP**).
- \* For 3W (208Y/120) network service, install field mounted fifth terminal catalog number **105J**. See accessories page.

**SHORT CIRCUIT CURRENT WITHSTAND RATING UP TO 200K AIC  
DEPENDENT ON OVERCURRENT PROTECTION DEVICE USED**

Please consult serving utility for their requirements prior to ordering or installing, as specifications and approvals vary by utility, and may require local electrical inspector approval. All installations must be installed by a licensed electrician and must comply with all national and local codes, laws and regulations. Milbank reserves the right to make changes in specifications and features shown without notice or obligation.



# Test Block Bypass/MTB Series

100 Amp | 4, 5 & 7 Terminal | Ring Type | 10K AIC



U214MTB

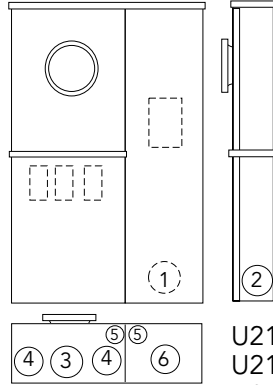

U214MTB  
U215MTB  
U217MTB

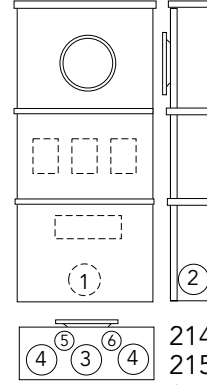

214MT  
215MT  
217MT



217MTB

100 Amp | 4, 5 & 7 Terminal | Ring Type | 240 Volt Self-Contained | Circuit Breaker

| Catalog Number | Terminal | Service | Type of Service | Connectors CU/AL |         | Dimensions                    |    |    | Knockouts |   |    |    |   |    |
|----------------|----------|---------|-----------------|------------------|---------|-------------------------------|----|----|-----------|---|----|----|---|----|
|                |          |         |                 | Line             | Load    | D"                            | W" | H" | 1         | 2 | 3  | 4  | 5 | 6  |
| 214MTB*        | 4        | OH      | 1Ø3W*           | #6-2/0           | #14-1/0 | 4 <sup>5</sup> / <sub>8</sub> | 12 | 34 | 2         | 2 | 2  | 1½ | — | ½  |
| 215MTB         | 5        | OH      | 3Ø3W            | #6-2/0           | #14-1/0 | 4 <sup>5</sup> / <sub>8</sub> | 12 | 34 | 2         | 2 | 2  | 1½ | — | ½  |
| 217MTB         | 7        | OH      | 3Ø4W            | #6-2/0           | #14-1/0 | 4 <sup>5</sup> / <sub>8</sub> | 12 | 34 | 2         | 2 | 2  | 1½ | — | ½  |
| U214MTB*       | 4        | OH/UG   | 1Ø3W*           | #6-2/0           | #14-1/0 | 4 <sup>5</sup> / <sub>8</sub> | 18 | 25 | 2         | 2 | 2½ | 1½ | ¾ | 1½ |
| U215MTB        | 5        | OH/UG   | 3Ø3W            | #6-2/0           | #14-1/0 | 4 <sup>5</sup> / <sub>8</sub> | 18 | 25 | 2         | 2 | 2½ | 1½ | ¾ | 1½ |
| U217MTB        | 7        | OH/UG   | 3Ø4W            | #6-2/0           | #14-1/0 | 4 <sup>5</sup> / <sub>8</sub> | 18 | 25 | 2         | 2 | 2½ | 1½ | ¾ | 1½ |

## Notes

- **Replacement Main Disconnects:** For replacement main disconnect see pages 42-43.
- **Hubs:** OH units use hub up to 2-1/2" (see accessory page). Units provided with closing plates.
- **Sealing Rings:** Units furnished with MR-2 snap style sealing rings.
- \* For 3W (208Y/120) network service, install field mounted fifth terminal catalog number 105J. See accessories page.

*These UL listed products are for use in areas requiring Electrical Utility Service Equipment Requirements Committee (EUSERC) compliance.*



Please consult serving utility for their requirements prior to ordering or installing, as specifications and approvals vary by utility, and may require local electrical inspector approval. All installations must be installed by a licensed electrician and must comply with all national and local codes, laws and regulations. Milbank reserves the right to make changes in specifications and features shown without notice or obligation.



# Test Block Bypass/MTB Series

100 Amp | 4 & 7 Terminal | Ring Type | 22K AIC

**33**  
100 AMP  
TEST BLOCK  
BYPASS



U214MTB/22

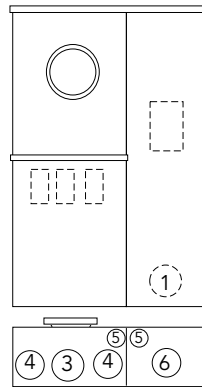

U214MTB/22  
U217MTB/22

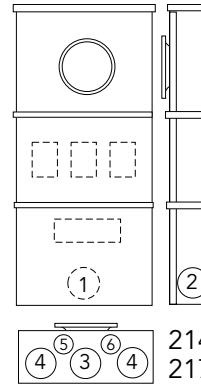

214MTB/2  
217MTB/2



217MTB/2

100 Amp | 4 & 7 Terminal | Ring Type | 240 Volt Self-Contained | Circuit Breaker

| Catalog Number | Terminal | Service | Type of Service | Connectors CU/AL |         | Dimensions      |    |    | Knockouts |   |                 |                 |               |                 |
|----------------|----------|---------|-----------------|------------------|---------|-----------------|----|----|-----------|---|-----------------|-----------------|---------------|-----------------|
|                |          |         |                 | Line             | Load    | D"              | W" | H" | 1         | 2 | 3               | 4               | 5             | 6               |
| 214MTB/22*     | 4        | OH      | 1Ø3W*           | #6-2/0           | #14-1/0 | 4 $\frac{5}{8}$ | 12 | 34 | 2         | 2 | 2               | 1 $\frac{1}{2}$ | —             | $\frac{1}{2}$   |
| 217MTB/22      | 7        | OH      | 3Ø4W            | #6-2/0           | #14-1/0 | 4 $\frac{5}{8}$ | 12 | 34 | 2         | 2 | 2               | 1 $\frac{1}{2}$ | —             | $\frac{1}{2}$   |
| U214MTB/22*    | 4        | OH/UG   | 1Ø3W*           | #6-2/0           | #14-1/0 | 4 $\frac{5}{8}$ | 18 | 25 | 2         | 2 | 2 $\frac{1}{2}$ | 1 $\frac{1}{2}$ | $\frac{3}{4}$ | 1 $\frac{1}{2}$ |
| U217MTB/22     | 7        | OH/UG   | 3Ø4W            | #6-2/0           | #14-1/0 | 4 $\frac{5}{8}$ | 18 | 25 | 2         | 2 | 2 $\frac{1}{2}$ | 1 $\frac{1}{2}$ | $\frac{3}{4}$ | 1 $\frac{1}{2}$ |

## Notes

- **Replacement Main Disconnects:** For replacement main disconnect see pages 42-43.
  - **Hubs:** OH units use hub up to 2-1/2" (see accessory page). Units provided with closing plates.
  - **Sealing Rings:** Units furnished with MR-2 snap style sealing rings.
- \* For 3W (208Y/120) network service, install field mounted fifth terminal catalog number 105J. See accessories page.

*These UL listed products are for use in areas requiring  
Electrical Utility Service Equipment Requirements Committee (EUSERC) compliance.*

Please consult serving utility for their requirements prior to ordering or installing, as specifications and approvals vary by utility, and may require local electrical inspector approval. All installations must be installed by a licensed electrician and must comply with all national and local codes, laws and regulations. Milbank reserves the right to make changes in specifications and features shown without notice or obligation.



# 34

100 AMP  
TEST BLOCK  
BYPASS

# Test Block Bypass/MTB Series

100 Amp | 4, 5 & 7 Terminal | Ring Type | 14K AIC | 480 Volt



217MTB-48

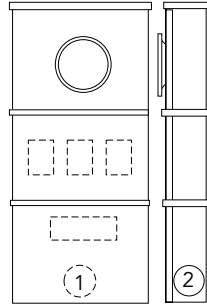

214MTB-48  
215MTB-48  
217MTB-48

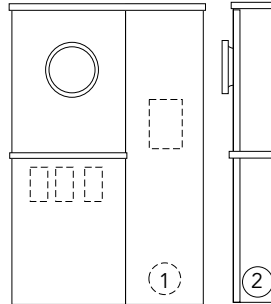

U214MTB-48  
U215MTB-48  
U217MTB-48



U214MTB-48

100 Amp | 4, 5 & 7 Terminal | Ring Type | 480 Volt Self-Contained | Circuit Breaker

| Catalog Number | Terminal | Service | Type of Service | Connectors CU/AL |         | Dimensions |    |    | Knockouts |    |    |    |     |    |
|----------------|----------|---------|-----------------|------------------|---------|------------|----|----|-----------|----|----|----|-----|----|
|                |          |         |                 | Line             | Load    | D"         | W" | H" | 1         | 2  | 3  | 4  | 5   | 6  |
| 214MTB-48*     | 4        | OH      | 1Ø3W*           | #6-2/0           | #14-1/0 | 6          | 14 | 48 | 2½        | 2½ | 3  | 3  | ¼   | ½  |
| 215MTB-48      | 5        | OH      | 3Ø3W            | #6-2/0           | #14-1/0 | 6          | 14 | 48 | 2½        | 2½ | 3  | 3  | ¼   | ½  |
| 217MTB-48      | 7        | OH      | 3Ø4W            | #6-2/0           | #14-1/0 | 6          | 14 | 48 | 2½        | 2½ | 3  | 3  | ¼   | ½  |
| U214MTB-48*    | 4        | OH/UG   | 1Ø3W*           | #6-2/0           | #14-1/0 | 4⅝         | 18 | 25 | 2         | 2  | 2½ | 1½ | ½,¾ | 1½ |
| U217MTB-48     | 7        | OH/UG   | 3Ø4W            | #6-2/0           | #14-1/0 | 4⅝         | 18 | 25 | 2         | 2  | 2½ | 1½ | ½,¾ | 1½ |

## Notes

- **Replacement Main Disconnects:** For replacement main disconnect see pages 42-43.
  - **Hubs:** OH units use hub up to 2-1/2" (see accessory page). Units provided with closing plates.
  - **Sealing Rings:** Units furnished with MR-2 snap style sealing rings.
- \* For 3W (208Y/120) network service, install field mounted fifth terminal catalog number 105J. See accessories page.

**These UL listed products are for use in areas requiring Electrical Utility Service Equipment Requirements Committee (EUSERC) compliance.**



Please consult serving utility for their requirements prior to ordering or installing, as specifications and approvals vary by utility, and may require local electrical inspector approval. All installations must be installed by a licensed electrician and must comply with all national and local codes, laws and regulations. Milbank reserves the right to make changes in specifications and features shown without notice or obligation.

# Test Block Bypass/MTB-P & MTB-P48 Series

# 35

100 AMP  
TEST BLOCK  
BYPASS

100 Amp | 4, 5 & 7 Terminal | Ring Type | 200K AIC



214MTB-P

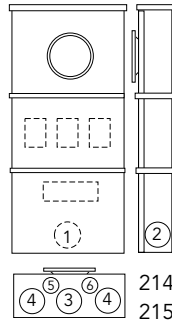

- 214MTB-P
- 215MTB-P
- 217MTB-P
- 214MTB-P48
- 215MTB-P48
- 217MTB-P48

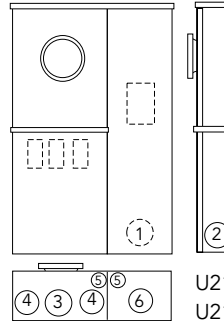

- U214MTB-P
- U215MTB-P
- U217MTB-P
- U214MTB-P48
- U215MTB-P48
- U217MTB-P48



U217MTB-P

## 100 Amp | 4, 5 & 7 Terminal | Ring Type | 240 Volt Self-Contained | T-Fuse Pullout

| Catalog Number | Terminal | Service | Type of Service | Connectors CU/AL |         | Dimensions |    |    | Knockouts |    |    |    |      |    |
|----------------|----------|---------|-----------------|------------------|---------|------------|----|----|-----------|----|----|----|------|----|
|                |          |         |                 | Line             | Load    | D"         | W" | H" | 1         | 2  | 3  | 4  | 5    | 6  |
| 214MTB-P*      | 4        | OH      | 1Ø3W*           | #1/0-250         | #14-1/0 | 6          | 14 | 48 | 2½        | 2½ | 3  | 3  | ¼    | ½  |
| 215MTB-P       | 5        | OH      | 3Ø3W            | #1/0-250         | #14-1/0 | 6          | 14 | 48 | 2½        | 2½ | 3  | 3  | ¼    | ½  |
| 217MTB-P       | 7        | OH      | 3Ø4W            | #1/0-250         | #14-1/0 | 6          | 14 | 48 | 2½        | 2½ | 3  | 3  | ¼    | ½  |
| U214MTB-P*     | 4        | OH/UG   | 1Ø3W*           | #6-2/0           | #14-1/0 | 4½         | 18 | 25 | 2         | 2  | 2½ | 1½ | ½, ¾ | 1½ |
| U215MTB-P      | 5        | OH/UG   | 3Ø3W            | #6-2/0           | #14-1/0 | 4½         | 18 | 25 | 2         | 2  | 2½ | 1½ | ½, ¾ | 1½ |
| U217MTB-P      | 7        | OH/UG   | 3Ø4W            | #6-2/0           | #14-1/0 | 4½         | 18 | 25 | 2         | 2  | 2½ | 1½ | ½, ¾ | 1½ |

## 100 Amp | 4, 5 & 7 Terminal | Ring Type | 480 Volt Self-Contained | T-Fuse Pullout

| Catalog Number | Terminal | Service | Type of Service | Connectors CU/AL |         | Dimensions |    |    | Knockouts |    |    |    |      |    |
|----------------|----------|---------|-----------------|------------------|---------|------------|----|----|-----------|----|----|----|------|----|
|                |          |         |                 | Line             | Load    | D"         | W" | H" | 1         | 2  | 3  | 4  | 5    | 6  |
| 214MTB-P48*    | 4        | OH      | 1Ø3W*           | #6-2/0           | #14-1/0 | 6          | 14 | 48 | 2½        | 2½ | 3  | 3  | ¼    | ½  |
| 215MTB-P48     | 5        | OH      | 3Ø3W            | #6-2/0           | #14-1/0 | 6          | 14 | 48 | 2½        | 2½ | 3  | 3  | ¼    | ½  |
| 217MTB-P48     | 7        | OH      | 3Ø4W            | #6-2/0           | #14-1/0 | 6          | 14 | 48 | 2½        | 2½ | 3  | 3  | ¼    | ½  |
| U214MTB-P48*   | 4        | OH/UG   | 1Ø3W*           | #6-2/0           | #14-1/0 | 4½         | 18 | 25 | 2         | 2  | 2½ | 1½ | ½, ¾ | 1½ |
| U215MTB-P48    | 5        | OH/UG   | 3Ø3W            | #6-2/0           | #14-1/0 | 4½         | 18 | 25 | 2         | 2  | 2½ | 1½ | ½, ¾ | 1½ |
| U217MTB-P48    | 7        | OH/UG   | 3Ø4W            | #6-2/0           | #14-1/0 | 4½         | 18 | 25 | 2         | 2  | 2½ | 1½ | ½, ¾ | 1½ |

### Notes

- **Replacement Main Disconnects:** For replacement main disconnect see pages 42-43.
  - **Hubs:** OH units use hub up to 2-1/2" (see accessory page). Units provided with closing plates.
  - **Sealing Rings:** Units furnished with MR-2 snap style sealing rings.
  - **Pull-Outs:** For use with T-fuses only. Fuses are included with fused safety sockets.
- \* For 3W (208Y/120) network service, install field mounted fifth terminal catalog number 105J. See accessories page.

**These UL listed products are for use in areas requiring  
Electrical Utility Service Equipment Requirements Committee (EUSERC) compliance.**

Please consult serving utility for their requirements prior to ordering or installing, as specifications and approvals vary by utility, and may require local electrical inspector approval. All installations must be installed by a licensed electrician and must comply with all national and local codes, laws and regulations. Milbank reserves the right to make changes in specifications and features shown without notice or obligation.



# Test Block Bypass/MTB Series

200 Amp | 4, 5 & 7 Terminal | Ring Type | 10K AIC



227MTB

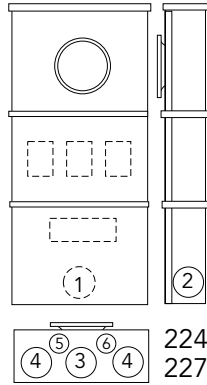

224MTB  
227MTB

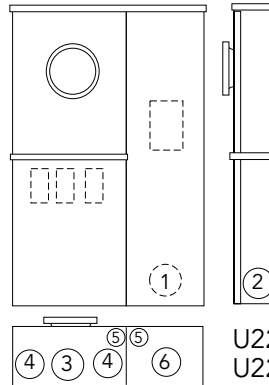

U224MTB  
U227MTB



U224MTB

200 Amp | 4 & 7 Terminal | Ring Type | 240 Volt Self-Contained | Circuit Breaker

| Catalog Number | Terminal | Service | Type of Service | Connectors CU/AL |          | Dimensions |     |    | Knockouts |    |    |    |     |    |
|----------------|----------|---------|-----------------|------------------|----------|------------|-----|----|-----------|----|----|----|-----|----|
|                |          |         |                 | Line             | Load     | D"         | W"  | H" | 1         | 2  | 3  | 4  | 5   | 6  |
| 224MTB*        | 4        | OH      | 1Ø3W*           | #6-250           | #2/0-250 | 6          | 14  | 48 | 2½        | 2½ | 3  | 3  | ½   | ¼  |
| 227MTB         | 7        | OH      | 3Ø4W            | #6-250           | #2/0-250 | 6          | 14  | 48 | 2½        | 2½ | 3  | 3  | ½   | ¼  |
| U224MTB*       | 4        | OH/UG   | 1Ø3W*           | #6-250           | #2/0-250 | 6          | 22¾ | 30 | 2½        | 2½ | 2½ | 1½ | ½,¾ | 1½ |
| U227MTB        | 7        | OH/UG   | 3Ø4W            | #6-250           | #2/0-250 | 6          | 22¾ | 30 | 2½        | 2½ | 2½ | 1½ | ½,¾ | 1½ |

## Notes

- **Replacement Main Disconnects:** For replacement main disconnect see pages 42-43.
- **Hubs:** OH units use hub up to 2-1/2" (see accessory page). Units provided with closing plates.
- **Sealing Rings:** Units furnished with MR-2 snap style sealing rings.
- \* For 3W (208Y/120) network service, install field mounted fifth terminal catalog number 105J. See accessories page.

*These UL listed products are for use in areas requiring  
Electrical Utility Service Equipment Requirements Committee (EUSERC) compliance.*



Please consult serving utility for their requirements prior to ordering or installing, as specifications and approvals vary by utility, and may require local electrical inspector approval. All installations must be installed by a licensed electrician and must comply with all national and local codes, laws and regulations. Milbank reserves the right to make changes in specifications and features shown without notice or obligation.

# Test Block Bypass/MTB Series

200 Amp | 4 & 7 Terminal | Ring Type | 22K AIC

**37**  
200 AMP  
TEST BLOCK  
BYPASS



227MTB/22

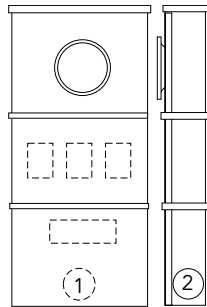

224MTB/22  
227MTB/22

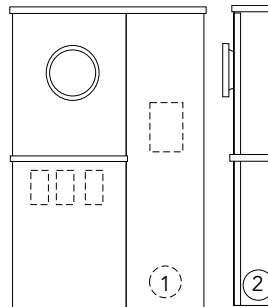

U224MTB/22  
U227MTB/22



U224MTB/22

200 Amp | 4 & 7 Terminal | Ring Type | 240 Volt Self-Contained | Circuit Breaker

| Catalog Number | Terminal | Service | Type of Service | Connectors CU/AL |          | Dimensions |     |    | Knockouts |    |    |    |     |    |
|----------------|----------|---------|-----------------|------------------|----------|------------|-----|----|-----------|----|----|----|-----|----|
|                |          |         |                 | Line             | Load     | D"         | W"  | H" | 1         | 2  | 3  | 4  | 5   | 6  |
| 224MTB/22*     | 4        | OH      | 1Ø3W*           | #6-250           | #2/0-250 | 6          | 14  | 48 | 2½        | 2½ | 3  | 3  | ½   | ¼  |
| 227MTB/22      | 7        | OH      | 3Ø4W            | #6-250           | #2/0-250 | 6          | 14  | 48 | 2½        | 2½ | 3  | 3  | ½   | ¼  |
| U224MTB/22*    | 4        | OH/UG   | 1Ø3W*           | #6-250           | #2/0-250 | 6          | 22¾ | 30 | 2½        | 2½ | 2½ | 1½ | ½,¾ | 1½ |
| U227MTB/22     | 7        | OH/UG   | 3Ø4W            | #6-250           | #2/0-250 | 6          | 22¾ | 30 | 2½        | 2½ | 2½ | 1½ | ½,¾ | 1½ |

## Notes

- **Replacement Main Disconnects:** For replacement main disconnect see pages 42-43.
  - **Hubs:** OH units use hub up to 2-1/2" (see accessory page). Units provided with closing plates.
  - **Sealing Rings:** Units furnished with MR-2 snap style sealing rings.
- \* For 3W (208Y/120) network service, install field mounted fifth terminal catalog number 105J. See accessories page.

Please consult serving utility for their requirements prior to ordering or installing, as specifications and approvals vary by utility, and may require local electrical inspector approval. All installations must be installed by a licensed electrician and must comply with all national and local codes, laws and regulations. Milbank reserves the right to make changes in specifications and features shown without notice or obligation.



# Test Block Bypass/MTB Series

200 Amp | 4 & 7 Terminal | Ring Type | 35K AIC | 480 Volt



227MTB-48

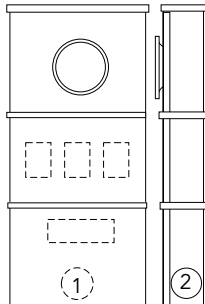

224MTB-48  
227MTB-48

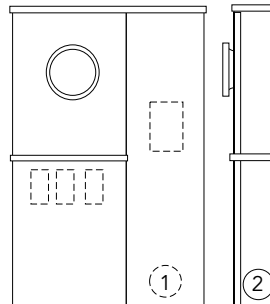

U224MTB-48  
U227MTB-48



U224MTB-48

## 200 Amp | 4 & 7 Terminal | Ring Type | 480 Volt Self-Contained | Circuit Breaker

| Catalog Number | Terminal | Service | Type of Service | Connectors CU/AL |          | Dimensions |     |    | Knockouts |    |    |    |    |    |
|----------------|----------|---------|-----------------|------------------|----------|------------|-----|----|-----------|----|----|----|----|----|
|                |          |         |                 | Line             | Load     | D"         | W"  | H" | 1         | 2  | 3  | 4  | 5  | 6  |
| 224MTB-48*     | 4        | OH      | 1Ø3W*           | #6-250           | #2/0-250 | 6          | 22¾ | 30 | 2½        | 2½ | 3  | 2½ | ½  | ¼  |
| U224MTB-48     | 4        | OH/UG   | 1Ø3W*           | #6-250           | #2/0-250 | 6          | 22¾ | 30 | 2½        | 2½ | 3  | 2½ | ½  | ¼  |
| 227MTB-48      | 7        | OH      | 3Ø4W            | #6-250           | #2/0-250 | 6          | 14  | 48 | 2½        | 2½ | 3  | 3  | ½  | ¼  |
| U227MTB-48     | 7        | OH/UG   | 3Ø4W            | #6-250           | #2/0-250 | 6          | 22¾ | 30 | 2½        | 2½ | 2½ | 1½ | ½¾ | 1½ |

### Notes

- **Replacement Main Disconnects:** For replacement main disconnect see pages 42-43.
  - **Hubs:** OH units use hub up to 2-1/2" (see accessory page). Units provided with closing plates.
  - **Sealing Rings:** Units furnished with MR-2 snap style sealing rings.
- \* For 3W (208Y/120) network service, install field mounted fifth terminal catalog number 105J. See accessories page.



Please consult serving utility for their requirements prior to ordering or installing, as specifications and approvals vary by utility, and may require local electrical inspector approval. All installations must be installed by a licensed electrician and must comply with all national and local codes, laws and regulations. Milbank reserves the right to make changes in specifications and features shown without notice or obligation.

# Test Block Bypass/MTB-P & MTB-P48

200 Amp | Ring Type | 200K AIC

**39**  
200 AMP  
TEST BLOCK  
BYPASS



224MTB-P

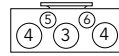
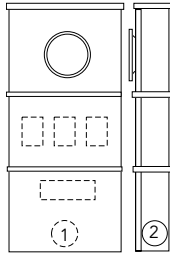

224MTB-P  
225MTB-P  
227MTB-P  
224MTB-P48  
225MTB-P48  
227MTB-P48

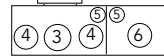
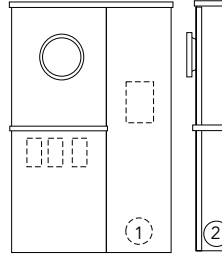

U224MTB-P  
U227MTB-P  
U224MTB-P48  
U227MTB-P48



U227MTB-P

200 Amp | 4, 5 & 7 Terminal | Ring Type | 240 Volt Self-Contained | T-Fuse Pullout

| Catalog Number | Terminal | Service | Type of Service | Connectors CU/AL |          | Dimensions |     |    | Knockouts |    |   |    |     |    |
|----------------|----------|---------|-----------------|------------------|----------|------------|-----|----|-----------|----|---|----|-----|----|
|                |          |         |                 | Line             | Load     | D"         | W"  | H" | 1         | 2  | 3 | 4  | 5   | 6  |
| 224MTB-P*      | 4        | OH      | 1Ø3W*           | #6-250           | #1/0-250 | 6          | 14  | 48 | 2½        | 2½ | 3 | 3  | ¼   | ½  |
| 225MTB-P       | 5        | OH      | 3Ø3W            | #6-250           | #1/0-250 | 6          | 14  | 48 | 2½        | 2½ | 3 | 3  | ¼   | ½  |
| 227MTB-P       | 7        | OH      | 3Ø4W            | #6-250           | #1/0-250 | 6          | 14  | 48 | 2½        | 2½ | 3 | 3  | ¼   | ½  |
| U224MTB-P*     | 4        | OH/UG   | 1Ø3W*           | #6-250           | #1/0-250 | 6          | 22¾ | 30 | 2½        | 2½ | 3 | 2½ | ½,¾ | 2½ |
| U227MTB-P      | 7        | OH/UG   | 3Ø4W            | #6-250           | #1/0-250 | 6          | 22¾ | 30 | 2½        | 2½ | 3 | 2½ | ½,¾ | 2½ |

200 Amp | 4, 5 & 7 Terminal | Ring Type | 480 Volt Self-Contained | T-Fuse Pullout

| Catalog Number | Terminal | Service | Type of Service | Connectors CU/AL |          | Dimensions |     |    | Knockouts |    |   |    |     |    |
|----------------|----------|---------|-----------------|------------------|----------|------------|-----|----|-----------|----|---|----|-----|----|
|                |          |         |                 | Line             | Load     | D"         | W"  | H" | 1         | 2  | 3 | 4  | 5   | 6  |
| 224MTB-P48*    | 4        | OH      | 1Ø3W*           | #6-250           | #1/0-250 | 6          | 14  | 48 | 2½        | 2½ | 3 | 3  | ¼   | ½  |
| 225MTB-P48     | 5        | OH      | 3Ø3W            | #6-250           | #1/0-250 | 6          | 14  | 48 | 2½        | 2½ | 3 | 3  | ¼   | ½  |
| 227MTB-P48     | 7        | OH      | 3Ø4W            | #6-250           | #1/0-250 | 6          | 14  | 48 | 2½        | 2½ | 3 | 3  | ¼   | ½  |
| U224MTB-P48*   | 4        | OH/UG   | 1Ø3W*           | #6-250           | #1/0-250 | 6          | 22¾ | 30 | 2½        | 2½ | 3 | 2½ | ½,¾ | 2½ |
| U227MTB-P48    | 7        | OH/UG   | 3Ø4W            | #6-250           | #1/0-250 | 6          | 22¾ | 30 | 2½        | 2½ | 3 | 2½ | ½,¾ | 2½ |

## Notes

- **Replacement Main Disconnects:** For replacement main disconnect see pages 42-43.
  - **Hubs:** OH units use hub up to 2-1/2" (see accessory page). Units provided with closing plates.
  - **Sealing Rings:** Units furnished with MR-2 snap style sealing rings.
  - **Pull-Outs:** For use with T-fuses only. Fuses are included with fused safety sockets.
- \* For 3W (208Y/120) network service, install field mounted fifth terminal catalog number 105J. See accessories page.

Please consult serving utility for their requirements prior to ordering or installing, as specifications and approvals vary by utility, and may require local electrical inspector approval. All installations must be installed by a licensed electrician and must comply with all national and local codes, laws and regulations. Milbank reserves the right to make changes in specifications and features shown without notice or obligation.



# Test Block Bypass/MTBL

All-In-One Series | 100 & 200 Amp | 10K & 200K AIC



**U227MTBL**

**100 & 200 Amp | 240 Volt Meter Main | Circuit Breaker/T-Fuse Pullout**

| Catalog Number | Rating                            | No. Internal Circuits | Main Circuit Breaker Or Fuse Pullout | Dimensions      |    |                  | Bottom Knockouts  | Back Knockouts  |
|----------------|-----------------------------------|-----------------------|--------------------------------------|-----------------|----|------------------|---|---|
|                |                                   |                       |                                      | D"              | W" | H"               |   |   |
| U214MTBL*      | 100A, 120/240 VAC 1Ø3W            | 12/24                 | 100A, 2P, 10K Milbank Q2100          | 4 $\frac{5}{8}$ | 25 | 24 $\frac{3}{4}$ | <b>Utility Section</b><br>(1) ½"<br>(3) 1¼", 1½", 2", 2½"<br><br><b>Customer Section</b><br>(3) ½", ¾"<br>(1) ½", ¾", 1", 1¼"<br>(2) ¾", 1", 1¼", 1½"                               | <b>Customer Section</b><br>(7) ½"<br>(4) ½", ¾"<br>(1) ¾", 1", 1¼", 1½" |
| U214MTBPL*     | 100A, 120/240 VAC 1Ø3W            | 12/24                 | 100A, 2P, 200K Boltswitch PT223      | 4 $\frac{5}{8}$ | 25 | 24 $\frac{3}{4}$ |   |   |
| U217MTBL       | 100A, 240Δ/120; 208Y/120 VAC 3Ø4W | 18/36                 | 100A, 3P, 10K Siemens BQ3100         | 4 $\frac{5}{8}$ | 25 | 24 $\frac{3}{4}$ |   |   |
| U217MTBPL      | 100A, 240Δ/120; 208Y/120 VAC 3Ø4W | 18/36                 | 100A, 3P, 200K Boltswitch PT323      | 4 $\frac{5}{8}$ | 25 | 24 $\frac{3}{4}$ |   |   |
| U224MTBL*      | 200A, 120/240 VAC 1Ø3W            | 20/40                 | 200A, 2P, 10K Milbank UQFP-200       | 6               | 27 | 30               | <b>Utility Section</b><br>(1) ½", ¾"<br>(2) 1¼", 1½", 2", 2½"<br>(1) 2½", 3"<br><br><b>Customer Section</b><br>(11) ½"<br>(2) ½", ¾"<br>(1) ½", ¾", 1", 1¼"<br>(2) ¾", 1", 1¼", 1½" | <b>Customer Section</b><br>(6) ½"<br>(4) ½", ¾"<br>(1) ¾", 1", 1¼", 1½" |
| U224MTBPL*     | 200A, 120/240 VAC 1Ø3W            | 20/40                 | 200A, 2P, 200K Boltswitch PT224      | 6               | 27 | 30               |   |   |
| U227MTBL       | 200A, 240Δ/120; 208Y/120 VAC 3Ø4W | 24/42                 | 200A, 3P, 10K Siemens QJ23B200       | 6               | 27 | 30               |   |   |
| U227MTBPL      | 200A, 240Δ/120; 208Y/120 VAC 3Ø4W | 24/42                 | 200A, 3P, 200K Boltswitch PT324      | 6               | 27 | 30               |   |   |

**Notes**

- **Line:** Underground or overhead service. Line Lug: 100A, 14-1/0 and 200A 1/0-250.
  - **Load:** Exit below load center only
  - **Branch Breakers:** Single phase units—approved for Siemens/ITE Type Q, Challenger, Cutler-Hammer/Westinghouse, General Electric, Murray. Three phase units—approved for Siemens/ITE Type Q.
  - **Hubs:** OH units use hub up to 2-1/2" (see accessory page). Units provided with closing plate.
  - **Pull-Outs:** For use with T-fuses only. Fuses are included with fused safety sockets.
- \* For 208Y/120 applications, order field kit **105J** separately and install.



Please consult serving utility for their requirements prior to ordering or installing, as specifications and approvals vary by utility, and may require local electrical inspector approval. All installations must be installed by a licensed electrician and must comply with all national and local codes, laws and regulations. Milbank reserves the right to make changes in specifications and features shown without notice or obligation.



# Test Block Bypass/MTBL

## Knockout Information

| Catalog Number | Knockouts |    |    |    |   |
|----------------|-----------|----|----|----|---|
|                | 1         | 2  | 3  | 4  | 5 |
| U214MTBL       | 2½        | 1½ | 1¼ | ¾  | ½ |
| U217MTBL       | 2½        | 1½ | 1¼ | ¾  | ½ |
| U227MTBL       | 3         | 2½ | 1½ | ¾  | ½ |
| U227MTBPL      | 3         | 2½ | 1½ | 1¼ | ¾ |

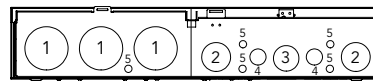
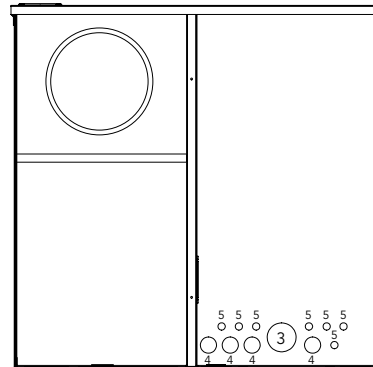

U214MTBL  
U217MTBL

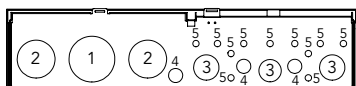
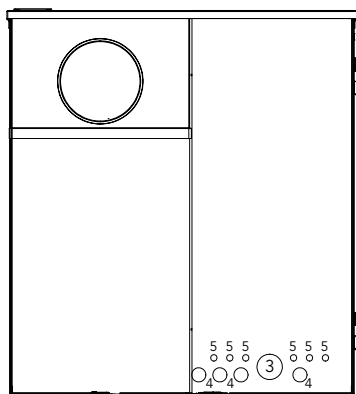

U227MTBL

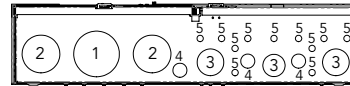
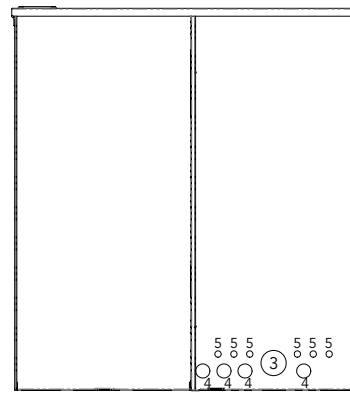

U227MTBPL

Please consult serving utility for their requirements prior to ordering or installing, as specifications and approvals vary by utility, and may require local electrical inspector approval. All installations must be installed by a licensed electrician and must comply with all national and local codes, laws and regulations. Milbank reserves the right to make changes in specifications and features shown without notice or obligation.



### Replacement Circuit Breakers

| Catalog Number | Circuit Breaker |
|----------------|-----------------|
| 214MTB         | BQ2B100L        |
| 214MTB-48      | ED42B100        |
| 214MTB/22      | BQ2B100HL       |
| U214MTB        | BQ2B100L        |
| U214MTB-48     | ED42B100        |
| U214MTB/22     | BQ2B100HL       |
| U214MTBL       | Q2100           |
|                |                 |
| 215MTB         | BQ3B100L        |
| 215MTB-48      | ED43B100L       |
| U215MTB        | BQ3B100L        |
| U215MTB-48     | ED43B100L       |
|                |                 |
| 217MTB         | BQ3B100L        |
| 217MTB48       | ED43B100L       |
| 217MTB/22      | BQ3B100HL       |
| U217MTB        | BQ3B100L        |
| U217MTB-48     | ED43B100L       |
| U217MTB/22     | BQ3B100HL       |
| U217MTBL       | BQ3B100L        |
|                |                 |
| 224MTB         | UQFB-200        |
| 224MTB/22      | UQFBH-200       |
| U224MTB        | UQFB-200        |
| U224MTB-48     | FXD62B200       |
| U224MTB/22     | UQFBH-200       |
| U224MTBL       | UQFB-200        |
|                |                 |
| U225MTB        | UQFB-3200       |

| Catalog Number | Circuit Breaker |
|----------------|-----------------|
| 227MTB         | UQFB-3200       |
| 227MTB-125     | UQFB-3125       |
| 227MTB-150     | UQFB-3150       |
| 227MTB-175     | UQFB-3175       |
| 227MTB-48      | FXD63B200L      |
| 227MTB/22      | QJH23B200L      |
| U227MTB        | UQFB-3200       |
| U227MTB-125    | UQFB-3125       |
| U227MTB-150    | UQFB-3150       |
| U227MTB-175    | UQFB-3175       |
| U227MTB-48     | FXD63B200L      |
| U227MTB/22     | QJH23B200L      |
| U227MTBL       | QJ23B200        |

### Lug Kits for Circuit Breakers

| Siemens Circuit Breaker | Number of Lug Collars Required |
|-------------------------|--------------------------------|
| ED42B100                | (2) LN13100                    |
| ED43B100                | (3) LN1E100                    |
| FXD62B200               | (4) TA1FD350                   |
| FXD63B200               | (6) TA1FD350                   |
| QJ22B200H               | (2) TA1Q300                    |
| QJ23B200                | (1) TA1Q300                    |
| QJH23B200L              | (1) TA1Q300                    |

### Note

When replacing Siemens Circuit Breaker (FXD,ED,QJ) in safety sockets, lug collars must be ordered from Siemens separately.



Please consult serving utility for their requirements prior to ordering or installing, as specifications and approvals vary by utility, and may require local electrical inspector approval. All installations must be installed by a licensed electrician and must comply with all national and local codes, laws and regulations. Milbank reserves the right to make changes in specifications and features shown without notice or obligation.

# Safety Socket Replacement

## T-Fuse Pullouts

### Replacement T-Fuse Pullouts

| Catalog Number | Circuit Breaker | Mfg.       | Part Number |
|----------------|-----------------|------------|-------------|
| 214MTB-P       | PT223           | Boltswitch | 707674-MO   |
| 214MTB-P48     | PT263           | Boltswitch | 708564-MO   |
| U214MTB-P      | PT223           | Boltswitch | 707674-MO   |
| U214MTB-P48    | PT263           | Boltswitch | 708564-MO   |
| U214MTBPL      | PT223           | Boltswitch | 707674-MO   |
| 215MTB-P       | PT323           | Boltswitch | 708565-MO   |
| 215MTB-P48     | PT363           | Boltswitch | 708566-MO   |
| U215MTB-P      | PT323           | Boltswitch | 708565-MO   |
| U215MTB-P48    | PT363           | Boltswitch | 708566-MO   |
| 217MTB-P       | PT323           | Boltswitch | 708565-MO   |
| 217MTB-P48     | PT363           | Boltswitch | 708566-MO   |
| U217MTB-P      | PT323           | Boltswitch | 708565-MO   |
| U217MTB-P48    | PT363           | Boltswitch | 708566-MO   |
| U217MTBPL      | PT323           | Boltswitch | 708565-MO   |
| 224MTB-P       | PT224           | Boltswitch | 707684-MO   |
| 224MTB-P48     | PT264           | Boltswitch | 708567-MO   |
| U224MTB-P      | PT224           | Boltswitch | 707684-MO   |
| U224MTB-P48    | PT264           | Boltswitch | 708567-MO   |
| U224MTBPL      | PT224           | Boltswitch | 707684-MO   |
| 225MTB-P48     | PT364           | Boltswitch | 708569-MO   |
| U225MTBPL      | PT324           | Boltswitch | 708568-MO   |
| 227MTB-P       | PT323           | Boltswitch | 708568-MO   |
| 227MTB-P48     | PT364           | Boltswitch | 708569-MO   |
| U227MTB-P      | PT324           | Boltswitch | 708568-MO   |
| U227MTB-P48    | PT364           | Boltswitch | 708569-MO   |
| U227MTBPL      | PT324           | Boltswitch | 708568-MO   |

### Lug Kits for T-Fuse Pullouts

| Part Number | Number of Lug Collars Required |
|-------------|--------------------------------|
| 707682-AC   | (2) TK100P                     |
| 708570-AC   | (2) TK200P                     |
| 707682-AC   | (2) TK100P                     |
| 708570-AC   | (2) TK200P                     |
| 707682-AC   | (3) TK100P                     |
| 708570-AC   | (3) TK200P                     |
| 707682-AC   | (3) TK100P                     |
| 708570-AC   | (3) TK200P                     |

### Note

T-Fuse pullouts provided with load side lugs. Order line side lugs separately from above chart.

Please consult serving utility for their requirements prior to ordering or installing, as specifications and approvals vary by utility, and may require local electrical inspector approval. All installations must be installed by a licensed electrician and must comply with all national and local codes, laws and regulations. Milbank reserves the right to make changes in specifications and features shown without notice or obligation.



# 44

SAFETY SOCKET  
& T-FUSE  
REPLACEMENT

# Safety Socket & T-Fuse Replacement



MS-27-TB



TB200-47

### Tenant Meter Sockets

| Catalog Number | Amp | Voltage/System |
|----------------|-----|----------------|
| MS-24-TB       | 200 | 600V/1Ø3W      |
| MS-25-TB       | 200 | 600V/3Ø3W      |
| MS-27-TB       | 200 | 600V/3Ø4W      |

### Replacement Test Blocks

| Catalog Number               | Amp | Phase          |
|------------------------------|-----|----------------|
| TB100-47                     | 100 | Phase A, B & C |
| TB100-5<br>Center Block Only | 100 | Phase B – 3Ø3W |
| TB200-47                     | 200 | Phase A, B & C |
| TB200-5<br>Center Block Only | 200 | Phase B – 3Ø3W |
| TB200-LL                     | 200 | Lug – Lug      |



PT324

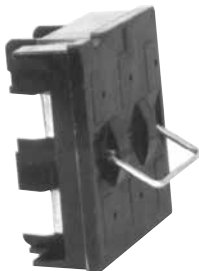

### 240 Volt Main Disconnects Pullout Switch (Uses Type "T" Fuse)

| Catalog Number | Amp | Rating            |
|----------------|-----|-------------------|
| PT223          | 100 | 2 Pole – 240 Volt |
| PT224          | 200 | 2 Pole – 240 Volt |
| PT323          | 100 | 3 Pole – 240 Volt |
| PT324          | 200 | 3 Pole – 240 Volt |

### 480 Volt Main Disconnects Pullout Switch (Uses Type "T" Fuse)

| Catalog Number | Amp | Rating            |
|----------------|-----|-------------------|
| PT263          | 100 | 2 Pole – 480 Volt |
| PT264          | 200 | 2 Pole – 480 Volt |
| PT363          | 100 | 3 Pole – 480 Volt |
| PT364          | 200 | 3 Pole – 480 Volt |

*These UL listed products are for use in areas requiring  
Electrical Utility Service Equipment Requirements Committee (EUSERC) compliance.*



Please consult serving utility for their requirements prior to ordering or installing, as specifications and approvals vary by utility, and may require local electrical inspector approval. All installations must be installed by a licensed electrician and must comply with all national and local codes, laws and regulations. Milbank reserves the right to make changes in specifications and features shown without notice or obligation.

# Underground Termination Boxes

600 VAC

**45**  
UNDERGROUND  
TERMINATION  
BOXES



PB-012



PB-038



PB-011



PB-032

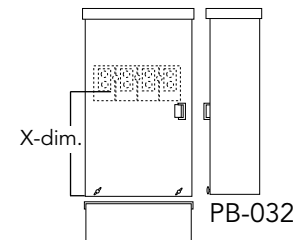
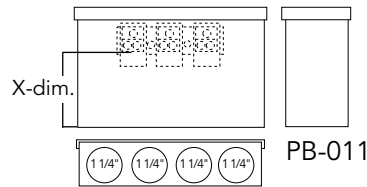
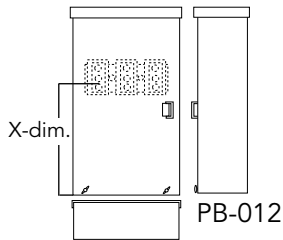

## Underground Termination Boxes | 600 VAC

| Catalog Number        | Amp | Type of Service | Connectors CU/AL |                        | Dimensions |    |    |       | Short Circuit Current Withstand Rating |
|-----------------------|-----|-----------------|------------------|------------------------|------------|----|----|-------|--|
|                       |     |                 | Line             | Load                   | D"         | W" | H" | X"    |  |
| PB-011*               | 100 | 1Ø3W            | #14-1/0          | #14-1/0                | 4          | 12 | 8½ | 3¾    | 10K Amp                                |
| PB-012                | 200 | 1Ø3W            | #6-250           | #6-250                 | 6          | 12 | 26 | 14¼   | 10K Amp                                |
| PB-014**<br>PB-014-NK | 400 | 1Ø3W            | ½"x13 Studs      | #4-600<br>Twin 1/0-250 | 6          | 16 | 36 | 22    | 50K Amp                                |
| PB-018**<br>PB-018-NK | 800 | 1Ø3W            | ½"x13 Studs**    | #4-600<br>Twin 1/0-250 | 11         | 24 | 48 | 26    | 50K Amp                                |
| PB-032                | 200 | 3Ø4W            | #6-250           | #6-250                 | 6          | 16 | 26 | 14¼/6 | 10K Amp                                |
| PB-034**<br>PB-034-NK | 400 | 3Ø4W            | ½"x13 Studs**    | #4-600<br>Twin 1/0-250 | 6          | 16 | 36 | 22    | 50K Amp                                |
| PB-038**              | 800 | 3Ø4W            | ½"x13 Studs**    | #4-600<br>Twin 1/0-250 | 11         | 24 | 48 | 26    | 50K Amp                                |

## Notes

- **Connectors and Bussing:** Extruded aluminum connectors and bus bars are tin plated.
- For no knockouts, add suffix -NK to the above catalog numbers.
- \* No lift handles provided on the **PB-011**.
- \*\* 2 studs per lug position provided for 400 amp units. 4 studs per lug position provided for 800 amp units.

Please consult serving utility for their requirements prior to ordering or installing, as specifications and approvals vary by utility, and may require local electrical inspector approval. All installations must be installed by a licensed electrician and must comply with all national and local codes, laws and regulations. Milbank reserves the right to make changes in specifications and features shown without notice or obligation.



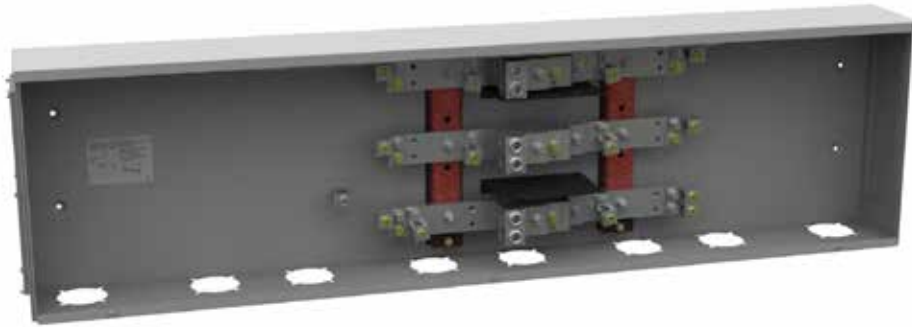

## For Commercial Safety Socket Applications

### Bussed Gutters | Type 3R | 1Ø3W | 600 VAC

| Catalog Number | Meter Position | Amp | Dimensions |                  |                  | Length of Bus | Line Lugs Per Each Bus | Load Lugs Per Bus |
|----------------|----------------|-----|------------|------------------|------------------|---------------|------------------------|-------------------|
|                |                |     | D"         | W"               | H"               |               |                        |                   |
| BC214          | 2              | 400 | 6          | 28 $\frac{5}{8}$ | 15 $\frac{1}{2}$ | 20" Bar       | (1) 600                | (2) 6-250         |
| BC318          | 3              | 800 | 6          | 43               | 15 $\frac{1}{2}$ | (2) 20" Bars  | (2) 600                | (3) 6-250         |
| BC418          | 4              | 800 | 6          | 57 $\frac{1}{4}$ | 15 $\frac{1}{2}$ | (2) 20" Bars  | (2) 600                | (4) 6-250         |
| BC518          | 5              | 800 | 6          | 71 $\frac{5}{8}$ | 15 $\frac{1}{2}$ | (2) 20" Bars  | (2) 600                | (5) 6-250         |
| BC618          | 6              | 800 | 6          | 85 $\frac{7}{8}$ | 15 $\frac{1}{2}$ | (2) 20" Bars  | (2) 600                | (6) 6-250         |

### Bussed Gutters | Type 3R | 3Ø4W | 600 VAC

| Catalog Number | Meter Position | Amp | Dimensions |                  |                  | Length of Bus | Line Lugs Per Each Bus | Load Lugs Per Bus |
|----------------|----------------|-----|------------|------------------|------------------|---------------|------------------------|-------------------|
|                |                |     | D"         | W"               | H"               |               |                        |                   |
| BC234          | 2              | 400 | 6          | 28 $\frac{5}{8}$ | 15 $\frac{1}{2}$ | 20" Bar       | (1) 600                | (2) 6-250         |
| BC338          | 3              | 800 | 6          | 43               | 15 $\frac{1}{2}$ | (2) 20" Bars  | (2) 600                | (3) 6-250         |
| BC438          | 4              | 800 | 6          | 57 $\frac{1}{4}$ | 15 $\frac{1}{2}$ | (2) 20" Bars  | (2) 600                | (4) 6-250         |
| BC538          | 5              | 800 | 6          | 71 $\frac{5}{8}$ | 15 $\frac{1}{2}$ | (2) 20" Bars  | (2) 600                | (5) 6-250         |
| BC638          | 6              | 800 | 6          | 85 $\frac{7}{8}$ | 15 $\frac{1}{2}$ | (2) 20" Bars  | (2) 600                | (6) 6-250         |

### Notes

- **Short Circuit Current Withstanding Rating:** Standard bracing is 42K AIC.
- **Connectors and Bussing:** Extruded aluminum connectors and bus bars are tin plated.
- **Cover:** Lift handles provided along with a cover sealing provision. A removable, sealable cover is provided at both ends for pull box assembly.
- **Hardware:** Meter socket mounting hardware included.
- Suitable for use on line side of service equipment.



Please consult serving utility for their requirements prior to ordering or installing, as specifications and approvals vary by utility, and may require local electrical inspector approval. All installations must be installed by a licensed electrician and must comply with all national and local codes, laws and regulations. Milbank reserves the right to make changes in specifications and features shown without notice or obligation.

# Bussed Gutters

Type 3R | 3Ø4W | 600 VAC



- Enclosure without knockouts
- Tin plated aluminum bus bars
- Furnished with line lugs only
- Bus is drilled and tapped for easy installation of load lugs

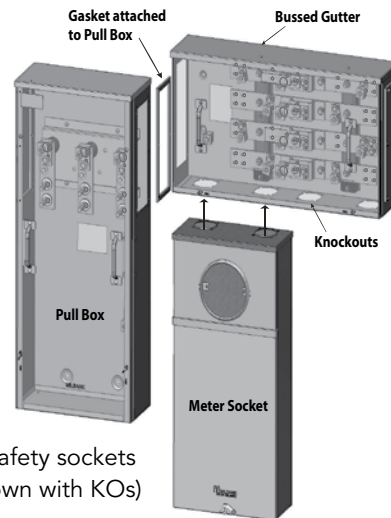

Typical application of safety sockets with multi-metering (shown with KOs)

## Bussed Gutters | Type 3R | 1Ø4W | 600 VAC

| Catalog Number | Meter Position | Amp | Dimensions |    |    | Length of Bus | Line Lugs Per Each Bus |
|----------------|----------------|-----|------------|----|----|---------------|------------------------|
|                |                |     | D"         | W" | H" |               |                        |
| U3412-O        | 2              | 400 | 6          | 24 | 24 | 17" Bar       | (1) 600                |
| U3413-O        | 3              | 600 | 6          | 36 | 24 | 24" Bars      | (2) 600                |
| U3414-O        | 4              | 800 | 6          | 48 | 24 | 32" Bars      | (3) 600                |
| U3415-O        | 5              | 800 | 6          | 60 | 24 | 40" Bars      | (3) 600                |
| U3416-O        | 6              | 800 | 6          | 72 | 24 | 56" Bars      | (3) 600                |

## Bussed Gutters | Type 3R | 3Ø4W | 600 VAC

| Catalog Number | Meter Position | Amp | Dimensions |    |    | Length of Bus | Line Lugs Per Each Bus |
|----------------|----------------|-----|------------|----|----|---------------|------------------------|
|                |                |     | D"         | W" | H" |               |                        |
| U3462-O        | 2              | 400 | 6          | 24 | 24 | 17" Bar       | (1) 600                |
| U3463-O        | 3              | 600 | 6          | 36 | 24 | 24" Bars      | (2) 600                |
| U3464-O        | 4              | 800 | 6          | 48 | 24 | 32" Bars      | (3) 600                |
| U3465-O        | 5              | 800 | 6          | 60 | 24 | 40" Bars      | (3) 600                |
| U3466-O        | 6              | 800 | 6          | 72 | 24 | 56" Bars      | (3) 600                |

### Notes

- **Short Circuit Current Withstanding Rating:** The 400 and 600 amp units have a withstand rating of 50K amp, and the 800 amp units have a rating of 65K amp.
- Suitable for use on line side of service equipment.

Please consult serving utility for their requirements prior to ordering or installing, as specifications and approvals vary by utility, and may require local electrical inspector approval. All installations must be installed by a licensed electrician and must comply with all national and local codes, laws and regulations. Milbank reserves the right to make changes in specifications and features shown without notice or obligation.





U8032-XL

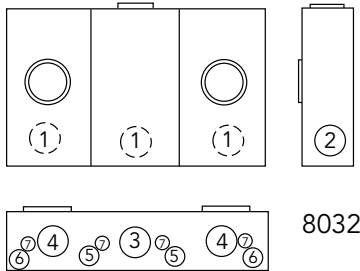

8032



U3522-XL-K1

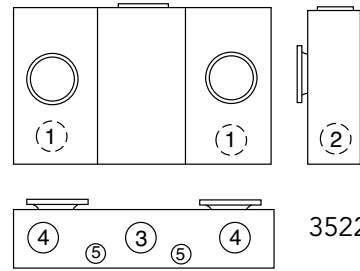

3522

100 Amp per Position | 4 Terminal | Multi-Position | Horizontal Gangs | Ringless

| Catalog Number | Positions | Service | Hub  | Connectors CU/AL |        | Dimensions |     |    | Knockouts |   |    |       |   |   |   |
|----------------|-----------|---------|------|------------------|--------|------------|-----|----|-----------|---|----|-------|---|---|---|
|                |           |         |      | Line             | Load   | D"         | W"  | H" | 1         | 2 | 3  | 4     | 5 | 6 | 7 |
| U8032-XL       | 2         | OH/UG   | C.P. | #2-350           | #6-2/0 | 4½         | 24½ | 16 | 2         | 2 | 2½ | 2     | ½ | ½ | ⅝ |
| U8033-XL       | 3         | OH/UG   | C.P. | #2-350           | #6-2/0 | 4½         | 32¾ | 16 | 2         | 2 | 2½ | (3) 2 | ½ | ½ | ⅝ |
| U8034-XL       | 4         | OH/UG   | C.P. | #2-350           | #6-2/0 | 4½         | 40⅞ | 16 | 2         | 2 | 2½ | (4) 2 | ½ | ½ | ⅝ |
| U8035-XL       | 5         | OH/UG   | C.P. | #2-350           | #6-2/0 | 4½         | 49⅙ | 16 | 2         | 2 | 2½ | (5) 2 | ½ | ½ | ⅝ |
| U8036-XL       | 6         | OH/UG   | C.P. | #2-350           | #6-2/0 | 4½         | 57¼ | 16 | 2         | 2 | 2½ | (6) 2 | ½ | ½ | ⅝ |

125 Amp per Position | 4 Terminal | Multi-Position | Horizontal Gangs | Ring Type

| Catalog Number | Positions | Service | Hub  | Connectors CU/AL |        | Dimensions |     |    | Knockouts |    |    |        |      |   |
|----------------|-----------|---------|------|------------------|--------|------------|-----|----|-----------|----|----|--------|------|---|
|                |           |         |      | Line             | Load   | D"         | W"  | H" | 1         | 2  | 3  | 4      | 5    | 6 |
| U3522-XL-K1    | 2         | OH/UG   | C.P. | #2-350           | #6-2/0 | 4½         | 24½ | 14 | 1½        | 1½ | 2½ | 2½     | ¼, ½ | ½ |
| U3523-XL-K1    | 3         | OH/UG   | C.P. | #2-350           | #6-2/0 | 4½         | 32¾ | 14 | 1½        | 1½ | 2½ | (3) 2½ | ¼, ½ | ½ |
| U3524-XL-K2    | 4         | OH/UG   | C.P. | #2-350           | #6-2/0 | 4½         | 40⅞ | 14 | 1½        | 1½ | 2½ | (4) 2½ | ¼, ½ | ½ |
| U3525-XL-K2    | 5         | UG      | C.P. | #2-350           | #6-2/0 | 4½         | 49⅙ | 14 | 1½        | 1½ | 2½ | (5) 2½ | ¼, ½ | ½ |

## Notes

- **Fifth Terminal:** For field mounted fifth terminal, order catalog number **5T8K2** (6 o'clock only on 100 amp units, 9 o'clock only on 125 amp units).
- **Hubs:** For proper hub selection, see the hub suffix chart on the accessory page.
- **Sealing Rings:** Ring type units are supplied with one **MR-4** screw type sealing ring per position.



Please consult serving utility for their requirements prior to ordering or installing, as specifications and approvals vary by utility, and may require local electrical inspector approval. All installations must be installed by a licensed electrician and must comply with all national and local codes, laws and regulations. Milbank reserves the right to make changes in specifications and features shown without notice or obligation.



# Multi-Position Sockets

200 Amp | 4 Terminal | Ringless | 300 VAC

**49**  
200 AMP  
MULTI-POSITION  
SOCKETS



U1252-X-K1

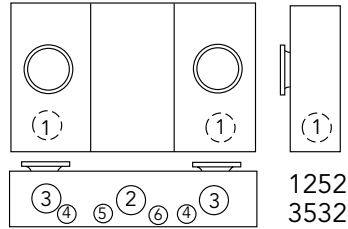

1252  
3532

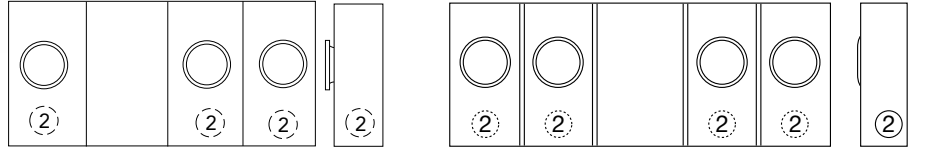

1253-6  
3533-6

1254  
3534

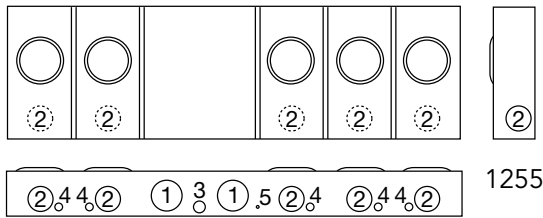

1255

1256

## 200 Amp per Position | 4 Terminal | Multi-Position | Horizontal Gangs | Ringless

| Catalog Number | Positions | Service | Hub  | Connectors CU/AL |        | Dimensions      |                  |    | Knockouts       |                 |                 |               |               |  |
|----------------|-----------|---------|------|------------------|--------|-----------------|------------------|----|-----------------|-----------------|-----------------|---------------|---------------|--|
|                |           |         |      | Line             | Load   | D"              | W"               | H" | 1               | 2               | 3               | 4             | 5             |  |
| U1252-X-K1     | 2         | OH/UG   | C.P. | #6-350           | #2-350 | 5 $\frac{1}{8}$ | 26 $\frac{1}{2}$ | 14 | 2 $\frac{1}{2}$ | 3               | 2 $\frac{1}{2}$ | $\frac{1}{2}$ | $\frac{1}{4}$ |  |
| U1253-X-K3     | 3         | OH/UG   | C.P. | #4-600           | #2-350 | 5 $\frac{1}{8}$ | 34 $\frac{3}{4}$ | 14 | 3               | 2 $\frac{1}{2}$ | $\frac{1}{2}$   | $\frac{1}{4}$ | 1             |  |
| U1254-X-K3     | 4         | OH/UG   | C.P. | #4-600           | #2-350 | 5 $\frac{1}{8}$ | 42 $\frac{7}{8}$ | 16 | 3               | 2 $\frac{1}{2}$ | 1               | $\frac{1}{2}$ | $\frac{1}{4}$ |  |
| U1255-X-K4     | 5         | OH/UG   | C.P. | (2) #2-600       | #2-350 | 5 $\frac{1}{8}$ | 54 $\frac{7}{8}$ | 16 | 3               | 2 $\frac{1}{2}$ | 1               | $\frac{1}{2}$ | $\frac{1}{4}$ |  |
| U1256-X-K4     | 6         | OH/UG   | C.P. | (2) #2-600       | #2-350 | 5 $\frac{1}{8}$ | 63 $\frac{1}{6}$ | 18 | 3               | 2 $\frac{1}{2}$ | 1               | $\frac{1}{2}$ | $\frac{1}{4}$ |  |

## 200 Amp per Position | 4 Terminal | Multi-Position | Horizontal Gangs | Ring Type

| Catalog Number | Positions | Service | Hub  | Connectors CU/AL |        | Dimensions      |                  |    | Knockouts       |                 |                 |               |               |   |
|----------------|-----------|---------|------|------------------|--------|-----------------|------------------|----|-----------------|-----------------|-----------------|---------------|---------------|---|
|                |           |         |      | Line             | Load   | D"              | W"               | H" | 1               | 2               | 3               | 4             | 5             | 6 |
| U3532-X-K1     | 2         | OH/UG   | C.P. | #6-350           | #2-350 | 5 $\frac{1}{8}$ | 26 $\frac{1}{2}$ | 16 | 2 $\frac{1}{2}$ | 3               | 2 $\frac{1}{2}$ | —             | $\frac{1}{2}$ | 1 |
| U3533-X-K3     | 3         | OH/UG   | C.P. | #4-600           | #2-350 | 5 $\frac{1}{8}$ | 34 $\frac{1}{2}$ | 16 | 3               | 2 $\frac{1}{2}$ | —               | $\frac{1}{4}$ | $\frac{1}{2}$ | — |
| U3534-X-K3     | 4         | OH/UG   | C.P. | #4-600           | #2-350 | 5 $\frac{1}{8}$ | 42 $\frac{7}{8}$ | 16 | 3               | 2 $\frac{1}{2}$ | 1               | —             | $\frac{1}{2}$ | — |

### Notes

- **Fifth Terminal:** For field mounted fifth terminal, order catalog number **5T8K2** (6 o'clock only on 100 amp units, 9 o'clock only on 125 amp units).
- **Hubs:** For proper hub selection, see the hub suffix chart on the accessory page.
- **Sealing Rings:** Ring type units are supplied with one **MR-4** screw type sealing ring per position.

Please consult serving utility for their requirements prior to ordering or installing, as specifications and approvals vary by utility, and may require local electrical inspector approval. All installations must be installed by a licensed electrician and must comply with all national and local codes, laws and regulations. Milbank reserves the right to make changes in specifications and features shown without notice or obligation.



# 50

125-200 AMP  
MULTI-POSITION  
METER MAINS

# Multi-Position Meter Mains

125-200 Amp | 4 Terminal | Ringless | 120/240 VAC



U2854-X

125 Amp | Position



U2866-X

200 Amp | Position

## VERTICAL

| Catalog Number | Positions | Main Bus Rating | Connectors CU/AL |
|----------------|-----------|-----------------|------------------|
|                |           |                 | Line             |
| U2852-X        | 2         | 200 Amp         | *3/8"-16 STUD    |
| U2853-X        | 3         | 200 Amp         | *3/8"-16 STUD    |

| Catalog Number | Positions | Main Bus Rating | Connectors CU/AL |
|----------------|-----------|-----------------|------------------|
|                |           |                 | Line             |
| U2862-X        | 2         | 250 Amp         | *3/8"-16 STUD    |
| U2863-X        | 3         | 300 Amp         | *3/8"-16 STUD    |

## RECTANGULAR

125 Amp | Position

200 Amp | Position

| Catalog Number | Positions | Main Bus Rating | Connectors CU/AL |
|----------------|-----------|-----------------|------------------|
|                |           |                 | Line             |
| U2854-X        | 4         | 400 Amp         | *3/8"-16 STUD    |
| U2855-X        | 5         | 400 Amp         | *3/8"-16 STUD    |
| U2856-X        | 6         | 400 Amp         | *3/8"-16 STUD    |

| Catalog Number | Positions | Main Bus Rating | Connectors CU/AL |
|----------------|-----------|-----------------|------------------|
|                |           |                 | Line             |
| U2864-X        | 4         | 400 Amp         | *3/8"-16 STUD    |
| U2865-X        | 5         | 400 Amp         | *3/8"-16 STUD    |
| U2866-X        | 6         | 400 Amp         | *3/8"-16 STUD    |

## Connector Kits

| Size   | Suffix | Kit Number | Compatible With      | Wire Range |
|--------|--------|------------|----------------------|------------|
| SINGLE | -K1    | K1539      | U2852-56<br>U2862-66 | #6-350     |
|        | -K3    | K1540      | U2854-56<br>U2864-66 | #4-600     |
| TWIN   | -K2    | K1350      | U2854-56<br>U2863-66 | #6-350     |
|        | -K4    | K1541      | U2864-66             | #2-600     |

**Connectors:** For line wire connector kits, order separately.

**Fifth Terminal:** For field mounted fifth terminal order catalog number **K2381**. Order one per meter position (9 o'clock position only).

**Breakers:** Units have provision for one double pole main per meter position. Breakers not included. Order as extra Milbank.

\*To add lugs, refer to the connector kits available in the Connector Kits table.

| Amp     | Cutler-Hammer (Westinghouse) | Simens (ITE) | Siemens Murray/ Crouse-Hinds | G.E. | SQ-D     |
|---------|------------------------------|--------------|------------------------------|------|----------|
| 150-200 | HQP/BR/WBJ                   | QN           | MD                           | THQ  |          |
| ≤125    | QP/BR/HQP                    | QP           | MP                           | THQ  | Homeline |



Please consult serving utility for their requirements prior to ordering or installing, as specifications and approvals vary by utility, and may require local electrical inspector approval. All installations must be installed by a licensed electrician and must comply with all national and local codes, laws and regulations. Milbank reserves the right to make changes in specifications and features shown without notice or obligation.

# Multi-Position Meter Mains

125-200 Amp | 22K AIC Rated | 240 VAC

# 51

125-200 AMP  
MULTI-POSITION  
METER MAINS



U2852-X

## CONDOMINIUM METERING BANKS

### VERTICAL

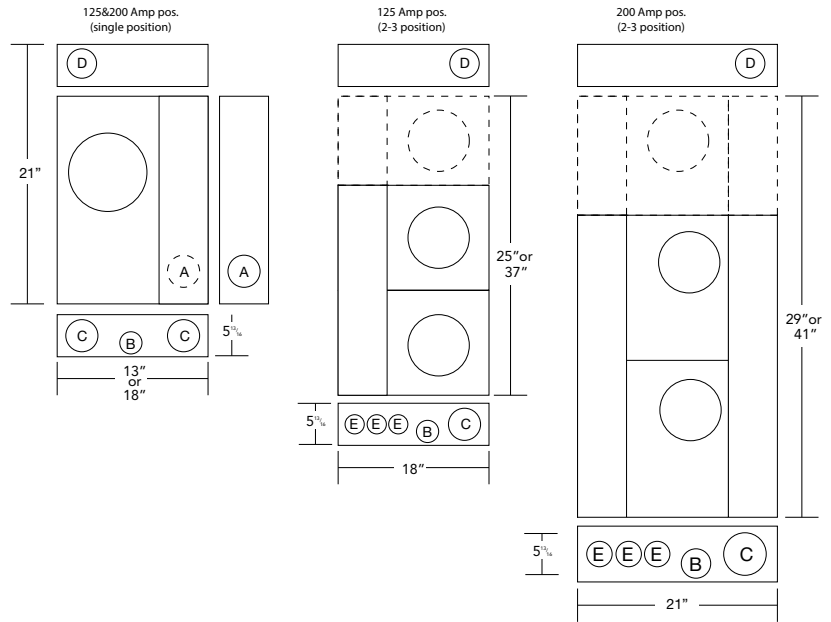

### RECTANGULAR

| Knockouts |           |
|-----------|-----------|
| A         | 1 1/4"    |
| B         | 1/4, 1/2" |
| C         | 3"        |
| D         | 4"        |
| E         | 2"        |

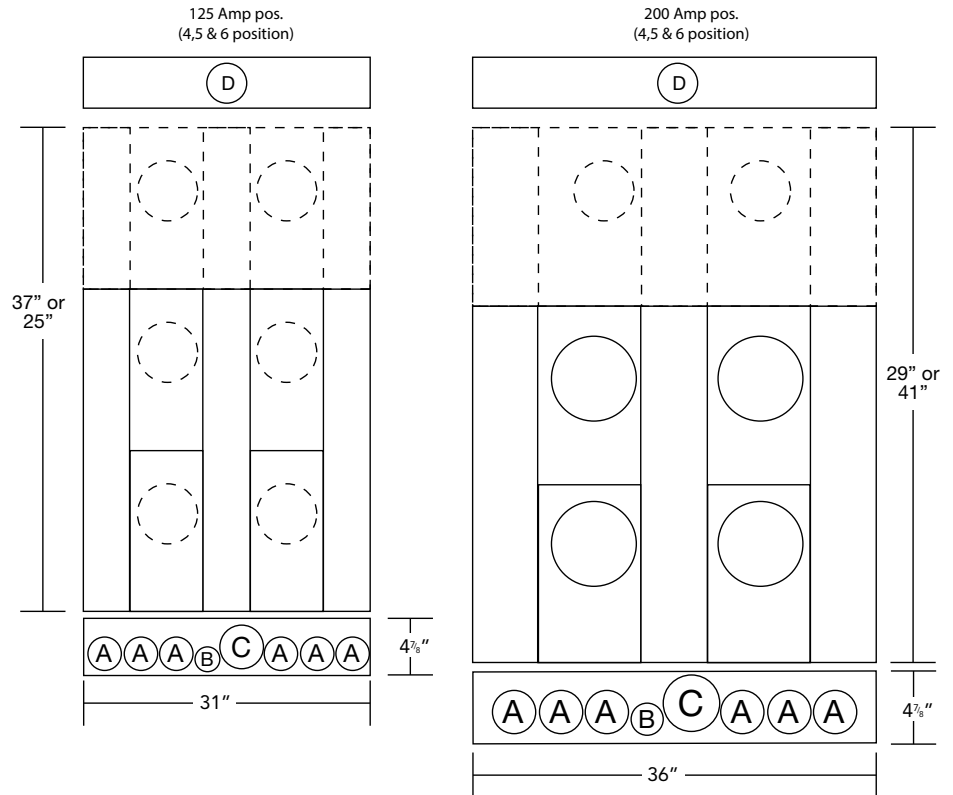

Please consult serving utility for their requirements prior to ordering or installing, as specifications and approvals vary by utility, and may require local electrical inspector approval. All installations must be installed by a licensed electrician and must comply with all national and local codes, laws and regulations. Milbank reserves the right to make changes in specifications and features shown without notice or obligation.



# 52

125-200 AMP  
MULTI-POSITION  
METER MAINS

# Multi-Position Meter Mains

125-200 Amp | 22K AIC Rated | 240 VAC



U5882-X



U5884-X

## 4 Terminal | Multi-Position Meter Main | Ringless

| Catalog Number | Amp | Positions | Service | Hub  | Connectors CU/AL | Bypass | Dimensions |          |     | Weight (lbs.) |
|----------------|-----|-----------|---------|------|------------------|--------|------------|----------|-----|---------------|
|                |     |           |         |      | Line             |        | D"         | W"       | H"  |               |
| U5902-X        | 125 | 2         | OH/UG   | C.P. | 3/8" x 16 Stud   | None   | 5 1/8"     | 26 1/2"  | 30" | 58            |
| U5903-X        | 125 | 3         | OH/UG   | C.P. | 3/8" x 16 Stud   | None   | 5 1/8"     | 34 5/8"  | 30" | 88            |
| U5904-X        | 125 | 4         | OH/UG   | C.P. | 3/8" x 16 Stud   | None   | 5 1/8"     | 42 5/8"  | 30" | 107           |
| U5905-X        | 125 | 5         | OH/UG   | C.P. | 3/8" x 16 Stud   | None   | 5 1/8"     | 51 1/20" | 30" | 128           |
| U5906-X        | 125 | 6         | OH/UG   | C.P. | 3/8" x 16 Stud   | None   | 5 1/8"     | 59 3/10" | 30" | 146           |
| U5882-X        | 200 | 2         | OH/UG   | C.P. | 3/8" x 16 Stud   | None   | 5 1/8"     | 26 1/2"  | 30" | 58            |
| U5883-X        | 200 | 3         | OH/UG   | C.P. | 3/8" x 16 Stud   | None   | 5 1/8"     | 34 5/8"  | 30" | 88            |
| U5884-X        | 200 | 4         | OH/UG   | C.P. | 3/8" x 16 Stud   | None   | 5 1/8"     | 42 5/8"  | 30" | 107           |
| U5885-X        | 200 | 5         | OH/UG   | C.P. | 3/8" x 16 Stud   | None   | 5 1/8"     | 51 1/20" | 30" | 128           |
| U5886-X        | 200 | 6         | OH/UG   | C.P. | 3/8" x 16 Stud   | None   | 5 1/8"     | 59 3/10" | 30" | 146           |

## Notes

- **Knockouts:** See drawings on the next page.
- **Optional:** Factory installed breakers are available—consult factory.
- **AIC Rating:** All models are rated 22K AIC when used with approved breakers rated at 22K.
- **Hub:** Units supplied with one (1) closing plate. Order hubs separately, see accessories page.
- **Fifth Terminal:** For field installed fifth terminal, order **K5T**.
- **Connectors:** Socket is supplied with 3/8" - 16 hex head nuts with Belleville washers. For connector lug kits, order as extra from chart on the accessories page. Separate lug kits are required for line and load.

## Breaker Chart - 10K AIC (unless noted 22K)

| Manufacturer    | Cutler Hammer | Siemens       | G.E. (50 Amp Max) | Square D |
|-----------------|---------------|---------------|-------------------|----------|
| 125 Amp or Less | BR, HQP, QPGF | QP, QPH (22K) | THQL, THQL-GF     | Homeline |
| 150-200 Amp     |               | QN, QNH (22K) | —                 | —        |



Please consult serving utility for their requirements prior to ordering or installing, as specifications and approvals vary by utility, and may require local electrical inspector approval. All installations must be installed by a licensed electrician and must comply with all national and local codes, laws and regulations. Milbank reserves the right to make changes in specifications and features shown without notice or obligation.

# Multi-Position Meter Mains

U5902 & U5882 Series | Dimensional Information

# 53

125-200 AMP  
MULTI-POSITION  
METER MAINS

| Knockouts |    |   |     |   |
|-----------|----|---|-----|---|
| 1         | 2  | 3 | 4   | 5 |
| 3         | 2½ | 1 | 7/8 | ¼ |

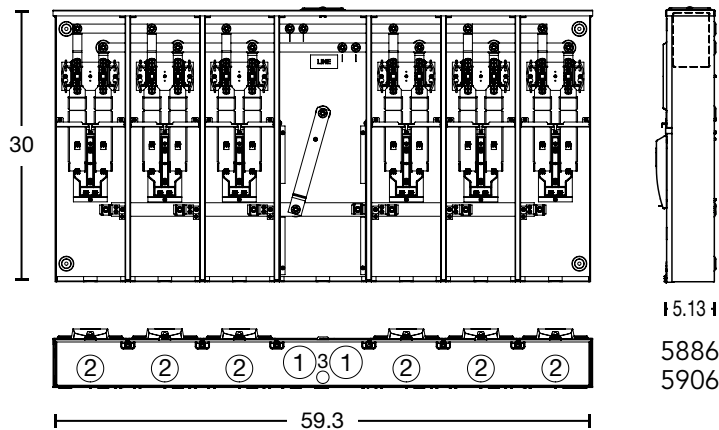
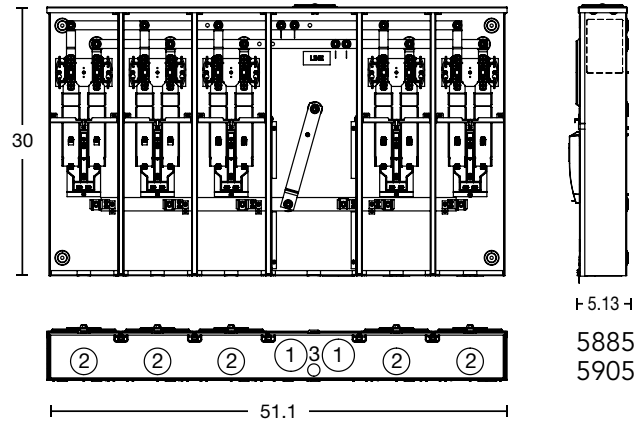
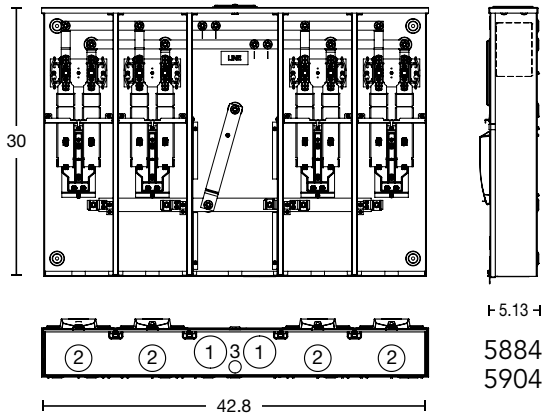
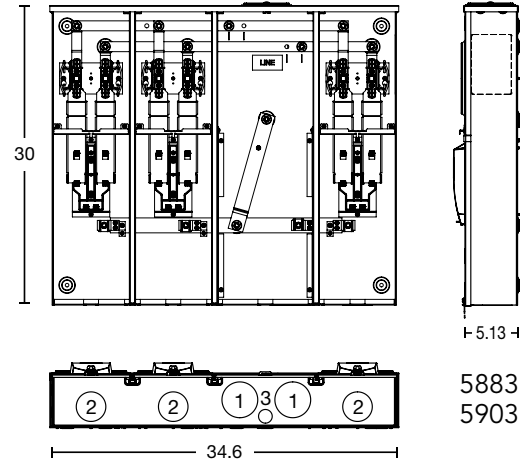
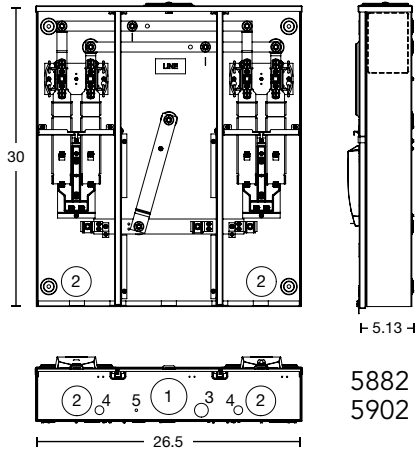

Please consult serving utility for their requirements prior to ordering or installing, as specifications and approvals vary by utility, and may require local electrical inspector approval. All installations must be installed by a licensed electrician and must comply with all national and local codes, laws and regulations. Milbank reserves the right to make changes in specifications and features shown without notice or obligation.





UC7582-XL

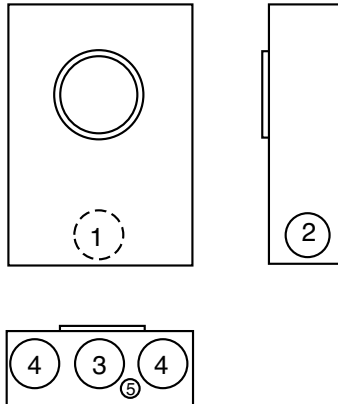

UC7237-RL

**20 Amp | Ringless | Plunger Type Bypass | Overhead/Underground**

| Catalog Number | Terminal | Meter Form           | Hub  | Bypass   | Connectors CU/AL |      | Dimensions                     |    |    | Knockouts                     |                               |   |                               |                               |
|----------------|----------|----------------------|------|----------|------------------|------|--------------------------------|----|----|-------------------------------|-------------------------------|---|-------------------------------|-------------------------------|
|                |          |                      |      |          | Line             | Load | D"                             | W" | H" | 1                             | 2                             | 3 | 4                             | 5                             |
| UC1290-XL      | 5        | 3S                   | C.P. | Plunger* | #14 - #10        |      | 3 <sup>5</sup> / <sub>16</sub> | 8  | 14 | 1 <sup>1</sup> / <sub>2</sub> | 1 <sup>1</sup> / <sub>2</sub> | 2 | 1 <sup>1</sup> / <sub>4</sub> | 1 <sup>1</sup> / <sub>4</sub> |
| UC1299-XL      | 6        | 4S                   | C.P. | Plunger* | #14 - #10        |      | 3 <sup>5</sup> / <sub>16</sub> | 8  | 14 | 1 <sup>1</sup> / <sub>2</sub> | 1 <sup>1</sup> / <sub>2</sub> | 2 | 1 <sup>1</sup> / <sub>4</sub> | 1 <sup>1</sup> / <sub>4</sub> |
| UC7233-XL      | 7        | 7, 14, 15 & 24 S     | C.P. | Plunger* | #14 - #10        |      | 3 <sup>5</sup> / <sub>16</sub> | 8  | 14 | 1 <sup>1</sup> / <sub>2</sub> | 1 <sup>1</sup> / <sub>2</sub> | 2 | 1 <sup>1</sup> / <sub>4</sub> | 1 <sup>1</sup> / <sub>4</sub> |
| UC7235-XL      | 8        | 5S                   | C.P. | Plunger* | #14 - #10        |      | 3 <sup>5</sup> / <sub>16</sub> | 8  | 14 | 1 <sup>1</sup> / <sub>2</sub> | 1 <sup>1</sup> / <sub>2</sub> | 2 | 1 <sup>1</sup> / <sub>4</sub> | 1 <sup>1</sup> / <sub>4</sub> |
| UC7237-XL      | 13       | 6, 8, 9S & (ALT) 10S | C.P. | Plunger* | #14 - #10        |      | 3 <sup>5</sup> / <sub>16</sub> | 8  | 14 | 1 <sup>1</sup> / <sub>2</sub> | 1 <sup>1</sup> / <sub>2</sub> | 2 | 1 <sup>1</sup> / <sub>4</sub> | 1 <sup>1</sup> / <sub>4</sub> |

**20 Amp | Ring Type | Plunger Type Bypass | Overhead/Underground**

| Catalog Number | Terminal | Meter Form           | Hub  | Bypass   | Connectors CU/AL |      | Dimensions                     |    |    | Knockouts                     |                               |                               |                               |                               |
|----------------|----------|----------------------|------|----------|------------------|------|--------------------------------|----|----|-------------------------------|-------------------------------|-------------------------------|-------------------------------|-------------------------------|
|                |          |                      |      |          | Line             | Load | D"                             | W" | H" | 1                             | 2                             | 3                             | 4                             | 5                             |
| UC1291-RL      | 5        | 3S                   | H.O. | Plunger* | #14 - #10 Max    |      | 3 <sup>5</sup> / <sub>16</sub> | 8  | 14 | 1 <sup>1</sup> / <sub>2</sub> | 1 <sup>1</sup> / <sub>2</sub> | 1 <sup>1</sup> / <sub>4</sub> | 1 <sup>1</sup> / <sub>4</sub> | 1 <sup>1</sup> / <sub>4</sub> |
| UC1300-RL      | 6        | 4S                   | H.O. | Plunger* | #14 - #10 Max    |      | 3 <sup>5</sup> / <sub>16</sub> | 8  | 14 | 1 <sup>1</sup> / <sub>2</sub> | 1 <sup>1</sup> / <sub>2</sub> | 1 <sup>1</sup> / <sub>4</sub> | 1 <sup>1</sup> / <sub>4</sub> | 1 <sup>1</sup> / <sub>4</sub> |
| UC7544-RL      | 7        | 5S                   | H.O. | Plunger* | #14 - #10 Max    |      | 3 <sup>5</sup> / <sub>16</sub> | 8  | 14 | 1 <sup>1</sup> / <sub>2</sub> | 1 <sup>1</sup> / <sub>2</sub> | 1 <sup>1</sup> / <sub>4</sub> | 1 <sup>1</sup> / <sub>4</sub> | 1 <sup>1</sup> / <sub>4</sub> |
| UC7545-RL      | 8        | 6, 8, 9S & (ALT) 10S | H.O. | Plunger* | #14 - #10 Max    |      | 3 <sup>5</sup> / <sub>16</sub> | 8  | 14 | 1 <sup>1</sup> / <sub>2</sub> | 1 <sup>1</sup> / <sub>2</sub> | 1 <sup>1</sup> / <sub>4</sub> | 1 <sup>1</sup> / <sub>4</sub> | 1 <sup>1</sup> / <sub>4</sub> |
| UC7582-RL      | 13       | 6, 8, 9S & (ALT) 10S | C.P. | None     | #14 - #10 Max    |      | 3 <sup>5</sup> / <sub>16</sub> | 8  | 14 | 1 <sup>1</sup> / <sub>2</sub> | 1 <sup>1</sup> / <sub>2</sub> | 1 <sup>1</sup> / <sub>4</sub> | 1 <sup>1</sup> / <sub>4</sub> | 1 <sup>1</sup> / <sub>4</sub> |

**Notes**

- **Hubs:** For proper hub selection see the hub suffix chart on the accessory page.
- **Connectors:** Units are supplied with sleeve type connectors (#14-#2).
- \* **Bypass:** Plunger type bypass automatically closes when meter is removed.



Please consult serving utility for their requirements prior to ordering or installing, as specifications and approvals vary by utility, and may require local electrical inspector approval. All installations must be installed by a licensed electrician and must comply with all national and local codes, laws and regulations. Milbank reserves the right to make changes in specifications and features shown without notice or obligation.

# Current Transformer

20 Amp | 5, 6, 8, 13, & 15 Terminal | 600 VAC

**55**  
CURRENT  
TRANSFORMER



UC3438-XL



UC3426-XL

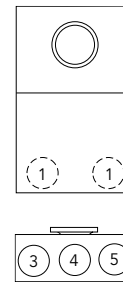
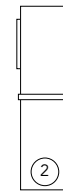
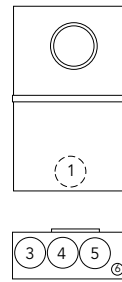

3425  
3426  
3428  
3423  
7636  
7461

3435  
3436  
3438  
3433  
3434

## 20 Amp | Ringless | With Provision for Test Switch | Two-Piece Front

| Catalog Number | Terminal | Meter Form           | Service | Hub  | Bypass | Connectors CU/AL |          | Dimensions |    |    | Knockouts |    |    |    |    |      |
|----------------|----------|----------------------|---------|------|--------|------------------|----------|------------|----|----|-----------|----|----|----|----|------|
|                |          |                      |         |      |        | Line             | Load     | D"         | W" | H" | 1         | 2  | 3  | 4  | 5  | 6    |
| UC3425-XL      | 5        | 3S                   | OH/UG   | C.P. | None   | #14 - #2         | #14 - #2 | 5½         | 12 | 20 | 1¼        | 1¼ | 1¼ | 1¼ | 1¼ | ¼, ½ |
| UC3426-XL      | 6        | 4S                   | OH/UG   | C.P. | None   | #14 - #2         | #14 - #2 | 5½         | 12 | 20 | 1¼        | 1¼ | 1¼ | 1¼ | 1¼ | ¼, ½ |
| UC3428-XL      | 8        | 5S                   | OH/UG   | C.P. | None   | #14 - #2         | #14 - #2 | 5½         | 12 | 20 | 1¼        | 1¼ | 1¼ | 1¼ | 1¼ | ¼, ½ |
| UC3423-XL      | 13       | 6, 8, 9S & (ALT) 10S | OH/UG   | C.P. | None   | #14 - #2         | #14 - #2 | 5½         | 12 | 20 | 1¼        | 1¼ | 1¼ | 1¼ | 1¼ | ¼, ½ |

## 20 Amp | Ring Type | Test Switch Factory Prewired | Two-Piece Front

Approved for Tucson Electric Power

| Catalog Number    | Terminal | Service | Hub | Bypass      | Connectors CU/AL |          | Dimensions |    |    | Knockouts |    |    |    |    |    |      |
|-------------------|----------|---------|-----|-------------|------------------|----------|------------|----|----|-----------|----|----|----|----|----|------|
|                   |          |         |     |             | Line             | Load     | D"         | W" | H" | 1         | 2  | 3  | 4  | 5  | 6  |      |
| UC7636-YL-TGE-DES | 6        | OH      | 1¼  | Test Switch | #14 - #2         | #14 - #2 | 4½         | 12 | 20 | 1¼        | 1¼ | 1¼ | 1¼ | 1¼ | 1¼ | ¼, ½ |
| UC7461-YL-TGE-DES | 13       | OH      | 1¼  | Test Switch | #14 - #2         | #14 - #2 | 4½         | 12 | 20 | 1¼        | 1¼ | 1¼ | 1¼ | 1¼ | 1¼ | ¼, ½ |

## 20 Amp | Ring Type | With Provision for Test Switch | EUSERC Compliant | Two-Piece Front

| Catalog Number | Terminal | Service | Hub  | Bypass | Connectors CU/AL |          | Dimensions |    |    | Knockouts |   |   |   |   |   |   |
|----------------|----------|---------|------|--------|------------------|----------|------------|----|----|-----------|---|---|---|---|---|---|
|                |          |         |      |        | Line             | Load     | D"         | W" | H" | 1         | 2 | 3 | 4 | 5 | 6 |   |
| UC3435-XL      | 5        | OH/UG   | C.P. | None   | #14 - #2         | #14 - #2 | 5½         | 12 | 20 | 2         | 2 | 2 | 2 | 2 | 2 | - |
| UC3436-XL      | 6        | OH/UG   | C.P. | None   | #14 - #2         | #14 - #2 | 5½         | 12 | 20 | 2         | 2 | 2 | 2 | 2 | 2 | - |
| UC3438-XL      | 8        | OH/UG   | C.P. | None   | #14 - #2         | #14 - #2 | 5½         | 12 | 20 | 2         | 2 | 2 | 2 | 2 | 2 | - |
| UC3433-XL      | 13       | OH/UG   | C.P. | None   | #14 - #2         | #14 - #2 | 5½         | 12 | 20 | 2         | 2 | 2 | 2 | 2 | 2 | - |
| UC3434-XL      | 15       | OH/UG   | C.P. | None   | #14 - #2         | #14 - #2 | 5½         | 12 | 20 | 2         | 2 | 2 | 2 | 2 | 2 | - |

### Notes

- **Prewiring:** If factory prewiring is required consult factory before ordering. Please include meter socket catalog number, test switch number, meter form number, and a copy of your wiring diagram.
- **Test Switch Covers:** Units on this page can be used with clear lexan cover (except units **7636** and **7461**).
- **Connectors:** Units are supplied with sleeve type connectors (#14-#2).
- **Hubs:** For proper hub selection see the hub suffix chart in accessory section.

Please consult serving utility for their requirements prior to ordering or installing, as specifications and approvals vary by utility, and may require local electrical inspector approval. All installations must be installed by a licensed electrician and must comply with all national and local codes, laws and regulations. Milbank reserves the right to make changes in specifications and features shown without notice or obligation.



## Current Transformer Test Switches

4, 7, &amp; 10 Pole

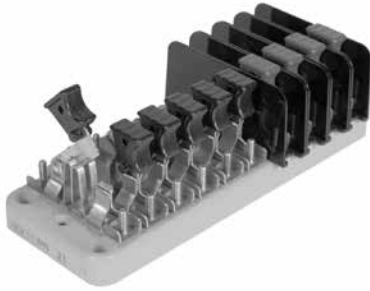
**SWITCH BLADES**

Two dimples coined into one side of the switch blade ensure positive contact in corrosive, sooty environments – even after years of inactivity.

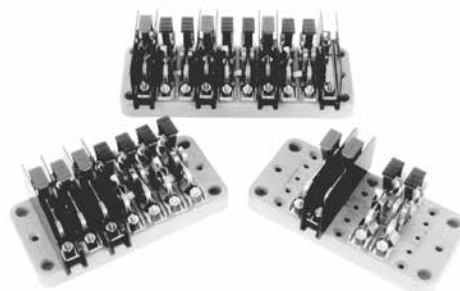
**TEST SWITCH BASE**

The base is molded from a high strength, fiberglass reinforced, thermoset polyester. This material is track resistant, flame retardant and has low water absorption qualities. Bases are available in 7 pole and 10 pole sizes.

**POLARITY BARRIER**

For maximum protection potential circuits are supplied with permanently mounted, rigid barriers made from high tensile strength, polycarbonate.

**TEST SWITCH COVERS**

Standard test switch covers are made from break resistant, clear, thermal plastic which has excellent tracking and moisture resistant properties. If covers are required, add suffix "-WC" (with cover) to the catalog number or order separately catalog number **K3388**. Black flush mount covers are also available. Order catalog number **K3388-BLK-FL**. 10 pole base only.

**SWITCH JAWS**

The switch blade jaw clips are constructed from spring grade copper alloy. The material and design ensure excellent contact which prevents overheating.

**CURRENT CARRYING PARTS**

Highly conductive copper and copper alloy materials are used on all current carrying parts. This ensures conductivity and deters corrosion. Spring grades are used where appropriate. Plating is available if required. Contact general offices to special order.

**STANDARD COVER****K3388**

Units must be  
5-1/8" deep  
for Cover

**FLUSH MOUNT COVER  
BLACK****K3388-BLK-FL****Notes**

- **Factory Installed:** For cover installed add the suffix **-WC** or **-WCFL** to the catalog number of desired test switch
- **Field Installed:** For field installed cover order kit number **K3388** or **K3388-BLK-FL**.

The MILBANK test switch is designed to meet the critical requirements of the electric utility industry. Not only do they meet EEI, ANSI C12.9, and UL standards but they combine several special features giving the MILBANK test switch increased safety, durability and reliability. One such feature is our unique switch blade contact points which cut through residue that builds up after years of service. Another distinction is our polarity barrier which is designed to be flexible as well as offer exceptional insulating qualities. Our test switches are constructed from the latest materials available using modern fabricating and assembly methods.



Please consult serving utility for their requirements prior to ordering or installing, as specifications and approvals vary by utility, and may require local electrical inspector approval. All installations must be installed by a licensed electrician and must comply with all national and local codes, laws and regulations. Milbank reserves the right to make changes in specifications and features shown without notice or obligation.



# Current Transformer Test Switches

4, 7, & 10 Pole | 600 VAC | Per Ansi C12.9 Standard

**57**  
CURRENT  
TRANSFORMER  
TEST SWITCHES

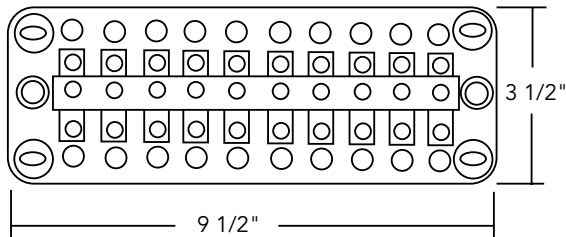
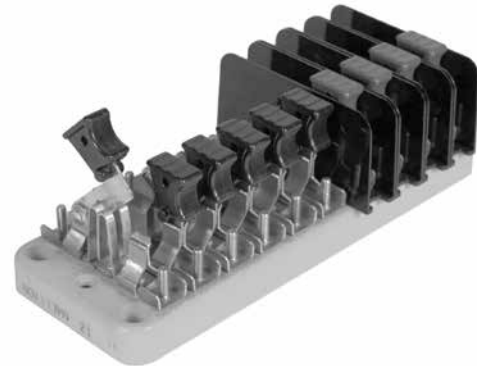
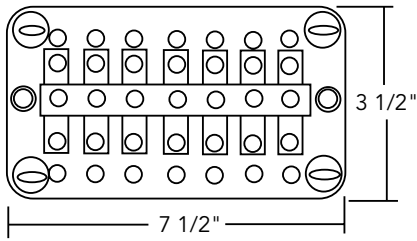

| Catalog Number | 4-POLE |    |    |   |    |    |   |
|----------------|--------|----|----|---|----|----|---|
| TS04-0101      | X      | P  | Pn | X | C+ | C  | X |
| TS04-0104      | X      | C+ | C  | X | P  | Pn | X |

| KEY |  |
|-----|--|
| P   | Potential Switch                                     |
| C+  | Line side current switch with short circuit assembly |
| C   | Load side current switch with test jack assembly     |
| N   | Neutral bar (no switch)                              |
| Pn  | Neutral potential switch                             |
| X   | Unused position on base                              |
|     | Line side current switch with short circuit assembly |

| Catalog Number | 7-POLE |   |    |    |   |    |   |
|----------------|--------|---|----|----|---|----|---|
| TS07-0105      | P      | P | Pn | C+ | C | C+ | C |

| Catalog Number | 7-POLE ON A 10-POLE BASE |   |    |   |    |    |    |    |   |    |
|----------------|--------------------------|---|----|---|----|----|----|----|---|----|
| TS07-0049      | P                        | X | P  | X | Pn | X  | C+ | C  | C | C+ |
| TS07-0106      | X                        | P | C+ | C | P  | C+ | C  | Pn | X | X  |

## CUSTOM POLE ARRANGEMENTS

The key may be used to diagram your own pole arrangement. Be sure to specify base size and whether all C+ line side, current switch/shunt circuit assemblies are to be bussed together. The catalog numbers shown above are connected in line-load pairs; therefore, if bussed is required, different catalog numbers will apply.

| Catalog Number | 10-POLE |    |    |    |    |    |    |    |    |    |
|----------------|---------|----|----|----|----|----|----|----|----|----|
| TS10-0109      | P       | P  | P  | Pn | C+ | C  | C+ | C  | C+ | C  |
| TS10-0110      | P       | C+ | C  | P  | C+ | C  | P  | C+ | C  | Pn |
| TS10-0111      | P       | P  | P  | Pn | C  | C+ | C  | C+ | C  | C+ |
| TS10-0112      | C+      | C  | C+ | C  | C+ | C  | P  | P  | P  | Pn |
| TS10-0016      | P       | P  | P  | PN | C  | C+ | C  | C+ | C  | C+ |

Please consult serving utility for their requirements prior to ordering or installing, as specifications and approvals vary by utility, and may require local electrical inspector approval. All installations must be installed by a licensed electrician and must comply with all national and local codes, laws and regulations. Milbank reserves the right to make changes in specifications and features shown without notice or obligation.



# Milbank Test Switch Worksheet



### TEST SWITCH BASE

The base is molded from a high strength, fiberglass reinforced, thermoset polyester. This material is track-resistant, flame-retardant and has low water absorption qualities. Bases are available in two standard sizes following NEMA mounting classifications.

Customer Name: \_\_\_\_\_

Email: \_\_\_\_\_

Phone: \_\_\_\_\_

| Handle Color Key |       |    |        |   |        |     |           |
|------------------|-------|----|--------|---|--------|-----|-----------|
| BK               | Black | P  | Purple | Y | Yellow | GN  | Green     |
| R                | Red   | BL | Blue   | W | White  | BKS | BK/Stripe |
| BR               | Brown | GR | Gray   | O | Orange | WS  | W/Stripe  |

### Pole Position Chart

| 1 | 2 | 3 | 4 | 5 | 6 | 7 | 8 | 9 | 10 |
|---|---|---|---|---|---|---|---|---|----|
|   |   |   |   |   |   |   |   |   |    |

### Special Features

| Features | 1 | 2 | 3 | 4 | 5 | 6 | 7 | 8 | 9 | 10 |
|----------|---|---|---|---|---|---|---|---|---|----|
|          |   |   |   |   |   |   |   |   |   |    |
|          |   |   |   |   |   |   |   |   |   |    |
|          |   |   |   |   |   |   |   |   |   |    |

Engineering Information: \_\_\_\_\_

\_\_\_\_\_

\_\_\_\_\_

| KEY |  |
|-----|--|
| P   | Potential Switch                                     |
| C+  | Line side current switch with short circuit assembly |
| C   | Load side current switch with test jack assembly     |
| N   | Neutral bar (no switch)                              |
| Pn  | Neutral potential switch                             |
| X   | Unused position on base                              |
|     | Line side current switch with short circuit assembly |

**Custom Pole Arrangements:** The key may be used to diagram your own pole arrangement. Be sure to specify base size and whether all C+ line side, current switch/shunt circuit assemblies are to be bussed together. The catalog numbers shown above are connected in line-load pairs; therefore, if bussed is required, different catalog numbers will apply.

#### Number of Poles

- 4
- 7
- 10
- Other \_\_\_\_\_

#### Test Switch Cover\*

- Yes    \_\_\_ Clear    \_\_\_ Black
- No

#### Base Size

- 7-Pole
- 10-Pole

\* Test switch covers are only available for 10-pole bases.



Please consult serving utility for their requirements prior to ordering or installing, as specifications and approvals vary by utility, and may require local electrical inspector approval. All installations must be installed by a licensed electrician and must comply with all national and local codes, laws and regulations. Milbank reserves the right to make changes in specifications and features shown without notice or obligation.

# Current Transformer Cabinets

## Door Mount CT Rated Socket & Type 3R

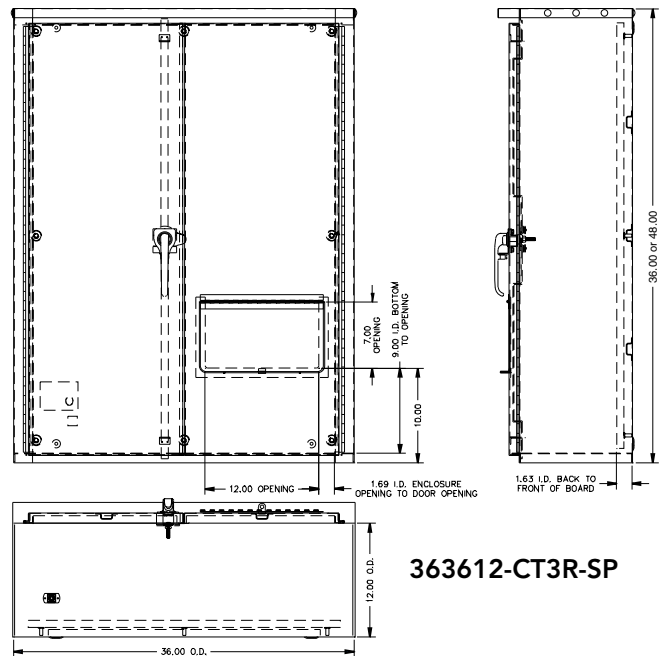
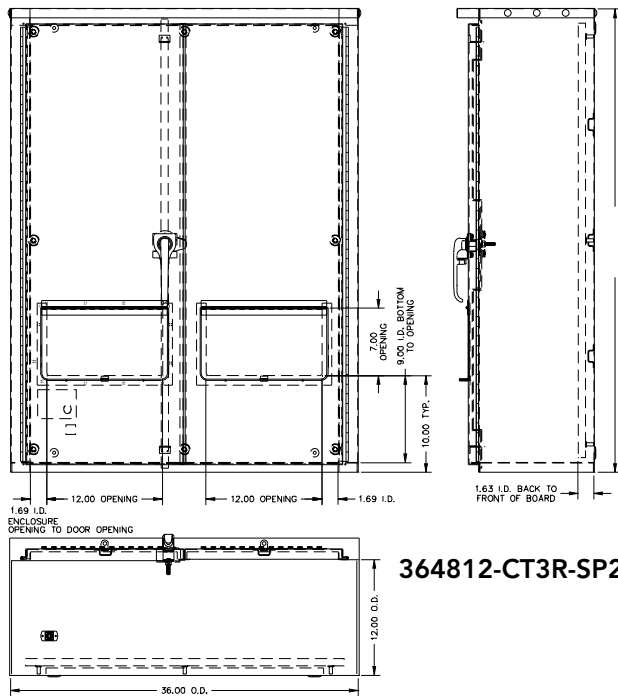

### Door Mount C.T. Rated Socket

| Catalog Number | Terminal | Bypass  | Amp  | Connectors | Dimensions |    |    |
|----------------|----------|---------|------|------------|------------|----|----|
|                |          |         |      |            | D"         | W" | H" |
| K4806-BP       | 13       | Plunger | 20 A | #14-4 Max  | 2½         | 7⅞ | 7½ |

### Note

BP: The -BP suffix indicates plunger bypass.

### Current Transformer Rated Cabinets – Type 3R

| Catalog Number  | Gauge of Steel | Dimensions |    |    | Panel Size |                     | Panel & Backboard Catalog Numbers |                   |
|-----------------|----------------|------------|----|----|------------|---------------------|-----------------------------------|-------------------|
|                 |                | D"         | W" | H" | W" x H"    | Painted Steel Panel | Wood Backboard                    |                   |
| 243210-LC3R-SP  | 14             | 10         | 24 | 32 | 21         | 29                  | A-24P32                           | A-24P32W          |
| 323610-LC3R-SP  | 14             | 10         | 32 | 36 | 29         | 33                  | A-32P36                           | A-32P36W          |
| 363016-CT3R     | 14             | 16         | 36 | 30 | 33         | 27                  | A-36P30                           | A-36P30W          |
| 363612-CT3R-SP  | 14             | 12         | 36 | 36 | 33         | 33                  | A-36P36                           | A-36P36W Included |
| 364812-CT3R-SP2 | 14             | 12         | 36 | 48 | 33         | 45                  | A-48P36                           | A-48P36W Included |

Please consult serving utility for their requirements prior to ordering or installing, as specifications and approvals vary by utility, and may require local electrical inspector approval. All installations must be installed by a licensed electrician and must comply with all national and local codes, laws and regulations. Milbank reserves the right to make changes in specifications and features shown without notice or obligation.



# Current Transformer Cabinets

## Mounting Racks

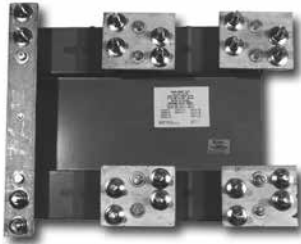

**K4797**



**K4722**

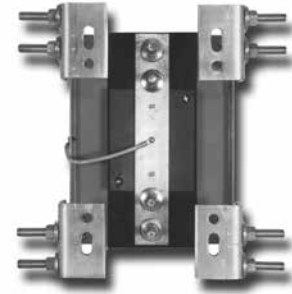

**K4793/K4795**

### Current Transformer Enclosure Mounting Racks

| Catalog Number | Code | AIC Rating | Amp     | Volts | Type of Service | Termination Type   |
|----------------|------|------------|---------|-------|-----------------|--|
| K4797          | A4   | 50K        | 400     | 600   | 1Ø3W            | 1/2 x 13 Studs on 1-3/4" Centers   |
| K4797          | A    | 50K        | 800     | 600   | 1Ø3W            | 1/2 x 13 Studs on 1-3/4" Centers   |
| K4798          | B4   | 50K        | 400     | 600   | 3Ø4W            | 1/2 x 13 Studs on 1-3/4" Centers   |
| K4798          | B    | 50K        | 800     | 600   | 3Ø4W            | 1/2 x 13 Studs on 1-3/4" Centers   |
| K4793          | C    | 10K        | 201-400 | 600   | 1Ø3W            | 1/2 x 13 Studs on 1-3/4" Centers   |
| K4795          | D    | 10K        | 401-800 | 600   | 1Ø3W            | 1/2 x 13 Studs on 1-3/4" Centers   |
| K4794          | E    | 10K        | 201-400 | 600   | 3Ø4W            | 1/2 x 13 Studs on 1-3/4" Centers   |
| K4796          | F    | 10K        | 401-800 | 600   | 3Ø4W            | 1/2 x 13 Studs on 1-3/4" Centers   |
| K4729          | G    | 50K        | 800     | 600   | 1Ø3W            | (3) #4 - 600 or (6) #1 - 250   |
| K4722          | H    | 50K        | 800     | 600   | 3Ø4W            | (3) #4 - 600 or (6) #1 - 250   |
| K4903          | J    | 50K        | 400     | 600   | 1Ø3W            | (1) #4 - 600 or (2) #1 - 250   |
| K4904          | K    | 50K        | 400     | 600   | 3Ø4W            | (1) #4 - 600 or (2) #1 - 250   |
| K5747          | L    | 50K        | 800     | 600   | 3Ø4W            | Line: 1/2 x 13 Studs on 1-3/4" Centers<br>Load: (3) #4 - 600 or (6) #1 - 250 |
| K5752          | M    | 50K        | 800     | 600   | 1Ø3W            | Line: 1/2 x 13 Studs on 1-3/4" Centers<br>Load: (3) #4 - 600 or (6) #1 - 250 |

### Note

- Match red code letter with the applicable CT Cabinet on pages 61 & 62.
- **1/2" Lug Kit:** order **K4200** (single, #4-600) or **K4223** (double, #6-350). Each Kit contains four connectors.



Please consult serving utility for their requirements prior to ordering or installing, as specifications and approvals vary by utility, and may require local electrical inspector approval. All installations must be installed by a licensed electrician and must comply with all national and local codes, laws and regulations. Milbank reserves the right to make changes in specifications and features shown without notice or obligation.

# Current Transformer Cabinets

## Screw Cover & Hinge Cover



CT363611-SC



CT203611-HC

### Screw Cover

| Catalog Number | C.T. Racks                           | Dimensions |    |    | Front Cover |
|----------------|--------------------------------------|------------|----|----|-------------|
|                |                                      | D"         | W" | H" |             |
| CT24329-SC     | A4, C, D, G, J, M                    | 9          | 24 | 32 | 1 Piece     |
| CT242411-SC    | G                                    | 11         | 24 | 24 | 1 Piece     |
| CT243011-SC    | A4, C, D, G, J, M                    | 11         | 24 | 30 | 1 Piece     |
| CT243611-SC    | A4, C, D, G, J, M                    | 11         | 24 | 36 | 1 Piece     |
| CT244811-SC    | A, C, D, G, J                        | 11         | 24 | 48 | 1 Piece     |
| CT303011-SC    | A4, B4, C, D, E, F, G, H, J, K, L, M | 11         | 30 | 30 | 1 Piece     |
| CT303611-SC    | A4, B4, C, D, E, F, G, H, J, K, L, M | 11         | 30 | 36 | 1 Piece     |
| CT363611-SC    | A4, B4, C, D, E, F, G, H, J, K, L, M | 11         | 36 | 36 | 1 Piece     |
| CT364211-SC    | A, B, C, D, E, F, G, H, J, K, L, M   | 11         | 36 | 42 | 2 Pieces    |
| CT364811-SC    | A, B, C, D, E, F, G, H, J, K, L, M   | 11         | 36 | 48 | 2 Pieces    |
| CT424211-SC    | A, B, C, D, E, F, G, H, J, K, L, M   | 11         | 42 | 42 | 2 Pieces    |
| CT484811-SC    | A, B, C, D, G, J, M                  | 11         | 48 | 48 | 2 Pieces    |
| CT303614-SC    | A4, B4, C, D, E, F, G, H, J, K, L, M | 14         | 30 | 36 | 2 Pieces    |
| CT364814-SC    | A, B, C, D, E, F, G, H, J, K, L, M   | 14         | 36 | 48 | 2 Pieces    |
| CT484814-SC    | A, B, C, D, E, F, G, H, J, K, L, M   | 14         | 48 | 48 | 2 Pieces    |

### Hinge Cover

| Catalog Number | C.T. Racks                             | Dimensions |    |    | Front Cover |
|----------------|--|------------|----|----|-------------|
|                |  | D"         | W" | H" |             |
| CT203611-HC    | A4, C, D, J                            | 11         | 20 | 36 | 1 Piece     |
| CT243011-HC    | A4, C, D, G, J, M                      | 11         | 24 | 30 | 1 Piece     |
| CT243611-HC    | A4, C, D, G, J, M                      | 11         | 24 | 36 | 1 Piece     |
| CT244811-HC    | A, C, D, G, J, M                       | 11         | 24 | 48 | 1 Piece     |
| CT303611-HC    | A4, B4, C, D, E, F, G, H, J, K, L, M   | 11         | 30 | 36 | 1 Piece     |
| CT304811-HC    | A, B, B4, C, D, E, F, G, H, J, K, L, M | 11         | 30 | 48 | 1 Piece     |
| CT363611-HC    | A4, B4, C, D, E, F, G, H, J, K, L, M   | 11         | 36 | 36 | 1 Piece     |
| CT364811-HC    | A, B, B4, C, D, E, F, G, H, J, K, L, M | 11         | 36 | 48 | 1 Piece     |
| CT484811-HC    | A, B, C, D, J, M                       | 11         | 48 | 48 | 2 Pieces    |
| CT484814-HC    | A, B, B4, C, D, E, F, G, H, J, K, L, M | 14         | 48 | 48 | 2 Pieces    |

### Note

- **Enclosure:** These units are rated Type 3R, powder coated, and constructed of galvanized steel.
- **Mounting Rack:** Select CT mounting rack by matching the appropriate letter in **CT rack column** on page 61 with applicable letter in **Code column** on page 60.
- **Mounting:** 1/4-20 welded studs.

Please consult serving utility for their requirements prior to ordering or installing, as specifications and approvals vary by utility, and may require local electrical inspector approval. All installations must be installed by a licensed electrician and must comply with all national and local codes, laws and regulations. Milbank reserves the right to make changes in specifications and features shown without notice or obligation.





U3565-O

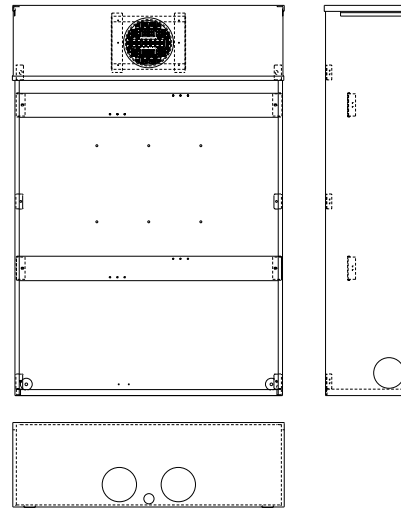

## Metered Transformer Cabinets | Ring Type

| Catalog Number | Terminal | Service | Meter Form           | Hub  | Dimensions |    |    | CT Racks                           |
|----------------|----------|---------|----------------------|------|------------|----|----|------------------------------------|
|                |          |         |                      |      | D"         | W" | H" |                                    |
| U3319-R        | 5        | OH      | 3S                   | H.O. | 11         | 24 | 42 | A, C, D, G, J, M                   |
| U3320-R        | 6        | OH      | 4S                   | H.O. | 11         | 24 | 42 | A, C, D, G, J, M                   |
| U3321-R        | 8        | OH      | 5S                   | H.O. | 11         | 24 | 42 | A, C, D, G, J, M                   |
| U3322-R        | 13       | OH      | 6, 8, 9S & (ALT) 10S | H.O. | 11         | 36 | 42 | A, B, C, D, E, F, G, H, J, K, L, M |
| U3323-R        | 8        | OH      | 5S                   | H.O. | 11         | 36 | 42 | A, B, C, D, E, F, G, H, J, K, L, M |
| U3555-R        | 15       | OH      | 39S, 76S             | H.O. | 11         | 36 | 42 | A, B, C, D, E, F, G, H, J, K, L, M |
| U3339-O        | 5        | UG      | 3S                   | none | 11         | 24 | 52 | A, C, D, G, J, M                   |
| U3340-O        | 6        | UG      | 4S                   | none | 11         | 24 | 52 | A, C, D, G, J, M                   |
| U3341-O        | 8        | UG      | 5S                   | none | 11         | 24 | 52 | A, C, D, G, J, M                   |
| U3342-O        | 13       | UG      | 6, 8, 9S & (ALT) 10S | none | 11         | 36 | 52 | A, B, C, D, E, F, G, H, J, K, L, M |
| U3343-O        | 8        | UG      | 5S                   | none | 11         | 36 | 52 | A, B, C, D, E, F, G, H, J, K, L, M |
| U3565-O        | 15       | UG      | 39S, 76S             | none | 11         | 36 | 52 | A, B, C, D, E, F, G, H, J, K, L, M |

### Note

- **Meter Socket:** 20 amp current transformer meter socket built in.
- **Enclosure:** NEMA Type 3R with screw cover.
- **Current Transformer Mounting:** 1/4-20 welded studs.
- **Hubs:** For proper hub selection, see hub suffix chart in the accessory section.
- **Sealing Rings:** Supplied with **MR-4** screw type sealing ring.
- **Mounting Racks:** For mounting rack information refer to previous page. Select CT mounting rack by matching the appropriate letter in **CT rack column** on page 62 with applicable letter in **Code column** on page 60.



Please consult serving utility for their requirements prior to ordering or installing, as specifications and approvals vary by utility, and may require local electrical inspector approval. All installations must be installed by a licensed electrician and must comply with all national and local codes, laws and regulations. Milbank reserves the right to make changes in specifications and features shown without notice or obligation.

# Service Pedestals

125 Amp | Mobile Home Metered | 120/240 VAC

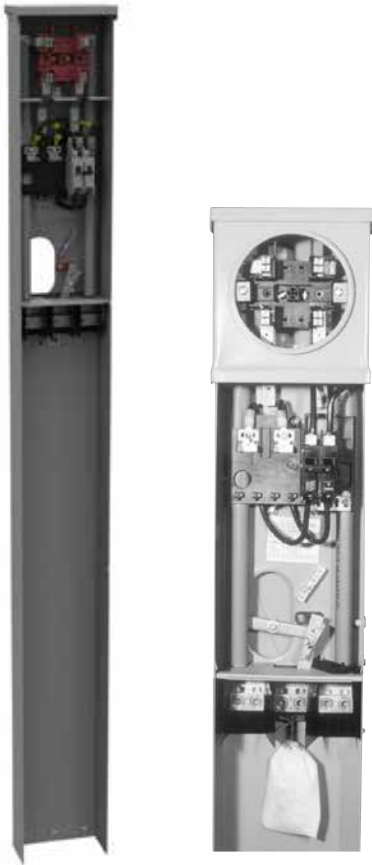

**MPRV-100-MB-78**

## Standard Configurations

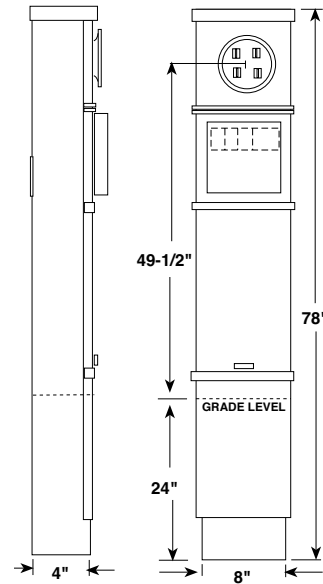
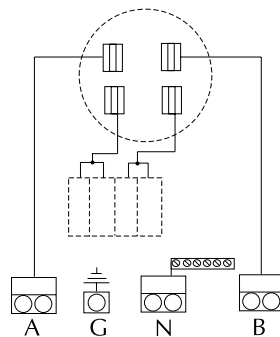
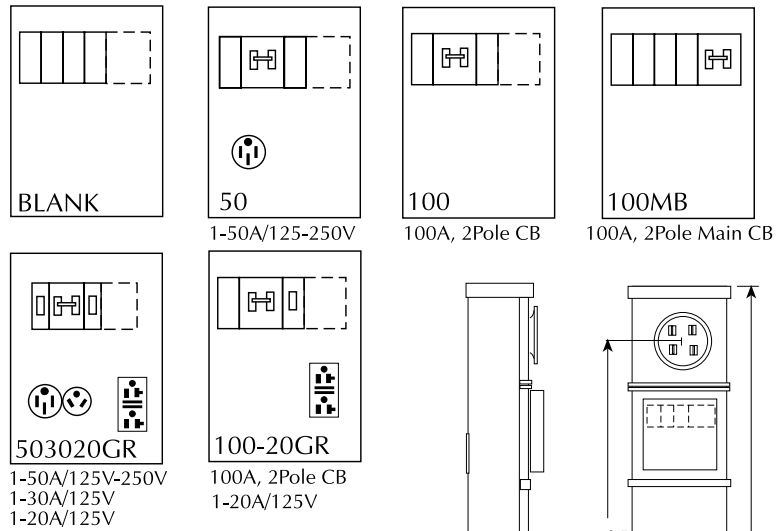

**Single**

## Specifications

- UL listed 100 amp continuous duty meter socket.
- 120/240 volt single phase service.
- Twin line termination lugs #6-350 kcmil CU/AL per phase for looping.
- Space for four (4) single, or one double (240V C/B center- positions only) and two (2) single pole universal style, plug-in circuit breakers.
- Ringless version equipped with horn bypass as standard.
- For fifth terminal field installed order kit **105J** in the 3 o'clock or 9 o'clock position.
- Direct rear feed kit **PF-KR** included.
- For optional stabilizer foot, order **K5763**.
- Specify **MPRV-100-78** for 100 amp service pedestal with direct feed kit and 100 amp CB wired in parallel. Space for two additional single pole CBs provided. Series wiring available; specify **MPRV-100-MB-78**.
- **MR-2** sealing ring standard with ring type cover.
- No knockouts.

| Catalog Number            | Description               |
|---------------------------|---------------------------|
| <b>MPRV-BLANK-78</b>      | Ring type, parallel wired |
| <b>MPRV-BLANK-78-R-5T</b> | Ringless, horn bypass     |
| <b>MPRV-100-78</b>        | Ring type, parallel wired |
| <b>MPRV-100-MB-78</b>     | Ring type, series wired   |
| <b>MPRV-100-20GR-78</b>   | Ring type, parallel wired |
| <b>MPRV-50-78</b>         | Ring type                 |
| <b>MPRV-503020GR-78</b>   | Ring type                 |

Please consult serving utility for their requirements prior to ordering or installing, as specifications and approvals vary by utility, and may require local electrical inspector approval. All installations must be installed by a licensed electrician and must comply with all national and local codes, laws and regulations. Milbank reserves the right to make changes in specifications and features shown without notice or obligation.



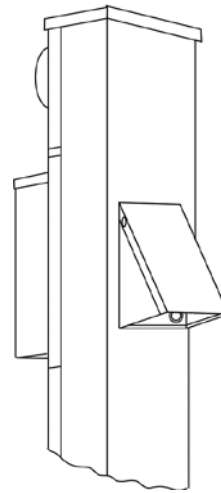
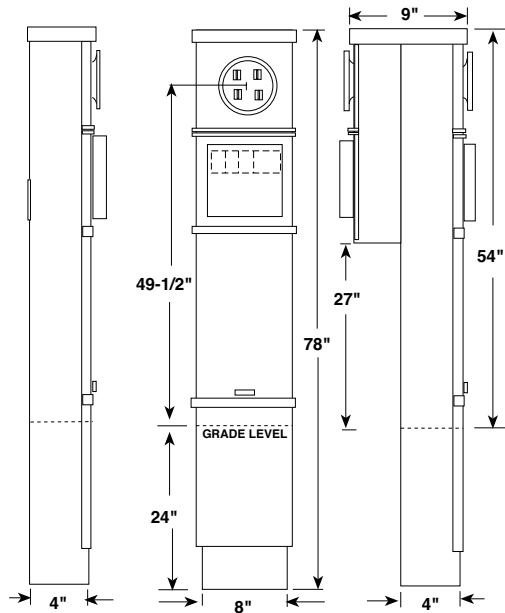

**MPAP-200-78**

### Standard Configurations

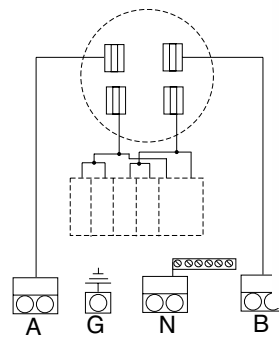
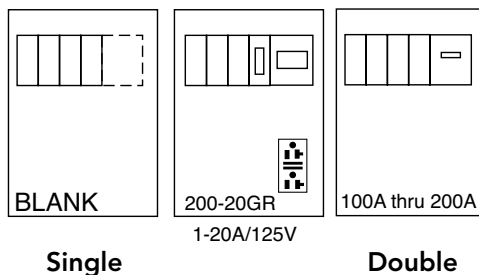

**Single**

**Double**

| Catalog Number   | Description                           |
|------------------|---------------------------------------|
| MPAP-BLANK-78    | Ring type, parallel wired             |
| MPAP-BLANK-78R   | Ringless, horn bypass, parallel wired |
| MPAP-100-78      | Ring type, parallel wired             |
| MPAP-100-MB-78   | Ring type, series wired               |
| MPAP-200-78      | Ring type, parallel wired             |
| MPAP-200-MB-78   | Ring type, series wired               |
| MPAP-200-20GR-78 | Ring type, parallel wired             |
| MPAPD-BLANK-78   | Ring type, parallel wired             |
| MPAPD-BLANK-78R  | Ringless, horn bypass, parallel wired |

### Specifications

- 120/240 volt single phase service.
- Twin line termination lugs #6-350 CU/AL per phase for looping.
- **UQFP** breaker provisions factory wired in parallel with branch breaker bus. Series wiring available. Specify **MB** after breaker rating, ex. **MPAP-200-MB**.
- Furnished with space for four single or one double (240V C/B center-positions only) and two single pole universal style, plug-in circuit breakers in addition to main.
- Ringless version equipped with horn bypass as standard.
- For fifth terminal field installed order kit **105J** in the 3 o'clock or 9 o'clock position.
- Direct rear feed kit **PF-KR** included.
- **MR-2** sealing ring standard with ring type cover.
- Series conversion kit order K4714

### Notes

- Order K4714 for series wire kit.
- Order K5194 for parallel to series field conversion kit.
- Order K5193 for series to parallel field conversion kit.



Please consult serving utility for their requirements prior to ordering or installing, as specifications and approvals vary by utility, and may require local electrical inspector approval. All installations must be installed by a licensed electrician and must comply with all national and local codes, laws and regulations. Milbank reserves the right to make changes in specifications and features shown without notice or obligation.



# Power Pedestals with Load Center

100 & 200 Amp Series MPRV & MPAP | Ring Type

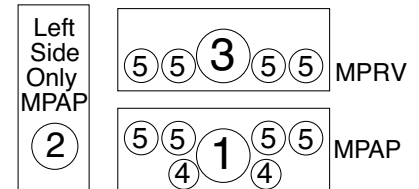
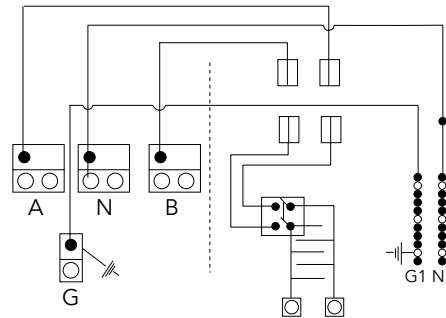
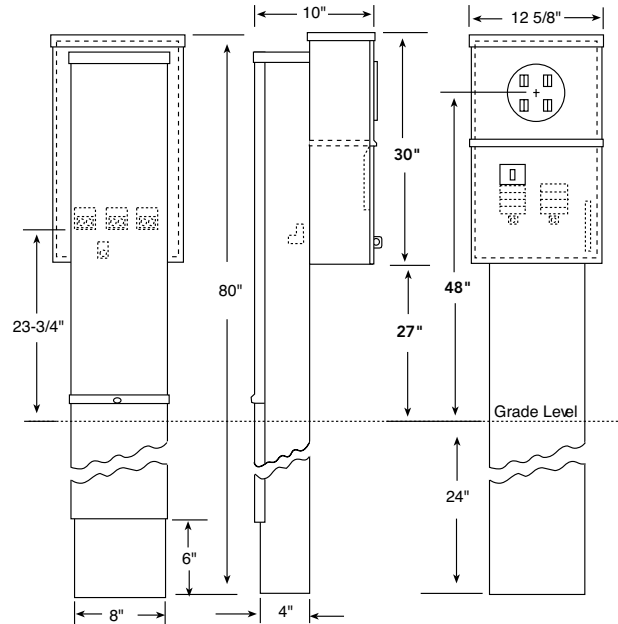

MPAP-200-MBLC-80

## 100 & 200 Amp | Load Center Power Outlets

| Catalog Number   | Description   | Knockouts |   |   |    |      |
|------------------|---|-----------|---|---|----|------|
|                  |   | 1         | 2 | 3 | 4  | 5    |
| MPRV-100-MBLC-80 | 100 Amp Metered Pedestal with (8) Circuit Load Center | 2½        | 2 | - | 1¼ | ½, ¾ |
| MPAP-200-MBLC-80 | 200 Amp Metered Pedestal with (8) Circuit Load Center | 2½        | 2 | - | 1¼ | ½, ¾ |

## Specifications

- UL listed 100/200 amp continuous duty meter socket.
- Approved for 120/240 volt single phase service.
- Twin line termination lugs #6-350 CU/AL per phase for looping. Rear termination.
- Space for (8) single, or (4) double and two single pole universal style plug-in circuit breakers.
- Series main breaker factory installed.
- Direct feed lugs standard.

Please consult serving utility for their requirements prior to ordering or installing, as specifications and approvals vary by utility, and may require local electrical inspector approval. All installations must be installed by a licensed electrician and must comply with all national and local codes, laws and regulations. Milbank reserves the right to make changes in specifications and features shown without notice or obligation.



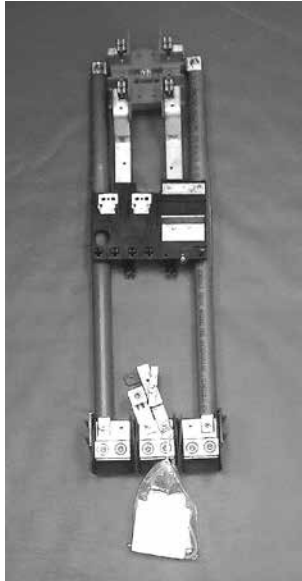

**Catalog Number Z020-148-00-00-0**  
MPAP 200A interior rebuild kit

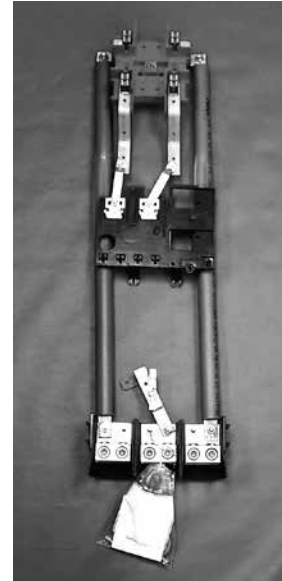

**Catalog Number 020-147-00-00-0**  
MPRV 100A interior rebuild kit

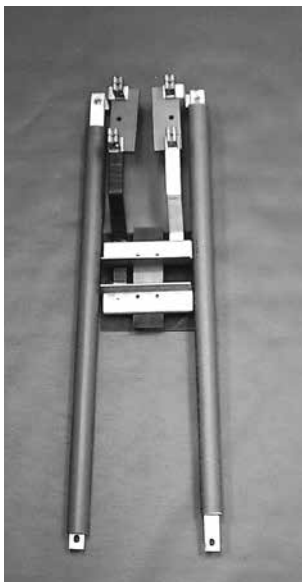

**Catalog Number RBK-1**  
Unicorn MPP (pre-1969)  
interior rebuild kit

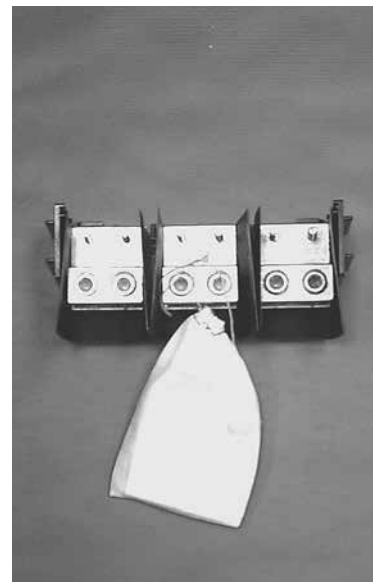

**Catalog Number Z1050596**  
MPAP, MPRV & Unicorn MPP  
lug landing assembly with grounding kit

**Above items sold as complete assemblies only.  
Individual components not available.**



Please consult serving utility for their requirements prior to ordering or installing, as specifications and approvals vary by utility, and may require local electrical inspector approval. All installations must be installed by a licensed electrician and must comply with all national and local codes, laws and regulations. Milbank reserves the right to make changes in specifications and features shown without notice or obligation.

# Replacement Parts

Mobile Home Rebuild Kits

**67**  
REPLACEMENT  
PARTS



**Catalog Number PF-BL**  
MPAP/MPRV blank deadfront  
with hinged cover



**Catalog Number PF-KR**  
MPAP/MPRV rear connector kit

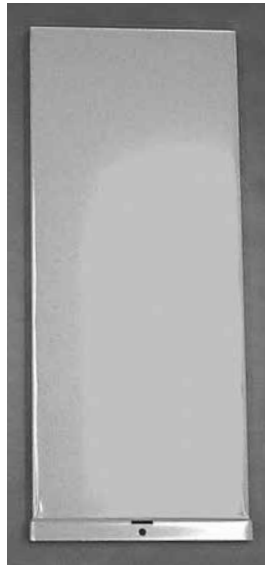

**Lug Cover for MPAP/MPRV**  
Order Catalog Number **403456-SC**  
(8-1/2" W X 20-1/2" H) for 72" pedestals  
and Catalog Number **403457-SC** (8-1/2" W X 26-1/2" H)  
for 78" pedestals.

Please consult serving utility for their requirements prior to ordering or installing, as specifications and approvals vary by utility, and may require local electrical inspector approval. All installations must be installed by a licensed electrician and must comply with all national and local codes, laws and regulations. Milbank reserves the right to make changes in specifications and features shown without notice or obligation.



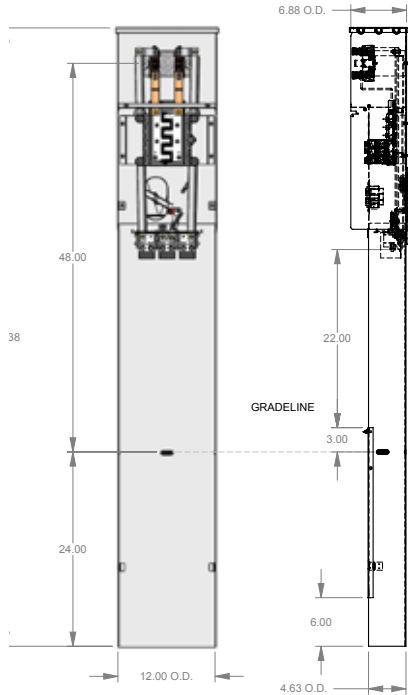

## Features and Benefits

- Circuit breaker interior has provisions for twelve full one-inch poles (including main).
- Rating: 100 Amp, 120/240 VAC.
- Interiors will accept plug-in breakers. (GE, Cutler-Hammer, Siemens, SQD)
- Suitable for use as service equipment and mobile home service equipment.
- Rear Feed Kit included in Pedestal
- Twin 350 MCM line terminals (installed) provide optional loop-feed installation.
- 14 gauge corrosion resistant steel construction.
- Type 3R Raintight enclosure.
- Padlock provision.
- Total unit height is 76". Burial depth is 24". Installed height from ground is 48" to meter center.
- Standard color: gray powder coat finish.
- EUSERC compliant drawing number 307
- Pad Mount version available

| Catalog Number | Configuration   |
|----------------|---|
| U6276-O-10GR   | (1) 20 amp 5-20R Duplex                                   |
| U6276-O-54     | (1) 50 amp 14-50R Duplex                                  |
| U6276-O-41     | (1) 20 amp 5-20R Duplex (1) 30 amp TT-30R                 |
| U6276-O-55     | (1) 20 amp 5-20R Duplex (1) 50 amp 14-50GR                |
| U6276-O-75     | (1) 50 amp 14-50R (1) 30 amp TT30 (1) 20amp 5-20GR Duplex |
| U6276-O-100    | (1) 100 amp breaker installed                             |
| U6276-O-100MB  | (1) 100 Main Breaker series wired                         |

## Notes

- Contact Factory for additional options
- Extension Kit and Stabilizer Foot Available
- Replacement Parts available (covers, dead-fronts, receptacles, breakers).



Please consult serving utility for their requirements prior to ordering or installing, as specifications and approvals vary by utility, and may require local electrical inspector approval. All installations must be installed by a licensed electrician and must comply with all national and local codes, laws and regulations. Milbank reserves the right to make changes in specifications and features shown without notice or obligation.

# Service Pedestals

200 Amp | U5240 & U5241 Series | Ring Type

**69**  
SERVICE  
PEDESTALS



U5240-O-200S

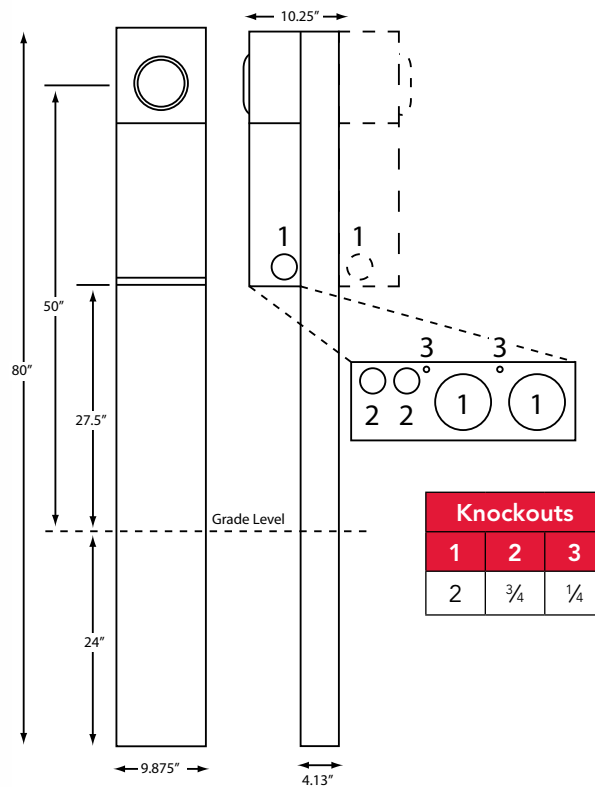

## Specifications

- Twin line termination lugs #6-350 CU/AL per phase for looping.
- 200 amp maximum, 120/240 volt, single phase, three wire meter socket.
- Ring type meter socket with stainless steel screw-type sealing ring.
- Short circuit withstand rating 22K AIC.
- Type 3R construction for durable outdoor use, one piece post – lockable and sealable.
- ANSI 61 gray polyester powder coat finish.
- Wire terminations accept copper or aluminum conductors.
- Line & neutral: (2) #6-350 kcmil per phase
- Line ground: (4) #14-1/0
- Load: See Circuit Breaker
- Load neutral: (1) #6-350 kcmil.
- Load ground: (2) #14-1/0, (4) #14/6
- Milbank plug-in main circuit breaker. Available in 100, 125, 150 & 200 amp. Type **UQFPH-M**.
- Four-circuit plated copper interior accepts (2) 2-pole or (4) 1-pole standard plug-in type circuit breakers up to a total of 125 amp maximum. Acceptable manufacturers: Cutler-Hammer, GE or Siemens
- Factory or field-installable receptacle bridge and receptacle/circuit breaker kits available. See accessories.

Please consult serving utility for their requirements prior to ordering or installing, as specifications and approvals vary by utility, and may require local electrical inspector approval. All installations must be installed by a licensed electrician and must comply with all national and local codes, laws and regulations. Milbank reserves the right to make changes in specifications and features shown without notice or obligation.



### 200 Amp | 4 Terminal | Service Pedestals | Ring Type

| Catalog Number | Powerheads | Mounting      | Main Breaker                     | Main CB | Circuits | Dimensions |    |    |
|----------------|------------|---------------|----------------------------------|---------|----------|------------|----|----|
|                |            |               |                                  |         |          | D"         | W" | H" |
| U5240-O-100S   | Single     | Direct Burial | UQFPH-M-100                      | 100     | 4        | 10¼        | 10 | 80 |
| U5240-O-200S   | Single     | Direct Burial | UQFPH-M-200                      | 200     | 4        | 10¼        | 10 | 80 |
| U5240-O        | Single     | Direct Burial | Provision for UQFPH-M series     | —       | 4        | 10¼        | 10 | 80 |
| U5242-O-200S   | Single     | Pad Mount     | UQFPH-M-200                      | 200     | 4        | 10¼        | 10 | 56 |
| U5242-O        | Single     | Pad Mount     | Provision for UQFPH-M series     | —       | 4        | 10¼        | 10 | 56 |
| U5241-O-100S   | Double     | Direct Burial | (2) UQFPH-M-100                  | 100     | 4        | 16         | 10 | 80 |
| U5241-O-200S   | Double     | Direct Burial | (2) UQFPH-M-200                  | 200     | 4        | 16         | 10 | 80 |
| U5241-O        | Double     | Direct Burial | Provision for (2) UQFPH-M series | —       | 4        | 16         | 10 | 80 |
| U5243-O        | Double     | Pad Mount     | Provision for (2) UQFPH-M series | —       | 4        | 16         | 10 | 56 |

### Accessories

| Catalog Number | Description   |
|----------------|---|
| K5415          | Stabilizer foot with hardware                             |
| K5035          | Pad mount kit with hardware for U5242 & U5243             |
| K5T            | 5th terminal for 208y/120V 3-wire service                 |
| K5193          | Bus kit to convert series-wired main breaker to parallel  |
| K5194          | Wire kit to convert parallel-wired main breaker to series |
| K3450          | Telephone/CATV mounting bracket (mounts left or right)    |
| K5039          | Penta bolt utility cover                                  |

### Notes

- Up to two receptacle/circuit breaker kits can be field-installed in each powerhead. Order mounting bridge and receptacle kits separately from above. For three receptacles or factory-installed kits, contact factory.
- **K5415** Stabilizer Foot sold separately. Recommended for double pedestals.
- Pad mount pedestals require **K5035** pad mount kit. Order separately.
- Receptacles and circuit breakers can be found in the accessories section.

# Service Pedestals

200 Amp | Ringless

**71**  
SERVICE  
PEDESTAL

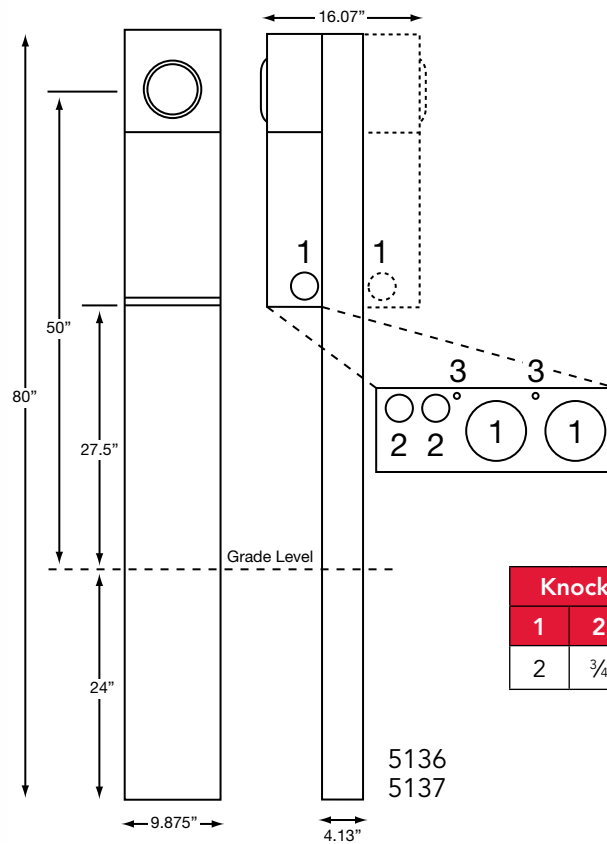

| Knockouts |     |     |
|-----------|-----|-----|
| 1         | 2   | 3   |
| 2         | 3/4 | 1/4 |

U5136-O-200S

## Specifications

- UL listed
- 200 amp maximum, 120/240 V, 1Ø3W
- Ringless type meter socket with stainless steel latch
- Short circuit withstand rating 22 KAIC
- Type 3R construction for durable outdoor use
- ANSI 61 gray polyester powder coat finish
- Wire terminations accept copper or aluminum conductors
- Line & Neutral: (2) #6-350 kcmil per phase, Line Ground: (4) #14-1/0
- Load (CB): 2/0 to 300 kcmil per pole
- Load neutral: (1) #6-350 kcmil
- Load ground: (2) #14-1/0, (4) #14/6
- Commercial grade, plug-in main circuit breaker. Available in 100, 125, 150 & 200 AMP. Type UQFP-H-M.
- 4 circuit plated copper interior accepts (2) 2-pole or (4) 1-pole standard plug-in type circuit breakers. Branch circuit rated to 125 amp max. Acceptable manufacturers: Milbank, Cutler-Hammer, GE or Siemens
- Twin line termination lugs #6-350 CU/AL per phase for looping.

Please consult serving utility for their requirements prior to ordering or installing, as specifications and approvals vary by utility, and may require local electrical inspector approval. All installations must be installed by a licensed electrician and must comply with all national and local codes, laws and regulations. Milbank reserves the right to make changes in specifications and features shown without notice or obligation.



### 100–200 Amp | Meter Main with Load Center Pedestals | Ringless

| Catalog Number | Powerheads | Mounting      | Amp | Main Breaker                     | Interior  | Dimensions       |    |    | Knockouts |          |     |
|----------------|------------|---------------|-----|----------------------------------|-----------|------------------|----|----|-----------|----------|-----|
|                |            |               |     |                                  |           | D"               | W" | H" | 1         | 2        | 3   |
| U5136-O-100S   | Single     | Direct Burial | 100 | UQFPH-M-100                      | 4 circuit | 10 $\frac{1}{4}$ | 10 | 80 | 2         | 1/2, 3/4 | 1/4 |
| U5136-O-200S   | Single     | Direct Burial | 200 | UQFPH-M-200                      | 4 circuit | 10 $\frac{1}{4}$ | 10 | 80 | 2         | 1/2, 3/4 | 1/4 |
| U5136-O        | Single     | Direct Burial | —   | Provision for UQFPH-M series     | 4 circuit | 10 $\frac{1}{4}$ | 10 | 80 | 2         | 1/2, 3/4 | 1/4 |
| U5137-O-100S   | Double     | Direct Burial | 100 | (2) UQFPH-M-100                  | 4 circuit | 16 $\frac{1}{6}$ | 10 | 80 | 2         | 1/2, 3/4 | 1/4 |
| U5137-O-200S   | Double     | Direct Burial | 200 | (2) UQFPH-M-200                  | 4 circuit | 16 $\frac{1}{6}$ | 10 | 80 | 2         | 1/2, 3/4 | 1/4 |
| U5137-O        | Double     | Direct Burial | —   | Provision for (2) UQFPH-M series | 4 circuit | 16 $\frac{1}{6}$ | 10 | 80 | 2         | 1/2, 3/4 | 1/4 |
| U5138-O-200S   | Single     | Pad Mount     | 200 | UQFPH-M-200                      | 4 circuit | 10 $\frac{1}{4}$ | 10 | 56 | 2         | 1/2, 3/4 | 1/4 |
| U5138-O        | Single     | Pad Mount     | —   | Provision for UQFPH-M series     | 4 circuit | 10 $\frac{1}{4}$ | 10 | 56 | 2         | 1/2, 3/4 | 1/4 |
| U5139-O        | Double     | Pad Mount     | —   | Provision for UQFPH-M series     | 4 circuit | 16 $\frac{1}{6}$ | 10 | 56 | 2         | 1/2, 3/4 | 1/4 |

### Accessories

| Catalog Number | Description   |
|----------------|---|
| K5415          | Stabilizer foot with hardware                             |
| K5035          | Pad mount kit with hardware for <b>U5138</b>              |
| K5T            | 5th terminal for 208y/120V 3-wire service                 |
| K5193          | Bus kit to convert series-wired main breaker to parallel  |
| K5194          | Wire kit to convert parallel-wired main breaker to series |
| K3450          | Telephone/CATV mounting bracket (mounts left or right)    |
| K5039          | Penta bolt utility cover                                  |

### Notes

- **Parallel to Series Conversion:** For field converting from parallel wired to series wired order **K5194**.
- **Fifth Terminal:** For field installed fifth terminal, order **K5T**.
- **Stabilizer Foot:** For field installed stabilizer foot, order **K5415**.
- **Penta Bolt Locking:** For field installed pedestal fronts penta bolt locking, order **K5039**.
- **Pad Mount Units:** Pad mount pedestals require **K5035** pad mount kit. Order separately.
- Receptacles and circuit breakers can be found in the accessories section.



Please consult serving utility for their requirements prior to ordering or installing, as specifications and approvals vary by utility, and may require local electrical inspector approval. All installations must be installed by a licensed electrician and must comply with all national and local codes, laws and regulations. Milbank reserves the right to make changes in specifications and features shown without notice or obligation.



# Service Pedestals

U5706 Series | Ringless

**73**  
SERVICE  
PEDESTALS



U5706-O-200S

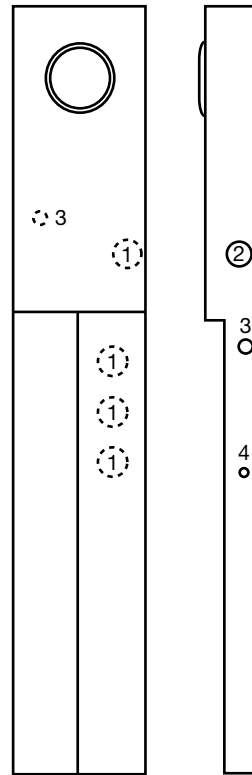

5706  
5707

## Specifications

- 200 amp, 1Ø, 120/240 volt, 22K AIC, underground service only.
  - U5706 has ringless meter socket available with or without horn bypass (-KK).
  - U5707 has ring type meter socket with MR-4 screw type meter ring.
  - Suitable for use as service equipment, mobile home service equipment and temporary power service equipment.
  - Direct burial pedestal suitable for free standing or structure mounted installation.
  - Separate line and load wireways are removable, lockable and sealable for security.
  - Left side is for utility connection. Right side is for customer underground load exit.
  - Convenient knockouts in post for through-wall load exit requirements.
  - Type 3R enclosure constructed with type G90 galvanized steel.
  - Repaintable light gray polyester powder coat finish.
  - Wire terminations accept copper or aluminum conductors: Line & Neutral: #6-350 Ground: (4) #14-1/0.
  - Main circuit breaker can be series or parallel connected.
  - Universal 4 circuit branch 125 amp interior (up to (2) 2-pole) accepts most manufacturers plug-in type circuit breakers. See wiring diagram.
- \*Provisions for up to two Type 3R in-use receptacle.  
\*Order receptacle and bridge separately. See ordering information.

Please consult serving utility for their requirements prior to ordering or installing, as specifications and approvals vary by utility, and may require local electrical inspector approval. All installations must be installed by a licensed electrician and must comply with all national and local codes, laws and regulations. Milbank reserves the right to make changes in specifications and features shown without notice or obligation.



### 200 Amp | 4 Terminal | Meter Main Pedestal | Ringless

| Catalog Number  | Service | Bypass | Connectors CU/AL |      | Dimensions |    |    | Knockouts |   |   |     |
|-----------------|---------|--------|------------------|------|------------|----|----|-----------|---|---|-----|
|                 |         |        | Line             | Load | D"         | W" | H" | 1         | 2 | 3 | 4   |
| U5706-O-200S    | UG      | None   | #6-350           | CB   | 5½         | 14 | 80 | 2½        | 2 | 1 | ¼,½ |
| U5706-O-200S-KK | UG      | Horn   | #6-350           | CB   | 5½         | 14 | 80 | 2½        | 2 | 1 | ¼,½ |

### 200 Amp | 4 Terminal | Meter Main Pedestal | Ring Type

| Catalog Number | Service | Bypass | Connectors CU/AL |      | Dimensions |    |    | Knockouts |   |   |     |
|----------------|---------|--------|------------------|------|------------|----|----|-----------|---|---|-----|
|                |         |        | Line             | Load | D"         | W" | H" | 1         | 2 | 3 | 4   |
| U5707-O-200S   | UG      | None   | #6-350           | CB   | 5½         | 14 | 80 | 2½        | 2 | 1 | ¼,½ |

### Notes

- **Fifth Terminal:** For field installed fifth terminal, order **K5T**.
- **Receptacles:** Maximum of two receptacles can be added. Contact Milbank for details.
- **Post Extension Kit:** To increase pedestal height, order field-installed post extension kit **K5708**.
- **Series-to-Parallel Field Conversion:** For field conversion from series to parallel wired, order kit **K5193**.
- **Branch Circuit Breakers (Four Additional Single Pole Spaces):** Branch interior accepts most manufacturers' small frame plug-in type circuit breakers (GE, Siemens, Cutler Hammer). Load center's four left stabs are rated up to 125 amp total.

### Accessories



K5400-BRIDGE-1POS



K5400-BRIDGE-2POS



UQFPH-M-200

# Temporary Power

## U4908 & U4909 Underground Service Power Outlet

**75**  
TEMPORARY  
POWER



U4909-O-11GR

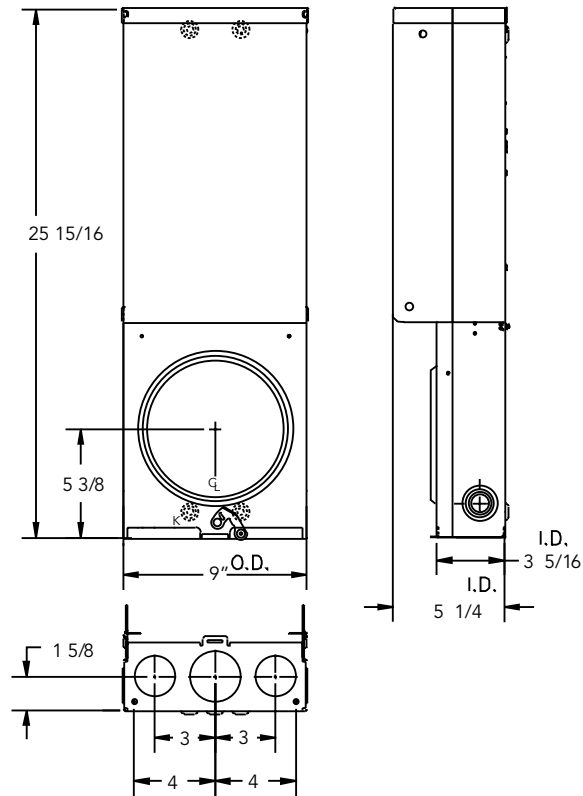

### Specifications

- Available in ringless style (**U4908** series) or ring type (**U4909** series).
- UL listed 100 amp, 120/240 Volt – 1Ø Underground Service Power Outlets.
- Short circuit current withstand rating 10K RMS symmetrical amperes.
- Type 3R welded enclosure for durable outdoor use.
- Enclosure constructed with galvanized 16 gauge steel.
- ANSI 61 gray polyester powder coat finish.
- Convenient concentric knock-out configurations and mounting embosses.
- Wire terminations accept copper or aluminum conductors.  
Service – Line & Neutral: (1) #6-2/0 Load Ground: (2) 1/0-#14 & (4) #6-#14  
Load Neutral: (2) 1/0-#14 & (4) #6-#14 Service Ground: #2-#8
- Six circuit plated copper interior accepts standard plug-in type circuit breakers.
- Three position **self-grounded** receptacle bridge accepts most standard NEMA receptacles with mounting plates.
- Four terminal, ringless meter socket with stainless steel locking hasp. Ring type socket has aluminum **MR-2** snap action sealing ring.
- Lockable hinge cover and deadfront are removable for installation and maintenance. Stay-open hinge cover has safety interlock on deadfront. Deadfront must be removed before hinge cover can be removed.
- Tamper proof fastening available.

Please consult serving utility for their requirements prior to ordering or installing, as specifications and approvals vary by utility, and may require local electrical inspector approval. All installations must be installed by a licensed electrician and must comply with all national and local codes, laws and regulations. Milbank reserves the right to make changes in specifications and features shown without notice or obligation.



### U4908 & U4909 Standard Configurations

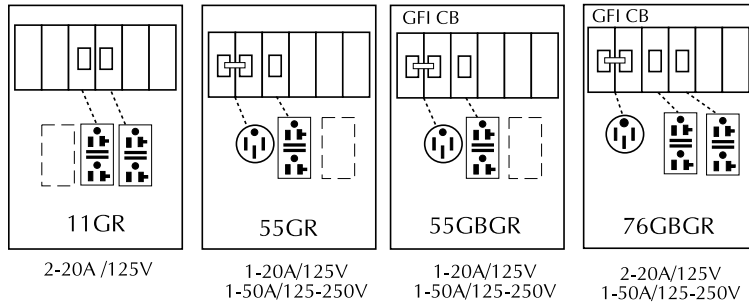

### Ordering Information

| Catalog Number   | Socket Type | Description  |
|------------------|-------------|--|
| • U4908-O        | Ringless    | Order base model and up to three factory installed receptacle/breaker kit separately from list below. Other kits available. Consult factory. |
| • U4908-O-11GR   | Ringless    |  |
| • U4908-O-55GBGR | Ringless    |  |
| • U4909-O        | Ring type   | Order base model and up to three factory installed receptacle/breaker kit separately from list below. Other kits available. Consult factory. |
| • U4909-O-11GR   | Ring type   |  |
| • U4909-O-55GBGR | Ring type   |  |

**Note:** Flat cover may not close completely with twist locking devices in use.

Order slope-front 3R cover #1107681 separately to use with twist lock type receptacles.

- Stock item – availability subject to prior sale.
- Non-stock items – minimum order quantity required.

# Temporary Power

## Series U5001 Unmetered Service Mount Power Outlet

**77**  
TEMPORARY  
POWER



**U5001-RL-01**

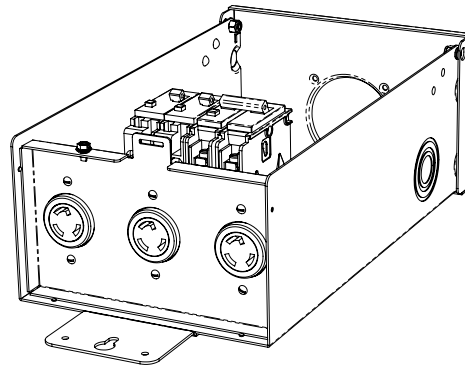

### Specifications

- UL listed 125 amp, 120/240 Volt, 1Ø Power Outlet.
- Short circuit current withstand rating 10K RMS symmetrical amperes.
- Type 3R welded enclosure for durable outdoor use.
- ANSI 61 gray polyester powder coat finish.
- Wire terminations accept copper or aluminum conductors.  
Line: 1/0-#4     Ground/Neutral: (4) 1/0-#14 & (11) #14-#6
- Six circuit plated copper interior accepts standard plug-in type circuit breakers.
- Components factory wired with stranded copper wire.
- Lockable hinge cover and deadfront are removable for installation and maintenance.
- U5001-RL-01 includes:
  - (1) L6-30     (1) 30 Amp, 2P, 240V GFI Breaker
  - (2) L5-20     (2) 20 Amp, 1P, 120V GFI Breaker

Please consult serving utility for their requirements prior to ordering or installing, as specifications and approvals vary by utility, and may require local electrical inspector approval. All installations must be installed by a licensed electrician and must comply with all national and local codes, laws and regulations. Milbank reserves the right to make changes in specifications and features shown without notice or obligation.





**U5865-XL-38GBGRW**

### Specifications

- UL listed 125 amp, 120/240 Volt, 1Ø Power Outlet.
- Short circuit current withstand rating 10K RMS symmetrical amperes.
- Type 3R welded enclosure for durable outdoor use.
- ANSI 61 gray polyester powder coat finish.
- Wire terminations accept copper or aluminum conductors.  
Line & Line Neutral: 250-#6
- Six circuit plated copper interior accepts standard plug-in type circuit breakers.
- Components factory wired with stranded copper wire.
- Lockable hinge cover and deadfront are removable for installation and maintenance.
- **U5865-XL-38GBGRW** includes:
  - (1) L6-30 (1) 30A, 2P, 240V GFI Breaker
  - (2) L5-20 GFI receptacles (2) 20A, IP, 120V Breaker

# Temporary Power

## Series U5001 Unmetered Service Mount Power Outlet

| Catalog Number | Circuit Breaker Description                                |
|----------------|--|
| Q115           | 15 Amp – 1 Pole – 120/240 – Plug-In Circuit Breaker        |
| Q120           | 20 Amp – 1 Pole – 120/240 – Plug-In Circuit Breaker        |
| Q130           | 30 Amp – 1 Pole – 120/240 – Plug-In Circuit Breaker        |
| Q220           | 20 Amp – 1 Pole – 120/240 – Plug-In Circuit Breaker        |
| Q250           | 50 Amp – 2 Pole – 120/240 – Plug-In Circuit Breaker        |
| Q2100          | 100 Amp – 2 Pole – 120/240 – Plug-In Circuit Breaker       |
| 708784-MO      | 20 Amp – GFCI – 1 Pole – 120/240 – Plug-In Circuit Breaker |
| 708785-MO      | 30 Amp – GFCI – 1 Pole – 120/240 – Plug-In Circuit Breaker |
| 707915-MO      | 50 Amp – GFCI – 1 Pole – 120/240 – Plug-In Circuit Breaker |
| 703997-MO      | 50 Amp – Quad – 2 Pole – 120/240 – Circuit Breaker         |

| Catalog Number | Receptacle Description   |
|----------------|--|
| 708777-MO      | 20 Amp – 120V – NEMA 5-20R – Duplex Receptacle                 |
| 708080-MO      | 20 Amp – 120V – NEMA 5-20 – GFCI Duplex Receptacle             |
| 704995-MO      | 20 Amp – 250V – NEMA 6-20R – Single Receptacle                 |
| 701776-MO      | 30 Amp – 120V – NEMA TT-30R – Travel Trailer Receptacle        |
| 706761-MO      | 50 Amp – 120V – 3 Pole – 3 Wire – NEMA 10-50R – Receptacle     |
| Z700911-MO     | 50 Amp – 120/250V – 3 Pole – 4 Wire – NEMA 14-50R – Receptacle |

| Catalog Number   | Lug Landings & Breaker Base Description     |
|------------------|---|
| Z1050596         | MPRV/MPAP – Lug Landing (Twin #6-350 KCMIL) |
| Z020-148-00-00-0 | MPAP – Complete Interior Assembly           |

### Note

- The following brand names may be supplied when replacement circuit breakers are ordered:  
Cutler-Hammer/ Westinghouse – QP, BQC, BD, BR. Siemens/ITE – Q, QT. General Electric – TQ, THQ, THQL.  
Challenger – C, Q, QC, QP. Contact sales office for brand specific requirements.

Please consult serving utility for their requirements prior to ordering or installing, as specifications and approvals vary by utility, and may require local electrical inspector approval. All installations must be installed by a licensed electrician and must comply with all national and local codes, laws and regulations. Milbank reserves the right to make changes in specifications and features shown without notice or obligation.



# Surface Mount Power Outlets

Millennium Series | 120/240 VAC



U5000-XL-75

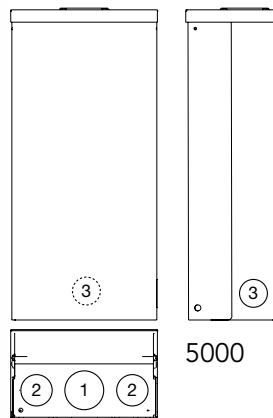

U5100-XL-75

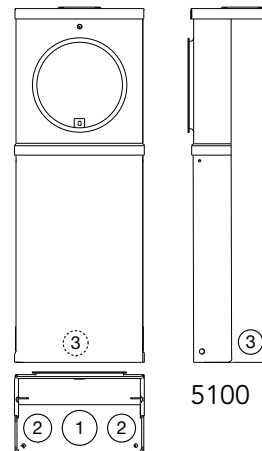

## 125 Amp | Surface Mount Power Outlets

| Catalog Number | Metered/Unmetered | Receptacle Configuration | Circuit Breaker Configuration | Loop Feed | Connectors Line | Dimensions |    |     | Knockouts |    |    |
|----------------|-------------------|--------------------------|-------------------------------|-----------|-----------------|------------|----|-----|-----------|----|----|
|                |                   |                          |                               |           |                 | D"         | W" | H"  | 1         | 2  | 3  |
| U5000-XL       | Unmetered         | —                        | —                             | Yes       | (2) 1/0-#12     | 5½         | 9⅞ | 19¼ | 2         | 1½ | 1¼ |
| U5000-XL-41    | Unmetered         | A                        | X                             | Yes       | (2) 1/0-#12     | 5½         | 9⅞ | 19¼ | 2         | 1½ | 1¼ |
| U5000-XL-55    | Unmetered         | B                        | Y                             | Yes       | (2) 1/0-#12     | 5½         | 9⅞ | 19¼ | 2         | 1½ | 1¼ |
| U5000-XL-75    | Unmetered         | C                        | Z                             | Yes       | (2) 1/0-#12     | 5½         | 9⅞ | 19¼ | 2         | 1½ | 1¼ |
| U5100-XL       | Metered           | —                        | —                             | No        | #6-250          | 5½         | 9⅞ | 25  | 2         | 1½ | 1¼ |
| U5100-XL-41    | Metered           | A                        | X                             | No        | #6-250          | 5½         | 9⅞ | 25  | 2         | 1½ | 1¼ |
| U5100-XL-55    | Metered           | B                        | Y                             | No        | #6-250          | 5½         | 9⅞ | 25  | 2         | 1½ | 1¼ |
| U5100-XL-75    | Metered           | C                        | Z                             | No        | #6-250          | 5½         | 9⅞ | 25  | 2         | 1½ | 1¼ |

### Receptacle Configurations

| A                        | B                         | C                                    |
|--------------------------|---------------------------|--------------------------------------|
|                          |                           |                                      |
| (1) TT30R, (1) 5-20R GFI | (1) 14-50R, (1) 5-20R GFI | (1) 14-50R, (1) TT30R, (1) 5-20R GFI |

### Circuit Breaker Configurations

| X                                      | Y  | Z   |
|--|--|---|
|  |  |   |
| (1) 30A, 1P, 120V<br>(1) 20A, 1P, 120V | (1) 50A, 2P, 120/240V<br>(1) 20A, 1P, 120V | (1) 50A, 2P, 120/240V<br>(1) 30A, 1P, 120V<br>(1) 20A, 1P, 120V |

### NOTE

These units are typically used for submetering applications.

Contact factory for additional configurations not shown here.



Please consult serving utility for their requirements prior to ordering or installing, as specifications and approvals vary by utility, and may require local electrical inspector approval. All installations must be installed by a licensed electrician and must comply with all national and local codes, laws and regulations. Milbank reserves the right to make changes in specifications and features shown without notice or obligation.



# Power Outlet Pedestals

Millennium Series | 120/240 VAC

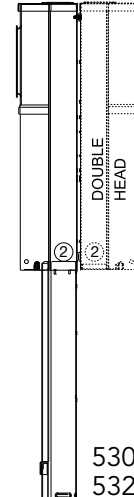
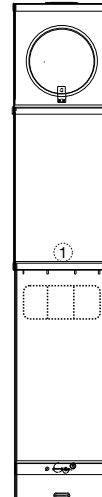
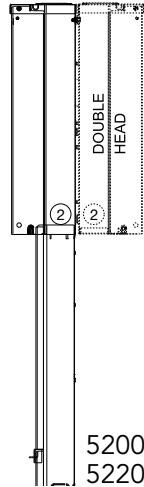
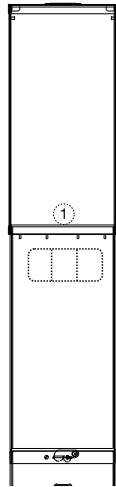

U5200-XL-75

U5300-O-75

## 125 Amp | Power Outlet Pedestals

| Catalog Number | Double Head Catalog Number | Metered/Unmetered | Receptacle Configuration | Circuit Breaker Configuration | Dimensions                     |                               |                                | Mounting Type |
|----------------|----------------------------|-------------------|--------------------------|-------------------------------|--------------------------------|-------------------------------|--------------------------------|---------------|
|                |                            |                   |                          |                               | D"                             | W"                            | H"                             |               |
| U5200-XL       | U5220-XL                   | Unmetered         | —                        | —                             | 5 <sup>5</sup> / <sub>16</sub> | 9 <sup>7</sup> / <sub>8</sub> | 64 <sup>1</sup> / <sub>2</sub> | Direct Burial |
| U5200-XL-41    | U5220-XL-41                | Unmetered         | A                        | X                             | 5 <sup>5</sup> / <sub>16</sub> | 9 <sup>7</sup> / <sub>8</sub> | 64 <sup>1</sup> / <sub>2</sub> | Direct Burial |
| U5200-XL-55    | U5220-XL-55                | Unmetered         | B                        | Y                             | 5 <sup>5</sup> / <sub>16</sub> | 9 <sup>7</sup> / <sub>8</sub> | 64 <sup>1</sup> / <sub>2</sub> | Direct Burial |
| U5200-XL-75    | U5220-XL-75                | Unmetered         | C                        | Z                             | 5 <sup>5</sup> / <sub>16</sub> | 9 <sup>7</sup> / <sub>8</sub> | 64 <sup>1</sup> / <sub>2</sub> | Direct Burial |
| U5300-O        | U5320-O                    | Metered           | —                        | —                             | 5 <sup>5</sup> / <sub>16</sub> | 9 <sup>7</sup> / <sub>8</sub> | 70 <sup>1</sup> / <sub>4</sub> | Direct Burial |
| U5300-O-41     | U5320-O-41                 | Metered           | A                        | X                             | 5 <sup>5</sup> / <sub>16</sub> | 9 <sup>7</sup> / <sub>8</sub> | 70 <sup>1</sup> / <sub>4</sub> | Direct Burial |
| U5300-O-55     | U5320-O-55                 | Metered           | B                        | Y                             | 5 <sup>5</sup> / <sub>16</sub> | 9 <sup>7</sup> / <sub>8</sub> | 70 <sup>1</sup> / <sub>4</sub> | Direct Burial |
| U5300-O-75     | U5320-O-75                 | Metered           | C                        | Z                             | 5 <sup>5</sup> / <sub>16</sub> | 9 <sup>7</sup> / <sub>8</sub> | 70 <sup>1</sup> / <sub>4</sub> | Direct Burial |

## Notes

- **Receptacle Configurations** - Reference chart on page 79.

### NOTE

These units are typically used for submetering applications. Contact factory for additional configurations not shown here. Pad mount is available. Contact factory for information.

Please consult serving utility for their requirements prior to ordering or installing, as specifications and approvals vary by utility, and may require local electrical inspector approval. All installations must be installed by a licensed electrician and must comply with all national and local codes, laws and regulations. Milbank reserves the right to make changes in specifications and features shown without notice or obligation.



# Replacement Receptacle Plates

*For Millennium Series Products*

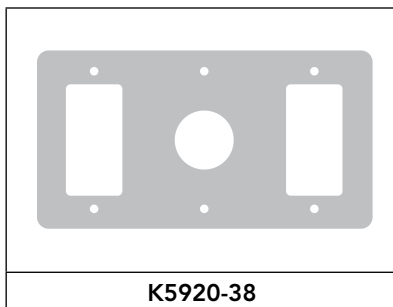
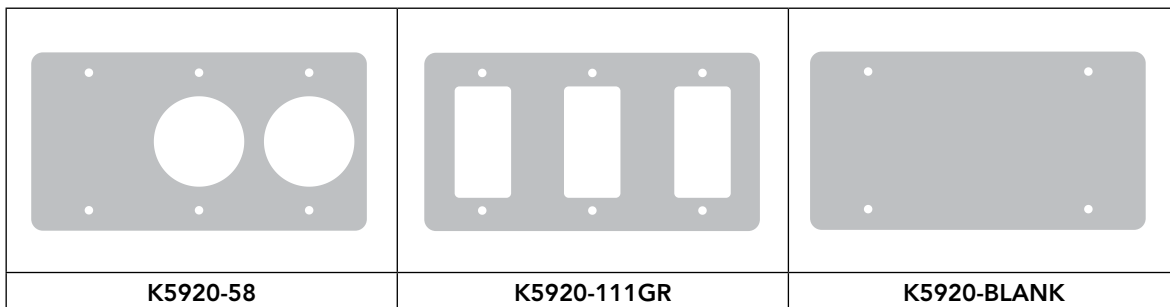
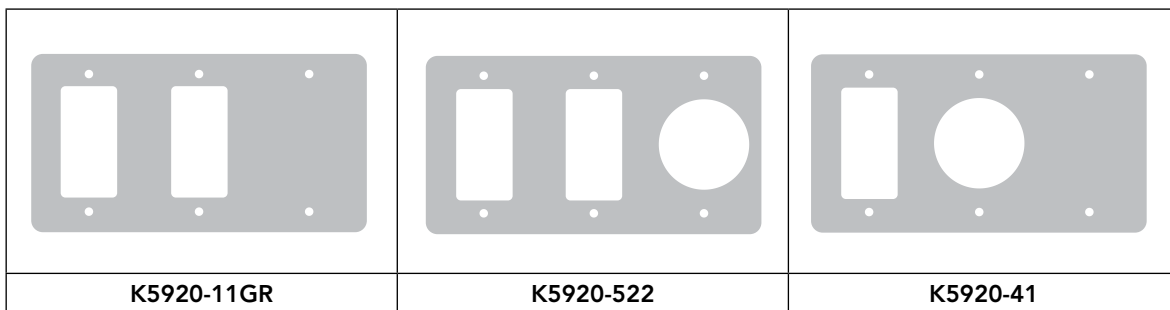
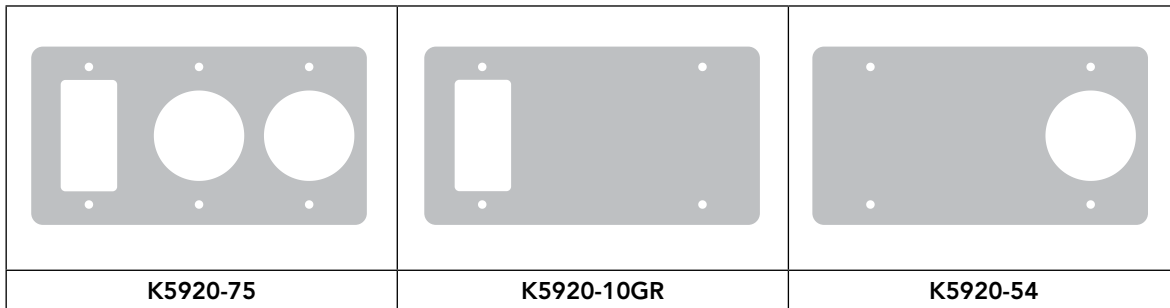

## Notes

- For application details, consult factory.



Please consult serving utility for their requirements prior to ordering or installing, as specifications and approvals vary by utility, and may require local electrical inspector approval. All installations must be installed by a licensed electrician and must comply with all national and local codes, laws and regulations. Milbank reserves the right to make changes in specifications and features shown without notice or obligation.

# Lighting Accessories

For Millennium Series Products

## Internal LED Light Kits for Unmetered Power Outlets (U5000 & U5200)

|                     |   |   |
|---------------------|---|---|
| <b>Application</b>  | Internal light kit for unmetered power outlets  |  |
| <b>LED Features</b> | Includes new LED light, lamp shield and opaque hinge cover lens. Factory wired to 20 amp GFI circuit. May be wired to separate 20 amp circuit breaker. Order <b>Q120</b> separately.<br><br>Cover on unmetered power outlet is 19 1/8" in height. |   |
| <b>Ordering</b>     | Order with <b>-LD</b> suffix (after catalog number) for factory installed.<br><br>Order catalog number <b>K6212</b> for field installed.  |   |

## Internal Fluorescent Light Kits for Unmetered Power Outlets (U5000 & U5200)

|                             |   |  |
|-----------------------------|---|--|
| <b>Application</b>          | Internal light kit for unmetered power outlets  |  |
| <b>Fluorescent Features</b> | Includes 5-watt fluorescent lamp socket, ballast, lamp shield and opaque hinge cover lens. Factory wired to 20 amp GFI circuit. May be wired to separate 20 amp circuit breaker. Order <b>Q120</b> separately.<br><br>Cover on unmetered power outlet is 19 1/8" in height. |  |
| <b>Ordering</b>             | Order with <b>-L</b> suffix (after catalog number) for factory installed.<br><br>Order catalog number <b>K5411</b> for field installed.   |  |

## Photoelectric Light Control Kit

|                    |   |   |
|--------------------|---|---|
| <b>Application</b> | Photoelectric light control kit for <b>K5411</b> light kits.  |  |
| <b>Features</b>    | 2.5 amp, 120 volt photo electrical control wired in series with <b>K5411</b> light kits.  |   |
| <b>Ordering</b>    | Order with <b>-LPC</b> suffix for factory installed light and PE control.<br><br>Order catalog number <b>K5413</b> for field installed. |   |

### WARNING!

Always disconnect power prior to installing these devices.

Please consult serving utility for their requirements prior to ordering or installing, as specifications and approvals vary by utility, and may require local electrical inspector approval. All installations must be installed by a licensed electrician and must comply with all national and local codes, laws and regulations. Milbank reserves the right to make changes in specifications and features shown without notice or obligation.



### Internal Light Kits for Metered Power Outlets (U5100 & U5300)

|                     |  |   |
|---------------------|--|---|
| <b>Application</b>  | Internal light kit for metered power outlets   |  |
| <b>LED Features</b> | Includes new <b>LED light</b> , lamp shield and opaque hinge cover lens. Factory wired to 20 amp GFI circuit. May be wired to separate 20 amp circuit breaker. Order <b>Q120</b> separately.<br><br>Cover on metered power outlet is 15¼" in height. |   |
| <b>Ordering</b>     | Order with <b>-LD</b> suffix (after catalog number) for factory installed.<br><br>Order catalog number <b>K6213</b> for field installed.   |   |

|                             |  |  |
|-----------------------------|--|--|
| <b>Application</b>          | Internal light kit for metered power outlets   |  |
| <b>Fluorescent Features</b> | Includes 5-watt fluorescent lamp socket, ballast, lamp shield and opaque hinge cover lens. Factory wired to 20 amp GFI circuit. May be wired to separate 20 amp circuit breaker. Order <b>Q120</b> separately.<br><br>Cover on metered power outlet is 15¼" in height. |  |
| <b>Ordering</b>             | Order with <b>-L</b> suffix (after catalog number) for factory installed.<br><br>Order catalog number <b>K5412</b> for field installed.  |  |

### Photoelectric Light Control Kit

|                    |   |   |
|--------------------|---|---|
| <b>Application</b> | Photoelectric light control kit for <b>K5412</b> light kits.  |  |
| <b>Features</b>    | 2.5 amp, 120 volt photo electrical control wired in series with <b>K5412</b> light kits.  |   |
| <b>Ordering</b>    | Order with <b>-LPC</b> suffix for factory installed light and PE control.<br><br>Order catalog number <b>K5413</b> for field installed. |   |

**WARNING!**

Always disconnect power prior to installing these devices.

# Telecom and Pedestal Accessories

For Millennium Series Products

# 85

TELECOM AND  
PEDESTAL  
ACCESSORIES

## Telephone and Cable TV Kit

|                    |   |   |
|--------------------|---|---|
| <b>Application</b> | Mounts to rear of pedestal series <b>U5200</b> and <b>U5300</b> . May also be adaptable to a wooden or similar structure.   |  <p><b>K4709-02-3R    K4709-02</b></p> |
| <b>Features</b>    | Single: 16" galvanized raceway, (1) RJ11 telephone jack and (1) Type F coaxial CATV jack.<br><br>Dual: 16" galvanized raceway, (2) RJ11 telephone jacks and (1) Type F coaxial CATV jack.<br><br>Includes mounting hardware and instructions. |   |
| <b>Ordering</b>    | Single line telephone and cable TV kit order <b>K4709-02</b> .  |   |
| <b>Note</b>        | Confirm acceptability with Cable TV and Telephone provider before ordering or installing these devices.   |   |

## Water Shroud with Hardware

|                    |  |  |
|--------------------|--|--|
| <b>Application</b> | Used to cover water pipe and provide means to mount hose bib to rear of pedestal.                        |  |
| <b>Features</b>    | Includes mounting hardware and instructions.<br><br>Matches <b>K4709</b> kits when mounted side-by-side. |  |
| <b>Ordering</b>    | Order catalog number <b>K4709-WS</b> .   |  |

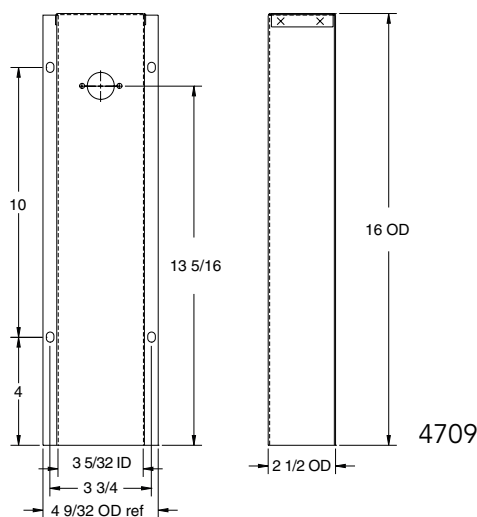

Please consult serving utility for their requirements prior to ordering or installing, as specifications and approvals vary by utility, and may require local electrical inspector approval. All installations must be installed by a licensed electrician and must comply with all national and local codes, laws and regulations. Milbank reserves the right to make changes in specifications and features shown without notice or obligation.



# Pedestal Mounting Accessories

*For Millennium Series Products*

## Field-Installed Pad Mount Kit

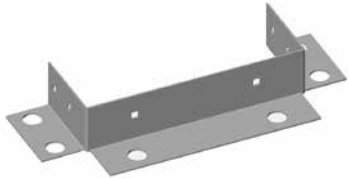
|                    |   |  |
|--------------------|---|--|
| <b>Application</b> | Field installed pad mount kit with (6) 3/4" mounting holes.   |  |
| <b>Features</b>    | Includes 1/4-20 stainless steel hardware to attach pad mount base to post.<br><br>Anchor bolt kit sold separately (order catalog number <b>K5421</b> ). |  |
| <b>Ordering</b>    | Order catalog number <b>K5410</b> .   |  |

## Stabilizer Foot with Hardware

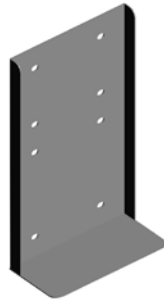
|                    |  |  |
|--------------------|--|--|
| <b>Application</b> | Stabilizes direct burial type posts in unstable soil conditions.               |  |
| <b>Features</b>    | Includes 1/4-20 hardware to attach to <b>U5200</b> and <b>U5300</b> pedestals. |  |
| <b>Ordering</b>    | Order catalog number <b>K5415</b> .  |  |

## Anchor Bolt Kit

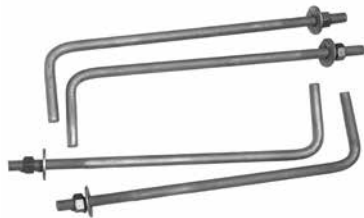
|                    |   |  |
|--------------------|---|--|
| <b>Application</b> | Concrete anchor bolt kit designed to attach pad mount base to concrete.                     |  |
| <b>Features</b>    | (4) sets of zinc-plated 5/8-11 x 10" bolt with 2" toe.<br><br>Includes nut and flat washer. |  |
| <b>Ordering</b>    | Order catalog number <b>K5421</b> .   |  |

# Metering & Receptacle Accessories

For Millennium Series Products

## Field-Installed Meter Kits





|                    |   |   |
|--------------------|---|---|
| <b>Application</b> | Field installed meter kit for <b>U5000</b> and <b>U5200</b> power outlets.  |  |
| <b>Features</b>    | 100 amp cast meter socket, CL200 E-Z Read Meter, sealing ring, security seal, 1" Milbank hub, nipple and mounting screws.<br><br>See CL200 for Watt-hour meter specification. |   |
| <b>Ordering</b>    | Order catalog number <b>K4800-01 mechanical meter kit</b> , or <b>K4800-D digital meter kit</b> .   |   |

## E-Z Read Watt-Hour Meter

|                    |   |  |
|--------------------|---|--|
| <b>Application</b> | 200 amp E-Z read watt-hour meter designed to be field installed on the U5100 and U5300 metered power outlets.   |  |
| <b>Features</b>    | 200 amp form 2S 120/240 volt.<br><br>Numeric readout in full kilowatt increments. No "tenths" dial; digital readout option available.<br><br>Remanufactured within 1% accuracy. |  |
| <b>Ordering</b>    | Order catalog number <b>CL200-D</b> .   |  |

**CL200-D**  
Digital

## Single Receptacle Only Power Outlet

|                           |   |  |  |  |
|---------------------------|---|--|--|--|
| <b>Application</b>        | Overhead/underground power outlet receptacle, suitable for RV, temporary service, campground, marina and boatyard equipment.    |  |  |  |
| <b>Features</b>           | Type 3R, 120/240 volt single phase.<br><br>Lockable cover.<br><br>Breaker not included (in receptacle box).                     |  |  |  |
| <b>Ordering</b>           | Order catalog number from chart below.  |  |  |  |
| <b>Receptacle Options</b> | <br><b>P-10GWR</b><br>20A 5-20GR<br>120V GFI | <br><b>P-13</b><br>30A TT-30R<br>120V | <br><b>P-54</b><br>50A 14-50R<br>120/240V |  |

### WARNING!

Always disconnect power prior to installing these devices.

Please consult serving utility for their requirements prior to ordering or installing, as specifications and approvals vary by utility, and may require local electrical inspector approval. All installations must be installed by a licensed electrician and must comply with all national and local codes, laws and regulations. Milbank reserves the right to make changes in specifications and features shown without notice or obligation.





## Replacement Parts & Accessories

For Millennium Series Products

|   |   |   |   |
|---|---|---|---|
|  |  |  |  |
| <b>Q120</b><br>20 Amp, 1 pole<br>circuit breaker                                  | <b>708784-MO</b><br>20 Amp, 1 pole<br>GFI circuit breaker                         | <b>Q130</b><br>30 Amp, 1 pole<br>circuit breaker                                  | <b>Q250</b><br>50 Amp, 2 pole<br>circuit breaker                                    |

| Main Breaker Kit<br>Part number | Metered/Unmetered<br>Surface Mount/ Pedestal | Amp |
|---------------------------------|--|-----|
| K5400-100MBM                    | Metered                                      | 100 |
| K5400-100MBU                    | Unmetered                                    | 100 |



|   |   |   |
|---|---|---|
|  |  |  |
| <b>Z918466-AC</b><br>Lug landing base   | <b>Z917602-AC</b><br>Circuit breaker base<br>(6-circuit)                            | <b>Z915141-AC</b><br>Left or right meter block<br>assembly                            |





# Replacement Parts & Accessories

For Millennium Series Products

**89**  
REPLACEMENT  
PARTS &  
ACCESSORIES

|  |  |  |
|--|--|--|
|                 |               |  |
| <b>Z918449-AC</b><br>(19" unmetered)<br><b>Z918447-AC</b><br>(15" metered)<br><i>Hinge cover</i> | <b>Z818052-SC</b><br>(19" unmetered)<br><b>Z818480-SC</b><br>(15" metered)<br><i>Deadfront</i> | <b>MR-2</b><br><i>Snap action sealing ring</i>                                     |

|  |  |  |
|--|--|--|
|  |  |  |
| <b>Z708080-MO</b><br><i>20 Amp GFI receptacle</i><br>NEMA 5-20GR                   | <b>Z701776-MO</b><br><i>30 Amp receptacle</i><br>NEMA TT-30                        | <b>Z708767-MO</b><br><i>50 Amp receptacle</i><br>NEMA 14-50R                         |

Please consult serving utility for their requirements prior to ordering or installing, as specifications and approvals vary by utility, and may require local electrical inspector approval. All installations must be installed by a licensed electrician and must comply with all national and local codes, laws and regulations. Milbank reserves the right to make changes in specifications and features shown without notice or obligation.





### Specifications

- 600 to 1200 amp, 120/240 Volt, 1Ø distribution bus accepts up to (6) 2 pole, 200 amp circuit breakers. Order from chart below.
- Costly main breaker not required per NEC 230-71.
- Economical alternative to costly wall hung or strut-mounted panel boards and load centers.
- Low profile, aesthetic design can be located near utility transformers or fed from a main service to a convenient location.
- Pad mounted Type 3R powder coated aluminum enclosure – standard color is gray.
- Hinge door and lift off rear service door are lockable and sealable for security.

**NOTE:** Consult local code enforcement for pad size requirements. Order catalog number **CP-24-PDMNT-CALT** pad mount base or catalog number **CP-ABK5/8** anchor bolt kit separately.

### Circuit Breakers

| Catalog Number | Amp  | Phase | Volts   | Connectors CU/AL                          |                     | Dimensions |    |    |
|----------------|------|-------|---------|---|---------------------|------------|----|----|
|                |      |       |         | Line                                      | Load                | D"         | W" | H" |
| CP3B-AUX-1200  | 1200 | 1Ø    | 120/240 | (3) 1-600 kcmil/Ø or<br>(3) 2-250 kcmil/Ø | See Circuit Breaker | 17         | 24 | 41 |

### Circuit Breakers

200 Amp Frame | Plug-In | 10K AIC | Two-Pole | Common Trip



| 2-Pole Rating | 10K AIC Plug-In | Package Quantity | Connectors CU/AL |         |
|---------------|-----------------|------------------|------------------|---------|
|               |                 |                  | Line             | Load    |
| 100           | UQFP-100        | 1                | #3-#1            | #1-1/0  |
| 125           | UQFP-125        | 1                | #3-#1            | #1-1/0  |
| 150           | UQFP-150        | 1                | 1/0-300          | 2/0-300 |
| 175           | UQFP-175        | 1                | 1/0-300          | 2/0-300 |
| 200           | UQFP-200        | 1                | 1/0-300          | 2/0-300 |
| 225           | UQFP-225        | 1                | 1/0-300          | 2/0-300 |

# Recreational Vehicle

600-1200 Amp | Pad mounted Panel Board



U4540-XL

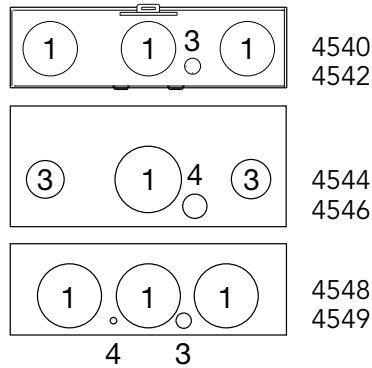
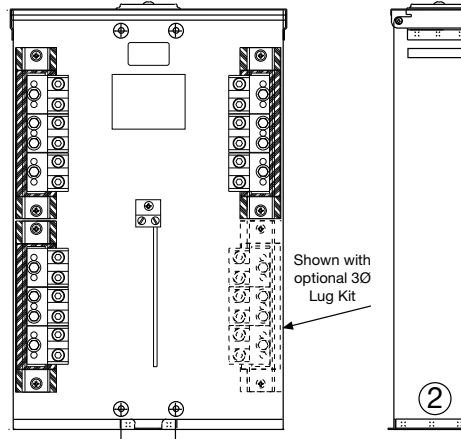

## Terminal Boxes | 1Ø & 3Ø | 120/240 Volt

| Catalog Number | Amp | Phase | Volts   | Hub  | 1Ø to 3Ø Kit | Connectors CU7AL         | Dimensions |          |    | Knockouts |       |       |          |          |
|----------------|-----|-------|---------|------|--------------|--------------------------|------------|----------|----|-----------|-------|-------|----------|----------|
|                |     |       |         |      |              |                          | D"         | W"       | H" | 1         | 2     | 3     | 4        | 5        |
| U4544-XL       | 100 | 1     | 120/240 | C.P. | K4543        | (6) #12-1/0              | 4 1/8      | 9 13/16  | 18 | —         | 2     | 2     | 1        | 1/4, 1/2 |
| U4546-XL       | 100 | 3     | 600     | C.P. | N/A          | (6) #12-1/0              | 4 1/8      | 9 13/16  | 18 | —         | 2     | 2     | 1        | 1/4, 1/2 |
| U4540-XL       | 200 | 1     | 120/240 | C.P. | K4539        | (6) #6-350               | 4 1/8      | 14 13/16 | 23 | —         | 1 1/4 | 2 1/2 | 2 1/2    | 1/4, 1/2 |
| U4542-XL       | 200 | 3     | 600     | C.P. | N/A          | (6) #6-350               | 4 1/8      | 14 13/16 | 23 | —         | 1 1/4 | 2 1/2 | 2 1/2    | 1/4, 1/2 |
| U4548-RXL      | 400 | 1     | 120/240 | C.P. | K4547        | (3) #6-350 or (2) #4-600 | 5          | 15 1/2   | 27 | 3         | 3     | 3     | 1/4, 1/2 | 1/4      |
| U4549-RXL      | 400 | 3     | 600     | C.P. | N/A          | (3) #6-350 or (2) #4-600 | 5          | 15 1/2   | 27 | 3         | 3     | 3     | 1/4, 1/2 | 1/4      |

## Notes

- **Hub:** Standard hub opening on top with closing plate attached.
- **Features:** UL listed pad lockable Type 3R enclosure.
- **3Ø 120/240V application:** Field-installable 3Ø lug kit converts 1Ø unit to 3Ø unit.

Please consult serving utility for their requirements prior to ordering or installing, as specifications and approvals vary by utility, and may require local electrical inspector approval. All installations must be installed by a licensed electrician and must comply with all national and local codes, laws and regulations. Milbank reserves the right to make changes in specifications and features shown without notice or obligation.



# Dry Type Transformers

*With Distribution for RV & Mobile Home Park Applications*



| 480 Volts to 120/240 Single Phase |      |           |
|-----------------------------------|------|-----------|
| Catalog Number                    | KVA  | Weight    |
| 10URMD*                           | 100  | 1050 lbs. |
| 16URMD*                           | 167½ | 1400 lbs. |
| 20URMD*                           | 200  | 1650 lbs. |
| 25URMD                            | 250  | 1950 lbs. |

\* UL listed

| 2400 Volts to 120/240 Single Phase |      |           |
|------------------------------------|------|-----------|
| Catalog Number                     | KVA  | Weight    |
| 10URMD24                           | 100  | 1050 lbs. |
| 16URMD24                           | 167½ | 1400 lbs. |
| 20URMD24                           | 200  | 1650 lbs. |
| 25URMD24                           | 250  | 1950 lbs. |

| Voltage  | Dimensions |     |     |
|----------|------------|-----|-----|
|          | A          | B   | C   |
| 480V, A  | 48"        | 38" | 40" |
| 2400V, A | 48"        | 41" | 53" |

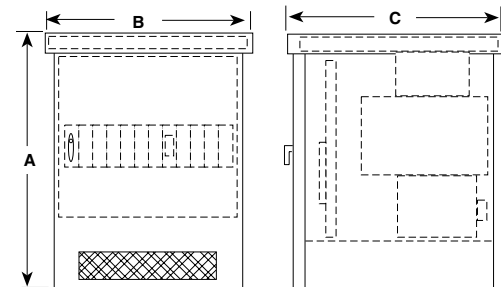
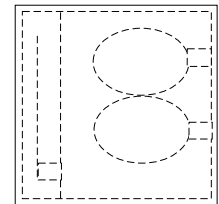

## Specifications

- Built in accordance with NEMA, ASA and AIEEE standards. Designed and tested to withstand 150% of rated load for two continuous hours. Consult local utility for acceptance of this product.
- Integrated design of the enclosure, core and coil, and secondary distribution panel permits convenient vertical line and load terminations.
- Primary and/or secondary main circuit breaker protection available. Consult local utility for 480 volt overcurrent protection requirements. Single fuse primary overcurrent protection provided on 2400 volt and above units.
- Other primary voltages available: 4160, 4800, 7200, 7960, & 12,470. Consult factory. Not UL listed.

## Core and Coil

- Aluminum wound (Copper available)
- Standard voltage taps @ 2FCAN and 4FCBN
- Rated at 150° C temperature rise

## Distribution Bus

- 1600 amp tin plated aluminum
- Space available for up to (12) circuit breakers – 1600 amp maximum
- Uses Milbank type UQFP-100 through 200 amp circuit breakers (See page 117-118)

## Enclosure

- Type 3R enclosure
- Powder coated galvanized steel (aluminum available)
- Lockable primary and secondary doors
- Lifting hooks and fork lift slots provided



Please consult serving utility for their requirements prior to ordering or installing, as specifications and approvals vary by utility, and may require local electrical inspector approval. All installations must be installed by a licensed electrician and must comply with all national and local codes, laws and regulations. Milbank reserves the right to make changes in specifications and features shown without notice or obligation.

# Commercial Pedestals

Attractive | Easy to Install | Secure | Cost-Effective

**Milbank Commercial Pedestals** are pad-mounted, weatherproof electrical enclosures consisting of a utility pull section with optional meter socket, and a customer section containing distribution and control equipment. Milbank Commercial Pedestals are an attractive, secure, easy to install and cost-effective solution when underground remote site power distribution and control equipment is required, replacing unsightly and inefficient strut and backboard structures.



Strut and backboard



Commercial pedestal

## UL Listed as Industrial Control Equipment (File E113855)

### Standard Features

- Type 3R rain resistant, vandal-resistant cabinet of polyurethane powder coated steel (aluminum or stainless steel also available)
- UL listed as enclosed industrial control equipment (UL508)
- Isolated lockable & sealable utility metering and lug landing sections
- Lockable customer section for distribution and control equipment with internal deadfront
- Print pocket inside customer section door contains wiring schematics and installation instructions
- Most load centers are UL listed for use with various manufacturers' circuit breakers
- All stainless steel external hardware (screws, bolts, hinges, handles, hasps and sealing screws)

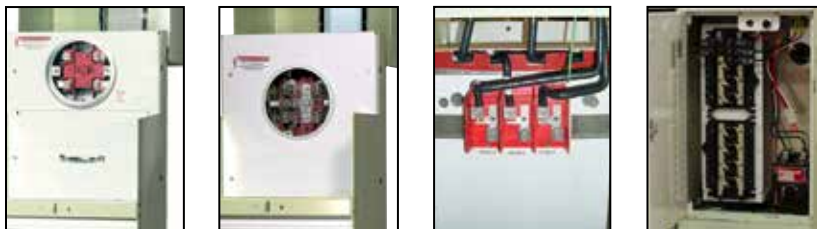

Please consult serving utility for their requirements prior to ordering or installing, as specifications and approvals vary by utility, and may require local electrical inspector approval. All installations must be installed by a licensed electrician and must comply with all national and local codes, laws and regulations. Milbank reserves the right to make changes in specifications and features shown without notice or obligation.





## Applications

These units are ideal for controlling and metering:

- Traffic signals
- Street lighting
- Power distribution for EV charging stations
- Irrigation and sprinkler systems
- Cell towers and telephone vaults
- Pump stations
- Temporary power for fairgrounds, swap meets, outdoor markets, portable offices, holiday lights, etc.
- Outdoor lighting for athletic fields, tennis and basketball courts, parking lots, landscaping and subdivision entrances, etc.

## Available Factory-Installed Options

- Meter sockets: ring type or ringless, up to 400 amp
- Main and branch breakers or T fuses
- Distribution: copper load centers and panel boards
- Clocks, timers and relays
- Photoelectric cells and controls
- Power receptacles: pin and sleeve, twist lock or straight blade
- Contactors: definite purpose, electrical or mechanically held, IEC and mercury types
- Surge protection and lightning arrestors
- Reserve inlet generator receptacle with interlocked circuit breakers
- Motor starters and relays
- Push button controls
- Thermostat controls, fans and heating strips
- Power blocks and terminal blocks
- Steel, aluminum and plywood backboards
- Transformers
- Interlock devices for circuit breakers
- Available in steel, aluminum (raw painted or anodized) or stainless steel construction with powder coated finish available in eight standard colors or special-ordered RAL colors
- Available for applications up to 400 amp, 120V, 208V, 240V, 277V, 480V - 1Ø or 3Ø

## Accessories



**K3865**  
Fifth terminal kit for use with ringless meter sockets

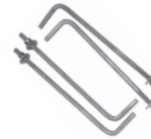

**CP-ABK5/8**  
Anchor bolt kit (includes four 5/8 - 13 x 18" anchor bolts)



**105J**  
Fifth terminal kit for use with ring-type meter sockets



**CP-TC7D**  
7-day time clock kit  
**CP-TC24H**  
24-hour time clock kit  
**CP-TCWIRE**  
Male 4-pin connector and wiring harness for use with time clocks other than above

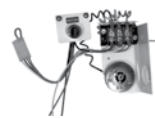

**CP-PE-HOA-3POS**  
HOA switch for field installation



**CP-16PDMNT-CALT**  
16" pedestal mounting base  
**CP-24PDMNT-CALT**  
24" pedestal mounting base (includes mounting hardware)



Please consult serving utility for their requirements prior to ordering or installing, as specifications and approvals vary by utility, and may require local electrical inspector approval. All installations must be installed by a licensed electrician and must comply with all national and local codes, laws and regulations. Milbank reserves the right to make changes in specifications and features shown without notice or obligation.

# Commercial Pedestals

Main Load Center Series | Custom Designs Available

## CP3B "ML" Series

Main Load Center Series

1Ø3 wire 120/240V or 208Y/120V

Application: remote site service for multiple loads

**Milbank Main Load Center Commercial Pedestals** are designed to handle the vast majority of all requirements in a standard, stocked configuration.

- All units feature a load center with a plug-on, back-fed main breaker.
- Load center has 16 positions for the 100 amp pedestals and 24 circuits for the 200 amp pedestals.
- Both sizes include sub-feed lugs to allow feeding an external panel.

If your application requires turning loads on based on "dusk-to-dawn" requirements, be sure to see the Milbank Switched Load Center Commercial Pedestal products on the following page.

### Features

These units include everything required for remote site service:

- NEMA 3R construction.
- Expandable: load centers allow for future expansion without costly modifications.
- All units feature 200 amp meter socket with optional field-installable fifth terminal kit available.
- 22K amp interrupting capacity (AIC) standard.
- Optional mounting base can be embedded in concrete for fast, easy installation.
- Separate sealable and lockable utility termination section.
- Separate sealable and lockable metering section.
- Separate sealable and lockable customer section with a load center for "always on" loads that include a main circuit breaker, 20 (125 or 200 amp model) or 14 (100 amp model) blank breaker spaces and a circuit directory to document configuration.

**Note**  
All meter form and bypass options available to meet utility requirements.



**Typical Applications**  
Remote site service for multiple loads.

| Standard Pedestals | Optional Fifth Terminal Kit | Main CB |         | Load Center Circuits | Meter Socket Type                 |
|--------------------|-----------------------------|---------|---------|----------------------|-----------------------------------|
|                    |                             | Amp     | Spaces  |                      |                                   |
| CP3B11115A22       | 105J                        | 100     | 1,2     | 16                   | Ring type with test/bypass blocks |
| CP3B12119A22       | 105J                        | 200     | 1,2,3 4 | 24                   | Ring type with test/bypass blocks |
| CP3B51115A22       | K3865                       | 100     | 1,2     | 16                   | Ringless socket with lever bypass |
| CP3B52119A22       | K3865                       | 200     | 1,2,3,4 | 24                   | Ringless socket with lever bypass |

### Notes

- Chart shows standard, stocked items. Other options and features are available. Contact factory for options, details and availability.

Please consult serving utility for their requirements prior to ordering or installing, as specifications and approvals vary by utility, and may require local electrical inspector approval. All installations must be installed by a licensed electrician and must comply with all national and local codes, laws and regulations. Milbank reserves the right to make changes in specifications and features shown without notice or obligation.



### CP3B "SL" Series

Switched Load Center Series  
1Ø3 wire 120/240V or 208Y/120V

**Milbank Switched Load Center Commercial Pedestals** are designed not only to provide power for various loads, but also to switch specific loads on and off under certain conditions. A photoelectric cell is used for these controlled loads, and an optional time clock is also available.

### Features

These units include everything required for remote site service:

- NEMA 3R construction.
- Expandable: load centers allow for future expansion without costly modifications.
- All units feature 200 amp meter socket with optional field-installable fifth terminal kit available.
- 22K amp interrupting capacity (AIC) standard.
- Optional mounting base can be embedded in concrete for fast, easy installation.
- Separate sealable and lockable utility termination section.
- Separate sealable and lockable metering section.
- Separate sealable and lockable customer section with a control circuit including PE receptacle, Lexan® window, glare shield, Hand-Off-Auto (HOA) switch, contractor controlling a 16-circuit load center for controlled loads, a pre-mounted DIN rail and pre-wired connector to add an optional "plug-and-play" time clock kit for PE on and TC off operation and a circuit directory to document configuration.
- A load center for "always on" loads that includes a main circuit breaker, a control power circuit breaker, a switched load center main breaker, nine (125 or 200 amp model) or 11 (100 amp model) blank breaker spaces and a circuit directory to document configuration.

**Note**  
All meter form and bypass options available to meet utility requirements.



**Typical Applications**  
Traffic signals, parking lots, highways & athletic field lighting

| Standard Pedestals | Optional Fifth Terminal Kit | Main CB |         | Contactor amperage | Meter Socket Type                 |
|--------------------|-----------------------------|---------|---------|--------------------|-----------------------------------|
|                    |                             | Amp     | Spaces  |                    |                                   |
| CP3B11110A22SL1    | 105J                        | 100     | 1,3     | 60                 | Ring type with test/bypass blocks |
| CP3B12110A22SL1    | 150J                        | 200     | 1,2,3,4 | 100                | Ring type with test/bypass blocks |
| CP3B51110A22SL1    | K3865                       | 100     | 1,3     | 60                 | Ringless socket with lever bypass |
| CP3B52110A22SL1    | K3865                       | 200     | 1,2,3,4 | 100                | Ringless socket with lever bypass |

### Notes

- Chart shows standard, stocked items. Other options and features are available. Contact factory for options, details and availability.



Please consult serving utility for their requirements prior to ordering or installing, as specifications and approvals vary by utility, and may require local electrical inspector approval. All installations must be installed by a licensed electrician and must comply with all national and local codes, laws and regulations. Milbank reserves the right to make changes in specifications and features shown without notice or obligation.



# Commercial Pedestals

## 400 Amp Series



**Milbank 400 Amp Commercial Pedestals** are designed to provide a weather and vandal resistant metered enclosure for various loads and distribution. Each pedestal has been designed to handle a wide range of applications using standard, stocked configurations.

- Choice of a single main breaker or twin service disconnect breakers gives flexibility to the pedestal design.
- Optional distribution with feed-through lugs below the service disconnect breakers allows the pedestal to handle numerous applications.
- Typical applications include remote homes where the metering is best located at the curb side or other remote area. The pedestal can also provide power to secondary residence, on-site business, workshop, irrigation, lighting, security or other secondary load.
- Available in custom colors to match home or landscaping.

### Features

These units include everything required for remote service:

- Type 3R construction
- Main circuit breaker or dual service disconnects
- Expandable: load center units allow for future expansion without costly modifications
- Optional mounting base can be embedded in concrete for fast, easy installation
- Separate sealable and lockable utility termination section with lug termination
- Separate sealable and lockable metering section
- A separate sealable and lockable customer section with a circuit directory and a print pocket to hold all documentation
- Meter socket options include ring type with bypass studs, ringless with heavy duty lever bypass, or K-Type bolt-on

#### Typical Applications

Remote site service for residential and commercial job sites.

| Standard Pedestals  | Optional fifth Terminal Kit | Main CB           | Load Center Circuits        | Meter Socket Type                |
|---------------------|-----------------------------|-------------------|-----------------------------|----------------------------------|
| <b>CP3B1411JB</b>   | N/A                         | 320 Amp (400 max) | 0                           | Ring-type with test/bypass studs |
| <b>CP3B14120B</b>   | N/A                         | 2-200 Amp         | (2) 12 circuit <sup>1</sup> | Ring-type with test/bypass studs |
| <b>CP3B54120B22</b> | K3865                       | 2-200 Amp         | (2) 12 circuit <sup>1</sup> | Ringless with lever bypass       |
| <b>CP3B5411JB22</b> | K3865                       | 320 Amp (400 max) | 0                           | Ringless with lever bypass       |

### Notes

- Chart shows standard, stocked items. Other options and features are available. Contact factory for options, details and availability.
- Stud utility landing is standard. Lug kits are available from factory.
- Units with load centers have (2) #6-250 sub-feed lugs on each load center. (Each load center is 200 amp rated and UL listed with: Siemens, General Electric and Cutler-Hammer plug-in style circuit breakers.)

Please consult serving utility for their requirements prior to ordering or installing, as specifications and approvals vary by utility, and may require local electrical inspector approval. All installations must be installed by a licensed electrician and must comply with all national and local codes, laws and regulations. Milbank reserves the right to make changes in specifications and features shown without notice or obligation.



# Commercial Pedestals

## CP3B "IR" Irrigation Control Series



**Milbank "IR" Series Irrigation Pedestals** install quickly and simply—often in less than an hour with a single technician—a fraction of the time typically needed for strut farm and other installation set ups. Additionally, the pedestal comes pre-wired, so the technician simply drops in the pre-drilled concrete box pad, fastens the pedestal and runs the wires. Prewired landing lugs are provided in a separate utility side so that there is no more need to wrestle with hard-to-bend wires. Simply run the utility wire up and land on the lugs. With both the motor starter and disconnect in the same enclosure, all the controls are housed in a safe, lockable pedestal that protects against vandalism and energy theft.

### Features

- 3Ø4W, 480Y/277 volt
- One technician can install in under an hour with use of Milbank's pre-drilled box pad
- All units are UL listed and service entrance rated
- Fused disconnect with accessible handle through the deadfront
- HOA and push button start
- Separate accessible utility side with pre-wired landing lugs
- NEMA rated starters (sizes 1-5)
- Soft start units sizes 30HP-150HP
- 30 amp fuse block for pivot pre-wired in the unit
- White powder coated paint finish helps keep components cooler
  - Options include:
    - Hour meter
    - Chemical injection receptacle
    - Multiple injection receptacle
    - Multiple 30 amp fuse blocks possible

### Typical Applications

Power pedestal for irrigation systems or other pump control applications.

| Standard Pedestals | Exterior Cabinet | NEMA Rating |
|--------------------|------------------|-------------|
| CP3B0281UMWIR04    | White            | 4           |
| CP3B0281UMWIR03    | White            | 3           |
| CP3B0181UMWIR02    | White            | 2           |

### Notes

- Chart shows standard, stocked items. Other options and features are available. Contact factory for options, details and availability.



Please consult serving utility for their requirements prior to ordering or installing, as specifications and approvals vary by utility, and may require local electrical inspector approval. All installations must be installed by a licensed electrician and must comply with all national and local codes, laws and regulations. Milbank reserves the right to make changes in specifications and features shown without notice or obligation.

# Commercial Pedestals

## CP3B "BBS" Battery Backup Series



**Milbank BBS Series Commercial Pedestals** are designed to provide battery backup power for various loads, and to switch specific loads on and off under certain conditions; a photoelectric cell or time clock to control lighting circuits, as an example. Metered and unmetered power distribution options are available. The back-up power pedestal is designed to handle the vast majority of today's back-up power requirements. By using 19" rack design, shelves can be adjusted to accommodate the required batteries and manufactures DC to AC inverters, transfer switches and other related equipment. This design gives the user a wide range of design and configuration options. Complete turnkey, ready to power-up pedestals are offered along with basic units ready to accept batteries and inverters supplied by others.

### Features

- Type 3R construction
- 100 through 320 amp meter socket with the option of either a ring type socket (conforms to EUSERC 308) with or without test/bypass blocks or a heavy duty ringless socket with lever bypass
- Separate sealable utility termination compartment
- An isolated separate customer section with service disconnects, power distribution options and power control
- 19" wide rack in customer compartment for easy layout of equipment
- Battery trays
- Thermostat with cooling fan
- Filtered louvers for heat rise flow through ventilation
- Three point door latch (key or pad lockable)

### Typical Applications

Metered emergency uninterrupted power for traffic intersections, wireless, phone and communications equipment, parking lots, camera and security locations

### Options

- Manual bypass switch
- Transfer switch for generator power back-up
- Generator inlet receptacles 30 through 200 amp
- Pad lockable provision for receptacles
- Police access door
- Metered load center distribution
- Unmetered load center distribution
- Photo electric controls (for street lighting)
- Time clocks
- HOA switches
- Contactors
- GFI duplex receptacles
- Thermostat for heating control
- Heating pads or elements
- Roll out shelves for batteries
- Surge arrestors and lighting arrestors

Please consult serving utility for their requirements prior to ordering or installing, as specifications and approvals vary by utility, and may require local electrical inspector approval. All installations must be installed by a licensed electrician and must comply with all national and local codes, laws and regulations. Milbank reserves the right to make changes in specifications and features shown without notice or obligation.



# Commercial Pedestals

## CP3B "Power Transfer" Series



**Milbank Power Transfer Series Pedestals** provide unmetered AC power, distribution, surge suppression, mechanical interlock and stand-by generator receptacle—all in a neat, compact pedestal.

### Features

- 120/240V 1Ø3W through 277/480V 3Ø4W ratings
- Metered or unmetered units
- Choice of EUSERC ring type or ringless meter sockets
- 60 amp through 400 amp ratings
- UL listed Type 3R rated
- Pad lockable, isolated utility compartments
- 20 amp GFI convenience receptacle
- Lockable recessed generator receptacle door
- Utility and generator indicator light options
- All stainless steel hardware
- Galvanized steel, aluminum or stainless steel cabinet options
- Custom designs available



### Typical Applications

Traffic intersections, cell sites, cable TV, pump and lift stations requiring utility power with backup generator power

### Typical Applications

Traffic intersections, cell sites, cable TV, pump and lift stations requiring utility power with backup generator power



Please consult serving utility for their requirements prior to ordering or installing, as specifications and approvals vary by utility, and may require local electrical inspector approval. All installations must be installed by a licensed electrician and must comply with all national and local codes, laws and regulations. Milbank reserves the right to make changes in specifications and features shown without notice or obligation.

# Commercial Pedestals

CP3BB "CT Metered" Series

101  
COMMERCIAL  
PEDESTALS



**Milbank CT Metered Series Commercial Pedestals** are designed to be used where a smaller service package would be a better choice over large 3R rated combination switchboards. These pedestals have amperage ratings of 400 to 800 amp at voltages up through 480 volt three phase.

## Features

- UL listed, freestanding Type 3R service
- A low profile CT pedestal
- All utility equipment is isolated in separated pad lockable and sealable compartments
- Separate customer compartment designed to hold distribution and control equipment
- Dead front customer construction
- Optional mounting base
- Optional construction in steel, aluminum and stainless steel.
- Wide choice of powder paint colors

## Typical Applications

Large homes, pumping & lift stations, motor control, water treatment plants, EV charging stations, commercial buildings, large remote service requirements, commercial and industrial control systems

Please consult serving utility for their requirements prior to ordering or installing, as specifications and approvals vary by utility, and may require local electrical inspector approval. All installations must be installed by a licensed electrician and must comply with all national and local codes, laws and regulations. Milbank reserves the right to make changes in specifications and features shown without notice or obligation.





**Milbank Slimline Series Commercial Pedestals** provide a sleeker, smaller footprint, with wireway access on the side of the unit rather than the back, allowing maximum flexibility to place the pedestal in tighter spaces.

### Features

- UL listed as service equipment
- 100 or 200 amp
- Vandal-resistant, secure and attractive design
- Customer compartment with distribution and control equipment with swing dead front door, secured with both a hasp/latch and draw latch outer door
- Utility metering compartment protected with a hinged hood, increasing resistance to meter vandalism
- Small footprint
- Wireway located on left side of pedestal for utility incoming wire, allowing pedestal to be mounted with back very close to a wall (14")
- Available in 12" and 20" widths and 50" and 63" (metered) and 43" (unmetered) heights
- Includes a print pocket for plans and drawings
- 200 amp main available
- Voltage range: 120V–480V
- Compatible with both ringless and ring type meter sockets, 4–7 terminals
- Available in a wide array of colors, including but not limited too all ANSI powder coated paint colors upon request
- Pedestal mounting base option saves time and labor to install on a cement pad—no anchor bolts required
- Powder coated G90 galvanized steel, raw, anodized or powder coated aluminum and stainless steel exterior options

### "Slimline" Series Direct Bury Extension



- No need for concrete
- Bolts directly to unit
- Easy, modular design
- Ships in a smaller package
- Increases project flexibility
- Easier to handle and install
- Utilizes stabilizer feet to prevent leaning over time
- Pedestal and extension can be installed within 45 minutes

### Notes

- 14 gauge steel
- Only available for 12" pedestals

### Typical Applications



Roadway lighting and signage, wastewater treatment facilities, parks and landscaping, and any application where physical space is at a premium



Please consult serving utility for their requirements prior to ordering or installing, as specifications and approvals vary by utility, and may require local electrical inspector approval. All installations must be installed by a licensed electrician and must comply with all national and local codes, laws and regulations. Milbank reserves the right to make changes in specifications and features shown without notice or obligation.

# Commercial Pedestals

## Accessories

|  |   |  |   |
|--|---|--|---|
|   |            |    |  |
| <p><b>CP-ABK5/8</b><br/>Anchor bolt kit (includes four 5/8-13" x 18" anchor bolts)</p>   | <p><b>K3865</b><br/>Fifth terminal kit for use with ringless lever bypass meter sockets</p> | <p><b>CP-TC7D</b><br/>7-day time clock kit<br/><b>CP-TC24H</b><br/>24-hour time clock kit<br/><b>CP-TCWIRE</b><br/>Male 4-pin connector and wiring harness for use with time clocks other than shown</p> | <p><b>105J</b><br/>Fifth terminal kit for use with ring type meter sockets</p>      |
|   |          |    |   |
| <p><b>CP-16PDMNT-CALT</b><br/>Pedestal mounting base for 16" pedestal<br/><b>CP-24PDMNT-CALT</b><br/>Pedestal mounting base for 24" pedestal (includes mounting hardware)<br/><b>CP-32PDMNT</b><br/>Pedestal mounting base for 32" pedestal (includes mounting hardware)</p> | <p><b>CP-PE-HOA-3POS</b><br/>HOA (Hand-Off-Auto) switch for field installation</p>          | <p><b>CP-PE-TYP5-2POS</b><br/>Two position PE control kit</p>  |   |

Please consult serving utility for their requirements prior to ordering or installing, as specifications and approvals vary by utility, and may require local electrical inspector approval. All installations must be installed by a licensed electrician and must comply with all national and local codes, laws and regulations. Milbank reserves the right to make changes in specifications and features shown without notice or obligation.



# Commercial Pedestals

## 16" Metered & Unmetered Drawings

### "A" Style 16" Metered Commercial Pedestal

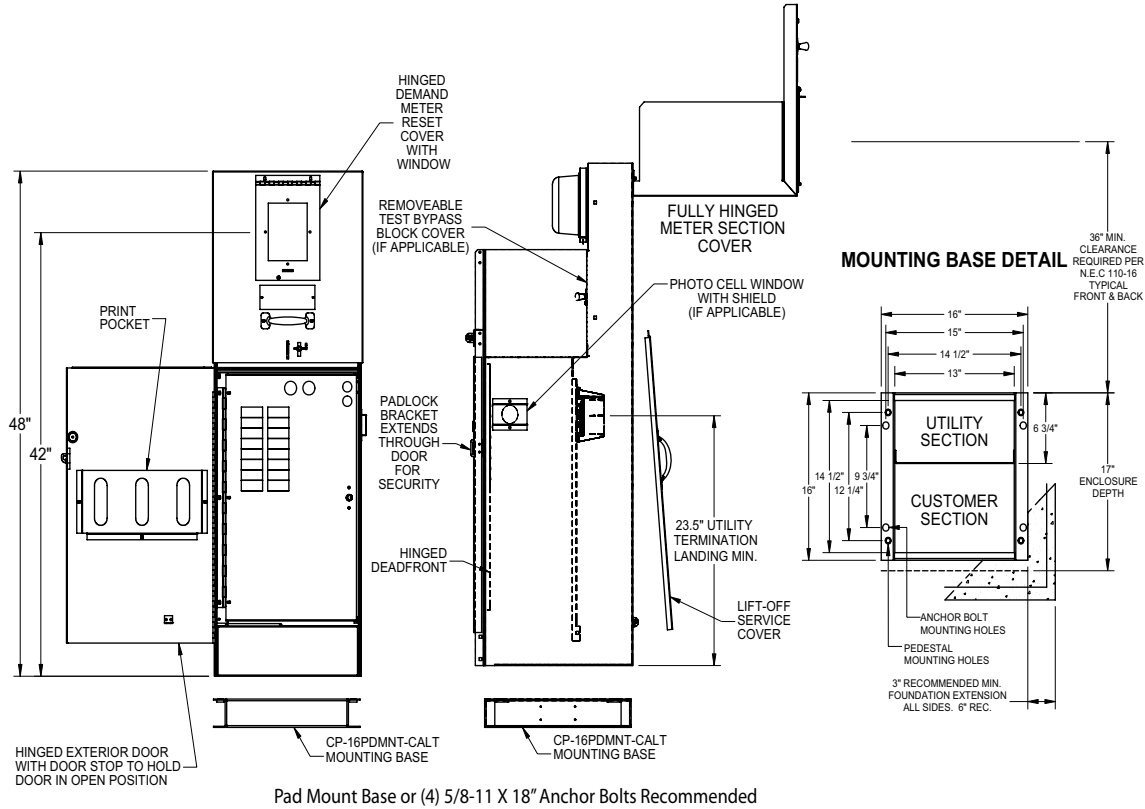

### "E" Style 16" Unmetered Commercial Pedestal | Low Profile

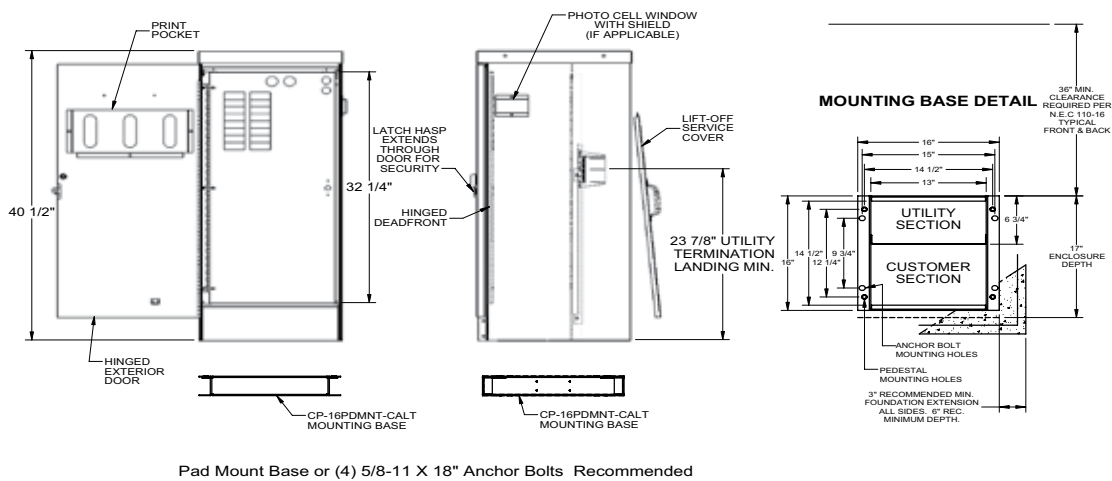

Please consult serving utility for their requirements prior to ordering or installing, as specifications and approvals vary by utility, and may require local electrical inspector approval. All installations must be installed by a licensed electrician and must comply with all national and local codes, laws and regulations. Milbank reserves the right to make changes in specifications and features shown without notice or obligation.



# Commercial Pedestals

## 24" Metered & Unmetered Drawings

### "B" Style 24" Metered Commercial Pedestal (with one or two meters)

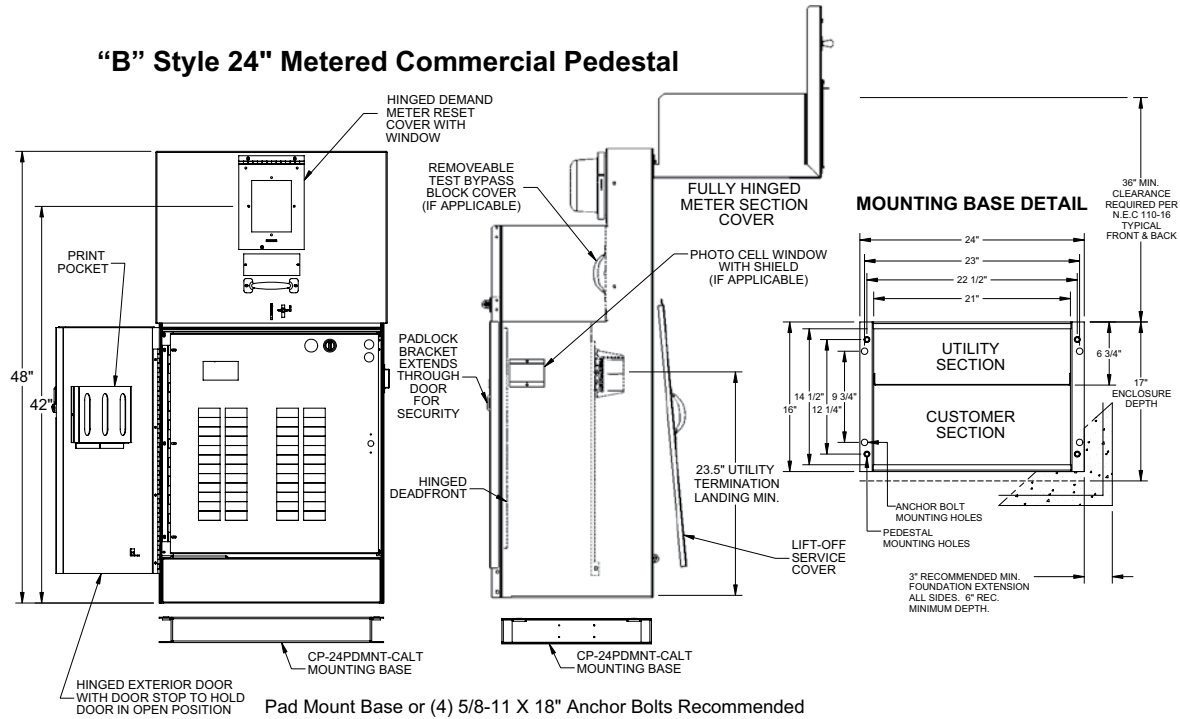

### "M" Style 24" Unmetered Commercial Pedestal

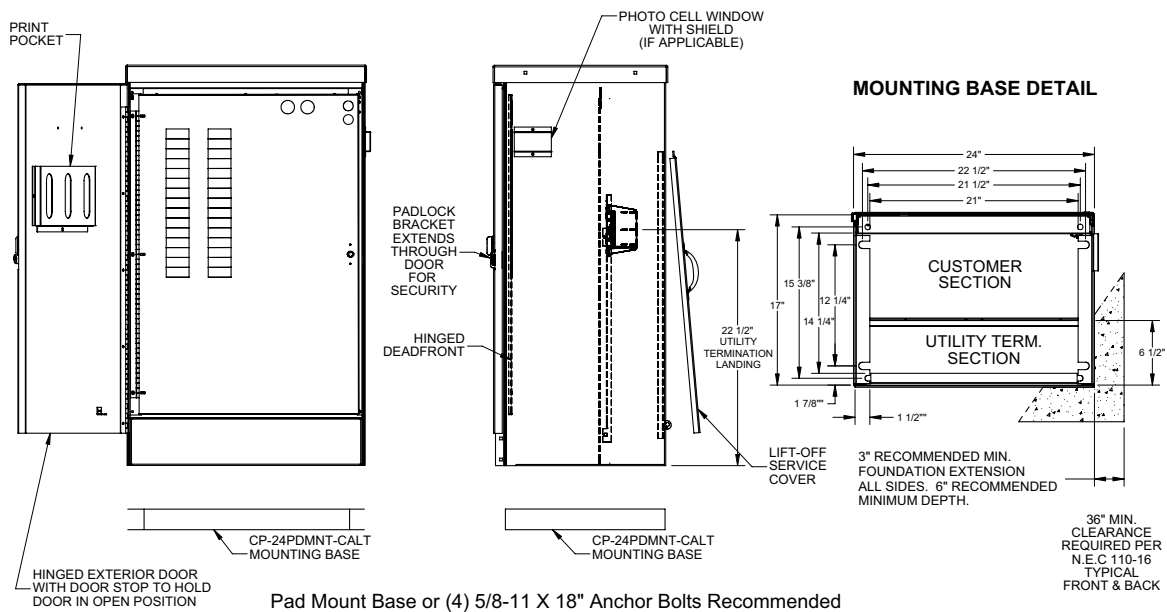

Please consult serving utility for their requirements prior to ordering or installing, as specifications and approvals vary by utility, and may require local electrical inspector approval. All installations must be installed by a licensed electrician and must comply with all national and local codes, laws and regulations. Milbank reserves the right to make changes in specifications and features shown without notice or obligation.



**"K" Style 32" Metered Commercial Pedestal (with one or two meters)**

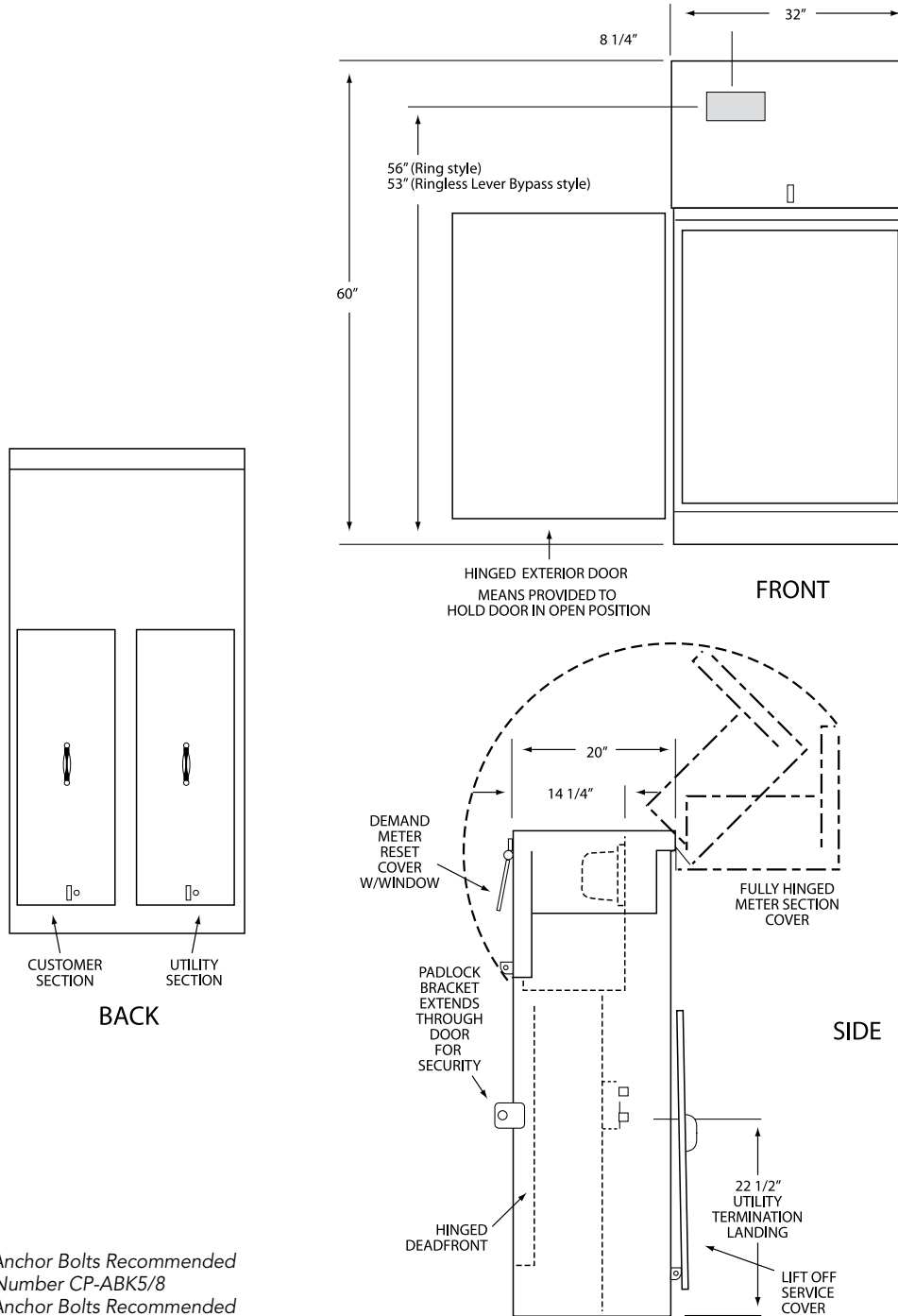

(4) 5/8-11 X 18" Anchor Bolts Recommended  
Catalog Number CP-ABK5/8  
(4) 5/8-11 X 18" Anchor Bolts Recommended



Please consult serving utility for their requirements prior to ordering or installing, as specifications and approvals vary by utility, and may require local electrical inspector approval. All installations must be installed by a licensed electrician and must comply with all national and local codes, laws and regulations. Milbank reserves the right to make changes in specifications and features shown without notice or obligation.

# Commercial Pedestals

## 32" Unmetered Drawings

**107**  
COMMERCIAL  
PEDESTALS

### "Q" Style 32" Unmetered Commercial Pedestal

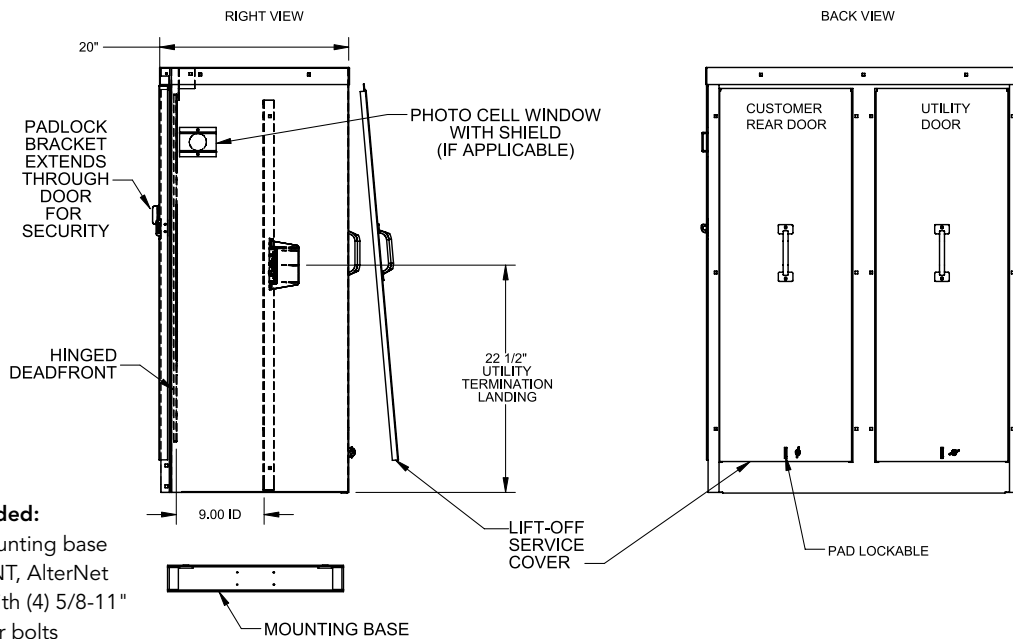
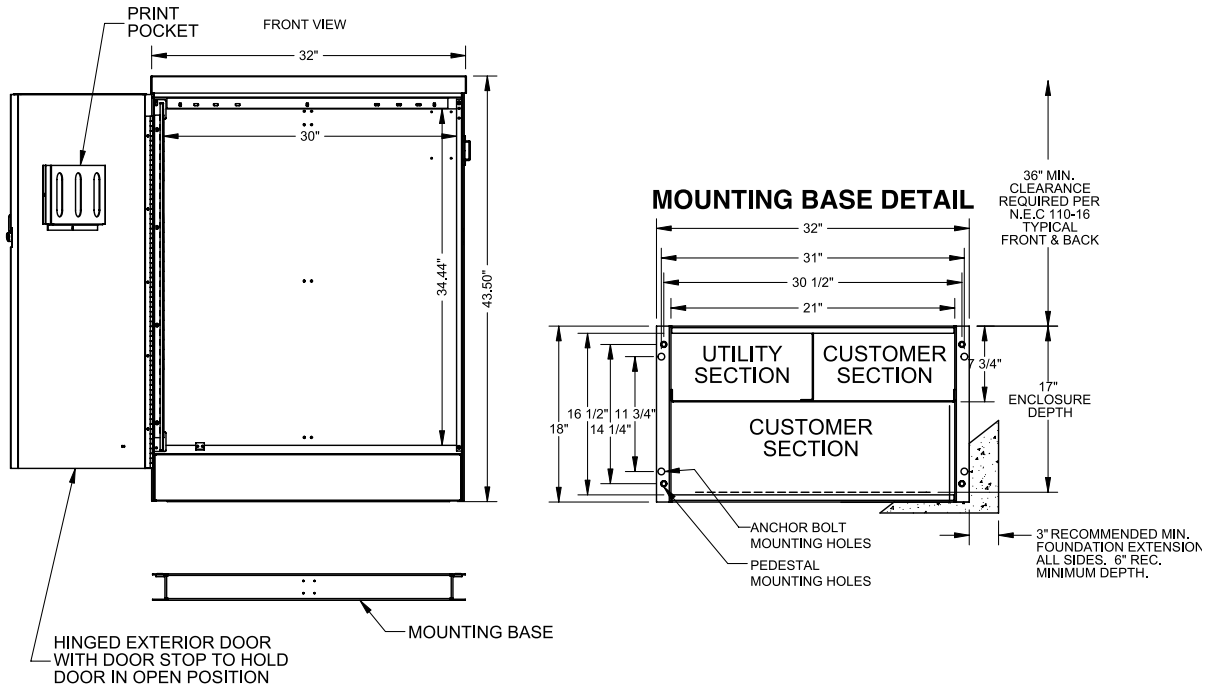

**Recommended:**  
Milbank mounting base CP-32PDMNT, AlterNet mounting with (4) 5/8-11" x 18" anchor bolts

Please consult serving utility for their requirements prior to ordering or installing, as specifications and approvals vary by utility, and may require local electrical inspector approval. All installations must be installed by a licensed electrician and must comply with all national and local codes, laws and regulations. Milbank reserves the right to make changes in specifications and features shown without notice or obligation.



### "D" Style Metered Commercial Pedestal

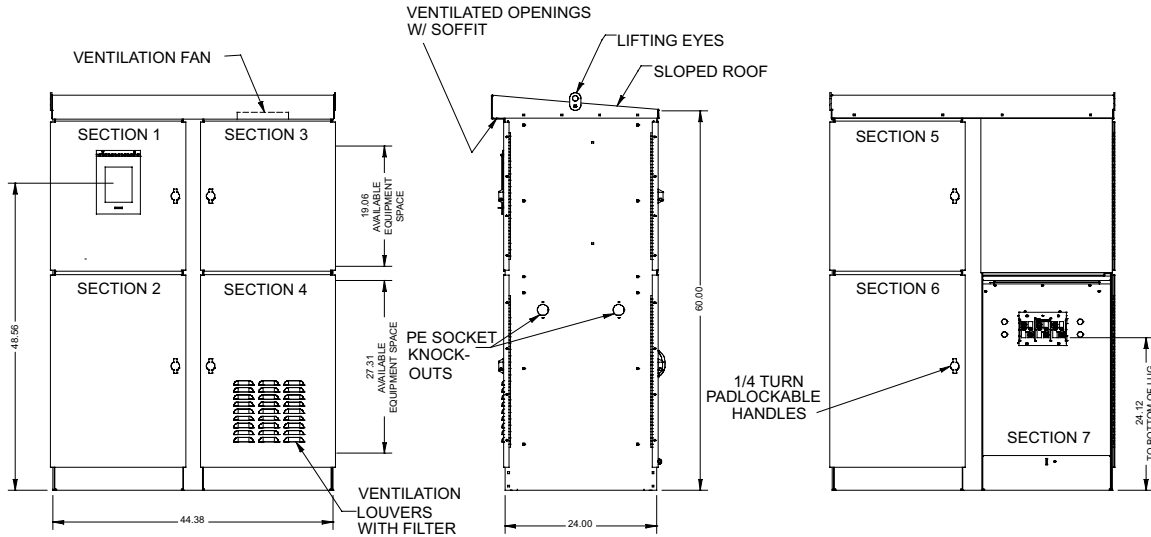

### "C" Style 54" Metered Commercial Pedestal

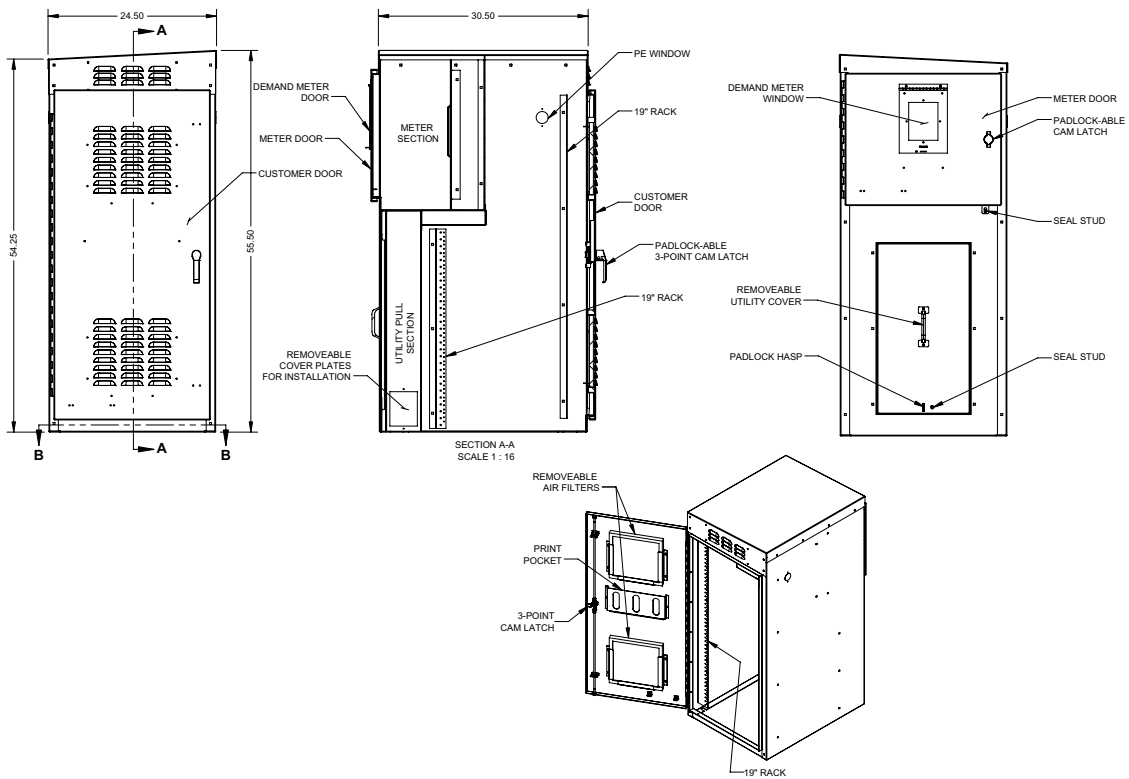

Please consult serving utility for their requirements prior to ordering or installing, as specifications and approvals vary by utility, and may require local electrical inspector approval. All installations must be installed by a licensed electrician and must comply with all national and local codes, laws and regulations. Milbank reserves the right to make changes in specifications and features shown without notice or obligation.

# Commercial Pedestals

## Slimline "A" Style Drawing

109  
COMMERCIAL  
PEDESTALS

### "A" Style Slimline Metered Commercial Pedestal

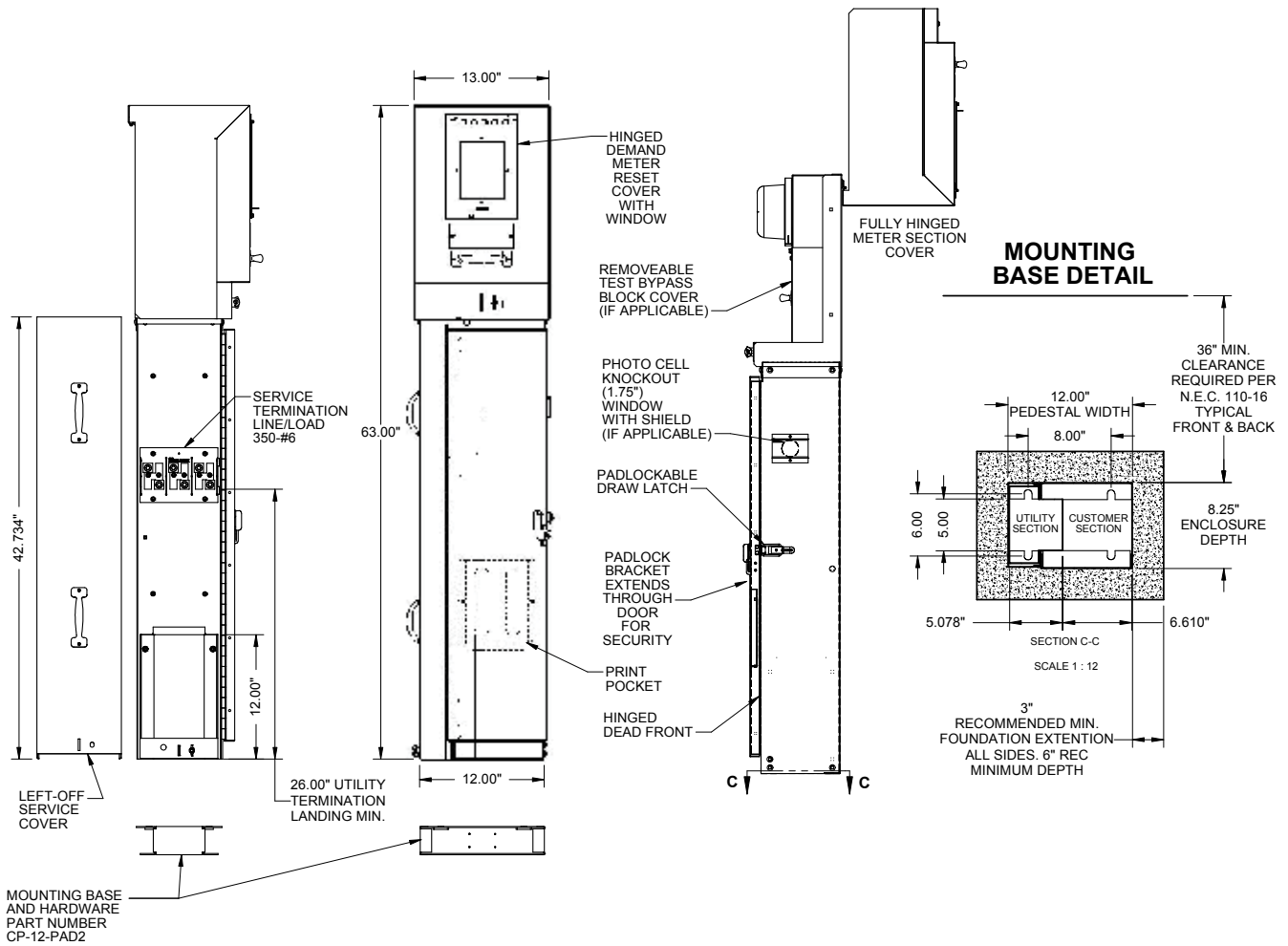

Please consult serving utility for their requirements prior to ordering or installing, as specifications and approvals vary by utility, and may require local electrical inspector approval. All installations must be installed by a licensed electrician and must comply with all national and local codes, laws and regulations. Milbank reserves the right to make changes in specifications and features shown without notice or obligation.



### "B" Style Slimline Metered Commercial Pedestal

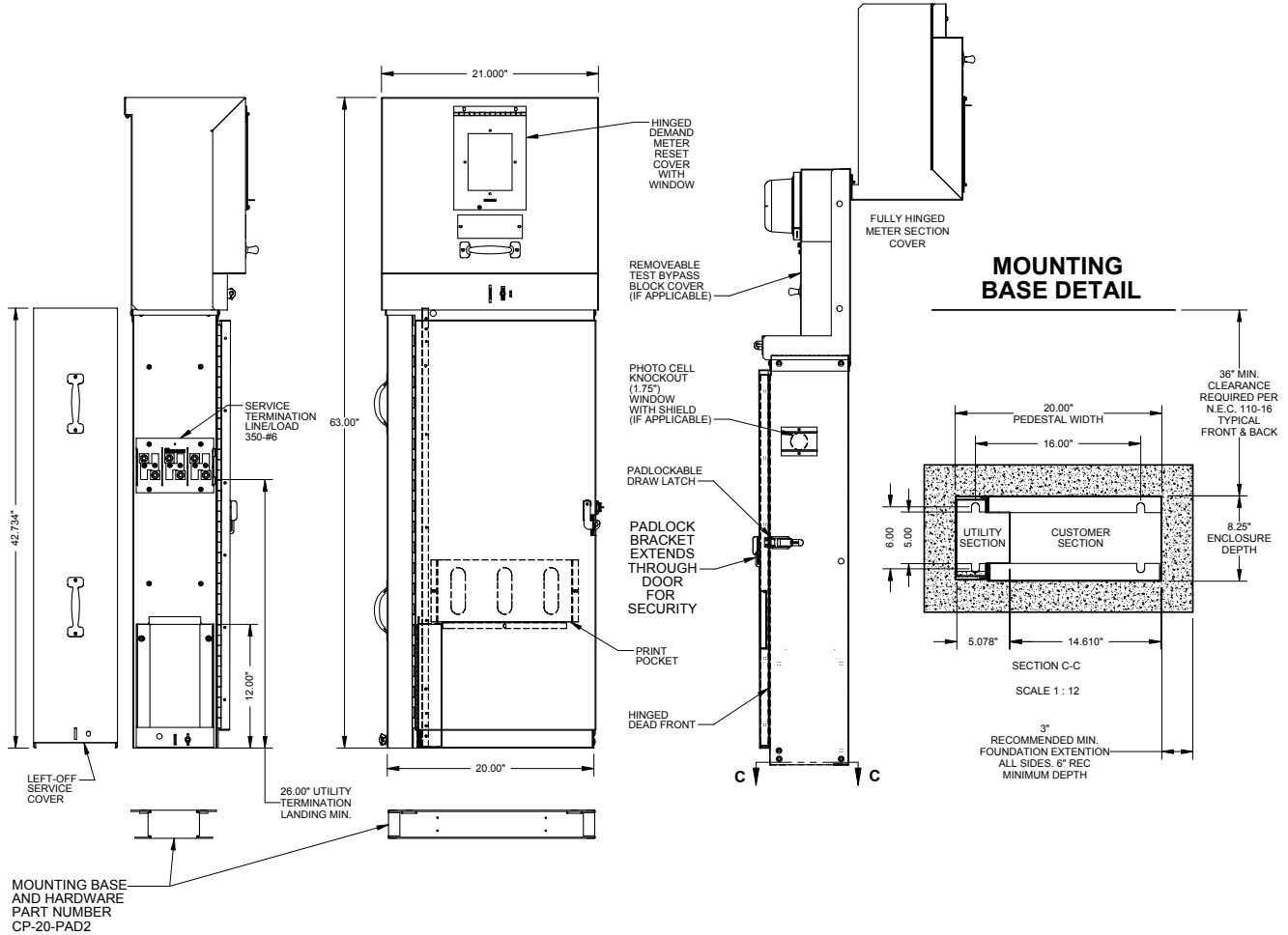

Please consult serving utility for their requirements prior to ordering or installing, as specifications and approvals vary by utility, and may require local electrical inspector approval. All installations must be installed by a licensed electrician and must comply with all national and local codes, laws and regulations. Milbank reserves the right to make changes in specifications and features shown without notice or obligation.

# Commercial Pedestals

## Slimline "I" Style Drawing

111  
COMMERCIAL  
PEDESTALS

### "I" Style Slimline Metered Commercial Pedestal

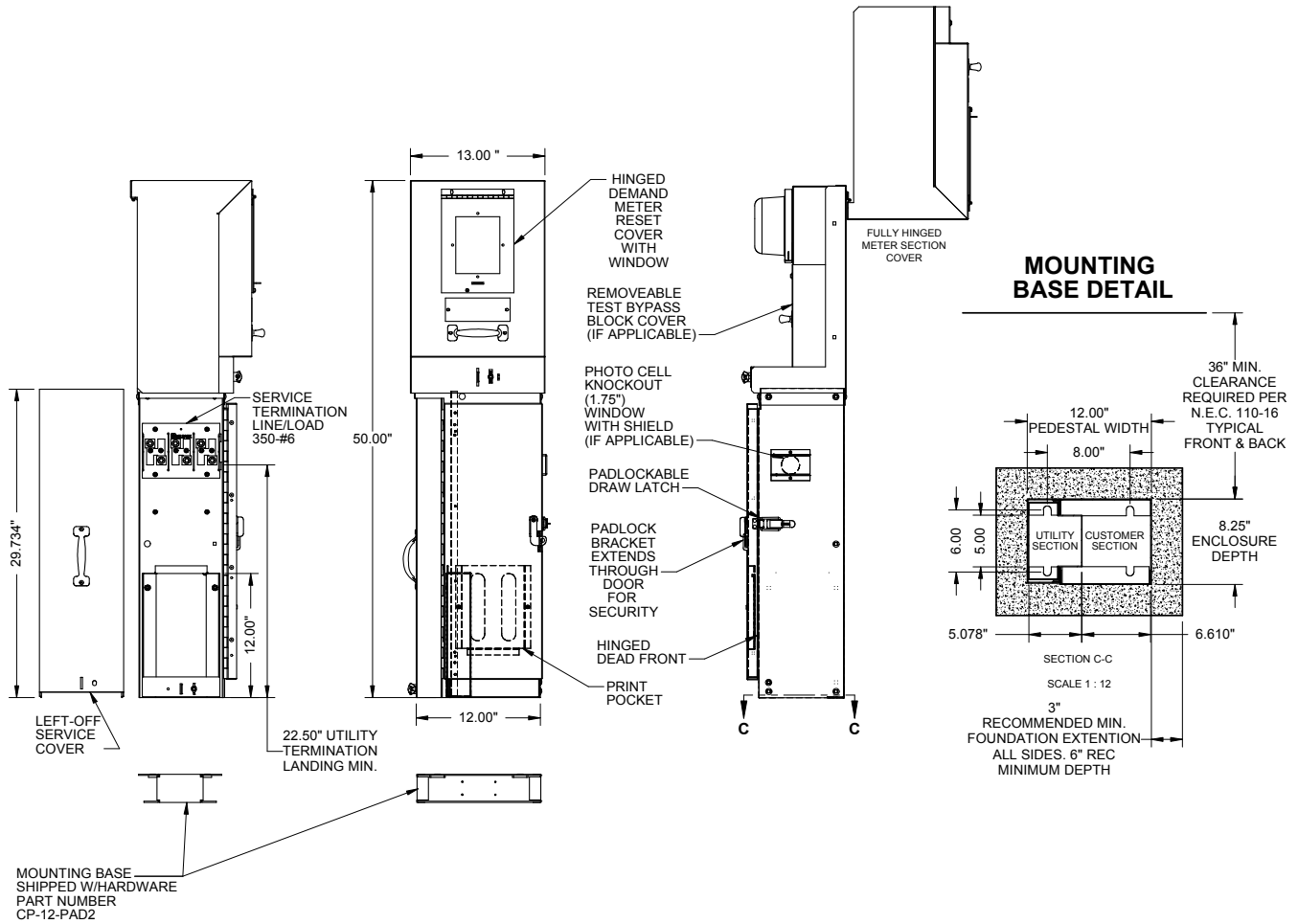

Please consult serving utility for their requirements prior to ordering or installing, as specifications and approvals vary by utility, and may require local electrical inspector approval. All installations must be installed by a licensed electrician and must comply with all national and local codes, laws and regulations. Milbank reserves the right to make changes in specifications and features shown without notice or obligation.



### "J" Style Slimline Metered Commercial Pedestal

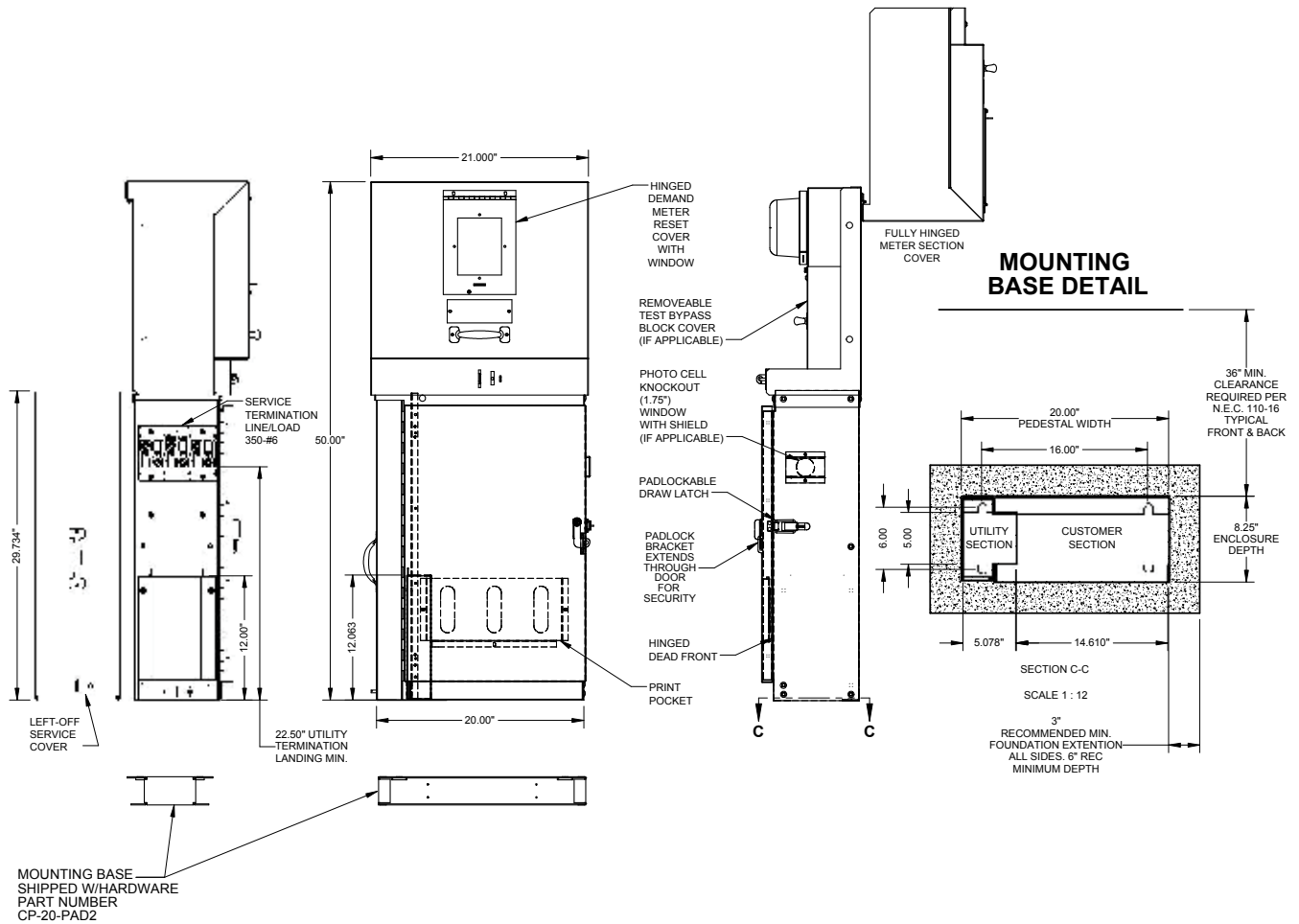

Please consult serving utility for their requirements prior to ordering or installing, as specifications and approvals vary by utility, and may require local electrical inspector approval. All installations must be installed by a licensed electrician and must comply with all national and local codes, laws and regulations. Milbank reserves the right to make changes in specifications and features shown without notice or obligation.



# Commercial Pedestals

## Product Worksheet

Please answer all of the questions listed below. Any additional information regarding application and/or future requirements will enable Milbank to configure the best product for your project.

Distributor: \_\_\_\_\_ Phone: \_\_\_\_\_ Fax: \_\_\_\_\_

Contact Name: \_\_\_\_\_ Application: \_\_\_\_\_

Milbank Representative: \_\_\_\_\_ Salesmen: \_\_\_\_\_

Project Name & Location: \_\_\_\_\_

Agency Specifications: (DOT-City-Other) \_\_\_\_\_

Unit amperage: \_\_\_\_\_ Voltage: \_\_\_\_\_ Phase: \_\_\_\_\_ Wire: \_\_\_\_\_

Meter socket (200 Amp) RING-TYPE RINGLESS Fifth Terminal? NO YES (at \_\_\_\_\_ o'clock)

Meter socket (200 Amp) RING-TYPE RINGLESS Fifth Terminal? NO YES (at \_\_\_\_\_ o'clock)

Main breaker requirements: Amp: \_\_\_\_\_ Poles: \_\_\_\_\_ KAIC: \_\_\_\_\_

Main breaker requirements: Amp: \_\_\_\_\_ Poles: \_\_\_\_\_ KAIC: \_\_\_\_\_

Interior #1 0-42 circuits \_\_\_\_\_ Load center \_\_\_\_\_ Panel board \_\_\_\_\_ Metered? YES NO

Interior #2 0-42 circuits \_\_\_\_\_ Load center \_\_\_\_\_ Panel board \_\_\_\_\_ Metered? YES NO

**Branch breakers:** Amp: \_\_\_\_\_ Poles: \_\_\_\_\_ KAIC: \_\_\_\_\_ Label & Special Requirements: \_\_\_\_\_

Qty \_\_\_\_\_ Breakers \_\_\_\_\_

Qty \_\_\_\_\_ Breakers \_\_\_\_\_

Qty \_\_\_\_\_ Breakers \_\_\_\_\_

Qty \_\_\_\_\_ Breakers \_\_\_\_\_

Qty \_\_\_\_\_ Breakers \_\_\_\_\_

Qty \_\_\_\_\_ Breakers \_\_\_\_\_

### Controls:

Qty \_\_\_\_\_ Time Clock: 24 Hr \_\_\_\_\_ 7 Day \_\_\_\_\_ 365 Day Astro \_\_\_\_\_ Description: \_\_\_\_\_

Qty \_\_\_\_\_ Photo Electric Control Receptacle

Qty \_\_\_\_\_ Test switch: 2 Pos. \_\_\_\_\_ 3 Pos. \_\_\_\_\_ HOA Type \_\_\_\_\_ Other \_\_\_\_\_

Qty \_\_\_\_\_ Control Transformer \_\_\_\_\_ Voltage \_\_\_\_\_ VA Size (required for all 277/480v)

### Contractors:

Type: Lighting - LT/Definite Purpose - DP/Mechanical Held - MH/Mercury - MV/IEC - IC

Qty \_\_\_\_\_ Type \_\_\_\_\_ Amp \_\_\_\_\_ Poles \_\_\_\_\_ Coil voltage \_\_\_\_\_ Other \_\_\_\_\_

Qty \_\_\_\_\_ Type \_\_\_\_\_ Amp \_\_\_\_\_ Poles \_\_\_\_\_ Coil voltage \_\_\_\_\_ Other \_\_\_\_\_

Qty \_\_\_\_\_ Type \_\_\_\_\_ Amp \_\_\_\_\_ Poles \_\_\_\_\_ Coil voltage \_\_\_\_\_ Other \_\_\_\_\_

**Cabinet/Finish requirements:** Alum - Untreated = AO/Alum Anodized = AL/Stainless Steel = SS

Aluminum - Painted = A / GALVANIZED STEEL PAINTED (standard) \_\_\_\_\_ (specify paint below):

MINT GREEN (standard) = G / PINE GREEN = PG / Dark Green = DG / Black = BK / Desert Tan = DT

White = W / Gray = P / Summerland Gray = SG / Other: (RAL finish number) \_\_\_\_\_

Other Requirements: \_\_\_\_\_

*Please send any drawings, plans, specifications, and load/panel board schedules with worksheet.*

Please consult serving utility for their requirements prior to ordering or installing, as specifications and approvals vary by utility, and may require local electrical inspector approval. All installations must be installed by a licensed electrician and must comply with all national and local codes, laws and regulations. Milbank reserves the right to make changes in specifications and features shown without notice or obligation.



## NEMA Commercial Enclosures

Milbank's line of commercial enclosures includes the full gamut of styles and sizes; everything from junction boxes to transformer cabinets, telephone cabinets to wireway.

### Type 1 Enclosures

Milbank's Type 1 enclosures are designed for indoor use to provide a degree of protection to personnel against access to hazardous parts and to provide a degree of protection of the equipment inside the enclosure against ingress of solid foreign objects, such as falling dirt.

### Type 3R Enclosures

Milbank's Type 3R enclosures are designed for either indoor or outdoor use to provide a degree of protection from harmful effects on the equipment due to the ingress of water (rain, sleet, snow) and that will be undamaged by the external formation of ice on the enclosure.

### Wireway

Milbank's wide range of wireway is available in many styles and sizes and its wide range of fittings allows it to smoothly transition to and from competitors' products.

## NEMA Industrial Enclosures

Milbank's line of industrial enclosures include junction boxes, wiring trough, push-button enclosures and modular enclosures. Milbank also excels in special designs; nearly any type, size or color of enclosure you need, we can make!

### Type 12 Enclosures

Enclosures constructed without knockouts for indoor use to provide a degree of protection to personnel against access to hazardous parts, and protect components against falling dirt, circulating dust and lint, and dripping or splashing water.

### Type 4 Enclosures

Enclosures constructed for either indoor or outdoor use to provide a degree of protection to personnel against access to hazardous parts; protect equipment against falling dirt and windblown dust; protect against rain, sleet, snow, splashing water, and hose directed water; and is resistant to damage by the external formation of ice on the enclosure.

### Industrial Enclosure Specials

Milbank specializes in custom enclosure projects, offering an almost limitless amount of styles, options, colors and sizes. Milbank will meet your needs and specifications and deliver a custom enclosure that protects your crucial electric equipment.

### Thermal Management

Protect components housed in enclosures from damage caused by overheating, freezing, humidity and condensation with these thermal management products.



Please consult serving utility for their requirements prior to ordering or installing, as specifications and approvals vary by utility, and may require local electrical inspector approval. All installations must be installed by a licensed electrician and must comply with all national and local codes, laws and regulations. Milbank reserves the right to make changes in specifications and features shown without notice or obligation.

# Accessories

## Hubs and Closing Plates

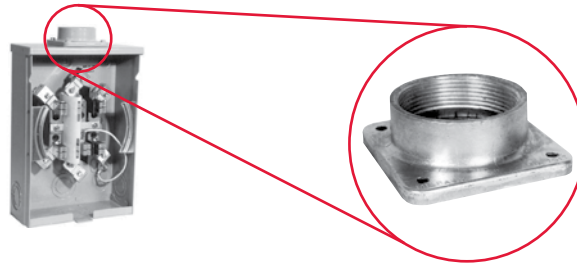
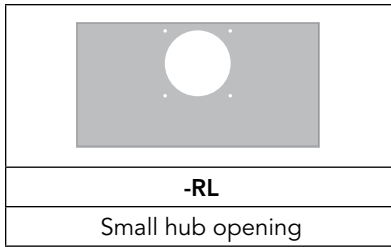

|                           |                           |                           |                           |                           |                           |
|---------------------------|---------------------------|---------------------------|---------------------------|---------------------------|---------------------------|
|                           |                           |                           |                           |                           |                           |
| <b>-WL</b>   <b>A7514</b> | <b>-YL</b>   <b>A7515</b> | <b>-ZL</b>   <b>A7516</b> | <b>-DL</b>   <b>A7517</b> | <b>-EL</b>   <b>A7518</b> | <b>-XL</b>   <b>A7551</b> |
| 1" hub                    | 1 1/4" hub                | 1 1/2" hub                | 2" hub                    | 2 1/2" hub                | Small closing plate       |

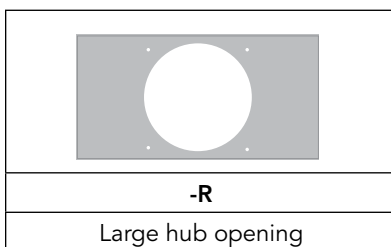

|                          |                          |                          |                          |  |
|--------------------------|--------------------------|--------------------------|--------------------------|--|
|                          |                          |                          |                          |  |
| <b>-F</b>   <b>A8110</b> | <b>-G</b>   <b>A8111</b> | <b>-H</b>   <b>A8112</b> | <b>-X</b>   <b>A9064</b> | <b>-RRL</b>   <b>S8324</b>                     |
| 3" hub                   | 3 1/2" hub               | 4" hub                   | Large closing plate      | Large hub opening adapted to small hub opening |

### Notes



- **Suffix:** Add to catalog number for factory installation of hub.
- **Packaging:** Individually packed units for field installation.
- **Abbreviations:** H.O. (hub opening), C.P. (closing plate).

Please consult serving utility for their requirements prior to ordering or installing, as specifications and approvals vary by utility, and may require local electrical inspector approval. All installations must be installed by a licensed electrician and must comply with all national and local codes, laws and regulations. Milbank reserves the right to make changes in specifications and features shown without notice or obligation.



## Connector Kits, Closing Kits & Generator Interlock

### Connector Kits — For Use with 3/8"-16 Stud Type Units Only

|  |        |                                     |  |        |                      |
|---|--------|-------------------------------------|---|--------|----------------------|
| Single  |        |                                     | Twin  |        |                      |
| Suffix  | Part # | (3 per set) - 1Ø                    | Suffix  | Part # | (3 per set) - 1Ø     |
| K1  | K1539  | 6-350                               | K2  | K1350  | 6-350                |
| K3  | K1540  | 4-600 or (2) 1/0-250                | K2L   | K1350L | 6-350 (non rotating) |
| K3L   | K1540L | 4-600 or (2) 1/0-250 (non rotating) | K4  | K1541  | 4-600                |
| Suffix  | Part # | (4 per set) - 3Ø                    | Suffix  | Part # | (4 per set) - 3Ø     |
| K5  | K3082  | 6-350                               | K6  | K3442  | 6-350                |
| K7  | K3441  | 4-600 or (2) 1/0-250                | K8  | K3083  | 4-600                |

### Bypass Link



**K8180**  
(sold in pairs, designed for temporary use only.)

### Closing Covers

|  |  |
|--|--|
|  |  |
| Meter Closing Plate (Ring Type/Ringless)   | Metal Closing Plate (For Ringless Sockets)   |
| 6003 - Gray Plastic  | CP-21  |
| 6116 - Clear Plastic   |  |

### Generator Interlock



K5815 - large QN with small frame Q

K5820 - large frame QN with large frame QN

K5830 - small frame Q to small frame Q

### Disconnect Sleeve



**M5-144**

**Do not use with lever bypass sockets**

### Anti-Inversion Clip



**K4802**

### Isolated Neutral Kit





**K1047**

# Accessories

## Fifth Terminal, Tap Connectors & Block Assemblies

### Fifth Terminal

|   |   |  |
|---|---|--|
|  |  |  |
| <b>5T8K2</b> - 100-200 Amp "Plug-In"  | <b>K5T</b> - 200 Amp (Block with Square Hole)                                     | <b>K3865</b> - Heavy Duty Jaw Clamping ( <b>K3866</b> without Neutral Wire)        |

### Tap Connectors (3 per set)

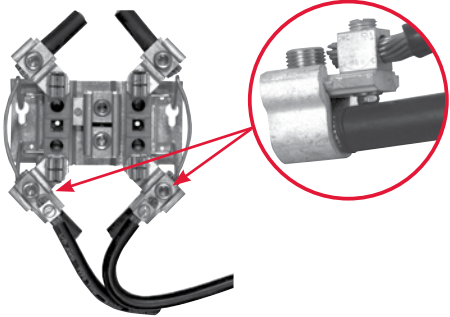
|  |  |
|--|--|
|  | Replaces the load or line side slide-in nut assembly on Milbank 200 amp sockets. Allows for a 100 amp tap location in addition to the #6-350 kcmil load-side connector. <b>K5022</b> includes safety barrier extensions for applications over 300 VAC. Three lugs per kit. |
| <b>K4977-INT</b> - Internal Hex  |  |
| <b>K4977-EXT</b> - External Hex  |  |
| <b>K5022-INT</b> - Internal Hex (set of 4 with barrier)                            |  |

### Triplex Ground

|  |
|--|
|       |
| <b>K1190</b><br>(For factory installed triplex ground, add suffix -TG to catalog number) |

### 100 Amp Blocks *(single sockets only)*

|   |
|---|
|  |
| <b>BL7474</b> - Block Assembly  |
| <b>BL7499</b> - Horn Bypass Block Assembly  |
| <b>Z904486-AO</b> - Nut Assembly  |
| <b>Z90327486-AO</b> - Horn Bypass Nut Assembly                                      |
| <b>Z802965-AC</b> - Neutral without Nut   |
| <b>Z901925-AC</b> - Hex Nut Set Screw   |

### 200 Amp Blocks *(single sockets only)*

|  |
|--|
|  |
| <b>K4527</b> - Internal Hex Block Assembly (with meter support)                      |
| <b>K4528</b> - External Hex Block Assembly (with meter support)                      |
| <b>K4529</b> - Internal Hex Horn Bypass Block Assembly (with meter support)          |
| <b>K4530</b> - External Hex Horn Bypass Block Assembly (with meter support)          |
| <b>Z916265-AO</b> - Internal Nut Assembly  |
| <b>Z916264-AO</b> - External Nut Assembly  |
| <b>Z814898-AC</b> - Neutral without Nut  |

Please consult serving utility for their requirements prior to ordering or installing, as specifications and approvals vary by utility, and may require local electrical inspector approval. All installations must be installed by a licensed electrician and must comply with all national and local codes, laws and regulations. Milbank reserves the right to make changes in specifications and features shown without notice or obligation.



## UQFP Plug-In Series Circuit Breakers



UQFP



UQFP-M

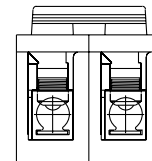
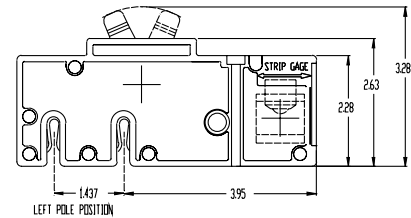
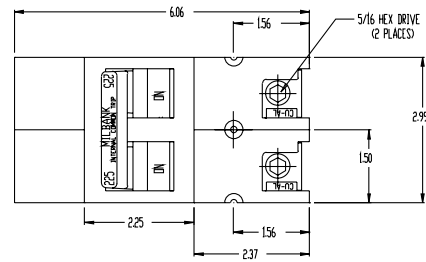

200 Amp Frame | Plug-In | 10K AIC & 22K AIC | Two-Pole | Common Trip

| Amp | 10K AIC Plug-In | 22K AIC Plug-In | 10K AIC Plug-In | 22K AIC Plug-In | Connectors CU/AL |         |
|-----|-----------------|-----------------|-----------------|-----------------|------------------|---------|
|     |                 |                 |                 |                 | Line             | Load    |
| 100 | UQFP-100        | UQFPH-100       | UQFP-M-100      | UQFPH-M-100     | #3-#1            | #1-1/0  |
| 125 | UQFP-125        | UQFPH-125       | UQFP-M-125      | UQFPH-M-125     | #3-#1            | #1-1/0  |
| 150 | UQFP-150        | UQFPH-150       | UQFP-M-150      | UQFPH-M-150     | 1/0-300          | 2/0-300 |
| 200 | UQFP-200        | UQFPH-200       | UQFP-M-200      | UQFPH-M-200     | 1/0-300          | 2/0-300 |

### Notes

- **UL listed:** For use with 60°C or 75°C wire.
- **UQFP:** For parallel main circuit breaker applications.
- **UQFP-M:** For series main circuit breaker applications. Split load tab features allow for feed through capability.
- **Standard Packaging:** 5 units per 16 lb. carton.



Please consult serving utility for their requirements prior to ordering or installing, as specifications and approvals vary by utility, and may require local electrical inspector approval. All installations must be installed by a licensed electrician and must comply with all national and local codes, laws and regulations. Milbank reserves the right to make changes in specifications and features shown without notice or obligation.

# Accessories

## UQFB Plug-In Series Circuit Breakers



UQFB-X1



UQFB-X



UQFB



UQFB-X-MOD

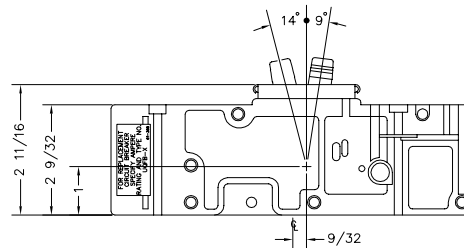
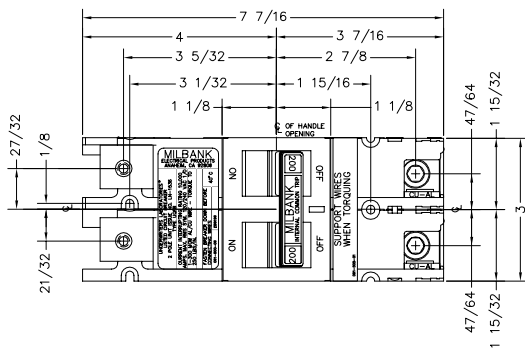

### 200 Amp Frame | Bolt-On | 10K AIC & 22K AIC | Two-Pole | Common Trip

| Amp | 10K AIC Bolt-On | 22K AIC Bolt-On | 10K AIC Bolt-On | Connectors CU/AL |         |
|-----|-----------------|-----------------|-----------------|------------------|---------|
|     |                 |                 |                 | Line             | Load    |
| 100 | UQFB-100        | UQFBH-100       | UQFB-100-X1     | #3-#1            | #1-1/0  |
| 125 | UQFB-125        | UQFBH-125       | UQFB-125-X1     | #3-#1            | #1-1/0  |
| 150 | UQFB-150        | UQFBH-150       | UQFB-150-X1     | 1/0-300          | 2/0-300 |
| 175 | UQFB-175        | UQFBH-175       | UQFB-175-X1     | 1/0-300          | 2/0-300 |
| 200 | UQFB-200        | UQFBH-200       | UQFB-200-X1     | 1/0-300          | 2/0-300 |

### Notes

- **UL listed:** For use with 60°C or 75°C wire.
- **UQFB:** (2) 1/0-300 kcmil lugs provided on load and line side (cable-in, cable-out).
- **UQFB3:** Three pole available. Consult factory.
- **UQFB-X:** (2) 1/0-300 kcmil lugs provided on load side and (2) line bar bus connections on line side.
- **UQFB-M:** For series main circuit breaker applications. Split load tab features allow for feed through capability.
- **UQFB-X-MOD:** Replacement circuit breaker with line barriers removed.
- **Standard Packaging:** 5 units per 16 lb. carton.

Please consult serving utility for their requirements prior to ordering or installing, as specifications and approvals vary by utility, and may require local electrical inspector approval. All installations must be installed by a licensed electrician and must comply with all national and local codes, laws and regulations. Milbank reserves the right to make changes in specifications and features shown without notice or obligation.



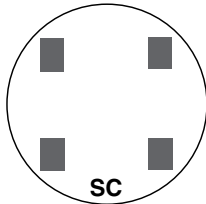

**SC**  
2 and 3-WIRE FORMS  
1S & 2S

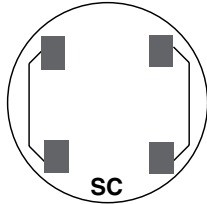

**SC**  
2 and 3-WIRE FORMS  
1S & 2S with BYPASS

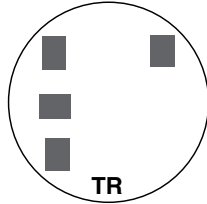

**TR**  
2-WIRE FORM 3S  
5th Term. 9 o'clock

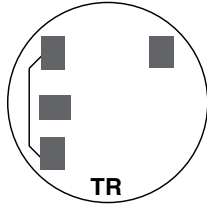

**TR**  
2-WIRE FORM 3S  
with BYPASS

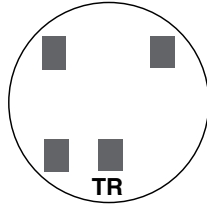

**TR**  
2-WIRE FORM 3S  
5th Term. 6 o'clock

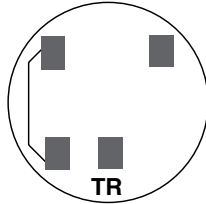

**TR**  
2-WIRE FORM 3S  
with BYPASS

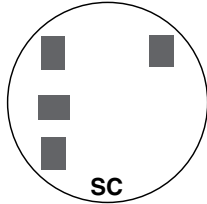

**SC**  
2 ELEMENT  
3-WIRE NETWORK  
FORM 12S 5th  
TERM. 9 o'clock

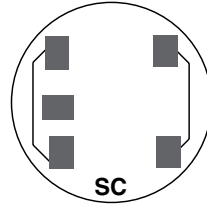

**SC**  
2 ELEMENT 3-WIRE  
NETWORK FORM 12S  
with BYPASS  
5th Term. 9 o'clock

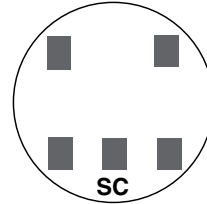

**SC**  
2 ELEMENT  
3-WIRE NETWORK  
FORM 12S 5th  
TERM. 6 o'clock

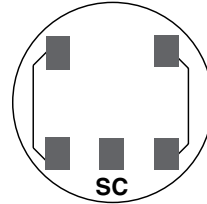

**SC**  
2 ELEMENT 3-WIRE  
NETWORK FORM 12S  
with BYPASS  
5th Term. 6 o'clock

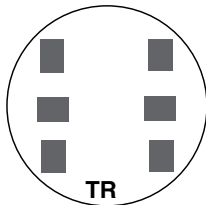

**TR**  
3-WIRE FORM 4S

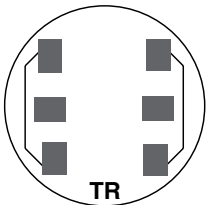

**TR**  
3-WIRE FORM 4S  
WITH BYPASS

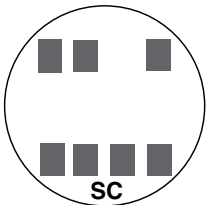

**SC**  
2 or 3 ELEMENT  
3Ø4W Y or  
Y FORM 14S  
FORM 15S  
Y FORM 16S

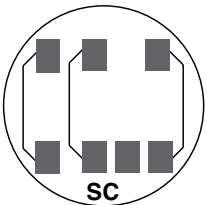

**SC**  
2 or 3 ELEMENT  
3Ø4W Y or  
FORMS 14S & 15S  
with BYPASS

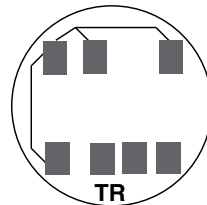

**TR**  
2 ELEMENT  
3Ø4W Y or  
Y FORM 7S  
FORM 24S  
with BYPASS

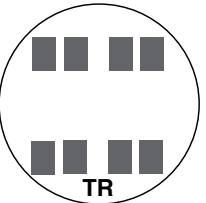

**TR**  
2 ELEMENT  
2Ø3W, 2Ø4W, 3Ø3W  
FORM 5S

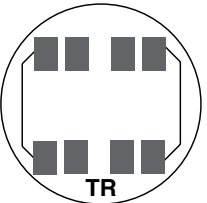

**TR**  
2 ELEMENT Ø3W,  
2Ø4W, 3Ø3W  
FORM 5S with  
BYPASS

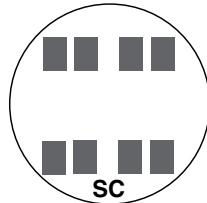

**SC**  
2 ELEMENT  
2Ø3W, 2Ø4W, 3Ø3W  
FORM 13S

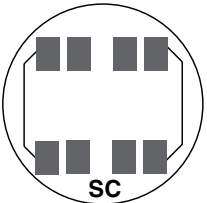

**SC**  
2 or 3 ELEMENT  
2Ø3W, 2Ø4W, 3Ø3W  
FORM 13S with  
BYPASS

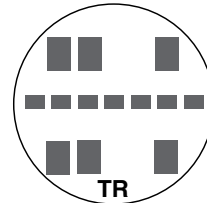

**TR**  
2 or 3 ELEMENT  
3Ø4W Y or  
Y FORM 9S  
FORM 8S

TR = TRANSFORMER RATED  
SC = SELF CONTAINED

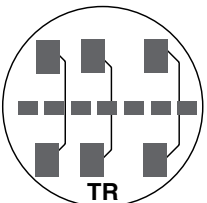

**TR**  
2 or 3 ELEMENT  
3Ø4W Y or  
FORMS 8S & 9S  
FORMS 8S & 9S  
with BYPASS

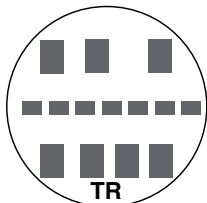

**TR**  
2 ELEMENT  
3Ø4W Y  
FORM 6S

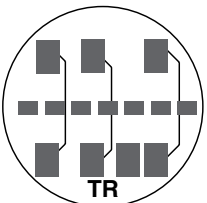

**TR**  
2 ELEMENT  
3Ø4W Y  
FORM 6S  
with BYPASS



Please consult serving utility for their requirements prior to ordering or installing, as specifications and approvals vary by utility, and may require local electrical inspector approval. All installations must be installed by a licensed electrician and must comply with all national and local codes, laws and regulations. Milbank reserves the right to make changes in specifications and features shown without notice or obligation.



# Meter Forms

## Reference Information

**DIAGRAM A**  
1Ø2W with 1 P.T. & 1 C.T.  
Single Stator Meter (2W1Ø) - Form 3S  
5T Socket, Test Switch #TS04-0101

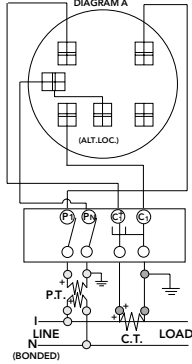

**DIAGRAM B**  
1Ø3W with 1 C.T.  
Single Stator Meter (2W1Ø) - Form 3S  
5T Socket, Test Switch #TS04-0101

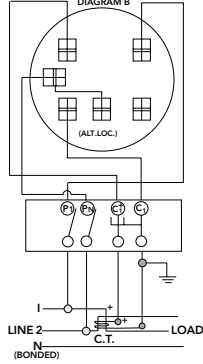

**DIAGRAM C**  
1Ø3W with 2 C.T.'s  
Single Stator Meter (3W1Ø) - Form 4S  
6T Socket, Test Switch #TS07-0105

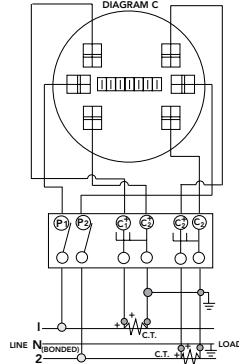

**DIAGRAM D**  
1Ø3W or 3W Network with 2 C.T.'s  
2 Stator Meter - Form 5S  
8T Socket, Test Switch #TS07-0105

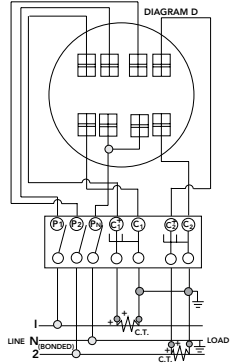

**DIAGRAM E**  
3Ø3W "A" with 2 P.T.'s & 2 C.T.'s  
2 Stator Meter - Form 5S  
8T Socket, Test Switch #TS07-0105

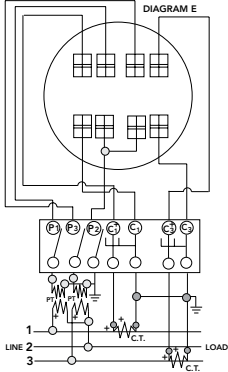

**DIAGRAM F**  
3Ø3W "A" with 2 C.T.'s  
2 Stator Meter - Form 5S  
8T Socket, Test Switch #TS07-0105

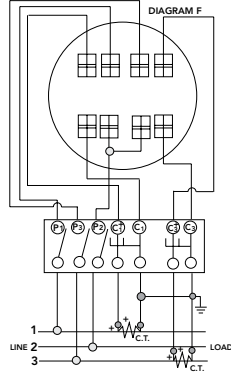

**DIAGRAM G**  
3Ø4W "Y" with 3 C.T.'s  
2 ½ Stator Meter - Form 6S  
13T Socket, Test Switch #TS10-0109

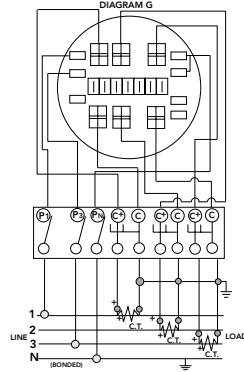

**DIAGRAM H**  
3Ø4W "Y" with 2 P.T.'s & 3 C.T.'s  
2 ½ Stator Meter - Form 6S  
13T Socket, Test Switch #TS10-0109

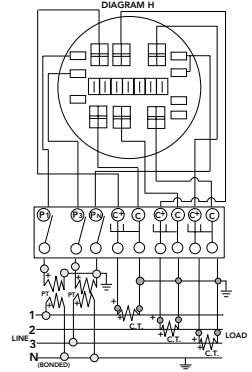

**DIAGRAM I**  
3Ø4W "Y" or "A" with 3 C.T.'s  
"Y" 3 Stator Meter - Form 9S  
"A" 2 Stator Meter - Form 8S  
13T Socket, Test Switch #TS10-0109

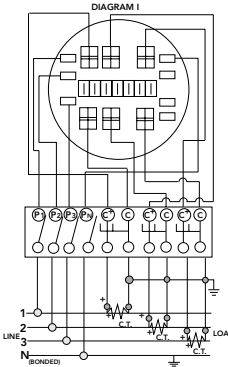

**DIAGRAM J**  
3Ø4W "Y" with 3 P.T.'s & 3 C.T.'s  
3 Stator Meter - Form 9S  
13T Socket, Test Switch #TS10-0109

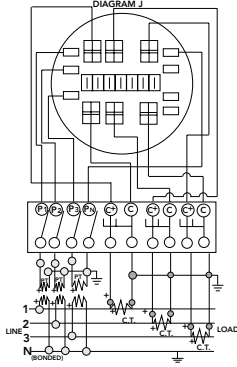

**Prewiring:** If standard factory prewiring is required, refer to wiring diagrams on this page. Determine appropriate diagram and send a copy with order. If custom factory prewiring is required, specify on order. Be sure to include meter socket catalog number, test switch make and catalog number, meter form number and provide a copy of your wiring diagram.

Please consult serving utility for their requirements prior to ordering or installing, as specifications and approvals vary by utility, and may require local electrical inspector approval. All installations must be installed by a licensed electrician and must comply with all national and local codes, laws and regulations. Milbank reserves the right to make changes in specifications and features shown without notice or obligation.



### Important Note

In addition to national and local electrical codes, many utilities have specific requirements for metering equipment. Always consult the serving utility for their specifications and requirements prior to ordering or installing Milbank meter mounting equipment.

### Before Energizing

1. Give equipment a thorough visual examination to determine that:
  - A. No shipping or installation damage exists.
  - B. Proper clearances have been maintained.
  - C. All connections have been made.
  - D. Equipment is clean and dry.
2. Make a thorough examination to:
  - A. Verify tightness of all bolted connections (see table below).
  - B. Manually operate all circuit breakers, switches, relays, etc.
  - C. Check rigidity of all mountings, bus bars and components.
  - D. Use test equipment to check continuity of circuitry and integrity of insulation.
3. All switches and circuit breakers should be in the "off" position.
4. Verify that manual meter bypass (if applicable) is in non-bypass position.
5. Install cover and/or close doors.
6. If installation is not being energized at this time, follow "after-energizing" steps listed below. These steps will secure the installation in case of accidental energization.

### When Energizing

Use caution and follow established safety procedures:

- 1) Wear safety apparel.
- 2) Use safety equipment.
- 3) Take action to prevent injury to yourself and others in the event of failure of the installation.
- 4) Take action to prevent/decrease damage to property in the event of failure of the installation.
- 5) If you are unsure how to safely energize the installation, get someone who is knowledgeable to do it.

### After Energizing

Secure the installation:

- 1) To prevent accidental contact with energized parts, cover all openings with approved filler devices.
- 2) To prevent unauthorized access, secure all covers and/or doors with approved security devices.
- 3) Attach/post information to advise others of potential hazards associated with the installation.

### Recommended Torque for General Applications\*

| Nominal Size | Joint Description |  | Head Type | Torque (Inch Lbs.) |
|--------------|-------------------|--|-----------|--------------------|
|              | Screw             | Nut  |           |                    |
| 10           | Brass             | Brass Nut or Extruded Hole                         | All       | 20-25 inch lbs.    |
| 10           | Steel             | Copper or Aluminum Busbar ≤ 1/8"                   | All       | 25-30 inch lbs.    |
| 10           | Steel             | Steel Nut or Extruded Hole; CU or AL Busbar > 1/8" | All       | 30-35 inch lbs.    |
| 12           | Steel             | Aluminum Extruded Hole                             | All       | 30-35 inch lbs.    |
| 12           | Steel             | Steel Nut or Extruded Hole                         | All       | 40-50 inch lbs.    |
| 1/4          | Steel             | Aluminum Extruded Hole                             | All       | 40-50 inch lbs.    |
| 1/4          | Steel             | Steel Nut or Extruded Hole; CU or AL Busbar        | All       | 50-60 inch lbs.    |
| 5/16         | Steel             | Aluminum Extruded Hole                             | Hex       | 60-70 inch lbs.    |
| 5/16         | Steel             | Steel Nut or Extruded Hole; CU or AL Busbar        | Hex       | 100-150 inch lbs.  |
| 3/8          | Steel             | Steel Nut  | Hex       | 150-200 inch lbs.  |
| 1/2          | Steel             | Steel Nut  | Hex       | 200-250 inch lbs.  |

\* Interior labels typically indicate the required torque for wire connectors and studs, and should be referenced first.  
**CU:** Copper  
**AL:** Aluminum



Please consult serving utility for their requirements prior to ordering or installing, as specifications and approvals vary by utility, and may require local electrical inspector approval. All installations must be installed by a licensed electrician and must comply with all national and local codes, laws and regulations. Milbank reserves the right to make changes in specifications and features shown without notice or obligation.

# Materials & Finishes

## Reference Information

## Materials

### Steel Quality

---

The meter equipment listed in this catalog is made of galvanized steel (AISI\* G90) to afford the best possible weather proofing.  
\*American Iron and Steel Institute.

### Steel Sheet

---

16 gauge, galvanized, sheet: 1 1/4 oz./ sq.ft. class zinc-coated. (AISI G90)  
14 gauge, galvanized, sheet: 1 1/4 oz./ sq.ft. class zinc-coated.

### Aluminum Extrusion

---

Wire-Terminal: Alloy; 6061-T6, Tin-plated for CU/AL wire.  
Bus Bar: Alloy; 6101-O & 6063-O

### Aluminum Sheet

---

3000 series aluminum sheet, H14, or 5052 series aluminum sheet, H32. Where applicable thicknesses range from .064-.125

### Copper Sheet & Bus

---

Electrolytic copper with tin plating in most applications.

### Insulating Materials

---

- In most units, support bases for current-carrying components are molded from fiberglass reinforced high-strength, track resistant, thermoset polyester molding compounds.
- Clear or black safety shields and polarity barriers are molded from high-strength, track resistant, polycarbonate molding compounds.
- Various sheet insulating materials, as appropriate for the application are utilized in the fabrication of flat, formed and punched component parts and barriers.

## Finish

### Process

---

Light gray state-of-the-art electrostatically applied powder paint offers a durable, non-fading finish. For further information concerning the chemical analysis of the weather resistant finish, please contact the factory.

### Metal Fasteners

---

Zinc-coated with a chromate dip.

## Ratings & Compliance

### Ratings & Compliance

---

All Milbank electrical enclosures in this catalog are rated "Type 3R Enclosure" unless specified otherwise on the product's page. All enclosures with a UL designation are constructed per the appropriate UL Standard and may be installed per the National Electric Code. UL procedure files associated with the UL Standards are listed as follows: Meter Sockets (UL 414, File E30202), Test Switches (UL 414, File E62531), Power Outlets (UL 231, File E90945), Panelboards (UL 67, File E32628) and Pullout Switches (UL 1429, File E133062). Additional standards are utilized as applicable: Meter Sockets (ANSI C12.7), Test Switches (ANSI C12.9) and Panelboards (NEMA PB-1).

Please consult serving utility for their requirements prior to ordering or installing, as specifications and approvals vary by utility, and may require local electrical inspector approval. All installations must be installed by a licensed electrician and must comply with all national and local codes, laws and regulations. Milbank reserves the right to make changes in specifications and features shown without notice or obligation.



|                      |     |                      |     |                        |     |
|----------------------|-----|----------------------|-----|------------------------|-----|
| 6003.....            | 116 | BC214.....           | 46  | K3082.....             | 116 |
| 6116.....            | 116 | BC234.....           | 46  | K3083.....             | 116 |
| 020-147-00-00-0..... | 65  | BC318.....           | 46  | K3441.....             | 116 |
| 105J.....            | 103 | BC338.....           | 46  | K3442.....             | 116 |
| 10URMD.....          | 92  | BC418.....           | 46  | K3865.....             | 103 |
| 10URMD24.....        | 92  | BC438.....           | 46  | K3865.....             | 117 |
| 114TB.....           | 31  | BC518.....           | 46  | K3866.....             | 117 |
| 115TB.....           | 31  | BC538.....           | 46  | K4527.....             | 117 |
| 117TB.....           | 31  | BC618.....           | 46  | K4528.....             | 117 |
| 124TB.....           | 31  | BC638.....           | 46  | K4529.....             | 117 |
| 125TB.....           | 31  | BL7474.....          | 117 | K4530.....             | 117 |
| 127TB.....           | 31  | BL7499.....          | 117 | K4709-02.....          | 85  |
| 16URMD.....          | 92  | CL200-D.....         | 87  | K4709-02-3R.....       | 85  |
| 16URMD24.....        | 92  | CP-16PDMNT-CALT..... | 103 | K4722.....             | 60  |
| 20URMD.....          | 92  | CP-21.....           | 116 | K4729.....             | 60  |
| 20URMD24.....        | 92  | CP-24PDMNT-CALT..... | 103 | K4793.....             | 60  |
| 214MTB.....          | 32  | CP-32PDMNT.....      | 103 | K4794.....             | 60  |
| 214MTB/22.....       | 33  | CP3B0181UMWIR02..... | 98  | K4795.....             | 60  |
| 214MTB-48.....       | 34  | CP3B0281UMWIR03..... | 98  | K4796.....             | 60  |
| 214MTB-P.....        | 35  | CP3B0281UMWIR04..... | 98  | K4797.....             | 60  |
| 214MTB-P48.....      | 35  | CP3B11110A22SL1..... | 96  | K4797.....             | 60  |
| 215MTB.....          | 32  | CP3B11115A22.....    | 95  | K4798.....             | 60  |
| 215MTB-48.....       | 34  | CP3B12110A22SL1..... | 96  | K4798.....             | 60  |
| 215MTB-P.....        | 35  | CP3B12119A22.....    | 95  | K4800-D.....           | 87  |
| 215MTB-P48.....      | 35  | CP3B1411jb.....      | 97  | K4802.....             | 116 |
| 217MTB.....          | 32  | CP3B14120b.....      | 97  | K4806-BP.....          | 59  |
| 217MTB/22.....       | 33  | CP3B51110A22SL1..... | 96  | K4903.....             | 60  |
| 217MTB-48.....       | 34  | CP3B51115A22.....    | 95  | K4904.....             | 60  |
| 217MTB-P.....        | 35  | CP3B52110A22SL1..... | 96  | K4977-EXT.....         | 117 |
| 217MTB-P48.....      | 35  | CP3B52119A22.....    | 95  | K4977-INT.....         | 117 |
| 224MTB.....          | 36  | CP3B5411Jb22.....    | 97  | K5022-INT.....         | 117 |
| 224MTB/22.....       | 37  | CP3B54120b22.....    | 97  | K5400-100MBM.....      | 88  |
| 224MTB-48.....       | 38  | CP3B-AUX-1200.....   | 90  | K5400-100MBU.....      | 88  |
| 224MTB-P.....        | 39  | CP-ABK5/8.....       | 103 | K5410.....             | 86  |
| 224MTB-P48.....      | 39  | CP-PE-HOA-3POS.....  | 103 | K5411.....             | 83  |
| 225MTB-P.....        | 39  | CP-PE-TYP5-2POS..... | 103 | K5412.....             | 84  |
| 225MTB-P48.....      | 39  | CP-TC24H.....        | 103 | K5413.....             | 83  |
| 227MTB.....          | 36  | CP-TC7D.....         | 103 | K5415.....             | 86  |
| 227MTB/22.....       | 37  | CP-TCWIRE.....       | 103 | K5421.....             | 86  |
| 227MTB-48.....       | 38  | CT203611-HC.....     | 61  | K5747.....             | 60  |
| 227MTB-P.....        | 39  | CT242411-SC.....     | 61  | K5752.....             | 60  |
| 227MTB-P48.....      | 39  | CT243011-HC.....     | 61  | K5815.....             | 116 |
| 243210-LC3R-SP.....  | 59  | CT243011-SC.....     | 61  | K5820.....             | 116 |
| 25URMD.....          | 92  | CT24329-SC.....      | 61  | K5830.....             | 116 |
| 25URMD24.....        | 92  | CT243611-HC.....     | 61  | K5920-10GR.....        | 82  |
| 323610-LC3R-SP.....  | 59  | CT243611-SC.....     | 61  | K5920-111GR.....       | 82  |
| 363016-CT3R.....     | 59  | CT244811-HC.....     | 61  | K5920-11GR.....        | 82  |
| 363612-CT3R-SP.....  | 59  | CT244811-SC.....     | 61  | K5920-38.....          | 82  |
| 364812-CT3R-SP2..... | 59  | CT303011-SC.....     | 61  | K5920-41.....          | 82  |
| 403456-SC.....       | 67  | CT303611-HC.....     | 61  | K5920-522.....         | 82  |
| 5T8K2.....           | 117 | CT303611-SC.....     | 61  | K5920-54.....          | 82  |
| 701776-MO.....       | 89  | CT303614-SC.....     | 61  | K5920-58.....          | 82  |
| 703997-MO.....       | 79  | CT304811-HC.....     | 61  | K5920-75.....          | 82  |
| 704995-MO.....       | 79  | CT363611-HC.....     | 61  | K5920-BLANK.....       | 82  |
| 706761-MO.....       | 79  | CT363611-SC.....     | 61  | K5T.....               | 117 |
| 707915-MO.....       | 79  | CT364211-SC.....     | 61  | K6212.....             | 83  |
| 708080-MO.....       | 89  | CT364811-HC.....     | 61  | K6213.....             | 84  |
| 708777-MO.....       | 79  | CT364811-SC.....     | 61  | K8180.....             | 116 |
| 708784-MO.....       | 88  | CT364814-SC.....     | 61  | M400-aps.....          | 27  |
| 708785-MO.....       | 79  | CT424211-SC.....     | 61  | M400-aps-BS.....       | 27  |
| A7514.....           | 115 | CT484811-HC.....     | 61  | M400-PAR-UG.....       | 26  |
| A7515.....           | 115 | CT484811-SC.....     | 61  | M400-UG-APS-F.....     | 28  |
| A7516.....           | 115 | CT484814-HC.....     | 61  | M400-UG-APS-F-BS.....  | 28  |
| A7517.....           | 115 | CT484814-SC.....     | 61  | M400-UG-APS-LC.....    | 28  |
| A7518.....           | 115 | K1047.....           | 116 | M400-UG-APS-LC-BS..... | 28  |
| A7551.....           | 115 | K1190.....           | 117 | M400-UG-APS-P.....     | 28  |
| A8110.....           | 115 | K1350.....           | 116 | M401-UG.....           | 29  |
| A8111.....           | 115 | K1350L.....          | 116 | M401-UG-BS.....        | 29  |
| A8112.....           | 115 | K1539.....           | 116 | M404-UG-LC.....        | 30  |
| A9064.....           | 115 | K1540.....           | 116 | M404-UG-LC-BS.....     | 30  |
| AP2300-03.....       | 10  | K1540L.....          | 116 | M5-144.....            | 116 |
| AP2300-04.....       | 10  | K1541.....           | 116 | MPAP-100-78.....       | 64  |



Please consult serving utility for their requirements prior to ordering or installing, as specifications and approvals vary by utility, and may require local electrical inspector approval. All installations must be installed by a licensed electrician and must comply with all national and local codes, laws and regulations. Milbank reserves the right to make changes in specifications and features shown without notice or obligation.

|                         |     |                     |    |                          |    |
|-------------------------|-----|---------------------|----|--------------------------|----|
| MPAP-100-MB-78.....     | 64  | U214MTB/22.....     | 33 | U3532-X-K1.....          | 49 |
| MPAP-200-20GR-78.....   | 64  | U214MTB-48.....     | 34 | U3533-X-K3.....          | 49 |
| MPAP-200-78.....        | 64  | U214MTBL.....       | 40 | U3534-X-K3.....          | 49 |
| MPAP-200-MB-78.....     | 64  | U214MTB-P.....      | 35 | U3548-X.....             | 21 |
| MPAP-200-MBLC-80.....   | 65  | U214MTB-P48.....    | 35 | U3555-R.....             | 62 |
| MPAP-BLANK-78.....      | 64  | U214MTBPL.....      | 40 | U3565-O.....             | 62 |
| MPAP-BLANK-78R.....     | 64  | U215MTB.....        | 32 | U3574-RL-200.....        | 24 |
| MPAPD-BLANK-78.....     | 64  | U215MTB-P.....      | 35 | U3577-RL-200.....        | 24 |
| MPAPD-BLANK-78R.....    | 64  | U215MTB-P48.....    | 35 | U3584-O-200.....         | 24 |
| MPRV-100-20GR-78.....   | 63  | U217MTB.....        | 32 | U3587-O-200.....         | 24 |
| MPRV-100-78.....        | 63  | U217MTB/22.....     | 33 | U3802.....               | 7  |
| MPRV-100-MB-78.....     | 63  | U217MTB-48.....     | 34 | U3812.....               | 7  |
| MPRV-100-MBLC-80.....   | 65  | U217MTBL.....       | 40 | U3822-20GWR.....         | 8  |
| MPRV-503020GR-78.....   | 63  | U217MTB-P.....      | 35 | U3832.....               | 7  |
| MPRV-50-78.....         | 63  | U217MTB-P48.....    | 35 | U3852-XL.....            | 17 |
| MPRV-BLANK-78.....      | 63  | U217MTBPL.....      | 40 | U3862.....               | 7  |
| MPRV-BLANK-78-R-5T..... | 63  | U224MTB.....        | 36 | U4013-X.....             | 22 |
| MR-2.....               | 89  | U224MTB/22.....     | 37 | U4015-O.....             | 14 |
| MS-24-TB.....           | 44  | U224MTB-48.....     | 38 | U4031-O-2/200.....       | 26 |
| MS-25-TB.....           | 44  | U224MTBL.....       | 40 | U4175-RL-BLG.....        | 11 |
| MS-27-TB.....           | 44  | U224MTB-P.....      | 39 | U4517-DL-M4.....         | 14 |
| PB-011.....             | 45  | U224MTB-P48.....    | 39 | U4518-O-W.....           | 14 |
| PB-012.....             | 45  | U224MTBPL.....      | 40 | U4518-XL-W.....          | 14 |
| PB-014.....             | 45  | U227MTB.....        | 36 | U4540-XL.....            | 91 |
| PB-014-NK.....          | 45  | U227MTB/22.....     | 37 | U4542-XL.....            | 91 |
| PB-018.....             | 45  | U227MTB-48.....     | 38 | U4544-XL.....            | 91 |
| PB-018-NK.....          | 45  | U227MTBL.....       | 40 | U4546-XL.....            | 91 |
| PB-032.....             | 45  | U227MTB-P.....      | 39 | U4548-RXL.....           | 91 |
| PB-034.....             | 45  | U227MTB-P48.....    | 39 | U4549-RXL.....           | 91 |
| PB-034-NK.....          | 45  | U227MTBPL.....      | 40 | U4881-O.....             | 9  |
| PB-038.....             | 45  | U2594-X.....        | 22 | U4881-O-50GB.....        | 9  |
| PF-BL.....              | 67  | U2827-X.....        | 22 | U4881-O-60GB.....        | 9  |
| PF-KR.....              | 67  | U2852-X.....        | 50 | U4909-O-11GR.....        | 75 |
| PT223.....              | 44  | U2853-X.....        | 50 | U5000-XL.....            | 80 |
| PT224.....              | 44  | U2854-X.....        | 50 | U5000-XL-41.....         | 80 |
| PT263.....              | 44  | U2855-X.....        | 50 | U5000-XL-55.....         | 80 |
| PT264.....              | 44  | U2856-X.....        | 50 | U5000-XL-75.....         | 80 |
| PT323.....              | 44  | U2862-X.....        | 50 | U5001-RL-01.....         | 77 |
| PT324.....              | 44  | U2863-X.....        | 50 | U5056-O.....             | 21 |
| PT363.....              | 44  | U2864-X.....        | 50 | U5059-x-2/200.....       | 26 |
| PT364.....              | 44  | U2865-X.....        | 50 | U5100-XL.....            | 80 |
| Q115.....               | 79  | U2866-X.....        | 50 | U5100-XL-41.....         | 80 |
| Q120.....               | 79  | U3251-O-200-CB..... | 28 | U5100-XL-55.....         | 80 |
| Q130.....               | 79  | U3319-R.....        | 62 | U5100-XL-75.....         | 80 |
| Q2100.....              | 79  | U3320-R.....        | 62 | U5136-O.....             | 72 |
| Q220.....               | 79  | U3321-R.....        | 62 | U5136-O-100S.....        | 72 |
| Q250.....               | 79  | U3322-R.....        | 62 | U5136-O-200S.....        | 72 |
| RBK-1.....              | 65  | U3323-R.....        | 62 | U5137-O.....             | 72 |
| S8324.....              | 115 | U3328-RXL.....      | 14 | U5137-O-100S.....        | 72 |
| TB100-47.....           | 44  | U3339-O.....        | 62 | U5137-O-200S.....        | 72 |
| TB100-5.....            | 44  | U3340-O.....        | 62 | U5138-O.....             | 72 |
| TB200-47.....           | 44  | U3341-O.....        | 62 | U5138-O-200S.....        | 72 |
| TB200-5.....            | 44  | U3342-O.....        | 62 | U5139-O.....             | 72 |
| TB200-LL.....           | 44  | U3343-O.....        | 62 | U5168-XTL-100.....       | 25 |
| U1060-RL.....           | 13  | U3412-O.....        | 47 | U5168-XTL-100-KK.....    | 25 |
| U1079-R.....            | 20  | U3413-O.....        | 47 | U5168-XTL-100-KK-5T..... | 25 |
| U1129-O-K3L-K2L.....    | 20  | U3414-O.....        | 47 | U5168-XTL-150.....       | 25 |
| U1211-RXL.....          | 17  | U3415-O.....        | 47 | U5168-XTL-150-KK.....    | 25 |
| U1252-X-K1.....         | 49  | U3416-O.....        | 47 | U5168-XTL-150-KK-5T..... | 25 |
| U1253-X-K3.....         | 49  | U3462-O.....        | 47 | U5168-XTL-200.....       | 25 |
| U1254-X-K3.....         | 49  | U3463-O.....        | 47 | U5168-XTL-200-KK.....    | 25 |
| U1255-X-K4.....         | 49  | U3464-O.....        | 47 | U5169-XTL-100.....       | 25 |
| U1256-X-K4.....         | 49  | U3465-O.....        | 47 | U5169-XTL-150.....       | 25 |
| U1431-R.....            | 20  | U3466-O.....        | 47 | U5169-XTL-200.....       | 25 |
| U1432-O.....            | 20  | U3504-XL.....       | 16 | U5200-XL.....            | 81 |
| U1527-O.....            | 13  | U3507-XL.....       | 16 | U5200-XL-41.....         | 81 |
| U1681-RL.....           | 12  | U3514-XL.....       | 16 | U5200-XL-55.....         | 81 |
| U1797-O-K3L-K2L.....    | 20  | U3517-XL.....       | 16 | U5200-XL-75.....         | 81 |
| U1819-X.....            | 20  | U3522-XL-K1.....    | 48 | U5240-O.....             | 70 |
| U1980-O.....            | 13  | U3523-XL-K1.....    | 48 | U5240-O-100S.....        | 70 |
| U2120-X.....            | 22  | U3524-XL-K2.....    | 48 | U5240-O-200S.....        | 70 |
| U214MTB.....            | 32  | U3525-XL-K2.....    | 48 | U5241-O.....             | 70 |

Please consult serving utility for their requirements prior to ordering or installing, as specifications and approvals vary by utility, and may require local electrical inspector approval. All installations must be installed by a licensed electrician and must comply with all national and local codes, laws and regulations. Milbank reserves the right to make changes in specifications and features shown without notice or obligation.



|                       |    |                        |     |
|-----------------------|----|------------------------|-----|
| U5241-O-100S.....     | 70 | UC3426-XL.....         | 55  |
| U5241-O-200S.....     | 70 | UC3428-XL.....         | 55  |
| U5242-O.....          | 70 | UC3433-XL.....         | 55  |
| U5242-O-200S.....     | 70 | UC3434-XL.....         | 55  |
| U5243-O.....          | 70 | UC3435-XL.....         | 55  |
| U5268-XTL-150.....    | 25 | UC3436-XL.....         | 55  |
| U5268-XTL-150-KK..... | 25 | UC3438-XL.....         | 55  |
| U5268-XTL-200.....    | 25 | UC7233-XL.....         | 54  |
| U5268-XTL-200-KK..... | 25 | UC7235-XL.....         | 54  |
| U5269-XTL-200.....    | 25 | UC7237-XL.....         | 54  |
| U5300-O.....          | 81 | UC7461-YL-TGE-DES..... | 55  |
| U5300-O-41.....       | 81 | UC7544-RL.....         | 54  |
| U5300-O-55.....       | 81 | UC7545-RL.....         | 54  |
| U5300-O-75.....       | 81 | UC7582-RL.....         | 54  |
| U5706-O-200S.....     | 74 | UC7636-YL-TGE-DES..... | 55  |
| U5706-O-200S-KK.....  | 74 | UF4015-KO.....         | 15  |
| U5707-O-200S.....     | 74 | UF4517-KO.....         | 15  |
| U5759-x-2/200.....    | 26 | UF4518-KO.....         | 15  |
| U5865-XL-38GBGRW..... | 78 | UF4969-KO.....         | 15  |
| U5882-X.....          | 52 | UQFB-100.....          | 119 |
| U5883-X.....          | 52 | UQFB-100-X1.....       | 119 |
| U5884-X.....          | 52 | UQFB-125.....          | 119 |
| U5885-X.....          | 52 | UQFB-125-X1.....       | 119 |
| U5886-X.....          | 52 | UQFB-150.....          | 119 |
| U5902-X.....          | 52 | UQFB-150-X1.....       | 119 |
| U5903-X.....          | 52 | UQFB-175.....          | 119 |
| U5904-X.....          | 52 | UQFB-175-X1.....       | 119 |
| U5905-X.....          | 52 | UQFB-200.....          | 119 |
| U5906-X.....          | 52 | UQFB-200-X1.....       | 119 |
| U5929-XL-INS.....     | 11 | UQFBH-100.....         | 119 |
| U5934-XL-BLG.....     | 11 | UQFBH-125.....         | 119 |
| U5971-XL-100.....     | 23 | UQFBH-150.....         | 119 |
| U5971-XL-200.....     | 23 | UQFBH-175.....         | 119 |
| U6087-XL.....         | 11 | UQFBH-200.....         | 119 |
| U6087-XL-INS.....     | 11 | UQFP-100.....          | 118 |
| U6276-O-100.....      | 68 | UQFP-125.....          | 118 |
| U6276-O-100MB.....    | 68 | UQFP-150.....          | 118 |
| U6276-O-10GR.....     | 68 | UQFP-200.....          | 118 |
| U6276-O-41.....       | 68 | UQFPH-100.....         | 118 |
| U6276-O-54.....       | 68 | UQFPH-125.....         | 118 |
| U6276-O-55.....       | 68 | UQFPH-150.....         | 118 |
| U6276-O-75.....       | 68 | UQFPH-200.....         | 118 |
| U7021-RL-TG.....      | 13 | UQFPH-M-100.....       | 118 |
| U7040-XL-TG.....      | 13 | UQFPH-M-125.....       | 118 |
| U7043-XL-TG.....      | 13 | UQFPH-M-150.....       | 118 |
| U7422-RXL.....        | 18 | UQFPH-M-200.....       | 118 |
| U7423-RXL.....        | 18 | UQFP-M-100.....        | 118 |
| U7487-O.....          | 12 | UQFP-M-125.....        | 118 |
| U7487-RL.....         | 12 | UQFP-M-150.....        | 118 |
| U7490-O.....          | 12 | UQFP-M-200.....        | 118 |
| U7490-RL.....         | 12 | USE-AP-200-MB.....     | 23  |
| U7573-RL.....         | 18 | USE-AP-200-ML.....     | 23  |
| U8032-XL.....         | 48 | Z020-148-00-00-0.....  | 65  |
| U8033-XL.....         | 48 | Z020-148-00-00-0.....  | 79  |
| U8034-XL.....         | 48 | Z1050596.....          | 65  |
| U8035-XL.....         | 48 | Z1050596.....          | 79  |
| U8036-XL.....         | 48 | Z700911-MO.....        | 79  |
| U8100-RL.....         | 18 | Z708767-MO.....        | 89  |
| U9319-XL.....         | 17 | Z802965-AC.....        | 117 |
| U9320-RXL.....        | 18 | Z814898-AC.....        | 117 |
| U9550-RRL.....        | 19 | Z818052-SC.....        | 89  |
| U9551-RXL.....        | 19 | Z818480-SC.....        | 89  |
| U9700-RRL.....        | 19 | Z901925-AC.....        | 117 |
| U9701-RXL.....        | 19 | Z90327486-AO.....      | 117 |
| U9800-RRL.....        | 19 | Z904486-AO.....        | 117 |
| U9801-RXL.....        | 19 | Z915141-AC.....        | 88  |
| UC1290-XL.....        | 54 | Z916264-AO.....        | 117 |
| UC1291-RL.....        | 54 | Z916265-AO.....        | 117 |
| UC1299-XL.....        | 54 | Z917602-AC.....        | 88  |
| UC1300-RL.....        | 54 | Z918447-AC.....        | 89  |
| UC3423-XL.....        | 55 | Z918449-AC.....        | 89  |
| UC3425-XL.....        | 55 | Z918466-AC.....        | 88  |



Please consult serving utility for their requirements prior to ordering or installing, as specifications and approvals vary by utility, and may require local electrical inspector approval. All installations must be installed by a licensed electrician and must comply with all national and local codes, laws and regulations. Milbank reserves the right to make changes in specifications and features shown without notice or obligation.



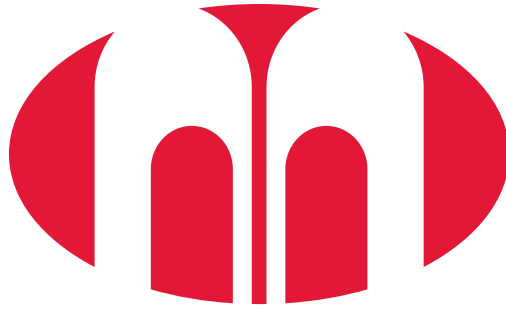

# MILBANK<sup>®</sup>

ENERGY AT WORK

