

Now there's something
better than prefab

Steel City | **eFab**
by Thomas & Betts



Thomas & Betts
A Member of the ABB Group

Introducing eFab

From online to on-site, eFab by Thomas & Betts reduces labor, inventory, and shipping costs.

eFab is the powerful, comprehensive rough-in solution that allows you to design and order Steel City® prefab assemblies online and have them delivered directly to the job site for fast installation. Choose from popular preconfigured combinations, or use our exclusive 3D eFab Configurator to design your assembly just the way you want it. Either way, eFab can help ensure a quality installation every time while greatly improving your cash flow.

Steel City® is the industry-leading product line of metallic switch and outlet boxes used in electrical construction. Since 1904, Steel City products have symbolized the highest quality standards in manufacturing and innovative design, with one of the most complete offerings available. Always paying attention to the details, Steel City® is known for introducing small improvements that make a big difference, such as the first box offering to standardize slotted/Phillips screws on all boxes.

Online.

Easily configure the assembly in 3D or choose from our popular preassemblies.

On-site.

The order is delivered directly from the factory to the job site, fully assembled and labeled as requested.

On time.

Delivery is made when requested, so planning can be more effective.

On the money.

Installers have the finished assemblies they need, built to the same high, consistent standard and labeled for every installation point. The result? Big savings on labor, inventory, and shipping.

Save steps. Save money.

In commercial construction, labor cost is the single largest expense for an electrical contractor. It can be particularly costly to have experienced electricians assembling the thousands of components needed to route, terminate, support, and protect a complicated commercial or institutional electrical system.

eFab takes care of the rough-in labor. You will save on inventory and shipping. And because your components come preassembled in the exact number you require, there is no worry about minimum order requirements on the individual parts, which often lead to leftovers.

It is all about Total Cost Reduction.

Tap into the efficiencies of eFab and you will see significant savings in all these areas:

- **Labor Savings**—Custom-designed assemblies of components can save you more than 50% on in-wall rough-in installation costs.
- **Material Savings**—Special eFab ARRA and Buy-America assemblies can reduce overall material costs by up to 40%.
- **Logistics Savings**—Deliveries of project-specific packaging and labeling direct to the job site reduce material handling and inventory costs.
- **Reduced Waste**—Palletized eFab assemblies reduce on-site packaging and waste.
- **Process Improvements**—eFab lets you design, quote, and order your in-wall rough-in electrical systems and manage it all online.
- **Extensive Project Support**



The eFab Configurator

Configure your assembly. Then, figure your savings.

Contractors make or break the bank within the wall and ceiling, with installation accounting for 60–70% of the project cost. Use the Configurator and save.

Customizing your assembly online.

Through its easy-to-use, intuitive cloud-based interface, the eFab Configurator gives you the power of full 3D manipulation, so you can design, edit, and manage an unlimited number of configurations. As you select parts, the eFab Configurator generates a 3D image of your assembly and assigns a part number, eliminating miscommunication.

Streamlining the process.

Once your 3D assembly is complete, you can:

- Specify how parts should be labeled and packaged together for added ease on the job site
- Instantly receive a quote
- Download your 3D image for submittal, including DXF file
- Produce a drawing with part numbers
- Print a bill of materials (BOM), including catalog numbers and descriptions

eFab creates a library of your assemblies, which can be accessed through the cloud by co-workers for reference or for ordering. Your assembly can be accessed anytime, anywhere from any computer connected to the internet.

Calculate your savings.

Whether you configure your own assembly or select one of our standard options, you will realize substantial labor cost savings. To calculate the savings associated with each type of assembly, check out our Labor Savings Calculator at tnb.com/SteelCityeFab. You can adjust the labor rate, quantities, and material costs to forecast your savings in both dollars and time.

To learn more visit tnb.com/SteelCityeFab, where you can view a demo video and access the eFab Configurator.



There's a T&B engineered solution for every project:

Schools | Office Buildings | Residential Developments
 Hospitals and Other Health Care Facilities | Mixed-Use Complexes
 Retail Centers | Hotels | Resorts | Data Centers

eFab Components

Quality you can count on

Thomas & Betts eFab assemblies are made from high-quality Steel City® components. They are designed to work together in perfect harmony, whether you choose to customize your own assembly or order one of our popular standard combinations.

Floor Mount T Bracket

Consistent box locations and box height...every time

Consistency results in efficiency and labor savings on the job. With three fixed box locations and a fixed height of 18", the Steel City® Pre-Fab T Bracket provides a consistent installation every time. For added efficiency, the bracket includes integral mounting screws that help reduce installation time. A handy locator tab at the base of the bracket saves you the time of looking for installed boxes that have been hidden by wall coverings. The base also features unique floor track tabs. The inner tab slides in front of the floor track, and the two outer tabs slide behind the floor track to provide stability when positioning the bracket.

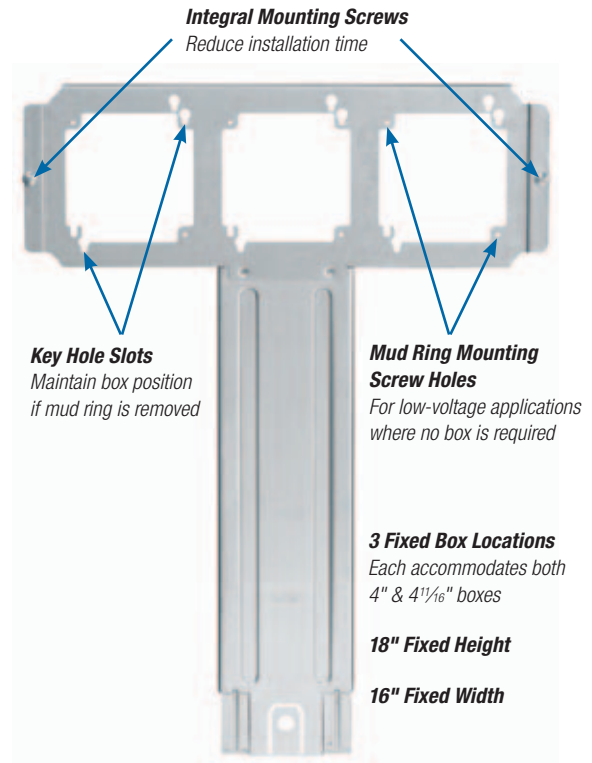
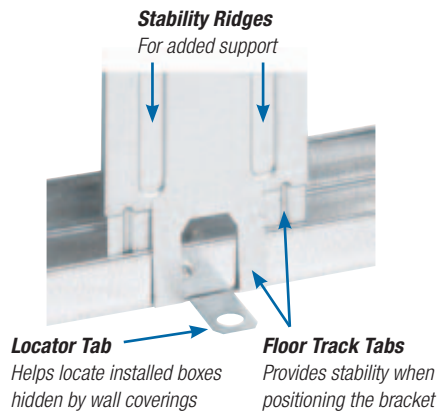

Floor Mount T Bracket

Cat. No.	Description	Std. Pkg. Quantity	UPC Number
H16V18S	Pre-Fab T Bracket	10	785991-04801

Extension Plate Bracket

- Improved bracket with bendable stabilizer leg for use on 2½" and 3½" metal studs
- Mounts outlet boxes 12" or 18" offset from either a metal stud track or a stud
- When mounted, drywall ring is brought to within ⅛" of drywall every time and will not budge or break out drywall
- Mounts 4" or 4¹/₆" outlet boxes, 1½" or 2¹/₈" deep
- SV18 provides compliance with Americans with Disabilities Act (ADA) requirements



Extension Plate Bracket

Cat. No.	Description	Std. Ctn.
SSF-SV12	Extension plate bracket, 12" height	50
SSF-SV18	Extension plate bracket, 18" height	50

Stud-to-Stud Mounting Brackets

- Constructed of 24-gauge steel
- Pre-measured on center for 16" (SBO16) or 24" (SBO24) stud spacing
- SBO16 accepts three 4" square or two 4¹/₁₆" boxes (deep or shallow)
- SBO24 accepts five 4" square or four 4¹/₁₆" boxes (deep or shallow)
- Can be mounted at any height to meet individual project requirements
- Versatile, open design enables mounting of box in any location across horizontal plane between studs
- Device cover (mud ring) mounts to front of bracket to set box in desired location
- Stamped rule on bracket with 1/4", 1/2", and 1" markings

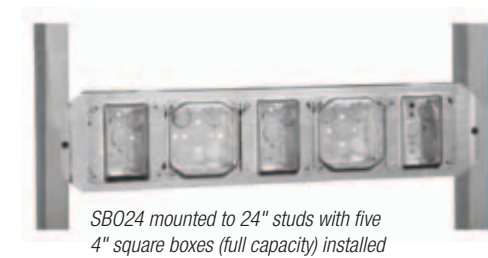
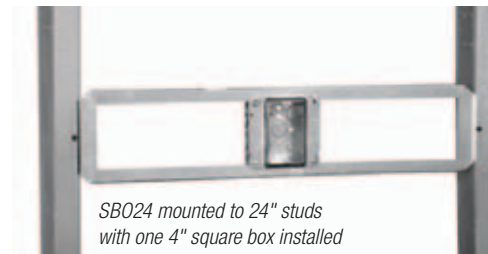
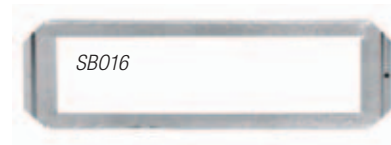

Stud-to-Stud Mounting Brackets

Cat. No.	Description	Std. Pkg. Quantity	UPC Number
SB016	16" Stud-to-Stud Horizontal Mounting Bracket	25	78599103893
SB024	24" Stud-to-Stud Horizontal Mounting Bracket	25	78599103895

Stud-to-Stud Mounting Brackets — Fixed Box Position

- Supports electrical boxes, plaster rings, or low-voltage devices from one bracket
- Accommodates 4" or 4¹/₁₆" boxes
- Bendable leg serves as a bracket stabilizer
- SB brackets allow box mounting in all four 90° orientations



Stud-to-Stud Mounting Brackets — Fixed Box Position

Cat. No.	Description	Std. Ctn.
H16S	Box mounting bracket for between studs, 16" stud spacing	25
H24S	Box mounting bracket for between studs, 24" stud spacing	25

Box-to-Stud Mounting Bracket With Far-Side and Cable Support

Three products in one.

The savings can add up, particularly on a large job, when a box bracket, far-side support, and cable support are combined in one product to reduce your labor and inventory costs. It is designed for maximum flexibility with flanges for either left or right stud mount, and compatibility with both 4" and 4¹/₁₆" boxes.

- Built-in cable support secures cable 6" above the box, satisfying NEC® code requirements
- Flexible design accommodates both 4" and 4¹/₁₆" boxes
- Key-hole box mounting slots maintain box position if mud ring needs to be removed
- Provides clear access to knockouts once the box is installed for installation of fittings
- Mounts to either side of the stud

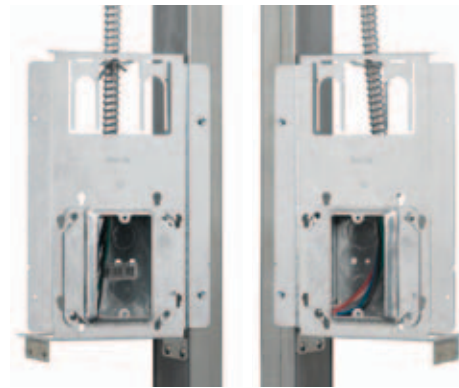

Can be mounted either left or right of the stud

Clear Access to Knock-Outs and/or Fittings
Once box is installed

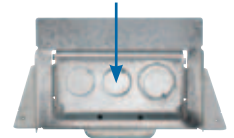

Bottom view of bracket with box installed

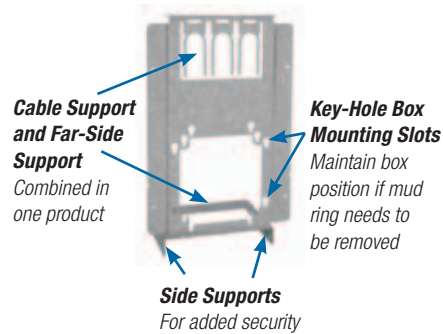

Cable Support and Far-Side Support
Combined in one product

Key-Hole Box Mounting Slots
Maintain box position if mud ring needs to be removed

Side Supports
For added security

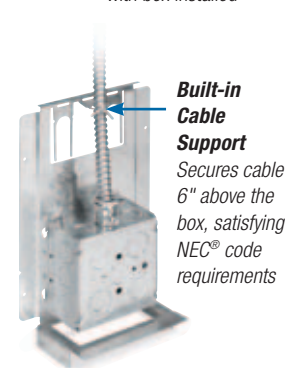

Built-in Cable Support

Secures cable 6" above the box, satisfying NEC® code requirements

Back view of bracket with box, fitting and cable installed

Box-to-Stud Mounting Bracket With Far-Side and Cable Support

Cat. No.	Description	Std. Pkg. Quantity
SSF-SH2346-CS	Pre-Fab Box Bracket with Far-Side and Cable Support	50

Box-to-Stud Mounting Bracket

- Attaches 4" and 4¹/₁₆" electrical boxes to metal stud
- Support leg can be attached to stud to eliminate movement of box in wall
- Attaches to metal or wood stud using self-tapping screws and screw gun or nails
- One part mounts boxes for 1¹/₂", 2¹/₂", 3¹/₂", 4", and 6" studs, which means less inventory

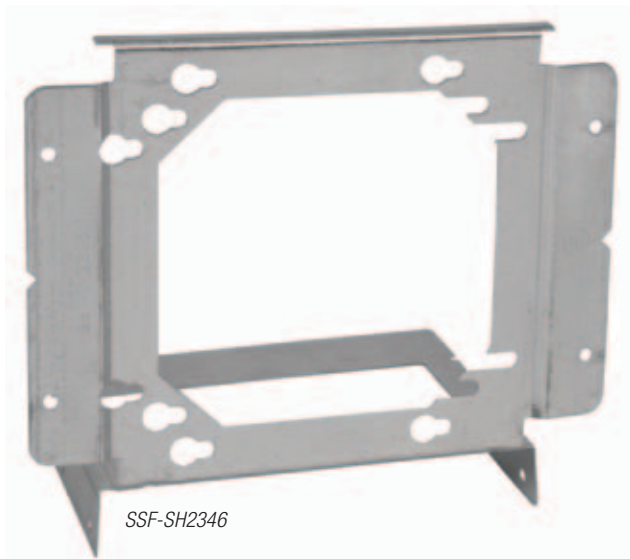
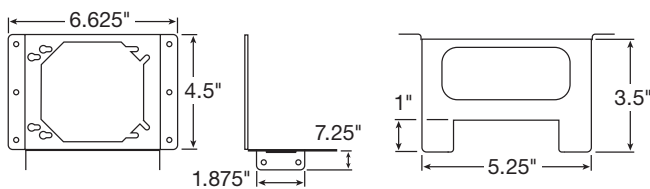

Box-to-Stud Mounting Brackets

Cat. No.	Description	Std. Pkg. Quantity	UPC Number
SSF-SH2346	Bracket for mounting 4" or 4 ¹ / ₁₆ " box to 1 ¹ / ₂ ", 2 ¹ / ₂ ", 3 ¹ / ₂ ", 4", or 6" stud	100	78599120731

Dual Box-to-Stud Mounting Bracket

One component replaces two, reducing both material and labor costs.



Power on both sides of the stud

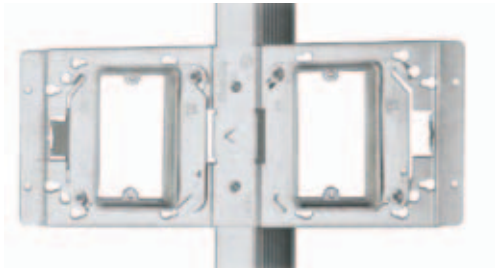

Low voltage on both sides of the stud

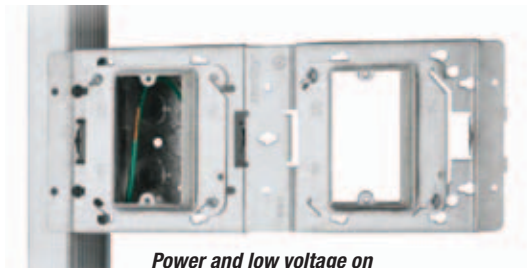

Power and low voltage on the same side of the stud

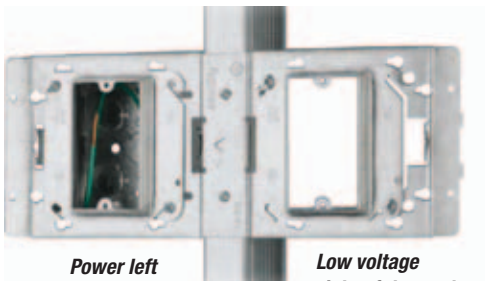

Power left of the stud

Low voltage right of the stud

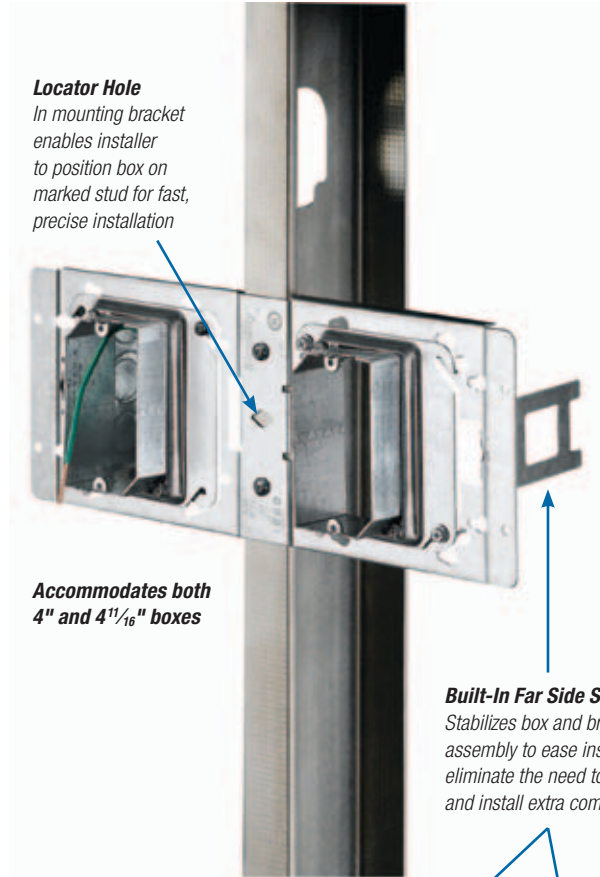

Locator Hole
In mounting bracket enables installer to position box on marked stud for fast, precise installation

Accommodates both 4" and 4^{11/16}" boxes

Built-In Far Side Support
Stabilizes box and bracket assembly to ease installation and eliminate the need to purchase and install extra components



Dual Box-to-Stud Mounting Bracket

Cat. No.	Description	Std. Pkg. Quantity	UPC Number
DBB1	Pre-Fab Dual Box Bracket	50	785991-04625

Box Support Covers

- Combines a box-to-stud mounting bracket with a device cover in one easy-to-use product
- Designed for use with 4" square boxes
- Used with both steel and wood studs
- Cover raised 1/2", 5/8", or 3/4"
- Designed for one or two devices

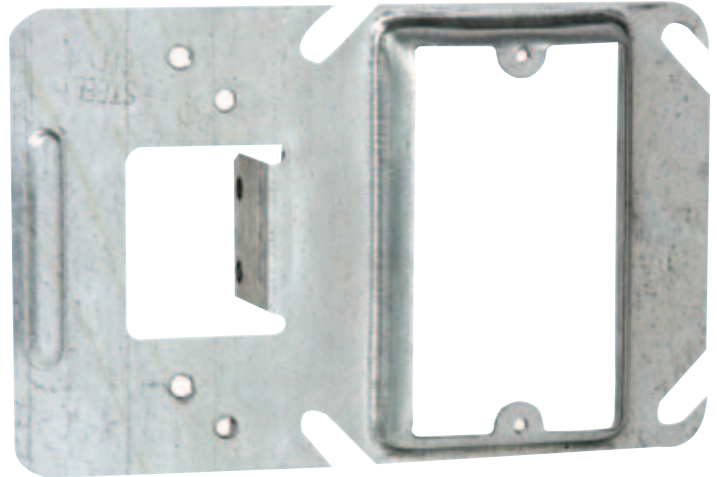

52CM14-5/8



Box Support Covers

Cat. No.	Raised	No. of Devices	Cu. In. Cap.	Std. Pkg. Quantity	UPC Number
52CM13	1/2"	1	3.0	25	78599102634
52CM14-5/8	5/8"	1	4.0	25	78599102635
52CM14	3/4"	1	5.0	25	78599102636
52CMD17	1/2"	2	6.3	25	78599102637
52CMD18-5/8	5/8"	2	7.3	25	78599102638
52CMD18	3/4"	2	9.0	25	78599102639

Adjustable Box Brackets

- Designed for metal studs 16" or 24" on center
- Can also be adjusted for non-standard stud spacing
- Adjustable tabs accommodate 1 1/2" or 2 1/8" box depths
- Enables mounting of multiple boxes
- Installs easily—dimples provide a starting point for screws



SSF-SG16A



Adjustable Box Brackets

Cat. No.	Description	Stud Spacing	Box Depth	Std. Pkg. Quantity	UPC Number
SSF-SG16A	16" Adjustable Box Bracket	11"–18"	1 1/2" or 2 1/8"	50	78599101489
SSF-SG24A	24" Adjustable Box Bracket	17"–26"	1 1/2" or 2 1/8"	50	78599101490

Adjustable Mud Rings

Available in both single- and two-gang.

UL-listed mud rings feature an inner ring that adjusts from $\frac{1}{2}$ " to $1\frac{1}{2}$ " in depth to accommodate various drywall thicknesses. Marked with a measured rule and equipped with two adjustment screws, the inner ring can be set to the anticipated depth prior to installation and then easily adjusted after drywall installation to accommodate any variation in depth ($\frac{1}{2}$ " to $1\frac{1}{2}$ ").

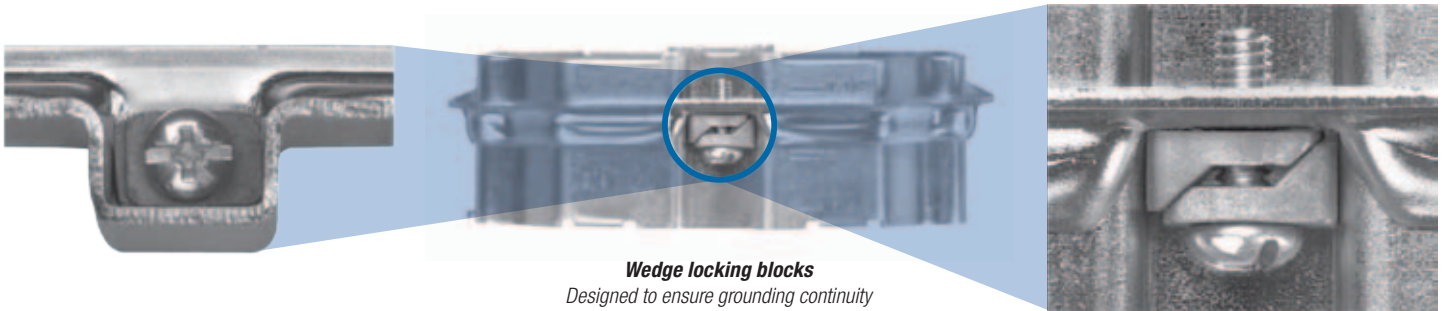

Adjustable Mud Ring Installation/Adjustment Steps:

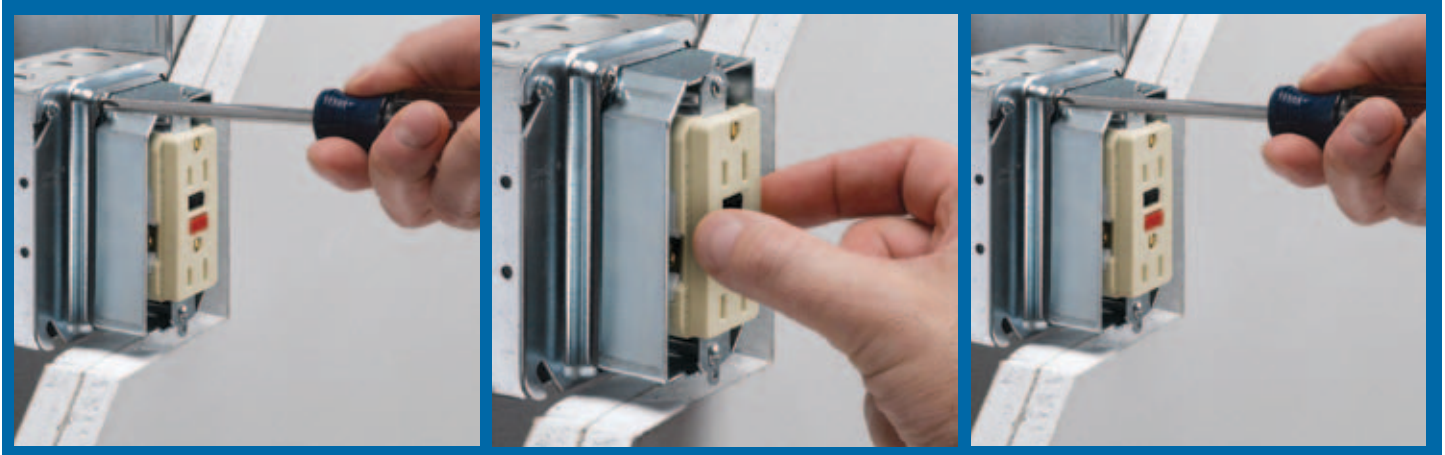

Loosen...

The two adjustment screws located on opposing corners of the mud ring.

Adjust...

Inner ring to be flush with wall surface.

Re-tighten...

Adjustment screws.

Adjustable Mud Ring

Cat. No.	Description	Std. Ctn.
52-C-ADJ	Single-Gang Adjustable Mud Ring, $\frac{1}{2}$ " to $1\frac{1}{2}$ "	25
52-C-ADJ2	Two-Gang Adjustable Mud Ring, $\frac{1}{2}$ " to $1\frac{1}{2}$ "	20

Cable Support Bracket

Meets code requirements for supporting and securing installed MC cable.

- Provides a simple means of complying with NEC® 330.30 requirements for securing and supporting MC cable
- Quick and easy locking tab snaps through slot to secure cable
- Ribs maintain separation of cables
- Durable steel construction retains integrity
- Versatile design—use with Romex or MC cable
- UL listed

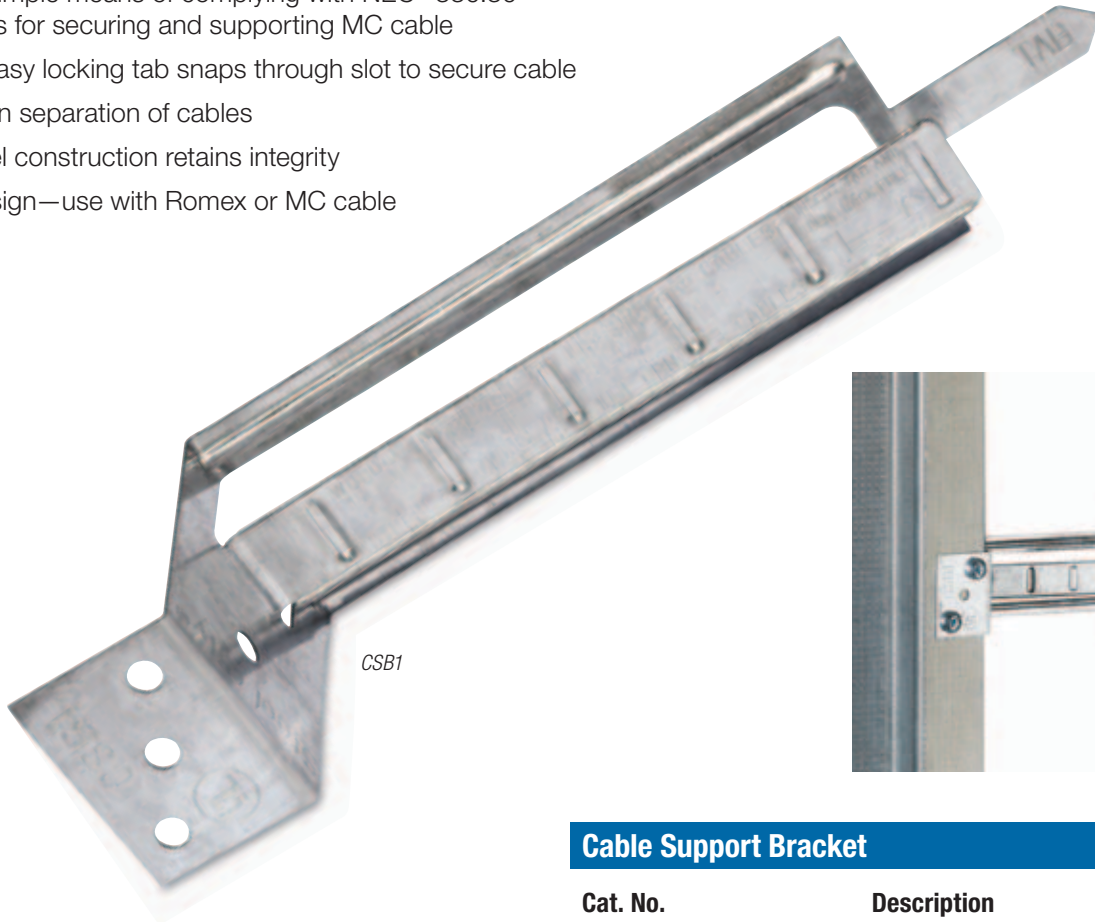

Cable Support Bracket

Cat. No.	Description	Std. Ctn.
CSB1	Cable Support Bracket	100

Screw-On Conduit Support

- Supports ½" and ¾" EMT conduit and MC/AC cable
- Works with wood or metal stud
- Preset bend provides alignment with knockouts for 1½"-deep boxes or 2⅛"-deep boxes

Screw-On Conduit Support

Cat. No.	Fig. No.	Description	Std. Ctn.
SSF-SS1/2 3/4	1	½" and ¾" EMT conduit and MC/AC to metal or wood stud. For 1½" deep box.	100
SSF-SS1/2 3/4D		½" and ¾" EMT conduit and MC/AC to metal or wood stud. For 2⅛" deep box.	100

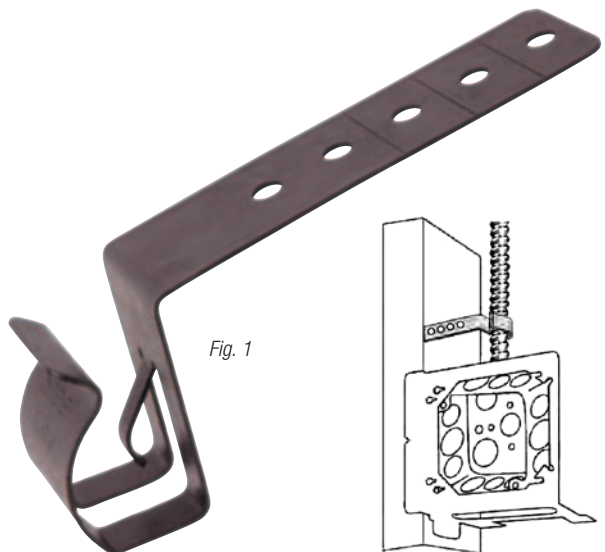

Steel City® Super Deep 4" Square Wall Boxes

- Increased capacity accommodates large devices in commercial and industrial applications, such as fire alarm systems
- Red-painted version available for quick and easy identification of life-safety electrical systems
- Available with or without integrally mounted support bracket



Super Deep 4" Square Wall Boxes

Cat. No.	Description	Ears	Brkts.	Each Side KO	Each End KO	Bottom KO	Cu. Inch Capacity	Std. Ctn.
521911234RD	3½"-Deep, 4"-Square Red Box	—	—	(4) ½" & ¾" Combo	(2) ½" & ¾" Combo	(4) ½" & ¾" Combo	46	24
521911234CVRD	3½"-Deep, 4"-Square Red Box with Side Mounting Bracket	—	CV	(4) ½" & ¾" Combo	(2) ½" & ¾" Combo	(4) ½" & ¾" Combo	46	10
521911234	3½"-Deep, 4"-Square Box	—	—	(4) ½" & ¾" Combo	(2) ½" & ¾" Combo	(4) ½" & ¾" Combo	46	24
521911234CV	3½"-Deep, 4"-Square Box with Side Mounting Bracket	—	CV	(4) ½" & ¾" Combo	(2) ½" & ¾" Combo	(4) ½" & ¾" Combo	46	10

Fire Alarm Boxes and Fittings

Easy to identify and install.

Steel City® Fire Alarm Boxes and Fittings can meet all of your visual identification requirements for fire alarm systems—and make installation and upgrades faster and easier than ever before. Available in a variety of sizes to accommodate new or old work configurations, these boxes are simple to install with high-quality Thomas & Betts fittings. Plus the bright red finish eliminates time-consuming painting of existing fixtures and provides long-lasting identification in even the harshest environments.



52171-1234RD

72171-1234RD

52171-EXTRD



52-C-1RD



52151-1234RD

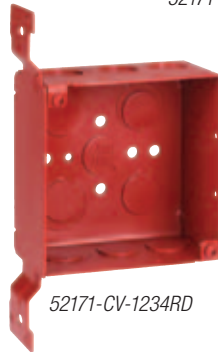

52171-CV-1234RD

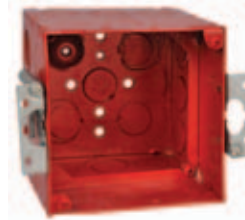

52171-EXTOWRD

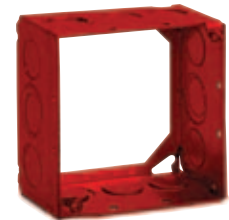

53171-1234RD



Fire Alarm Boxes

Cat. No.	Description	Ears	Brkts.	Each Side Conduit	Each End Conduit	Bottom Conduit	Cu. Inch Capacity	Std. Ctn.
52171-1234RD	2 1/8"-deep 4-square red box	—	—	2 1/2", 1 1/2" & 3/4"E	2 1/2", 1 1/2" & 3/4"E	3 1/2", 2 1/2" & 3/4"E	30.3	50
52151-1234RD	1 1/2"-deep drawn red box	—	—	2 1/2", 1 3/4"	2 1/2", 1 3/4"	3 1/2", 2 3/4"	21.0	50
72171-1234RD	2 1/8"-deep 4 1/16" red box	—	—	3 1/2" & 3/4"E	3 1/2" & 3/4"E	3 1/2", 2 1/2" & 3/4"E	42.0	20
52171-CV-1234RD	2 1/8"-deep 4-square red box with CV bracket	—	CV	2 1/2", 1 1/2" & 3/4"E	2 1/2", 1 1/2" & 3/4"E	3 1/2", 2 1/2" & 3/4"E	30.3	50
52171-EXTRD	2 1/8"-deep 4-square red box with ext. ring	—	—	4 1/2", 2 1/2" & 3/4"E	4 1/2", 2 1/2" & 3/4"E	3 1/2", 2 1/2" & 3/4"E	60.6	25
52171-EXTOWRD	2 1/8"-deep 4-square red box with ext. ring and old work ears	Yes	—	4 1/2", 2 1/2" & 3/4"E	4 1/2", 2 1/2" & 3/4"E	3 1/2", 2 1/2" & 3/4"E	60.6	25
52-C-1RD	Flat 4-square red cover	—	—	—	—	—	—	100
53171-1234RD	2 1/8"-deep 4-square red extension ring	—	—	2 1/2", 1 1/2" & 3/4"E	2 1/2", 1 1/2" & 3/4"E	—	30.3	25



TK122A-FA

TK121A-FA

TC122A-FA

TC121A-FA



Fire Alarm Fittings

Cat. No.	Description	Std. Ctn.
TC121A-FA	1/2" Red Steel EMT Set Screw Connector	50
TC122A-FA	3/4" Red Steel EMT Set Screw Connector	50
TC123A-FA	1" Red Steel EMT Set Screw Connector	25
TC721A-FA	1/2" Red Insulated Steel EMT Set Screw Connector	50
TC722A-FA	3/4" Red Insulated Steel EMT Set Screw Connector	50
TC723A-FA	1" Red Insulated Steel EMT Set Screw Connector	25
TK121A-FA	1/2" Red Steel EMT Set Screw Coupling	50
TK122A-FA	3/4" Red Steel EMT Set Screw Coupling	50
TK123A-FA	1" Red Steel EMT Set Screw Coupling	25



eFab Typical Assemblies

How successful projects are put together

Here are some of our most requested preassembled units. Order as is or customize further using the eFab Configurator.

Box With Pre-Installed 10½" Pigtail, Raised Cover, and Vertical Mounting Bracket

- 4" square welded box, 1½" or 2⅛" deep
- Pre-installed 10½" insulated grounding pigtail
- One- or two-device cover, raised ½", ⅝", or ¾"
- 12" (SSF-SV12) or 18" (SSF-SV18) vertical mounting bracket
- Save on labor costs by eliminating multiple installation steps



151-SV18-1458



151-SV12-1458



Box With Pre-Installed 10½" Pigtail, Raised Cover, and Vertical Mounting Bracket

Cat. No.	Box Type Included	Box Depth	Pigtail Included	Box Cover Included	Raised	No. of Devices	Bracket Included	Std. Pkg. Quantity	UPC Number
151-SV12-13	521511234EW	1½"	10½"	52-C-13	½"	1	SSF-SV12	10	78599102601
151-SV12-1458	521511234EW	1½"	10½"	52-C-14-5/8	⅝"	1	SSF-SV12	10	78599102602
151-SV12-14	521511234EW	1½"	10½"	52-C-14	¾"	1	SSF-SV12	10	78599102752
151-SV12-17	521511234EW	1½"	10½"	52-C-17-25	½"	2	SSF-SV12	10	78599102754
151-SV12-1858	521511234EW	1½"	10½"	52-C-18-5/8-25	⅝"	2	SSF-SV12	10	78599102756
151-SV12-18	521511234EW	1½"	10½"	52-C-18	¾"	2	SSF-SV12	10	78599102604
171-SV12-13	521711234E	2⅛"	10½"	52-C-13	½"	1	SSF-SV12	10	78599102589
171-SV12-1458	521711234E	2⅛"	10½"	52-C-14-5/8	⅝"	1	SSF-SV12	10	78599102591
171-SV12-14	521711234E	2⅛"	10½"	52-C-14	¾"	1	SSF-SV12	10	78599102590
171-SV12-17	521711234E	2⅛"	10½"	52-C-17-25	½"	2	SSF-SV12	10	78599102770
171-SV12-1858	521711234E	2⅛"	10½"	52-C-18-5/8-25	⅝"	2	SSF-SV12	10	78599102774
171-SV12-18	521711234E	2⅛"	10½"	52-C-18	¾"	2	SSF-SV12	10	78599102772
151-SV18-13	521511234EW	1½"	10½"	52-C-13	½"	1	SSF-SV18	10	78599102606
151-SV18-1458	521511234EW	1½"	10½"	52-C-14-5/8	⅝"	1	SSF-SV18	10	78599102607
151-SV18-14	521511234EW	1½"	10½"	52-C-14	¾"	1	SSF-SV18	10	78599102758
151-SV18-17	521511234EW	1½"	10½"	52-C-17-25	½"	2	SSF-SV18	10	78599102760
151-SV18-1858	521511234EW	1½"	10½"	52-C-18-5/8-25	⅝"	2	SSF-SV18	10	78599102762
151-SV18-18	521511234EW	1½"	10½"	52-C-18	¾"	2	SSF-SV18	10	78599102609
171-SV18-13	521711234E	2⅛"	10½"	52-C-13	½"	1	SSF-SV18	10	78599102593
171-SV18-1458	521711234E	2⅛"	10½"	52-C-14-5/8	⅝"	1	SSF-SV18	10	78599102595
171-SV18-14	521711234E	2⅛"	10½"	52-C-14	¾"	1	SSF-SV18	10	78599102594
171-SV18-17	521711234E	2⅛"	10½"	52-C-17-25	½"	2	SSF-SV18	10	78599102776
171-SV18-1858	521711234E	2⅛"	10½"	52-C-18-5/8-25	⅝"	2	SSF-SV18	10	78599102780
171-SV18-18	521711234E	2⅛"	10½"	52-C-18	¾"	2	SSF-SV18	10	78599102778

Box-to-Stud Mounting Bracket With Far-Side and Cable Support

- Built-in cable support secures cable 6" above the box, satisfying NEC® code requirements
- Flexible design accommodates both 4" and 4¹/₁₆" boxes
- Key-hole box mounting slots maintain box position if mud ring needs to be removed
- Pre-installed 10¹/₂" insulated grounding pigtails
- One- or two-device cover, raised 1/2", 5/8", or 3/4"
- Save on labor costs by eliminating multiple installation steps



Box-to-Stud Mounting Bracket With Far-Side and Cable Support

Cat. No.	Box Type Included	Box Depth	Pigtail Included	Box Cover Included	Raised	No. of Devices	Bracket Included	Std. Pkg. Quantity	UPC Number
151-SH2346-13-CS	521511234EW	1 ¹ / ₂ "	10 ¹ / ₂ "	52-C-13	1/2"	1	SSF-SH2346-CS	10	78599107178
151-SH2346-1458-CS	521511234EW	1 ¹ / ₂ "	10 ¹ / ₂ "	52-C-14-5/8	5/8"	1	SSF-SH2346-CS	10	78599107179
151-SH2346-14-CS	521511234EW	1 ¹ / ₂ "	10 ¹ / ₂ "	52-C-14	3/4"	1	SSF-SH2346-CS	10	78599107180
151-SH2346-17-CS	521511234EW	1 ¹ / ₂ "	10 ¹ / ₂ "	52-C-17-25	1/2"	2	SSF-SH2346-CS	10	78599107181
151-SH2346-1858-CS	521511234EW	1 ¹ / ₂ "	10 ¹ / ₂ "	52-C-18-5/8-25	5/8"	2	SSF-SH2346-CS	10	78599107182
151-SH2346-18-CS	521511234EW	1 ¹ / ₂ "	10 ¹ / ₂ "	52-C-18	3/4"	2	SSF-SH2346-CS	10	78599107183
171-SH2346-13-CS	521711234E	2 ¹ / ₈ "	10 ¹ / ₂ "	52-C-13	1/2"	1	SSF-SH2346-CS	10	78599107184
171-SH2346-1458-CS	521711234E	2 ¹ / ₈ "	10 ¹ / ₂ "	52-C-14-5/8	5/8"	1	SSF-SH2346-CS	10	78599107186
171-SH2346-14-CS	521711234E	2 ¹ / ₈ "	10 ¹ / ₂ "	52-C-14	3/4"	1	SSF-SH2346-CS	10	78599107187
171-SH2346-17-CS	521711234E	2 ¹ / ₈ "	10 ¹ / ₂ "	52-C-17-25	1/2"	2	SSF-SH2346-CS	10	78599107188
171-SH2346-1858-CS	521711234E	2 ¹ / ₈ "	10 ¹ / ₂ "	52-C-18-5/8-25	5/8"	2	SSF-SH2346-CS	10	78599107189
171-SH2346-18-CS	521711234E	2 ¹ / ₈ "	10 ¹ / ₂ "	52-C-18	3/4"	2	SSF-SH2346-CS	10	78599107191

Box With Pre-Installed 10½" Pigtail, Raised Cover, and Box-to-Stud Bracket

- 4" square welded box, 1½" or 2⅞" deep
- Pre-installed 10½" insulated grounding pigtail
- One- or two-device cover, raised ½", ⅝", or ¾"
- SSF-SH2346 box-to-stud mounting bracket
- Save on labor costs by eliminating multiple installation steps

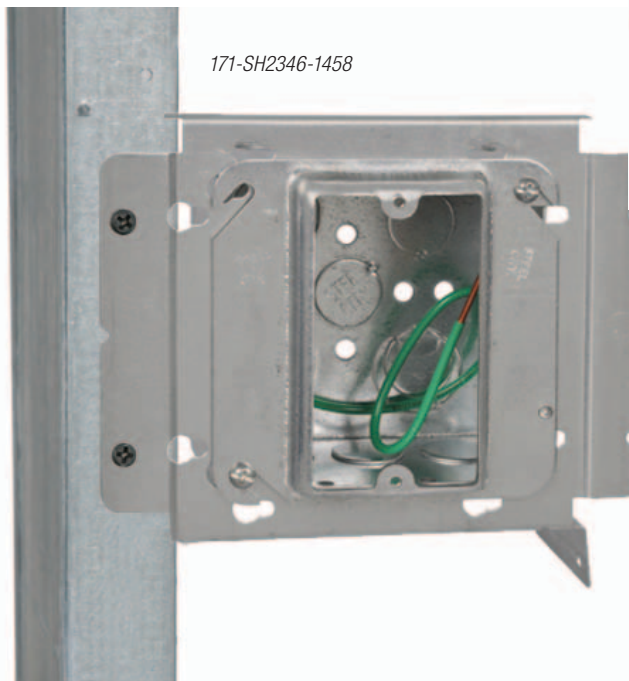

Box With Pre-Installed 10½" Pigtail, Raised Cover, and Box-to-Stud Bracket

Cat. No.	Box Type Included	Box Depth	Pigtail Included	Box Cover Included	Raised	No. of Devices	Bracket Included	Std. Pkg. Quantity	UPC Number
*151-SH2346-13	521511234EW	1½"	10½"	52-C-13	½"	1	SSF-SH2346	10	78599102611
*151-SH2346-1458	521511234EW	1½"	10½"	52-C-14-5/8	⅝"	1	SSF-SH2346	10	78599102612
*151-SH2346-14	521511234EW	1½"	10½"	52-C-14	¾"	1	SSF-SH2346	10	78599102746
*151-SH2346-17	521511234EW	1½"	10½"	52-C-17-25	½"	2	SSF-SH2346	10	78599102748
*151-SH2346-1858	521511234EW	1½"	10½"	52-C-18-5/8-25	⅝"	2	SSF-SH2346	10	78599102810
*151-SH2346-18	521511234EW	1½"	10½"	52-C-18	¾"	2	SSF-SH2346	10	78599102614
171-SH2346-13	521711234E	2⅞"	10½"	52-C-13	½"	1	SSF-SH2346	10	8599102597
171-SH2346-1458	521711234E	2⅞"	10½"	52-C-14-5/8	⅝"	1	SSF-SH2346	10	78599102599
171-SH2346-14	521711234E	2⅞"	10½"	52-C-14	¾"	1	SSF-SH2346	10	78599102598
171-SH2346-17	521711234E	2⅞"	10½"	52-C-17-25	½"	2	SSF-SH2346	10	78599102764
171-SH2346-1858	521711234E	2⅞"	10½"	52-C-18-5/8-25	⅝"	2	SSF-SH2346	10	78599102812
171-SH2346-18	521711234E	2⅞"	10½"	52-C-18	¾"	2	SSF-SH2346	10	78599102766

* ¾" K/O not usable in shallow box.

Box With Pre-Installed 10½" Pigtail and Box Support Cover

- 4" square welded box, 1½" or 2⅛" deep
- Pre-installed 10½" insulated grounding pigtail
- Box support cover combines box-to-stud mounting bracket with device cover
- One- or two-device box support cover, raised ½", ⅝", or ¾"
- Save on labor costs by eliminating multiple installation steps

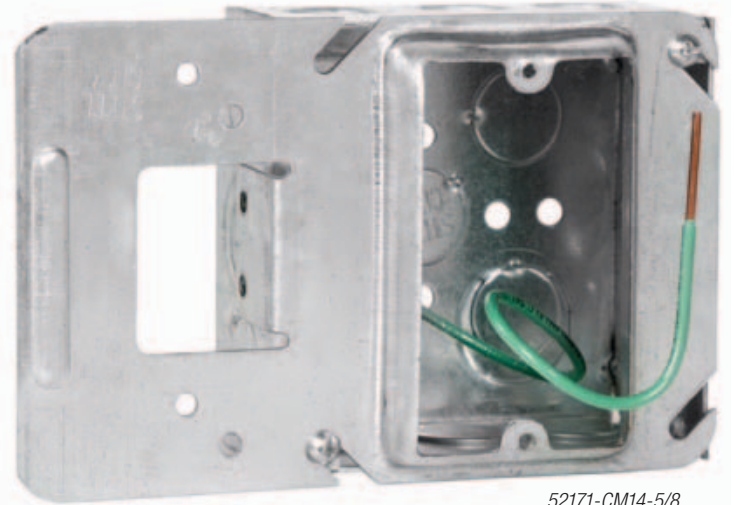

52171-CM14-5/8

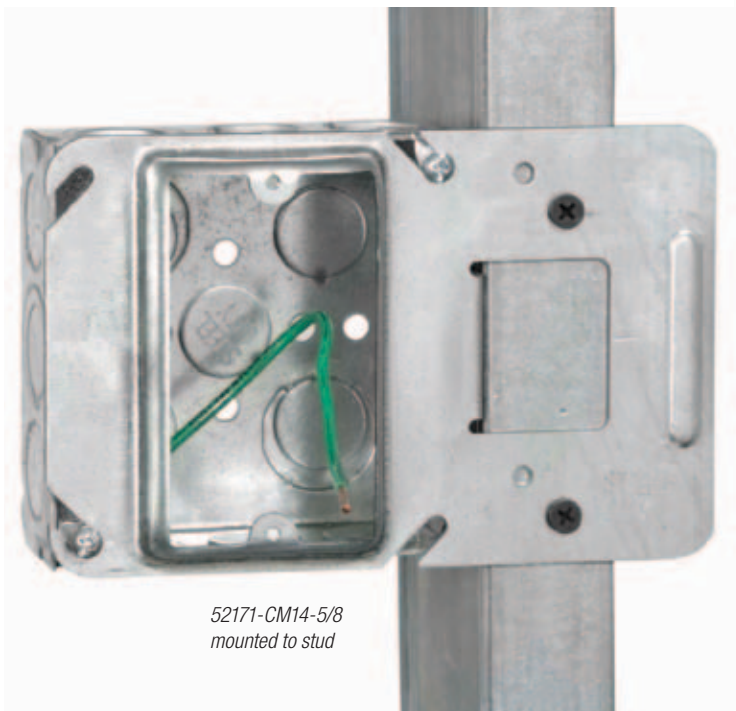
52171-CM14-5/8
mounted to stud

Box With Pre-Installed 10½" Pigtail and Box Support Cover

Cat. No.	Box Type Included	Box Depth	Pigtail Included	Box Cover Included	Raised	No. of Devices	Std. Pkg. Quantity	UPC Number
52151-CM13	521511234EW	1½"	10½"	52CM13	½"	1	25	78599102712
52151-CM14-5/8	521511234EW	1½"	10½"	52CM14-5/8	⅝"	1	25	78599102714
52151-CM14	521511234EW	1½"	10½"	52CM14	¾"	1	25	78599102716
52151-CMD17	521511234EW	1½"	10½"	52CMD17	½"	2	25	78599102718
52151-CMD18-5/8	521511234EW	1½"	10½"	52CMD18-5/8	⅝"	2	25	78599102720
52151-CMD18	521511234EW	1½"	10½"	52CMD18	¾"	2	25	78599102722
52171-CM13	521711234E	2⅛"	10½"	52CM13	½"	1	25	78599102700
52171-CM14-5/8	521711234E	2⅛"	10½"	52CM14-5/8	⅝"	1	25	78599102702
52171-CM14	521711234E	2⅛"	10½"	52CM14	¾"	1	25	78599102704
52171-CMD17	521711234E	2⅛"	10½"	52CMD17	½"	2	25	78599102706
52171-CMD18-5/8	521711234E	2⅛"	10½"	52CMD18-5/8	⅝"	2	25	78599102708
52171-CMD18	521711234E	2⅛"	10½"	52CMD18	¾"	2	25	78599102710

MS Series Pre-Assemblies

- 4" square and 4¹/₁₆" square boxes
- 1¹/₂" deep or 2¹/₈" deep
- Pre-installed 10¹/₂" insulated grounding pigtail
- Available with conduit KOs or clamps for flexible/armored/MC cable
- Save on labor costs by eliminating multiple installation steps

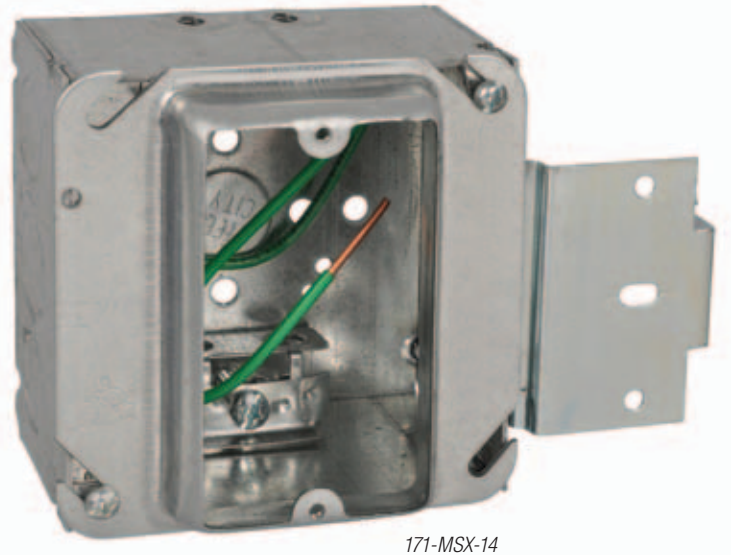

171-MSX-14



MS Series Pre-Assemblies

Cat. No.	Box Type Included	Box Depth	Pigtail Included	Box Cover Included	Raised	No. of Devices	Std. Ctn.
151-MS-13	52151-MS-1/2 3/4	1 ¹ / ₂ "	10 ¹ / ₂ "	52-C-13	1/2"	1	25
151-MS-14	52151-MS-1/2 3/4	1 ¹ / ₂ "	10 ¹ / ₂ "	52-C-14	3/4"	1	25
151-MS-1458	52151-MS-1/2 3/4	1 ¹ / ₂ "	10 ¹ / ₂ "	52-C-14-5/8	5/8"	1	25
171MS13	52171-MS-1/2 3/4	2 ¹ / ₈ "	10 ¹ / ₂ "	52-C-13	1/2"	1	25
171-MS-14	52171-MS-1/2 3/4	2 ¹ / ₈ "	10 ¹ / ₂ "	52-C-14	3/4"	1	25
171-MS-1458	52171-MS-1/2 3/4	2 ¹ / ₈ "	10 ¹ / ₂ "	52-C-14-5/8	5/8"	1	25
171MS18	52171-MS-1/2 3/4	2 ¹ / ₈ "	10 ¹ / ₂ "	52-C-18	3/4"	2	25
171-MS-18 5/8	52171-MS-1/2 3/4	2 ¹ / ₈ "	10 ¹ / ₂ "	52-C-18-5/8-25	5/8"	2	25
171MSX13	52171-MSX	2 ¹ / ₈ "	10 ¹ / ₂ "	52-C-13	1/2"	1	25
171-MSX-14	52171-MSX	2 ¹ / ₈ "	10 ¹ / ₂ "	52-C-14	3/4"	1	25
171-MSX-1458	52171-MSX	2 ¹ / ₈ "	10 ¹ / ₂ "	52-C-14-5/8	5/8"	1	25
171MSX18	52171-MSX	2 ¹ / ₈ "	10 ¹ / ₂ "	52-C-18	3/4"	2	25
171-MSX-18 5/8	52171-MSX	2 ¹ / ₈ "	10 ¹ / ₂ "	52-C-18-5/8-25	5/8"	2	25
72171MS14	72171-MS-1/2 3/4	2 ¹ / ₈ "	10 ¹ / ₂ "	72-C-14	3/4"	1	25
72171-MS-1458	72171-MS-1/2 3/4	2 ¹ / ₈ "	10 ¹ / ₂ "	72-C-14-5/8	5/8"	1	25
72171MS18	72171-MS-1/2 3/4	2 ¹ / ₈ "	10 ¹ / ₂ "	72-C-18	3/4"	2	25
72171-MS-18 5/8	72171-MS-1/2 3/4	2 ¹ / ₈ "	10 ¹ / ₂ "	72-C-18-5/8	5/8"	2	25
72171MSX14	72171-MS-1/2 3/4	2 ¹ / ₈ "	10 ¹ / ₂ "	72-C-14	3/4"	1	25
72171-MSX-1458	72171-MSX	2 ¹ / ₈ "	10 ¹ / ₂ "	72-C-14-5/8	5/8"	1	25
72171MSX18	72171-MS-1/2 3/4	2 ¹ / ₈ "	10 ¹ / ₂ "	72-C-18	3/4"	2	25
72171-MSX-1858	72171-MS-1/2 3/4	2 ¹ / ₈ "	10 ¹ / ₂ "	72-C-18-5/8	5/8"	2	25

Box With Pre-Installed 10½" Pigtail

- Popular 4" square boxes and switch boxes
- Pre-installed 10½" insulated grounding pigtails
- Save on labor costs by eliminating multiple installation steps

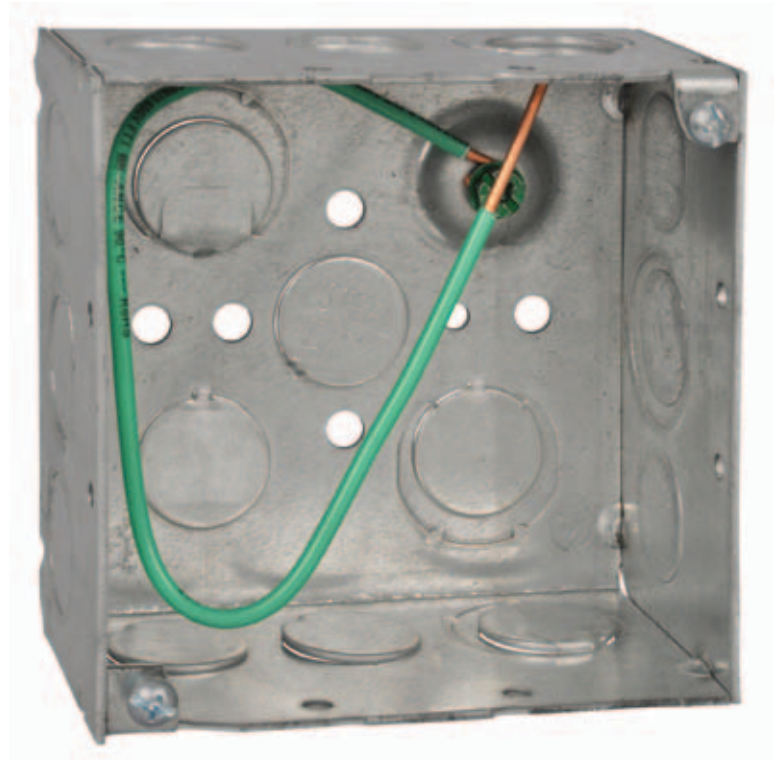

521711234EP



Box With Pre-Installed 10½" Pigtail

Cat. No.	Box Type Included	Knockouts	Pre-Installed Pigtail	Std. Pkg. Quantity	UPC Number
521511234EWP	52151234EW 4"-sq. x 1½"D Welded Box	Eccentric	10½"	50	78599102588
521511234P	521511234 4"-sq. x 1½"D Drawn Box	½" & ¾"	10½"	50	78599102586
521711234EP	521711234E 4"-sq. x 2½"D Welded Box	½" & ¾" Eccentric	10½"	50	78599102587
52151XP	52151X 4"-sq. x 1½"D Welded Box	½" & ¾" Eccentric	10½"	50	78599102724
52151CVNP	52151CVN 4"-sq. x 1½"D Welded Box	½" & ¾" Eccentric	10½"	25	78599102728
LXWOWP	LXWOW-25 3"H x 2"W x 2½"D Gangable Switch Box	½"	10½"	25	78599102959
LXVP	LXV-25 3"H x 2"W x 2½"D Gangable Switch Box	½"	10½"	25	78599102692
CXWOWP	CXWOW 3"H x 2"W x 3½"D Gangable Switch Box	½" & ¾"	10½"	25	78599102694
CXWVP	CXWV 3"H x 2"W x 3½"D Gangable Switch Box	½" & ¾"	10½"	25	78599102696
CXP	CX 3"H x 2"W x 3½"D Gangable Switch Box	½" & ¾"	10½"	25	78599102698



eFabTM
by Thomas & Betts

Online. On-site. On time. On the money.

tnb.com/SteelCityeFab

Visit the T&B world of electrical product solutions

Visit our website for more information about Thomas & Betts solutions and our newest products. For a user-friendly catalog and competitive part-number search, application and technical support, and other useful information, go to tnb.com.

Industry codes and specifications

All Thomas & Betts products for use in commercial and institutional facilities meet or exceed applicable industry specifications or codes, which are detailed in the appropriate T&B product literature.



Online CAD library

Thomas & Betts offers free download of two- and three-dimensional CAD models of many of its products in more than 90 native CAD formats at tnb.com/cadlibrary.



American Recovery and Reinvestment Act (ARRA)

Get certification for compliant products online at tnb.com/ARRA.

United States

Thomas & Betts Corporation Electrical Division Headquarters

8155 T&B Boulevard
Memphis, TN 38125
Phone: 901.252.5000
Fax: 901.252.1354

**Technical Services:
888.862.3289**

**Customer Service:
1.800.816.7809
elec_custserv@tnb.com**

Canada

Thomas & Betts Ltd

700 Thomas Avenue
Saint-Jean-sur-Richelieu, Quebec
J2X 2M9
Phone: 450.347.5318
Fax: 450.347.1976
mrkt.canada@tnb.com

Europe/Middle East/ Africa

Thomas & Betts Europe Centre

200 Chaussee de Waterloo
B-1640 Rhode-St-Genese
Belgium
Phone: +32.235.98200
europe_inquiry@tnb.com

Thomas & Betts Corporation

8155 T&B Boulevard
Memphis, TN 38125
Phone: 901.252.5000

www.tnb.com

Asia Pacific

Thomas & Betts Adia Pte Ltd

10 Ang Mo Kio
Street 65
#06-07 Techpoint
Singapore 569059
Phone: +65.6720.8828
Fax: +65.6720.8780
asia_inquiry@tnb.com

Australasia

Thomas & Betts Australasia Pty Ltd

Unit D3, Lidcombe Business Park
3-29 Birnie Avenue
Lidcombe NSW 2141 Australia
Phone: +61 2 8754 2700
Fax: +61 2 8754 2735



tnb.com/SteelCityFab

Thomas & Betts

A Member of the ABB Group

Now there's something
better than prefab

Steel City | **eFab**
by Thomas & Betts



Thomas & Betts
A Member of the ABB Group

Introducing eFab

From online to on-site, eFab by Thomas & Betts reduces labor, inventory, and shipping costs.

eFab is the powerful, comprehensive rough-in solution that allows you to design and order Steel City® prefab assemblies online and have them delivered directly to the job site for fast installation. Choose from popular preconfigured combinations, or use our exclusive 3D eFab Configurator to design your assembly just the way you want it. Either way, eFab can help ensure a quality installation every time while greatly improving your cash flow.

Steel City® is the industry-leading product line of metallic switch and outlet boxes used in electrical construction. Since 1904, Steel City products have symbolized the highest quality standards in manufacturing and innovative design, with one of the most complete offerings available. Always paying attention to the details, Steel City® is known for introducing small improvements that make a big difference, such as the first box offering to standardize slotted/Phillips screws on all boxes.

Online.

Easily configure the assembly in 3D or choose from our popular preassemblies.

On-site.

The order is delivered directly from the factory to the job site, fully assembled and labeled as requested.

On time.

Delivery is made when requested, so planning can be more effective.

On the money.

Installers have the finished assemblies they need, built to the same high, consistent standard and labeled for every installation point. The result? Big savings on labor, inventory, and shipping.

Save steps. Save money.

In commercial construction, labor cost is the single largest expense for an electrical contractor. It can be particularly costly to have experienced electricians assembling the thousands of components needed to route, terminate, support, and protect a complicated commercial or institutional electrical system.

eFab takes care of the rough-in labor. You will save on inventory and shipping. And because your components come preassembled in the exact number you require, there is no worry about minimum order requirements on the individual parts, which often lead to leftovers.

It is all about Total Cost Reduction.

Tap into the efficiencies of eFab and you will see significant savings in all these areas:

- **Labor Savings**—Custom-designed assemblies of components can save you more than 50% on in-wall rough-in installation costs.
- **Material Savings**—Special eFab ARRA and Buy-America assemblies can reduce overall material costs by up to 40%.
- **Logistics Savings**—Deliveries of project-specific packaging and labeling direct to the job site reduce material handling and inventory costs.
- **Reduced Waste**—Palletized eFab assemblies reduce on-site packaging and waste.
- **Process Improvements**—eFab lets you design, quote, and order your in-wall rough-in electrical systems and manage it all online.
- **Extensive Project Support**



The eFab Configurator

Configure your assembly. Then, figure your savings.

Contractors make or break the bank within the wall and ceiling, with installation accounting for 60–70% of the project cost. Use the Configurator and save.

Customizing your assembly online.

Through its easy-to-use, intuitive cloud-based interface, the eFab Configurator gives you the power of full 3D manipulation, so you can design, edit, and manage an unlimited number of configurations. As you select parts, the eFab Configurator generates a 3D image of your assembly and assigns a part number, eliminating miscommunication.

Streamlining the process.

Once your 3D assembly is complete, you can:

- Specify how parts should be labeled and packaged together for added ease on the job site
- Instantly receive a quote
- Download your 3D image for submittal, including DXF file
- Produce a drawing with part numbers
- Print a bill of materials (BOM), including catalog numbers and descriptions

eFab creates a library of your assemblies, which can be accessed through the cloud by co-workers for reference or for ordering. Your assembly can be accessed anytime, anywhere from any computer connected to the internet.

Calculate your savings.

Whether you configure your own assembly or select one of our standard options, you will realize substantial labor cost savings. To calculate the savings associated with each type of assembly, check out our Labor Savings Calculator at tnb.com/SteelCityeFab. You can adjust the labor rate, quantities, and material costs to forecast your savings in both dollars and time.

To learn more visit tnb.com/SteelCityeFab, where you can view a demo video and access the eFab Configurator.



There's a T&B engineered solution for every project:

Schools | Office Buildings | Residential Developments
Hospitals and Other Health Care Facilities | Mixed-Use Complexes
Retail Centers | Hotels | Resorts | Data Centers

eFab Components

Quality you can count on

Thomas & Betts eFab assemblies are made from high-quality Steel City® components. They are designed to work together in perfect harmony, whether you choose to customize your own assembly or order one of our popular standard combinations.

Floor Mount T Bracket

Consistent box locations and box height...every time

Consistency results in efficiency and labor savings on the job. With three fixed box locations and a fixed height of 18", the Steel City® Pre-Fab T Bracket provides a consistent installation every time. For added efficiency, the bracket includes integral mounting screws that help reduce installation time. A handy locator tab at the base of the bracket saves you the time of looking for installed boxes that have been hidden by wall coverings. The base also features unique floor track tabs. The inner tab slides in front of the floor track, and the two outer tabs slide behind the floor track to provide stability when positioning the bracket.

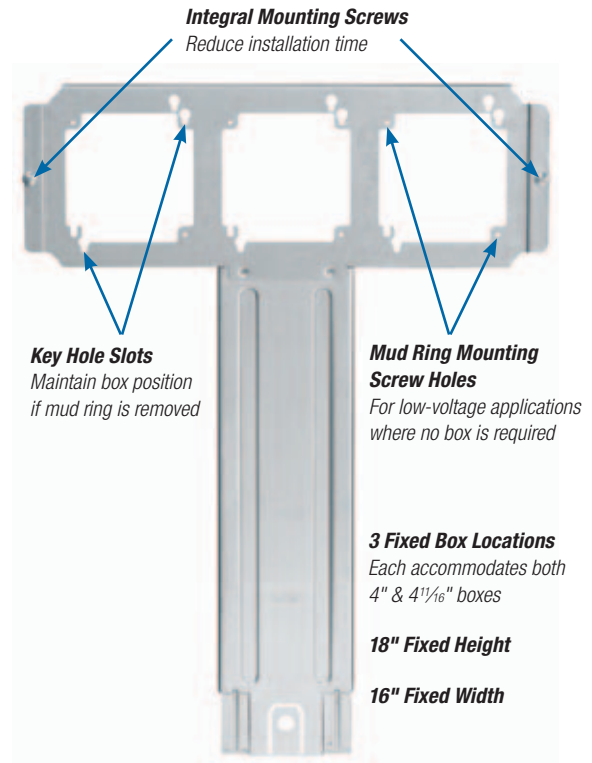
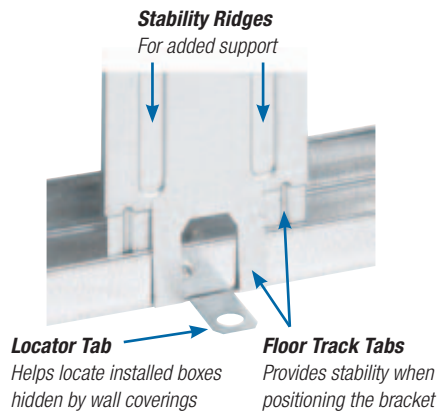

Floor Mount T Bracket

Cat. No.	Description	Std. Pkg. Quantity	UPC Number
H16V18S	Pre-Fab T Bracket	10	785991-04801

Extension Plate Bracket

- Improved bracket with bendable stabilizer leg for use on 2½" and 3½" metal studs
- Mounts outlet boxes 12" or 18" offset from either a metal stud track or a stud
- When mounted, drywall ring is brought to within 1/8" of drywall every time and will not budge or break out drywall
- Mounts 4" or 4 1/16" outlet boxes, 1½" or 2 1/8" deep
- SV18 provides compliance with Americans with Disabilities Act (ADA) requirements



Extension Plate Bracket

Cat. No.	Description	Std. Ctn.
SSF-SV12	Extension plate bracket, 12" height	50
SSF-SV18	Extension plate bracket, 18" height	50

Stud-to-Stud Mounting Brackets

- Constructed of 24-gauge steel
- Pre-measured on center for 16" (SBO16) or 24" (SBO24) stud spacing
- SBO16 accepts three 4" square or two 4¹/₁₆" boxes (deep or shallow)
- SBO24 accepts five 4" square or four 4¹/₁₆" boxes (deep or shallow)
- Can be mounted at any height to meet individual project requirements
- Versatile, open design enables mounting of box in any location across horizontal plane between studs
- Device cover (mud ring) mounts to front of bracket to set box in desired location
- Stamped rule on bracket with 1/4", 1/2", and 1" markings

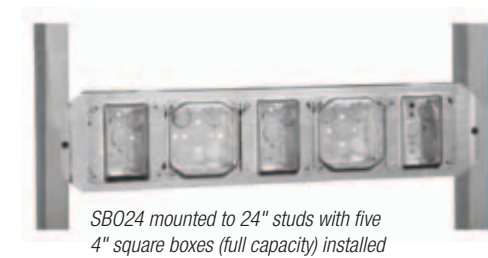
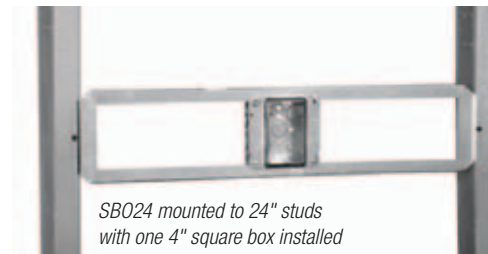
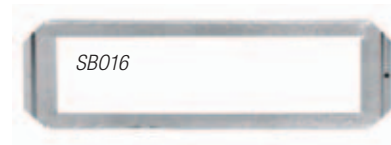

Stud-to-Stud Mounting Brackets

Cat. No.	Description	Std. Pkg. Quantity	UPC Number
SB016	16" Stud-to-Stud Horizontal Mounting Bracket	25	78599103893
SB024	24" Stud-to-Stud Horizontal Mounting Bracket	25	78599103895

Stud-to-Stud Mounting Brackets — Fixed Box Position

- Supports electrical boxes, plaster rings, or low-voltage devices from one bracket
- Accommodates 4" or 4¹/₁₆" boxes
- Bendable leg serves as a bracket stabilizer
- SB brackets allow box mounting in all four 90° orientations



Stud-to-Stud Mounting Brackets — Fixed Box Position

Cat. No.	Description	Std. Ctn.
H16S	Box mounting bracket for between studs, 16" stud spacing	25
H24S	Box mounting bracket for between studs, 24" stud spacing	25

Box-to-Stud Mounting Bracket With Far-Side and Cable Support

Three products in one.

The savings can add up, particularly on a large job, when a box bracket, far-side support, and cable support are combined in one product to reduce your labor and inventory costs. It is designed for maximum flexibility with flanges for either left or right stud mount, and compatibility with both 4" and 4¹/₁₆" boxes.

- Built-in cable support secures cable 6" above the box, satisfying NEC® code requirements
- Flexible design accommodates both 4" and 4¹/₁₆" boxes
- Key-hole box mounting slots maintain box position if mud ring needs to be removed
- Provides clear access to knockouts once the box is installed for installation of fittings
- Mounts to either side of the stud

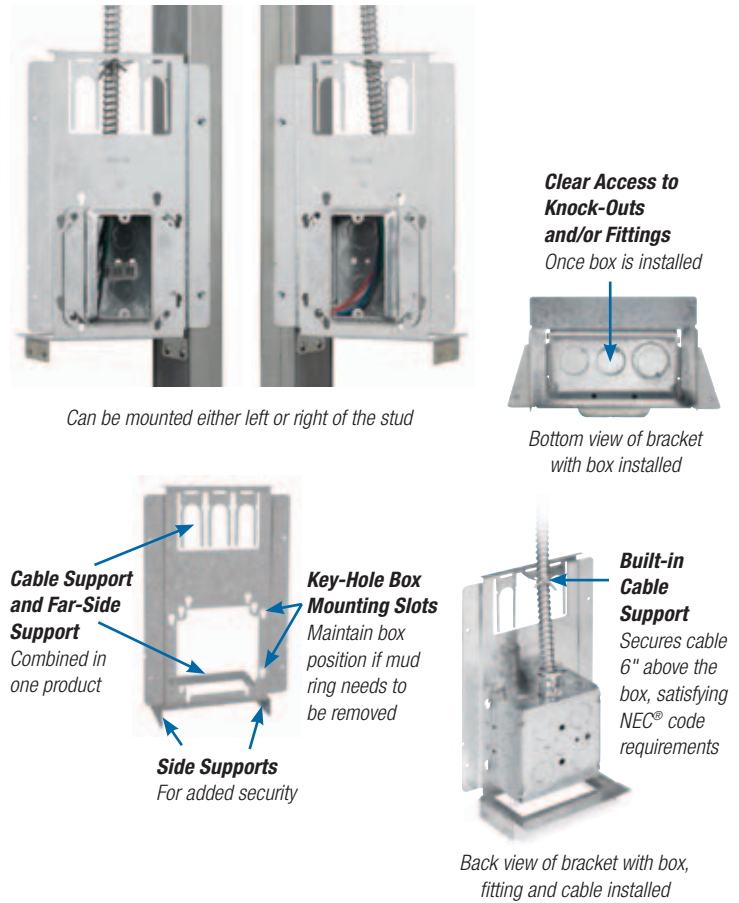

Box-to-Stud Mounting Bracket With Far-Side and Cable Support

Cat. No.	Description	Std. Pkg. Quantity
SSF-SH2346-CS	Pre-Fab Box Bracket with Far-Side and Cable Support	50

Box-to-Stud Mounting Bracket

- Attaches 4" and 4¹/₁₆" electrical boxes to metal stud
- Support leg can be attached to stud to eliminate movement of box in wall
- Attaches to metal or wood stud using self-tapping screws and screw gun or nails
- One part mounts boxes for 1¹/₂", 2¹/₂", 3¹/₂", 4", and 6" studs, which means less inventory

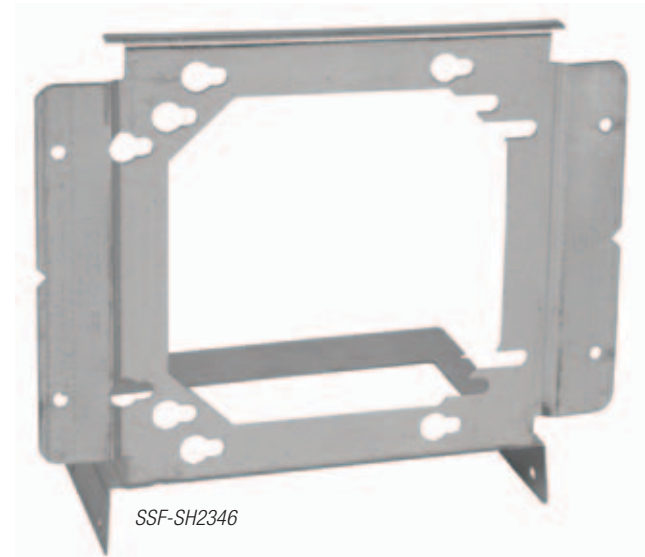
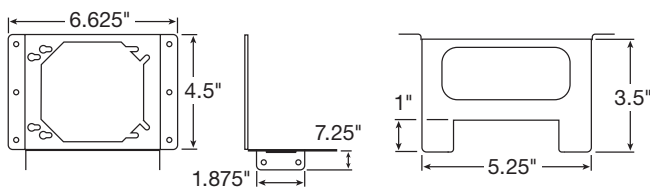

Box-to-Stud Mounting Brackets

Cat. No.	Description	Std. Pkg. Quantity	UPC Number
SSF-SH2346	Bracket for mounting 4" or 4 ¹ / ₁₆ " box to 1 ¹ / ₂ ", 2 ¹ / ₂ ", 3 ¹ / ₂ ", 4", or 6" stud	100	78599120731

Dual Box-to-Stud Mounting Bracket

One component replaces two, reducing both material and labor costs.



Power on both sides of the stud

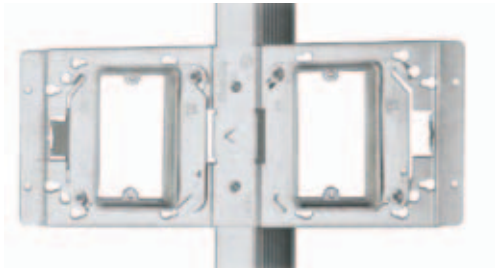

Low voltage on both sides of the stud

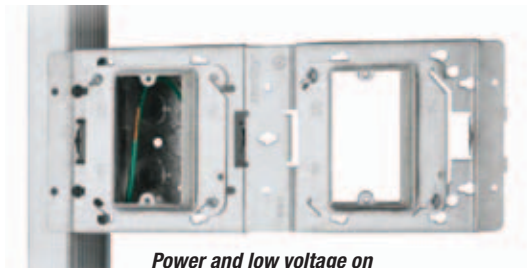

Power and low voltage on the same side of the stud

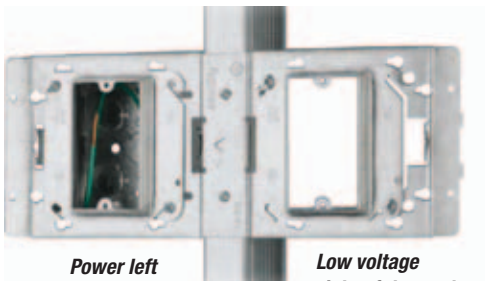

Power left of the stud

Low voltage right of the stud

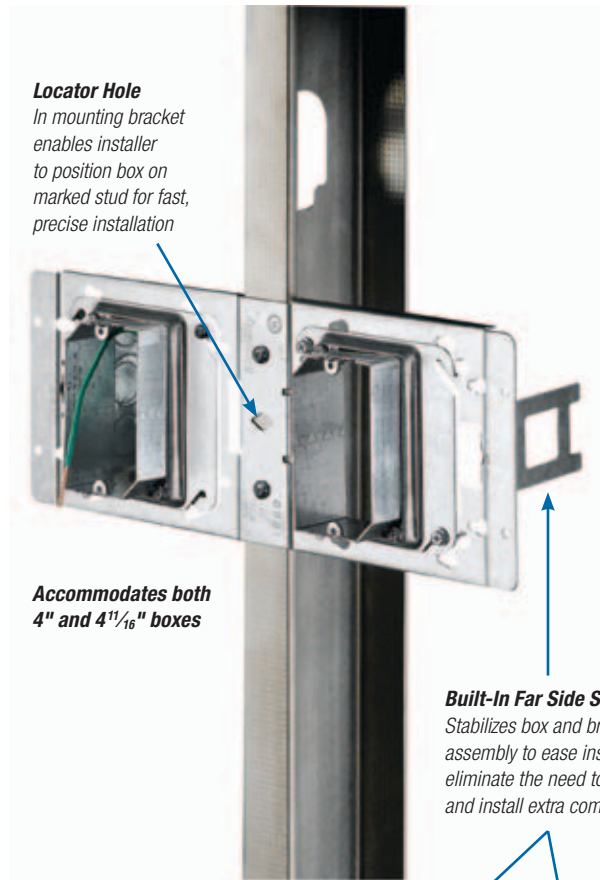

Locator Hole
In mounting bracket enables installer to position box on marked stud for fast, precise installation

Accommodates both 4" and 4¹¹/₁₆" boxes

Built-In Far Side Support
Stabilizes box and bracket assembly to ease installation and eliminate the need to purchase and install extra components



Dual Box-to-Stud Mounting Bracket

Cat. No.	Description	Std. Pkg. Quantity	UPC Number
DBB1	Pre-Fab Dual Box Bracket	50	785991-04625

Box Support Covers

- Combines a box-to-stud mounting bracket with a device cover in one easy-to-use product
- Designed for use with 4" square boxes
- Used with both steel and wood studs
- Cover raised 1/2", 5/8", or 3/4"
- Designed for one or two devices

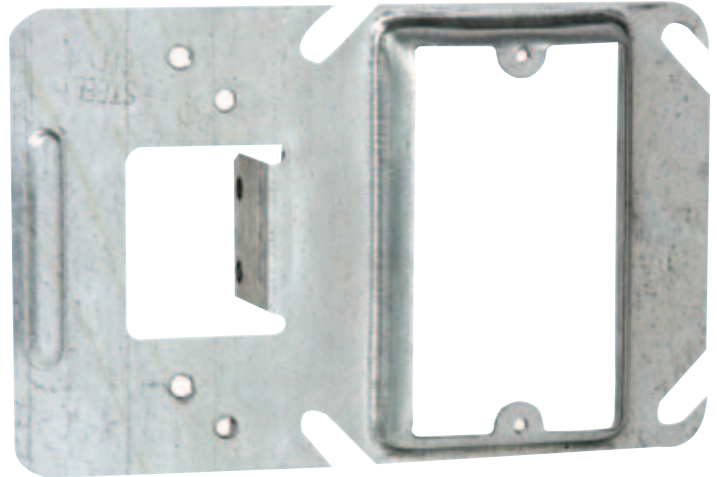

52CM14-5/8



Box Support Covers

Cat. No.	Raised	No. of Devices	Cu. In. Cap.	Std. Pkg. Quantity	UPC Number
52CM13	1/2"	1	3.0	25	78599102634
52CM14-5/8	5/8"	1	4.0	25	78599102635
52CM14	3/4"	1	5.0	25	78599102636
52CMD17	1/2"	2	6.3	25	78599102637
52CMD18-5/8	5/8"	2	7.3	25	78599102638
52CMD18	3/4"	2	9.0	25	78599102639

Adjustable Box Brackets

- Designed for metal studs 16" or 24" on center
- Can also be adjusted for non-standard stud spacing
- Adjustable tabs accommodate 1 1/2" or 2 1/8" box depths
- Enables mounting of multiple boxes
- Installs easily—dimples provide a starting point for screws



SSF-SG16A



Adjustable Box Brackets

Cat. No.	Description	Stud Spacing	Box Depth	Std. Pkg. Quantity	UPC Number
SSF-SG16A	16" Adjustable Box Bracket	11"–18"	1 1/2" or 2 1/8"	50	78599101489
SSF-SG24A	24" Adjustable Box Bracket	17"–26"	1 1/2" or 2 1/8"	50	78599101490

Adjustable Mud Rings

Available in both single- and two-gang.

UL-listed mud rings feature an inner ring that adjusts from $\frac{1}{2}$ " to $1\frac{1}{2}$ " in depth to accommodate various drywall thicknesses. Marked with a measured rule and equipped with two adjustment screws, the inner ring can be set to the anticipated depth prior to installation and then easily adjusted after drywall installation to accommodate any variation in depth ($\frac{1}{2}$ " to $1\frac{1}{2}$ ").

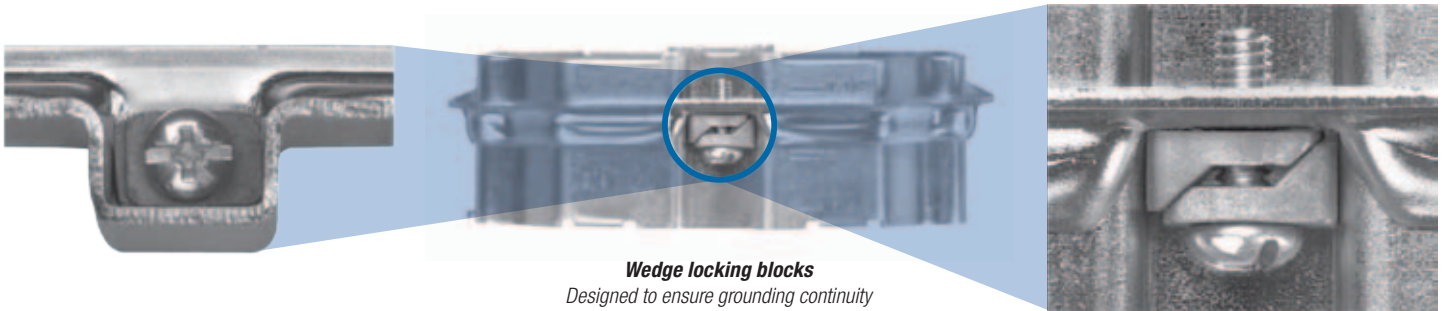

Adjustable Mud Ring Installation/Adjustment Steps:

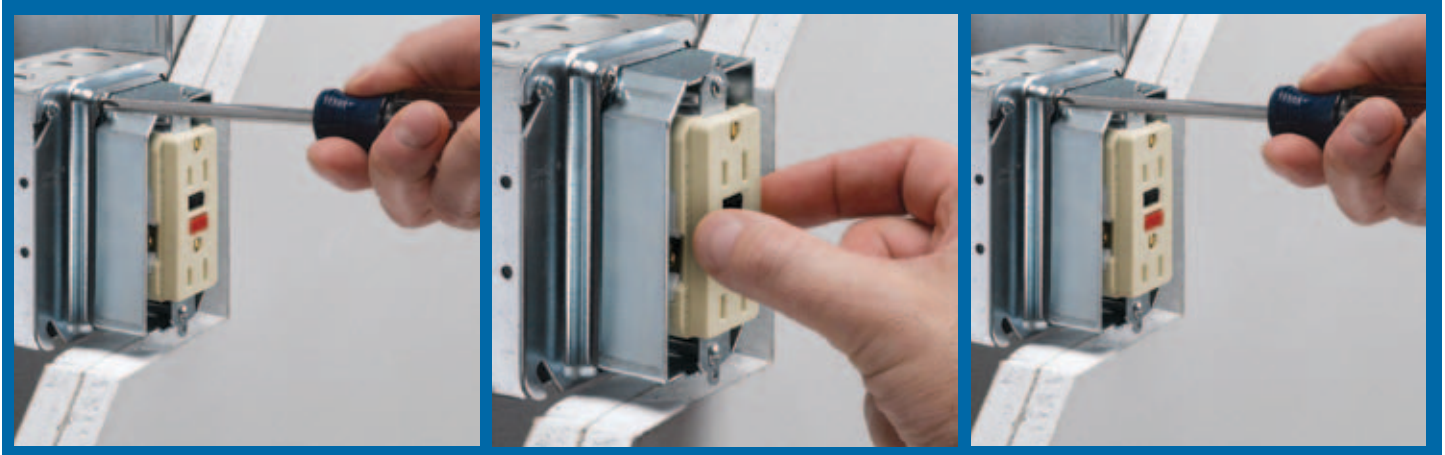

Loosen...

The two adjustment screws located on opposing corners of the mud ring.

Adjust...

Inner ring to be flush with wall surface.

Re-tighten...

Adjustment screws.

Adjustable Mud Ring

Cat. No.	Description	Std. Ctn.
52-C-ADJ	Single-Gang Adjustable Mud Ring, $\frac{1}{2}$ " to $1\frac{1}{2}$ "	25
52-C-ADJ2	Two-Gang Adjustable Mud Ring, $\frac{1}{2}$ " to $1\frac{1}{2}$ "	20

Cable Support Bracket

Meets code requirements for supporting and securing installed MC cable.

- Provides a simple means of complying with NEC® 330.30 requirements for securing and supporting MC cable
- Quick and easy locking tab snaps through slot to secure cable
- Ribs maintain separation of cables
- Durable steel construction retains integrity
- Versatile design—use with Romex or MC cable
- UL listed

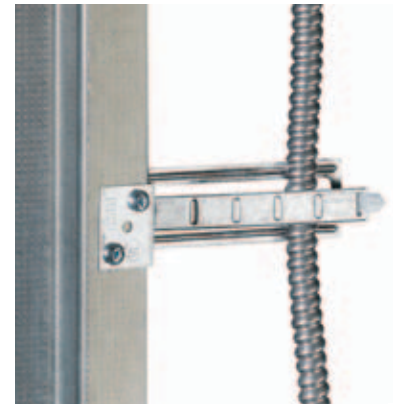
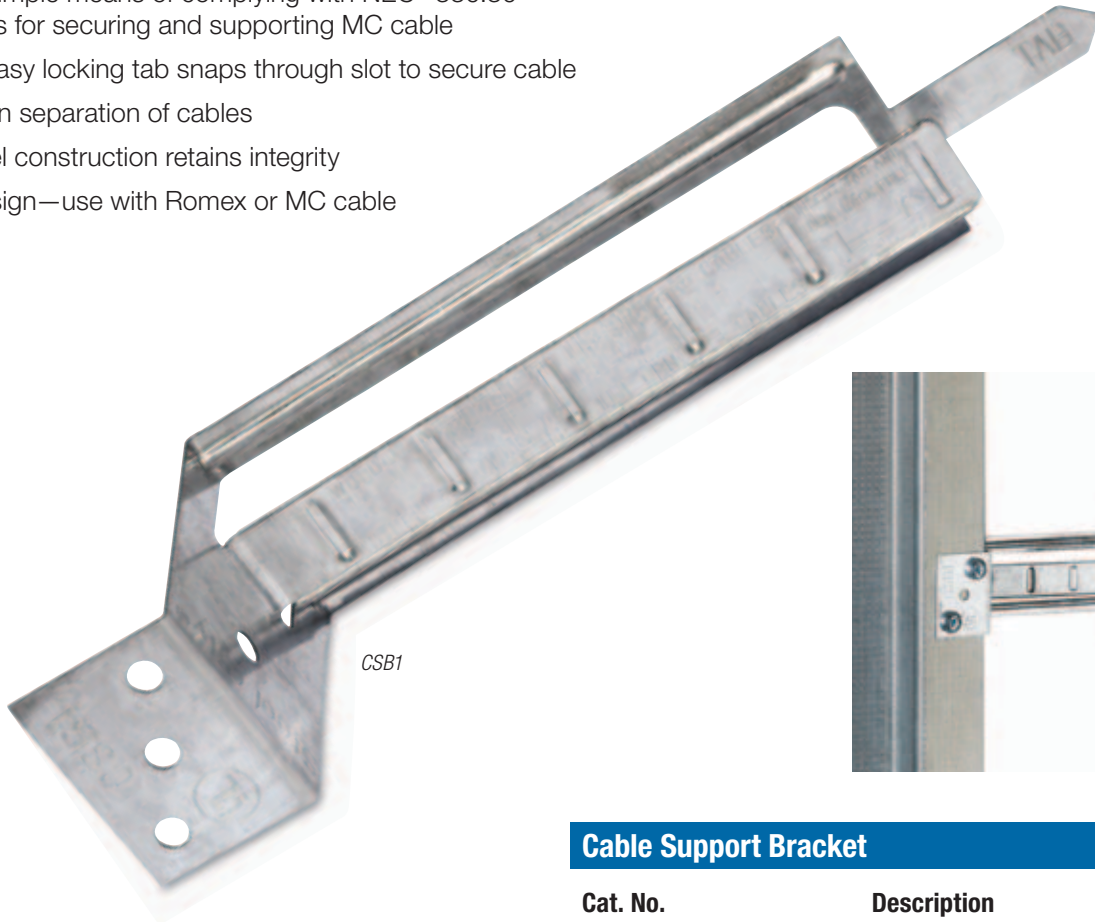

Cable Support Bracket

Cat. No.	Description	Std. Ctn.
CSB1	Cable Support Bracket	100

Screw-On Conduit Support

- Supports ½" and ¾" EMT conduit and MC/AC cable
- Works with wood or metal stud
- Preset bend provides alignment with knockouts for 1½"-deep boxes or 2⅛"-deep boxes

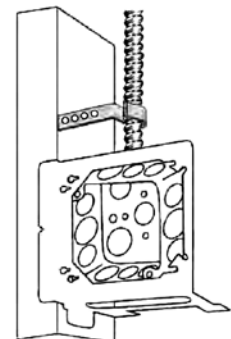
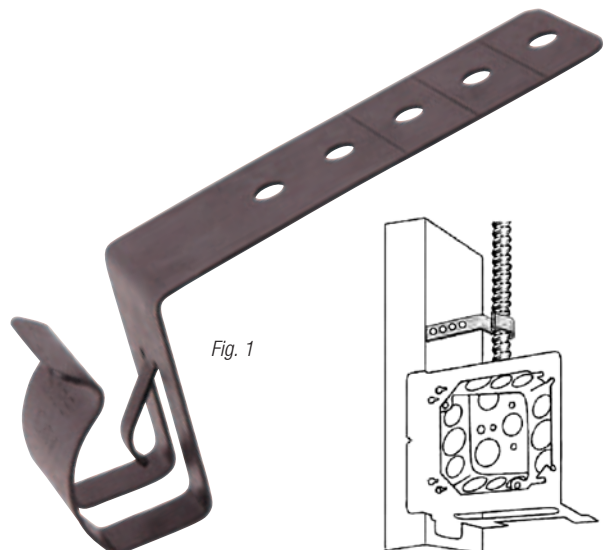

Screw-On Conduit Support

Cat. No.	Fig. No.	Description	Std. Ctn.
SSF-SS1/2 3/4	1	½" and ¾" EMT conduit and MC/AC to metal or wood stud. For 1½" deep box.	100
SSF-SS1/2 3/4D		½" and ¾" EMT conduit and MC/AC to metal or wood stud. For 2⅛" deep box.	100

Steel City® Super Deep 4" Square Wall Boxes

- Increased capacity accommodates large devices in commercial and industrial applications, such as fire alarm systems
- Red-painted version available for quick and easy identification of life-safety electrical systems
- Available with or without integrally mounted support bracket



Super Deep 4" Square Wall Boxes

Cat. No.	Description	Ears	Brkts.	Each Side KO	Each End KO	Bottom KO	Cu. Inch Capacity	Std. Ctn.
521911234RD	3½"-Deep, 4"-Square Red Box	—	—	(4) ½" & ¾" Combo	(2) ½" & ¾" Combo	(4) ½" & ¾" Combo	46	24
521911234CVRD	3½"-Deep, 4"-Square Red Box with Side Mounting Bracket	—	CV	(4) ½" & ¾" Combo	(2) ½" & ¾" Combo	(4) ½" & ¾" Combo	46	10
521911234	3½"-Deep, 4"-Square Box	—	—	(4) ½" & ¾" Combo	(2) ½" & ¾" Combo	(4) ½" & ¾" Combo	46	24
521911234CV	3½"-Deep, 4"-Square Box with Side Mounting Bracket	—	CV	(4) ½" & ¾" Combo	(2) ½" & ¾" Combo	(4) ½" & ¾" Combo	46	10

Fire Alarm Boxes and Fittings

Easy to identify and install.

Steel City® Fire Alarm Boxes and Fittings can meet all of your visual identification requirements for fire alarm systems—and make installation and upgrades faster and easier than ever before. Available in a variety of sizes to accommodate new or old work configurations, these boxes are simple to install with high-quality Thomas & Betts fittings. Plus the bright red finish eliminates time-consuming painting of existing fixtures and provides long-lasting identification in even the harshest environments.



52171-1234RD

72171-1234RD

52171-EXTRD



52-C-1RD



52151-1234RD

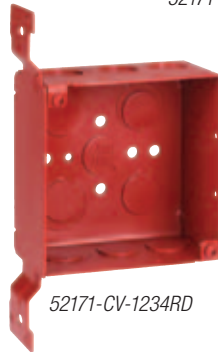

52171-CV-1234RD

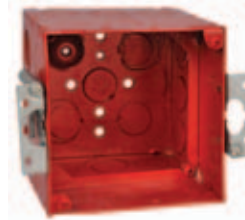

52171-EXTOWRD

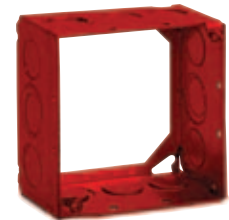

53171-1234RD



Fire Alarm Boxes

Cat. No.	Description	Ears	Brkts.	Each Side Conduit	Each End Conduit	Bottom Conduit	Cu. Inch Capacity	Std. Ctn.
52171-1234RD	2 1/8"-deep 4-square red box	—	—	2 1/2", 1 1/2" & 3/4"E	2 1/2", 1 1/2" & 3/4"E	3 1/2", 2 1/2" & 3/4"E	30.3	50
52151-1234RD	1 1/2"-deep drawn red box	—	—	2 1/2", 1 3/4"	2 1/2", 1 3/4"	3 1/2", 2 3/4"	21.0	50
72171-1234RD	2 1/8"-deep 4 1/16" red box	—	—	3 1/2" & 3/4"E	3 1/2" & 3/4"E	3 1/2", 2 1/2" & 3/4"E	42.0	20
52171-CV-1234RD	2 1/8"-deep 4-square red box with CV bracket	—	CV	2 1/2", 1 1/2" & 3/4"E	2 1/2", 1 1/2" & 3/4"E	3 1/2", 2 1/2" & 3/4"E	30.3	50
52171-EXTRD	2 1/8"-deep 4-square red box with ext. ring	—	—	4 1/2", 2 1/2" & 3/4"E	4 1/2", 2 1/2" & 3/4"E	3 1/2", 2 1/2" & 3/4"E	60.6	25
52171-EXTOWRD	2 1/8"-deep 4-square red box with ext. ring and old work ears	Yes	—	4 1/2", 2 1/2" & 3/4"E	4 1/2", 2 1/2" & 3/4"E	3 1/2", 2 1/2" & 3/4"E	60.6	25
52-C-1RD	Flat 4-square red cover	—	—	—	—	—	—	100
53171-1234RD	2 1/8"-deep 4-square red extension ring	—	—	2 1/2", 1 1/2" & 3/4"E	2 1/2", 1 1/2" & 3/4"E	—	30.3	25



TK122A-FA

TK121A-FA

TC122A-FA

TC121A-FA



Fire Alarm Fittings

Cat. No.	Description	Std. Ctn.
TC121A-FA	1/2" Red Steel EMT Set Screw Connector	50
TC122A-FA	3/4" Red Steel EMT Set Screw Connector	50
TC123A-FA	1" Red Steel EMT Set Screw Connector	25
TC721A-FA	1/2" Red Insulated Steel EMT Set Screw Connector	50
TC722A-FA	3/4" Red Insulated Steel EMT Set Screw Connector	50
TC723A-FA	1" Red Insulated Steel EMT Set Screw Connector	25
TK121A-FA	1/2" Red Steel EMT Set Screw Coupling	50
TK122A-FA	3/4" Red Steel EMT Set Screw Coupling	50
TK123A-FA	1" Red Steel EMT Set Screw Coupling	25



eFab Typical Assemblies

How successful projects are put together

Here are some of our most requested preassembled units. Order as is or customize further using the eFab Configurator.

Box With Pre-Installed 10½" Pigtail, Raised Cover, and Vertical Mounting Bracket

- 4" square welded box, 1½" or 2⅛" deep
- Pre-installed 10½" insulated grounding pigtail
- One- or two-device cover, raised ½", ⅝", or ¾"
- 12" (SSF-SV12) or 18" (SSF-SV18) vertical mounting bracket
- Save on labor costs by eliminating multiple installation steps



151-SV18-1458



151-SV12-1458



Box With Pre-Installed 10½" Pigtail, Raised Cover, and Vertical Mounting Bracket

Cat. No.	Box Type Included	Box Depth	Pigtail Included	Box Cover Included	Raised	No. of Devices	Bracket Included	Std. Pkg. Quantity	UPC Number
151-SV12-13	521511234EW	1½"	10½"	52-C-13	½"	1	SSF-SV12	10	78599102601
151-SV12-1458	521511234EW	1½"	10½"	52-C-14-5/8	⅝"	1	SSF-SV12	10	78599102602
151-SV12-14	521511234EW	1½"	10½"	52-C-14	¾"	1	SSF-SV12	10	78599102752
151-SV12-17	521511234EW	1½"	10½"	52-C-17-25	½"	2	SSF-SV12	10	78599102754
151-SV12-1858	521511234EW	1½"	10½"	52-C-18-5/8-25	⅝"	2	SSF-SV12	10	78599102756
151-SV12-18	521511234EW	1½"	10½"	52-C-18	¾"	2	SSF-SV12	10	78599102604
171-SV12-13	521711234E	2⅛"	10½"	52-C-13	½"	1	SSF-SV12	10	78599102589
171-SV12-1458	521711234E	2⅛"	10½"	52-C-14-5/8	⅝"	1	SSF-SV12	10	78599102591
171-SV12-14	521711234E	2⅛"	10½"	52-C-14	¾"	1	SSF-SV12	10	78599102590
171-SV12-17	521711234E	2⅛"	10½"	52-C-17-25	½"	2	SSF-SV12	10	78599102770
171-SV12-1858	521711234E	2⅛"	10½"	52-C-18-5/8-25	⅝"	2	SSF-SV12	10	78599102774
171-SV12-18	521711234E	2⅛"	10½"	52-C-18	¾"	2	SSF-SV12	10	78599102772
151-SV18-13	521511234EW	1½"	10½"	52-C-13	½"	1	SSF-SV18	10	78599102606
151-SV18-1458	521511234EW	1½"	10½"	52-C-14-5/8	⅝"	1	SSF-SV18	10	78599102607
151-SV18-14	521511234EW	1½"	10½"	52-C-14	¾"	1	SSF-SV18	10	78599102758
151-SV18-17	521511234EW	1½"	10½"	52-C-17-25	½"	2	SSF-SV18	10	78599102760
151-SV18-1858	521511234EW	1½"	10½"	52-C-18-5/8-25	⅝"	2	SSF-SV18	10	78599102762
151-SV18-18	521511234EW	1½"	10½"	52-C-18	¾"	2	SSF-SV18	10	78599102609
171-SV18-13	521711234E	2⅛"	10½"	52-C-13	½"	1	SSF-SV18	10	78599102593
171-SV18-1458	521711234E	2⅛"	10½"	52-C-14-5/8	⅝"	1	SSF-SV18	10	78599102595
171-SV18-14	521711234E	2⅛"	10½"	52-C-14	¾"	1	SSF-SV18	10	78599102594
171-SV18-17	521711234E	2⅛"	10½"	52-C-17-25	½"	2	SSF-SV18	10	78599102776
171-SV18-1858	521711234E	2⅛"	10½"	52-C-18-5/8-25	⅝"	2	SSF-SV18	10	78599102780
171-SV18-18	521711234E	2⅛"	10½"	52-C-18	¾"	2	SSF-SV18	10	78599102778

Box-to-Stud Mounting Bracket With Far-Side and Cable Support

- Built-in cable support secures cable 6" above the box, satisfying NEC® code requirements
- Flexible design accommodates both 4" and 4¹/₁₆" boxes
- Key-hole box mounting slots maintain box position if mud ring needs to be removed
- Pre-installed 10¹/₂" insulated grounding pigtails
- One- or two-device cover, raised 1/2", 5/8", or 3/4"
- Save on labor costs by eliminating multiple installation steps



Box-to-Stud Mounting Bracket With Far-Side and Cable Support

Cat. No.	Box Type Included	Box Depth	Pigtail Included	Box Cover Included	Raised	No. of Devices	Bracket Included	Std. Pkg. Quantity	UPC Number
151-SH2346-13-CS	521511234EW	1 ¹ / ₂ "	10 ¹ / ₂ "	52-C-13	1/2"	1	SSF-SH2346-CS	10	78599107178
151-SH2346-1458-CS	521511234EW	1 ¹ / ₂ "	10 ¹ / ₂ "	52-C-14-5/8	5/8"	1	SSF-SH2346-CS	10	78599107179
151-SH2346-14-CS	521511234EW	1 ¹ / ₂ "	10 ¹ / ₂ "	52-C-14	3/4"	1	SSF-SH2346-CS	10	78599107180
151-SH2346-17-CS	521511234EW	1 ¹ / ₂ "	10 ¹ / ₂ "	52-C-17-25	1/2"	2	SSF-SH2346-CS	10	78599107181
151-SH2346-1858-CS	521511234EW	1 ¹ / ₂ "	10 ¹ / ₂ "	52-C-18-5/8-25	5/8"	2	SSF-SH2346-CS	10	78599107182
151-SH2346-18-CS	521511234EW	1 ¹ / ₂ "	10 ¹ / ₂ "	52-C-18	3/4"	2	SSF-SH2346-CS	10	78599107183
171-SH2346-13-CS	521711234E	2 ¹ / ₈ "	10 ¹ / ₂ "	52-C-13	1/2"	1	SSF-SH2346-CS	10	78599107184
171-SH2346-1458-CS	521711234E	2 ¹ / ₈ "	10 ¹ / ₂ "	52-C-14-5/8	5/8"	1	SSF-SH2346-CS	10	78599107186
171-SH2346-14-CS	521711234E	2 ¹ / ₈ "	10 ¹ / ₂ "	52-C-14	3/4"	1	SSF-SH2346-CS	10	78599107187
171-SH2346-17-CS	521711234E	2 ¹ / ₈ "	10 ¹ / ₂ "	52-C-17-25	1/2"	2	SSF-SH2346-CS	10	78599107188
171-SH2346-1858-CS	521711234E	2 ¹ / ₈ "	10 ¹ / ₂ "	52-C-18-5/8-25	5/8"	2	SSF-SH2346-CS	10	78599107189
171-SH2346-18-CS	521711234E	2 ¹ / ₈ "	10 ¹ / ₂ "	52-C-18	3/4"	2	SSF-SH2346-CS	10	78599107191

Box With Pre-Installed 10½" Pigtail, Raised Cover, and Box-to-Stud Bracket

- 4" square welded box, 1½" or 2⅛" deep
- Pre-installed 10½" insulated grounding pigtail
- One- or two-device cover, raised ½", ⅝", or ¾"
- SSF-SH2346 box-to-stud mounting bracket
- Save on labor costs by eliminating multiple installation steps

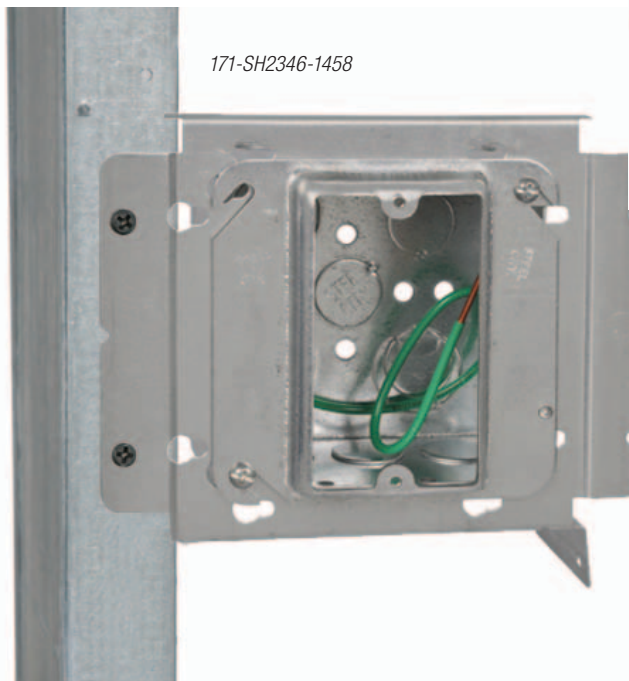

Box With Pre-Installed 10½" Pigtail, Raised Cover, and Box-to-Stud Bracket

Cat. No.	Box Type Included	Box Depth	Pigtail Included	Box Cover Included	Raised	No. of Devices	Bracket Included	Std. Pkg. Quantity	UPC Number
*151-SH2346-13	521511234EW	1½"	10½"	52-C-13	½"	1	SSF-SH2346	10	78599102611
*151-SH2346-1458	521511234EW	1½"	10½"	52-C-14-5/8	⅝"	1	SSF-SH2346	10	78599102612
*151-SH2346-14	521511234EW	1½"	10½"	52-C-14	¾"	1	SSF-SH2346	10	78599102746
*151-SH2346-17	521511234EW	1½"	10½"	52-C-17-25	½"	2	SSF-SH2346	10	78599102748
*151-SH2346-1858	521511234EW	1½"	10½"	52-C-18-5/8-25	⅝"	2	SSF-SH2346	10	78599102810
*151-SH2346-18	521511234EW	1½"	10½"	52-C-18	¾"	2	SSF-SH2346	10	78599102614
171-SH2346-13	521711234E	2⅛"	10½"	52-C-13	½"	1	SSF-SH2346	10	8599102597
171-SH2346-1458	521711234E	2⅛"	10½"	52-C-14-5/8	⅝"	1	SSF-SH2346	10	78599102599
171-SH2346-14	521711234E	2⅛"	10½"	52-C-14	¾"	1	SSF-SH2346	10	78599102598
171-SH2346-17	521711234E	2⅛"	10½"	52-C-17-25	½"	2	SSF-SH2346	10	78599102764
171-SH2346-1858	521711234E	2⅛"	10½"	52-C-18-5/8-25	⅝"	2	SSF-SH2346	10	78599102812
171-SH2346-18	521711234E	2⅛"	10½"	52-C-18	¾"	2	SSF-SH2346	10	78599102766

* ¾" K/O not usable in shallow box.

Box With Pre-Installed 10½" Pigtail and Box Support Cover

- 4" square welded box, 1½" or 2⅛" deep
- Pre-installed 10½" insulated grounding pigtail
- Box support cover combines box-to-stud mounting bracket with device cover
- One- or two-device box support cover, raised ½", ⅝", or ¾"
- Save on labor costs by eliminating multiple installation steps

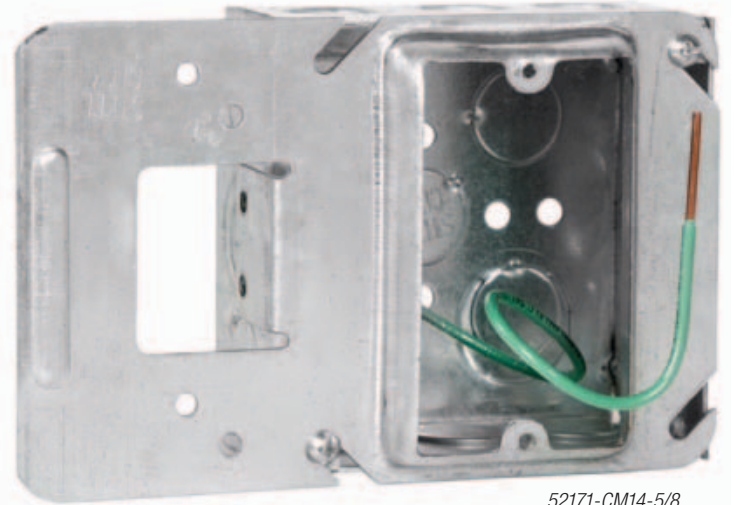

52171-CM14-5/8

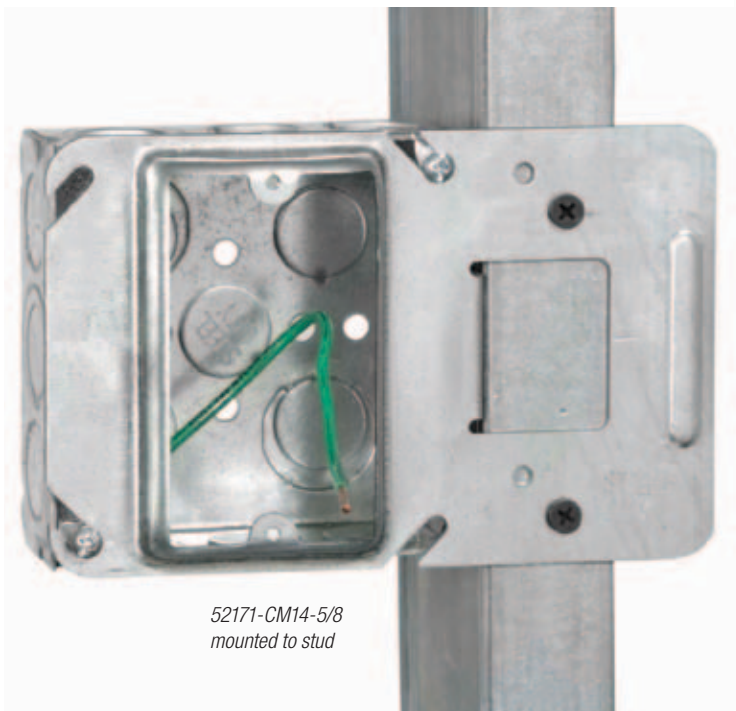
52171-CM14-5/8
mounted to stud

Box With Pre-Installed 10½" Pigtail and Box Support Cover

Cat. No.	Box Type Included	Box Depth	Pigtail Included	Box Cover Included	Raised	No. of Devices	Std. Pkg. Quantity	UPC Number
52151-CM13	521511234EW	1½"	10½"	52CM13	½"	1	25	78599102712
52151-CM14-5/8	521511234EW	1½"	10½"	52CM14-5/8	⅝"	1	25	78599102714
52151-CM14	521511234EW	1½"	10½"	52CM14	¾"	1	25	78599102716
52151-CMD17	521511234EW	1½"	10½"	52CMD17	½"	2	25	78599102718
52151-CMD18-5/8	521511234EW	1½"	10½"	52CMD18-5/8	⅝"	2	25	78599102720
52151-CMD18	521511234EW	1½"	10½"	52CMD18	¾"	2	25	78599102722
52171-CM13	521711234E	2⅛"	10½"	52CM13	½"	1	25	78599102700
52171-CM14-5/8	521711234E	2⅛"	10½"	52CM14-5/8	⅝"	1	25	78599102702
52171-CM14	521711234E	2⅛"	10½"	52CM14	¾"	1	25	78599102704
52171-CMD17	521711234E	2⅛"	10½"	52CMD17	½"	2	25	78599102706
52171-CMD18-5/8	521711234E	2⅛"	10½"	52CMD18-5/8	⅝"	2	25	78599102708
52171-CMD18	521711234E	2⅛"	10½"	52CMD18	¾"	2	25	78599102710

MS Series Pre-Assemblies

- 4" square and 4¹/₁₆" square boxes
- 1¹/₂" deep or 2¹/₈" deep
- Pre-installed 10¹/₂" insulated grounding pigtail
- Available with conduit KOs or clamps for flexible/armored/MC cable
- Save on labor costs by eliminating multiple installation steps

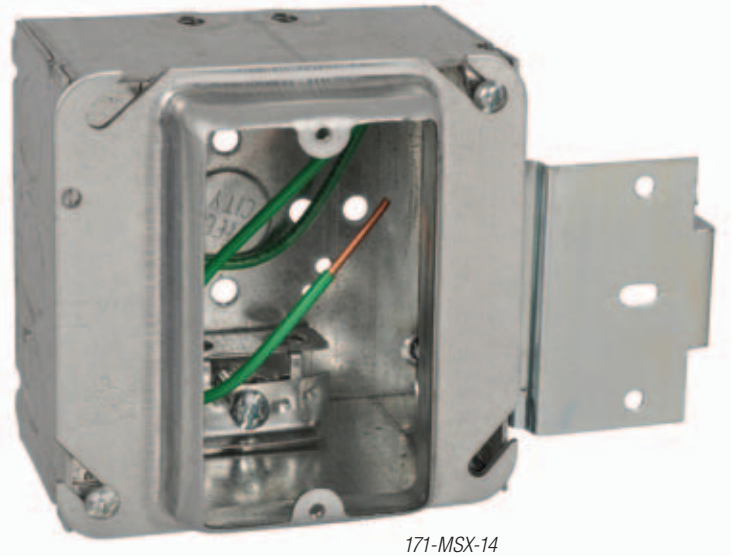

171-MSX-14



MS Series Pre-Assemblies

Cat. No.	Box Type Included	Box Depth	Pigtail Included	Box Cover Included	Raised	No. of Devices	Std. Ctn.
151-MS-13	52151-MS-1/2 3/4	1 ¹ / ₂ "	10 ¹ / ₂ "	52-C-13	1/2"	1	25
151-MS-14	52151-MS-1/2 3/4	1 ¹ / ₂ "	10 ¹ / ₂ "	52-C-14	3/4"	1	25
151-MS-1458	52151-MS-1/2 3/4	1 ¹ / ₂ "	10 ¹ / ₂ "	52-C-14-5/8	5/8"	1	25
171MS13	52171-MS-1/2 3/4	2 ¹ / ₈ "	10 ¹ / ₂ "	52-C-13	1/2"	1	25
171-MS-14	52171-MS-1/2 3/4	2 ¹ / ₈ "	10 ¹ / ₂ "	52-C-14	3/4"	1	25
171-MS-1458	52171-MS-1/2 3/4	2 ¹ / ₈ "	10 ¹ / ₂ "	52-C-14-5/8	5/8"	1	25
171MS18	52171-MS-1/2 3/4	2 ¹ / ₈ "	10 ¹ / ₂ "	52-C-18	3/4"	2	25
171-MS-18 5/8	52171-MS-1/2 3/4	2 ¹ / ₈ "	10 ¹ / ₂ "	52-C-18-5/8-25	5/8"	2	25
171MSX13	52171-MSX	2 ¹ / ₈ "	10 ¹ / ₂ "	52-C-13	1/2"	1	25
171-MSX-14	52171-MSX	2 ¹ / ₈ "	10 ¹ / ₂ "	52-C-14	3/4"	1	25
171-MSX-1458	52171-MSX	2 ¹ / ₈ "	10 ¹ / ₂ "	52-C-14-5/8	5/8"	1	25
171MSX18	52171-MSX	2 ¹ / ₈ "	10 ¹ / ₂ "	52-C-18	3/4"	2	25
171-MSX-18 5/8	52171-MSX	2 ¹ / ₈ "	10 ¹ / ₂ "	52-C-18-5/8-25	5/8"	2	25
72171MS14	72171-MS-1/2 3/4	2 ¹ / ₈ "	10 ¹ / ₂ "	72-C-14	3/4"	1	25
72171-MS-1458	72171-MS-1/2 3/4	2 ¹ / ₈ "	10 ¹ / ₂ "	72-C-14-5/8	5/8"	1	25
72171MS18	72171-MS-1/2 3/4	2 ¹ / ₈ "	10 ¹ / ₂ "	72-C-18	3/4"	2	25
72171-MS-18 5/8	72171-MS-1/2 3/4	2 ¹ / ₈ "	10 ¹ / ₂ "	72-C-18-5/8	5/8"	2	25
72171MSX14	72171-MS-1/2 3/4	2 ¹ / ₈ "	10 ¹ / ₂ "	72-C-14	3/4"	1	25
72171-MSX-1458	72171-MSX	2 ¹ / ₈ "	10 ¹ / ₂ "	72-C-14-5/8	5/8"	1	25
72171MSX18	72171-MS-1/2 3/4	2 ¹ / ₈ "	10 ¹ / ₂ "	72-C-18	3/4"	2	25
72171-MSX-1858	72171-MS-1/2 3/4	2 ¹ / ₈ "	10 ¹ / ₂ "	72-C-18-5/8	5/8"	2	25

Box With Pre-Installed 10½" Pigtail

- Popular 4" square boxes and switch boxes
- Pre-installed 10½" insulated grounding pigtails
- Save on labor costs by eliminating multiple installation steps

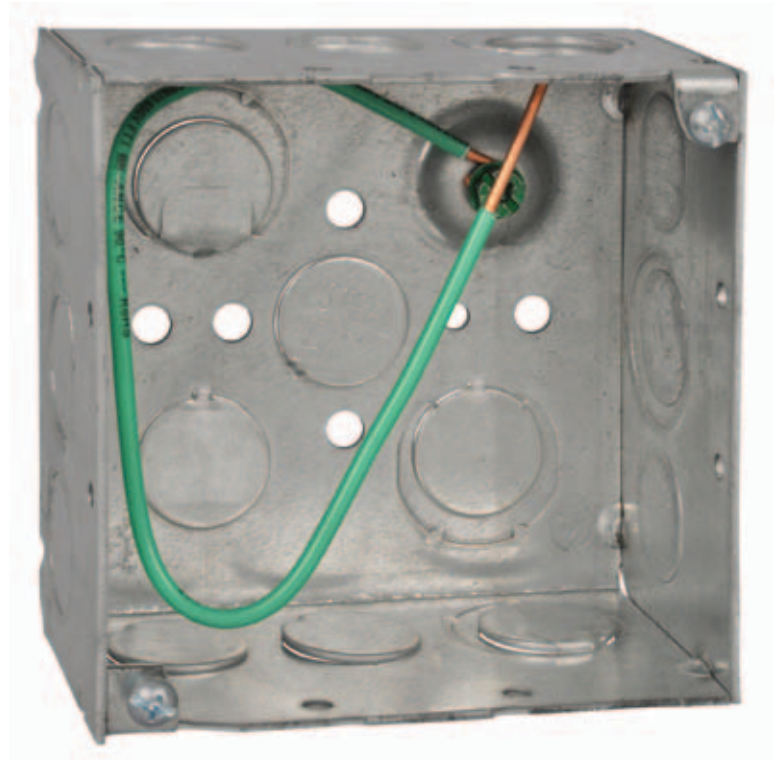

521711234EP



Box With Pre-Installed 10½" Pigtail

Cat. No.	Box Type Included	Knockouts	Pre-Installed Pigtail	Std. Pkg. Quantity	UPC Number
521511234EWP	52151234EW 4"-sq. x 1½"D Welded Box	Eccentric	10½"	50	78599102588
521511234P	521511234 4"-sq. x 1½"D Drawn Box	½" & ¾"	10½"	50	78599102586
521711234EP	521711234E 4"-sq. x 2½"D Welded Box	½" & ¾" Eccentric	10½"	50	78599102587
52151XP	52151X 4"-sq. x 1½"D Welded Box	½" & ¾" Eccentric	10½"	50	78599102724
52151CVNP	52151CVN 4"-sq. x 1½"D Welded Box	½" & ¾" Eccentric	10½"	25	78599102728
LXWOWP	LXWOW-25 3"H x 2"W x 2½"D Gangable Switch Box	½"	10½"	25	78599102959
LXVP	LXV-25 3"H x 2"W x 2½"D Gangable Switch Box	½"	10½"	25	78599102692
CXWOWP	CXWOW 3"H x 2"W x 3½"D Gangable Switch Box	½" & ¾"	10½"	25	78599102694
CXWVP	CXWV 3"H x 2"W x 3½"D Gangable Switch Box	½" & ¾"	10½"	25	78599102696
CXP	CX 3"H x 2"W x 3½"D Gangable Switch Box	½" & ¾"	10½"	25	78599102698



eFabTM
by Thomas & Betts

Online. On-site. On time. On the money.

tnb.com/SteelCityeFab

Visit the T&B world of electrical product solutions

Visit our website for more information about Thomas & Betts solutions and our newest products. For a user-friendly catalog and competitive part-number search, application and technical support, and other useful information, go to tnb.com.

Industry codes and specifications

All Thomas & Betts products for use in commercial and institutional facilities meet or exceed applicable industry specifications or codes, which are detailed in the appropriate T&B product literature.



Online CAD library

Thomas & Betts offers free download of two- and three-dimensional CAD models of many of its products in more than 90 native CAD formats at tnb.com/cadlibrary.



American Recovery and Reinvestment Act (ARRA)

Get certification for compliant products online at tnb.com/ARRA.

United States

Thomas & Betts Corporation Electrical Division Headquarters

8155 T&B Boulevard
Memphis, TN 38125
Phone: 901.252.5000
Fax: 901.252.1354

**Technical Services:
888.862.3289**

**Customer Service:
1.800.816.7809
elec_custserv@tnb.com**

Canada

Thomas & Betts Ltd

700 Thomas Avenue
Saint-Jean-sur-Richelieu, Quebec
J2X 2M9
Phone: 450.347.5318
Fax: 450.347.1976
mrkt.canada@tnb.com

Europe/Middle East/ Africa

Thomas & Betts Europe Centre

200 Chaussee de Waterloo
B-1640 Rhode-St-Genese
Belgium
Phone: +32.235.98200
europe_inquiry@tnb.com

Thomas & Betts Corporation

8155 T&B Boulevard
Memphis, TN 38125
Phone: 901.252.5000

www.tnb.com

Asia Pacific

Thomas & Betts Adia Pte Ltd

10 Ang Mo Kio
Street 65
#06-07 Techpoint
Singapore 569059
Phone: +65.6720.8828
Fax: +65.6720.8780
asia_inquiry@tnb.com

Australasia

Thomas & Betts Australasia Pty Ltd

Unit D3, Lidcombe Business Park
3-29 Birnie Avenue
Lidcombe NSW 2141 Australia
Phone: +61 2 8754 2700
Fax: +61 2 8754 2735



tnb.com/SteelCityFab

Thomas & Betts

A Member of the ABB Group