



AmbiStar

AMBISTAR ELE BALLAST (2) F40T12 120V

Ambistar electronic ballasts are an easy-to-install, energy-efficient replacement solution for optimizing residential and hospitality lighting.

Product data

General Information	
Lamp Type	F40T12
Number of Lamps	1/2 piece/unit
Ballast Type	Electronic Fluorescent
Base Model	REL-B2540N
Suitable For Outdoor Use	Yes
Automatic Restart	Yes
Operating and Electrical	
Input Voltage	120 V
Input Frequency	60 Hz
Total Harmonic Distortion USA	20 %
Ignition Method	Rapid Start
Crestfactor (Nom)	1.7
Ignition Time (Nom)	1 s
Ballast Factor (Nom)	0.85
Power Factor (Nom)	0.98
Input Current (Nom)	0.62 A
Input Power (Nom)	72 W
Rated Lamp Power	40 W
Wiring	
Color Input Terminals	No terminals
Color Output Terminals	No terminals
Wire Striplength	0.50/0.375 mm

Lamp Connection	Series
Wire Length by Color	See data sheet
Wire Gauge (Nom)	18AWG mm
Wire Type	Solid
Remote Wiring Configuration Allowed	Yes
Tandem Wiring Configuration Allowed	Yes
Through Wiring Configuration Allowed	Yes
Max Ballast-Lamp Distance Remote Wiring	20'
Max Ballast-Lamp Distance Tandem Wiring	Red = 10'
Max Ballast-Lamp Distance Through Wiring	Red = 10'
Connector Type	No connector
Temperature	
T-Case Maximum (Nom)	70 °C
Mechanical and Housing	
Housing Material	Metal
Housing	N
Housing Dimensions	9.5" x 1.3" x 1.0"
Approval and Application	
EMC Immunity Standard	FCC Consumer
Approval Marks	CSA certificate UL certificate CEC Listing Circle E logo CSA E DOE Energy Star RoHS Compliant

Hum And Noise Level	A
UL Recognized	No
Product Data	
Order product name	AMBISTAR ELE BALLAST (2) F40T12 120V
EAN/UPC - Product	781087090428
Order code	913701218101

Numerator - Quantity Per Pack	1
Numerator - Packs per outer box	10
Material Nr. (12NC)	913701218101
Net Weight (Piece)	331.000 g

Dimensional drawing

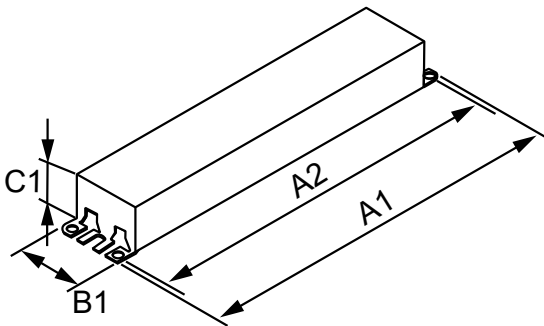

ELE BALLAST (2) F40T12 120V

Product	A1	A2	B1	C1
AMBISTAR ELE BALLAST (2) F40T12 120V	9.50 in	8.90 in	1.30 in	1.00 in

