

## Pico Wireless Control (for North, Central, and South America)

The Pico wireless control is a flexible and easy to use device that allows the user to control Lutron wireless load-control devices from anywhere in the space. This battery-operated control requires no external power or communication wiring.

### Features

- Provides control for the following:
  - Caséta Wireless controls
  - Energi Savr Node, Quantum, and myRoom systems, through the use of a QS sensor module (QSM)
  - Vive systems, including:
    - Maestro Wireless controls
    - PowPak modules
  - GRAFIK Eye QS wireless systems
  - HomeWorks QS wireless systems
  - Maestro Wireless controls
  - PowPak modules
  - RadioRA 2 systems
  - Serena RF remote control shades
  - Sivoia QS wireless systems
- Control available in a variety of button marking options.
- Control available in Gloss and Satin Colors finishes.
- Easy reconfiguration for use as:
  - Handheld remote
  - Wall-mount control (with or without faceplate; faceplate adapter kit sold separately)
  - Car visor control (car visor clip sold separately)
  - A table top control (table top pedestal sold separately).
- Battery-powered. Requires no wiring.
- 10 year battery life<sup>2</sup> (one CR2032 battery included).
- Can provide control of blinds, curtains, or lighting devices within a range of 30 ft (9 m) through walls and 60 ft (18 m) line-of-sight.
- BAA-compliant model numbers available in gloss only.

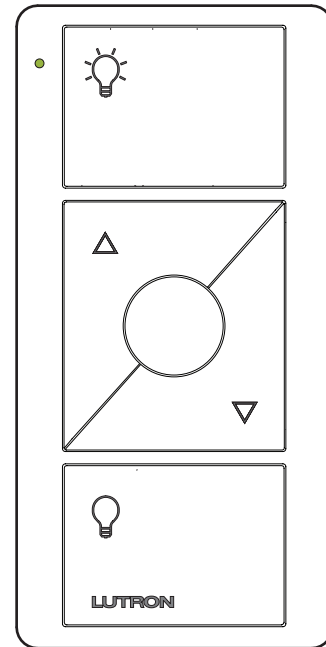

Pico wireless control <sup>1</sup>

<sup>1</sup> Button markings for Lights shown. Shade printing also available.

<sup>2</sup> Based on a 1 year shelf life, an average of 10 button presses per day, and an ambient temperature of 86 °F (30 °C). Actual life may vary based on usage and environmental conditions.

<b>Job Name:</b>	<b>Model Numbers:</b>
<b>Job Number:</b>	

## Specifications

### Regulatory Approvals

- Lutron Quality Systems registered to ISO 9001:2015.
- FCC Certified (U.S.A.)
- IC Certified (Canada)
- COFETEL Certified (Mexico)
- SUTEL Certified (Costa Rica)
- Anatel Certified (Brazil)

### Power

- Operating Voltage 3 V<sub>DC</sub>
- (1) CR2032 Battery (included)

### System Communication and Capacity

- Communicates using Radio Frequency (RF) at 431 MHz to 437 MHz.
- Thousands of system addresses prevent interference between systems.
- Can be assigned to control blinds, curtains or lighting devices that are within a 30 ft (9 m) range.
- Can be configured as a scene or zone control in GRAFIK Eye QS wireless applications.

### Mounting Considerations

- All RF devices should be mounted on nonmetallic surfaces to ensure proper performance.
- If you wish to mount your Pico wireless control to a metallic surface, the PICO-MOUNT-1-XX-CPN6774 will be required in order to maintain proper RF performance. For availability, please contact your local Lutron sales office.

### Environment

- Ambient operating temperature: 32 °F to 140 °F (0 °C to 60 °C)
- Maximum 90% non-condensing relative humidity
- Indoor use only

### Warranty

- 1 Year Limited Warranty  
For additional Warranty information, please visit [www.lutron.com/TechnicalDocumentLibrary/369-119\\_Wallbox\\_Warranty.pdf](http://www.lutron.com/TechnicalDocumentLibrary/369-119_Wallbox_Warranty.pdf)

Job Name:	Model Numbers:
Job Number:	

### Pico Wireless Control Dimensions

Measurements shown as: in (mm)

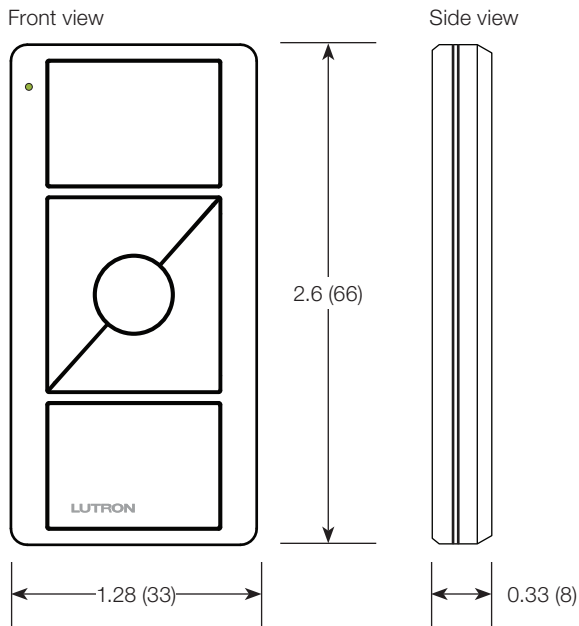

Job Name:	Model Numbers:
Job Number:	

# Operation

## 2 Button Controls (2B)

Lights Models: **L01**

Appliance Model: **L02**

Screens Model: **S08**

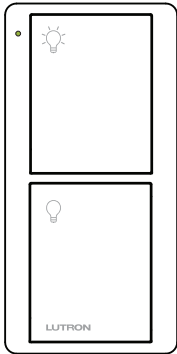

**ON Button**  
Lights go to full intensity.

**OFF Button**  
Lights go to off.

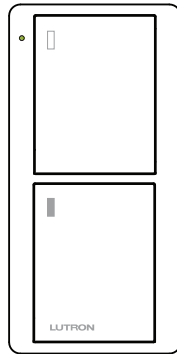

**ON Button**  
Appliance is turned ON.

**OFF Button**  
Appliance is turned OFF.

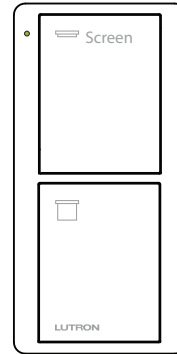

**OPEN Button**  
Screens go to open limit.

**CLOSE Button**  
Screens go to close limit.

## 2 Button Controls with Raise/Lower (2BRL)

Lights Model: **L01**

Shades Model: **S01**

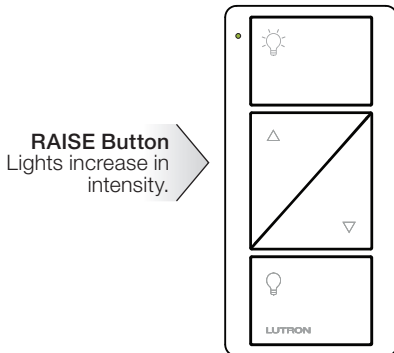

**ON Button**  
Lights brighten to full intensity.

**LOWER Button**  
Lights decrease in intensity.

**OFF Button**  
Lights dim to off.

**RAISE Button**  
Lights increase in intensity.

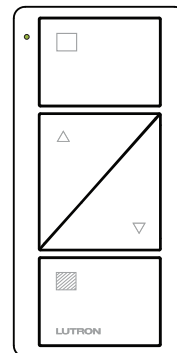

**OPEN Button**  
Shades go to open limit.

**LOWER Button**  
Shades move toward close limit.

**CLOSED Button**  
Shades go to close limit.

**RAISE Button**  
Shades move toward open limit.

(continued on next page...)

Job Name:	Model Numbers:
Job Number:	

Operation (continued)

**3 Button Controls (3B)**

Lights Model: L01

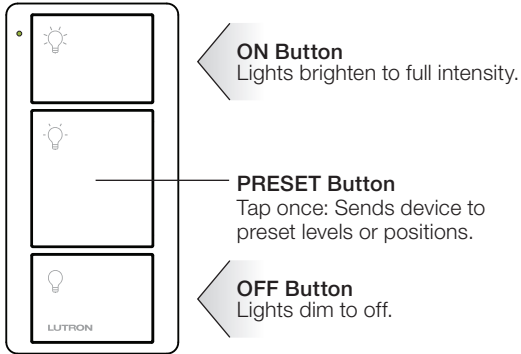

**3 Button Controls with Raise/Lower (3BRL)**

Lights Models: L01

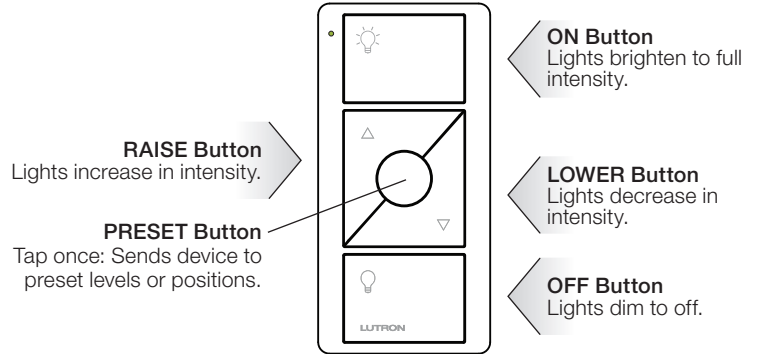

Shades Models: S01, S02, S03, S04, S06, S07

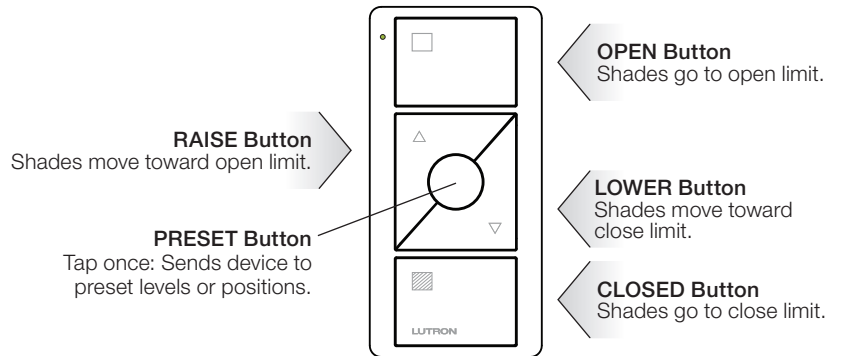

**3 Button Controls with Raise/Lower (3BRL)**

Venetian Blinds/Wood Blinds Model: S05

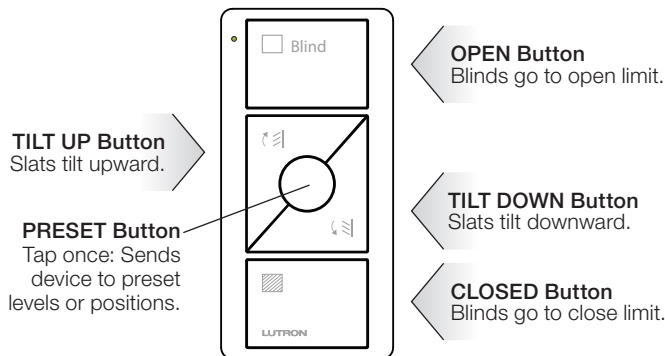

Horizontal Sheer Blinds Model: S09

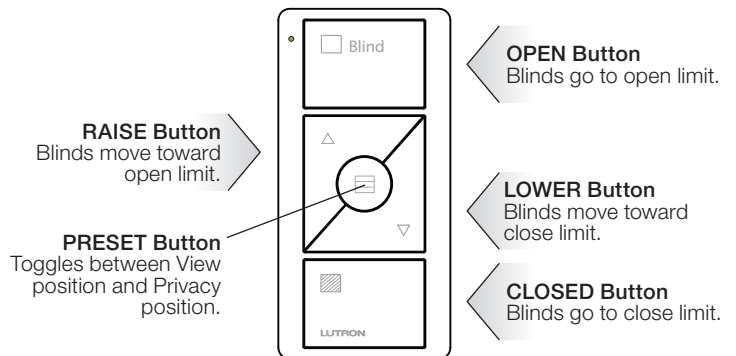

<b>Job Name:</b>	<b>Model Numbers:</b>
<b>Job Number:</b>	

## Pico Wireless Control Model Number

For order quantities of 96 pieces or greater of the same model number, bulk packaging may be available. Mounting hardware is not available with bulk packaging. Contact your local Lutron sales office.

PJ2 – XXXX – XXX – XXX

### Frequency/Channel Code \*

Code	Frequency Range
J	431.0 – 437.0 MHz

Button Marking Code  
(next page)

\* For questions about frequency/channel code compatibility, contact your local Lutron sales office or visit us at [www.lutron.com](http://www.lutron.com)

### Button Configuration Codes

Code	Button Configuration
2B	2 Button
2BRL	2 Button with Raise/Lower
3B	3 Button
3BRL	3 Button with Raise/Lower

### Color/Finish Codes

Color	Finish	
	Gloss	Texture (Satin Colors)
White	GWH	TSW
Black	GBL	TMN
Ivory	GIV	–
Light Almond	GLA	–
Biscuit	–	TBI
White/Gray <sup>1</sup>	GWG	–

<sup>1</sup> Top and Raise buttons are White; Preset, Lower, and Bottom buttons are Gray

(continued on next page...)

<b>Job Name:</b>	<b>Model Numbers:</b>
<b>Job Number:</b>	

Pico Wireless Control Model Number (continued)

PJ2 – XXXX – XXX – XXX

Frequency/  
Channel Code  
(previous page)

Button  
Configuration Code  
(previous page)

Color/Finish  
Code  
(previous page)

Button Marking Codes

2 Button

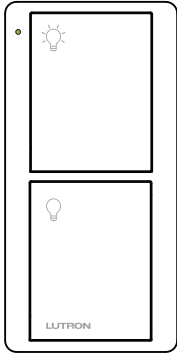

**L01:** Lights  
(icons only)

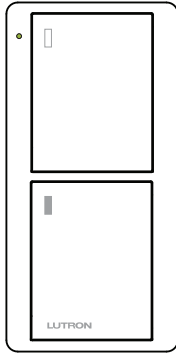

**L02:** Appliances  
(icons only)

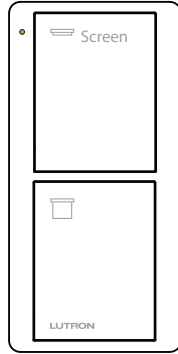

**S08:** Screens  
(icons + text)

2 Button with Raise/Lower

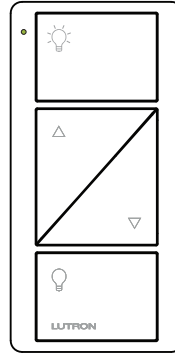

**L01:** Lights  
(icons only)

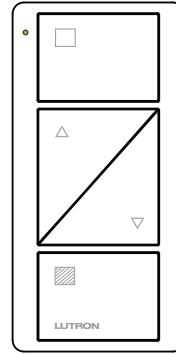

**S01:** Shades  
(icons only)

3 Button

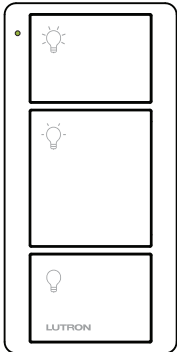

**L01:** Lights  
(icons only)

3 Button with Raise/Lower

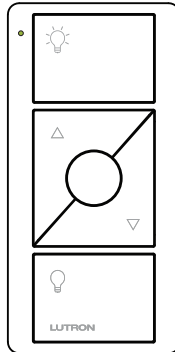

**L01\*:** Lights  
(icons only)

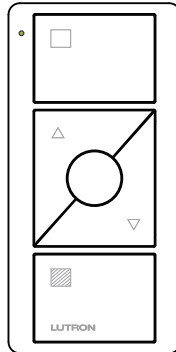

**S01:** Shades  
(icons only)

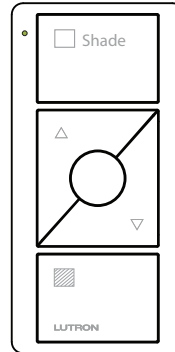

**S02:** Shades  
(icons + text)

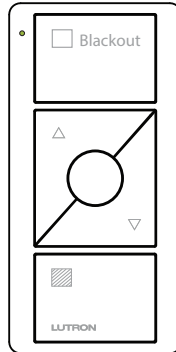

**S03:** Blackouts  
(icons + text)

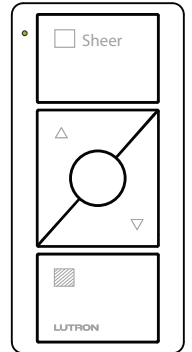

**S04:** Sheers  
(icons + text)

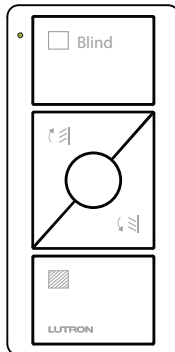

**S05:** Blinds  
(icons + text)

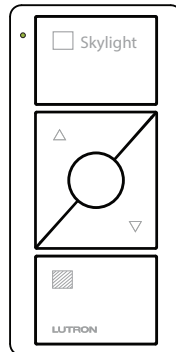

**S06:** Skylights  
(icons + text)

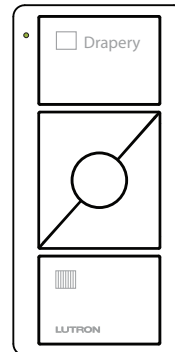

**S07:** Draperies  
(icons + text)

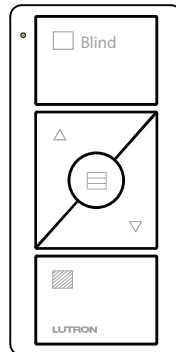

**S09:** Horizontal  
Sheer Blinds  
(icons + text)

\* Add "R" after "L01" in the model number for Caséta wireless retail packaging. Available in Gloss White (WH) or Light Almond (LA).

<b>Job Name:</b>	<b>Model Numbers:</b>
<b>Job Number:</b>	

## Pico Wireless Control Model Number (BAA Compliant)

For order quantities of 96 pieces or greater of the same model number, bulk packaging may be available. Mounting hardware is not available with bulk packaging. Contact your local Lutron sales office.

# UPJ2 – XXXX – XX – L01

### Frequency/Channel Codes\*

Code	Frequency Range
J	431.0 – 437.0 MHz

\* For questions about frequency/channel code compatibility, contact your local Lutron sales office or visit us at [www.lutron.com](http://www.lutron.com)

### Button Configuration Codes

Code	Button Configuration
2B	2 Button
2BRL	2 Button with Raise/Lower
3B	3 Button
3BRL	3 Button with Raise/Lower

### Color Codes

Color	Code
	Gloss <sup>1</sup>
White	WH
Black	BL
Ivory	IV
Light Almond	LA
White/Gray <sup>2</sup>	WG

<sup>1</sup> BAA controls are available in Gloss finish only.

<sup>2</sup> Top and Raise buttons are White; Preset, Lower, and Bottom buttons are Gray

### Button Marking Codes

2 Button

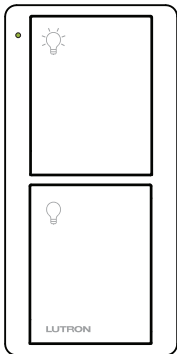

L01: Lights (icons only)

2 Button with Raise/Lower

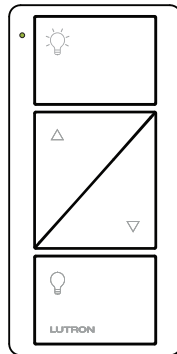

L01: Lights (icons only)

3 Button

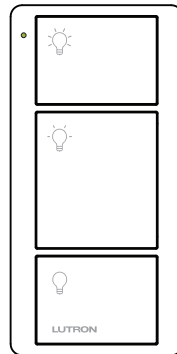

L01: Lights (icons only)

3 Button with Raise/Lower

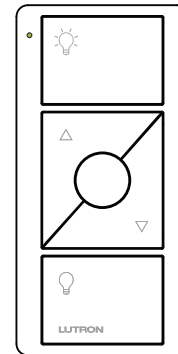

L01: Lights (icons only)

Job Name:	Model Numbers:
Job Number:	



### Pico Pedestal Model Number

Pedestals sold separately. Available in gloss finish only

L – PEDX – XX

#### Capacity Codes

Capacity	Code
Single	1
Double	2
Triple	3

#### Color Codes

Color*	Code
White	WH
Black	BL

\* Available in gloss finish only.

### Pico Pedestal Dimensions

Measurements shown as: in (mm)

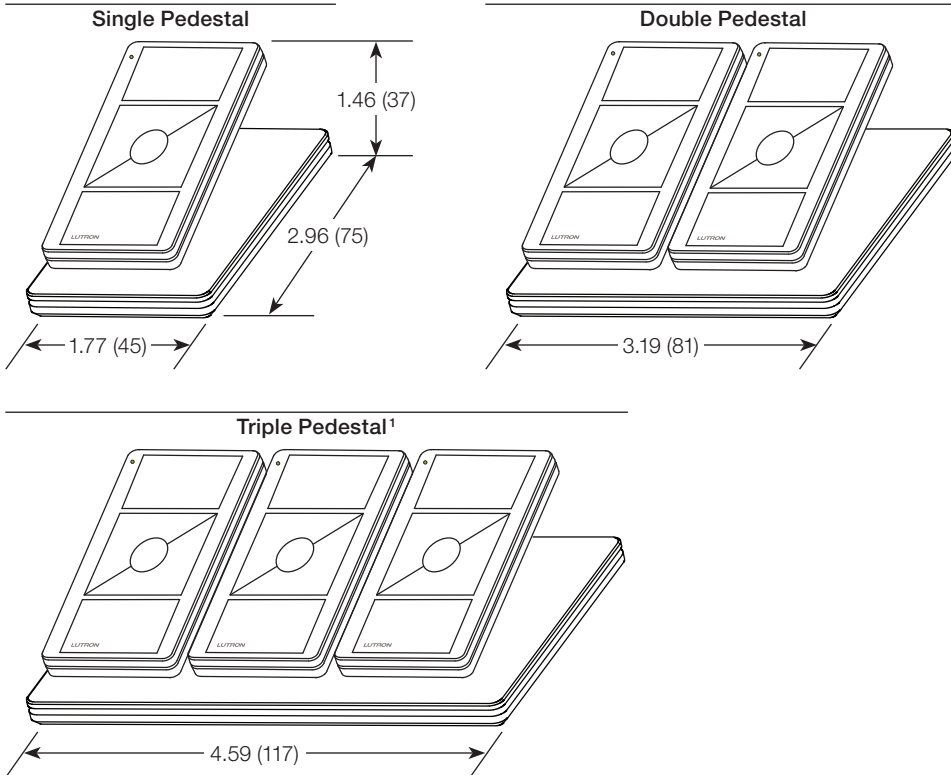

<sup>1</sup> For Triple Pedestals contact your local Lutron sales office or visit us at [www.lutron.com](http://www.lutron.com)

<p><b>Job Name:</b></p>	<p><b>Model Numbers:</b></p>
<p><b>Job Number:</b></p>	

## Mounting Options

### Standalone Mounting

**Adhesive Mounting**  
Included with Pico wireless control

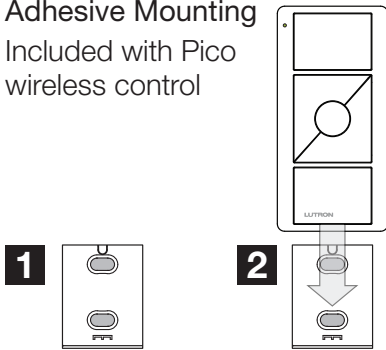

**Screw Mounting**  
Model: PICO-SM-KIT (sold separately)

Kit includes special screws to be used for more permanent mounting and/or for non-smooth surfaces.

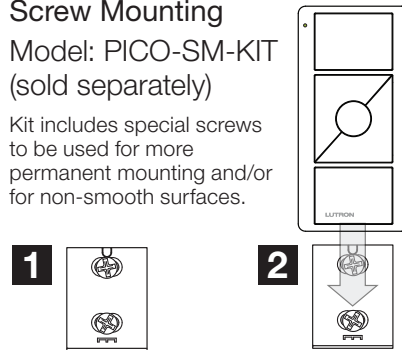

**Metal Surface Mounting**  
Model: PICO-MOUNT-1-XX-CPN6774 (sold separately)

Contact your local Lutron sales office.

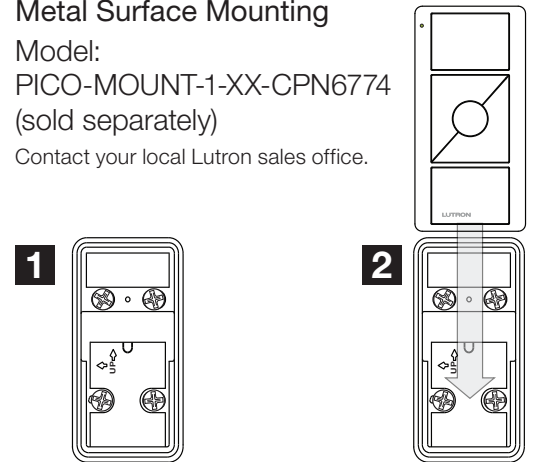

### Wallbox Mounting

**Wallbox Adapter**  
Model: PICO-WBX-ADAPT (sold separately)

Wallplate adapter/wallplate sold separately.

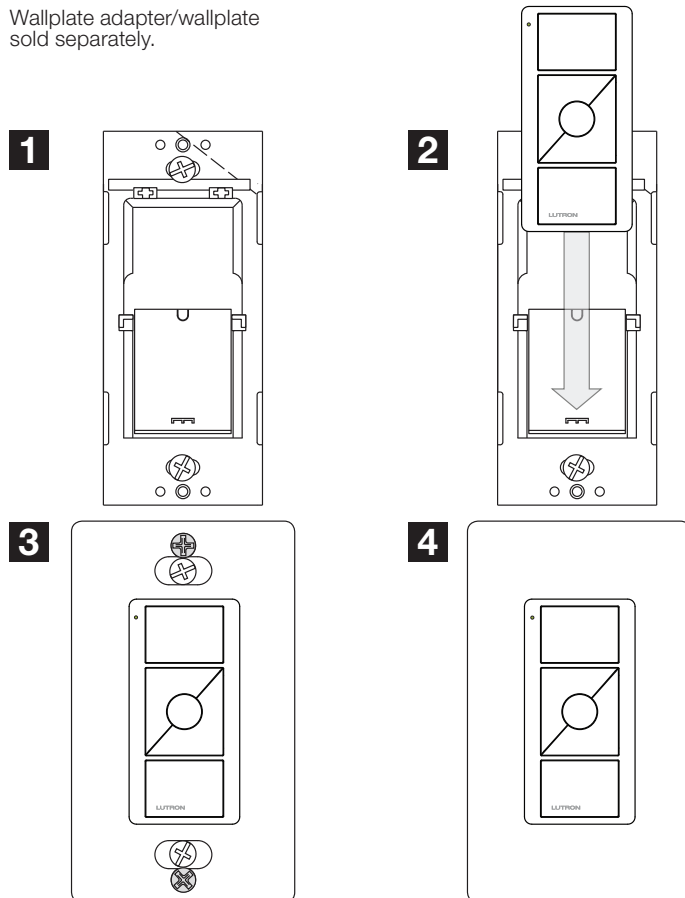

### Surface Mounting Kits

#### Wall-Mounting Kit

Model: PJ2-WALL-WH-L01; PJ2-WALL-WH-L01C\* (sold separately)

Kit includes:

- Pico wireless control
- Claro wallplate (with wallplate adapter)
- Wallbox adapter

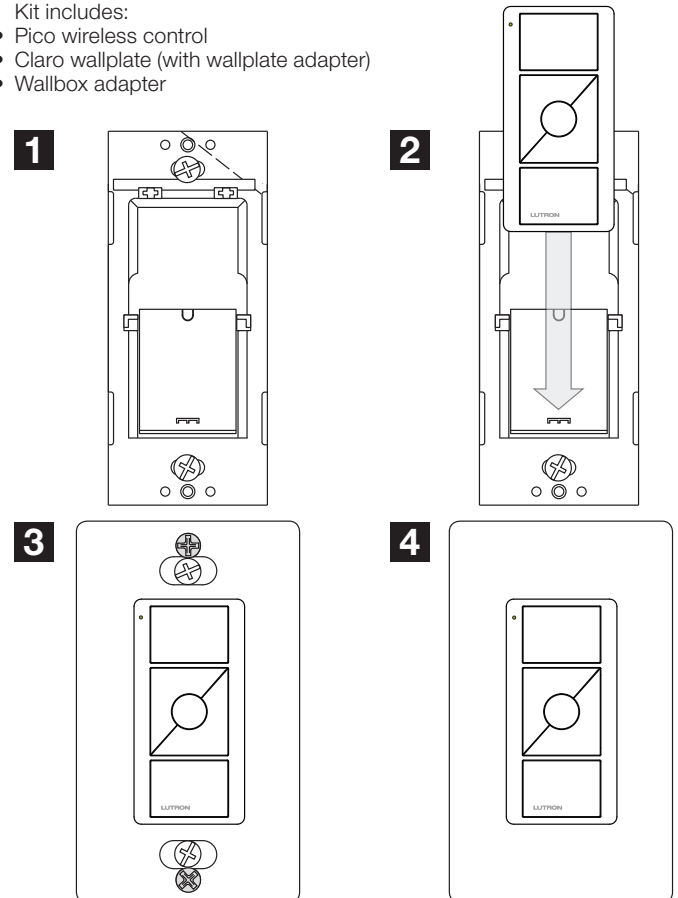

\* Canadian packaged product.

Job Name:	Model Numbers:
Job Number:	

### Mounting Options (continued)

#### Surface Mounting Kits (continued)

##### Wall-Mounting Kit (BAA Compliant)

Model: UPJ2-XXXX-XX-L01  
(sold separately)

Kit includes:

- Pico wireless control
- Wallbox adapter

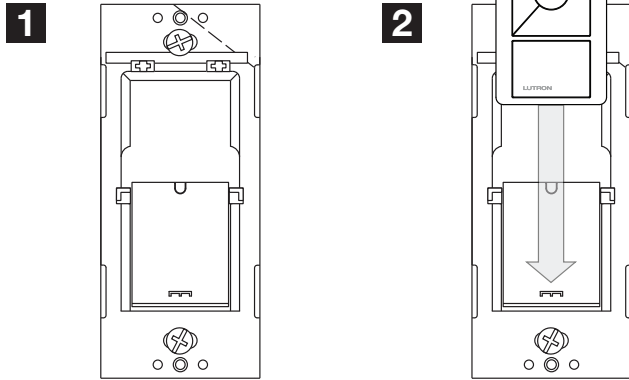

#### Vehicle Mounting

##### Mounting to a Car Visor

Model: PICO-CARVISOR-CL  
(sold separately)

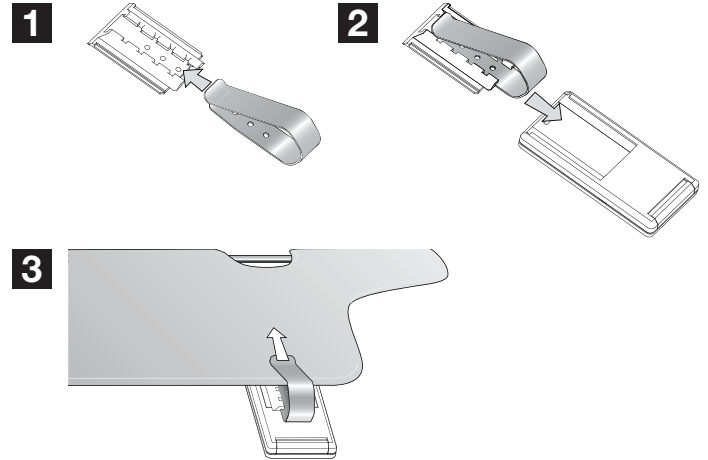

Lutron, Lutron, Pico, Caséta, Quantum, Maestro Wireless, PowPak, GRAFIK Eye, RadioRA, Satin Colors, Serena, Sivoia, HomeWorks and Claro are trademarks of Lutron Electronics Co., Inc. registered in the U.S. and other countries.

myRoom, Energi Savr Node, and Vive are trademarks of Lutron Electronics Co., Inc.

#### LUTRON SPECIFICATION SUBMITTAL

Page:

Job Name:	Model Numbers:
Job Number:	

## Pico Wireless Control (for North, Central, and South America)

The Pico wireless control is a flexible and easy to use device that allows the user to control Lutron wireless load-control devices from anywhere in the space. This battery-operated control requires no external power or communication wiring.

### Features

- Provides control for the following:
  - Caséta Wireless controls
  - Energi Savr Node, Quantum, and myRoom systems, through the use of a QS sensor module (QSM)
  - Vive systems, including:
    - Maestro Wireless controls
    - PowPak modules
  - GRAFIK Eye QS wireless systems
  - HomeWorks QS wireless systems
  - Maestro Wireless controls
  - PowPak modules
  - RadioRA 2 systems
  - Serena RF remote control shades
  - Sivoia QS wireless systems
- Control available in a variety of button marking options.
- Control available in Gloss and Satin Colors finishes.
- Easy reconfiguration for use as:
  - Handheld remote
  - Wall-mount control (with or without faceplate; faceplate adapter kit sold separately)
  - Car visor control (car visor clip sold separately)
  - A table top control (table top pedestal sold separately).
- Battery-powered. Requires no wiring.
- 10 year battery life<sup>2</sup> (one CR2032 battery included).
- Can provide control of blinds, curtains, or lighting devices within a range of 30 ft (9 m) through walls and 60 ft (18 m) line-of-sight.
- BAA-compliant model numbers available in gloss only.

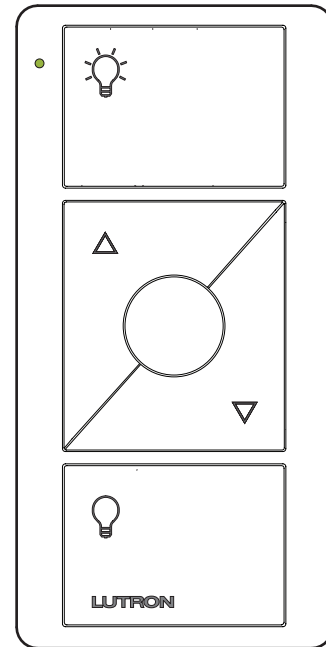

Pico wireless control <sup>1</sup>

<sup>1</sup> Button markings for Lights shown. Shade printing also available.

<sup>2</sup> Based on a 1 year shelf life, an average of 10 button presses per day, and an ambient temperature of 86 °F (30 °C). Actual life may vary based on usage and environmental conditions.

<b>Job Name:</b>	<b>Model Numbers:</b>
<b>Job Number:</b>	

## Specifications

### Regulatory Approvals

- Lutron Quality Systems registered to ISO 9001:2015.
- FCC Certified (U.S.A.)
- IC Certified (Canada)
- COFETEL Certified (Mexico)
- SUTEL Certified (Costa Rica)
- Anatel Certified (Brazil)

### Power

- Operating Voltage 3 V<sub>DC</sub>
- (1) CR2032 Battery (included)

### System Communication and Capacity

- Communicates using Radio Frequency (RF) at 431 MHz to 437 MHz.
- Thousands of system addresses prevent interference between systems.
- Can be assigned to control blinds, curtains or lighting devices that are within a 30 ft (9 m) range.
- Can be configured as a scene or zone control in GRAFIK Eye QS wireless applications.

### Mounting Considerations

- All RF devices should be mounted on nonmetallic surfaces to ensure proper performance.
- If you wish to mount your Pico wireless control to a metallic surface, the PICO-MOUNT-1-XX-CPN6774 will be required in order to maintain proper RF performance. For availability, please contact your local Lutron sales office.

### Environment

- Ambient operating temperature: 32 °F to 140 °F (0 °C to 60 °C)
- Maximum 90% non-condensing relative humidity
- Indoor use only

### Warranty

- 1 Year Limited Warranty  
For additional Warranty information, please visit [www.lutron.com/TechnicalDocumentLibrary/369-119\\_Wallbox\\_Warranty.pdf](http://www.lutron.com/TechnicalDocumentLibrary/369-119_Wallbox_Warranty.pdf)

Job Name:	Model Numbers:
Job Number:	

### Pico Wireless Control Dimensions

Measurements shown as: in (mm)

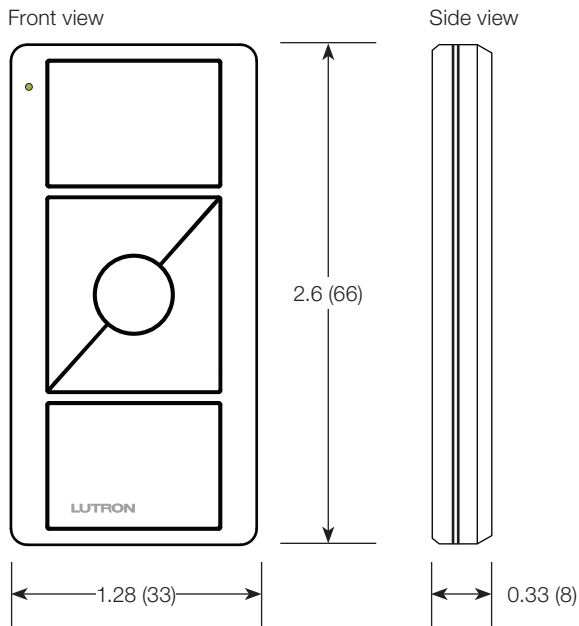

Job Name:	Model Numbers:
Job Number:	

# Operation

## 2 Button Controls (2B)

Lights Models: **L01**

Appliance Model: **L02**

Screens Model: **S08**

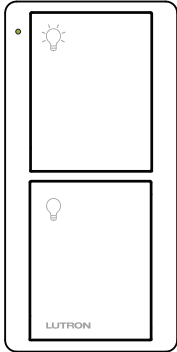

**ON Button**  
Lights go to full intensity.

**OFF Button**  
Lights go to off.

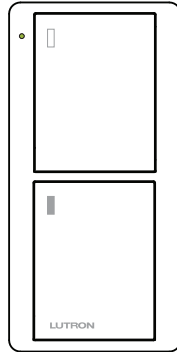

**ON Button**  
Appliance is turned ON.

**OFF Button**  
Appliance is turned OFF.

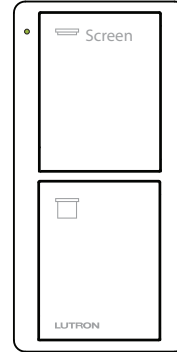

**OPEN Button**  
Screens go to open limit.

**CLOSE Button**  
Screens go to close limit.

## 2 Button Controls with Raise/Lower (2BRL)

Lights Model: **L01**

Shades Model: **S01**

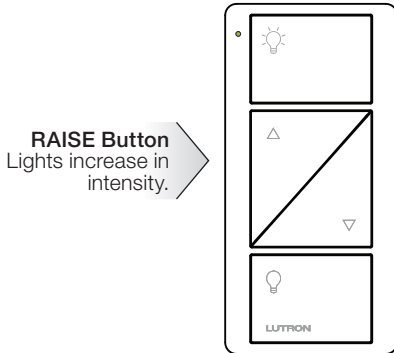

**ON Button**  
Lights brighten to full intensity.

**LOWER Button**  
Lights decrease in intensity.

**OFF Button**  
Lights dim to off.

**RAISE Button**  
Lights increase in intensity.

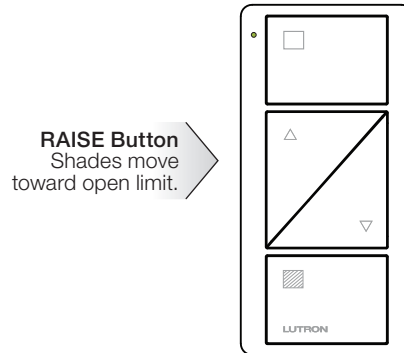

**RAISE Button**  
Shades move toward open limit.

**OPEN Button**  
Shades go to open limit.

**LOWER Button**  
Shades move toward close limit.

**CLOSED Button**  
Shades go to close limit.

(continued on next page...)

<p>Job Name:</p>  <p>Job Number:</p>	<p>Model Numbers:</p>
--	-----------------------

Operation (continued)

**3 Button Controls (3B)**

Lights Model: L01

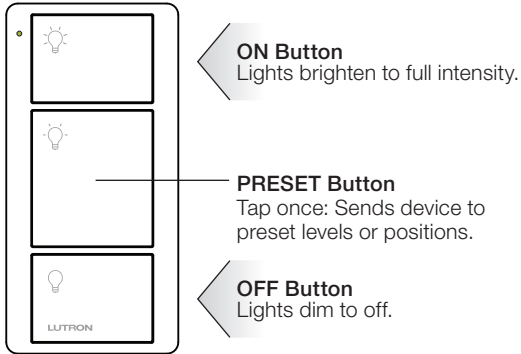

**3 Button Controls with Raise/Lower (3BRL)**

Lights Models: L01

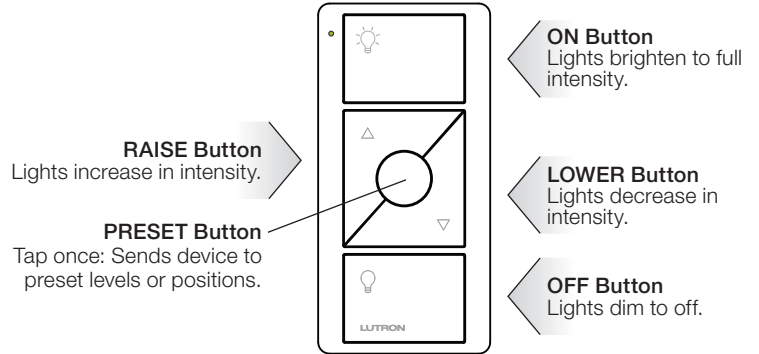

Shades Models: S01, S02, S03, S04, S06, S07

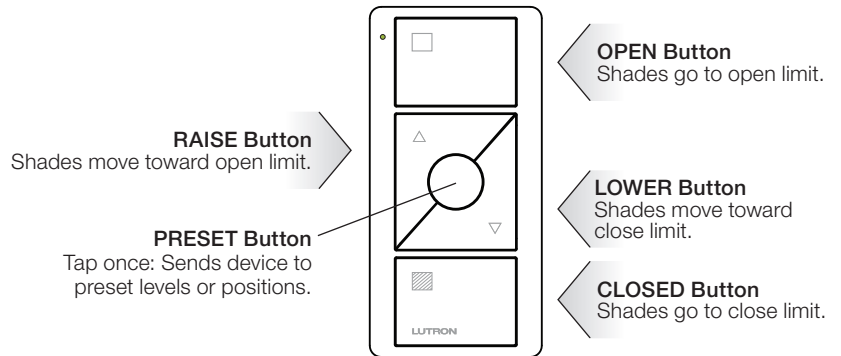

**3 Button Controls with Raise/Lower (3BRL)**

Venetian Blinds/Wood Blinds Model: S05

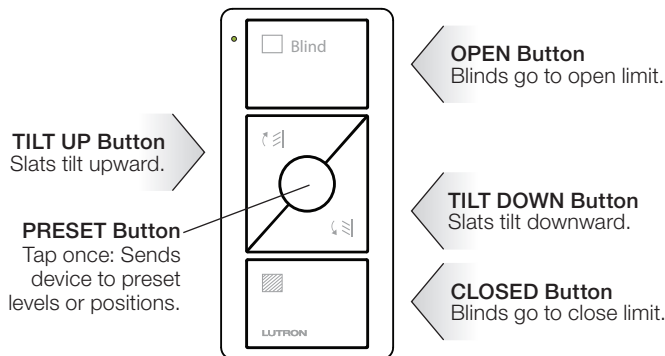

Horizontal Sheer Blinds Model: S09

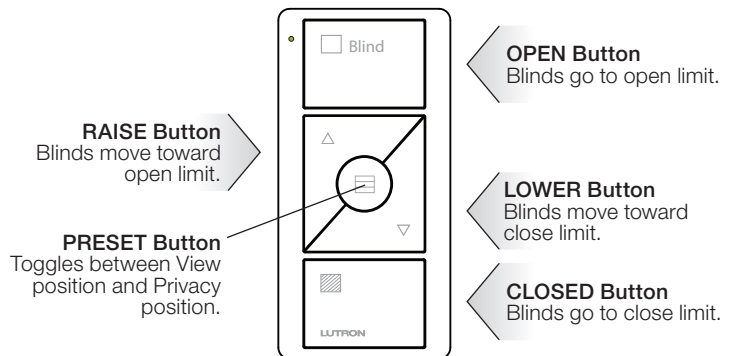

<b>Job Name:</b>	<b>Model Numbers:</b>
<b>Job Number:</b>	



## Pico Wireless Control Model Number

For order quantities of 96 pieces or greater of the same model number, bulk packaging may be available. Mounting hardware is not available with bulk packaging. Contact your local Lutron sales office.

PJ2 – XXXX – XXX – XXX

### Frequency/Channel Code \*

Code	Frequency Range
J	431.0 – 437.0 MHz

Button Marking Code  
(next page)

\* For questions about frequency/channel code compatibility, contact your local Lutron sales office or visit us at [www.lutron.com](http://www.lutron.com)

### Button Configuration Codes

Code	Button Configuration
2B	2 Button
2BRL	2 Button with Raise/Lower
3B	3 Button
3BRL	3 Button with Raise/Lower

### Color/Finish Codes

Color	Finish	
	Gloss	Texture (Satin Colors)
White	GWH	TSW
Black	GBL	TMN
Ivory	GIV	–
Light Almond	GLA	–
Biscuit	–	TBI
White/Gray <sup>1</sup>	GWG	–

<sup>1</sup> Top and Raise buttons are White; Preset, Lower, and Bottom buttons are Gray

(continued on next page...)

<b>Job Name:</b>	<b>Model Numbers:</b>
<b>Job Number:</b>	

**Pico Wireless Control Model Number** (continued)

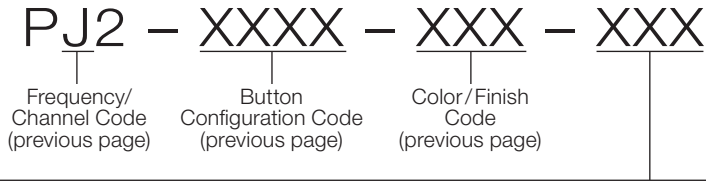

**Button Marking Codes**

**2 Button**

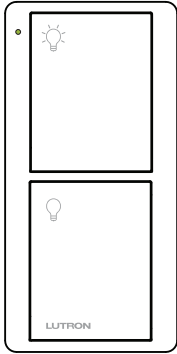

**L01:** Lights (icons only)

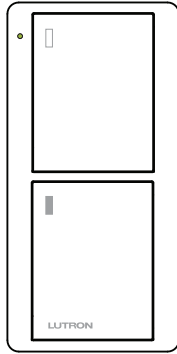

**L02:** Appliances (icons only)

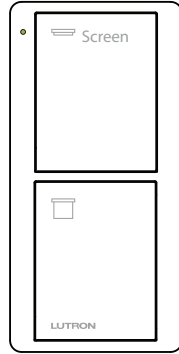

**S08:** Screens (icons + text)

**2 Button with Raise/Lower**

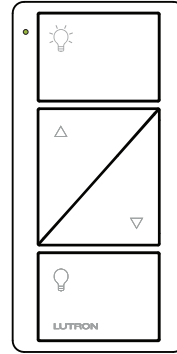

**L01:** Lights (icons only)

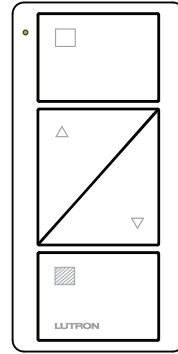

**S01:** Shades (icons only)

**3 Button**

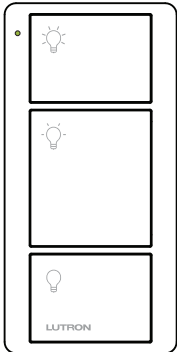

**L01:** Lights (icons only)

**3 Button with Raise/Lower**

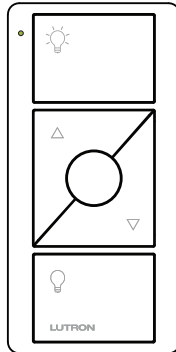

**L01\*:** Lights (icons only)

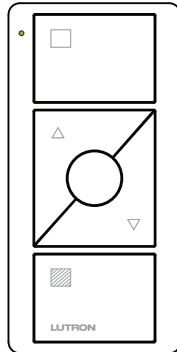

**S01:** Shades (icons only)

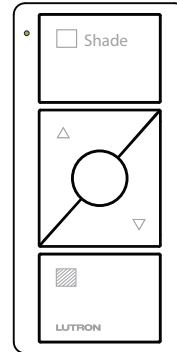

**S02:** Shades (icons + text)

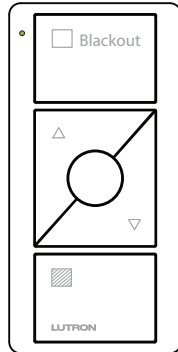

**S03:** Blackouts (icons + text)

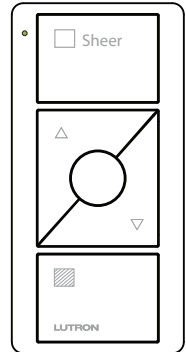

**S04:** Sheers (icons + text)

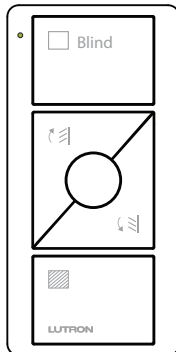

**S05:** Blinds (icons + text)

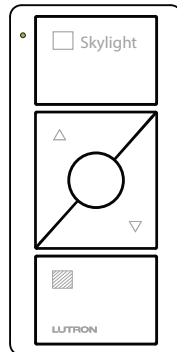

**S06:** Skylights (icons + text)

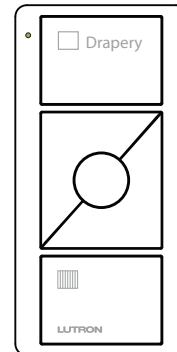

**S07:** Draperies (icons + text)

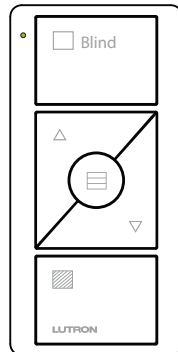

**S09:** Horizontal Sheer Blinds (icons + text)

\* Add "R" after "L01" in the model number for Caséta wireless retail packaging. Available in Gloss White (WH) or Light Almond (LA).

<b>Job Name:</b>	<b>Model Numbers:</b>
<b>Job Number:</b>	

## Pico Wireless Control Model Number (BAA Compliant)

For order quantities of 96 pieces or greater of the same model number, bulk packaging may be available. Mounting hardware is not available with bulk packaging. Contact your local Lutron sales office.

# UPJ2 – XXXX – XX – L01

### Frequency/Channel Codes\*

Code	Frequency Range
J	431.0 – 437.0 MHz

\* For questions about frequency/channel code compatibility, contact your local Lutron sales office or visit us at [www.lutron.com](http://www.lutron.com)

### Button Configuration Codes

Code	Button Configuration
2B	2 Button
2BRL	2 Button with Raise/Lower
3B	3 Button
3BRL	3 Button with Raise/Lower

### Color Codes

Color	Code
	Gloss <sup>1</sup>
White	WH
Black	BL
Ivory	IV
Light Almond	LA
White/Gray <sup>2</sup>	WG

<sup>1</sup> BAA controls are available in Gloss finish only.

<sup>2</sup> Top and Raise buttons are White; Preset, Lower, and Bottom buttons are Gray

### Button Marking Codes

2 Button

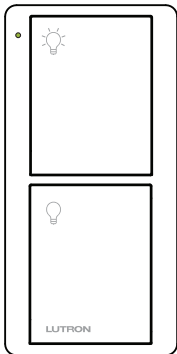

L01: Lights (icons only)

2 Button with Raise/Lower

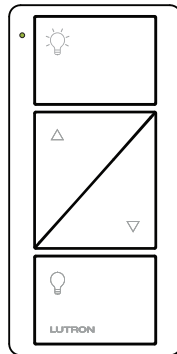

L01: Lights (icons only)

3 Button

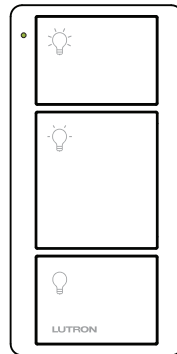

L01: Lights (icons only)

3 Button with Raise/Lower

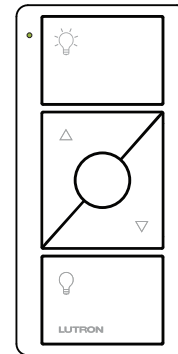

L01: Lights (icons only)

Job Name:	Model Numbers:
Job Number:	

## Pico Pedestal Model Number

Pedestals sold separately. Available in gloss finish only

L – PEDX – XX

### Capacity Codes

Capacity	Code
Single	1
Double	2
Triple	3

### Color Codes

Color*	Code
White	WH
Black	BL

\* Available in gloss finish only.

## Pico Pedestal Dimensions

Measurements shown as: in (mm)

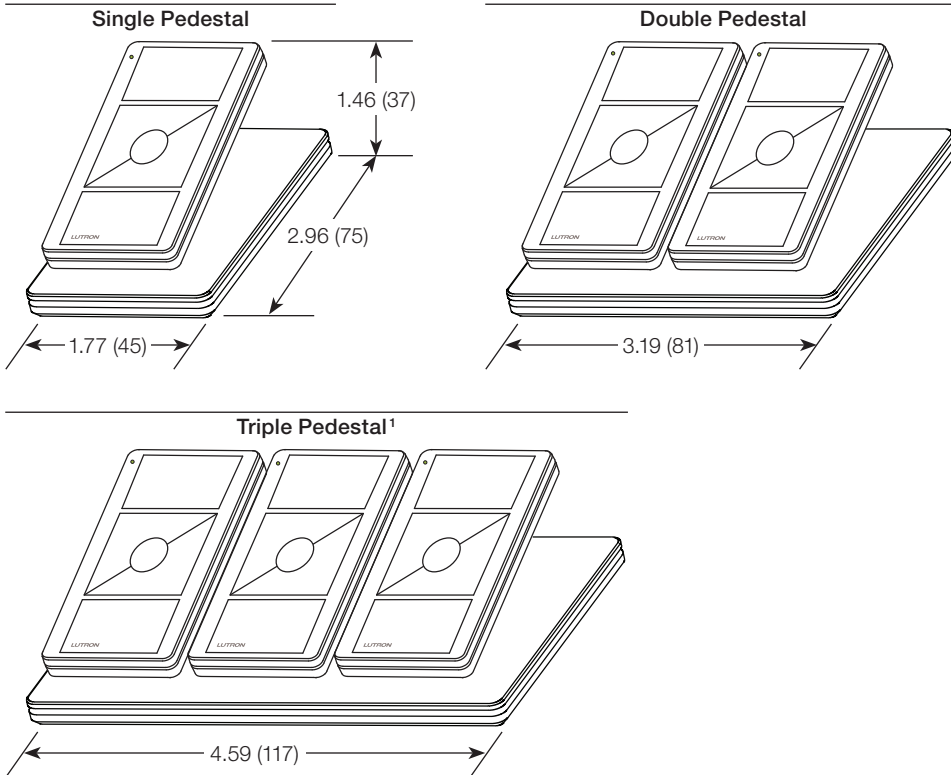

<sup>1</sup> For Triple Pedestals contact your local Lutron sales office or visit us at [www.lutron.com](http://www.lutron.com)

<b>Job Name:</b>	<b>Model Numbers:</b>
<b>Job Number:</b>	

# Mounting Options

## Standalone Mounting

**Adhesive Mounting**  
Included with Pico wireless control

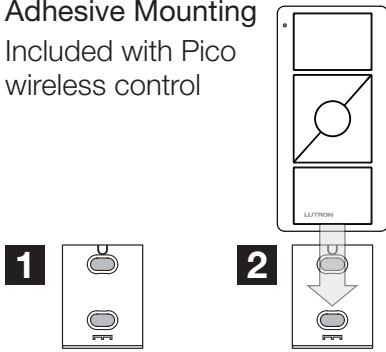

**Screw Mounting**  
Model: PICO-SM-KIT (sold separately)

Kit includes special screws to be used for more permanent mounting and/or for non-smooth surfaces.

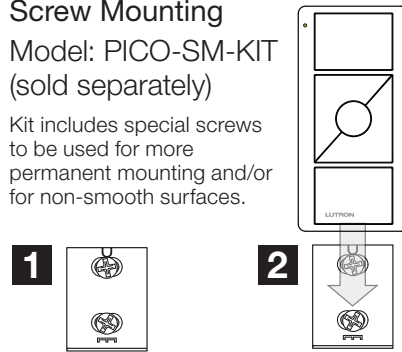

**Metal Surface Mounting**  
Model: PICO-MOUNT-1-XX-CPN6774 (sold separately)

Contact your local Lutron sales office.

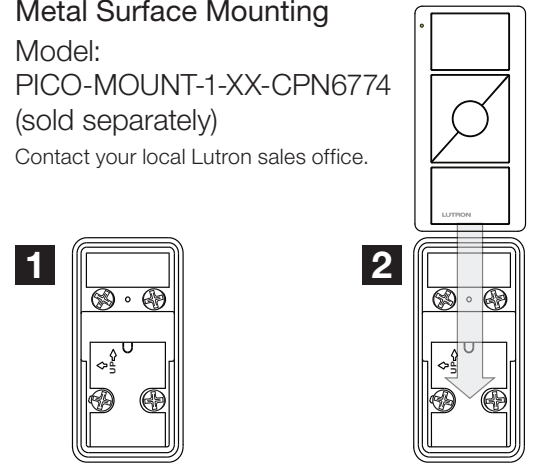

## Wallbox Mounting

**Wallbox Adapter**  
Model: PICO-WBX-ADAPT (sold separately)

Wallplate adapter/wallplate sold separately.

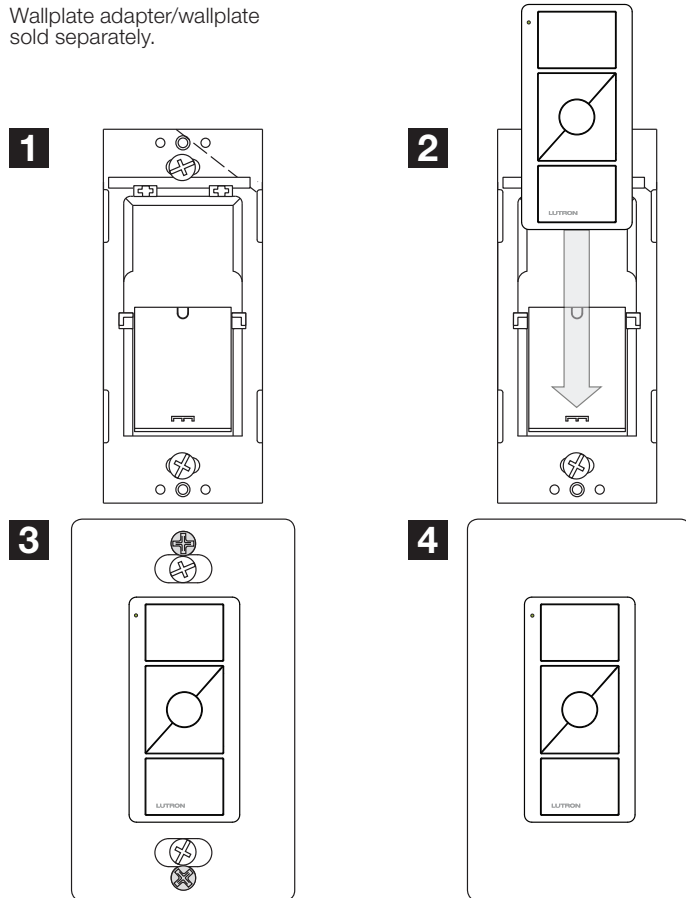

## Surface Mounting Kits

### Wall-Mounting Kit

Model: PJ2-WALL-WH-L01; PJ2-WALL-WH-L01C\* (sold separately)

- Kit includes:
- Pico wireless control
  - Claro wallplate (with wallplate adapter)
  - Wallbox adapter

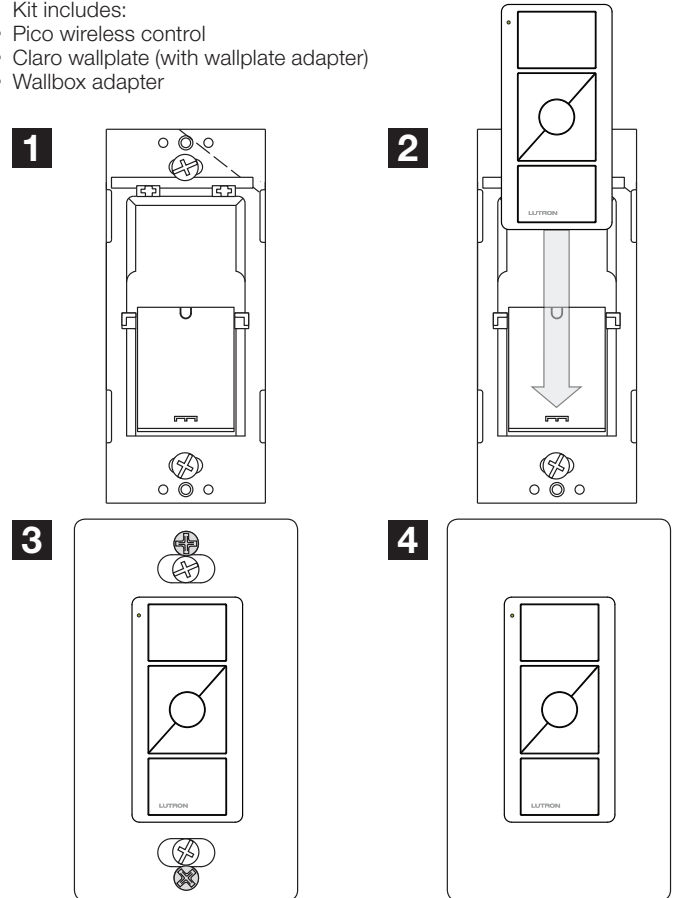

\* Canadian packaged product.

Job Name:	Model Numbers:
Job Number:	

### Mounting Options (continued)

#### Surface Mounting Kits (continued)

##### Wall-Mounting Kit (BAA Compliant)

Model: UPJ2-XXXX-XX-L01  
(sold separately)

Kit includes:

- Pico wireless control
- Wallbox adapter

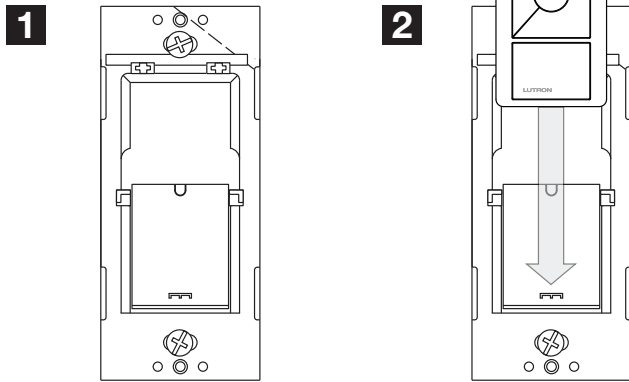

#### Vehicle Mounting

##### Mounting to a Car Visor

Model: PICO-CARVISOR-CL  
(sold separately)

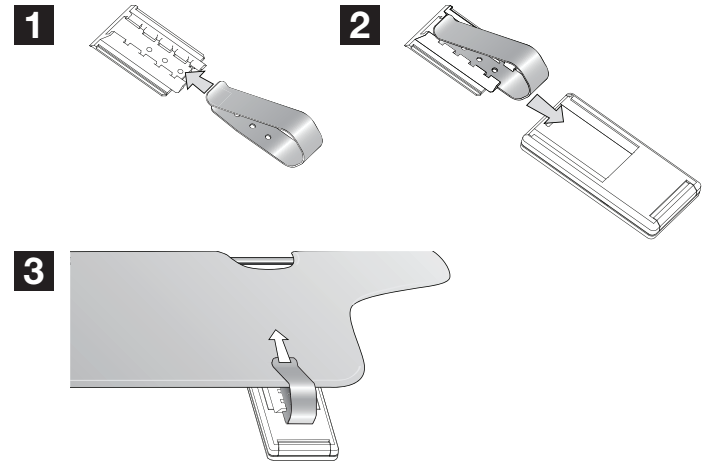

Lutron, Lutron, Pico, Caséta, Quantum, Maestro Wireless, PowPak, GRAFIK Eye, RadioRA, Satin Colors, Serena, Sivoia, HomeWorks and Claro are trademarks of Lutron Electronics Co., Inc. registered in the U.S. and other countries.

myRoom, Energi Savr Node, and Vive are trademarks of Lutron Electronics Co., Inc.

#### LUTRON SPECIFICATION SUBMITTAL

Page:

Job Name:	Model Numbers:
Job Number:	