

# Heavy duty, Non-Metallic QuickLATCH™

Made in USA 

**NEW!**  
more on reverse

*Installed Strut Clip • For RIGID and EMT*



**Fast, Easy Installation!**  
*Saves 20 seconds per installation*

Arlington's heavy duty NM3100 series QuickLATCH™ with *installed strut clip* holds RIGID and EMT securely on strut. Use it like a pipe hanger.



NM3100  
1/2" EMT

Stainless steel screw

One-piece QuickLATCH saves time, about 20 seconds per installation... over 33¢ each at \$60.00 per hour labor rate.

Fast and easy to install. Insert the hanger into the strut, twist to lock the pre-installed clip in place then tighten screw to secure QuickLATCH to strut. Push RIGID or EMT into the hanger to lock it in place.



1 Insert QuickLATCH into strut. The strut clip is already attached so you save time.



2 Twist QuickLATCH to seat clip in strut.



3 Tighten screw for secure installation on strut.



4 Push conduit into QuickLATCH to snap in place.



5 Secure installation of conduit to strut.



Easy screwdriver removal

- UV rated, corrosion resistant for outdoor use
- Stainless steel screw
- Mounts vertically or horizontally
- Screwdriver removal, reusable
- Listed for use in environmental air handling spaces per 2020 NEC, article 300.22(c)

**See reverse for even more QuickLATCH products!**

Patent pending



**Arlington®**

1 Stauffer Industrial Park  
Scranton, PA 18517

800/233.4717 • Fax 570/562.0646

[www.aifittings.com](http://www.aifittings.com)



**QUICKLATCH™ PIPE HANGER**

CATALOG NUMBER	UPC/DEI/NAED MFG. #018997	RIGID, IMC PVC SIZE	EMT SIZE	STD PKG
NM3100	54027	---	1/2"	100
NM3105	54028	1/2"	---	100
NM3110	54029	---	3/4"	100
NM3115	54030	3/4"	---	100
NM3120	54031	---	1"	100
NM3125	54032	1"	---	100

Includes 1/4"-20 stainless steel screw and strut clip (installed)

NM3100 series 0120/15M © 2020 Arlington Industries, Inc.

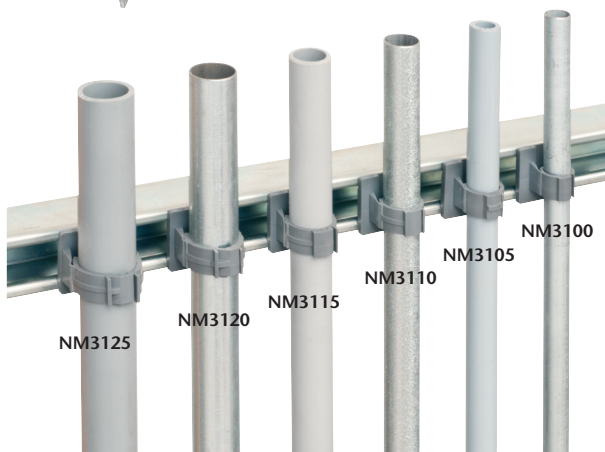

# UV Rated • Non-metallic QuickLATCH™

Made in USA 

*Works just like a Pipe Hanger • Easy to Install*



Mount to surface with a screw.

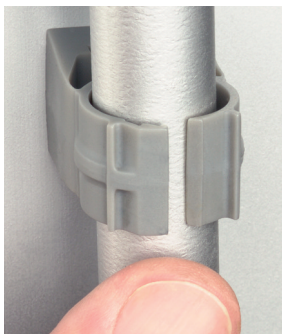

Press down on pipe to lock it firmly in place.



**Removable** Use screwdriver to lift tab.

Fast and easy to install, one-piece, non-metallic **QuickLATCH™** mounts to walls, metal strut and studs, and threaded rod up to 1/4-20...works with Arlington's Strut Clip™ too. *Strut Clip holds pipe hangers securely on strut.*

It fits 1/2" to 4" EMT, RIGID, IMC and PVC. The larger 2-1/2" to 4" sizes have an extra opening for the optional securing of tie wire or cable tie.

- Corrosion resistant
- Horizontal or vertical mounting
- Integral slot keeps nut from spinning



**2-1/2" to 4"**  
Press pipe into QuickLATCH, up to the first notch to lock it in place. Then squeeze tabs together for a super-secure hold.



Catalog Number	UPC/DEI/NAED Mfg. #018997	RIGID, IMC PVC sizes	EMT size	LT size	Flex size	ENT size	Copper Tubing	Copper Pipe	Std Pkg
NM1900	54514	---	---	5/16	---	---	1/2	---	100
NM2000	54515	---	1/2	3/8	---	---	---	3/8	100
NM2005	54525	1/2	---	1/2	1/2	1/2	---	1/2	100
NM2010	54516	---	3/4	---	---	---	3/4	---	100
NM2015	54526	3/4	---	3/4	3/4	3/4	---	3/4	100
NM2020	54517	---	1	---	---	---	1	---	100
NM2025	54518	1	---	1	1	1	---	1	100
NM2030	54528	---	1-1/4	---	---	---	1-1/4	---	100
NM2040	54519	1-1/4	1-1/2	---	---	---	1-1/2	1-1/4	100
NM2045	54544	1-1/2	---	1-1/2	1-1/2	---	---	1-1/2	100
NM2150	54547	---	---	---	---	---	2	---	50
NM2050	54520	2	2	2	2	---	2	---	50
NM2060	54521	2-1/2	2-1/2	2-1/2	2-1/2	---	---	---	50
NM2070	54522	3	3	3	3	---	---	---	25
NM2080	54523	3-1/2	3-1/2	3-1/2	3-1/2	---	---	---	25
NM2090	54524	4	4	4	4	---	---	---	10

Catalog Number	UPC/DEI/NAED Mfg. #018997	Description	Unit/Std Pkg
NM1000	54615	UV rated, non-metallic clip Holds pipe hangers and/or conduit secure on strut Includes 1/4"-20 screw (installed)	100

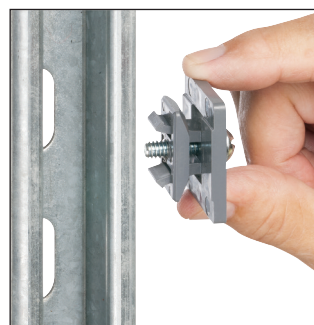

Our QuickLATCH™ Pipe Hanger installs on Strut Clip™

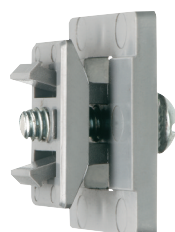

NM1000  
STRUT CLIP  
Strut Conduit Support



**Arlington®**

1 Stauffer Industrial Park  
Scranton, PA 18517  
800/233.4717 • Fax 570/562.0646  
www.aifittings.com

Distributed by

# Heavy duty, Non-Metallic QuickLATCH™

Made in USA 

**NEW!**  
more on reverse

*Installed Strut Clip • For RIGID and EMT*



**Fast, Easy Installation!**  
*Saves 20 seconds per installation*

Arlington's heavy duty NM3100 series QuickLATCH™ with *installed strut clip* holds RIGID and EMT securely on strut. Use it like a pipe hanger.



NM3100  
1/2" EMT

Stainless steel screw

One-piece QuickLATCH saves time, about 20 seconds per installation... over 33¢ each at \$60.00 per hour labor rate.

Fast and easy to install. Insert the hanger into the strut, twist to lock the pre-installed clip in place then tighten screw to secure QuickLATCH to strut. Push RIGID or EMT into the hanger to lock it in place.



1 Insert QuickLATCH into strut. The strut clip is already attached so you save time.

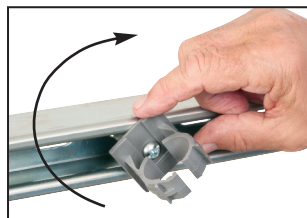

2 Twist QuickLATCH to seat clip in strut.



3 Tighten screw for secure installation on strut.



4 Push conduit into QuickLATCH to snap in place.



5 Secure installation of conduit to strut.



Easy screwdriver removal

- UV rated, corrosion resistant for outdoor use
- Stainless steel screw
- Mounts vertically or horizontally
- Screwdriver removal, reusable
- Listed for use in environmental air handling spaces per 2020 NEC, article 300.22(c)

**See reverse for even more QuickLATCH products!**

Patent pending



**Arlington®**

1 Stauffer Industrial Park  
Scranton, PA 18517

800/233.4717 • Fax 570/562.0646

[www.aifittings.com](http://www.aifittings.com)

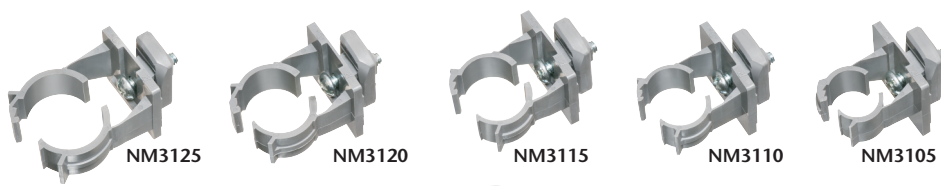

**QUICKLATCH™ PIPE HANGER**

CATALOG NUMBER	UPC/DEI/NAED MFG. #018997	RIGID, IMC PVC SIZE	EMT SIZE	STD PKG
NM3100	54027	---	1/2"	100
NM3105	54028	1/2"	---	100
NM3110	54029	---	3/4"	100
NM3115	54030	3/4"	--	100
NM3120	54031	---	1"	100
NM3125	54032	1"	---	100

Includes 1/4"-20 stainless steel screw and strut clip (installed)

NM3100 series 0120/15M © 2020 Arlington Industries, Inc.



# UV Rated • Non-metallic QuickLATCH™

Made in USA 

*Works just like a Pipe Hanger • Easy to Install*

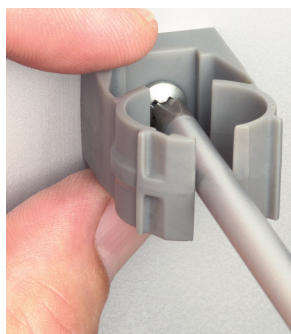

Mount to surface with a screw.

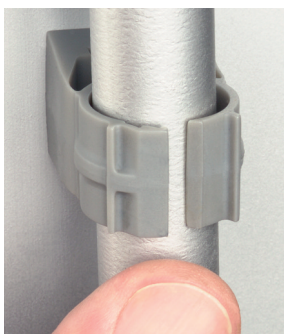

Press down on pipe to lock it firmly in place.



**Removable** Use screwdriver to lift tab.

Fast and easy to install, one-piece, non-metallic **QuickLATCH™** mounts to walls, metal strut and studs, and threaded rod up to 1/4-20...works with Arlington's Strut Clip™ too. *Strut Clip holds pipe hangers securely on strut.*

It fits 1/2" to 4" EMT, RIGID, IMC and PVC. The larger 2-1/2" to 4" sizes have an extra opening for the optional securing of tie wire or cable tie.

- Corrosion resistant
- Horizontal or vertical mounting
- Integral slot keeps nut from spinning



**2-1/2" to 4"**  
Press pipe into QuickLATCH, up to the first notch to lock it in place. Then squeeze tabs together for a super-secure hold.



Catalog Number	UPC/DEI/NAED Mfg. #018997	RIGID, IMC PVC sizes	EMT size	LT size	Flex size	ENT size	Copper Tubing	Copper Pipe	Std Pkg
NM1900	54514	---	---	5/16	---	---	1/2	---	100
NM2000	54515	---	1/2	3/8	---	---	---	3/8	100
NM2005	54525	1/2	---	1/2	1/2	1/2	---	1/2	100
NM2010	54516	---	3/4	---	---	---	3/4	---	100
NM2015	54526	3/4	---	3/4	3/4	3/4	---	3/4	100
NM2020	54517	---	1	---	---	---	1	---	100
NM2025	54518	1	---	1	1	1	---	1	100
NM2030	54528	---	1-1/4	---	---	---	1-1/4	---	100
NM2040	54519	1-1/4	1-1/2	---	---	---	1-1/2	1-1/4	100
NM2045	54544	1-1/2	---	1-1/2	1-1/2	---	---	1-1/2	100
NM2150	54547	---	---	---	---	---	2	---	50
NM2050	54520	2	2	2	2	---	2	---	50
NM2060	54521	2-1/2	2-1/2	2-1/2	2-1/2	---	---	---	50
NM2070	54522	3	3	3	3	---	---	---	25
NM2080	54523	3-1/2	3-1/2	3-1/2	3-1/2	---	---	---	25
NM2090	54524	4	4	4	4	---	---	---	10

Catalog Number	UPC/DEI/NAED Mfg. #018997	Description STRUT CLIP™	Unit/Std Pkg
NM1000	54615	UV rated, non-metallic clip Holds pipe hangers and/or conduit secure on strut Includes 1/4"-20 screw (installed)	100

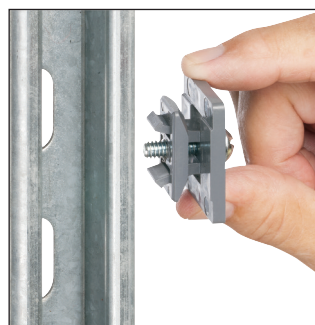

Our QuickLATCH™ Pipe Hanger installs on Strut Clip™

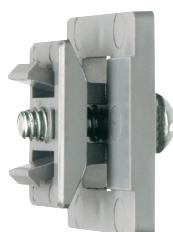

NM1000  
STRUT CLIP  
Strut Conduit Support



**Arlington®**

1 Stauffer Industrial Park  
Scranton, PA 18517  
800/233.4717 • Fax 570/562.0646  
www.aifittings.com

Distributed by