











Liquidtight Fittings

Overview

Our liquidtight product line offers high quality, high performance fittings. Designed to the toughest standards and integrating the latest technology, not only do you get a reliable and durable product, you also get one that reduces installation time and cost. Our versatile lines of liquidtight fittings are designed for a wide range of industrial, commercial and residential applications. Choose from our Liquidator™, LiQuik™, zinc die cast, non-metallic or low profile liquidtight fittings.

Liquidtight Fittings Selection Chart:

	Family	Material	Size/Range	Configurations	Typical Applications
	Liquidator™	Malleable Iron	3/8" - 6"	Straight, 45°, 90°	For use with LFMC in tough, industrial, corrosive applications
	Liquidator LT SA Aluminum	Copper-free Aluminum	3/8" - 4"	Straight (3/8" through 4"), 90° (3/8" through 2")	Used where aluminum material is preferred in tough, industrial, corrosive applications
	LTK Low Profile	Steel/Malleable Iron	3/8" - 2"	Straight, 45°, 90°	Used where there are space restrictions in tough, industrial, corrosive applications
	LTQ LiQuik™	Malleable Iron	3/8" - 2"	Straight (3/8" through 2"), 45° & 90° (1/2" through 1")	Labor saving, no disassembly, in tough, industrial, corrosive applications
	LTDC Zinc Die Cast	Zinc Die Cast	3/8" - 4"	Straight, 90°	Used where zinc die cast material is preferred in tough, industrial, corrosive applications
	LTNM Non-metallic	Nylon	3/8" - 2"	Straight, 90°	Use with non-metallic Type B LT conduit in corrosive, commercial and residential applications
	LT US Product of the USA	Steel/Malleable Iron	3/8" - 4"	Straight, 45°, 90°	When Product of the USA material is specified in tough, industrial, corrosive applications
	LTS Steel	Tubular Steel	1/2" - 2"	Straight Only	For use in cost-competitive applications in light industrial and commercial applications
	LT SS Stainless Steel	304 Stainless Steel	1/2" - 2"	Straight, 90°	Used where corrosion resistance is required in tough, industrial, corrosive applications
	Space-Saver	Malleable Iron	3/8" - 1"	Straight Only	Used where space restrictions occur in tough, industrial, corrosive applications

Liquidtight

Product Features	User Benefits
UL Listed; cUL certified	Assurance of safe and reliable performance; end-user peace of mind
Provides protection in wet locations	Meets NEC and UL requirements for use in wet locations; reduces downtime and replacement costs
Available in various configurations in various trade sizes and materials	Complete selection of styles and sizes; easy selection from one source, saves time and money
Hex surfaces on gland nut and body	Easy wrenching; fast, easy installation results in labor savings
Sealing gasket effectively seals out water, oil, dust and dirt	Eliminates leakage, potential downtime and replacement costs
Locknut bites into box; won't vibrate loose	Provides a reliable ground and safety of personnel and equipment
Cupped long grounding ferrule is distortion-free	Provides excellent pull-out strength, prevents conduit pop-out and provides grounding for safety of personnel and equipment
Concrete tight	Provides rugged durability in concrete applications

Liquidtight Fittings

Overview

Applications:

Typical applications for liquidtight conduit and liquidtight fittings include the wiring of machine tools, motors, transformers, food processing equipment, robotics, air conditioning units, illuminated storefront signs and billboards, etc. The flexible metallic conduit and fittings protect conductors from mechanical damage due to vibration and movement, and seal out cutting oils, coolants, water, dust, etc. Applications such as these can be found in, but are not limited to, industries such as:

- Machine tool manufacturers
- Electric power generating plants
- Waste treatment facilities
- Paint manufacturing facilities
- Automobile manufacturing facilities
- Aerospace industries
- Breweries
- Food processing plants
- Dairies
- Pulp and paper mills
- Petroleum refineries
- Chemical and petrochemical plants

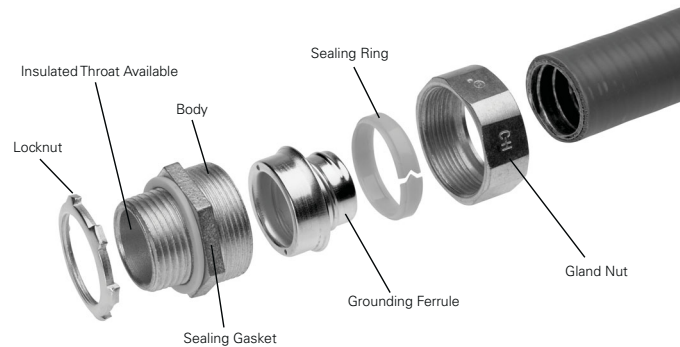

Features:

- Liquidtight, raintight, oiltight for protection and long life in wet, dusty and corrosive environments
- Hex shaped gland nut allows for easy wrenching, providing a fast, tight installation
- Suitable for wet locations
- Reusable, long ferrule prevents pull-out and tight bend conduit pop-out
- Furnished with locknut and sealing ring
- Third party certified
- Available in insulated and non-insulated versions to meet any customer preference

Certifications and Compliances:

- UL Listed liquidtight flexible metal conduit fittings are suitable for use in the following hazardous locations under NEC:
 - Class I, Division 2;
 - Class II, Divisions 1 & 2; and
 - Class III, Divisions 1 & 2;
 - Suitable for grounding in sizes 3/8" through 1 1/4" under NEC
- UL Standards 514B, 467
- cUL Standard C22.2 No. 18F
- UL File No. E-19189



Liquidtight Fittings

Liquidator™ Flexible Metallic Conduit Fittings

Applications:

- Liquidator™ Fittings are used when liquidtight conduit is in tough, industrial and corrosive applications
- Available in both malleable iron and aluminum construction with the option of a ground lug pre-attached

Features:

- Liquidtight, raintight, oiltight for protection and long life in wet, dusty and corrosive environments
- Hex shaped gland nut allows for easy wrenching, providing a fast, tight installation
- Suitable for wet locations
- Reusable, long ferrule prevents pull-out and tight bend conduit pop-out
- Furnished with locknut and sealing ring
- Third party certified
- Available in malleable iron and aluminum construction
- Available in straight, 90 and 45 degree configurations
- Available in sizes $\frac{3}{8}$ " to 6" (select sizes)
- Available in insulated and non-insulated versions to meet any customer preference

Certifications and Compliances:

- UL Listed liquidtight flexible metal conduit fittings are suitable for use in the following hazardous locations under NEC:
 - Class I, Division 2;
 - Class II, Divisions 1 & 2; and
 - Class III, Divisions 1 & 2;
 - Suitable for grounding in sizes $\frac{3}{8}$ " through $1\frac{1}{4}$ " under NEC
- UL Standards 514B, 467
- cUL Standard C22.2 No. 18F
- UL File No. E-19189

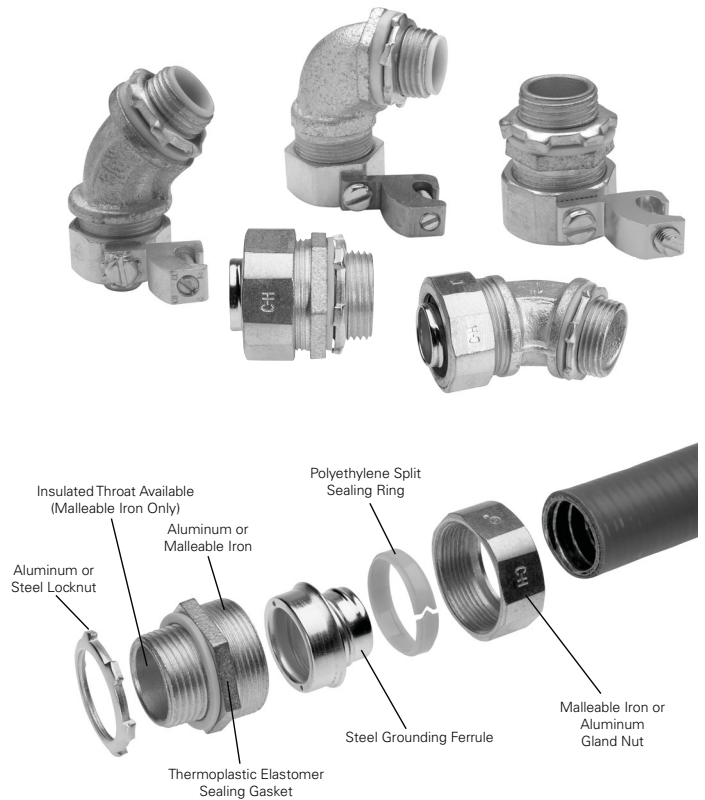

Standard Materials:

- Body – straight – $\frac{3}{8}$ " through 6": malleable iron; $\frac{3}{8}$ " through 4": aluminum
- 45° – $\frac{3}{8}$ " through 4": malleable iron
- 90° – $\frac{3}{8}$ " through 4": malleable iron or aluminum
- Gland nut – malleable iron or aluminum
- Ferrule – steel
- Gland nut sealing ring – polyethylene
- Sealing gasket – thermoplastic elastomer
- Locknut – steel or aluminum

Standard Finishes:

- Malleable iron – zinc electroplate
- Aluminum – natural

Liquidtight Fittings

Liquidator™ Flexible Metallic Conduit Fittings

Straight Connectors – Malleable Iron

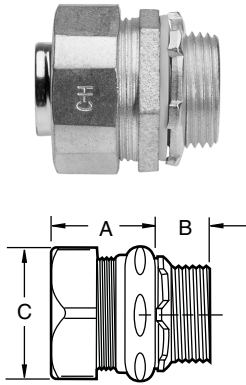

Trade Size	Cat. # Non-insulated	Cat. # Insulated	Unit Qty.	Wt. Lbs. Per 100	A	B	C
3/8"	LT38	LTB38	25	15.4	1.125	0.500	1.125
1/2"	LT50	LTB50	25	17.6	1.250	0.500	1.250
3/4"	LT75	LTB75	25	28.7	1.250	0.500	1.563
1"	LT100	LTB100	5	39.7	1.438	0.625	0.813
1 1/4"	LT125	LTB125	5	55.1	1.500	0.688	2.250
1 1/2"	LT150	LTB150	2	70.5	1.625	0.750	2.438
2"	LT200	LTB200	1	99.2	1.750	0.750	3.000
2 1/2"	LT250	LTB250	1	363.8	2.188	1.000	4.000
3"	LT300	LTB300	1	456.4	2.500	1.125	4.188
3 1/2"	LT350	LTB350	1	668.0	2.625	1.188	5.250
4"	LT400	LTB400	1	789.2	2.750	1.250	5.750
5"	LT500†	LTB500†	1	1036.2	3.125	1.438	6.063
6"	LT600†	LTB600†	1	1366.9	3.375	1.500	7.750

†Not UL Listed or CSA certified.

Liquidtight

Straight Connectors with Grounding Lug – Malleable Iron

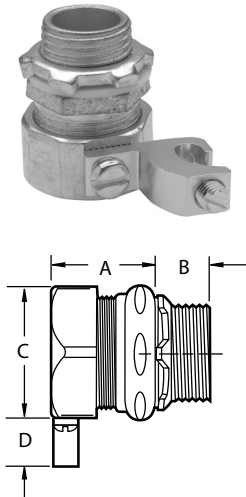

Trade Size	Cat. # Non-insulated with Aluminum Grounding Lug	Cat. # Insulated with Aluminum Grounding Lug	Cat. # Insulated with Copper Grounding Lug	Lug Size	Unit Qty.	Wt. Lbs. Per 100	A	B	C	D
3/8"	LT38G	LTB38G	LTB38GC	#4 - #14	25	17.4	1.125	0.500	1.125	0.750
1/2"	LT50G	LTB50G	LTB50GC	#4 - #14	25	19.5	1.250	0.500	1.250	0.750
3/4"	LT75G	LTB75G	LTB75GC	#4 - #14	25	30.7	1.250	0.500	1.563	0.750
1"	LT100G	LTB100G	LTB100GC	#4 - #14	5	41.7	1.438	0.625	0.813	0.750
1 1/4"	LT125G	LTB125G	LTB125GC	#4 - #14	5	57.0	1.500	0.688	2.250	0.750
1 1/2"	LT150G	LTB150G	LTB150GC	#4 - #14	2	72.4	1.625	0.750	2.438	0.750
2"	LT200G	LTB200G	LTB200GC	#4 - #14	1	100.9	1.750	0.750	3.000	0.750
2 1/2"	LT250G	LTB250G	LTB250GC	#1/0 - #8	1	370.9	2.188	1.000	4.000	1.125
3"	LT300G	LTB300G	LTB300GC	#1/0 - #8	1	462.9	2.500	1.125	4.188	1.125
3 1/2"	LT350G	LTB350G	LTB350GC	#3/0 - #6	1	682.1	2.625	1.188	5.250	1.500
4"	LT400G	LTB400G	LTB400GC	#3/0 - #6	1	802.9	2.750	1.250	5.750	1.500
5"	LT500G†	LTB500G†	-	250MCM - #6	1	1052.7	3.125	1.438	6.063	1.688
6"	LT600G†	LTB600G†	-	250MCM - #6	1	1389.4	3.375	1.500	7.750	1.688

†Not UL Listed or CSA certified.

Straight Connectors with and without Grounding Lug – Aluminum

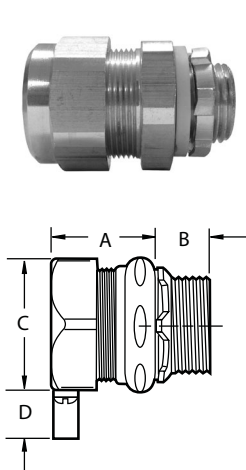

Trade Size	Cat. # Non-insulated	Cat. # Non-insulated with Aluminum Grounding Lug	Lug Size	Unit Qty.	Wt. Lbs. Per 100	A	B	C	D
3/8"	LT38 SA	LT38G SA	#4 - #14	25	13.4	1.188	0.594	1.250	0.750
1/2"	LT50 SA	LT50G SA	#4 - #14	25	15.6	1.313	0.594	1.250	0.750
3/4"	LT75 SA	LT75G SA	#4 - #14	25	26.7	1.313	0.594	1.500	0.750
1"	LT100 SA	LT100G SA	#4 - #14	5	37.7	1.438	0.813	1.750	0.750
1 1/4"	LT125 SA	LT125G SA	#4 - #14	5	53.1	1.563	0.813	2.250	0.750
1 1/2"	LT150 SA	LT150G SA	#4 - #14	2	68.5	1.813	0.813	2.500	0.750
2"	LT200 SA	LT200G SA	#4 - #14	1	97.2	1.750	0.875	3.000	0.750
2 1/2"	LT250 SA	LT250G SA	#1/0 - #8	1	361.8	2.250	1.063	3.750	1.125
3"	LT300 SA	LT300G SA	#1/0 - #8	1	454.4	2.438	1.125	4.500	1.125
3 1/2"	LT350 SA	LT350G SA	#3/0 - #6	1	666.0	2.875	1.188	5.125	1.500
4"	LT400 SA	LT400G SA	#3/0 - #6	1	787.2	2.938	1.250	5.625	1.500

Liquidtight Fittings

Liquidator™ Liquidtight Flexible Metallic Conduit Fittings

90° Angle Connectors – Malleable Iron

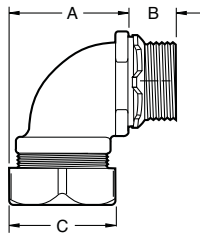

Trade Size	Cat. # Non-insulated	Cat. # Insulated	Unit Qty.	Wt. Lbs. Per 100	A	B	C
3/8"	LT3890	LTB3890	25	25.4	1.313	0.500	1.125
1/2"	LT5090	LTB5090	25	28.9	1.438	0.500	1.250
3/4"	LT7590	LTB7590	10	44.1	1.625	0.500	1.563
1"	LT10090	LTB10090	10	74.5	2.313	0.625	0.813
1 1/4"	LT12590	LTB12590	5	96.1	2.375	0.688	2.250
1 1/2"	LT15090	LTB15090	2	121.3	3.063	0.750	2.438
2"	LT20090	LTB20090	1	176.4	3.188	0.750	3.000
2 1/2"	LT25090	LTB25090	1	837.7	8.313	1.000	4.000
3"	LT30090	LTB30090	1	1234.6	9.813	1.125	4.188
3 1/2"	LT35090	LTB35090	1	1896.0	11.188	1.188	5.250
4"	LT40090	LTB40090	1	2381.0	12.563	1.250	5.750

90° Angle Connectors with Grounding Lug – Malleable Iron

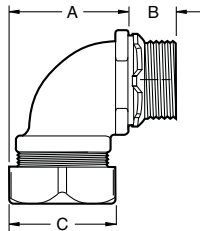

Trade Size	Cat. # Non-insulated with Aluminum Grounding Lug	Cat. # Insulated with Aluminum Grounding Lug	Cat. # Insulated with Copper Grounding Lug	Lug Size	Unit Qty.	Wt. Lbs. Per 100	A	B	C
3/8"	LT3890G	LTB3890G	LTB3890GC	#4 - #14	25	27.6	1.313	0.500	1.125
1/2"	LT5090G	LTB5090G	LTB5090GC	#4 - #14	25	31.1	1.438	0.500	1.250
3/4"	LT7590G	LTB7590G	LTB7590GC	#4 - #14	10	46.3	1.625	0.500	1.563
1"	LT10090G	LTB10090G	LTB10090GC	#4 - #14	10	76.7	2.313	0.625	0.813
1 1/4"	LT12590G	LTB12590G	LTB12590GC	#4 - #14	5	98.3	2.375	0.688	2.250
1 1/2"	LT15090G	LTB15090G	LTB15090GC	#4 - #14	2	123.5	3.063	0.750	2.438
2"	LT20090G	LTB20090G	LTB20090GC	#4 - #14	1	178.6	3.188	0.750	3.000
2 1/2"	LT25090G	LTB25090G	LTB25090GC	#1/0 - #8	1	846.6	8.313	1.000	4.000
3"	LT30090G	LTB30090G	LTB30090GC	#1/0 - #8	1	1243.4	9.813	1.125	4.188
3 1/2"	LT35090G	LTB35090G	LTB35090GC	#3/0 - #6	1	1913.6	11.188	1.188	5.250
4"	LT40090G	LTB40090G	LTB40090GC	#3/0 - #6	1	2398.6	12.563	1.250	5.750

90° Angle Connectors with and without Grounding Lug – Aluminum

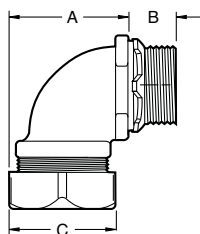

Trade Size	Cat. # Non-insulated	Cat. # Non-insulated with Aluminum Grounding Lug	Lug Size	Unit Qty.	Wt. Lbs. Per 100	A	B	C
3/8"	LT3890 SA	LT3890G SA	#4 - #14	25	16	1.313	0.500	1.125
1/2"	LT5090 SA	LT5090G SA	#4 - #14	25	20	1.438	0.500	1.250
3/4"	LT7590 SA	LT7590G SA	#4 - #14	10	25	1.625	0.500	1.563
1"	LT10090 SA	LT10090G SA	#4 - #14	10	31	2.313	0.625	0.813
1 1/4"	LT12590 SA	LT12590G SA	#4 - #14	5	48	2.375	0.688	2.250
1 1/2"	LT15090 SA	LT15090G SA	#4 - #14	2	150	3.063	0.750	2.438
2"	LT20090 SA	LT20090G SA	#4 - #14	1	200	3.188	0.750	3.000

Liquidtight

Liquidtight Fittings

Liquidator™ Liquidtight Flexible Metallic Conduit Fittings

45° Angle Connectors – Malleable Iron

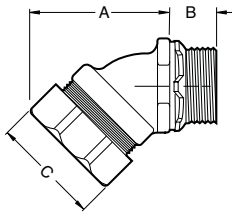

Trade Size	Cat. # Non-insulated	Cat. # Insulated	Unit Qty.	Wt. Lbs. Per 100	A	B	C
3/8"	LT3845	LTB3845	25	27.1	1.938	0.500	1.125
1/2"	LT5045	LTB5045	25	27.1	2.000	0.500	1.250
3/4"	LT7545	LTB7545	10	39.7	2.188	0.500	1.563
1"	LT10045	LTB10045	10	63.5	2.500	0.625	0.813
1 1/4"	LT12545	LTB12545	5	87.3	2.813	0.688	2.250
1 1/2"	LT15045	LTB15045	2	110.2	3.000	0.750	2.438
2"	LT20045	LTB20045	1	176.4	3.688	0.750	3.000
2 1/2"	LT25045	LTB25045	1	573.2	7.313	1.000	4.000
3"	LT30045	LTB30045	1	859.8	7.625	1.125	4.188
3 1/2"	LT35045	LTB35045	1	1278.7	9.625	1.188	5.250
4"	LT40045	LTB40045	1	1521.2	11.063	1.250	5.750

45° Angle Connectors with Grounding Lug – Malleable Iron

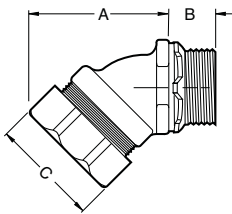

Trade Size	Cat. # Non-insulated with Aluminum Grounding Lug	Cat. # Insulated with Aluminum Grounding Lug	Cat. # Insulated with Copper Grounding Lug	Lug Size	Unit Qty.	Wt. Lbs. Per 100	A	B	C
3/8"	LT3845G	LTB3845G	LTB3845GC	#4 - #14	25	29.3	1.938	0.500	1.125
1/2"	LT5045G	LTB5045G	LTB5045GC	#4 - #14	25	29.3	2.000	0.500	1.250
3/4"	LT7545G	LTB7545G	LTB7545GC	#4 - #14	10	41.9	2.188	0.500	1.563
1"	LT10045G	LTB10045G	LTB10045GC	#4 - #14	10	65.7	2.500	0.625	0.813
1 1/4"	LT12545G	LTB12545G	LTB12545GC	#4 - #14	5	89.5	2.813	0.688	2.250
1 1/2"	LT15045G	LTB15045G	LTB15045GC	#4 - #14	2	112.4	3.000	0.750	2.438
2"	LT20045G	LTB20045G	LTB20045GC	#4 - #14	1	178.6	3.688	0.750	3.000
2 1/2"	LT25045G	LTB25045G	LTB25045GC	#1/0 - #8	1	582.0	7.313	1.000	4.000
3"	LT30045G	LTB30045G	LTB30045GC	#1/0 - #8	1	868.6	7.625	1.125	4.188
3 1/2"	LT35045G	LTB35045G	LTB35045GC	#3/0 - #6	1	1296.3	9.625	1.188	5.250
4"	LT40045G	LTB40045G	LTB40045GC	#3/0 - #6	1	1538.8	11.063	1.250	5.750

Replacement Liquidtight Ferrules













Trade Size	Cat. #	Unit Qty.	Wt. Lbs. Per 100
3/8"	FEA38	100	1.9
1/2"	FEA50	100	2.2
3/4"	FEA75	100	2.5
1"	FEA100	100	3.1
1 1/4"	FEA125	50	5.0
1 1/2"	FEA150	50	6.3
2"	FEA200	10	8.1
2 1/2"	FEA250	10	21.3
3"	FEA300	10	27.5
3 1/2"	FEA350	10	31.3
4"	FEA400	10	34.4

Liquidtight Fittings

Overview

Our liquidtight product line offers high quality, high performance fittings. Designed to the toughest standards and integrating the latest technology, not only do you get a reliable and durable product, you also get one that reduces installation time and cost. Our versatile lines of liquidtight fittings are designed for a wide range of industrial, commercial and residential applications. Choose from our Liquidator™, LiQuik™, zinc die cast, non-metallic or low profile liquidtight fittings.

Liquidtight Fittings Selection Chart:

	Family	Material	Size/Range	Configurations	Typical Applications
	Liquidator™	Malleable Iron	3/8" - 6"	Straight, 45°, 90°	For use with LFMC in tough, industrial, corrosive applications
	Liquidator LT SA Aluminum	Copper-free Aluminum	3/8" - 4"	Straight (3/8" through 4"), 90° (3/8" through 2")	Used where aluminum material is preferred in tough, industrial, corrosive applications
	LTK Low Profile	Steel/Malleable Iron	3/8" - 2"	Straight, 45°, 90°	Used where there are space restrictions in tough, industrial, corrosive applications
	LTQ LiQuik™	Malleable Iron	3/8" - 2"	Straight (3/8" through 2"), 45° & 90° (1/2" through 1")	Labor saving, no disassembly, in tough, industrial, corrosive applications
	LTDC Zinc Die Cast	Zinc Die Cast	3/8" - 4"	Straight, 90°	Used where zinc die cast material is preferred in tough, industrial, corrosive applications
	LTNM Non-metallic	Nylon	3/8" - 2"	Straight, 90°	Use with non-metallic Type B LT conduit in corrosive, commercial and residential applications
	LT US Product of the USA	Steel/Malleable Iron	3/8" - 4"	Straight, 45°, 90°	When Product of the USA material is specified in tough, industrial, corrosive applications
	LTS Steel	Tubular Steel	1/2" - 2"	Straight Only	For use in cost-competitive applications in light industrial and commercial applications
	LT SS Stainless Steel	304 Stainless Steel	1/2" - 2"	Straight, 90°	Used where corrosion resistance is required in tough, industrial, corrosive applications
	Space-Saver	Malleable Iron	3/8" - 1"	Straight Only	Used where space restrictions occur in tough, industrial, corrosive applications

Liquidtight

Product Features	User Benefits
UL Listed; cUL certified	Assurance of safe and reliable performance; end-user peace of mind
Provides protection in wet locations	Meets NEC and UL requirements for use in wet locations; reduces downtime and replacement costs
Available in various configurations in various trade sizes and materials	Complete selection of styles and sizes; easy selection from one source, saves time and money
Hex surfaces on gland nut and body	Easy wrenching; fast, easy installation results in labor savings
Sealing gasket effectively seals out water, oil, dust and dirt	Eliminates leakage, potential downtime and replacement costs
Locknut bites into box; won't vibrate loose	Provides a reliable ground and safety of personnel and equipment
Cupped long grounding ferrule is distortion-free	Provides excellent pull-out strength, prevents conduit pop-out and provides grounding for safety of personnel and equipment
Concrete tight	Provides rugged durability in concrete applications

Liquidtight Fittings

Overview

Applications:

Typical applications for liquidtight conduit and liquidtight fittings include the wiring of machine tools, motors, transformers, food processing equipment, robotics, air conditioning units, illuminated storefront signs and billboards, etc. The flexible metallic conduit and fittings protect conductors from mechanical damage due to vibration and movement, and seal out cutting oils, coolants, water, dust, etc. Applications such as these can be found in, but are not limited to, industries such as:

- Machine tool manufacturers
- Electric power generating plants
- Waste treatment facilities
- Paint manufacturing facilities
- Automobile manufacturing facilities
- Aerospace industries
- Breweries
- Food processing plants
- Dairies
- Pulp and paper mills
- Petroleum refineries
- Chemical and petrochemical plants

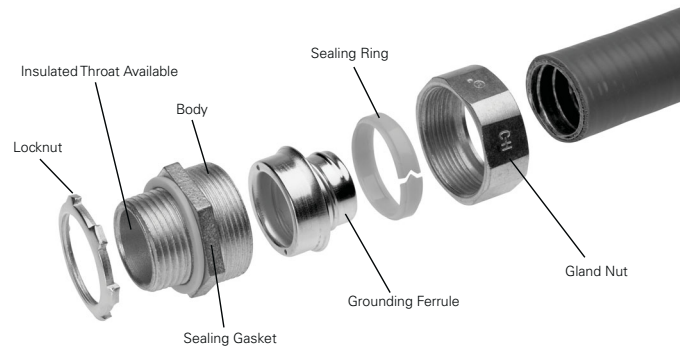

Features:

- Liquidtight, raintight, oiltight for protection and long life in wet, dusty and corrosive environments
- Hex shaped gland nut allows for easy wrenching, providing a fast, tight installation
- Suitable for wet locations
- Reusable, long ferrule prevents pull-out and tight bend conduit pop-out
- Furnished with locknut and sealing ring
- Third party certified
- Available in insulated and non-insulated versions to meet any customer preference

Certifications and Compliances:

- UL Listed liquidtight flexible metal conduit fittings are suitable for use in the following hazardous locations under NEC:
 - Class I, Division 2;
 - Class II, Divisions 1 & 2; and
 - Class III, Divisions 1 & 2;
 - Suitable for grounding in sizes 3/8" through 1 1/4" under NEC
- UL Standards 514B, 467
- cUL Standard C22.2 No. 18F
- UL File No. E-19189



Liquidtight Fittings

Liquidator™ Flexible Metallic Conduit Fittings

Applications:

- Liquidator™ Fittings are used when liquidtight conduit is in tough, industrial and corrosive applications
- Available in both malleable iron and aluminum construction with the option of a ground lug pre-attached

Features:

- Liquidtight, raintight, oiltight for protection and long life in wet, dusty and corrosive environments
- Hex shaped gland nut allows for easy wrenching, providing a fast, tight installation
- Suitable for wet locations
- Reusable, long ferrule prevents pull-out and tight bend conduit pop-out
- Furnished with locknut and sealing ring
- Third party certified
- Available in malleable iron and aluminum construction
- Available in straight, 90 and 45 degree configurations
- Available in sizes $\frac{3}{8}$ " to 6" (select sizes)
- Available in insulated and non-insulated versions to meet any customer preference

Certifications and Compliances:

- UL Listed liquidtight flexible metal conduit fittings are suitable for use in the following hazardous locations under NEC:
 - Class I, Division 2;
 - Class II, Divisions 1 & 2; and
 - Class III, Divisions 1 & 2;
- Suitable for grounding in sizes $\frac{3}{8}$ " through $1\frac{1}{4}$ " under NEC
- UL Standards 514B, 467
- cUL Standard C22.2 No. 18F
- UL File No. E-19189

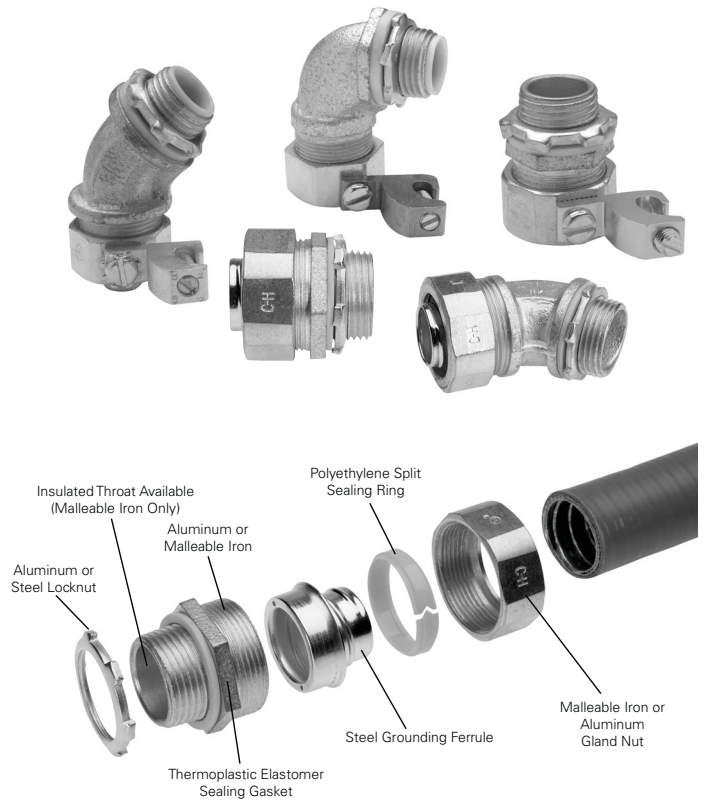

Standard Materials:

- Body – straight – $\frac{3}{8}$ " through 6": malleable iron; $\frac{3}{8}$ " through 4": aluminum
- 45° – $\frac{3}{8}$ " through 4": malleable iron
- 90° – $\frac{3}{8}$ " through 4": malleable iron or aluminum
- Gland nut – malleable iron or aluminum
- Ferrule – steel
- Gland nut sealing ring – polyethylene
- Sealing gasket – thermoplastic elastomer
- Locknut – steel or aluminum

Standard Finishes:

- Malleable iron – zinc electroplate
- Aluminum – natural

Liquidtight Fittings

Liquidator™ Flexible Metallic Conduit Fittings

Straight Connectors – Malleable Iron

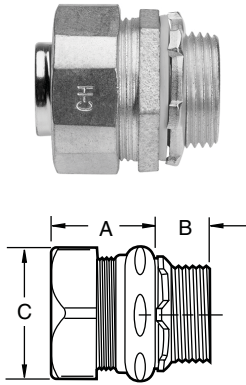

Trade Size	Cat. # Non-insulated	Cat. # Insulated	Unit Qty.	Wt. Lbs. Per 100	A	B	C
3/8"	LT38	LTB38	25	15.4	1.125	0.500	1.125
1/2"	LT50	LTB50	25	17.6	1.250	0.500	1.250
3/4"	LT75	LTB75	25	28.7	1.250	0.500	1.563
1"	LT100	LTB100	5	39.7	1.438	0.625	0.813
1 1/4"	LT125	LTB125	5	55.1	1.500	0.688	2.250
1 1/2"	LT150	LTB150	2	70.5	1.625	0.750	2.438
2"	LT200	LTB200	1	99.2	1.750	0.750	3.000
2 1/2"	LT250	LTB250	1	363.8	2.188	1.000	4.000
3"	LT300	LTB300	1	456.4	2.500	1.125	4.188
3 1/2"	LT350	LTB350	1	668.0	2.625	1.188	5.250
4"	LT400	LTB400	1	789.2	2.750	1.250	5.750
5"	LT500†	LTB500†	1	1036.2	3.125	1.438	6.063
6"	LT600†	LTB600†	1	1366.9	3.375	1.500	7.750

†Not UL Listed or CSA certified.

Liquidtight

Straight Connectors with Grounding Lug – Malleable Iron

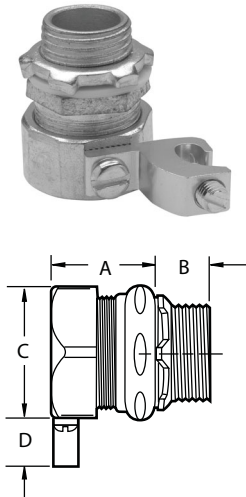

Trade Size	Cat. # Non-insulated with Aluminum Grounding Lug	Cat. # Insulated with Aluminum Grounding Lug	Cat. # Insulated with Copper Grounding Lug	Lug Size	Unit Qty.	Wt. Lbs. Per 100	A	B	C	D
3/8"	LT38G	LTB38G	LTB38GC	#4 - #14	25	17.4	1.125	0.500	1.125	0.750
1/2"	LT50G	LTB50G	LTB50GC	#4 - #14	25	19.5	1.250	0.500	1.250	0.750
3/4"	LT75G	LTB75G	LTB75GC	#4 - #14	25	30.7	1.250	0.500	1.563	0.750
1"	LT100G	LTB100G	LTB100GC	#4 - #14	5	41.7	1.438	0.625	0.813	0.750
1 1/4"	LT125G	LTB125G	LTB125GC	#4 - #14	5	57.0	1.500	0.688	2.250	0.750
1 1/2"	LT150G	LTB150G	LTB150GC	#4 - #14	2	72.4	1.625	0.750	2.438	0.750
2"	LT200G	LTB200G	LTB200GC	#4 - #14	1	100.9	1.750	0.750	3.000	0.750
2 1/2"	LT250G	LTB250G	LTB250GC	#1/0 - #8	1	370.9	2.188	1.000	4.000	1.125
3"	LT300G	LTB300G	LTB300GC	#1/0 - #8	1	462.9	2.500	1.125	4.188	1.125
3 1/2"	LT350G	LTB350G	LTB350GC	#3/0 - #6	1	682.1	2.625	1.188	5.250	1.500
4"	LT400G	LTB400G	LTB400GC	#3/0 - #6	1	802.9	2.750	1.250	5.750	1.500
5"	LT500G†	LTB500G†	-	250MCM - #6	1	1052.7	3.125	1.438	6.063	1.688
6"	LT600G†	LTB600G†	-	250MCM - #6	1	1389.4	3.375	1.500	7.750	1.688

†Not UL Listed or CSA certified.

Straight Connectors with and without Grounding Lug – Aluminum

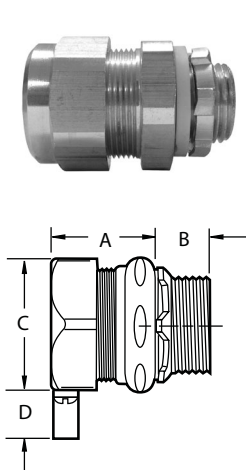

Trade Size	Cat. # Non-insulated	Cat. # Non-insulated with Aluminum Grounding Lug	Lug Size	Unit Qty.	Wt. Lbs. Per 100	A	B	C	D
3/8"	LT38 SA	LT38G SA	#4 - #14	25	13.4	1.188	0.594	1.250	0.750
1/2"	LT50 SA	LT50G SA	#4 - #14	25	15.6	1.313	0.594	1.250	0.750
3/4"	LT75 SA	LT75G SA	#4 - #14	25	26.7	1.313	0.594	1.500	0.750
1"	LT100 SA	LT100G SA	#4 - #14	5	37.7	1.438	0.813	1.750	0.750
1 1/4"	LT125 SA	LT125G SA	#4 - #14	5	53.1	1.563	0.813	2.250	0.750
1 1/2"	LT150 SA	LT150G SA	#4 - #14	2	68.5	1.813	0.813	2.500	0.750
2"	LT200 SA	LT200G SA	#4 - #14	1	97.2	1.750	0.875	3.000	0.750
2 1/2"	LT250 SA	LT250G SA	#1/0 - #8	1	361.8	2.250	1.063	3.750	1.125
3"	LT300 SA	LT300G SA	#1/0 - #8	1	454.4	2.438	1.125	4.500	1.125
3 1/2"	LT350 SA	LT350G SA	#3/0 - #6	1	666.0	2.875	1.188	5.125	1.500
4"	LT400 SA	LT400G SA	#3/0 - #6	1	787.2	2.938	1.250	5.625	1.500

Liquidtight Fittings

Liquidator™ Liquidtight Flexible Metallic Conduit Fittings

90° Angle Connectors – Malleable Iron

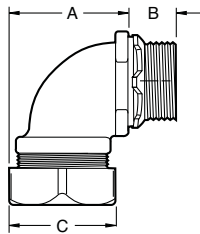

Trade Size	Cat. # Non-insulated	Cat. # Insulated	Unit Qty.	Wt. Lbs. Per 100	A	B	C
3/8"	LT3890	LTB3890	25	25.4	1.313	0.500	1.125
1/2"	LT5090	LTB5090	25	28.9	1.438	0.500	1.250
3/4"	LT7590	LTB7590	10	44.1	1.625	0.500	1.563
1"	LT10090	LTB10090	10	74.5	2.313	0.625	0.813
1 1/4"	LT12590	LTB12590	5	96.1	2.375	0.688	2.250
1 1/2"	LT15090	LTB15090	2	121.3	3.063	0.750	2.438
2"	LT20090	LTB20090	1	176.4	3.188	0.750	3.000
2 1/2"	LT25090	LTB25090	1	837.7	8.313	1.000	4.000
3"	LT30090	LTB30090	1	1234.6	9.813	1.125	4.188
3 1/2"	LT35090	LTB35090	1	1896.0	11.188	1.188	5.250
4"	LT40090	LTB40090	1	2381.0	12.563	1.250	5.750

90° Angle Connectors with Grounding Lug – Malleable Iron

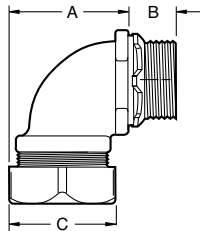

Trade Size	Cat. # Non-insulated with Aluminum Grounding Lug	Cat. # Insulated with Aluminum Grounding Lug	Cat. # Insulated with Copper Grounding Lug	Lug Size	Unit Qty.	Wt. Lbs. Per 100	A	B	C
3/8"	LT3890G	LTB3890G	LTB3890GC	#4 - #14	25	27.6	1.313	0.500	1.125
1/2"	LT5090G	LTB5090G	LTB5090GC	#4 - #14	25	31.1	1.438	0.500	1.250
3/4"	LT7590G	LTB7590G	LTB7590GC	#4 - #14	10	46.3	1.625	0.500	1.563
1"	LT10090G	LTB10090G	LTB10090GC	#4 - #14	10	76.7	2.313	0.625	0.813
1 1/4"	LT12590G	LTB12590G	LTB12590GC	#4 - #14	5	98.3	2.375	0.688	2.250
1 1/2"	LT15090G	LTB15090G	LTB15090GC	#4 - #14	2	123.5	3.063	0.750	2.438
2"	LT20090G	LTB20090G	LTB20090GC	#4 - #14	1	178.6	3.188	0.750	3.000
2 1/2"	LT25090G	LTB25090G	LTB25090GC	#1/0 - #8	1	846.6	8.313	1.000	4.000
3"	LT30090G	LTB30090G	LTB30090GC	#1/0 - #8	1	1243.4	9.813	1.125	4.188
3 1/2"	LT35090G	LTB35090G	LTB35090GC	#3/0 - #6	1	1913.6	11.188	1.188	5.250
4"	LT40090G	LTB40090G	LTB40090GC	#3/0 - #6	1	2398.6	12.563	1.250	5.750

90° Angle Connectors with and without Grounding Lug – Aluminum

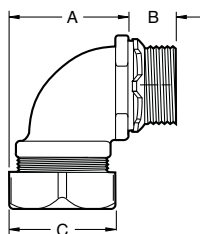

Trade Size	Cat. # Non-insulated	Cat. # Non-insulated with Aluminum Grounding Lug	Lug Size	Unit Qty.	Wt. Lbs. Per 100	A	B	C
3/8"	LT3890 SA	LT3890G SA	#4 - #14	25	16	1.313	0.500	1.125
1/2"	LT5090 SA	LT5090G SA	#4 - #14	25	20	1.438	0.500	1.250
3/4"	LT7590 SA	LT7590G SA	#4 - #14	10	25	1.625	0.500	1.563
1"	LT10090 SA	LT10090G SA	#4 - #14	10	31	2.313	0.625	0.813
1 1/4"	LT12590 SA	LT12590G SA	#4 - #14	5	48	2.375	0.688	2.250
1 1/2"	LT15090 SA	LT15090G SA	#4 - #14	2	150	3.063	0.750	2.438
2"	LT20090 SA	LT20090G SA	#4 - #14	1	200	3.188	0.750	3.000

Liquidtight

Liquidtight Fittings

Liquidator™ Liquidtight Flexible Metallic Conduit Fittings

45° Angle Connectors – Malleable Iron

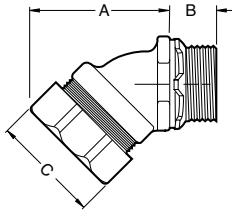

Trade Size	Cat. # Non-insulated	Cat. # Insulated	Unit Qty.	Wt. Lbs. Per 100	A	B	C
3/8"	LT3845	LTB3845	25	27.1	1.938	0.500	1.125
1/2"	LT5045	LTB5045	25	27.1	2.000	0.500	1.250
3/4"	LT7545	LTB7545	10	39.7	2.188	0.500	1.563
1"	LT10045	LTB10045	10	63.5	2.500	0.625	0.813
1 1/4"	LT12545	LTB12545	5	87.3	2.813	0.688	2.250
1 1/2"	LT15045	LTB15045	2	110.2	3.000	0.750	2.438
2"	LT20045	LTB20045	1	176.4	3.688	0.750	3.000
2 1/2"	LT25045	LTB25045	1	573.2	7.313	1.000	4.000
3"	LT30045	LTB30045	1	859.8	7.625	1.125	4.188
3 1/2"	LT35045	LTB35045	1	1278.7	9.625	1.188	5.250
4"	LT40045	LTB40045	1	1521.2	11.063	1.250	5.750

45° Angle Connectors with Grounding Lug – Malleable Iron

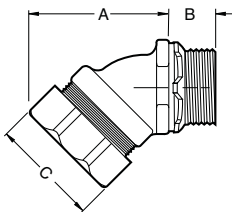

Trade Size	Cat. # Non-insulated with Aluminum Grounding Lug	Cat. # Insulated with Aluminum Grounding Lug	Cat. # Insulated with Copper Grounding Lug	Lug Size	Unit Qty.	Wt. Lbs. Per 100	A	B	C
3/8"	LT3845G	LTB3845G	LTB3845GC	#4 - #14	25	29.3	1.938	0.500	1.125
1/2"	LT5045G	LTB5045G	LTB5045GC	#4 - #14	25	29.3	2.000	0.500	1.250
3/4"	LT7545G	LTB7545G	LTB7545GC	#4 - #14	10	41.9	2.188	0.500	1.563
1"	LT10045G	LTB10045G	LTB10045GC	#4 - #14	10	65.7	2.500	0.625	0.813
1 1/4"	LT12545G	LTB12545G	LTB12545GC	#4 - #14	5	89.5	2.813	0.688	2.250
1 1/2"	LT15045G	LTB15045G	LTB15045GC	#4 - #14	2	112.4	3.000	0.750	2.438
2"	LT20045G	LTB20045G	LTB20045GC	#4 - #14	1	178.6	3.688	0.750	3.000
2 1/2"	LT25045G	LTB25045G	LTB25045GC	#1/0 - #8	1	582.0	7.313	1.000	4.000
3"	LT30045G	LTB30045G	LTB30045GC	#1/0 - #8	1	868.6	7.625	1.125	4.188
3 1/2"	LT35045G	LTB35045G	LTB35045GC	#3/0 - #6	1	1296.3	9.625	1.188	5.250
4"	LT40045G	LTB40045G	LTB40045GC	#3/0 - #6	1	1538.8	11.063	1.250	5.750

Replacement Liquidtight Ferrules



Trade Size	Cat. #	Unit Qty.	Wt. Lbs. Per 100
3/8"	FEA38	100	1.9
1/2"	FEA50	100	2.2
3/4"	FEA75	100	2.5
1"	FEA100	100	3.1
1 1/4"	FEA125	50	5.0
1 1/2"	FEA150	50	6.3
2"	FEA200	10	8.1
2 1/2"	FEA250	10	21.3
3"	FEA300	10	27.5
3 1/2"	FEA350	10	31.3
4"	FEA400	10	34.4