

FEATURES

- Used in high and low bay, aisle and task lighting applications
- Ideal for mounting heights ranging 8 to 40 feet
- Rugged 22 gauge riveted full body steel housing
- 95% specular aluminum reflectors for precise control or finished white reflectors available for wide light distribution
- Tool-less ballast access for easy service
- V-hangers included for chain hanging
- Five year warranty (Terms and Conditions apply)

PROJECT INFORMATION

Project Name _____

Type _____

Catalog No. _____

Date _____

HOUSING

22 gauge riveted steel housing

REFLECTOR

Choice of 95% specular aluminum or finished white aluminum.

BALLASTS

Energy efficient, thermally protected, automatic resetting, Class P, high power factor, sound rated A, unless otherwise specified. CEE NEMA Premium compliant.

CERTIFICATION

All luminaires are built to UL 1598 standards and bear appropriate UL and cUL or CSA labels. Damp location labeling is standard.

ELECTRICAL

Standard class "P," thermally protected, auto-resetting HPF ballast, sound rated A. CEE NEMA Premium compliant. All ballast leads extend a minimum of 6" through access location. NEC/CEC-compliant ballast disconnect is standard.

WARRANTY

Five year warranty (Terms and Conditions apply).

FINISH

Painted parts are treated with a five stage phosphate bonding process and finished with a high reflectance baked white enamel. End caps are painted after fabrication as standard.

ORDERING INFORMATION

EXAMPLE LHS4-454-M4R-4EPU

LHS		4 -		-		U -			
MODEL	NO. OF LAMPS IN CROSS SECTION	LAMP TYPE	SIZE	REFLECTOR	BALLAST	VOLTAGE	LAMPS INSTALLED	OPTIONS	
LHS Slim Body Linear High Bay	4 Four 6 Six	32 4', T8: 32, 30, 28, or 25 Watt 54 4', T5HO: 54, 51, or 49 Watt	4 4'	M4R Aluminum 95% Reflective, Specular Silver (Narrow Beam) GW Gloss White (Wide Beam)	T8 4EHL (1) 4-Lamp Electronic T8 High Light Output, Instant Start 3EHL (2) 3-Lamp Electronic T8 High Light Output, Instant Start 4EPHL (1) 4-Lamp Electronic T8 High Light Output, Programmed Start 3EPHL (2) 3-Lamp Electronic T8 High Light Output, Programmed Start T5HO 4EP (1) 4-Lamp Electronic T5HO, Programmed Start 24EP (1) 4-Lamp and (1) 2-Lamp Electronic T5HO, Programmed Start	U 120V-277V	T8 F0841 85 CRI, 4100K F0850 85 CRI, 5000K T5HO F5841 85 CRI, 4100K F5850 85 CRI, 5000K	F3C5 3-Conductor Cord F4C5 4-Conductor Cord C8TL15 8' Cord and Twist-Lock™ Plug 15A (Add Voltage: 1=120, 2=277) C8P151 8' Cord and Straight Blade Plug 15A EL Emergency Battery Pack, T8 1100-1200 Lumens, 1 Lamp or T5HO 1150 Lumens, 1 Lamp WG Cage Type Wire Guard NYC NYC Compliant	
ACCESSORIES (ORDER SEPARATELY)									
LHTG5	Y-Fit Toggle Hanger, 5' Adjustable, Pair								
LHTG10	Y-Fit Toggle Hanger, 10' Adjustable, Pair								
LHS432WGK	Wire Guard for 4-Lamp T8 Fixture								
LHS454WGK	Wire Guard for 4-Lamp T5HO Fixture								
LHS632WGK	Wire Guard for 6-Lamp T8 Fixture								
LHS654WGK	Wire Guard for 6-Lamp T5HO Fixture								
GLH5	5', Adjustable Cable Kit								
GLH10	10', Adjustable Cable Kit								
GLH15	15', Adjustable Cable Kit								
OS1360K	Occupancy/Daylight sensor kit, 120/277/347V, one relay, 360 Lens, snap on drop down adaptor, quick connect wiring*								
OS2360K	Occupancy/Daylight sensor kit, 120/277/347V, two relay, 360 Lens, snap on drop down adaptor, quick connect wiring*								

*Use programmed start ballast. Not recommended for use with an instant start. For more occupancy/daylight harvesting sensor accessories contact your Columbia Lighting representative.

PHOTOMETRIC DATA

LUMINAIRE DATA

Luminaire	LHS4-632-M4R-3EU Linear Fluorescent High Bay Industrial 17" x 48", 6-lamp T8 with specular reflectors
Ballast	(2) GE-332-MAX-H/ ULTRA
Ballast Factor	1.18
Lamp	F32T8
Lumens per Lamp	2950
Watts	217
Mounting	Suspended
Shielding Angle	0° = 0 90° = 0
Spacing Criterion	0° = 1.24 90° = 1.57
Luminous Opening in Feet	Length: 4.00 Width: 1.33 Height: 0.00

AVG. LUMINANCE (Candela/Sq. M.)

	0.0	22.5	45.0	67.5	90.0
0	8963	8963	8963	8963	8963
30	8675	9289	11051	11787	11955
40	8373	9910	11558	11637	11471
45	8166	10184	11463	10988	10762
50	7913	10353	10866	10205	10013
55	7595	10392	10085	9694	10050
60	7203	10197	9263	10687	11602
65	6712	9532	9604	12203	12874
70	6081	8359	11287	13358	13754
75	5261	7622	12399	13743	14079
80	4125	9496	12607	13854	14262
85	2577	9704	13024	15346	16112

COEFFICIENTS OF UTILIZATION (%)

RC	80				70				50				0
	RW	70	50	30	10	70	50	30	10	50	30	10	0
1	98	94	89	85	96	91	87	84	87	84	81	74	
2	89	81	74	68	86	79	73	67	75	70	66	60	
3	81	70	62	56	78	69	61	55	66	60	54	50	
4	74	62	54	47	71	61	53	47	58	51	46	42	
5	68	55	47	40	65	54	46	40	52	45	39	36	
6	62	49	41	35	60	49	40	35	47	40	34	31	
7	58	45	36	31	56	44	36	30	42	35	30	28	
8	54	41	33	27	52	40	32	27	39	32	27	24	
9	50	37	29	24	49	37	29	24	35	29	24	22	
10	47	34	27	22	45	34	27	22	33	26	22	20	

Test 19448 Test Date 04/13/09

INDOOR CANDELA PLOT

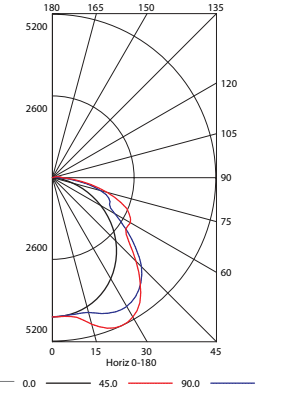

ZONAL LUMEN SUMMARY

Zone	Lumens	Lamp	Fixt.
0-30	3822	21.6	23.5
0-40	6549	37.0	40.3
0-60	11875	67.1	73.1
0-90	16051	90.7	98.8
0-180	16244	91.8	100.0

ENERGY DATA

Total Luminaire Efficiency	91.8%
Luminaire Efficacy Rating (LER)	88
IESNA RP-1-2004 Compliance	Non-Compliant
Comparative Yearly Lighting Energy Cost per 1000 Lumens	\$2.73 based on 3000 hrs. and \$0.08 per KWH

RCR = Room Cavity Ratio

RC = Effective Ceiling Cavity Reflectance RW = Wall Reflectance

LUMINAIRE DATA

Luminaire	LHS4-454-M4R-4EPU Linear Fluorescent High Bay Industrial 12" x 48", 4-lamp T5HO with specular reflectors
Ballast	ICN-4554-90C-2LS-G
Ballast Factor	1.00
Lamp	F54T5HO
Lumens per Lamp	4500
Watts	226
Shielding Angle	0° = 0 90° = 0
Spacing Criterion	0° = 1.21 90° = 1.05
Luminous Opening in Feet	Length: 4.00 Width: 0.92 Height: 0.00

AVG. LUMINANCE (Candela/Sq. M.)

	0.0	22.5	45.0	67.5	90.0
0	18928	18928	18928	18928	18928
30	17776	17104	15776	15178	14966
40	16991	15640	14273	13078	12677
45	16476	14747	13204	12124	12008
50	15840	13838	12004	11708	11827
55	15039	12948	11178	11647	12081
60	14046	11823	10869	12250	12958
65	12776	10319	11150	13531	14541
70	11066	8997	12315	15924	17318
75	8872	8487	14895	19416	20704
80	6232	9601	18495	22066	22993
85	3121	12518	19399	22386	23023

COEFFICIENTS OF UTILIZATION (%)

RC	80				70				50				0
	RW	70	50	30	10	70	50	30	10	50	30	10	0
1	94	90	86	82	92	88	84	81	84	81	79	72	
2	86	78	72	67	83	77	71	66	74	69	65	60	
3	78	69	62	56	76	68	61	56	65	59	55	51	
4	72	61	54	48	70	60	53	47	58	52	47	44	
5	66	55	47	41	65	54	47	41	52	46	41	38	
6	61	50	42	36	60	49	42	36	47	41	36	34	
7	57	45	38	32	56	45	37	32	43	37	32	30	
8	53	42	34	29	52	41	34	29	40	33	29	27	
9	50	38	31	26	49	38	31	26	37	31	26	24	
10	47	35	29	24	46	35	28	24	34	28	24	22	

Test 22716 Test Date 04/13/09

INDOOR CANDELA PLOT

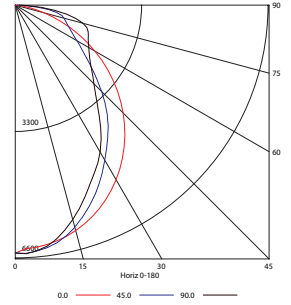

ZONAL LUMEN SUMMARY

Zone	Lumens	Lamp	Fixt.
0-30	4687	26.0	29.8
0-40	7372	41.0	46.9
0-60	12087	67.1	76.9
0-90	15715	87.3	100.0
0-180	15715	87.3	100.0

ENERGY DATA

Total Luminaire Efficiency	87.3%
Luminaire Efficacy Rating (LER)	70
IESNA RP-1-2004 Compliance	Noncompliant
Comparative Yearly Lighting Energy Cost per 1000 Lumens	\$3.43 based on 3000 hrs. and \$0.08 per KWH

RCR = Room Cavity Ratio

RC = Effective Ceiling Cavity Reflectance RW = Wall Reflectance

DIMENSIONAL DATA

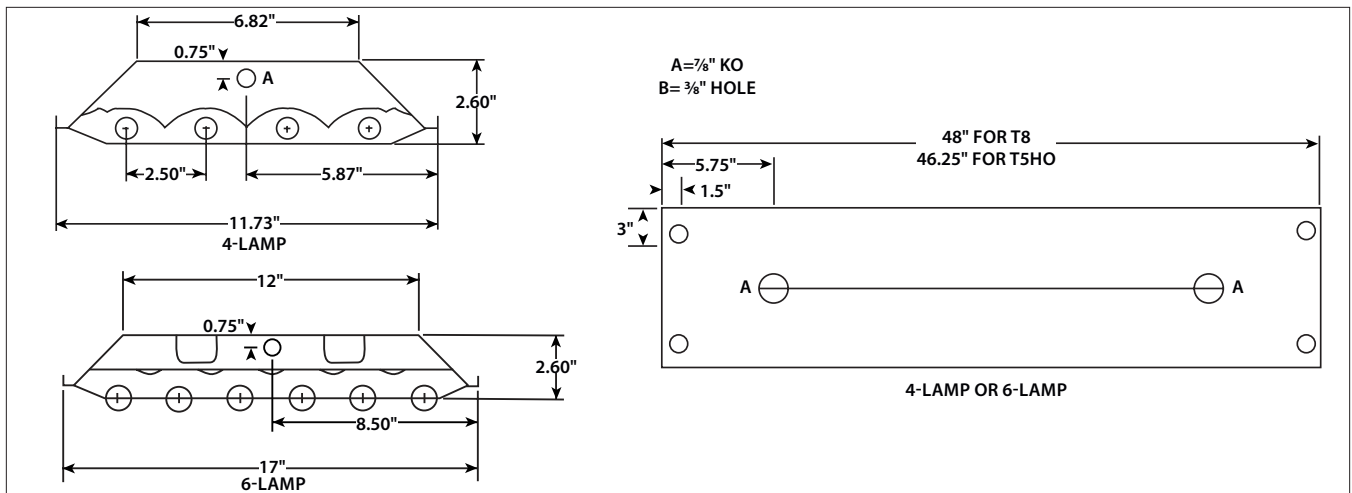

NOTE: All dimensions are in inches; dimensions and specifications are subject to change without notice. Please consult factory or check sample for verification.

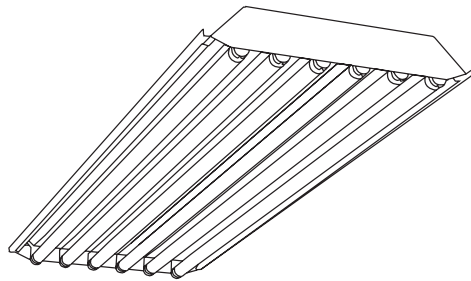

FEATURES

- Used in high and low bay, aisle and task lighting applications
- Ideal for mounting heights ranging 8 to 40 feet
- Rugged 22 gauge riveted full body steel housing
- 95% specular aluminum reflectors for precise control or finished white reflectors available for wide light distribution
- Tool-less ballast access for easy service
- V-hangers included for chain hanging
- Five year warranty (Terms and Conditions apply)

PROJECT INFORMATION

Project Name _____

Type _____

Catalog No. _____

Date _____

HOUSING

22 gauge riveted steel housing

REFLECTOR

Choice of 95% specular aluminum or finished white aluminum.

BALLASTS

Energy efficient, thermally protected, automatic resetting, Class P, high power factor, sound rated A, unless otherwise specified. CEE NEMA Premium compliant.

CERTIFICATION

All luminaires are built to UL 1598 standards and bear appropriate UL and cUL or CSA labels. Damp location labeling is standard.

ELECTRICAL

Standard class "P," thermally protected, auto-resetting HPF ballast, sound rated A. CEE NEMA Premium compliant. All ballast leads extend a minimum of 6" through access location. NEC/CEC-compliant ballast disconnect is standard.

WARRANTY

Five year warranty (Terms and Conditions apply).

FINISH

Painted parts are treated with a five stage phosphate bonding process and finished with a high reflectance baked white enamel. End caps are painted after fabrication as standard.

ORDERING INFORMATION

EXAMPLE LHS4-454-M4R-4EPU

LHS		4 -		-		U -	
MODEL	NO. OF LAMPS IN CROSS SECTION	LAMP TYPE	SIZE	REFLECTOR	BALLAST	VOLTAGE	OPTIONS
LHS Slim Body Linear High Bay	4 Four 6 Six	32 4', T8: 32, 30, 28, or 25 Watt 54 4', T5HO: 54, 51, or 49 Watt	4 4'	M4R Aluminum 95% Reflective, Specular Silver (Narrow Beam) GW Gloss White (Wide Beam)	T8 4EHL (1) 4-Lamp Electronic T8 High Light Output, Instant Start 3EHL (2) 3-Lamp Electronic T8 High Light Output, Instant Start 4EPHL (1) 4-Lamp Electronic T8 High Light Output, Programmed Start 3EPHL (2) 3-Lamp Electronic T8 High Light Output, Programmed Start T5HO 4EP (1) 4-Lamp Electronic T5HO, Programmed Start 24EP (1) 4-Lamp and (1) 2-Lamp Electronic T5HO, Programmed Start	U 120V-277V LAMPS INSTALLED T8 F0841 85 CRI, 4100K F0850 85 CRI, 5000K T5HO F5841 85 CRI, 4100K F5850 85 CRI, 5000K	F3CS 3-Conductor Cord F4CS 4-Conductor Cord C8TL15 8' Cord and Twist-Lock™ Plug 15A (Add Voltage: 1=120, 2=277) C8P151 8' Cord and Straight Blade Plug 15A EL Emergency Battery Pack, T8 1100-1200 Lumens, 1 Lamp or T5HO 1150 Lumens, 1 Lamp WG Cage Type Wire Guard NYC NYC Compliant
ACCESSORIES (ORDER SEPARATELY)							
LHTG5	Y-Fit Toggle Hanger, 5' Adjustable, Pair						
LHTG10	Y-Fit Toggle Hanger, 10' Adjustable, Pair						
LHS432WGK	Wire Guard for 4-Lamp T8 Fixture						
LHS454WGK	Wire Guard for 4-Lamp T5HO Fixture						
LHS632WGK	Wire Guard for 6-Lamp T8 Fixture						
LHS654WGK	Wire Guard for 6-Lamp T5HO Fixture						
GLH5	5', Adjustable Cable Kit						
GLH10	10', Adjustable Cable Kit						
GLH15	15', Adjustable Cable Kit						
OS1360K	Occupancy/Daylight sensor kit, 120/277/347V, one relay, 360 Lens, snap on drop down adaptor, quick connect wiring*						
OS2360K	Occupancy/Daylight sensor kit, 120/277/347V, two relay, 360 Lens, snap on drop down adaptor, quick connect wiring*						

*Use programmed start ballast. Not recommended for use with an instant start. For more occupancy/daylight harvesting sensor accessories contact your Columbia Lighting representative.

PHOTOMETRIC DATA

LUMINAIRE DATA

Luminaire	LHS4-632-M4R-3EU Linear Fluorescent High Bay Industrial 17" x 48", 6-lamp T8 with specular reflectors
Ballast	(2) GE-332-MAX-H/ULTRA
Ballast Factor	1.18
Lamp	F32T8
Lumens per Lamp	2950
Watts	217
Mounting	Suspended
Shielding Angle	0° = 0 90° = 0
Spacing Criterion	0° = 1.24 90° = 1.57
Luminous Opening in Feet	Length: 4.00 Width: 1.33 Height: 0.00

AVG. LUMINANCE (Candela/Sq. M.)

Average Luminance Angle	0.0	22.5	45.0	67.5	90.0
0	8963	8963	8963	8963	8963
30	8675	9289	11051	11787	11955
40	8373	9910	11558	11637	11471
45	8166	10184	11463	10988	10762
50	7913	10353	10866	10205	10013
55	7595	10392	10085	9694	10050
60	7203	10197	9263	10687	11602
65	6712	9532	9604	12203	12874
70	6081	8359	11287	13358	13754
75	5261	7622	12399	13743	14079
80	4125	9496	12607	13854	14262
85	2577	9704	13024	15346	16112

COEFFICIENTS OF UTILIZATION (%)

RC	80				70				50				0
	RW	70	50	30	10	70	50	30	10	50	30	10	0
1	98	94	89	85	96	91	87	84	87	84	81	74	
2	89	81	74	68	86	79	73	67	75	70	66	60	
3	81	70	62	56	78	69	61	55	66	60	54	50	
4	74	62	54	47	71	61	53	47	58	51	46	42	
5	68	55	47	40	65	54	46	40	52	45	39	36	
6	62	49	41	35	60	49	40	35	47	40	34	31	
7	58	45	36	31	56	44	36	30	42	35	30	28	
8	54	41	33	27	52	40	32	27	39	32	27	24	
9	50	37	29	24	49	37	29	24	35	29	24	22	
10	47	34	27	22	45	34	27	22	33	26	22	20	

INDOOR CANDELA PLOT

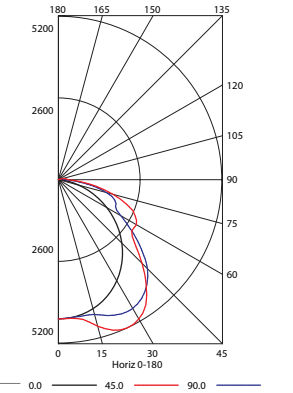

ZONAL LUMEN SUMMARY

Zone	Lumens	Lamp	Fixt.
0-30	3822	21.6	23.5
0-40	6549	37.0	40.3
0-60	11875	67.1	73.1
0-90	16051	90.7	98.8
0-180	16244	91.8	100.0

ENERGY DATA

Total Luminaire Efficiency	91.8%
Luminaire Efficacy Rating (LER)	88
IESNA RP-1-2004 Compliance	Non-Compliant
Comparative Yearly Lighting Energy Cost per 1000 Lumens	\$2.73 based on 3000 hrs. and \$0.08 per KWH

LUMINAIRE DATA

Luminaire	LHS4-454-M4R-4EPU Linear Fluorescent High Bay Industrial 12" x 48", 4-lamp T5HO with specular reflectors
Ballast	ICN-4554-90C-2LS-G
Ballast Factor	1.00
Lamp	F54T5HO
Lumens per Lamp	4500
Watts	226
Shielding Angle	0° = 0 90° = 0
Spacing Criterion	0° = 1.21 90° = 1.05
Luminous Opening in Feet	Length: 4.00 Width: 0.92 Height: 0.00

AVG. LUMINANCE (Candela/Sq. M.)

Average Luminance Angle	0.0	22.5	45.0	67.5	90.0
0	18928	18928	18928	18928	18928
30	17776	17104	15776	15178	14966
40	16991	15640	14273	13078	12677
45	16476	14747	13204	12124	12008
50	15840	13838	12004	11708	11827
55	15039	12948	11178	11647	12081
60	14046	11823	10869	12250	12958
65	12776	10319	11150	13531	14541
70	11066	8997	12315	15924	17318
75	8872	8487	14895	19416	20704
80	6232	9601	18495	22066	22993
85	3121	12518	19399	22386	23023

COEFFICIENTS OF UTILIZATION (%)

RC	80				70				50				0
	RW	70	50	30	10	70	50	30	10	50	30	10	0
1	94	90	86	82	92	88	84	81	84	81	79	72	
2	86	78	72	67	83	77	71	66	74	69	65	60	
3	78	69	62	56	76	68	61	56	65	59	55	51	
4	72	61	54	48	70	60	53	47	58	52	47	44	
5	66	55	47	41	65	54	47	41	52	46	41	38	
6	61	50	42	36	60	49	42	36	47	41	36	34	
7	57	45	38	32	56	45	37	32	43	37	32	30	
8	53	42	34	29	52	41	34	29	40	33	29	27	
9	50	38	31	26	49	38	31	26	37	31	26	24	
10	47	35	29	24	46	35	28	24	34	28	24	22	

INDOOR CANDELA PLOT

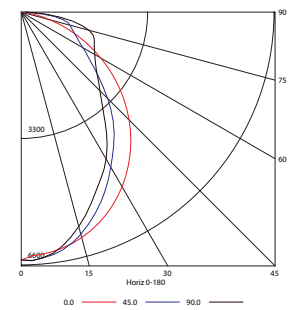

ZONAL LUMEN SUMMARY

Zone	Lumens	Lamp	Fixt.
0-30	4687	26.0	29.8
0-40	7372	41.0	46.9
0-60	12087	67.1	76.9
0-90	15715	87.3	100.0
0-180	15715	87.3	100.0

ENERGY DATA

Total Luminaire Efficiency	87.3%
Luminaire Efficacy Rating (LER)	70
IESNA RP-1-2004 Compliance	Noncompliant
Comparative Yearly Lighting Energy Cost per 1000 Lumens	\$3.43 based on 3000 hrs. and \$0.08 per KWH

DIMENSIONAL DATA

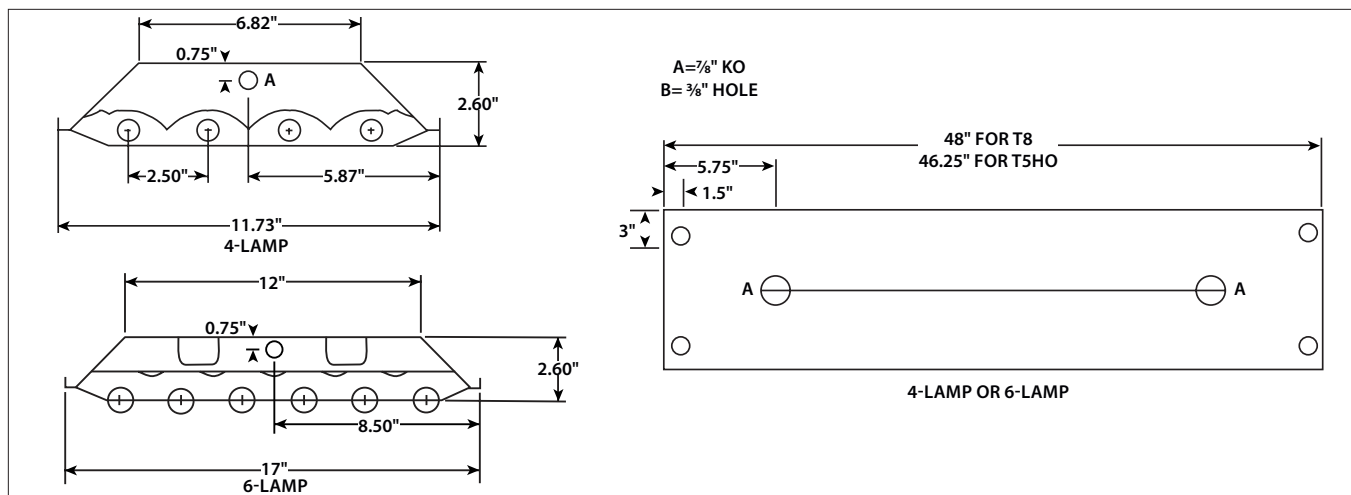

NOTE: All dimensions are in inches; dimensions and specifications are subject to change without notice. Please consult factory or check sample for verification.