



PASS & SEYMOUR®

Turnlok® Extra-Hard Use Plugs & Connectors
4 Wire 20 & 30A; 125 & 250V, 3ø 250 & 480V, 3øY 120/208V

L1420, L1520, L1620, L1820, L1430, L1530, L1630, L1830

Tough enough for industrial environments.

Every component of these durable Turnlok locking plugs and connectors are built to offer the lowest installed cost with maximum durability. Quick-thread assembly screws install four times faster than competitive product and backed-out screws come ready-to-wire. The rugged easy-to-grip nylon housing, clear thermoplastic terminal chambers as well as high-strength brass alloy blades and contacts combine to give Legrand the premium selection of P&S Turnlok plugs and connectors.

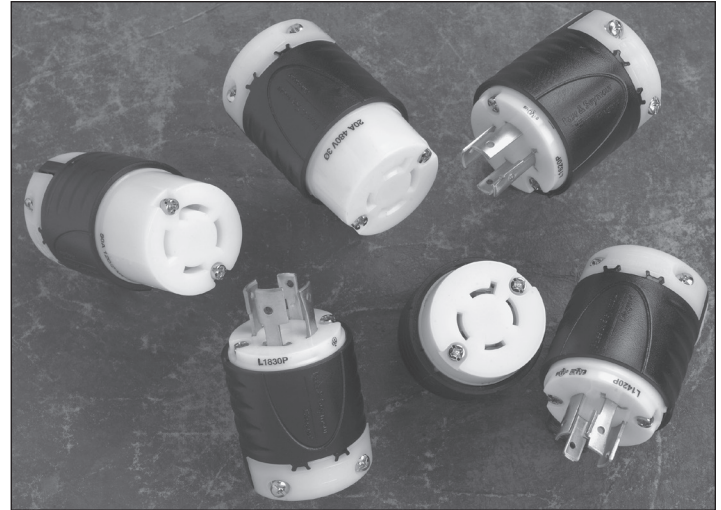

FEATURES & BENEFITS

Rounded back contour reduces snags and hang-ups on the job site.

Visible stamped NEMA configuration and device rating.

Raised ribs provide non-slip gripping profile for turning to lock and unlock.

Industrial-strength, brass alloy plug blades and connector contacts resist heat rise, provide excellent conductivity.

Double dovetail design provides superior protection against cord pull-out forces.



Impact- and corrosion-resistant durable nylon 6/6 shell material.

L1420C & L1420P

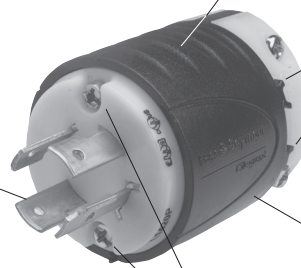

Scallop shell design provides non-slip gripping surface for insertion and withdrawal.

External cord grips provide visible assurance of safe and proper cord retention.

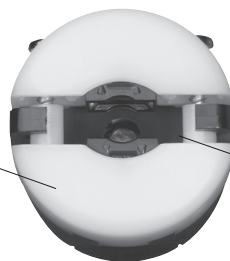

Quick-thread assembly screws and cord-grip screws come backed-out, ready-to-wire. Installs four times faster.

Integral flexible rubber cord grommet conforms to and seals around SO cord to provide protection from oils, water, or chips entering wiring chamber.

FIELD USES/VERTICAL MARKETS

- Industrial
- Health Care
- Education
- Institutional
- Retail
- Office
- Hospitality/Lodging

ORDERING INFORMATION

Catalog Number	Rating A. V.	Description/Color	Cord Diameter	NEMA Config. No.
Connectors IP20 Suitability				
L1420C	20 125/250	Black Back, White Front Body	.225"-1.150"	L14-20R
L1520C	20 3ø, 250	Black Back, White Front Body	.225"-1.150"	L15-20R
L1620C	20 3ø, 480	Black Back, White Front Body	.225"-1.150"	L16-20R
L1820C	20 3øY, 120/208	Black Back, White Front Body	.225"-1.150"	L18-20R
L1430C	30 125/250	Black Back, White Front Body	.225"-1.150"	L14-30R
L1530C	30 3ø, 250	Black Back, Black Front Body	.225"-1.150"	L15-30R
L1630C	30 3ø, 480	Black Back, Black Front Body	.225"-1.150"	L16-30R
L1830C	30 3øY, 120/208	Black Back, White Front Body	.225"-1.150"	L18-30R
Plugs IP20 Suitability				
L1420P	20 125/250	Black Back, White Front Body	.225"-1.150"	L14-20P
L1520P	20 3ø, 250	Black Back, White Front Body	.225"-1.150"	L15-20P
L1620P	20 3ø, 480	Black Back, White Front Body	.225"-1.150"	L16-20P
L1820P	20 3øY, 120/208	Black Back, White Front Body	.225"-1.150"	L18-20P
L1430P	30 125/250	Black Back, White Front Body	.225"-1.150"	L14-30P
L1530P	30 3ø, 250	Black Back, White Front Body	.225"-1.150"	L15-30P
L1630P	30 3ø, 480	Black Back, White Front Body	.225"-1.150"	L16-30P
L1830P	30 3øY, 120/208	Black Back, White Front Body	.225"-1.150"	L18-30P

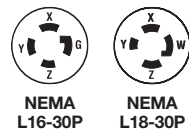
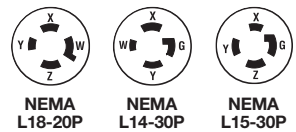
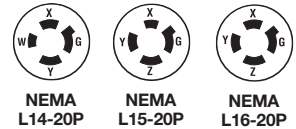
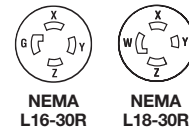
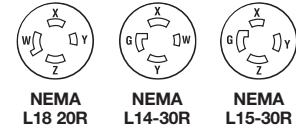
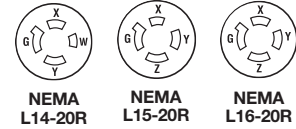

Download this product's PEP ecopassport® environmental product declaration at www.legrand.us/resources-and-downloads. This declaration conforms with ISO 14025 and 14040 and is in alignment with EN 15804.

For more information on these and other P&S products refer to our Catalog or visit our web site.

Turnlok® Extra-Hard Use Plugs & Connectors 4 Wire 20 & 30A; 125 & 250V, 3Ø 250 & 480V, 3ØY 120/208V

TECHNICAL SPECIFICATIONS

3rd Party Compliance

UL Listed, File Number E146159, Standard UL498, Attachment Plugs and Receptacles. Federal Specification WC596.
CSA Certified, File Number LR1765, Standard CSA-C22.2 No. 42, General Use Receptacles and Attachment Plugs.
Conforms to NEMA WD-1 and WD-6.

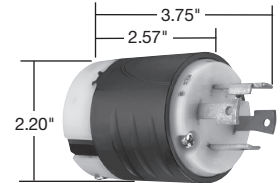

**Dimensions for
20 & 30 Amp Plug**

Performance

Electrical

Dielectric Withstand Voltage	2200V minimum
Maximum Working Voltage	600VAC
Current Interrupting	Certified for current interrupting at full-rated current
Temperature Rise	30°C maximum after 50 cycles at 150% rated current

Mechanical

Cord Accommodations	Round portable service cords of diameters in accordance with the device rating as defined in UL62
Cord Grip Accommodations	.225"-1.150" diameter
Terminal Identification	"GR" and Green color = Ground, "WH" and White color = Neutral, "X", "Y", "Z" = Hot
Terminal Accommodation	#18 AWG min. – #8 AWG max.
Product Identification	Amperage, Voltage, 3rd Party Compliance, NEMA Configuration hot stamped onto device

Environmental

Flammability	UL94 V2
Operating Temperature	Maximum continuous +75°C, minimum -40°C without impact



**Dimensions for
20 & 30 Amp Connector**

Materials

Back Body	Super Tough Nylon
Front Body	Nylon
Terminal Chamber	Polycarbonate
Cord Clamp	Nylon
Insert	Nylon
Dust Cover	Kraton
Plug Blades	Brass
Connector Contacts	Brass
Terminal Clamp	20A = Nickel-Plated Steel 30A = Brass
Terminal Screws	Brass
Ground Screws	Brass
Cord Clamp Screws	Nickel-Plated Steel
Assembly Screws	Nickel-Plated Steel

Warranty

1 Year

NOTES

ALSO AVAILABLE...

- USB Charging Devices
- Hospital Grade Devices
- PlugTail™ Devices
- Switches
- Straight Blade Receptacles
- Lighting & Fan Controls
- GFCIs
- Weatherproof Boxes & Covers
- Wall Plates
- Flexcor® Wire Mesh Grips



Electrical Wiring Systems

P.O. Box 4822
Syracuse, NY 13221-4822
Phone: 1.800.776.4035
www.legrand.us/passandseymour
570 Applewood Crescent
Vaughan, Ontario L4K 4B4
Phone: 905.738.9195
www.legrand.ca





PASS & SEYMOUR®

Turnlok® Extra-Hard Use Plugs & Connectors
4 Wire 20 & 30A; 125 & 250V, 3ø 250 & 480V, 3øY 120/208V

L1420, L1520, L1620, L1820, L1430, L1530, L1630, L1830

Tough enough for industrial environments.

Every component of these durable Turnlok locking plugs and connectors are built to offer the lowest installed cost with maximum durability. Quick-thread assembly screws install four times faster than competitive product and backed-out screws come ready-to-wire. The rugged easy-to-grip nylon housing, clear thermoplastic terminal chambers as well as high-strength brass alloy blades and contacts combine to give Legrand the premium selection of P&S Turnlok plugs and connectors.

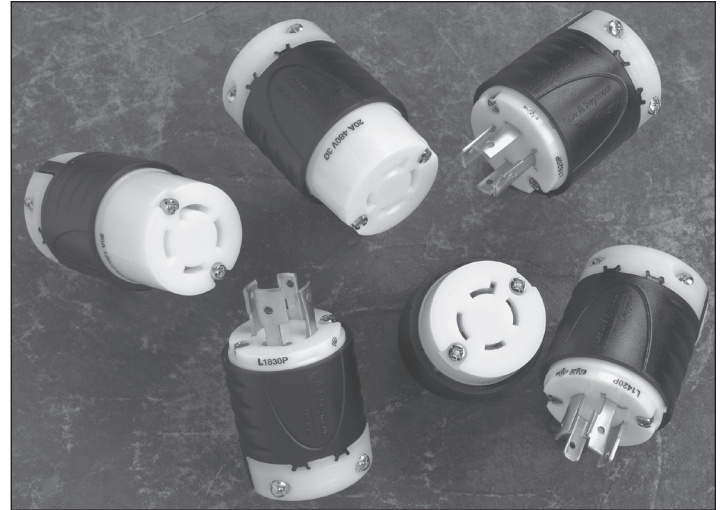

FEATURES & BENEFITS

Rounded back contour reduces snags and hang-ups on the job site.

Visible stamped NEMA configuration and device rating.

Raised ribs provide non-slip gripping profile for turning to lock and unlock.

Industrial-strength, brass alloy plug blades and connector contacts resist heat rise, provide excellent conductivity.

Double dovetail design provides superior protection against cord pull-out forces.

Impact- and corrosion-resistant durable nylon 6/6 shell material.

Scallop shell design provides non-slip gripping surface for insertion and withdrawal.

L1420C & L1420P

Quick-thread assembly screws and cord-grip screws come backed-out, ready-to-wire. Installs four times faster.

External cord grips provide visible assurance of safe and proper cord retention.

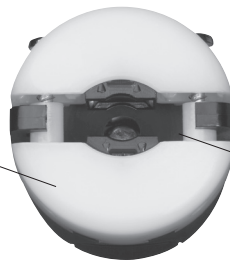

Integral flexible rubber cord grommet conforms to and seals around SO cord to provide protection from oils, water, or chips entering wiring chamber.

FIELD USES/VERTICAL MARKETS

- Industrial
- Health Care
- Education
- Institutional
- Retail
- Office
- Hospitality/Lodging

ORDERING INFORMATION

Catalog Number	Rating A. V.	Description/Color	Cord Diameter	NEMA Config. No.
Connectors IP20 Suitability				
L1420C	20 125/250	Black Back, White Front Body	.225"-1.150"	L14-20R
L1520C	20 3ø, 250	Black Back, White Front Body	.225"-1.150"	L15-20R
L1620C	20 3ø, 480	Black Back, White Front Body	.225"-1.150"	L16-20R
L1820C	20 3øY, 120/208	Black Back, White Front Body	.225"-1.150"	L18-20R
L1430C	30 125/250	Black Back, White Front Body	.225"-1.150"	L14-30R
L1530C	30 3ø, 250	Black Back, Black Front Body	.225"-1.150"	L15-30R
L1630C	30 3ø, 480	Black Back, Black Front Body	.225"-1.150"	L16-30R
L1830C	30 3øY, 120/208	Black Back, White Front Body	.225"-1.150"	L18-30R
Plugs IP20 Suitability				
L1420P	20 125/250	Black Back, White Front Body	.225"-1.150"	L14-20P
L1520P	20 3ø, 250	Black Back, White Front Body	.225"-1.150"	L15-20P
L1620P	20 3ø, 480	Black Back, White Front Body	.225"-1.150"	L16-20P
L1820P	20 3øY, 120/208	Black Back, White Front Body	.225"-1.150"	L18-20P
L1430P	30 125/250	Black Back, White Front Body	.225"-1.150"	L14-30P
L1530P	30 3ø, 250	Black Back, White Front Body	.225"-1.150"	L15-30P
L1630P	30 3ø, 480	Black Back, White Front Body	.225"-1.150"	L16-30P
L1830P	30 3øY, 120/208	Black Back, White Front Body	.225"-1.150"	L18-30P

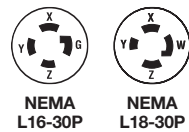
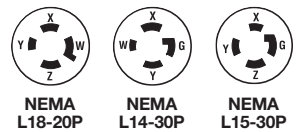
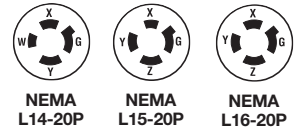
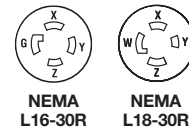
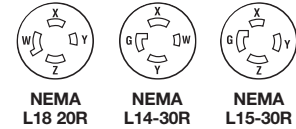
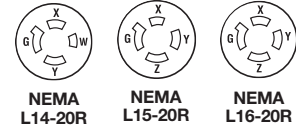

Download this product's PEP ecopassport® environmental product declaration at www.legrand.us/resources-and-downloads. This declaration conforms with ISO 14025 and 14040 and is in alignment with EN 15804.

For more information on these and other P&S products refer to our Catalog or visit our web site.

Turnlok® Extra-Hard Use Plugs & Connectors 4 Wire 20 & 30A; 125 & 250V, 3Ø 250 & 480V, 3ØY 120/208V

TECHNICAL SPECIFICATIONS

3rd Party Compliance

UL Listed, File Number E146159, Standard UL498, Attachment Plugs and Receptacles. Federal Specification WC596.
CSA Certified, File Number LR1765, Standard CSA-C22.2 No. 42, General Use Receptacles and Attachment Plugs.
Conforms to NEMA WD-1 and WD-6.

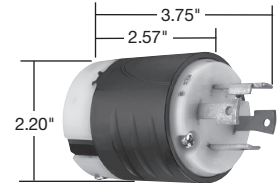

**Dimensions for
20 & 30 Amp Plug**

Performance

Electrical

Dielectric Withstand Voltage	2200V minimum
Maximum Working Voltage	600VAC
Current Interrupting	Certified for current interrupting at full-rated current
Temperature Rise	30°C maximum after 50 cycles at 150% rated current

Mechanical

Cord Accommodations	Round portable service cords of diameters in accordance with the device rating as defined in UL62
Cord Grip Accommodations	.225"-1.150" diameter
Terminal Identification	"GR" and Green color = Ground, "WH" and White color = Neutral, "X", "Y", "Z" = Hot
Terminal Accommodation	#18 AWG min. – #8 AWG max.
Product Identification	Amperage, Voltage, 3rd Party Compliance, NEMA Configuration hot stamped onto device

Environmental

Flammability	UL94 V2
Operating Temperature	Maximum continuous +75°C, minimum -40°C without impact



**Dimensions for
20 & 30 Amp Connector**

Materials

Back Body	Super Tough Nylon
Front Body	Nylon
Terminal Chamber	Polycarbonate
Cord Clamp	Nylon
Insert	Nylon
Dust Cover	Kraton
Plug Blades	Brass
Connector Contacts	Brass
Terminal Clamp	20A = Nickel-Plated Steel 30A = Brass
Terminal Screws	Brass
Ground Screws	Brass
Cord Clamp Screws	Nickel-Plated Steel
Assembly Screws	Nickel-Plated Steel

Warranty

1 Year

NOTES

ALSO AVAILABLE...

- USB Charging Devices
- Hospital Grade Devices
- PlugTail™ Devices
- Switches
- Straight Blade Receptacles
- Lighting & Fan Controls
- GFCIs
- Weatherproof Boxes & Covers
- Wall Plates
- Flexcor® Wire Mesh Grips



Electrical Wiring Systems

P.O. Box 4822
Syracuse, NY 13221-4822
Phone: 1.800.776.4035
www.legrand.us/passandseymour
570 Applewood Crescent
Vaughan, Ontario L4K 4B4
Phone: 905.738.9195
www.legrand.ca

