



**MILBANK**<sup>®</sup>  
ENERGY AT WORK



# Upstate New York

*Meter Mounting Equipment*



# Milbank Overview

## *Energy At Work since 1927*

Milbank designs and manufactures electrical solutions that move and manage power for the residential, commercial, industrial, utility and transportation sectors. With 90 years of expertise in electrical engineering design and manufacturing, Milbank's portfolio includes metering equipment, enclosures and enclosed controls. Founded in 1927, Milbank is a family-owned, American manufacturer headquartered in Kansas City, Mo. For more information, please visit [milbankworks.com](http://milbankworks.com).

### METERING



As a market leader in electrical metering equipment, Milbank has set the standard for quality since 1927. Hundreds of configurations are available, including many sizes, knockout configurations, terminal configurations, bypass options, hubs, locks and connectors. Milbank has the socket you need with thousands of active products to meet your utility's requirements.

### ENCLOSURES



Milbank's line of enclosures include commercial junction boxes, panel mount enclosures, transformer cabinets, wireway, trough and industrial panel mount and push-button enclosures. Built with high-quality craftsmanship and materials which meet or exceed industry standards, Milbank enclosures are made to protect controls and equipment from dust, dirt and other harmful elements found in a wide variety of environments.

### ENCLOSED CONTROLS



Milbank doesn't just build empty enclosures. We can deliver the entire package, complete with custom control equipment built to your exact specifications by our engineers. Milbank commercial pedestals are an attractive, secure, easy to install and cost-effective solution when underground remote site power distribution and control equipment is required, replacing unsightly and inefficient strut and backboard structures.



Please consult serving utility for their requirements prior to ordering or installing, as specifications and approvals vary by utility, and may require local electrical inspector approval. All installations must be installed by a licensed electrician and must comply with all national and local codes, laws and regulations. Milbank reserves the right to make changes in specifications and features shown without notice or obligation.

# Table of Contents

## Air Conditioner Disconnects

---

30 & 60 amp AC disconnects .....	6
60 amp AC disconnect with 20 amp GFCI receptacle .....	7

## Single Position Sockets

---

100 amps, 4 terminals, solar, ringless .....	8
125 & 200 amps, 4 terminals, ringless .....	9
200 amps, 4 terminals, ringless.....	10
100-200 amps, 4 & 5 terminals, lever bypass, ringless .....	11
200 amps, 5 & 7 terminals, lever bypass, ringless .....	12
200 amps, 4 & 7 terminals, lever bypass, ringless .....	13

## Meter Main with Load Center

---

100-200 amps, 4 terminal, lever bypass, ringless .....	14
--	----

## Multi-Position

---

200 amps, 4 terminals, ringless.....	15
125 & 200 amp, 4 terminals, meter main, ringless.....	16
100-200 amp, 4 terminals, meter main, ringless.....	17-18
200 amp, 5 & 7 terminals, lever bypass, ringless.....	19-20

## Miscellaneous

---

Service Pedestals .....	21-23
CT Rated Sockets.....	24
Current transformer enclosures .....	25-27
Commercial Pedestals.....	28-37
Circuit Breakers .....	38
Accessories .....	39-41
Reference information .....	42-47
Approval Chart .....	48-49
Index.....	50

Please consult serving utility for their requirements prior to ordering or installing, as specifications and approvals vary by utility, and may require local electrical inspector approval. All installations must be installed by a licensed electrician and must comply with all national and local codes, laws and regulations. Milbank reserves the right to make changes in specifications and features shown without notice or obligation.





# Catalog Number Logic

How our product catalog numbers are derived

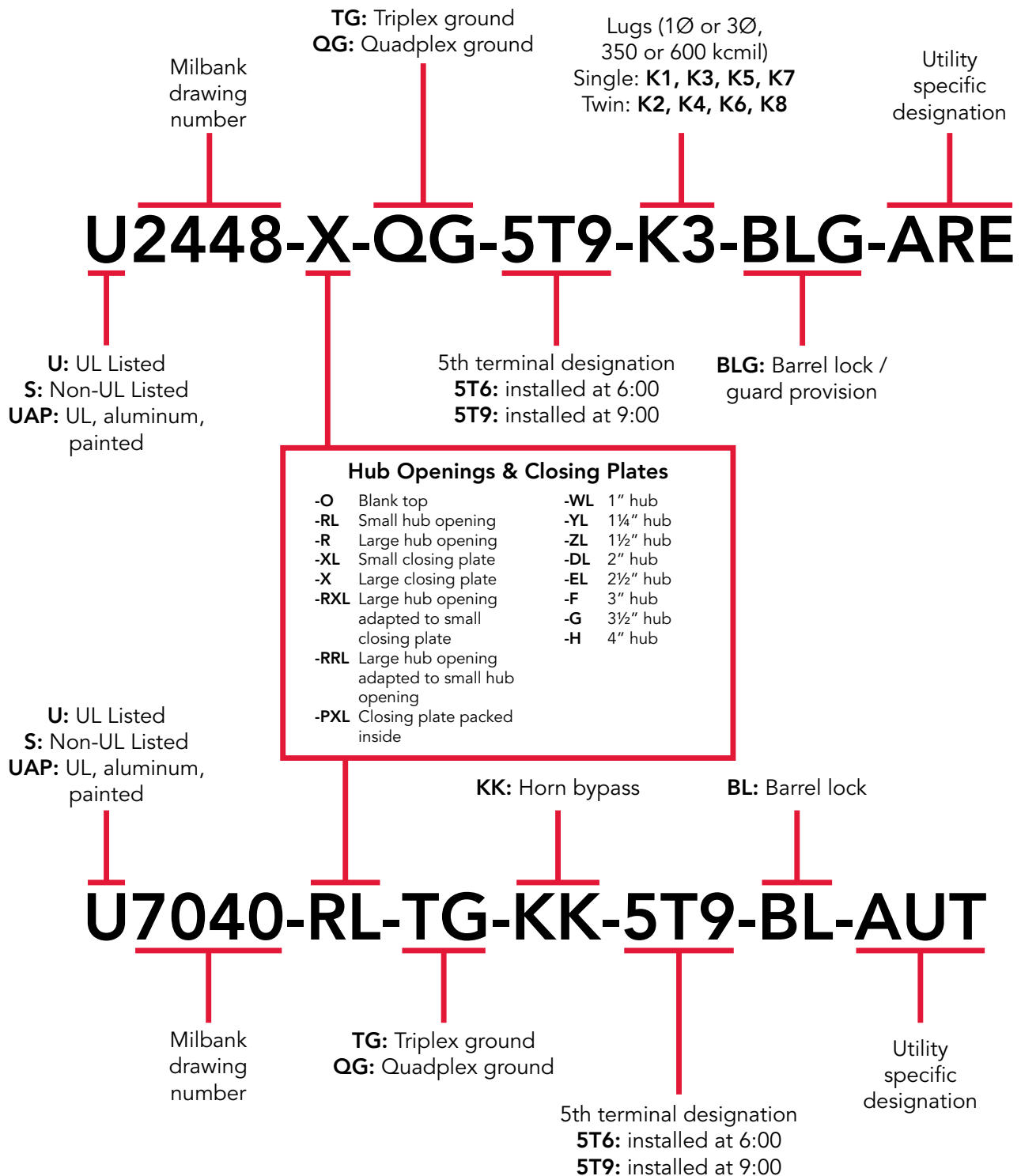

Please consult serving utility for their requirements prior to ordering or installing, as specifications and approvals vary by utility, and may require local electrical inspector approval. All installations must be installed by a licensed electrician and must comply with all national and local codes, laws and regulations. Milbank reserves the right to make changes in specifications and features shown without notice or obligation.



# Air Conditioner Disconnects

30 & 60 Amps | Fusible & Non-Fusible



**U3802**



**U3812**



**U3832**

Milbank’s air conditioner disconnect has a removable hinged cover for ease of installation. Our compact design meets NEC wiring space requirements and also complies with NEC article 440-14. For safe working conditions, our disconnect pullers may be removed and reinstalled in the OFF position. Additionally, padlock provisions are included on the front cover. As with other Milbank products, our enclosure is constructed of G90U galvanized steel and electrostatically finished with an attractive, light gray, baked powder coating. Our epoxy/polyester resin blend offers a finish that is both durable and fade-resistant.

## 30–60 Amps | 1Ø 240 VAC | Air Conditioner Disconnects

Catalog Number	Amps	Type	Max H.P.	Weight (lbs.)	Line/Load Wire Range		Ground Wire Range CU/AL	Dimensions			Wire Rating	
					CU	AL		D"	W"	H"	CU °C	AL °C
<b>U3802</b>	60	Non-Fusible	10	3.25	#14-#2	#12-#2	#14-4	2½	5	7½	60°/75°	60°/75°
<b>U3812</b>	60	Non-Auto	10	3.25	#14-#2	#12-#2	#14-4	2½	5	7½	60°/75°	60°/75°
<b>U3832</b>	30	Fusible	3	2.5	#14-#3	#14-#3	#14-3	2½	5	7	60°/75°	60°/75°
<b>U3862</b>	60	Fusible	10	3.3	#14-#3	#14-#3	#14-3	2½	5	9	60°/75°	60°/75°

### Notes

- UL listed as Enclosed Pullout Switch
- Type 3R rainproof
- One-inch concentric knockouts



Please consult serving utility for their requirements prior to ordering or installing, as specifications and approvals vary by utility, and may require local electrical inspector approval. All installations must be installed by a licensed electrician and must comply with all national and local codes, laws and regulations. Milbank reserves the right to make changes in specifications and features shown without notice or obligation.

# Air Conditioner Disconnects

## 20 Amp GFCI Receptacle



U3822-20GWR

### Specifications

- Meets NEC #210.63 requirements
- UL listed as Power Outlet
- Type 3R enclosure
- In-use cover\*
- Duplex ground connector
- 1" concentric knockouts
- 1Ø, 240 volt
- 60 amp, non-fused
- 20 amp GFCI receptacle
- Reset/test button
- Weather and tamper resistant
- Meets NEC #406.8 requirements

### 60 Amps | 1Ø, 240 VAC | Air Conditioner Disconnect with GFCI Receptacle

Catalog Number	Type	Max H.P.	Weight (lbs.)	Line/Load Wire Range		Ground Wire Range CU/AL	Dimensions			Wire Rating	
				CU	AL		D"	W"	H"	CU °C	AL °C
U3822-20GWR	Non-Fusible	10	6	#14-#2	#12-#2	#14-4	4½	5¼	7½	60°/75°	60°/75°

### Notes

- **Disconnect Pullers:** To ensure the safest conditions, Milbank disconnect pullers are reversible so they may be reinstalled in the OFF position.
- **Padlock Provision:** All units are designed with a padlock provision on the cover for security.
- **\*In-Use Cover:** Cover is rated as an in-use cover (cover may be closed with cords plugged into receptacle).

Please consult serving utility for their requirements prior to ordering or installing, as specifications and approvals vary by utility, and may require local electrical inspector approval. All installations must be installed by a licensed electrician and must comply with all national and local codes, laws and regulations. Milbank reserves the right to make changes in specifications and features shown without notice or obligation.



# Single Position Solar Sockets

100 amp | 4 Terminal | 600 VAC

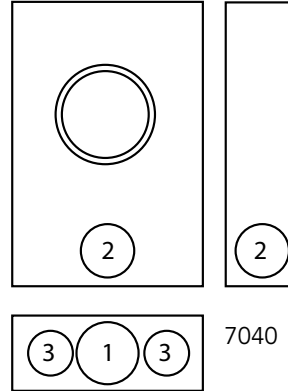

U4175-RL-BLG

100 Amp | 4 Terminal | Load Control Socket | Ringless\*

Catalog Number	Utility Number	Hub	Connectors CU/AL	Dimensions			Knockouts		
				D"	W"	H"	1	2	3
U4175-RL-BLG	M-361	H.O.	#12-#1 AWG	3 $\frac{5}{16}$	8	11 $\frac{1}{2}$	2	1 $\frac{1}{2}$	1 $\frac{1}{4}$

## Notes

- **HUB:** For proper hub selection, see the hub suffix chart on the accessory page.
- **Application:** For use on CATV Power Supply Service, Billboard Lighting Service, Traffic Signal Service



Please consult serving utility for their requirements prior to ordering or installing, as specifications and approvals vary by utility, and may require local electrical inspector approval. All installations must be installed by a licensed electrician and must comply with all national and local codes, laws and regulations. Milbank reserves the right to make changes in specifications and features shown without notice or obligation.



# Single Position Sockets

125 & 200 amps

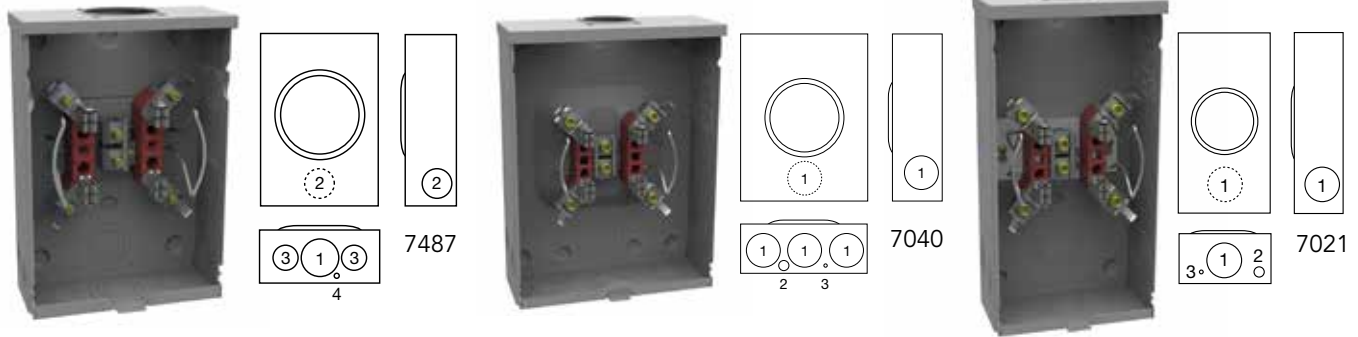

**U7487-RL-TG-KK**  
(APPROVED FOR NYSEG  
& CENTRAL HUDSON)

**U7040-RL-TG-KK-RGE**  
(APPROVED FOR NYSEG, RGE &  
CENTRAL HUDSON)

**U7021-RL-TG-KK-RGE**  
(APPROVED FOR NYSEG, RGE  
& NATIONAL GRID NY SERVICE  
AREAS)

## 125 Amps | 4 Terminal | Ringless | Horn Bypass

Catalog Number	Central Hudson Code#	Service	Hub	Connectors CU/AL		Dimensions			Knockouts			
				Line	Load	D"	W"	H"	1	2	3	4
U7487-RL-TG-KK	CH-063	OH/UG	H.O.	#6-2/0	#6-2/0	3 <sup>5</sup> / <sub>16</sub>	8	11 <sup>1</sup> / <sub>2</sub>	2	1 <sup>1</sup> / <sub>2</sub>	1 <sup>1</sup> / <sub>4</sub>	1 <sup>1</sup> / <sub>4</sub>

## 200 Amps | 4 Terminal | Ringless | Horn Bypass

Catalog Number	Central Hudson Code#	Service	Hub	Connectors CU/AL		Dimensions			Knockouts		
				Line	Load	D"	W"	H"	1	2	3
U7021-RL-TG-KK-RGE	-	OH	H.O.	#6-350 kcmil	#6-350 kcmil	4 <sup>1</sup> / <sub>8</sub>	8	15 <sup>1</sup> / <sub>2</sub>	2 <sup>1</sup> / <sub>2</sub>	1 <sup>1</sup> / <sub>2</sub>	1 <sup>1</sup> / <sub>4</sub>
U7040-RL-TG-KK-RGE *	CH-069	OH/UG	H.O.	#6-350 kcmil	#6-350 kcmil	4 <sup>1</sup> / <sub>8</sub>	11	15 <sup>1</sup> / <sub>2</sub>	2 <sup>1</sup> / <sub>2</sub>	1 <sup>1</sup> / <sub>2</sub>	1 <sup>1</sup> / <sub>4</sub>
	CH-081										

### Notes

- **Fifth Terminal:** For field mounted fifth terminal order catalog number **5T8K2** for 100 amp unit. For 200 amp units, order **K5T**.
- **Connectors:** Extruded aluminum connectors are tin plated. Units are supplied with duplex neutral.
- **Bypass:** Horn type bypass is provided.
- **Underground Service:** A closing plate must be used when the **U7040-RL-TG-KK-RGE** is designated for underground service. Order closing plate catalog number **A7551** as extra.

Please consult serving utility for their requirements prior to ordering or installing, as specifications and approvals vary by utility, and may require local electrical inspector approval. All installations must be installed by a licensed electrician and must comply with all national and local codes, laws and regulations. Milbank reserves the right to make changes in specifications and features shown without notice or obligation.



# Single Position Socket

200 amp | 4 Terminal | 600 VAC



U9090-O

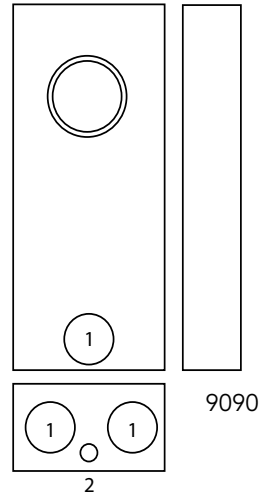

9090

## 200 Amp | 4 Terminal | Ringless

Catalog Number	Utility Number	Service	Hub	Connectors CU/AL		Dimensions			Knock-outs	
				Line	Load	D"	W"	H"	1	2
U9090-O	M-301	UG	Blank	3/8"-16 Stud	#6-350 kcmil	4½	9	20¾	2½	½

## Notes

- **Fifth Terminal:** For the field mounted fifth terminal, order as extra catalog number **K5T**.
- **Connectors:** Line and neutral service is supplied with 3/8"-16 studs with hex head nuts and captive Belleville washers. One hole compression lugs per National Grid NY standards are to be supplied by the contractor. Loadside is supplied with 350 kcmil, lay-in type connectors.

# Lever Bypass Single Position

200 amp | 4 & 5 Terminal

**1 1**  
SINGLE POSITION  
SOCKETS



U2048-RL

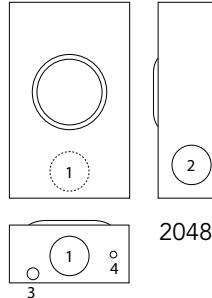

2048



U9551-RXL

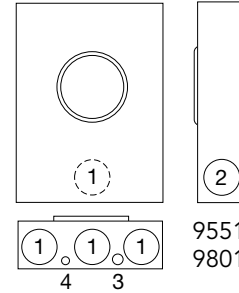

9551  
9801

## 200 Amp | 4 Terminal | Ringless | Lever Bypass | 1Ø3W

Catalog Number	Central Hudson Code#	Service	Hub	Connectors CU/AL		Dimensions			Knockouts			
				Line	Load	D"	W"	H"	1	2	3	4
U9801-R	CH-065	OH/UG	H.O.	#6-350 kcmil	#6-350 kcmil	4 $\frac{7}{8}$	13	19	3	2 $\frac{1}{2}$	$\frac{1}{2}$	$\frac{1}{2}$

### Notes

- **Fifth Terminal:** For field mounted fifth terminal, order as extra **K3866**.
- **Bypass:** Lever supplies clamping action on meter spades and also operates bypass device.
- **Connectors:** Units are supplied with extruded aluminum connectors, bonded neutral and a grounding stud.

## 200 Amp | 5 Terminal | Ringless | Lever Bypass | 1Ø3W or 3Ø3W

Catalog Number	Central Hudson Code#	Service	Hub	Connectors CU/AL		Dimensions			Knockouts			
				Line	Load	D"	W"	H"	1	2	3	4
U2048-RL	CH-116	OH	H.O.	#6-350 kcmil	#6-350 kcmil	4 $\frac{7}{8}$	10	18 $\frac{1}{2}$	3	2 $\frac{1}{2}$	3	$\frac{3}{4}$
U9551-RXL	CH-117	OH/UG	C.P.	#6-350 kcmil	#6-350 kcmil	4 $\frac{7}{8}$	13	19	3	2 $\frac{1}{2}$	$\frac{1}{2}$	$\frac{1}{4}$

## 200 Amp | 5 Terminal | Ringless | Lever Bypass | 1Ø3W or 3Ø3W

Catalog Number	RGE #	Service	Hub	Connectors CU/AL		Dimensions			Knockouts			
				Line	Load	D"	W"	H"	1	2	3	4
U9551-RL	R1121	OH/UG	H.O.	#6-350 kcmil	#6-350 kcmil	4 $\frac{7}{8}$	13	19	3	2 $\frac{1}{2}$	$\frac{1}{2}$	$\frac{1}{4}$

### Notes

- **Hub:** For proper hub selection see the hub suffix chart on the accessory page.
- **Bypass:** Lever supplies clamping action on meter spades and also operates bypass device.
- **Connectors:** Units are supplied with extruded aluminum connectors, bonded neutral and a grounding stud.
- **Fifth Terminal:** Fifth terminal is supplied in the 6 o'clock position. For factory installed fifth terminal in the 9 o'clock position add the suffix **-5T9** to the catalog number. Fifth terminal can be changed in the field from 6 o'clock to 9 o'clock position.

Please consult serving utility for their requirements prior to ordering or installing, as specifications and approvals vary by utility, and may require local electrical inspector approval. All installations must be installed by a licensed electrician and must comply with all national and local codes, laws and regulations. Milbank reserves the right to make changes in specifications and features shown without notice or obligation.



# Lever Bypass Single Position

200 amps | 5 & 7 Terminal | Lever Bypass | Ringless



U2046-O



U2047-O



U9701-R

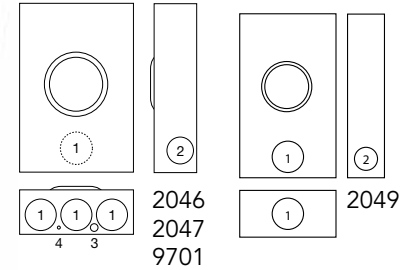

## 200 Amp | 5 Terminal | Ringless | 1Ø3W or 3Ø3W | Lever Bypass

Catalog Number	Service	Hub	Connectors CU/AL	Dimensions			Knockouts				
				D"	W"	H"	1	2	3	4	5
U2047-O	UG	Blank	#6-350 kcmil	4 <sup>7</sup> / <sub>8</sub>	13	19	3	2 <sup>1</sup> / <sub>2</sub>	3	1 <sup>1</sup> / <sub>4</sub>	1 <sup>1</sup> / <sub>4</sub> , 1 <sup>1</sup> / <sub>2</sub>

## 200 Amp | 7 Terminal | Ringless | 3Ø4W | Lever Bypass

Catalog Number	Service	Hub	Connectors CU/AL	Dimensions			Knockouts			
				D"	W"	H"	1	2	3	4
U2049-RL	OH	H.O.	#6-350 kcmil	4 <sup>7</sup> / <sub>8</sub>	10	18 <sup>1</sup> / <sub>2</sub>	3	2 <sup>1</sup> / <sub>2</sub>	—	—
U9701-R	OH/UG	H.O.	#6-350 kcmil	4 <sup>7</sup> / <sub>8</sub>	13	19	3	2 <sup>1</sup> / <sub>2</sub>	1 <sup>1</sup> / <sub>2</sub>	1 <sup>1</sup> / <sub>4</sub>
U2046-O	UG	Blank	#6-350 kcmil	4 <sup>7</sup> / <sub>8</sub>	13	19	3	2 <sup>1</sup> / <sub>2</sub>	3	1 <sup>1</sup> / <sub>4</sub>

### Notes

- **Hub:** For proper hub selection, see the hub suffix chart on the accessory page.
- **Lever Bypass:** Lever supplies clamping action on meter spades and also operates bypass device.
- **Connectors:** Units supplied with extruded aluminum connectors and bonded triplex ground.
- **Isolated Neutral:** For field installed isolated neutral, order kit number **K1047**.



Please consult serving utility for their requirements prior to ordering or installing, as specifications and approvals vary by utility, and may require local electrical inspector approval. All installations must be installed by a licensed electrician and must comply with all national and local codes, laws and regulations. Milbank reserves the right to make changes in specifications and features shown without notice or obligation.

# Lever Bypass Single Position

320 amp | 4 & 7 Terminal

**1 3**  
SINGLE POSITION  
WITH LEVER  
BYPASS



U2448-X-RGE

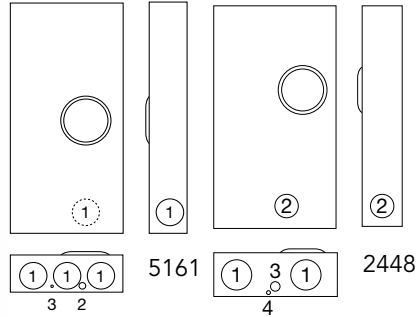

U4013-X

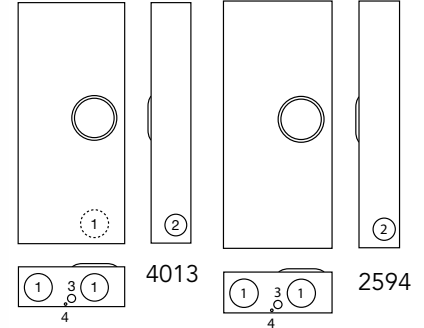

## 320 Amp | 4 Terminal | Side Wireway | Ringless | Lever Bypass | 1Ø3W

Catalog Number	Hub	Service	Connectors CU/AL	Dimensions			Knockouts			
			Line & Load	D"	W"	H"	1	2	3	4
U5161-X	C.P.	OH/UG	3/8"-16 Stud	4 <sup>7</sup> / <sub>8</sub>	15	31 <sup>1</sup> / <sub>2</sub>	3	1/2	1/4	-
U2448-X-RGE	C.P.	OH/UG	3/8"-16 Stud	6 <sup>1</sup> / <sub>2</sub>	17 <sup>3</sup> / <sub>4</sub>	34 <sup>1</sup> / <sub>8</sub>	4	3	1	1/4

## 320 Amp | 7 Terminal | Side Wireway | Ringless | Lever Bypass | 3Ø4W

Catalog Number	Hub	Service	Connectors CU/AL	Dimensions			Knockouts			
			Line & Load	D"	W"	H"	1	2	3	4
U4013-X	C.P.	OH/UG	3/8"-16 Stud	6 <sup>1</sup> / <sub>2</sub>	17 <sup>3</sup> / <sub>4</sub>	40 <sup>1</sup> / <sub>2</sub>	4	3	1	1/4
U2594-X	C.P.	OH/UG	3/8"-16 Stud	6 <sup>1</sup> / <sub>2</sub>	19	34 <sup>1</sup> / <sub>8</sub>	-	3	4	1

## Notes

- **Hubs:** For proper hub selection see the hub suffix chart on the accessory page.
- **Bypass:** Lever supplies clamping action on meter spades and also operates bypass device.
- **Connectors:** Stud type units supplied with 3/8"-16 hex head nuts with Belleville washers. For 1Ø connector kits, order as extra: **K1539** (350 kcmil) or **K1540** (600 kcmil). For twin lug connectors order as extra: **K1350** (350 kcmil). For 3Ø connector kits, order as extra: **K3082** (350 kcmil) or **K3441** (600 kcmil). For twin lug connectors, order as extra: **K3441** (#4-600 kcmil or (2) 1/0-250 kcmil). Separate kits are required for both line and load.
- **Fifth Terminal:** **U2448-X-RGE**—for factory installed fifth terminal in the 6 o'clock position add the suffix **-5T6** to the catalog number. For factory installed fifth terminal in the 9 o'clock position at the suffix **-5T9** to the catalog number. Catalog number **K3865** is available for field install.
- **National Grid NY Part Nos.:** **U5161-X**, **U2448-X-RGE** (M-116), **U4013-X**, **U2594-X** (M-117). One hole compression lugs per National Grid NY standards to be supplied by contractor.

Please consult serving utility for their requirements prior to ordering or installing, as specifications and approvals vary by utility, and may require local electrical inspector approval. All installations must be installed by a licensed electrician and must comply with all national and local codes, laws and regulations. Milbank reserves the right to make changes in specifications and features shown without notice or obligation.



# Meter Main with Load Center

100-200 amps | 4 Terminal | Ringless

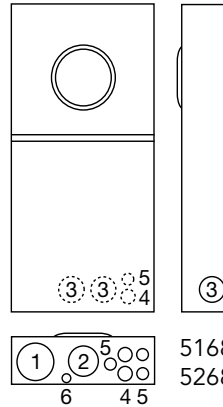

U5168-XTL-200-KK-PL

100 - 200 Amps | 4 Terminal | Meter Main | Overhead/Underground | Horn Bypass | 22K AIC | 1Ø3W

Catalog Number	Amp	No. of Circuits	Hub	Connectors	Dimensions			Knockouts					
				Line	D"	W"	H"	1	2	3	4	5	6
U5168-XTL-100-KK	100	8	C.P.	#6-350 kcmil	4½	14⅞	32	3	2½	2	1	¾	½
U5168-XTL-150-KK	150	8	C.P.	#6-350 kcmil	4½	14⅞	32	3	2½	2	1	¾	½
U5168-XTL-200-KK	200	8	C.P.	#6-350 kcmil	4½	14⅞	32	3	2½	2	1	¾	½
U5168-XTL-100-KK-PL**	100	8	C.P.	#6-350 kcmil	4½	14⅞	32	3	2½	2	1	¾	½
U5168-XTL-200-KK-PL**	200	8	C.P.	#6-350 kcmil	4½	14⅞	32	3	2½	2	1	¾	½
U5268-XTL-150-KK	150	20	C.P.	#6-350 kcmil	4½	14⅞	32	3	2½	2	1	¾	½
U5268-XTL-200-KK	200	20	C.P.	#6-350 kcmil	4½	14⅞	32	3	2½	2	1	¾	½

## Notes

- **Hub:** Supplied with (2) closing plates packed inside. Order hubs as a separate item. See accessory page for hub options.
- **Interior:** U5168 units have 8 circuit interior; U5268 units have 20 circuit interior.
- **Fifth Terminal:** Order K5T and field install in the 9 o'clock position only.
- **Breakers:** Rated 22K AIC with QNR2200H main installed.
- **Interlock Kit:** For generator auxiliary circuit breaker interlock, order K5815 for large QN with small frame Q; order K5820 for large frame QN with large frame QN.
- **\*Sub-feed Lugs:** #6-350 kcmil sub-feed lugs provided on 8 circuit interior. Not available on 20 circuit interior.

\*\*National Grid NY Service Area – for overhead and underground when underground service is a complete cable-in-conduit system.

### Plug-in Breaker Compatibility Chart

Amps	Cutler-Hammer (Westinghouse)	Siemens (ITE)	Siemens Murray Crouse-hinds	G.E.	SQ-D
125-200	HQP / BR / WBJ	QN	MD	THQ	–
≤ 100	QP / BR / HQP	QP	MP	THQ	Homeline

### Main Circuit Breaker Chart

Amperage	100	150	200
Catalog No.	Q2100H	QN2150RH	QN2200RH



Please consult serving utility for their requirements prior to ordering or installing, as specifications and approvals vary by utility, and may require local electrical inspector approval. All installations must be installed by a licensed electrician and must comply with all national and local codes, laws and regulations. Milbank reserves the right to make changes in specifications and features shown without notice or obligation.

# Multi-Position Sockets

200 Amp | 4 Terminal | Ringless | 300 VAC

**15**  
METER MAIN W/  
LOAD CENTER



U1252-R-KK-RGE

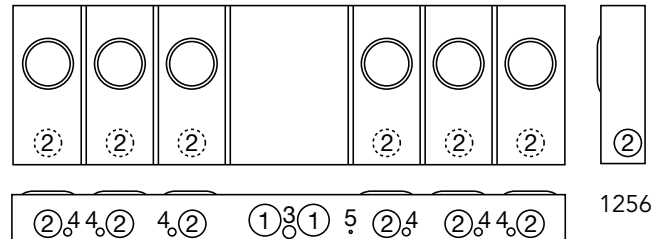
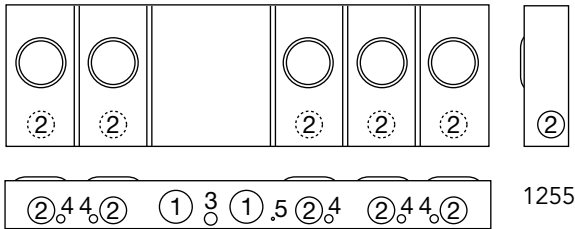
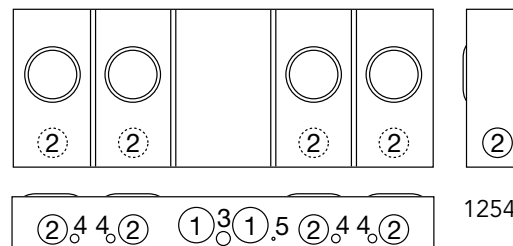
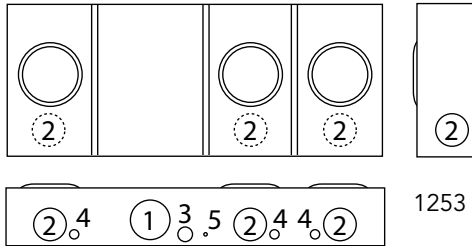
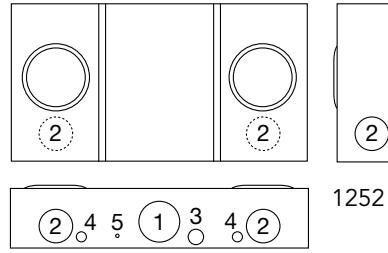

200 Amp / Position | 4 Terminal | Ringless | Horn Bypass | 1Ø3W | OH/UG\*

Catalog Number	Hub	Connectors		Dimensions			Knockouts				
		Line	Load	D"	W"	H"	1	2	3	4	5
U1252-R-KK-RGE	H.O.	3/8"-16 Stud	#6-350 kcmil	5 1/8	26 1/2	14	3	2 1/2	1	1/2	1/4
U1253-R-KK-RGE	H.O.	3/8"-16 Stud	#6-350 kcmil	5 1/8	34 3/4	14	3	2 1/2	1	1/2	1/4
U1254-R-KK-EX-RGE	H.O.	3/8"-16 Stud	#6-350 kcmil	5 1/8	42 7/8	16	3	2 1/2	1	1/2	1/4
U1255-R-KK-EX-RGE	H.O.	3/8"-16 Stud	#6-350 kcmil	5 1/8	54 7/8	16	3	2 1/2	1	1/2	1/4
U1256-R-KK-EX-RGE	H.O.	3/8"-16 Stud	#6-350 kcmil	5 1/8	63 1/16	18	3	2 1/2	1	1/2	1/4

## Notes

- **Hub:** For proper hub selection refer to the hub suffix chart on the accessory page. Two hub openings are supplied and the extra opening is closed with a closing plate as standard on the 5 and 6 position units.
- **Fifth Terminal:** For factory installed fifth terminal in the 9 o'clock position, add the suffix **-5T**. For field mounted fifth terminal, order catalog number **K5T** (1 kit per meter position).
- **Connectors:** Extruded aluminum connectors are tin plated. See page 26 for connectors.
- **Bussing:** Bussing is 5/16" x 1" aluminum on the **U1252-1253**. On the **U1254-6** gangs the bussing is 3/8" x 1" aluminum. Refer to general engineering section of the Standard Catalog for information on ampacity of bussing.

Please consult serving utility for their requirements prior to ordering or installing, as specifications and approvals vary by utility, and may require local electrical inspector approval. All installations must be installed by a licensed electrician and must comply with all national and local codes, laws and regulations. Milbank reserves the right to make changes in specifications and features shown without notice or obligation.



# Multi-Position Meter Mains

125/200 amp | 4 Terminal | Ringless | 120/240 VAC



**U2854-X**

125 amp | Position

Catalog Number	Positions	Main Bus Rating	Connectors CU/AL
			Line
U2852-X	2	200 amp	*3/8"-16 STUD
U2853-X	3	200 amp	*3/8"-16 STUD



**U2866-X**

200 amp | Position

Catalog Number	Positions	Main Bus Rating	Connectors CU/AL
			Line
U2862-X	2	250 amp	*3/8"-16 STUD
U2863-X	3	300 amp	*3/8"-16 STUD

## VERTICAL

## RECTANGULAR

125 amp | Position

Catalog Number	Positions	Main Bus Rating	Connectors CU/AL
			Line
U2854-X	4	400 amp	*3/8"-16 STUD
U2855-X	5	400 amp	*3/8"-16 STUD
U2856-X	6	400 amp	*3/8"-16 STUD

200 amp | Position

Catalog Number	Positions	Main Bus Rating	Connectors CU/AL
			Line
U2864-X	4	400 amp	*3/8"-16 STUD
U2865-X	5	400 amp	*3/8"-16 STUD
U2866-X	6	400 amp	*3/8"-16 STUD

### Connector Kits\*

Size	Suffix	Kit Number	Compatible With	Wire Range
SINGLE	-K1	K1539	U2852-56 U2862-66	#6-350
	-K3	K1540	U2854-56 U2864-66	#4-600
TWIN	-K2	K1350	U2854-56 U2863-66	#6-350
	-K4	K1541	U2864-66	#2-600

**Connectors:** For line wire connector kits, order separately.

**Fifth Terminal:** For field mounted fifth terminal order catalog number **K2381**. Order one per meter position (9 o'clock position only).

**Breakers:** Units have provision for one double pole main per meter position. Breakers not included. Order as extra Milbank.

amp	Cutler-Hammer (Westinghouse)	Simens (ITE)	Siemens Murray/ Crouse-Hinds	G.E.	SQ-D
150-200	HQP/BR/WBJ	QNR	MD	THQ	
≤125	QP/BR/HQP	QP	MP	THQ	Homeline



Please consult serving utility for their requirements prior to ordering or installing, as specifications and approvals vary by utility, and may require local electrical inspector approval. All installations must be installed by a licensed electrician and must comply with all national and local codes, laws and regulations. Milbank reserves the right to make changes in specifications and features shown without notice or obligation.



# Multi-Position Meter Mains

100-200 amp | 4 Terminal | Ringless | 120/240 VAC | 22K AIC

**17**  
MULTI-POSITION  
METER MAIN



U5902-X-KK-BL

100-200 amp | 4 Terminal | Ringless

Catalog Number	Amp	No. of Pos.	Hub	Connectors	Dimensions			Knockouts				
				Line	D"	W'	H"	1	2	3	4	5
U5902-X-KK-BL**	125	2	C.P.	3/8" x 16 Stud	5 1/8	26 1/2	30	3	2 1/2	1	7/8	1/4
U5902-X-KK-BLG*	125	2	C.P.	3/8" x 16 Stud	5 1/8	26 1/2	30	3	2 1/2	1	7/8	1/4
U5903-X-KK-BL**	125	3	C.P.	3/8" x 16 Stud	5 1/8	34 1/16	30	3	3	2 1/2	1	—
U5903-X-KK-BLG*	125	3	C.P.	3/8" x 16 Stud	5 1/8	34 1/16	30	3	3	2 1/2	1	—
U5904-X-KK-BL**	125	4	C.P.	3/8" x 16 Stud	5 1/8	42 13/16	30	3	3	2 1/2	1	—
U5904-X-KK-BLG*	125	4	C.P.	3/8" x 16 Stud	5 1/8	42 13/16	30	3	3	2 1/2	1	—
U5905-X-KK-BL**	125	5	C.P.	3/8" x 16 Stud	5 1/8	51 1/16	30	3	3	2 1/2	1	—
U5905-X-KK-BLG*	125	5	C.P.	3/8" x 16 Stud	5 1/8	51 1/16	30	3	3	2 1/2	1	—
U5906-X-KK-BL**	125	6	C.P.	3/8" x 16 Stud	5 1/8	59 5/16	30	3	3	2 1/2	1	—
U5906-X-KK-BLG*	125	6	C.P.	3/8" x 16 Stud	5 1/8	59 5/16	30	3	3	2 1/2	1	—
U5882-X-KK-BL**	200	2	C.P.	3/8" x 16 Stud	5 1/8	59 5/16	30	3	2 1/2	1	7/8	1/4
U5882-X-KK-BLG*	200	2	C.P.	3/8" x 16 Stud	5 1/8	59 5/16	30	3	2 1/2	1	7/8	1/4
U5883-X-KK-BL**	200	3	C.P.	3/8" x 16 Stud	5 1/8	34 1/16	30	3	2 1/2	2 1/2	1	—
U5883-X-KK-BLG*	200	3	C.P.	3/8" x 16 Stud	5 1/8	34 1/16	30	3	2 1/2	2 1/2	1	—
U5884-X-KK-BL**	200	4	C.P.	3/8" x 16 Stud	5 1/8	42 13/16	30	3	2 1/2	2 1/2	1	—
U5884-X-KK-BLG*	200	4	C.P.	3/8" x 16 Stud	5 1/8	42 13/16	30	3	2 1/2	2 1/2	1	—
U5885-X-KK-BL**	200	5	C.P.	3/8" x 16 Stud	5 1/8	51 1/16	30	3	2 1/2	2 1/2	1	—
U5885-X-KK-BLG*	200	5	C.P.	3/8" x 16 Stud	5 1/8	51 1/16	30	3	2 1/2	2 1/2	1	—
U5886-X-KK-BL**	200	6	C.P.	3/8" x 16 Stud	5 1/8	59 5/16	30	3	2 1/2	2 1/2	1	—
U5886-X-KK-BLG*	200	6	C.P.	3/8" x 16 Stud	5 1/8	59 5/16	30	3	2 1/2	2 1/2	1	—

## Notes

- **Hub:** For proper hub selection refer to the hub suffix chart on the accessory page.
  - **Fifth Terminal:** For field mounted fifth terminal, order catalog number K5T for each meter position, 9 o'clock position.
  - **Connectors:** Extruded aluminum connectors are tin plated.
  - **Bypass:** Units provided with horn type bypass (suffix -KK).
- \*Barrel lock with guard provision (suffix -BLG).  
 \*\*Barrel lock (suffix -BL).

Please consult serving utility for their requirements prior to ordering or installing, as specifications and approvals vary by utility, and may require local electrical inspector approval. All installations must be installed by a licensed electrician and must comply with all national and local codes, laws and regulations. Milbank reserves the right to make changes in specifications and features shown without notice or obligation.



# U5902-06 & U5882-86 Series

*Knockout Information*

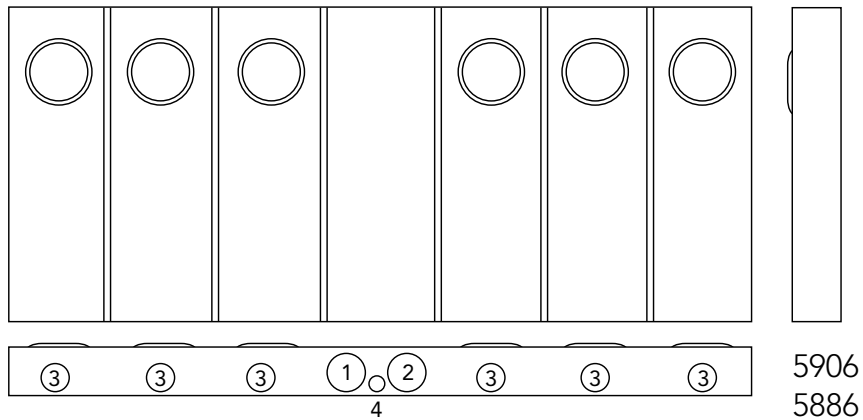
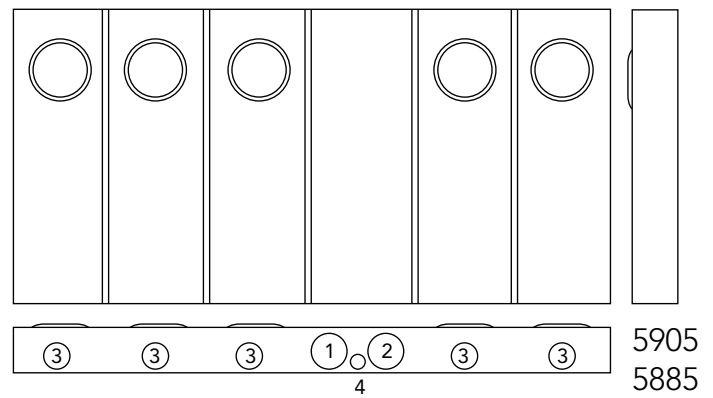
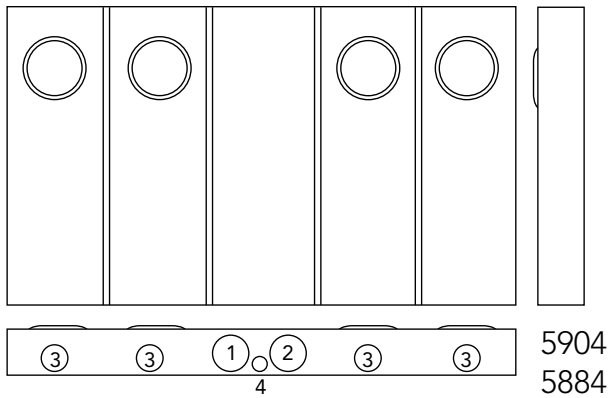
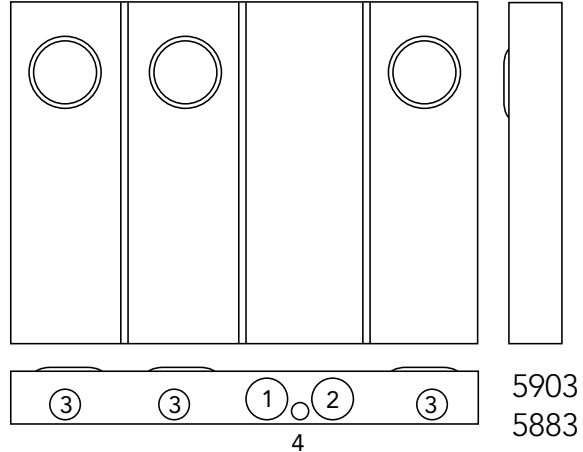
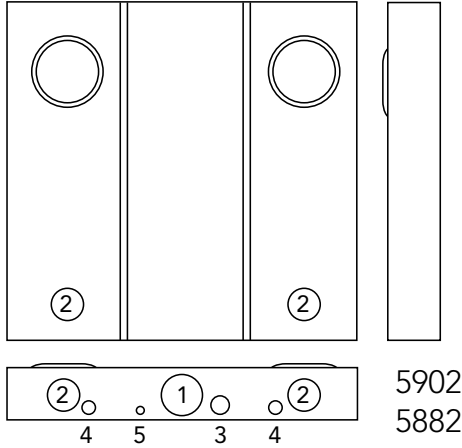

Please consult serving utility for their requirements prior to ordering or installing, as specifications and approvals vary by utility, and may require local electrical inspector approval. All installations must be installed by a licensed electrician and must comply with all national and local codes, laws and regulations. Milbank reserves the right to make changes in specifications and features shown without notice or obligation.

# Lever Bypass Multi-Position Sockets

200 Amp | 5 Terminal | Ringless | 600 VAC

**19**  
LEVER BYPASS  
MULTI-POSITION  
SOCKETS



U2872-XT

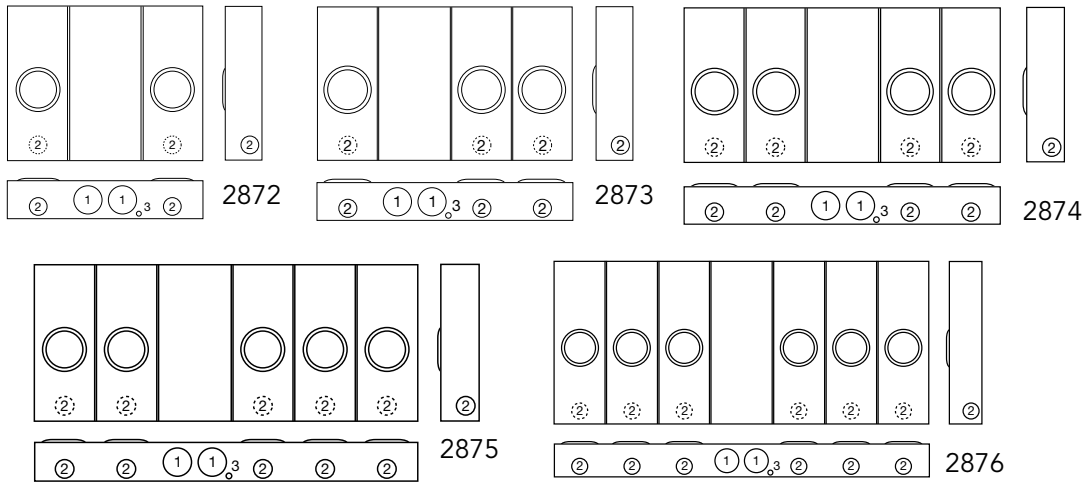

200 Amp | 5 Terminal | Ringless | Lever Bypass | 1Ø3W | OH/UG

Catalog Number	Positions	Hub	Connectors CU/AL		Dimensions			Knockouts		
			Line	Load	D"	W"	H"	1	2	3
U2872-XT	2	(2)C.P.	3/8"-16 Stud	#6-350 kcmil	6	32 <sup>1</sup> / <sub>8</sub>	25 <sup>1</sup> / <sub>4</sub>	4	2 <sup>1</sup> / <sub>2</sub>	1 <sup>1</sup> / <sub>4</sub> , 1 <sup>1</sup> / <sub>2</sub>
U2873-XT	3	(2)C.P.	3/8"-16 Stud	#6-350 kcmil	6	42 <sup>3</sup> / <sub>16</sub>	25 <sup>1</sup> / <sub>4</sub>	4	2 <sup>1</sup> / <sub>2</sub>	1 <sup>1</sup> / <sub>4</sub> , 1 <sup>1</sup> / <sub>2</sub>
U2874-XT	4	(2)C.P.	3/8"-16 Stud	#6-350 kcmil	6	52 <sup>1</sup> / <sub>4</sub>	25 <sup>1</sup> / <sub>4</sub>	4	2 <sup>1</sup> / <sub>2</sub>	1 <sup>1</sup> / <sub>4</sub> , 1 <sup>1</sup> / <sub>2</sub>
U2875-XT	5	(2)C.P.	3/8"-16 Stud	#6-350 kcmil	6	62 <sup>5</sup> / <sub>16</sub>	25 <sup>1</sup> / <sub>4</sub>	4	2 <sup>1</sup> / <sub>2</sub>	1 <sup>1</sup> / <sub>4</sub> , 1 <sup>1</sup> / <sub>2</sub>
U2876-XT	6	(2)C.P.	3/8"-16 Stud	#6-350 kcmil	6	72 <sup>3</sup> / <sub>8</sub>	31 <sup>1</sup> / <sub>4</sub>	4	2 <sup>1</sup> / <sub>2</sub>	1 <sup>1</sup> / <sub>4</sub> , 1 <sup>1</sup> / <sub>2</sub>

## Notes

- **Hubs:** Units supplied with two closing plates. To order hubs as extra refer to the hub suffix chart on the accessory page.
- **Bypass:** Lever supplies clamping action on meter spades and also operates bypass device.
- **\*Connector Kits:** Line wire sections supplied with studs. For connector kits for the U2872-6 units, order as extra: **K1539** (350 kcmil), **K1350** (twin 350 kcmil), **K1540** (600 kcmil) or **K1541** (twin 600 kcmil). For U2732-6 units, order **K3082** (350 kcmil), **K3442** (twin 350 kcmil), **K3441** (600 kcmil) or **K3083** (twin 600 kcmil). Line connectors can be reversed to change from "OH" to "UG" service.
- **Bussing:** Bussing is 3/8" x 1" aluminum. Refer to the conduit & ampacity information page for information on ampacity of bussing.

Please consult serving utility for their requirements prior to ordering or installing, as specifications and approvals vary by utility, and may require local electrical inspector approval. All installations must be installed by a licensed electrician and must comply with all national and local codes, laws and regulations. Milbank reserves the right to make changes in specifications and features shown without notice or obligation.



# Lever Bypass Multi-Position Sockets

200 Amp | 7 Terminal | Ringless | 600 VAC



U2732-XT

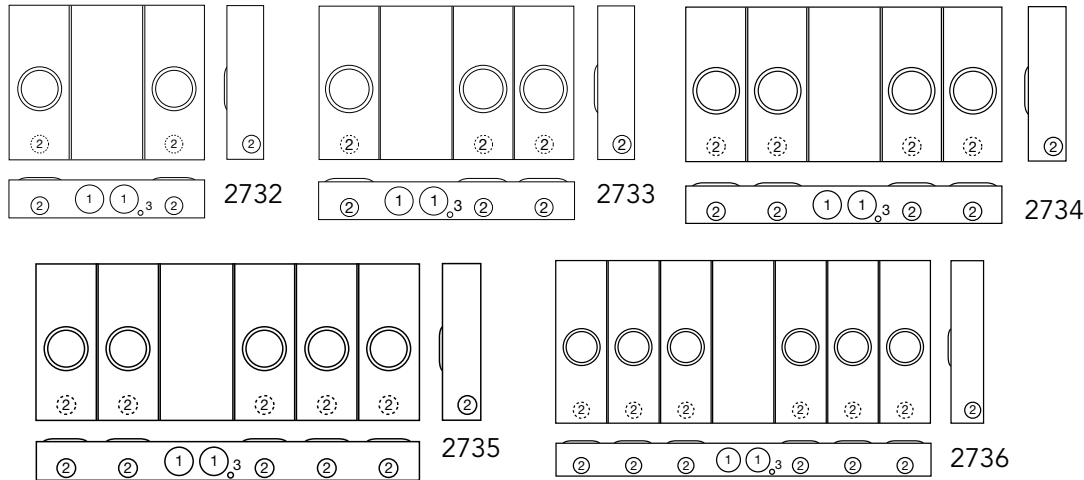

200 Amp | 7 Terminal | Ringless | Lever Bypass | 3Ø4W | OH/UG

Catalog Number	No. of Pos.	Hub	Connectors CU/AL		Dimensions			Knockouts				
			Line	Load	D"	W"	H"	1	2	3	4	5
U2732-XT	2	(2)C.P.	3/8"-16 Stud	#6-350 kcmil	6	32 <sup>1</sup> / <sub>8</sub>	25 <sup>1</sup> / <sub>4</sub>	2 <sup>1</sup> / <sub>2</sub>	2 <sup>1</sup> / <sub>2</sub>	4	2 <sup>1</sup> / <sub>2</sub>	1/4, 1/2
U2733-XT	3	(2)C.P.	3/8"-16 Stud	#6-350 kcmil	6	42 <sup>3</sup> / <sub>16</sub>	25 <sup>1</sup> / <sub>4</sub>	2 <sup>1</sup> / <sub>2</sub>	2 <sup>1</sup> / <sub>2</sub>	4	2 <sup>1</sup> / <sub>2</sub>	1/4, 1/2
U2734-XT	4	(2)C.P.	3/8"-16 Stud	#6-350 kcmil	6	52 <sup>1</sup> / <sub>4</sub>	25 <sup>1</sup> / <sub>4</sub>	2 <sup>1</sup> / <sub>2</sub>	2 <sup>1</sup> / <sub>2</sub>	4	2 <sup>1</sup> / <sub>2</sub>	1/4, 1/2
U2735-XT	5	(2)C.P.	3/8"-16 Stud	#6-350 kcmil	6	62 <sup>5</sup> / <sub>16</sub>	25 <sup>1</sup> / <sub>4</sub>	2 <sup>1</sup> / <sub>2</sub>	2 <sup>1</sup> / <sub>2</sub>	4	2 <sup>1</sup> / <sub>2</sub>	1/4, 1/2
U2736-XT	6	(2)C.P.	3/8"-16 Stud	#6-350 kcmil	6	72 <sup>3</sup> / <sub>8</sub>	31 <sup>1</sup> / <sub>4</sub>	2 <sup>1</sup> / <sub>2</sub>	2 <sup>1</sup> / <sub>2</sub>	4	2 <sup>1</sup> / <sub>2</sub>	1/4, 1/2

## Notes

- **Hubs:** Units supplied with two closing plates. To order hubs as extra refer to the hub suffix chart on the accessory page.
- **Bypass:** Lever supplies clamping action on meter spades and also operates bypass device.
- **\*Connector Kits:** Line wire sections supplied with studs. For connector kits for the **U2872-6** units, order as extra: **K1539** (350 kcmil), **K1350** (twin 350 kcmil), **K1540** (600 kcmil) or **K1541** (twin 600 kcmil). For **U2732-6** units, order **K3082** (350 kcmil), **K3442** (twin 350 kcmil), **K3441** (600 kcmil) or **K3083** (twin 600 kcmil). Line connectors can be reversed to change from "OH" to "UG" service.
- **Bussing:** Bussing is 3/8" x 1" aluminum. Refer to the conduit & ampacity information page for information on ampacity of bussing.



Please consult serving utility for their requirements prior to ordering or installing, as specifications and approvals vary by utility, and may require local electrical inspector approval. All installations must be installed by a licensed electrician and must comply with all national and local codes, laws and regulations. Milbank reserves the right to make changes in specifications and features shown without notice or obligation.

# Service Pedestals

200 Amp | 4 Terminal | 120/240 VAC



U4093N-O

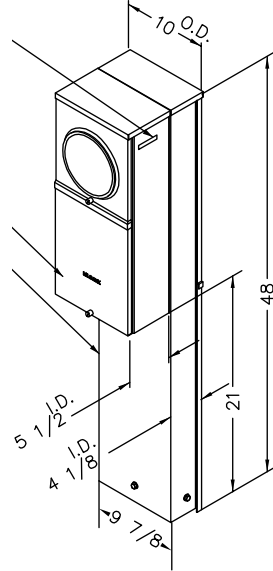

## Main Breakers (Series Wired)

Catalog Number	Amps
UQFP-M-100	100
UQFP-M-125	125
UQFP-M-150	150
UQFP-M-200	200

## Branch Breaker

Amps	Milbank	Cutler-Hammer/ Westinghouse	Siemens/ ITE	Murray / Crouse-Hinds	G.E.	SQ-D
125 or Less	Q	Quicklag P BR / HQP	QP	MP-T	THQ	Home Line

## 200 Amp | 4 Terminal | Ringless

Catalog Number	Meter Positions	Mounting Type	Line Connectors CU/AL	Circuit Prov.	LBS.	Description
U4093N-O	Single	Post	3/8" - 16 Stud	6	100#	Provisions for Main with Branch or Parallel Breakers

## Notes

- **Application:** Pedestals are suitable for use as mobile home service equipment. These units are in stock, wired as parallel, without breaker. They have provisions for one double, and two single circuit branch breakers in addition to the main. Order breakers separately (see chart above.) Quadplex style breakers may be used in accordance to the NEC. For main style breakers (series wired), order **UQFP-M**, plus kit **K4714** (includes wire assemblies, hardware, instructions and label).
- **Required Accessories:** Pedestal must be used with Direct Burial Kit **K3236 / K3188** (22 lbs.) which is furnished as part of unit and is included in price. Pad Mount Sleeve **K3237** (6 lbs.) can be ordered as an extra option, and is required if unit is to be pad-mounted.
- **22K AIC—Consult Factory**
- **Fifth Terminal:** For field installed fifth terminal, use **K5T** in the 9 o'clock position.

Please consult serving utility for their requirements prior to ordering or installing, as specifications and approvals vary by utility, and may require local electrical inspector approval. All installations must be installed by a licensed electrician and must comply with all national and local codes, laws and regulations. Milbank reserves the right to make changes in specifications and features shown without notice or obligation.





U5136-O-200S

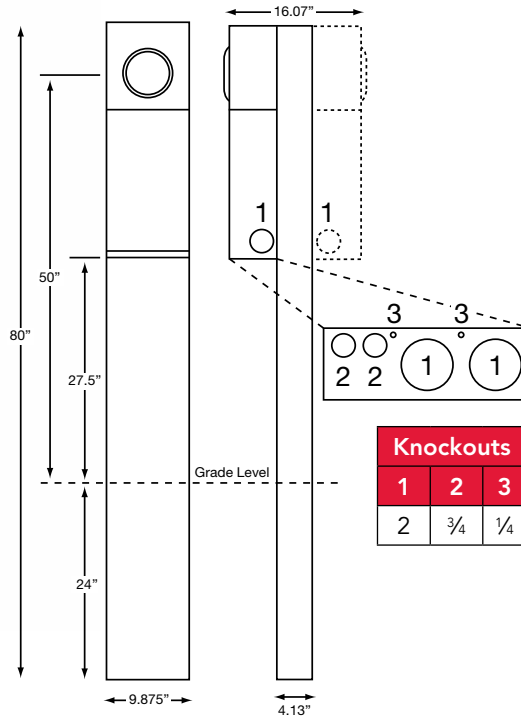

## Specifications

- UL Listed
- 200 amp maximum, 120/240 V, 1Ø3W
- Ringless type meter socket with stainless steel latch
- Short circuit withstand rating 10 KAIC, 22 KAIC available consult factory
- Type 3R construction for durable outdoor use
- ASA 61 grey polyester powder coat finish
- Wire terminations accept copper or aluminum conductors
- Line & Neutral: (2) #6-350 kcmil per phase, Line Ground: (4) #14-1/0
- Load (CB): 2/0 to 300 kcmil per pole
- Load neutral: (1) #6-350 kcmil
- Load ground: (2) #14-1/0, (4) #14/6
- Commercial grade, plug-in main circuit breaker. Available in 100, 125, 150 & 200 AMP. Type UQFP-H-M.
- 4 circuit plated copper interior accepts (2) 2-pole or (4) 1-pole standard plug-in type circuit breakers. Branch circuit rated to 125 amp max. Acceptable manufacturers: Milbank, Cutler-Hammer, GE or Siemens
- Twin line termination lugs #6-350 CU/AL per phase for looping.



Please consult serving utility for their requirements prior to ordering or installing, as specifications and approvals vary by utility, and may require local electrical inspector approval. All installations must be installed by a licensed electrician and must comply with all national and local codes, laws and regulations. Milbank reserves the right to make changes in specifications and features shown without notice or obligation.

# Service Pedestals

## U5136 & U5137 Series | Ringless

### 100 - 200 Amp | Meter Main w/ Load Center Pedestals | Ringless

Catalog Number	Powerheads	Mounting	Amp	Main Breaker	Interior	Dimensions			Knockouts		
						D"	W"	H"	1	2	3
U5136-O-100S	Single	Direct Burial	100	UQFPH-M-100	4 circuit	10 $\frac{1}{4}$	10	80	2	1 $\frac{1}{2}$ , 3 $\frac{3}{4}$	1 $\frac{1}{4}$
U5136-O-200S	Single	Direct Burial	200	UQFPH-M-200	4 circuit	10 $\frac{1}{4}$	10	80	2	1 $\frac{1}{2}$ , 3 $\frac{3}{4}$	1 $\frac{1}{4}$
U5136-O	Single	Direct Burial	—	Provision for UQFPH-M series	4 circuit	10 $\frac{1}{4}$	10	80	2	1 $\frac{1}{2}$ , 3 $\frac{3}{4}$	1 $\frac{1}{4}$
U5137-O-100S	Double	Direct Burial	100	(2) UQFPH-M-100	4 circuit	16 $\frac{1}{16}$	10	80	2	1 $\frac{1}{2}$ , 3 $\frac{3}{4}$	1 $\frac{1}{4}$
U5137-O-200S	Double	Direct Burial	200	(2) UQFPH-M-200	4 circuit	16 $\frac{1}{16}$	10	80	2	1 $\frac{1}{2}$ , 3 $\frac{3}{4}$	1 $\frac{1}{4}$
U5137-O	Double	Direct Burial	—	Provision for (2) UQFPH-M series	4 circuit	16 $\frac{1}{16}$	10	80	2	1 $\frac{1}{2}$ , 3 $\frac{3}{4}$	1 $\frac{1}{4}$
U5138-O-200S	Single	Pad Mount	200	UQFPH-M-200	4 circuit	10 $\frac{1}{4}$	10	56	2	1 $\frac{1}{2}$ , 3 $\frac{3}{4}$	1 $\frac{1}{4}$
U5138-O	Single	Pad Mount	—	Provision for UQFPH-M series	4 circuit	10 $\frac{1}{4}$	10	56	2	1 $\frac{1}{2}$ , 3 $\frac{3}{4}$	1 $\frac{1}{4}$
U5139-O	Double	Pad Mount	—	Provision for UQFPH-M series	4 circuit	16 $\frac{1}{16}$	10	56	2	1 $\frac{1}{2}$ , 3 $\frac{3}{4}$	1 $\frac{1}{4}$

### Accessories

Catalog Number	Description
K5415	Stabilizer foot with hardware
K5035	Pad mount kit with hardware for <b>U5138</b>
K5T	5th terminal for 208y/120V 3-wire service
K5193	Bus kit to convert series-wired main breaker to parallel
K5194	4 Wire kit to convert parallel-wired main breaker to series
K3450	Telephone/CATV mounting bracket (mounts left or right)
K5039	Penta bolt utility cover

### Notes

- Parallel to Series Conversion: For field converting from parallel wired to series wired order K5194.
- Fifth Terminal: For field installed fifth terminal, order K5T.
- Stabilizer Foot: For field installed stabilizer foot, order K5415.
- Penta Bolt Locking: For field installed pedestal fronts penta bolt locking, order K5039.
- Pad Mount Units: Pad mount pedestals require K5035 pad mount kit. Order separately.
- Receptacles and circuit breakers can be found in the accessories section.

Please consult serving utility for their requirements prior to ordering or installing, as specifications and approvals vary by utility, and may require local electrical inspector approval. All installations must be installed by a licensed electrician and must comply with all national and local codes, laws and regulations. Milbank reserves the right to make changes in specifications and features shown without notice or obligation.



# Lever Bypass CT Rated Sockets

80 Amps | Ringless | 600 VAC



U4493-XL

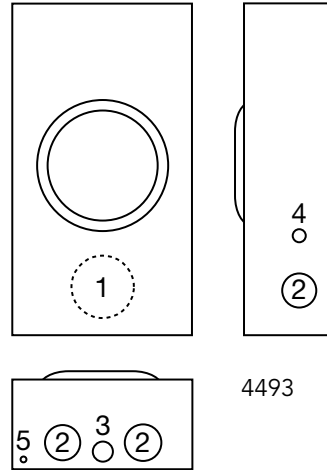

**80 Amp Transformer Rated | 13 Terminal | Lever Bypass | Ringless**  
Central Hudson Approved

Catalog Number	Service	Hub	Connectors CU	Dimensions			Knockouts				
				D"	W"	H"	1	2	3	4	5
U4493-XL	OH/UG	C.P.	#14 - #4 MAX	4 $\frac{5}{8}$	10	18 $\frac{1}{2}$	3	1 $\frac{1}{2}$	$\frac{3}{4}$	$\frac{3}{4}$	$\frac{1}{4}$

## Notes

- **Hubs:** For proper hub selection see the hub suffix chart.
- **Bypass:** Lever operates current bypass device and also supplies clamping action on current meter spades.
- **Connector:** Units are supplied with mechanical type connectors (#4 max.)



Please consult serving utility for their requirements prior to ordering or installing, as specifications and approvals vary by utility, and may require local electrical inspector approval. All installations must be installed by a licensed electrician and must comply with all national and local codes, laws and regulations. Milbank reserves the right to make changes in specifications and features shown without notice or obligation.



# Current Transformer Enclosure

400-1200 Amps

**25**  
CURRENT  
TRANSFORMER  
ENCLOSURE



S1855-O

## Current Transformer Enclosure—Not UL Listed

Central Hudson Approved Only

Catalog Number	Amperage Rating	Hud	Gauge Steel	Connectors CU/AL	Dimensions		
					D"	W"	H"
S1855-O	400-800	Blank	12	#3-750 kcmil Per Phase	12	36	36
S1856-O-HUD	800-1200	Blank	12	#5-750 kcmil Per Phase	12	48	48

Please consult serving utility for their requirements prior to ordering or installing, as specifications and approvals vary by utility, and may require local electrical inspector approval. All installations must be installed by a licensed electrician and must comply with all national and local codes, laws and regulations. Milbank reserves the right to make changes in specifications and features shown without notice or obligation.





**36363612-CT3R**

## Industry Standards

- NEMA —Type 3R
- UL 50—Type 3R
- CUL—Type 3R (Equivalent to CSA)

## Application

- Designed for use as a current transformer cabinet or panel enclosure
- For outdoor use to provide protection against rain, sleet, and snow, or indoor use to protect against dripping water

## Construction

- Enclosure and cover manufactured from 16 or 14 gauge G90U galvanized steel, panels are 10 or 12 gauge, painted white
- The doors are overlapping with no center post
- Continuous door hinge with stainless steel hinge pins
- Three point pad-lockable handle
- Panel mounting studs provided for optional back panels
- Drip shield top and seam free sides, front and back

## Finish

- ANSI 61 gray polyester powder coating over phosphatized G90 galvanized steel.

## Accessories

- Panel - See option P Series on Panel-Steel P Series panels sold separate, add 'W' to the end of panel part number for wood instead of painted steel.
- Touch up paint - See accessories

Catalog Number	Product Family	UPC Number 7-84572-	Weight	Dimensions			P Series Panel Catalog No.	Panel Size
				D"	W"	H"		
363010-CT3R	CN3R	18823	99	36	30	10	<b>A-36P30</b>	36 x 30
363016-CT3R	CN3R	16181	121.5	36	30	16	<b>A-36P30</b>	36 x 30
363610-CT3R	CN3R	17368	113	36	36	10	<b>A-36P36</b>	36 x 36
363612-CT3R	CN3R	16185	118	36	36	12	<b>A-36P36</b>	36 x 36
363616-CT3R	CN3R	18819	139	36	36	16	<b>A-36P36</b>	36 x 36
483616-CT3R	CN3R	25707	163	48	36	16	<b>A-48P36</b>	48 x 36
484812-CT3R	CN3R	16184	210	48	48	12	<b>A-DD4848</b>	48 x 48
606013-CT3R	CN3R	18252	274	60	60	13	<b>A-60P60</b>	60 x 60



Please consult serving utility for their requirements prior to ordering or installing, as specifications and approvals vary by utility, and may require local electrical inspector approval. All installations must be installed by a licensed electrician and must comply with all national and local codes, laws and regulations. Milbank reserves the right to make changes in specifications and features shown without notice or obligation.

# Current Transformer Cabinet

Type 3R

**27**  
CURRENT  
TRANSFORMER  
CABINET



363610-TC3R-H-BP-SP

**CURRENT TRANSFORMER ENCLOSURE**  
NATIONAL GRID APPROVED ONLY

120/240 Volt Single Phase | 208Y/120 Volt & 480/277 Volt Three-Phase

Catalog Number	Amperage Rating	Hub	Gauge Steel	Steel Back Panel	Dimensions		
					D"	W"	H"
363610-TC3R-H-BP-SP	400-800	Blank	16	Installed	10	36	36

Please consult serving utility for their requirements prior to ordering or installing, as specifications and approvals vary by utility, and may require local electrical inspector approval. All installations must be installed by a licensed electrician and must comply with all national and local codes, laws and regulations. Milbank reserves the right to make changes in specifications and features shown without notice or obligation.



# Commercial Pedestals

*Attractive | Easy to install | Secure | Cost-effective*

**Milbank Commercial Pedestals** are pad-mounted, weather resistant electrical enclosures consisting of a utility pull section with optional meter socket, and a customer section containing distribution and control equipment. Milbank Commercial Pedestals are an attractive, secure, easy to install and cost-effective solution when underground remote site power distribution and control equipment is required, replacing unsightly and inefficient strut and backboard structures.



Strut and backboard



Commercial pedestal

## UL Listed as Industrial Control Equipment (File E113855)

### Standard Features

- Type 3R rain resistant, vandal-resistant cabinet of polyurethane powder-coated steel (aluminum or stainless steel also available)
- UL listed as enclosed industrial control equipment (UL508)
- Isolated lockable and sealable utility metering and lug landing sections
- Lockable customer section for distribution and control equipment with internal deadfront
- Print pocket inside customer section door contains wiring schematics and installation instructions
- Most load centers are UL listed for use with various manufacturers' circuit breakers
- All stainless steel external hardware (screws, bolts, hinges, handles, hasps and sealing screws)

### Note

All meter form and bypass options available to meet utility requirements.

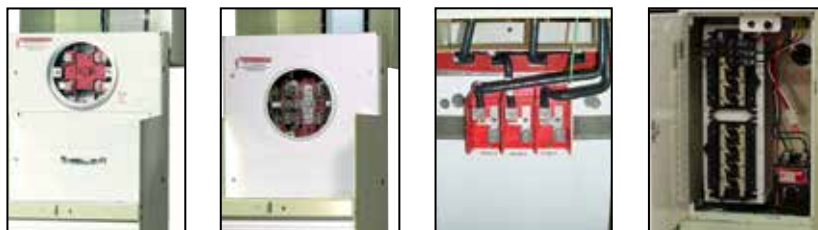

Please consult serving utility for their requirements prior to ordering or installing, as specifications and approvals vary by utility, and may require local electrical inspector approval. All installations must be installed by a licensed electrician and must comply with all national and local codes, laws and regulations. Milbank reserves the right to make changes in specifications and features shown without notice or obligation.

# Commercial Pedestals

Attractive | Easy to install | Secure | Cost-effective

**29**  
COMMERCIAL  
PEDESTALS



## Applications

These units are ideal for controlling and metering:

- Traffic signals
- Street lighting
- Power distribution for EV charging stations
- Irrigation and sprinkler systems
- Cell towers and telephone vaults
- Pump stations
- Temporary power for fairgrounds, swap meets, outdoor markets, portable offices, holiday lights, etc.
- Outdoor lighting for athletic fields, tennis and basketball courts, parking lots, landscaping and subdivision entrances, etc.

## Available Factory-Installed Options

- Meter sockets: ring type or ringless, up to 400 amp
- Main and branch breakers or T fuses
- Distribution: copper load centers and panel boards
- Clocks, timers and relays
- Photoelectric cells and controls
- Power receptacles: pin and sleeve, twist lock or straight blade
- Contactors: definite purpose, electrical or mechanically held, IEC and mercury types
- Surge protection and lightning arrestors
- Reserve inlet generator receptacle with interlocked circuit breakers
- Motor starters and relays
- Push button controls
- Thermostat controls, fans and heating strips
- Power blocks and terminal blocks
- Steel, aluminum and plywood backboards
- Transformers
- Interlock devices for circuit breakers
- Available in steel, aluminum (raw painted or anodized) or stainless steel construction with powder-coated finish available in eight standard colors or special-ordered RAL colors
- Available for applications up to 400 amp, 120V, 208V, 240V, 277V, 480V - 1Ø or 3Ø

## Accessories



**K3865**  
Fifth terminal kit for use with ringless meter sockets



**CP-ABK5/8**  
Anchor bolt kit (includes four 5/8 - 13 x 18" anchor bolts)



**105J**  
Fifth terminal kit for use with ring type meter sockets



**CP-TC7D**  
7-day time clock kit  
**CP-TC24H**  
24-hour time clock kit  
**CP-TCWIRE**  
Male 4-pin connector and wiring harness for use with time clocks other than above

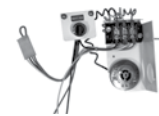

**CP-PE-HOA-3POS**  
HOA switch for field installation



**CP-16PDMNT-CALT**  
16" pedestal mounting base  
**CP-24PDMNT-CALT**  
24" pedestal mounting base (includes mounting hardware)

Please consult serving utility for their requirements prior to ordering or installing, as specifications and approvals vary by utility, and may require local electrical inspector approval. All installations must be installed by a licensed electrician and must comply with all national and local codes, laws and regulations. Milbank reserves the right to make changes in specifications and features shown without notice or obligation.



### CP3B "ML" Series

Main Load Center Series

1Ø3 wire 120/240V or 208Y/120V

Application: remote site service for multiple loads

The **Milbank Main Load Center Commercial Pedestals** are designed to handle the vast majority of all requirements in a standard, stocked configuration.

- All units feature a load center with a plug-on, back-fed main breaker.
- Load center has 16 positions for the 100 amp pedestals and 24 circuits for the 200 amp pedestals.
- Both sizes include sub-feed lugs to allow feeding an external panel.

If your application requires turning loads on based on "dusk-to-dawn" requirements, be sure to see the Milbank Switched Load Center Commercial Pedestal products on the following page.

#### Features

These units include everything required for remote site service:

- NEMA 3R construction.
- Expandable: load centers allow for future expansion without costly modifications.
- All units feature 200 amp meter socket with optional field installable fifth terminal kit available.
- 22K ampere interrupting capacity (AIC) standard.
- Optional mounting base can be embedded in concrete for fast, easy installation.
- Separate sealable and lockable utility termination section.
- Separate sealable and lockable metering section.
- Separate sealable and lockable customer section with a load center for "always on" loads that include a main circuit breaker, 20 (125 or 200 amp model) or 14 (100 amp model) blank breaker spaces and a circuit directory to document configuration.



**CP3B11115A22**

#### Typical Applications

Remote site service for multiple loads.

Stocked Pedestals	Optional Fifth Terminal Kit	Main CB		Load Center Circuits	Meter Socket Type
		Amp	Spaces		
CP3B51115A22	K3865	100	1,2	16	Ringless socket with lever bypass
CP3B52119A22	K3865	200	1,2,3,4	24	Ringless socket with lever bypass

#### Notes

- Chart shows standard, stocked items. Other options and features are available. Contact factory for options, details and availability.



Please consult serving utility for their requirements prior to ordering or installing, as specifications and approvals vary by utility, and may require local electrical inspector approval. All installations must be installed by a licensed electrician and must comply with all national and local codes, laws and regulations. Milbank reserves the right to make changes in specifications and features shown without notice or obligation.

# Commercial Pedestals

## Switched Load Center Series

### CP3B "SL" Series

Switched Load Center Series  
1Ø3 wire 120/240V or 208Y/120V

Milbank's Switched Load Center Commercial Pedestals are designed not only to provide power for various loads, but also to switch specific loads on and off under certain conditions. A photoelectric cell is used for these controlled loads, and an optional time clock is also available.

#### Features

These units include everything required for remote site service:

- NEMA 3R construction.
- Expandable: load centers allow for future expansion without costly modifications.
- All units feature 200 amp meter socket with optional field installable fifth terminal kit available.
- 22K ampere interrupting capacity (AIC) standard.
- Optional mounting base can be embedded in concrete for fast, easy installation.
- Separate sealable and lockable utility termination section.
- Separate sealable and lockable metering section.
- Separate sealable and lockable customer section with a control circuit including PE receptacle, Lexan® window, glare shield, Hand-Off-Auto (HOA) switch, contractor controlling a 16-circuit load center for controlled loads, a pre-mounted DIN rail and pre-wired connector to add an optional "plug-and-play" time clock kit for PE on and TC off operation and a circuit directory to document configuration.
- A load center for "always on" loads that includes a main circuit breaker, a control power circuit breaker, a switched load center main breaker, nine (125 or 200 amp model) or 11 (100 amp model) blank breaker spaces and a circuit directory to document configuration.



CP3B11110A22SL1

#### Typical Applications

Traffic signals, parking lots, highways & athletic field lighting

Stocked Pedestals	Optional Fifth Terminal Kit	Main CB		Contactor Amperage	Meter Socket Type
		Amp	Spaces		
CP3B51110A22SL1	K3865	100	1,3	60	Ringless socket with lever bypass
CP3B52110A22SL1	K3865	200	1,2,3,4	100	Ringless socket with lever bypass

#### Notes

- Chart shows standard, stocked items. Other options and features are available. Contact factory for options, details and availability.

Please consult serving utility for their requirements prior to ordering or installing, as specifications and approvals vary by utility, and may require local electrical inspector approval. All installations must be installed by a licensed electrician and must comply with all national and local codes, laws and regulations. Milbank reserves the right to make changes in specifications and features shown without notice or obligation.





**CP3B1411JB22**

### Typical Applications

Remote site service for residential and commercial job sites.

**Milbank's 400 Amp Commercial Pedestal** is designed to provide a weather and vandal resistant metered enclosure for various loads and distribution. Each pedestal has been designed to handle a wide range of applications using standard, stocked configurations.

- Choice of a single main breaker or twin service disconnect breakers gives flexibility to the pedestal design.
- Optional distribution with feed-thru lugs below the service disconnect breakers allows the pedestal to handle numerous applications.
- Typical applications include remote homes where the metering is best located at the curb side or other remote area. The pedestal can also provide power to secondary residence, on-site business, workshop, irrigation, lighting, security or other secondary load.
- Available in custom colors to match home or landscaping.

### Features

These units include everything required for remote service:

- Type 3R construction
- Main circuit breaker or dual service disconnects
- Expandable: load center units allow for future expansion without costly modifications
- Optional mounting base can be embedded in concrete for fast, easy installation
- Separate sealable and lockable utility termination section with lug termination
- Separate sealable and lockable metering section
- A separate sealable and lockable customer section with a circuit directory and a print pocket to hold all documentation
- Meter socket options include ring type with bypass studs, ringless with heavy duty lever bypass, or K-Type bolt-on

Standard Pedestals	Optional fifth Terminal Kit	Main CB	Load Center Circuits	Meter Socket Type
<b>CP3B54120B22</b>	K3865	2-200 amp	(2) 12 circuit	Ringless with lever bypass
<b>CP3B5411JB22</b>	K3865	320 amp (400 max)	0	Ringless with lever bypass

### Notes

- Chart shows standard, stocked items. Other options and features are available. Contact factory for options, details and availability.
- Stud utility landing is standard. Lug kits are available from factory.
- Units with load centers have (2) #6-250 sub-feed lugs on each load center. (Each load center is 200 amp rated and UL Listed with: Siemens, General Electric and Cutler-Hammer plug-in style circuit breakers.)



Please consult serving utility for their requirements prior to ordering or installing, as specifications and approvals vary by utility, and may require local electrical inspector approval. All installations must be installed by a licensed electrician and must comply with all national and local codes, laws and regulations. Milbank reserves the right to make changes in specifications and features shown without notice or obligation.



# Commercial Pedestals

## Irrigation Control Series



CP3B0281UMWIR04

Milbank's "IR" Series Irrigation Pedestals install quickly and simply – often in less than an hour with a single technician – a fraction of the time typically needed for strut farm and other installation set ups. Additionally, the pedestal comes pre-wired, so the technician simply drops in the pre-drilled concrete box pad, fastens the pedestal and runs the wires. Prewired landing lugs are provided in a separate utility side so that there is no more need to wrestle with hard-to-bend wires. Simply run the utility wire up and land on the lugs. With both the motor starter and disconnect in the same enclosure, all the controls are housed in a safe, lockable pedestal that protects against vandalism and energy theft.

### Features

- 3Ø4W, 480Y/277 volt
- One technician can install in under an hour with use of Milbank's pre-drilled box pad
- All units are UL listed and service entrance rated
- Fused disconnect with accessible handle through the deadfront
- HOA and push button start
- Separate accessible utility side with pre-wired landing lugs
- NEMA rated starters (sizes 1-5)
- Soft start units sizes 30HP-150HP
- 30 amp fuse block for pivot pre-wired in the unit
- White powder coated paint finish helps keep components cooler
  - Options include:
    - Hour meter
    - Chemical injection receptacle
    - Multiple injection receptacle
    - Multiple 30A fuse blocks possible

### Typical Applications

Power pedestal for irrigation systems or other pump control applications.

Stocked Pedestals	Exterior Cabinet	NEMA Rating
CP3B0281UMWIR04	White	4
CP3B0281UMWIR03	White	3
CP3B0181UMWIR02	White	2

### Notes

- Chart shows standard, stocked items. Other options and features are available. Contact factory for options, details and availability.

Please consult serving utility for their requirements prior to ordering or installing, as specifications and approvals vary by utility, and may require local electrical inspector approval. All installations must be installed by a licensed electrician and must comply with all national and local codes, laws and regulations. Milbank reserves the right to make changes in specifications and features shown without notice or obligation.



# Commercial Pedestals

## CP3B "BBS" Battery Backup Series



CP3B5111TCAWSP1

### Typical Applications

Metered emergency uninterrupted power for traffic intersections, wireless, phone and communications equipment, parking lots, camera and security locations.

**Milbank's BBS Series Commercial Pedestals** are designed to provide battery backup power for various loads, and to switch specific loads on and off under certain conditions; a photoelectric cell or time clock to control lighting circuits, as an example. Metered and non-metered power distribution options are available. The back-up power pedestal is designed to handle the vast majority of today's back-up power requirements. By using 19" rack design, shelves can be adjusted to accommodate the required batteries and manufactures DC to AC inverters, transfer switches and other related equipment. This design gives the user a wide range of design and configuration options. Complete turnkey, ready to power-up pedestals are offered along with basic units ready to accept batteries and inverters supplied by others.

### Features

- Type 3R construction
- 100 through 320 amp meter socket with the option of either a ring type socket (conforms to EUSERC 308) with or without test / bypass blocks or a heavy duty ringless socket with lever bypass
- Separate sealable utility termination compartment
- An isolated separate customer section with service disconnects, power distribution options and power control
- 19" wide rack in customer compartment for easy layout of equipment
- Battery trays
- Thermostat with cooling fan
- Filtered louvers for heat rise flow through ventilation
- Three point door latch (key or pad lockable)

### Options

- Manual bypass switch
- Transfer switch for generator power back-up
- Generator inlet receptacles 30A through 200A
- Pad lockable provision for receptacles
- Police access door
- Metered load center distribution
- Non metered load center distribution
- Photo electric controls (for street lighting)
- Time clocks
- HOA switches
- Contactors
- GFI duplex receptacles
- Thermostat for heating control
- Heating pads or elements
- Roll out shelves for batteries
- Surge arrestors and lighting arrestors



Please consult serving utility for their requirements prior to ordering or installing, as specifications and approvals vary by utility, and may require local electrical inspector approval. All installations must be installed by a licensed electrician and must comply with all national and local codes, laws and regulations. Milbank reserves the right to make changes in specifications and features shown without notice or obligation.

# Commercial Pedestals

## CP3B "Power Transfer" Series

**35**  
COMMERCIAL  
PEDESTALS



**Milbank's Power Transfer Series Pedestals** provide non metered AC power, distribution, surge suppression, mechanical interlock and stand-by generator receptacle all in a neat, compact pedestal.

### Features

- 120/240V 1Ø3W thru 277/480V 3Ø4W ratings
- Metered or unmetered units
- Choice of EUSERC ring type or ringless meter sockets
- 60 Amp thru 400 amp ratings
- UL Listed Type 3R rated
- Pad lockable, isolated utility compartments
- 20 amp GFI convenience receptacle
- Lockable recessed generator receptacle door
- Utility and generator indicator light options
- All stainless steel hardware
- Galvanized steel, aluminum or stainless steel cabinet options
- Custom designs available



### Typical Applications

Traffic intersections, cell sites, cable TV, pump and lift stations requiring utility power with backup generator power

Please consult serving utility for their requirements prior to ordering or installing, as specifications and approvals vary by utility, and may require local electrical inspector approval. All installations must be installed by a licensed electrician and must comply with all national and local codes, laws and regulations. Milbank reserves the right to make changes in specifications and features shown without notice or obligation.



# Commercial Pedestals

## CP3BB "CT Metered" Series



### Milbank's CT Metered Series

**Commercial Pedestals** are designed to be used where a smaller service package would be a better choice over large 3R rated combination switchboards. These pedestals have amperage ratings of 400 to 800 amp at voltages up through 480 volt three phase.

### Features

- UL Listed, freestanding Type 3R service
- A low profile CT pedestal
- All utility equipment is isolated in separated pad lockable and sealable compartments
- Separate customer compartment designed to hold distribution and control equipment
- Dead front customer construction
- Optional mounting base
- Optional construction in steel, aluminum and stainless steel.
- Wide choice of powder paint colors

### Typical Applications

Large homes, pumping and lift stations, motor control, water treatment plants, EV charging stations, commercial buildings, large remote service requirements, commercial and industrial control systems.



Please consult serving utility for their requirements prior to ordering or installing, as specifications and approvals vary by utility, and may require local electrical inspector approval. All installations must be installed by a licensed electrician and must comply with all national and local codes, laws and regulations. Milbank reserves the right to make changes in specifications and features shown without notice or obligation.

# Commercial Pedestals

## CP3A "Slimline" Series



Milbank's Slimline Series Commercial Pedestals provide a sleeker, smaller footprint and wireway access on the side of the unit rather than the back, allowing maximum flexibility to place the pedestal in tighter spaces.

### Features

- UL Listed as service equipment
- 100 or 200 amp
- Vandal-resistant, secure and attractive design
- Customer compartment with distribution and control equipment with swing dead front door, secured with both a hasp/latch and draw latch outer door
- Utility metering compartment protected with a hinged hood, increasing resistance to meter vandalism
- Small footprint
- Wireway located on left side of pedestal for utility incoming wire, allowing pedestal to be mounted with back very close to a wall (14")
- Available in 12" and 20" widths and 50" and 63" (metered) and 43" (nonmetered) heights
- Includes a print pocket for plans and drawings
- 200 amp main available
- Voltage range: 120V–480V
- Compatible with both ringless and ring type meter sockets, 4–7 terminals
- Available in a wide array of colors, including but not limited too all ANSI powder coated paint colors upon request
- Pedestal mounting base option saves time and labor to install on a cement pad—no anchor bolts required
- Powder-coated G90 galvanized steel, raw, anodized or powder-coated aluminum and stainless steel exterior options

### "Slimline" Series Direct Bury Extension

- No need for concrete
- Bolts directly to unit
- Easy, modular design
- Ships in a smaller package
- Increases project flexibility
- Easier to handle and install
- Utilizes a stabilizer foot to prevent leaning over time
- Pedestal and extension can be installed within 30 minutes

### Typical Applications

Roadway lighting and signage, wastewater treatment facilities, parks and landscaping, and any application where physical space is at a premium



### Notes

- Currently only built in 14 guage steel
- Only available for 12" pedestals

Please consult serving utility for their requirements prior to ordering or installing, as specifications and approvals vary by utility, and may require local electrical inspector approval. All installations must be installed by a licensed electrician and must comply with all national and local codes, laws and regulations. Milbank reserves the right to make changes in specifications and features shown without notice or obligation.





**UQFP  
UQFPH**



**UQFP-M  
UQFPH-M**



**UQFB-X1**



**UQFB-X**



**UQFB**

**200 amp Frame | Plug-In | 10,000 AIC & 22,000 AIC | Two-Pole - Common Trip**

amp	10K AIC Plug-In	22K AIC Plug-In	10K AIC Plug-In	22K AIC Plug-In	Wire Range	
					CU	AL
100	UQFP-100	UQFPH-100	UQFP-M-100	UQFPH-M-100	#3-#1	#1-1/0
125	UQFP-125	UQFPH-125	UQFP-M-125	UQFPH-M-125	#3-#1	#1-1/0
150	UQFP-150	UQFPH-150	UQFP-M-150	UQFPH-M-150	1/0-300	2/0-300
175	UQFP-175	UQFPH-175	UQFP-M-175	UQFPH-M-175	1/0-300	2/0-300
200	UQFP-200	UQFPH-200	UQFP-M-200	UQFPH-M-200	1/0-300	2/0-300

**200 amp Frame | Bolt-On | 10,000 AIC & 22,000 AIC | Two-Pole - Common Trip**

amp	10K AIC Bolt-On	22K AIC Bolt-On	10K AIC Bolt-On	22K AIC Bolt-On	Wire Range	
					CU	AL
100	UQFB-100	UQFBH-100	UQFB-100-X1	UQFBH-M-100	#3-#1	#1-1/0
125	UQFB-125	UQFBH-125	UQFB-125-X1	UQFBH-M-125	#3-#1	#1-1/0
150	UQFB-150	UQFBH-150	UQFB-150-X1	UQFBH-M-150	1/0-300	2/0-300
175	UQFB-175	UQFBH-175	UQFB-175-X1	UQFBH-M-175	1/0-300	2/0-300
200	UQFB-200	UQFBH-200	UQFB-200-X1	UQFBH-M-200	1/0-300	2/0-300

### Notes

- **UL Listed:** For use with 60°C or 75°C wire.
- **UQFP:** For parallel main circuit breaker applications.
- **UQFP-M:** For series main circuit breaker applications Split load tab features allow for feed-through capability.
- **UQFB:** (2) 1/0-300 lugs provided on load and line side (cable-in, cable-out).
- **UQFB3:** Three-pole available. Consult factory.
- **UQFB-X:** (2) 1/0-300 lugs provided on load side and (2) line bar bus connections on line side.
- **UQFB-M:** For series main circuit breaker applications. Split load tab features allow for feed-through capability.
- **UQFB-X-MOD:** Replacement circuit breaker with line barriers removed.



Please consult serving utility for their requirements prior to ordering or installing, as specifications and approvals vary by utility, and may require local electrical inspector approval. All installations must be installed by a licensed electrician and must comply with all national and local codes, laws and regulations. Milbank reserves the right to make changes in specifications and features shown without notice or obligation.

# Accessories

## Hubs and Closing Plates

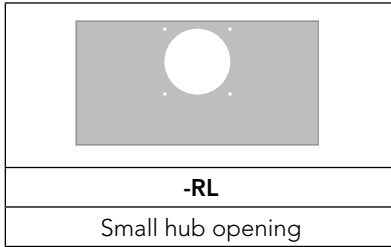

<b>-WL</b>   <b>A7514</b>	<b>-YL</b>   <b>A7515</b>	<b>-ZL</b>   <b>A7516</b>	<b>-DL</b>   <b>A7517</b>	<b>-EL</b>   <b>A7518</b>	<b>-XL</b>   <b>A7551</b>
1" hub	1¼" hub	1½" hub	2" hub	2½" hub	Small closing plate

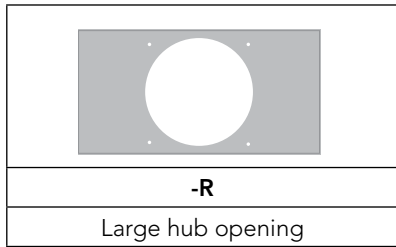

<b>-F</b>   <b>A8110</b>	<b>-G</b>   <b>A8111</b>	<b>H</b>   <b>A8112</b>	<b>-X</b>   <b>A9064</b>	<b>-RRL</b>   <b>S8324</b>
3" hub	3½" hub	4" hub	Large closing plate	Large hub opening adapted to small hub opening

Please consult serving utility for their requirements prior to ordering or installing, as specifications and approvals vary by utility, and may require local electrical inspector approval. All installations must be installed by a licensed electrician and must comply with all national and local codes, laws and regulations. Milbank reserves the right to make changes in specifications and features shown without notice or obligation.



## Connector Kits, Closing Kits and Sealing Rings

### Connector Kits | For Use with 3/8"-16 Stud Type Units Only

Single			Twin		
Suffix	Part #	(3 per set) - 1Ø	Suffix	Part #	(3 per set) - 1Ø
K1	<b>K1539</b>	6-350	K2	<b>K1350</b>	6-350
K3	<b>K1540</b>	4-600 or (2) 1/0-250	K2L	<b>K1350L</b>	6-350 (non rotating)
K3L	<b>K1540L</b>	4-600 or (2) 1/0-250 (non rotating)	K4	<b>K1541</b>	4-600
Suffix	Part #	(4 per set) - 3Ø	Suffix	Part #	(4 per set) - 3Ø
K5	<b>K3082</b>	6-350	K6	<b>K3442</b>	6-350
K7	<b>K3441</b>	4-600 or (2) 1/0-250	K8	<b>K3083</b>	4-600

### Bypass Link



**K8180** (sold in pairs)

### Closing Covers

Meter Closing Plate (Ring Type / Ringless)	Metal Closing Plate (For Ringless Sockets)
<b>6003</b> - Grey Plastic	<b>CP-21</b>
<b>6116</b> - Clear Plastic	

### Generator Interlock

<b>K5815</b> - large QN with small frame Q
<b>K5820</b> - large frame QN with large frame QN
<b>K5830</b> - small frame Q to small frame Q

### Sealing Rings

<b>MR-2</b> - Snap Action	<b>MR-4</b> - Screw Type (Stainless Steel)
<b>MR2-SS</b> - Stainless Steel	

### Touch-Up Paint







**A-GP** - Light Grey

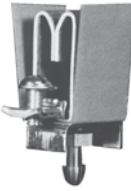

# Accessories

## Fifth Terminal and Tap Connectors

### Fifth Terminal

			
<b>5T8K2</b> - 100-200 amp "Plug-In"	<b>K5T</b> - 200 amp (Block with Square Hole)	<b>K3865</b> - Heavy Duty Jaw Clamping ( <b>K3866</b> without Neutral Wire)	This is for the U2852-56 and U2862-66 Condo metering Banks (125-200 amp) <b>K2381</b>

### Tap Connectors (3 per set)

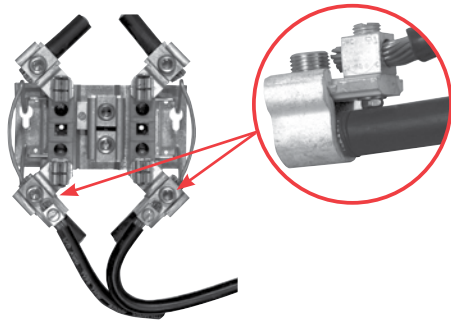
	Replaces the load or line side slide-in nut assembly on Milbank 200 amp sockets. Allows for a 100 amp tap location in addition to the #6-350 kcmil load-side connector. <b>K5022</b> includes safety barrier extensions for applications over 300 VAC. Three lugs per kit.
<b>K4977-INT</b> - Internal Hex	
<b>K4977-EXT</b> - External Hex	
<b>K5022-INT</b> - Internal Hex (set of 4 w/ barrier)	

### Pedestal Extension Units

Catalog Number	D"	W"	H"
<b>S8988</b>	4½	8¾	15
<b>S3488</b>	6	11	15
<b>S2571</b>	4⅞	10	12
<b>S1848</b>	4⅞	13	15
<b>K4694</b>	6	9	24
<b>K5800</b>	4⅞	9	15

### Isolated Neutral Kit



### Anti-Inversion Clip

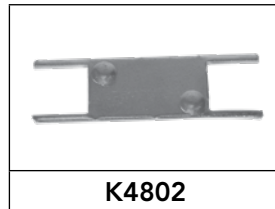

### Disconnect Sleeve



### Triplex Ground



\*Isolated neutrals are specific to the meter socket. Consult factory for correct isolated neutral.

Please consult serving utility for their requirements prior to ordering or installing, as specifications and approvals vary by utility, and may require local electrical inspector approval. All installations must be installed by a licensed electrician and must comply with all national and local codes, laws and regulations. Milbank reserves the right to make changes in specifications and features shown without notice or obligation.



### MAXIMUM NUMBER OF CONDUCTORS IN CONDUIT

Table from 2008 NEC Code Reference: Rigid Metal Conduit

Type	Conductor Size (AWG/kcmil)	Conduit Trade Sizes (Inches)									
		1/2	3/4	1	1 1/4	1 1/2	2	2 1/2	3	3 1/2	4
THHN, THWN, THWN-2	12	9	16	26	46	62	102	146	225	301	387
	10	6	10	17	29	39	64	92	142	189	244
	8	3	6	9	16	22	37	53	82	109	140
	6	2	4	4	12	16	27	38	59	79	101
	4	1	2	4	7	10	16	23	36	48	62
	3	1	1	3	6	8	14	20	31	41	53
	2	1	1	3	5	7	11	19	26	34	44
	1	1	1	1	4	5	8	12	19	25	35
	1/0	1	1	1	3	4	7	10	16	21	27
	2/0	0	1	1	2	3	6	8	13	18	23
3/0	0	1	1	1	3	5	7	11	15	19	
4/0	0	1	1	1	2	4	6	9	12	16	
XHH, XHHW, XHHW-2	4	1	2	4	7	10	16	24	37	49	63
	2	1	1	3	5	7	12	17	26	35	45
	1/0	1	1	1	3	4	7	10	16	22	28
	2/0	0	1	1	2	3	6	9	13	18	23
	4/0	0	1	1	1	2	4	6	9	12	16
	250	0	0	1	1	1	3	5	7	10	13
	350	0	0	1	1	1	2	3	6	7	10
500	0	0	0	1	1	1	2	4	5	7	
750	0	0	0	0	1	1	1	3	4	5	

This table is for concentric stranded conductors only. For cables with compact conductors refer to NEC. Refer to latest NEC Code or Local Codes for updated requirements.

### SAMPLE RATING LABEL

**CATALOG NUMBERS U5952 & U5953**  
100A MAXIMUM, 120/240 VAC SINGLE PHASE, THREE WIRE  
RAINPROOF NEMA TYPE 3R

---

SHORT CIRCUIT CURRENT RATING IS 10,000 RMS SYMMETRICAL AMPERE AT 240 VAC MAXIMUM, BUT IS LIMITED TO THE LOWEST SHORT CIRCUIT CURRENT RATING OF ANY INSTALLED CIRCUIT BREAKER. WATTHOUR METER NOT INCLUDED IN SHORT CIRCUIT CURRENT RATING. REPLACEMENT CIRCUIT BREAKER MUST BE THE SAME TYPE AND RATING. USE SIEMENS CP, QT, CUTLER-HAMMER CP, BD, BR, SQUARE D HOMELINE; G.E. TO, THQ, THQL.

---

SUITABLE FOR USE AS RECREATIONAL VEHICLE SITE SUPPLY EQUIPMENT

---

UNDERGROUND FEED ONLY

---

ON   
TRIP   
OFF

TO RESET BREAKER MOVE TO "OFF" THEN TO "ON"

---

**DANGER**  
HAZARD OF ELECTRICAL SHOCK OR BURN  
**TURN OFF POWER**  
SUPPLYING THIS EQUIPMENT BEFORE WORKING INSIDE

---

WIRE TERMINAL INFORMATION USE AL-CU CONDUCTORS		
TERMINAL	WIRE RANGE	TORQUE LB-IN
LINE AND LINE NEUTRAL	350 kcmil - # 6	250
GROUND CONNECTOR	20 AWG - #14 AWG	120
LOAD NEUTRAL SLOTTED HEAD (LARGE HOLE)	14 - 10	35
	8	40
	6 - 4	45
LOAD NEUTRAL SLOTTED HEAD (SMALL HOLE)	3 - 1/0	50
	14 - 10	20
	8	25
	6	35

SHIPPING TENDS TO LOOSEN BOLTED CONNECTIONS. CHECK AND TIGHTEN ALL HARDWARE BEFORE ENERGIZING UNIT.

SIZE OF FIELD INSTALLED CONDUCTORS SHALL BE 60°C/75°C SIZED TO 60°C RATINGS FOR 110 AMPS OR LESS AND 75°C SIZED TO 75°C FOR 125 AMPS AND ABOVE.

#### \* ALLOWABLE AMPACITIES OF INSULATED COPPER & ALUMINUM CONDUCTORS (3W IN CONDUIT) 75°C (167°F)

*CU		AL or **Cu-Clad AL	
A	B	A	C
18	-	-	-
16	-	-	-
14	20†	-	-
12	25†	12	20†
10	35†	10	30†
8	50	8	40
6	65	6	50
4	85	4	65
3	100	3	75
2	115	2	90
1	130	1	100
1/0	150	1/0	120
2/0	175	2/0	135
3/0	200	3/0	155
4/0	230	4/0	180
250	255	250	205
300	285	300	230
350	310	350	250
400	335	400	270
500	380	500	310
600	420	600	340
700	460	700	375
750	475	750	385

A = Size: AWG/MCM  
 \*B = Ampere Rating for Insulation Types:  
**FEPW, RH, RHW, THW, THWN, XHHW, USE, 2W.**  
 \*\*C = Ampere Rating for Insulation Types:  
**RH, RHW, THW, THWN, XHHW, USE**  
 (Per NEC table 310-16)

#### AMPACITY CORRECTION FACTORS

AMBIENT TEMP. C°	CORRECTION FACTOR	AMBIENT TEMP. F°
21 - 25	1.05	70 - 77
26 - 30	1.00	78 - 86
31 - 35	.94	87 - 95
36 - 40	.88	96 - 104
41 - 45	.82	105 - 113
46 - 50	.75	114 - 122
51 - 55	.67	123 - 131
56 - 60	.58	132 - 140
61 - 65	.33	141 - 158

Overall ampere ratings of U/L listed Milbank multiple position meter sockets are based on 2008 N.E.C. Handbook Article 220-84 and ANSI / UL-414 (except where restricted by line connector size.) These requirements provide for a diversity factor / demand factor being utilized in determining the overall (main bus / lug) rating of a gang socket. All Milbank U/L listed gang sockets meet or exceed these diversity factor/demand factor requirements. Standard overall ampacity ratings for U/L listed and non U/L listed gang sockets are as shown in the chart below. Ampere ratings of meter sockets are based on the meter socket being wired with 75° C insulated wire conductor, sized in accordance with Table 310-16 of the National Electric Code.

#### GANG SOCKET OVERALL AMPACITIES

NO. OF METER POSITIONS	100A / POS. AMPACITY	125A / POS. AMPACITY	150A / POS. AMPACITY	200A / POS. AMPACITY
2	200A	200A	200A	200A #
3	200A	225A	225A	270A
4	200A	250A	270A	360A
5	225A	285A	338A	450A
6	270A	330A	396A	528A

† Unless otherwise permitted elsewhere in the Code, the overcurrent protection for conductor types marked with an obelisk (†) shall not exceed 15 amps for 14 AWG, 20 amps for 12 AWG, and 30 amps for 10 AWG copper; or 15 amps for 12 AWG and 25 amps for 10 AWG aluminum and copper-clad aluminum after any correction factors for ambient temperature and number of conductors have been applied.

# Some constructions are rated at 400 amps overall. Contact your sales representative for more information. Refer to latest NEC Code or Local Codes for updated requirements.



Please consult serving utility for their requirements prior to ordering or installing, as specifications and approvals vary by utility, and may require local electrical inspector approval. All installations must be installed by a licensed electrician and must comply with all national and local codes, laws and regulations. Milbank reserves the right to make changes in specifications and features shown without notice or obligation.

# Energization of Electrical Equipment

## Important Information for Installers

### Important Note

In addition to national and local electrical codes, many utilities have specific requirements for metering equipment. Always consult the serving utility for their specifications and requirements prior to ordering or installing Milbank meter mounting equipment.

### Before Energizing

1. Give equipment a thorough visual examination to determine that:
  - a) No shipping or installation damage exists.
  - b) Proper clearances have been maintained.
  - c) All connections have been made.
  - d) Equipment is clean and dry.
2. Make a thorough examination to:
  - a) Verify tightness of all bolted connections (see table below).
  - b) Manually operate all circuit breakers, switches, relays, etc.
  - c) Check rigidity of all mountings, bus bars and components.
  - d) Use test equipment to check continuity of circuitry and integrity of insulation.
3. All switches and circuit breakers should be in the OFF position.
4. Verify that manual meter bypass (if applicable) is in non-bypass position.
5. Install cover and/or close doors.
6. If installation is not being energized at this time, follow "after-energizing" steps listed below. These steps will secure the installation in case of accidental energization.

### When Energizing

1. Use caution and follow established safety procedures:
  - a) Wear safety apparel.
  - b) Use safety equipment.
  - c) Take action to prevent injury to yourself and others in the event of failure of the installation.
  - d) Take action to prevent/decrease damage to property in the event of failure of the installation.
  - e) If you are unsure how to safely energize the installation, get someone who is knowledgeable to do it.

### After Energizing

1. Secure the installation:
  - a) To prevent accidental contact with energized parts, cover all openings with approved filler devices.
  - b) To prevent unauthorized access, secure all covers and/or doors with approved security devices.
  - c) Attach/post information to advise others of potential hazards associated with the installation.

### Recommended Torque for General Applications\*

Nominal Size	Joint Description		Head Type	Torque (Inch Lbs.)
	Screw	Nut		
10	Brass	Brass Nut or Extruded Hole	All	20-25 inch lbs.
10	Steel	Copper or Aluminum Busbar ≤ 1/8"	All	25-30 inch lbs.
10	Steel	Steel Nut or Extruded Hole; CU or AL Busbar > 1/8"	All	30-35 inch lbs.
12	Steel	Aluminum Extruded Hole	All	30-35 inch lbs.
12	Steel	Steel Nut or Extruded Hole	All	40-50 inch lbs.
1/4	Steel	Aluminum Extruded Hole	All	40-50 inch lbs.
1/4	Steel	Steel Nut or Extruded Hole; CU or AL Busbar	All	50-60 inch lbs.
5/16	Steel	Aluminum Extruded Hole	Hex	60-70 inch lbs.
5/16	Steel	Steel Nut or Extruded Hole; CU or AL Busbar	Hex	100-150 inch lbs.
3/8	Steel	Steel Nut	Hex	150-200 inch lbs.
1/2	Steel	Steel Nut	Hex	200-250 inch lbs.

\* Interior labels typically indicate the required torque for wire connectors and studs, and should be referenced first.  
CU: Copper  
AL: Aluminum

Please consult serving utility for their requirements prior to ordering or installing, as specifications and approvals vary by utility, and may require local electrical inspector approval. All installations must be installed by a licensed electrician and must comply with all national and local codes, laws and regulations. Milbank reserves the right to make changes in specifications and features shown without notice or obligation.



## Materials

### Steel Quality

---

The meter equipment listed in this catalog is made of galvanized steel (AISI\* G90) to afford the best possible weather proofing.  
\*American Iron and Steel Institute.

### Steel Sheet

---

16 gauge, galvanized, sheet: 1 1/4 oz./ sq.ft. class zinc-coated. (AISI G90)  
14 gauge, galvanized, sheet: 1 1/4 oz./ sq.ft. class zinc-coated.

### Aluminum Extrusion

---

Wire-Terminal: Alloy; 6061-T6, Tin-plated for CU/AL wire.  
Bus Bar: Alloy; 6101-O & 6063-O

### Aluminum Sheet

---

3000 series aluminum sheet, H14, or 5052 series aluminum sheet, H32. Where applicable thicknesses range from .064-.125

### Copper Sheet & Bus

---

Electrolytic copper with tin plating in most applications.

### Insulating Materials

---

- In most units, support bases for current-carrying components are molded from fiberglass reinforced high-strength, track resistant, thermoset polyester molding compounds.
- Clear or black safety shields and polarity barriers are molded from high-strength, track resistant, polycarbonate molding compounds.
- Various sheet insulating materials, as appropriate for the application are utilized in the fabrication of flat, formed and punched component parts and barriers.

## Finish

### Process

---

Light gray state-of-the-art electrostatically applied powder paint offers a durable, non-fading finish. For further information concerning the chemical analysis of the weather resistant finish, please contact the factory.

### Metal Fasteners

---

Zinc-coated with a chromate dip.

## Ratings & Compliance

### Ratings & Compliance

---

All Milbank electrical enclosures in this catalog are rated "Type 3R Enclosure" unless specified otherwise on the product's page. All enclosures with a UL designation are constructed per the appropriate UL Standard and may be installed per the National Electric Code. UL procedure files associated with the UL Standards are listed as follows: Meter Sockets (UL 414, File E30202), Test Switches (UL 414, File E62531), Power Outlets (UL 231, File E90945), Panelboards (UL 67, File E32628) and Pullout Switches (UL 1429, File E133062). Additional standards are utilized as applicable: Meter Sockets (ANSI C12.7), Test Switches (ANSI C12.9) and Panelboards (NEMA PB-1).



Please consult serving utility for their requirements prior to ordering or installing, as specifications and approvals vary by utility, and may require local electrical inspector approval. All installations must be installed by a licensed electrician and must comply with all national and local codes, laws and regulations. Milbank reserves the right to make changes in specifications and features shown without notice or obligation.

**DIAGRAM A**  
1 $\emptyset$ 2w with 1 P.T. & 1 C.T.  
Single Stator Meter(2W1 $\emptyset$ ) - Form 3S  
5T Socket, Test Switch #TS04-0101

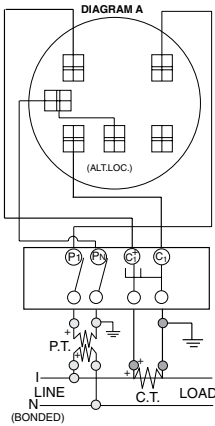

**DIAGRAM B**  
1 $\emptyset$ 3w with 1 C.T.  
Single Stator Meter(2W1 $\emptyset$ ) - Form 3S  
5T Socket, Test Switch #TS04-0101

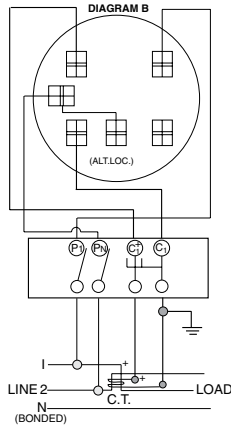

**DIAGRAM C**  
1 $\emptyset$ 3w with 2 C.T.'s  
Single Stator Meter(3W1 $\emptyset$ ) - Form 4S  
6T Socket, Test Switch #TS07-0105

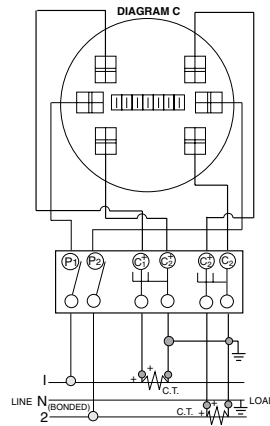

**DIAGRAM D**  
1 $\emptyset$ 3w or 3W Network with 2 C.T.'s  
2 Stator Meter - Form 5S  
8T Socket, Test Switch #TS07-0105

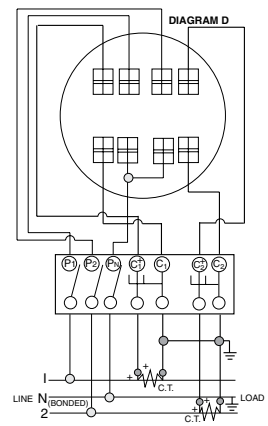

**DIAGRAM E**  
3 $\emptyset$ 3w "Δ" with 2 P.T.'s & 2 C.T.'s  
2 Stator Meter - Form 5S  
8T Socket, Test Switch #TS07-0105

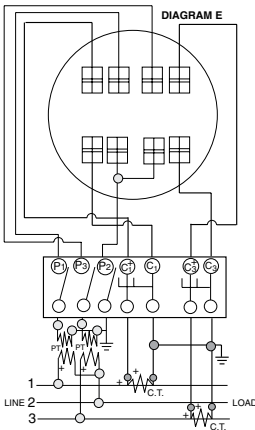

**DIAGRAM F**  
3 $\emptyset$ 3w "Δ" with 2 C.T.'s  
2 Stator Meter - Form 5S  
8T Socket, Test Switch #TS07-0105

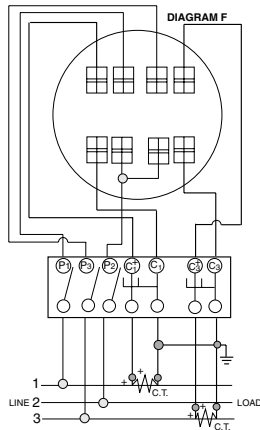

**DIAGRAM G**  
3 $\emptyset$ 4w "Y" with 3 C.T.'s  
2 1/2 Stator Meter - Form 6S  
13T Socket, Test Switch #TS10-0109

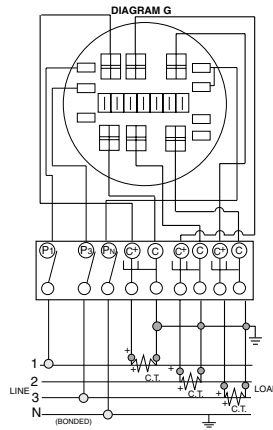

**DIAGRAM H**  
3 $\emptyset$ 4w "Y" with 2 P.T.'s & 3 C.T.'s  
1 1/2 Stator Meter - Form 6S  
13T Socket, Test Switch #TS10-0109

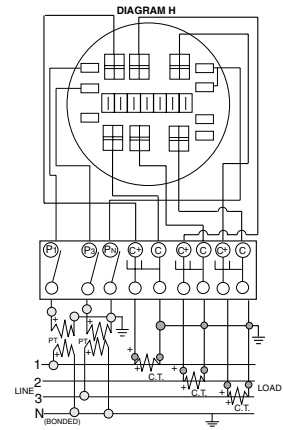

**DIAGRAM I**  
3 $\emptyset$ 4w "Y" or "Δ" with 3 C.T.'s  
"Y" 3 Stator Meter - Form 9S  
"Δ" 2 Stator Meter - Form 8S  
13T Socket, Test Switch #TS10-0109

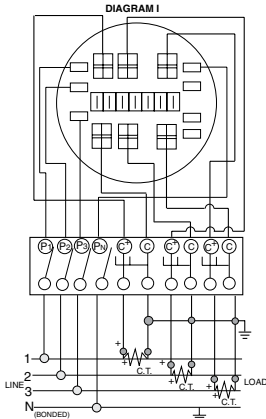

**DIAGRAM J**  
3 $\emptyset$ 4w "Y" with 3 P.T.'s & 3 C.T.'s  
3 Stator Meter - Form 9S  
13T Socket, Test Switch #TS10-0109

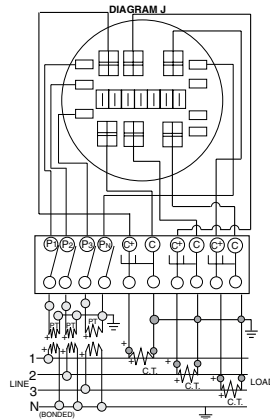

**Prewiring:** If standard factory prewiring is required, refer to wiring diagrams on this page. Determine appropriate diagram and send a copy with order. If custom factory prewiring is required, specify on order. Be sure to include meter socket catalog number, test switch make and catalog number, meter form number and provide a copy of your wiring diagram.

Please consult serving utility for their requirements prior to ordering or installing, as specifications and approvals vary by utility, and may require local electrical inspector approval. All installations must be installed by a licensed electrician and must comply with all national and local codes, laws and regulations. Milbank reserves the right to make changes in specifications and features shown without notice or obligation.



# Watthour Meter Forms

Standard Forms | Transformer Rated or Self-Contained

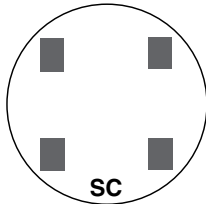

**SC**  
2 and 3-WIRE FORMS  
1S & 2S

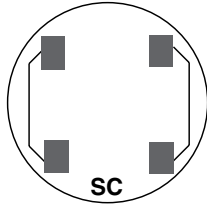

**SC**  
2 and 3-WIRE FORMS  
1S & 2S with BYPASS

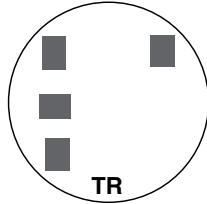

**TR**  
2-WIRE FORM 3S  
5th Term. 9 o'clock

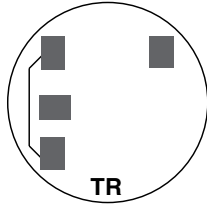

**TR**  
2-WIRE FORM 3S  
with BYPASS

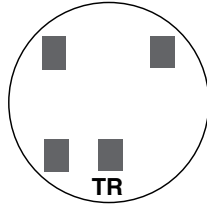

**TR**  
2-WIRE FORM 3S  
5th Term. 6 o'clock

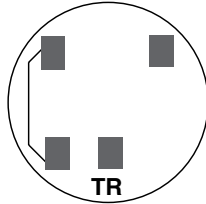

**TR**  
2-WIRE FORM 3S  
with BYPASS

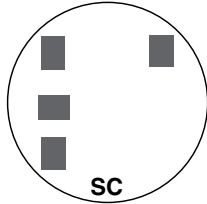

**SC**  
2 ELEMENT  
3-WIRE NETWORK  
FORM 12S 5th  
TERM. 9 o'clock

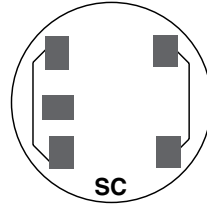

**SC**  
2 ELEMENT 3-WIRE  
NETWORK FORM 12S  
with BYPASS  
5th Term. 9 o'clock

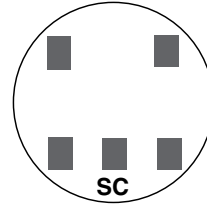

**SC**  
2 ELEMENT  
3-WIRE NETWORK  
FORM 12S 5th  
TERM. 6 o'clock

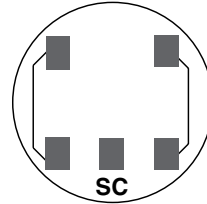

**SC**  
2 ELEMENT 3-WIRE  
NETWORK FORM 12S  
with BYPASS  
5th Term. 6 o'clock

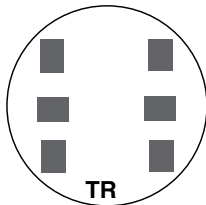

**TR**  
3-WIRE FORM 4S

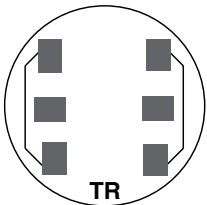

**TR**  
3-WIRE FORM 4S  
WITH BYPASS

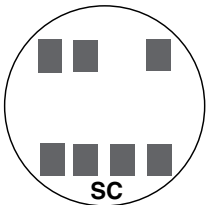

**SC**  
2 or 3 ELEMENT  
3Ø4W Y or  
Y FORM 14S  
FORM 15S  
Y FORM 16S

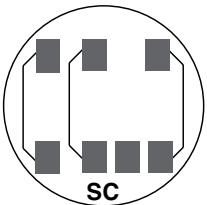

**SC**  
2 or 3 ELEMENT  
3Ø4W Y or  
FORMS 14S & 15S  
with BYPASS

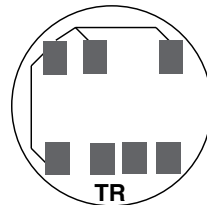

**TR**  
2 ELEMENT  
3Ø4W Y or  
Y FORM 7S  
FORM 24S  
with BYPASS

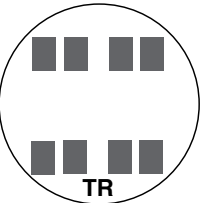

**TR**  
2 ELEMENT  
2Ø3W, 2Ø4W, 3Ø3W  
FORM 5S

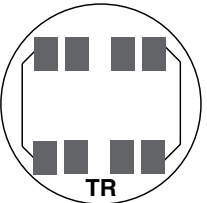

**TR**  
2 ELEMENT Ø3W,  
2Ø4W, 3Ø3W  
FORM 5S with  
BYPASS

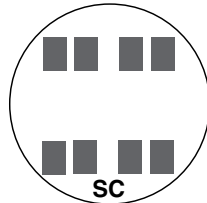

**SC**  
2 ELEMENT  
2Ø3W, 2Ø4W, 3Ø3W  
FORM 13S

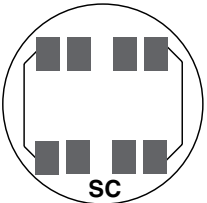

**SC**  
2 or 3 ELEMENT  
2Ø3W, 2Ø4W, 3Ø3W  
FORM 13S with  
BYPASS

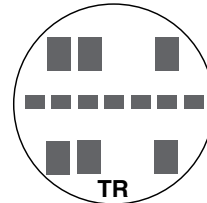

**TR**  
2 or 3 ELEMENT  
3Ø4W Y or  
Y FORM 9S  
FORM 8S

TR = TRANSFORMER RATED  
SC = SELF CONTAINED

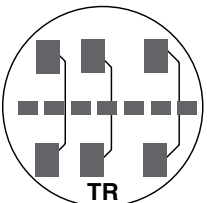

**TR**  
2 or 3 ELEMENT  
3Ø4W Y or  
FORMS 8S & 9S  
FORMS 8S & 9S  
with BYPASS

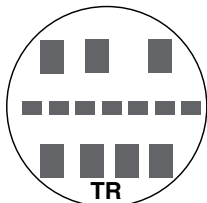

**TR**  
2 ELEMENT  
3Ø4W Y  
FORM 6S

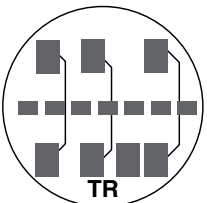

**TR**  
2 ELEMENT  
3Ø4W Y  
FORM 6S  
with BYPASS



Please consult serving utility for their requirements prior to ordering or installing, as specifications and approvals vary by utility, and may require local electrical inspector approval. All installations must be installed by a licensed electrician and must comply with all national and local codes, laws and regulations. Milbank reserves the right to make changes in specifications and features shown without notice or obligation.

# Standard NEMA Configurations

Reference Information Only

## 2 Pole | 3 Wire | Grounding Receptacles

Straight Blade Wiring Devices				Twist-Lock Wiring Devices				
Volts	Code	15 amp	20 amp	30 amp	50 amp	15 amp	20 amp	30 amp
125	5							
		5-15R	5-20R	5-30R	5-50R	L5-15R	L5-20R	L5-30R
250	6							
		6-15R	6-20R	6-30R	6-50R	L6-15R	L6-20R	L6-30R
277 VAC	7							
		7-15R	7-20R	7-30R	7-50R	L7-15R	L7-20R	L7-30R

## 3 Pole | 3 Wire | Special Applications

Straight Blade Wiring Devices			Twist-Lock Wiring Devices			
Volts	Code	20 amp	30 amp	50 amp	20 amp	30 amp
125V 250V	10					
		10-20R	10-30R	10-50R	L10-20R	L10-30R

## 3 Pole | 4 Wire | Grounding

Straight Blade Wiring Devices				Twist-Lock			
Volts	Code	15 amp	20 amp	30 amp	50 amp	20 amp	30 amp
125V 250V	14						
		14-15R	14-20R	14-30R	14-50R	L14-20R	L14-30R

## 2 Pole | 3 Wire | Grounding | NEMA Trailer

Straight Blade Wiring Devices		
Volts	Code	30 amp
125V	TT	

Please consult serving utility for their requirements prior to ordering or installing, as specifications and approvals vary by utility, and may require local electrical inspector approval. All installations must be installed by a licensed electrician and must comply with all national and local codes, laws and regulations. Milbank reserves the right to make changes in specifications and features shown without notice or obligation.



# Utility Approval Chart

Catalog Number	C.H.	NYS EG	National Grid NY	RGE
U3802				
U3812				
U3832				
U3862				
U3822-20GWR				
U4175-RL-BLG			X	
U7021-RL-TG-KK-RGE		X	X	X
U7040-RL-TG-KK-RGE	X	X		X
U7487-RL-TG-KK	X	X		
U9090-O			X	
U2048-RL	X		X	
U9551-RL				X
U9551-RXL				
U9801-R	X			
U2046-O			X	
U2047-O			X	
U2049-RL			X	
U9701-R	X			
U2448-X-RGE	X		X	X
U2594-X	X		X	X
U4013-X			X	X
U5161-X			X	X
U5168-XTL-100-KK	X	X	X	X
U5168-XTL-100-KK-PL	X	X	X	X
U5168-XTL-150-KK	X	X	X	X
U5168-XTL-200-KK	X	X	X	X
U5168-XTL-200-KK-PL	X	X	X	X
U5268-XTL-150-KK				
U5268-XTL-200-KK				
U1252-R-KK-RGE	X	X	X	X
U1253-R-KK-RGE	X	X	X	X
U1254-R-KK-EX-RGE	X	X	X	X
U1255-R-KK-EX-RGE	X	X	X	X
U1256-R-KK-EX-RGE	X	X	X	X
U2852-X			X	
U2853-X			X	
U2854-X			X	
U2855-X			X	

Catalog Number	C.H.	NYS EG	National Grid NY	RGE
U2856-X			X	
U2862-X			X	
U2863-X			X	X
U2864-X			X	X
U2865-X			X	X
U2866-X			X	X
U5882-X-KK-BL		x	x	x
U5882-X-KK-BLG		x	x	x
U5883-X-KK-BL		x	x	x
U5883-X-KK-BLG		x	x	x
U5884-X-KK-BL		x	x	x
U5884-X-KK-BLG		x	x	x
U5885-X-KK-BL		x	x	x
U5885-X-KK-BLG		x	x	x
U5886-X-KK-BL		x	x	x
U5886-X-KK-BLG		x	x	x
U5902-X-KK-BL		x	x	x
U5902-X-KK-BLG		x	x	x
U5903-X-KK-BL		x	x	x
U5903-X-KK-BLG		x	x	x
U5904-X-KK-BL		x	x	x
U5904-X-KK-BLG		x	x	x
U5905-X-KK-BL		x	x	x
U5905-X-KK-BLG		x	x	x
U5906-X-KK-BL		x	x	x
U5906-X-KK-BLG		x	x	x
U2872-XT			X	
U2873-XT			X	
U2874-XT			X	
U2875-XT			X	
U2876-XT			X	
U2732-XT			X	
U2733-XT			X	
U2734-XT			X	
U2735-XT			X	



Please consult serving utility for their requirements prior to ordering or installing, as specifications and approvals vary by utility, and may require local electrical inspector approval. All installations must be installed by a licensed electrician and must comply with all national and local codes, laws and regulations. Milbank reserves the right to make changes in specifications and features shown without notice or obligation.



# Utility Approval Chart

Catalog Number	C.H.	NYS EG	National Grid NY	RGE
U2736-XT			X	
U4093N-O			X	X
U5136-O			X	
U5136-O-100S			X	
U5136-O-200S			X	
U5137-O			X	
U5137-O-100S			X	
U5137-O-200S			X	
U5138-O				
U5138-O-200S				
U5139-O				
U4493-XL	X			
S1855-O	X			
S1856-O-HUD				
363010-CT3R			X	
363016-CT3R			X	
363610-CT3R			X	
363612-CT3R			X	
363616-CT3R			X	
483616-CT3R			X	
484812-CT3R			X	
606013-CT3R			X	
363610-TC3R-H-BP-SP			X	

Please consult serving utility for their requirements prior to ordering or installing, as specifications and approvals vary by utility, and may require local electrical inspector approval. All installations must be installed by a licensed electrician and must comply with all national and local codes, laws and regulations. Milbank reserves the right to make changes in specifications and features shown without notice or obligation.



6003.....	40	K4802 .....	41	U2866-X.....	16
6116.....	40	K4977-EXT.....	41	U2872-XT.....	19
363010-CT3R.....	26	K4977-INT .....	41	U2873-XT.....	19
363016-CT3R.....	26	K5022-INT .....	41	U2874-XT.....	19
363610-CT3R.....	26	K5800 .....	41	U2875-XT.....	19
363610-TC3R-H-BP-SP .....	27	K5815 .....	40	U2876-XT.....	19
363612-CT3R.....	26	K5820 .....	40	U3802 .....	6
363616-CT3R.....	26	K5830 .....	40	U3812 .....	6
483616-CT3R.....	26	K5T .....	41	U3822-20GWR.....	7
484812-CT3R.....	26	M5-144 .....	41	U3832 .....	6
5T8K2 .....	41	MR-2 .....	40	U3862 .....	6
606013-CT3R.....	26	MR2-SS.....	40	U4013-X.....	13
A7514 .....	39	MR-4 .....	40	U4093N-O .....	21
A7515 .....	39	-R .....	39	U4175-RL-BLG .....	8
A7516 .....	39	-RL.....	39	U4493-XL.....	24
A7517 .....	39	S1848.....	41	U5136-O .....	23
A7518 .....	39	S1855-O.....	25	U5136-O-100S.....	23
A7551 .....	39	S1856-O-HUD.....	25	U5136-O-200S.....	23
A8110 .....	39	S2571.....	41	U5137-O .....	23
A8111 .....	39	S3488.....	41	U5137-O-100S.....	23
A8112 .....	39	S8324.....	39	U5137-O-200S.....	23
A9064 .....	39	S8988.....	41	U5138-O .....	23
A-GP.....	40	U1252-R-KK-RGE.....	15	U5138-O-200S.....	23
CP-21.....	40	U1253-R-KK-RGE.....	15	U5139-O .....	23
CP3B51110A22SL1.....	31	U1254-R-KK-EX-RGE.....	15	U5161-X.....	13
CP3B51115A22 .....	30	U1255-R-KK-EX-RGE.....	15	U5168-XTL-100-KK.....	14
CP3B5111RASP .....	33	U1256-R-KK-EX-RGE.....	15	U5168-XTL-100-KK-PL.....	14
CP3B52110A22SL1.....	31	U2046-O .....	12	U5168-XTL-150-KK.....	14
CP3B52119A22 .....	30	U2047-O .....	12	U5168-XTL-200-KK.....	14
CP3B54111JB22.....	32	U2048-RL.....	11	U5168-XTL-200-KK-PL.....	14
CP3B54120B22.....	32	U2049-RL.....	12	U5268-XTL-150-KK.....	14
K1047 .....	41	U2448-X-RGE.....	13	U5268-XTL-200-KK.....	14
K1190 .....	41	U2594-X.....	13	U5882-X-KK-BL.....	17
K1350 .....	40	U2732-XT.....	20	U5882-X-KK-BLG.....	17
K1350L.....	40	U2733-XT.....	20	U5883-X-KK-BL.....	17
K1539 .....	40	U2734-XT.....	20	U5883-X-KK-BLG.....	17
K1540 .....	40	U2735-XT.....	20	U5884-X-KK-BL.....	17
K1540L.....	40	U2736-XT.....	20	U5884-X-KK-BLG.....	17
K1541 .....	40	U2852-X.....	16	U5885-X-KK-BL.....	17
K2381 .....	41	U2853-X.....	16	U5885-X-KK-BLG.....	17
K3082 .....	40	U2854-X.....	16	U5886-X-KK-BL.....	17
K3083 .....	40	U2855-X.....	16	U5886-X-KK-BLG.....	17
K3441 .....	40	U2856-X.....	16	U5902-X-KK-BL.....	17
K3442 .....	40	U2862-X.....	16	U5902-X-KK-BLG.....	17
K3865 .....	41	U2863-X.....	16	U5903-X-KK-BL.....	17
K3866 .....	41	U2864-X.....	16	U5903-X-KK-BLG.....	17
K4694 .....	41	U2865-X.....	16	U5904-X-KK-BL.....	17



Please consult serving utility for their requirements prior to ordering or installing, as specifications and approvals vary by utility, and may require local electrical inspector approval. All installations must be installed by a licensed electrician and must comply with all national and local codes, laws and regulations. Milbank reserves the right to make changes in specifications and features shown without notice or obligation.

U5904-X-KK-BLG .....	17	UQFP-M-100.....	38
U5905-X-KK-BL.....	17	UQFP-M-125.....	38
U5905-X-KK-BLG .....	17	UQFP-M-150.....	38
U5906-X-KK-BL.....	17	UQFP-M-175.....	38
U5906-X-KK-BLG .....	17	UQFP-M-200.....	38
U7021-RL-TG-KK-RGE .....	9		
U7040-RL-TG-KK-RGE .....	9		
U7487-RL-TG-KK .....	9		
U9090-O .....	10		
U9551-RL .....	11		
U9551-RXL.....	11		
U9701-R.....	12		
U9801-R.....	11		
UQFB-100.....	38		
UQFB-100-X1 .....	38		
UQFB-125.....	38		
UQFB-125-X1 .....	38		
UQFB-150.....	38		
UQFB-150-X1 .....	38		
UQFB-175.....	38		
UQFB-175-X1 .....	38		
UQFB-200.....	38		
UQFB-200-X1 .....	38		
UQFBH-100 .....	38		
UQFBH-125 .....	38		
UQFBH-150 .....	38		
UQFBH-175 .....	38		
UQFBH-200 .....	38		
UQFBH-M-100.....	38		
UQFBH-M-125.....	38		
UQFBH-M-150.....	38		
UQFBH-M-175.....	38		
UQFBH-M-200.....	38		
UQFP-100.....	38		
UQFP-125.....	38		
UQFP-150.....	38		
UQFP-175.....	38		
UQFP-200.....	38		
UQFPH-100 .....	38		
UQFPH-125 .....	38		
UQFPH-150 .....	38		
UQFPH-175 .....	38		
UQFPH-200 .....	38		
UQFPH-M-100.....	38		
UQFPH-M-125.....	38		
UQFPH-M-150.....	38		
UQFPH-M-175.....	38		
UQFPH-M-200.....	38		

Please consult serving utility for their requirements prior to ordering or installing, as specifications and approvals vary by utility, and may require local electrical inspector approval. All installations must be installed by a licensed electrician and must comply with all national and local codes, laws and regulations. Milbank reserves the right to make changes in specifications and features shown without notice or obligation.



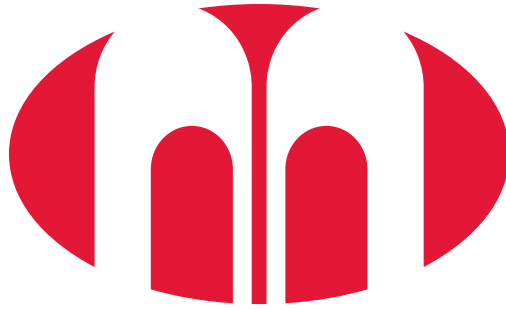

# MILBANK<sup>®</sup>

ENERGY AT WORK

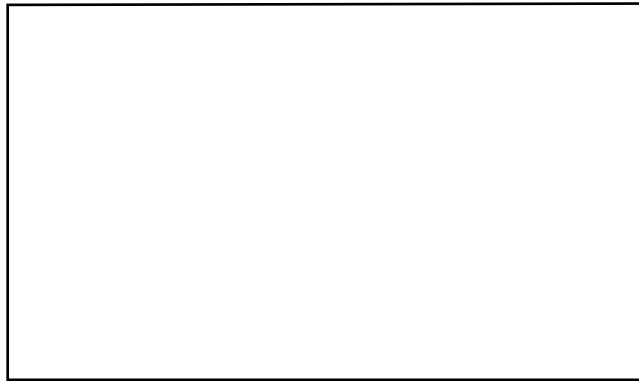

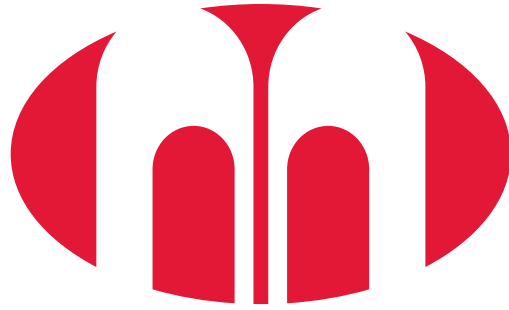

**MILBANK**<sup>®</sup>  
ENERGY AT WORK



# Upstate New York

*Meter Mounting Equipment*



# Milbank Overview

## *Energy At Work since 1927*

Milbank designs and manufactures electrical solutions that move and manage power for the residential, commercial, industrial, utility and transportation sectors. With 90 years of expertise in electrical engineering design and manufacturing, Milbank's portfolio includes metering equipment, enclosures and enclosed controls. Founded in 1927, Milbank is a family-owned, American manufacturer headquartered in Kansas City, Mo. For more information, please visit [milbankworks.com](http://milbankworks.com).

### METERING



As a market leader in electrical metering equipment, Milbank has set the standard for quality since 1927. Hundreds of configurations are available, including many sizes, knockout configurations, terminal configurations, bypass options, hubs, locks and connectors. Milbank has the socket you need with thousands of active products to meet your utility's requirements.

### ENCLOSURES



Milbank's line of enclosures include commercial junction boxes, panel mount enclosures, transformer cabinets, wireway, trough and industrial panel mount and push-button enclosures. Built with high-quality craftsmanship and materials which meet or exceed industry standards, Milbank enclosures are made to protect controls and equipment from dust, dirt and other harmful elements found in a wide variety of environments.

### ENCLOSED CONTROLS



Milbank doesn't just build empty enclosures. We can deliver the entire package, complete with custom control equipment built to your exact specifications by our engineers. Milbank commercial pedestals are an attractive, secure, easy to install and cost-effective solution when underground remote site power distribution and control equipment is required, replacing unsightly and inefficient strut and backboard structures.



Please consult serving utility for their requirements prior to ordering or installing, as specifications and approvals vary by utility, and may require local electrical inspector approval. All installations must be installed by a licensed electrician and must comply with all national and local codes, laws and regulations. Milbank reserves the right to make changes in specifications and features shown without notice or obligation.

# Table of Contents

## Air Conditioner Disconnects

---

30 & 60 amp AC disconnects .....	6
60 amp AC disconnect with 20 amp GFCI receptacle .....	7

## Single Position Sockets

---

100 amps, 4 terminals, solar, ringless .....	8
125 & 200 amps, 4 terminals, ringless .....	9
200 amps, 4 terminals, ringless.....	10
100-200 amps, 4 & 5 terminals, lever bypass, ringless .....	11
200 amps, 5 & 7 terminals, lever bypass, ringless .....	12
200 amps, 4 & 7 terminals, lever bypass, ringless .....	13

## Meter Main with Load Center

---

100-200 amps, 4 terminal, lever bypass, ringless .....	14
--	----

## Multi-Position

---

200 amps, 4 terminals, ringless.....	15
125 & 200 amp, 4 terminals, meter main, ringless.....	16
100-200 amp, 4 terminals, meter main, ringless.....	17-18
200 amp, 5 & 7 terminals, lever bypass, ringless.....	19-20

## Miscellaneous

---

Service Pedestals .....	21-23
CT Rated Sockets.....	24
Current transformer enclosures .....	25-27
Commercial Pedestals.....	28-37
Circuit Breakers .....	38
Accessories .....	39-41
Reference information .....	42-47
Approval Chart .....	48-49
Index.....	50

Please consult serving utility for their requirements prior to ordering or installing, as specifications and approvals vary by utility, and may require local electrical inspector approval. All installations must be installed by a licensed electrician and must comply with all national and local codes, laws and regulations. Milbank reserves the right to make changes in specifications and features shown without notice or obligation.







# Catalog Number Logic

How our product catalog numbers are derived

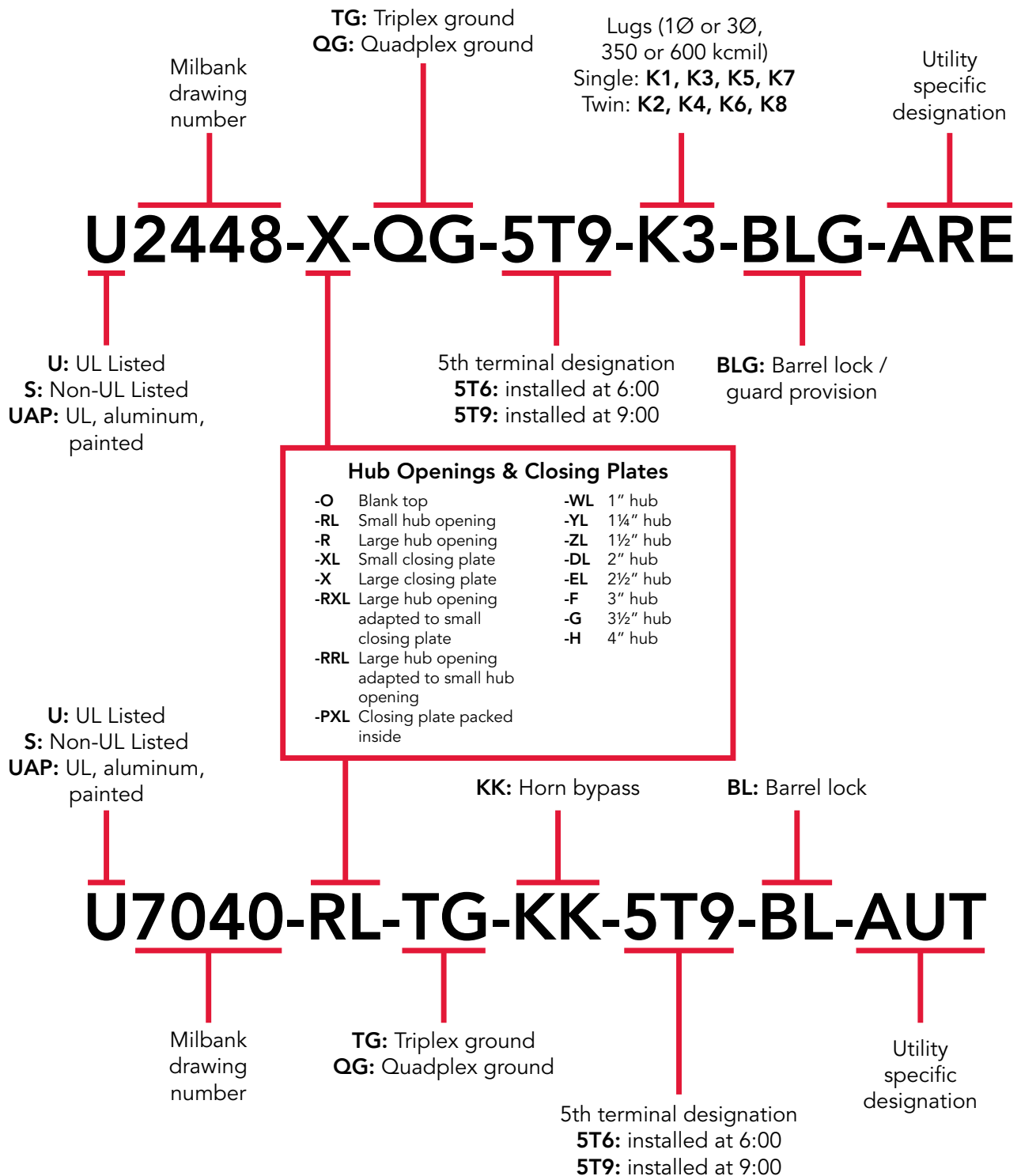

Please consult serving utility for their requirements prior to ordering or installing, as specifications and approvals vary by utility, and may require local electrical inspector approval. All installations must be installed by a licensed electrician and must comply with all national and local codes, laws and regulations. Milbank reserves the right to make changes in specifications and features shown without notice or obligation.



# Air Conditioner Disconnects

30 & 60 Amps | Fusible & Non-Fusible



**U3802**



**U3812**



**U3832**

Milbank’s air conditioner disconnect has a removable hinged cover for ease of installation. Our compact design meets NEC wiring space requirements and also complies with NEC article 440-14. For safe working conditions, our disconnect pullers may be removed and reinstalled in the OFF position. Additionally, padlock provisions are included on the front cover. As with other Milbank products, our enclosure is constructed of G90U galvanized steel and electrostatically finished with an attractive, light gray, baked powder coating. Our epoxy/polyester resin blend offers a finish that is both durable and fade-resistant.

## 30–60 Amps | 1Ø 240 VAC | Air Conditioner Disconnects

Catalog Number	Amps	Type	Max H.P.	Weight (lbs.)	Line/Load Wire Range		Ground Wire Range CU/AL	Dimensions			Wire Rating	
					CU	AL		D"	W"	H"	CU °C	AL °C
<b>U3802</b>	60	Non-Fusible	10	3.25	#14-#2	#12-#2	#14-4	2½	5	7½	60°/75°	60°/75°
<b>U3812</b>	60	Non-Auto	10	3.25	#14-#2	#12-#2	#14-4	2½	5	7½	60°/75°	60°/75°
<b>U3832</b>	30	Fusible	3	2.5	#14-#3	#14-#3	#14-3	2½	5	7	60°/75°	60°/75°
<b>U3862</b>	60	Fusible	10	3.3	#14-#3	#14-#3	#14-3	2½	5	9	60°/75°	60°/75°

### Notes

- UL listed as Enclosed Pullout Switch
- Type 3R rainproof
- One-inch concentric knockouts



Please consult serving utility for their requirements prior to ordering or installing, as specifications and approvals vary by utility, and may require local electrical inspector approval. All installations must be installed by a licensed electrician and must comply with all national and local codes, laws and regulations. Milbank reserves the right to make changes in specifications and features shown without notice or obligation.

# Air Conditioner Disconnects

## 20 Amp GFCI Receptacle



U3822-20GWR

### Specifications

- Meets NEC #210.63 requirements
- UL listed as Power Outlet
- Type 3R enclosure
- In-use cover\*
- Duplex ground connector
- 1" concentric knockouts
- 1Ø, 240 volt
- 60 amp, non-fused
- 20 amp GFCI receptacle
- Reset/test button
- Weather and tamper resistant
- Meets NEC #406.8 requirements

### 60 Amps | 1Ø, 240 VAC | Air Conditioner Disconnect with GFCI Receptacle

Catalog Number	Type	Max H.P.	Weight (lbs.)	Line/Load Wire Range		Ground Wire Range CU/AL	Dimensions			Wire Rating	
				CU	AL		D"	W"	H"	CU °C	AL °C
U3822-20GWR	Non-Fusible	10	6	#14-#2	#12-#2	#14-4	4½	5¼	7½	60°/75°	60°/75°

### Notes

- **Disconnect Pullers:** To ensure the safest conditions, Milbank disconnect pullers are reversible so they may be reinstalled in the OFF position.
- **Padlock Provision:** All units are designed with a padlock provision on the cover for security.
- **\*In-Use Cover:** Cover is rated as an in-use cover (cover may be closed with cords plugged into receptacle).

Please consult serving utility for their requirements prior to ordering or installing, as specifications and approvals vary by utility, and may require local electrical inspector approval. All installations must be installed by a licensed electrician and must comply with all national and local codes, laws and regulations. Milbank reserves the right to make changes in specifications and features shown without notice or obligation.



# Single Position Solar Sockets

100 amp | 4 Terminal | 600 VAC

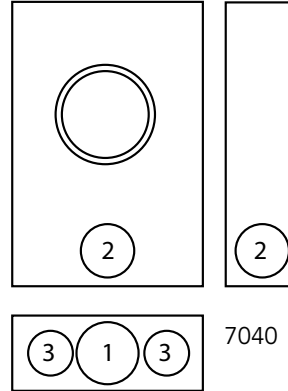

U4175-RL-BLG

100 Amp | 4 Terminal | Load Control Socket | Ringless\*

Catalog Number	Utility Number	Hub	Connectors CU/AL	Dimensions			Knockouts		
				D"	W"	H"	1	2	3
U4175-RL-BLG	M-361	H.O.	#12-#1 AWG	3 <sup>5</sup> / <sub>16</sub>	8	11 <sup>1</sup> / <sub>2</sub>	2	1 <sup>1</sup> / <sub>2</sub>	1 <sup>1</sup> / <sub>4</sub>

## Notes

- **HUB:** For proper hub selection, see the hub suffix chart on the accessory page.
- **Application:** For use on CATV Power Supply Service, Billboard Lighting Service, Traffic Signal Service



Please consult serving utility for their requirements prior to ordering or installing, as specifications and approvals vary by utility, and may require local electrical inspector approval. All installations must be installed by a licensed electrician and must comply with all national and local codes, laws and regulations. Milbank reserves the right to make changes in specifications and features shown without notice or obligation.

# Single Position Sockets

125 & 200 amps

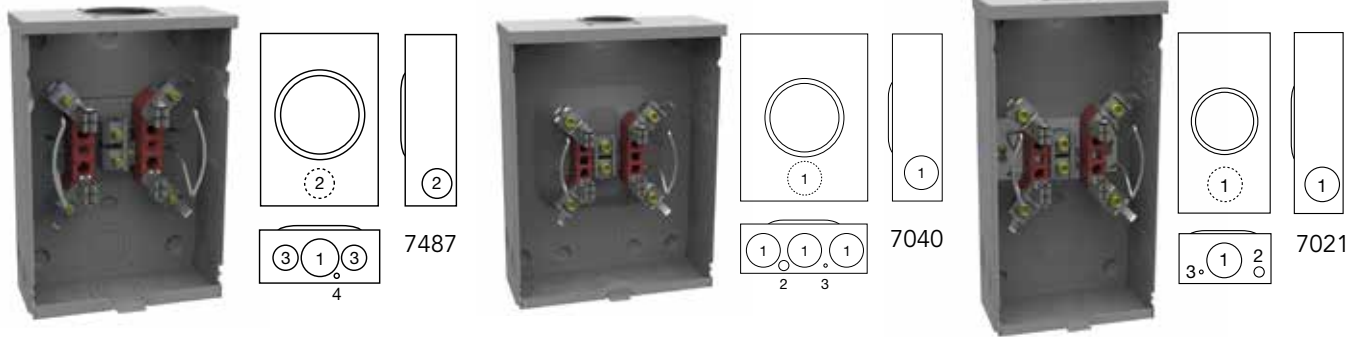

**U7487-RL-TG-KK**  
(APPROVED FOR NYSEG  
& CENTRAL HUDSON)

**U7040-RL-TG-KK-RGE**  
(APPROVED FOR NYSEG, RGE &  
CENTRAL HUDSON)

**U7021-RL-TG-KK-RGE**  
(APPROVED FOR NYSEG, RGE  
& NATIONAL GRID NY SERVICE  
AREAS)

## 125 Amps | 4 Terminal | Ringless | Horn Bypass

Catalog Number	Central Hudson Code#	Service	Hub	Connectors CU/AL		Dimensions			Knockouts			
				Line	Load	D"	W"	H"	1	2	3	4
U7487-RL-TG-KK	CH-063	OH/UG	H.O.	#6-2/0	#6-2/0	3 <sup>5</sup> / <sub>16</sub>	8	11 <sup>1</sup> / <sub>2</sub>	2	1 <sup>1</sup> / <sub>2</sub>	1 <sup>1</sup> / <sub>4</sub>	1 <sup>1</sup> / <sub>4</sub>

## 200 Amps | 4 Terminal | Ringless | Horn Bypass

Catalog Number	Central Hudson Code#	Service	Hub	Connectors CU/AL		Dimensions			Knockouts		
				Line	Load	D"	W"	H"	1	2	3
U7021-RL-TG-KK-RGE	-	OH	H.O.	#6-350 kcmil	#6-350 kcmil	4 <sup>1</sup> / <sub>8</sub>	8	15 <sup>1</sup> / <sub>2</sub>	2 <sup>1</sup> / <sub>2</sub>	1 <sup>1</sup> / <sub>2</sub>	1 <sup>1</sup> / <sub>4</sub>
U7040-RL-TG-KK-RGE *	CH-069	OH/UG	H.O.	#6-350 kcmil	#6-350 kcmil	4 <sup>1</sup> / <sub>8</sub>	11	15 <sup>1</sup> / <sub>2</sub>	2 <sup>1</sup> / <sub>2</sub>	1 <sup>1</sup> / <sub>2</sub>	1 <sup>1</sup> / <sub>4</sub>
	CH-081										

### Notes

- **Fifth Terminal:** For field mounted fifth terminal order catalog number **5T8K2** for 100 amp unit. For 200 amp units, order **K5T**.
- **Connectors:** Extruded aluminum connectors are tin plated. Units are supplied with duplex neutral.
- **Bypass:** Horn type bypass is provided.
- **Underground Service:** A closing plate must be used when the **U7040-RL-TG-KK-RGE** is designated for underground service. Order closing plate catalog number **A7551** as extra.

Please consult serving utility for their requirements prior to ordering or installing, as specifications and approvals vary by utility, and may require local electrical inspector approval. All installations must be installed by a licensed electrician and must comply with all national and local codes, laws and regulations. Milbank reserves the right to make changes in specifications and features shown without notice or obligation.



# Single Position Socket

200 amp | 4 Terminal | 600 VAC



U9090-O

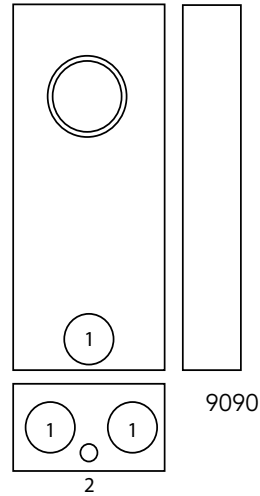

## 200 Amp | 4 Terminal | Ringless

Catalog Number	Utility Number	Service	Hub	Connectors CU/AL		Dimensions			Knock-outs	
				Line	Load	D"	W"	H"	1	2
U9090-O	M-301	UG	Blank	3/8"-16 Stud	#6-350 kcmil	4½	9	20¾	2½	½

## Notes

- **Fifth Terminal:** For the field mounted fifth terminal, order as extra catalog number **K5T**.
- **Connectors:** Line and neutral service is supplied with 3/8"-16 studs with hex head nuts and captive Belleville washers. One hole compression lugs per National Grid NY standards are to be supplied by the contractor. Loadside is supplied with 350 kcmil, lay-in type connectors.

# Lever Bypass Single Position

200 amp | 4 & 5 Terminal

**1 1**  
SINGLE POSITION  
SOCKETS



U2048-RL

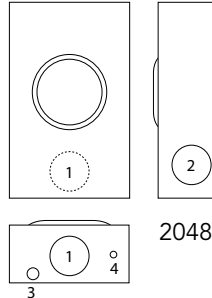

2048



U9551-RXL

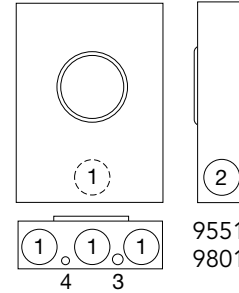

9551  
9801

## 200 Amp | 4 Terminal | Ringless | Lever Bypass | 1Ø3W

Catalog Number	Central Hudson Code#	Service	Hub	Connectors CU/AL		Dimensions			Knockouts			
				Line	Load	D"	W"	H"	1	2	3	4
U9801-R	CH-065	OH/UG	H.O.	#6-350 kcmil	#6-350 kcmil	4 $\frac{7}{8}$	13	19	3	2 $\frac{1}{2}$	$\frac{1}{2}$	$\frac{1}{2}$

### Notes

- **Fifth Terminal:** For field mounted fifth terminal, order as extra **K3866**.
- **Bypass:** Lever supplies clamping action on meter spades and also operates bypass device.
- **Connectors:** Units are supplied with extruded aluminum connectors, bonded neutral and a grounding stud.

## 200 Amp | 5 Terminal | Ringless | Lever Bypass | 1Ø3W or 3Ø3W

Catalog Number	Central Hudson Code#	Service	Hub	Connectors CU/AL		Dimensions			Knockouts			
				Line	Load	D"	W"	H"	1	2	3	4
U2048-RL	CH-116	OH	H.O.	#6-350 kcmil	#6-350 kcmil	4 $\frac{7}{8}$	10	18 $\frac{1}{2}$	3	2 $\frac{1}{2}$	3	$\frac{3}{4}$
U9551-RXL	CH-117	OH/UG	C.P.	#6-350 kcmil	#6-350 kcmil	4 $\frac{7}{8}$	13	19	3	2 $\frac{1}{2}$	$\frac{1}{2}$	$\frac{1}{4}$

## 200 Amp | 5 Terminal | Ringless | Lever Bypass | 1Ø3W or 3Ø3W

Catalog Number	RGE #	Service	Hub	Connectors CU/AL		Dimensions			Knockouts			
				Line	Load	D"	W"	H"	1	2	3	4
U9551-RL	R1121	OH/UG	H.O.	#6-350 kcmil	#6-350 kcmil	4 $\frac{7}{8}$	13	19	3	2 $\frac{1}{2}$	$\frac{1}{2}$	$\frac{1}{4}$

### Notes

- **Hub:** For proper hub selection see the hub suffix chart on the accessory page.
- **Bypass:** Lever supplies clamping action on meter spades and also operates bypass device.
- **Connectors:** Units are supplied with extruded aluminum connectors, bonded neutral and a grounding stud.
- **Fifth Terminal:** Fifth terminal is supplied in the 6 o'clock position. For factory installed fifth terminal in the 9 o'clock position add the suffix **-5T9** to the catalog number. Fifth terminal can be changed in the field from 6 o'clock to 9 o'clock position.

Please consult serving utility for their requirements prior to ordering or installing, as specifications and approvals vary by utility, and may require local electrical inspector approval. All installations must be installed by a licensed electrician and must comply with all national and local codes, laws and regulations. Milbank reserves the right to make changes in specifications and features shown without notice or obligation.



# Lever Bypass Single Position

200 amps | 5 & 7 Terminal | Lever Bypass | Ringless



U2046-O



U2047-O



U9701-R

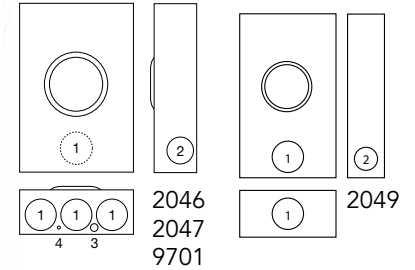

## 200 Amp | 5 Terminal | Ringless | 1Ø3W or 3Ø3W | Lever Bypass

Catalog Number	Service	Hub	Connectors CU/AL	Dimensions			Knockouts				
				D"	W"	H"	1	2	3	4	5
U2047-O	UG	Blank	#6-350 kcmil	4 <sup>7</sup> / <sub>8</sub>	13	19	3	2 <sup>1</sup> / <sub>2</sub>	3	1 <sup>1</sup> / <sub>4</sub>	1 <sup>1</sup> / <sub>4</sub> , 1 <sup>1</sup> / <sub>2</sub>

## 200 Amp | 7 Terminal | Ringless | 3Ø4W | Lever Bypass

Catalog Number	Service	Hub	Connectors CU/AL	Dimensions			Knockouts			
				D"	W"	H"	1	2	3	4
U2049-RL	OH	H.O.	#6-350 kcmil	4 <sup>7</sup> / <sub>8</sub>	10	18 <sup>1</sup> / <sub>2</sub>	3	2 <sup>1</sup> / <sub>2</sub>	—	—
U9701-R	OH/UG	H.O.	#6-350 kcmil	4 <sup>7</sup> / <sub>8</sub>	13	19	3	2 <sup>1</sup> / <sub>2</sub>	1 <sup>1</sup> / <sub>2</sub>	1 <sup>1</sup> / <sub>4</sub>
U2046-O	UG	Blank	#6-350 kcmil	4 <sup>7</sup> / <sub>8</sub>	13	19	3	2 <sup>1</sup> / <sub>2</sub>	3	1 <sup>1</sup> / <sub>4</sub>

### Notes

- **Hub:** For proper hub selection, see the hub suffix chart on the accessory page.
- **Lever Bypass:** Lever supplies clamping action on meter spades and also operates bypass device.
- **Connectors:** Units supplied with extruded aluminum connectors and bonded triplex ground.
- **Isolated Neutral:** For field installed isolated neutral, order kit number **K1047**.



Please consult serving utility for their requirements prior to ordering or installing, as specifications and approvals vary by utility, and may require local electrical inspector approval. All installations must be installed by a licensed electrician and must comply with all national and local codes, laws and regulations. Milbank reserves the right to make changes in specifications and features shown without notice or obligation.



# Lever Bypass Single Position

320 amp | 4 & 7 Terminal

**1 3**  
SINGLE POSITION  
WITH LEVER  
BYPASS



U2448-X-RGE

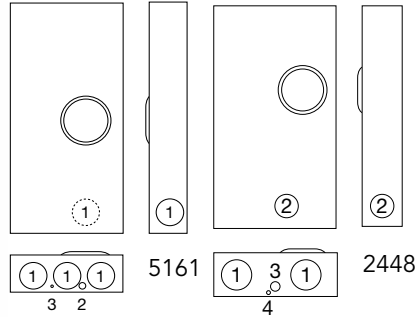

U4013-X

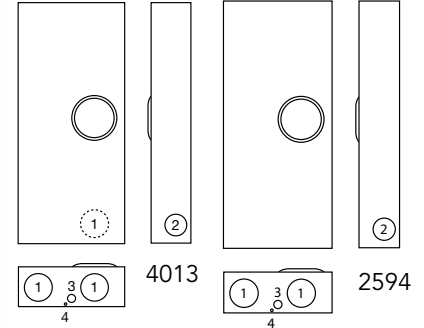

## 320 Amp | 4 Terminal | Side Wireway | Ringless | Lever Bypass | 1Ø3W

Catalog Number	Hub	Service	Connectors CU/AL	Dimensions			Knockouts			
			Line & Load	D"	W"	H"	1	2	3	4
U5161-X	C.P.	OH/UG	3/8"-16 Stud	4 <sup>7</sup> / <sub>8</sub>	15	31 <sup>1</sup> / <sub>2</sub>	3	1/2	1/4	-
U2448-X-RGE	C.P.	OH/UG	3/8"-16 Stud	6 <sup>1</sup> / <sub>2</sub>	17 <sup>3</sup> / <sub>4</sub>	34 <sup>1</sup> / <sub>8</sub>	4	3	1	1/4

## 320 Amp | 7 Terminal | Side Wireway | Ringless | Lever Bypass | 3Ø4W

Catalog Number	Hub	Service	Connectors CU/AL	Dimensions			Knockouts			
			Line & Load	D"	W"	H"	1	2	3	4
U4013-X	C.P.	OH/UG	3/8"-16 Stud	6 <sup>1</sup> / <sub>2</sub>	17 <sup>3</sup> / <sub>4</sub>	40 <sup>1</sup> / <sub>2</sub>	4	3	1	1/4
U2594-X	C.P.	OH/UG	3/8"-16 Stud	6 <sup>1</sup> / <sub>2</sub>	19	34 <sup>1</sup> / <sub>8</sub>	-	3	4	1

## Notes

- **Hubs:** For proper hub selection see the hub suffix chart on the accessory page.
- **Bypass:** Lever supplies clamping action on meter spades and also operates bypass device.
- **Connectors:** Stud type units supplied with 3/8"-16 hex head nuts with Belleville washers. For 1Ø connector kits, order as extra: **K1539** (350 kcmil) or **K1540** (600 kcmil). For twin lug connectors order as extra: **K1350** (350 kcmil). For 3Ø connector kits, order as extra: **K3082** (350 kcmil) or **K3441** (600 kcmil). For twin lug connectors, order as extra: **K3441** (#4-600 kcmil or (2) 1/0-250 kcmil). Separate kits are required for both line and load.
- **Fifth Terminal:** **U2448-X-RGE**—for factory installed fifth terminal in the 6 o'clock position add the suffix **-5T6** to the catalog number. For factory installed fifth terminal in the 9 o'clock position at the suffix **-5T9** to the catalog number. Catalog number **K3865** is available for field install.
- **National Grid NY Part Nos.:** **U5161-X**, **U2448-X-RGE** (M-116), **U4013-X**, **U2594-X** (M-117). One hole compression lugs per National Grid NY standards to be supplied by contractor.

Please consult serving utility for their requirements prior to ordering or installing, as specifications and approvals vary by utility, and may require local electrical inspector approval. All installations must be installed by a licensed electrician and must comply with all national and local codes, laws and regulations. Milbank reserves the right to make changes in specifications and features shown without notice or obligation.



# Meter Main with Load Center

100-200 amps | 4 Terminal | Ringless

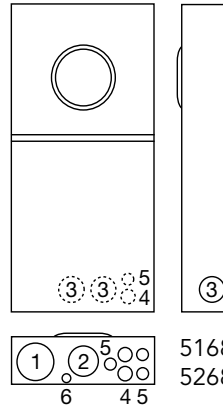

U5168-XTL-200-KK-PL

100 - 200 Amps | 4 Terminal | Meter Main | Overhead/Underground | Horn Bypass | 22K AIC | 1Ø3W

Catalog Number	Amp	No. of Circuits	Hub	Connectors	Dimensions			Knockouts					
				Line	D"	W"	H"	1	2	3	4	5	6
U5168-XTL-100-KK	100	8	C.P.	#6-350 kcmil	4½	14⅞	32	3	2½	2	1	¾	½
U5168-XTL-150-KK	150	8	C.P.	#6-350 kcmil	4½	14⅞	32	3	2½	2	1	¾	½
U5168-XTL-200-KK	200	8	C.P.	#6-350 kcmil	4½	14⅞	32	3	2½	2	1	¾	½
U5168-XTL-100-KK-PL**	100	8	C.P.	#6-350 kcmil	4½	14⅞	32	3	2½	2	1	¾	½
U5168-XTL-200-KK-PL**	200	8	C.P.	#6-350 kcmil	4½	14⅞	32	3	2½	2	1	¾	½
U5268-XTL-150-KK	150	20	C.P.	#6-350 kcmil	4½	14⅞	32	3	2½	2	1	¾	½
U5268-XTL-200-KK	200	20	C.P.	#6-350 kcmil	4½	14⅞	32	3	2½	2	1	¾	½

## Notes

- **Hub:** Supplied with (2) closing plates packed inside. Order hubs as a separate item. See accessory page for hub options.
- **Interior:** U5168 units have 8 circuit interior; U5268 units have 20 circuit interior.
- **Fifth Terminal:** Order K5T and field install in the 9 o'clock position only.
- **Breakers:** Rated 22K AIC with QNR2200H main installed.
- **Interlock Kit:** For generator auxiliary circuit breaker interlock, order K5815 for large QN with small frame Q; order K5820 for large frame QN with large frame QN.
- **\*Sub-feed Lugs:** #6-350 kcmil sub-feed lugs provided on 8 circuit interior. Not available on 20 circuit interior.

\*\*National Grid NY Service Area – for overhead and underground when underground service is a complete cable-in-conduit system.

### Plug-in Breaker Compatibility Chart

Amps	Cutler-Hammer (Westinghouse)	Siemens (ITE)	Siemens Murray Crouse-hinds	G.E.	SQ-D
125-200	HQP / BR / WBJ	QN	MD	THQ	–
≤ 100	QP / BR / HQP	QP	MP	THQ	Homeline

### Main Circuit Breaker Chart

Amperage	100	150	200
Catalog No.	Q2100H	QN2150RH	QN2200RH



Please consult serving utility for their requirements prior to ordering or installing, as specifications and approvals vary by utility, and may require local electrical inspector approval. All installations must be installed by a licensed electrician and must comply with all national and local codes, laws and regulations. Milbank reserves the right to make changes in specifications and features shown without notice or obligation.

# Multi-Position Sockets

200 Amp | 4 Terminal | Ringless | 300 VAC

**15**  
METER MAIN W/  
LOAD CENTER



U1252-R-KK-RGE

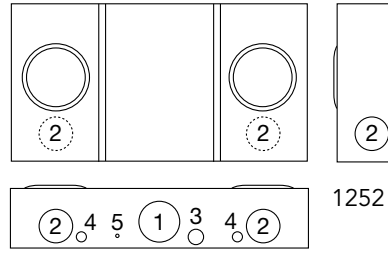

1252

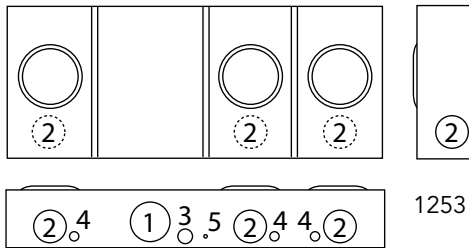

1253

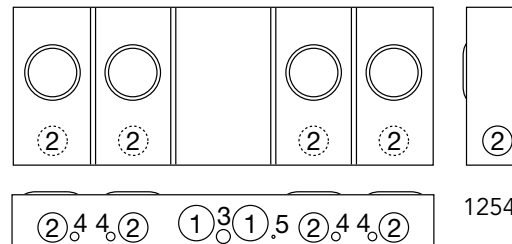

1254

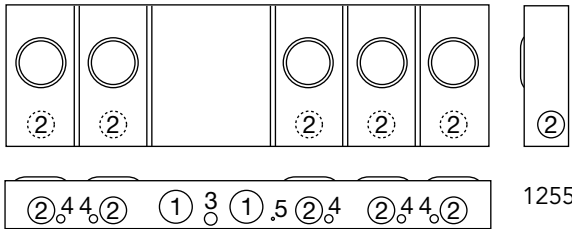

1255

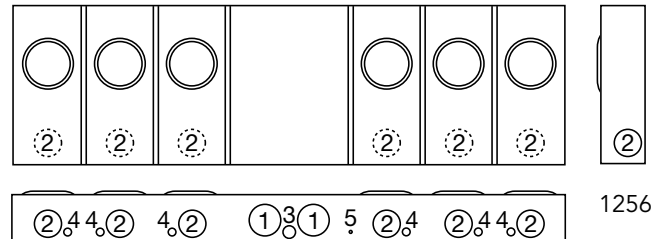

1256

200 Amp / Position | 4 Terminal | Ringless | Horn Bypass | 1Ø3W | OH/UG\*

Catalog Number	Hub	Connectors		Dimensions			Knockouts				
		Line	Load	D"	W"	H"	1	2	3	4	5
U1252-R-KK-RGE	H.O.	3/8" -16 Stud	#6-350 kcmil	5 1/8	26 1/2	14	3	2 1/2	1	1/2	1/4
U1253-R-KK-RGE	H.O.	3/8" -16 Stud	#6-350 kcmil	5 1/8	34 3/4	14	3	2 1/2	1	1/2	1/4
U1254-R-KK-EX-RGE	H.O.	3/8" -16 Stud	#6-350 kcmil	5 1/8	42 7/8	16	3	2 1/2	1	1/2	1/4
U1255-R-KK-EX-RGE	H.O.	3/8" -16 Stud	#6-350 kcmil	5 1/8	54 7/8	16	3	2 1/2	1	1/2	1/4
U1256-R-KK-EX-RGE	H.O.	3/8" -16 Stud	#6-350 kcmil	5 1/8	63 1/16	18	3	2 1/2	1	1/2	1/4

## Notes

- **Hub:** For proper hub selection refer to the hub suffix chart on the accessory page. Two hub openings are supplied and the extra opening is closed with a closing plate as standard on the 5 and 6 position units.
- **Fifth Terminal:** For factory installed fifth terminal in the 9 o'clock position, add the suffix **-5T**. For field mounted fifth terminal, order catalog number **K5T** (1 kit per meter position).
- **Connectors:** Extruded aluminum connectors are tin plated. See page 26 for connectors.
- **Bussing:** Bussing is 5/16" x 1" aluminum on the **U1252-1253**. On the **U1254-6** gangs the bussing is 3/8" x 1" aluminum. Refer to general engineering section of the Standard Catalog for information on ampacity of bussing.

Please consult serving utility for their requirements prior to ordering or installing, as specifications and approvals vary by utility, and may require local electrical inspector approval. All installations must be installed by a licensed electrician and must comply with all national and local codes, laws and regulations. Milbank reserves the right to make changes in specifications and features shown without notice or obligation.



# Multi-Position Meter Mains

125/200 amp | 4 Terminal | Ringless | 120/240 VAC



**U2854-X**

125 amp | Position

Catalog Number	Positions	Main Bus Rating	Connectors CU/AL
			Line
U2852-X	2	200 amp	*3/8"-16 STUD
U2853-X	3	200 amp	*3/8"-16 STUD



**U2866-X**

200 amp | Position

Catalog Number	Positions	Main Bus Rating	Connectors CU/AL
			Line
U2862-X	2	250 amp	*3/8"-16 STUD
U2863-X	3	300 amp	*3/8"-16 STUD

## VERTICAL

## RECTANGULAR

125 amp | Position

Catalog Number	Positions	Main Bus Rating	Connectors CU/AL
			Line
U2854-X	4	400 amp	*3/8"-16 STUD
U2855-X	5	400 amp	*3/8"-16 STUD
U2856-X	6	400 amp	*3/8"-16 STUD

200 amp | Position

Catalog Number	Positions	Main Bus Rating	Connectors CU/AL
			Line
U2864-X	4	400 amp	*3/8"-16 STUD
U2865-X	5	400 amp	*3/8"-16 STUD
U2866-X	6	400 amp	*3/8"-16 STUD

### Connector Kits\*

Size	Suffix	Kit Number	Compatible With	Wire Range
SINGLE	-K1	K1539	U2852-56 U2862-66	#6-350
	-K3	K1540	U2854-56 U2864-66	#4-600
TWIN	-K2	K1350	U2854-56 U2863-66	#6-350
	-K4	K1541	U2864-66	#2-600

**Connectors:** For line wire connector kits, order separately.

**Fifth Terminal:** For field mounted fifth terminal order catalog number **K2381**. Order one per meter position (9 o'clock position only).

**Breakers:** Units have provision for one double pole main per meter position. Breakers not included. Order as extra Milbank.

amp	Cutler-Hammer (Westinghouse)	Simens (ITE)	Siemens Murray/ Crouse-Hinds	G.E.	SQ-D
150-200	HQP/BR/WBJ	QNR	MD	THQ	
≤125	QP/BR/HQP	QP	MP	THQ	Homeline



Please consult serving utility for their requirements prior to ordering or installing, as specifications and approvals vary by utility, and may require local electrical inspector approval. All installations must be installed by a licensed electrician and must comply with all national and local codes, laws and regulations. Milbank reserves the right to make changes in specifications and features shown without notice or obligation.

# Multi-Position Meter Mains

100-200 amp | 4 Terminal | Ringless | 120/240 VAC | 22K AIC

**17**  
MULTI-POSITION  
METER MAIN



U5902-X-KK-BL

100-200 amp | 4 Terminal | Ringless

Catalog Number	Amp	No. of Pos.	Hub	Connectors	Dimensions			Knockouts				
				Line	D"	W'	H"	1	2	3	4	5
U5902-X-KK-BL**	125	2	C.P.	3/8" x 16 Stud	5 1/8	26 1/2	30	3	2 1/2	1	7/8	1/4
U5902-X-KK-BLG*	125	2	C.P.	3/8" x 16 Stud	5 1/8	26 1/2	30	3	2 1/2	1	7/8	1/4
U5903-X-KK-BL**	125	3	C.P.	3/8" x 16 Stud	5 1/8	34 1/16	30	3	3	2 1/2	1	—
U5903-X-KK-BLG*	125	3	C.P.	3/8" x 16 Stud	5 1/8	34 1/16	30	3	3	2 1/2	1	—
U5904-X-KK-BL**	125	4	C.P.	3/8" x 16 Stud	5 1/8	42 13/16	30	3	3	2 1/2	1	—
U5904-X-KK-BLG*	125	4	C.P.	3/8" x 16 Stud	5 1/8	42 13/16	30	3	3	2 1/2	1	—
U5905-X-KK-BL**	125	5	C.P.	3/8" x 16 Stud	5 1/8	51 1/16	30	3	3	2 1/2	1	—
U5905-X-KK-BLG*	125	5	C.P.	3/8" x 16 Stud	5 1/8	51 1/16	30	3	3	2 1/2	1	—
U5906-X-KK-BL**	125	6	C.P.	3/8" x 16 Stud	5 1/8	59 5/16	30	3	3	2 1/2	1	—
U5906-X-KK-BLG*	125	6	C.P.	3/8" x 16 Stud	5 1/8	59 5/16	30	3	3	2 1/2	1	—
U5882-X-KK-BL**	200	2	C.P.	3/8" x 16 Stud	5 1/8	59 5/16	30	3	2 1/2	1	7/8	1/4
U5882-X-KK-BLG*	200	2	C.P.	3/8" x 16 Stud	5 1/8	59 5/16	30	3	2 1/2	1	7/8	1/4
U5883-X-KK-BL**	200	3	C.P.	3/8" x 16 Stud	5 1/8	34 1/16	30	3	2 1/2	2 1/2	1	—
U5883-X-KK-BLG*	200	3	C.P.	3/8" x 16 Stud	5 1/8	34 1/16	30	3	2 1/2	2 1/2	1	—
U5884-X-KK-BL**	200	4	C.P.	3/8" x 16 Stud	5 1/8	42 13/16	30	3	2 1/2	2 1/2	1	—
U5884-X-KK-BLG*	200	4	C.P.	3/8" x 16 Stud	5 1/8	42 13/16	30	3	2 1/2	2 1/2	1	—
U5885-X-KK-BL**	200	5	C.P.	3/8" x 16 Stud	5 1/8	51 1/16	30	3	2 1/2	2 1/2	1	—
U5885-X-KK-BLG*	200	5	C.P.	3/8" x 16 Stud	5 1/8	51 1/16	30	3	2 1/2	2 1/2	1	—
U5886-X-KK-BL**	200	6	C.P.	3/8" x 16 Stud	5 1/8	59 5/16	30	3	2 1/2	2 1/2	1	—
U5886-X-KK-BLG*	200	6	C.P.	3/8" x 16 Stud	5 1/8	59 5/16	30	3	2 1/2	2 1/2	1	—

## Notes

- **Hub:** For proper hub selection refer to the hub suffix chart on the accessory page.
  - **Fifth Terminal:** For field mounted fifth terminal, order catalog number K5T for each meter position, 9 o'clock position.
  - **Connectors:** Extruded aluminum connectors are tin plated.
  - **Bypass:** Units provided with horn type bypass (suffix -KK).
- \*Barrel lock with guard provision (suffix -BLG).  
 \*\*Barrel lock (suffix -BL).

Please consult serving utility for their requirements prior to ordering or installing, as specifications and approvals vary by utility, and may require local electrical inspector approval. All installations must be installed by a licensed electrician and must comply with all national and local codes, laws and regulations. Milbank reserves the right to make changes in specifications and features shown without notice or obligation.



# U5902-06 & U5882-86 Series

*Knockout Information*

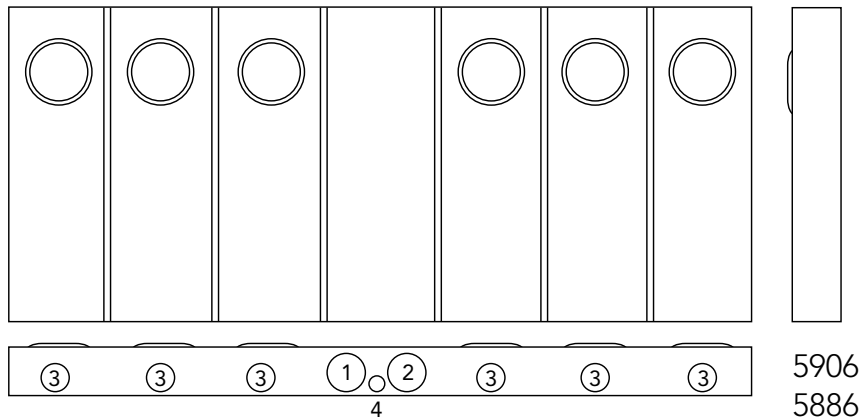
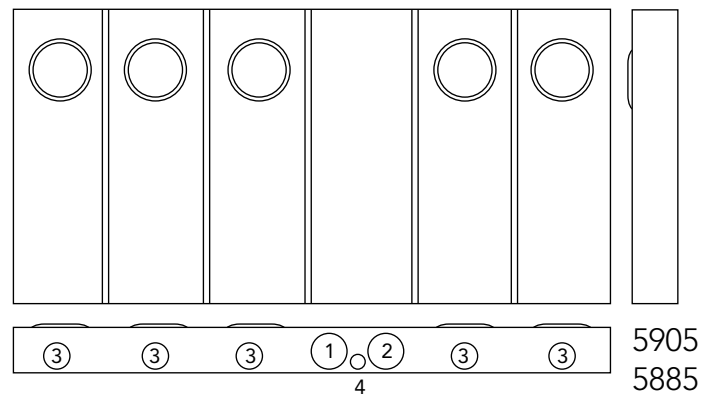
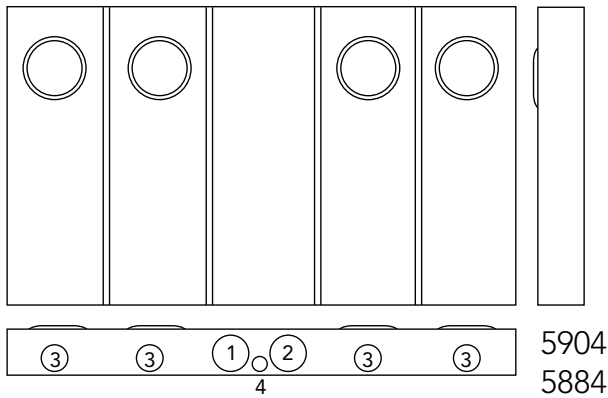
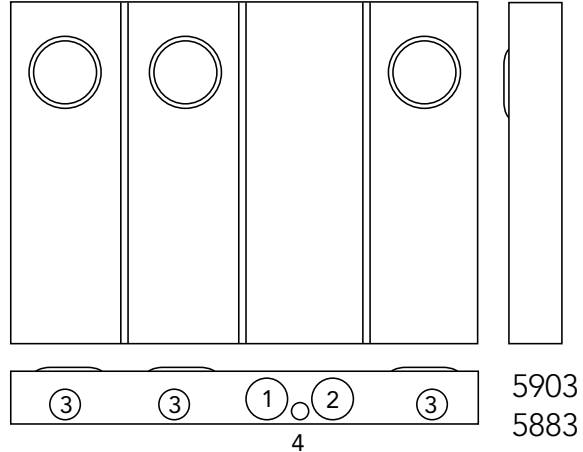
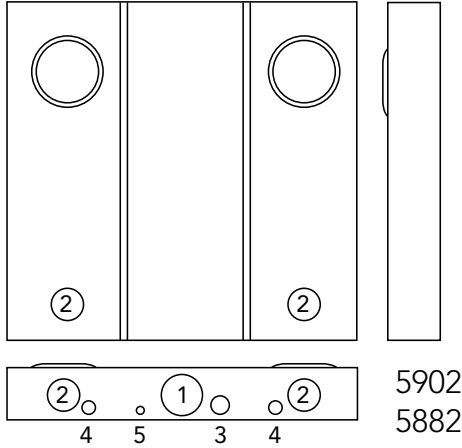

Please consult serving utility for their requirements prior to ordering or installing, as specifications and approvals vary by utility, and may require local electrical inspector approval. All installations must be installed by a licensed electrician and must comply with all national and local codes, laws and regulations. Milbank reserves the right to make changes in specifications and features shown without notice or obligation.

# Lever Bypass Multi-Position Sockets

200 Amp | 5 Terminal | Ringless | 600 VAC

**19**  
LEVER BYPASS  
MULTI-POSITION  
SOCKETS



U2872-XT

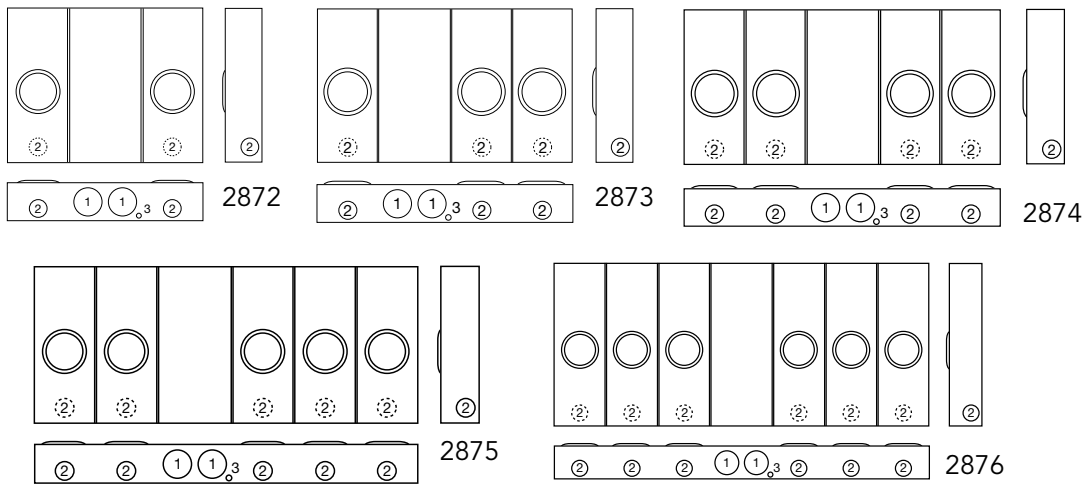

200 Amp | 5 Terminal | Ringless | Lever Bypass | 1Ø3W | OH/UG

Catalog Number	Positions	Hub	Connectors CU/AL		Dimensions			Knockouts		
			Line	Load	D"	W"	H"	1	2	3
U2872-XT	2	(2)C.P.	3/8"-16 Stud	#6-350 kcmil	6	32 <sup>1</sup> / <sub>8</sub>	25 <sup>1</sup> / <sub>4</sub>	4	2 <sup>1</sup> / <sub>2</sub>	1 <sup>1</sup> / <sub>4</sub> , 1 <sup>1</sup> / <sub>2</sub>
U2873-XT	3	(2)C.P.	3/8"-16 Stud	#6-350 kcmil	6	42 <sup>3</sup> / <sub>16</sub>	25 <sup>1</sup> / <sub>4</sub>	4	2 <sup>1</sup> / <sub>2</sub>	1 <sup>1</sup> / <sub>4</sub> , 1 <sup>1</sup> / <sub>2</sub>
U2874-XT	4	(2)C.P.	3/8"-16 Stud	#6-350 kcmil	6	52 <sup>1</sup> / <sub>4</sub>	25 <sup>1</sup> / <sub>4</sub>	4	2 <sup>1</sup> / <sub>2</sub>	1 <sup>1</sup> / <sub>4</sub> , 1 <sup>1</sup> / <sub>2</sub>
U2875-XT	5	(2)C.P.	3/8"-16 Stud	#6-350 kcmil	6	62 <sup>5</sup> / <sub>16</sub>	25 <sup>1</sup> / <sub>4</sub>	4	2 <sup>1</sup> / <sub>2</sub>	1 <sup>1</sup> / <sub>4</sub> , 1 <sup>1</sup> / <sub>2</sub>
U2876-XT	6	(2)C.P.	3/8"-16 Stud	#6-350 kcmil	6	72 <sup>3</sup> / <sub>8</sub>	31 <sup>1</sup> / <sub>4</sub>	4	2 <sup>1</sup> / <sub>2</sub>	1 <sup>1</sup> / <sub>4</sub> , 1 <sup>1</sup> / <sub>2</sub>

## Notes

- **Hubs:** Units supplied with two closing plates. To order hubs as extra refer to the hub suffix chart on the accessory page.
- **Bypass:** Lever supplies clamping action on meter spades and also operates bypass device.
- **\*Connector Kits:** Line wire sections supplied with studs. For connector kits for the **U2872-6** units, order as extra: **K1539** (350 kcmil), **K1350** (twin 350 kcmil), **K1540** (600 kcmil) or **K1541** (twin 600 kcmil). For **U2732-6** units, order **K3082** (350 kcmil), **K3442** (twin 350 kcmil), **K3441** (600 kcmil) or **K3083** (twin 600 kcmil). Line connectors can be reversed to change from "OH" to "UG" service.
- **Bussing:** Bussing is 3/8" x 1" aluminum. Refer to the conduit & ampacity information page for information on ampacity of bussing.

Please consult serving utility for their requirements prior to ordering or installing, as specifications and approvals vary by utility, and may require local electrical inspector approval. All installations must be installed by a licensed electrician and must comply with all national and local codes, laws and regulations. Milbank reserves the right to make changes in specifications and features shown without notice or obligation.



# Lever Bypass Multi-Position Sockets

200 Amp | 7 Terminal | Ringless | 600 VAC



U2732-XT

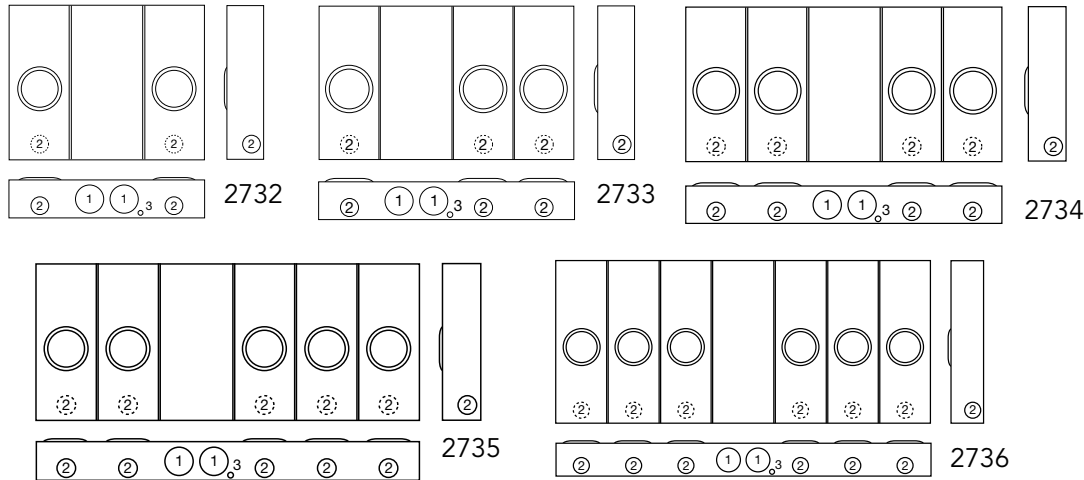

200 Amp | 7 Terminal | Ringless | Lever Bypass | 3Ø4W | OH/UG

Catalog Number	No. of Pos.	Hub	Connectors CU/AL		Dimensions			Knockouts				
			Line	Load	D"	W"	H"	1	2	3	4	5
U2732-XT	2	(2)C.P.	3/8"-16 Stud	#6-350 kcmil	6	32 <sup>1</sup> / <sub>8</sub>	25 <sup>1</sup> / <sub>4</sub>	2 <sup>1</sup> / <sub>2</sub>	2 <sup>1</sup> / <sub>2</sub>	4	2 <sup>1</sup> / <sub>2</sub>	1/4, 1/2
U2733-XT	3	(2)C.P.	3/8"-16 Stud	#6-350 kcmil	6	42 <sup>3</sup> / <sub>16</sub>	25 <sup>1</sup> / <sub>4</sub>	2 <sup>1</sup> / <sub>2</sub>	2 <sup>1</sup> / <sub>2</sub>	4	2 <sup>1</sup> / <sub>2</sub>	1/4, 1/2
U2734-XT	4	(2)C.P.	3/8"-16 Stud	#6-350 kcmil	6	52 <sup>1</sup> / <sub>4</sub>	25 <sup>1</sup> / <sub>4</sub>	2 <sup>1</sup> / <sub>2</sub>	2 <sup>1</sup> / <sub>2</sub>	4	2 <sup>1</sup> / <sub>2</sub>	1/4, 1/2
U2735-XT	5	(2)C.P.	3/8"-16 Stud	#6-350 kcmil	6	62 <sup>5</sup> / <sub>16</sub>	25 <sup>1</sup> / <sub>4</sub>	2 <sup>1</sup> / <sub>2</sub>	2 <sup>1</sup> / <sub>2</sub>	4	2 <sup>1</sup> / <sub>2</sub>	1/4, 1/2
U2736-XT	6	(2)C.P.	3/8"-16 Stud	#6-350 kcmil	6	72 <sup>3</sup> / <sub>8</sub>	31 <sup>1</sup> / <sub>4</sub>	2 <sup>1</sup> / <sub>2</sub>	2 <sup>1</sup> / <sub>2</sub>	4	2 <sup>1</sup> / <sub>2</sub>	1/4, 1/2

## Notes

- **Hubs:** Units supplied with two closing plates. To order hubs as extra refer to the hub suffix chart on the accessory page.
- **Bypass:** Lever supplies clamping action on meter spades and also operates bypass device.
- **\*Connector Kits:** Line wire sections supplied with studs. For connector kits for the **U2872-6** units, order as extra: **K1539** (350 kcmil), **K1350** (twin 350 kcmil), **K1540** (600 kcmil) or **K1541** (twin 600 kcmil). For **U2732-6** units, order **K3082** (350 kcmil), **K3442** (twin 350 kcmil), **K3441** (600 kcmil) or **K3083** (twin 600 kcmil). Line connectors can be reversed to change from "OH" to "UG" service.
- **Bussing:** Bussing is 3/8" x 1" aluminum. Refer to the conduit & ampacity information page for information on ampacity of bussing.



Please consult serving utility for their requirements prior to ordering or installing, as specifications and approvals vary by utility, and may require local electrical inspector approval. All installations must be installed by a licensed electrician and must comply with all national and local codes, laws and regulations. Milbank reserves the right to make changes in specifications and features shown without notice or obligation.



# Service Pedestals

200 Amp | 4 Terminal | 120/240 VAC



U4093N-O

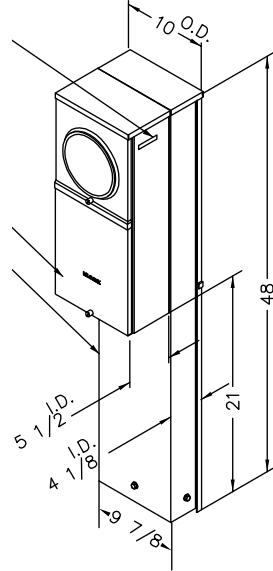

## Main Breakers (Series Wired)

Catalog Number	Amps
UQFP-M-100	100
UQFP-M-125	125
UQFP-M-150	150
UQFP-M-200	200

## Branch Breaker

Amps	Milbank	Cutler-Hammer/ Westinghouse	Siemens/ ITE	Murray / Crouse-Hinds	G.E.	SQ-D
125 or Less	Q	Quicklag P BR / HQP	QP	MP-T	THQ	Home Line

## 200 Amp | 4 Terminal | Ringless

Catalog Number	Meter Positions	Mounting Type	Line Connectors CU/AL	Circuit Prov.	LBS.	Description
U4093N-O	Single	Post	3/8" - 16 Stud	6	100#	Provisions for Main with Branch or Parallel Breakers

## Notes

- **Application:** Pedestals are suitable for use as mobile home service equipment. These units are in stock, wired as parallel, without breaker. They have provisions for one double, and two single circuit branch breakers in addition to the main. Order breakers separately (see chart above.) Quadplex style breakers may be used in accordance to the NEC. For main style breakers (series wired), order **UQFP-M**, plus kit **K4714** (includes wire assemblies, hardware, instructions and label).
- **Required Accessories:** Pedestal must be used with Direct Burial Kit **K3236 / K3188** (22 lbs.) which is furnished as part of unit and is included in price. Pad Mount Sleeve **K3237** (6 lbs.) can be ordered as an extra option, and is required if unit is to be pad-mounted.
- **22K AIC—Consult Factory**
- **Fifth Terminal:** For field installed fifth terminal, use **K5T** in the 9 o'clock position.

Please consult serving utility for their requirements prior to ordering or installing, as specifications and approvals vary by utility, and may require local electrical inspector approval. All installations must be installed by a licensed electrician and must comply with all national and local codes, laws and regulations. Milbank reserves the right to make changes in specifications and features shown without notice or obligation.





U5136-O-200S

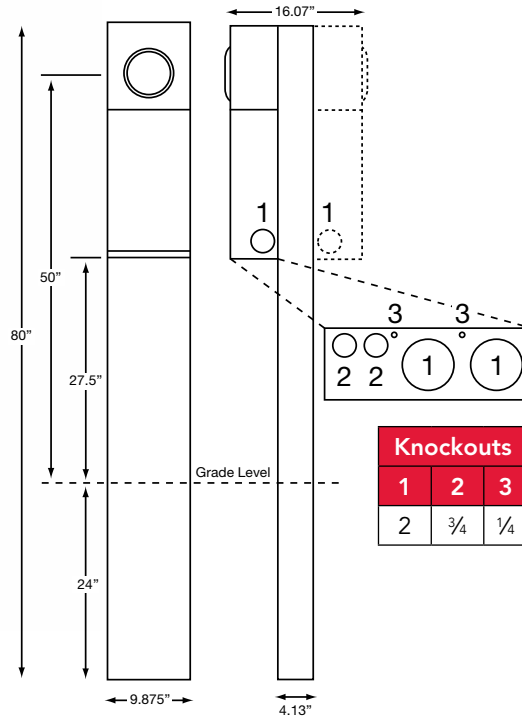

## Specifications

- UL Listed
- 200 amp maximum, 120/240 V, 1Ø3W
- Ringless type meter socket with stainless steel latch
- Short circuit withstand rating 10 KAIC, 22 KAIC available consult factory
- Type 3R construction for durable outdoor use
- ASA 61 grey polyester powder coat finish
- Wire terminations accept copper or aluminum conductors
- Line & Neutral: (2) #6-350 kcmil per phase, Line Ground: (4) #14-1/0
- Load (CB): 2/0 to 300 kcmil per pole
- Load neutral: (1) #6-350 kcmil
- Load ground: (2) #14-1/0, (4) #14/6
- Commercial grade, plug-in main circuit breaker. Available in 100, 125, 150 & 200 AMP. Type UQFP-H-M.
- 4 circuit plated copper interior accepts (2) 2-pole or (4) 1-pole standard plug-in type circuit breakers. Branch circuit rated to 125 amp max. Acceptable manufacturers: Milbank, Cutler-Hammer, GE or Siemens
- Twin line termination lugs #6-350 CU/AL per phase for looping.

# Service Pedestals

## U5136 & U5137 Series | Ringless

### 100 - 200 Amp | Meter Main w/ Load Center Pedestals | Ringless

Catalog Number	Powerheads	Mounting	Amp	Main Breaker	Interior	Dimensions			Knockouts		
						D"	W"	H"	1	2	3
U5136-O-100S	Single	Direct Burial	100	UQFPH-M-100	4 circuit	10 $\frac{1}{4}$	10	80	2	1 $\frac{1}{2}$ , 3 $\frac{3}{4}$	1 $\frac{1}{4}$
U5136-O-200S	Single	Direct Burial	200	UQFPH-M-200	4 circuit	10 $\frac{1}{4}$	10	80	2	1 $\frac{1}{2}$ , 3 $\frac{3}{4}$	1 $\frac{1}{4}$
U5136-O	Single	Direct Burial	—	Provision for UQFPH-M series	4 circuit	10 $\frac{1}{4}$	10	80	2	1 $\frac{1}{2}$ , 3 $\frac{3}{4}$	1 $\frac{1}{4}$
U5137-O-100S	Double	Direct Burial	100	(2) UQFPH-M-100	4 circuit	16 $\frac{1}{16}$	10	80	2	1 $\frac{1}{2}$ , 3 $\frac{3}{4}$	1 $\frac{1}{4}$
U5137-O-200S	Double	Direct Burial	200	(2) UQFPH-M-200	4 circuit	16 $\frac{1}{16}$	10	80	2	1 $\frac{1}{2}$ , 3 $\frac{3}{4}$	1 $\frac{1}{4}$
U5137-O	Double	Direct Burial	—	Provision for (2) UQFPH-M series	4 circuit	16 $\frac{1}{16}$	10	80	2	1 $\frac{1}{2}$ , 3 $\frac{3}{4}$	1 $\frac{1}{4}$
U5138-O-200S	Single	Pad Mount	200	UQFPH-M-200	4 circuit	10 $\frac{1}{4}$	10	56	2	1 $\frac{1}{2}$ , 3 $\frac{3}{4}$	1 $\frac{1}{4}$
U5138-O	Single	Pad Mount	—	Provision for UQFPH-M series	4 circuit	10 $\frac{1}{4}$	10	56	2	1 $\frac{1}{2}$ , 3 $\frac{3}{4}$	1 $\frac{1}{4}$
U5139-O	Double	Pad Mount	—	Provision for UQFPH-M series	4 circuit	16 $\frac{1}{16}$	10	56	2	1 $\frac{1}{2}$ , 3 $\frac{3}{4}$	1 $\frac{1}{4}$

### Accessories

Catalog Number	Description
K5415	Stabilizer foot with hardware
K5035	Pad mount kit with hardware for <b>U5138</b>
K5T	5th terminal for 208y/120V 3-wire service
K5193	Bus kit to convert series-wired main breaker to parallel
K5194	4 Wire kit to convert parallel-wired main breaker to series
K3450	Telephone/CATV mounting bracket (mounts left or right)
K5039	Penta bolt utility cover

### Notes

- Parallel to Series Conversion: For field converting from parallel wired to series wired order K5194.
- Fifth Terminal: For field installed fifth terminal, order K5T.
- Stabilizer Foot: For field installed stabilizer foot, order K5415.
- Penta Bolt Locking: For field installed pedestal fronts penta bolt locking, order K5039.
- Pad Mount Units: Pad mount pedestals require K5035 pad mount kit. Order separately.
- Receptacles and circuit breakers can be found in the accessories section.

Please consult serving utility for their requirements prior to ordering or installing, as specifications and approvals vary by utility, and may require local electrical inspector approval. All installations must be installed by a licensed electrician and must comply with all national and local codes, laws and regulations. Milbank reserves the right to make changes in specifications and features shown without notice or obligation.



# Lever Bypass CT Rated Sockets

80 Amps | Ringless | 600 VAC



U4493-XL

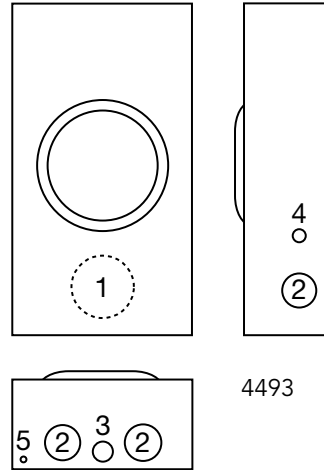

**80 Amp Transformer Rated | 13 Terminal | Lever Bypass | Ringless**  
Central Hudson Approved

Catalog Number	Service	Hub	Connectors CU	Dimensions			Knockouts				
				D"	W"	H"	1	2	3	4	5
U4493-XL	OH/UG	C.P.	#14 - #4 MAX	4 $\frac{5}{8}$	10	18 $\frac{1}{2}$	3	1 $\frac{1}{2}$	$\frac{3}{4}$	$\frac{3}{4}$	$\frac{1}{4}$

## Notes

- **Hubs:** For proper hub selection see the hub suffix chart.
- **Bypass:** Lever operates current bypass device and also supplies clamping action on current meter spades.
- **Connector:** Units are supplied with mechanical type connectors (#4 max.)



Please consult serving utility for their requirements prior to ordering or installing, as specifications and approvals vary by utility, and may require local electrical inspector approval. All installations must be installed by a licensed electrician and must comply with all national and local codes, laws and regulations. Milbank reserves the right to make changes in specifications and features shown without notice or obligation.

# Current Transformer Enclosure

400-1200 Amps

**25**  
CURRENT  
TRANSFORMER  
ENCLOSURE



S1855-O

## Current Transformer Enclosure—Not UL Listed

Central Hudson Approved Only

Catalog Number	Amperage Rating	Hud	Gauge Steel	Connectors CU/AL	Dimensions		
					D"	W"	H"
S1855-O	400-800	Blank	12	#3-750 kcmil Per Phase	12	36	36
S1856-O-HUD	800-1200	Blank	12	#5-750 kcmil Per Phase	12	48	48

Please consult serving utility for their requirements prior to ordering or installing, as specifications and approvals vary by utility, and may require local electrical inspector approval. All installations must be installed by a licensed electrician and must comply with all national and local codes, laws and regulations. Milbank reserves the right to make changes in specifications and features shown without notice or obligation.





36363612-CT3R

## Industry Standards

- NEMA —Type 3R
- UL 50—Type 3R
- CUL—Type 3R (Equivalent to CSA)

## Application

- Designed for use as a current transformer cabinet or panel enclosure
- For outdoor use to provide protection against rain, sleet, and snow, or indoor use to protect against dripping water

## Construction

- Enclosure and cover manufactured from 16 or 14 gauge G90U galvanized steel, panels are 10 or 12 gauge, painted white
- The doors are overlapping with no center post
- Continuous door hinge with stainless steel hinge pins
- Three point pad-lockable handle
- Panel mounting studs provided for optional back panels
- Drip shield top and seam free sides, front and back

## Finish

- ANSI 61 gray polyester powder coating over phosphatized G90 galvanized steel.

## Accessories

- Panel - See option P Series on Panel-Steel P Series panels sold separate, add 'W' to the end of panel part number for wood instead of painted steel.
- Touch up paint - See accessories

Catalog Number	Product Family	UPC Number 7-84572-	Weight	Dimensions			P Series Panel Catalog No.	Panel Size
				D"	W"	H"		
363010-CT3R	CN3R	18823	99	36	30	10	<b>A-36P30</b>	36 x 30
363016-CT3R	CN3R	16181	121.5	36	30	16	<b>A-36P30</b>	36 x 30
363610-CT3R	CN3R	17368	113	36	36	10	<b>A-36P36</b>	36 x 36
363612-CT3R	CN3R	16185	118	36	36	12	<b>A-36P36</b>	36 x 36
363616-CT3R	CN3R	18819	139	36	36	16	<b>A-36P36</b>	36 x 36
483616-CT3R	CN3R	25707	163	48	36	16	<b>A-48P36</b>	48 x 36
484812-CT3R	CN3R	16184	210	48	48	12	<b>A-DD4848</b>	48 x 48
606013-CT3R	CN3R	18252	274	60	60	13	<b>A-60P60</b>	60 x 60



Please consult serving utility for their requirements prior to ordering or installing, as specifications and approvals vary by utility, and may require local electrical inspector approval. All installations must be installed by a licensed electrician and must comply with all national and local codes, laws and regulations. Milbank reserves the right to make changes in specifications and features shown without notice or obligation.

# Current Transformer Cabinet

Type 3R

**27**  
CURRENT  
TRANSFORMER  
CABINET



363610-TC3R-H-BP-SP

**CURRENT TRANSFORMER ENCLOSURE**  
NATIONAL GRID APPROVED ONLY

120/240 Volt Single Phase | 208Y/120 Volt & 480/277 Volt Three-Phase

Catalog Number	Amperage Rating	Hub	Gauge Steel	Steel Back Panel	Dimensions		
					D"	W"	H"
363610-TC3R-H-BP-SP	400-800	Blank	16	Installed	10	36	36

Please consult serving utility for their requirements prior to ordering or installing, as specifications and approvals vary by utility, and may require local electrical inspector approval. All installations must be installed by a licensed electrician and must comply with all national and local codes, laws and regulations. Milbank reserves the right to make changes in specifications and features shown without notice or obligation.



# Commercial Pedestals

*Attractive | Easy to install | Secure | Cost-effective*

**Milbank Commercial Pedestals** are pad-mounted, weather resistant electrical enclosures consisting of a utility pull section with optional meter socket, and a customer section containing distribution and control equipment. Milbank Commercial Pedestals are an attractive, secure, easy to install and cost-effective solution when underground remote site power distribution and control equipment is required, replacing unsightly and inefficient strut and backboard structures.



Strut and backboard



Commercial pedestal

## UL Listed as Industrial Control Equipment (File E113855)

### Standard Features

- Type 3R rain resistant, vandal-resistant cabinet of polyurethane powder-coated steel (aluminum or stainless steel also available)
- UL listed as enclosed industrial control equipment (UL508)
- Isolated lockable and sealable utility metering and lug landing sections
- Lockable customer section for distribution and control equipment with internal deadfront
- Print pocket inside customer section door contains wiring schematics and installation instructions
- Most load centers are UL listed for use with various manufacturers' circuit breakers
- All stainless steel external hardware (screws, bolts, hinges, handles, hasps and sealing screws)

### Note

All meter form and bypass options available to meet utility requirements.

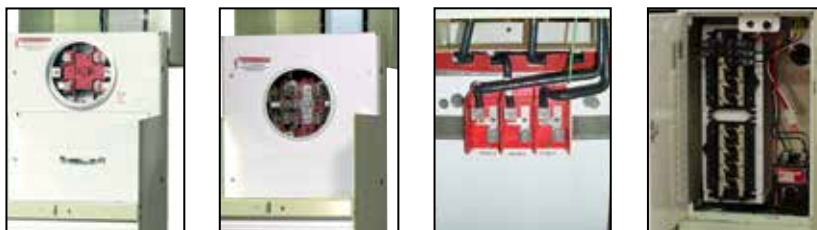

Please consult serving utility for their requirements prior to ordering or installing, as specifications and approvals vary by utility, and may require local electrical inspector approval. All installations must be installed by a licensed electrician and must comply with all national and local codes, laws and regulations. Milbank reserves the right to make changes in specifications and features shown without notice or obligation.



# Commercial Pedestals

Attractive | Easy to install | Secure | Cost-effective

**29**  
COMMERCIAL  
PEDESTALS



## Applications

These units are ideal for controlling and metering:

- Traffic signals
- Street lighting
- Power distribution for EV charging stations
- Irrigation and sprinkler systems
- Cell towers and telephone vaults
- Pump stations
- Temporary power for fairgrounds, swap meets, outdoor markets, portable offices, holiday lights, etc.
- Outdoor lighting for athletic fields, tennis and basketball courts, parking lots, landscaping and subdivision entrances, etc.

## Available Factory-Installed Options

- Meter sockets: ring type or ringless, up to 400 amp
- Main and branch breakers or T fuses
- Distribution: copper load centers and panel boards
- Clocks, timers and relays
- Photoelectric cells and controls
- Power receptacles: pin and sleeve, twist lock or straight blade
- Contactors: definite purpose, electrical or mechanically held, IEC and mercury types
- Surge protection and lightning arrestors
- Reserve inlet generator receptacle with interlocked circuit breakers
- Motor starters and relays
- Push button controls
- Thermostat controls, fans and heating strips
- Power blocks and terminal blocks
- Steel, aluminum and plywood backboards
- Transformers
- Interlock devices for circuit breakers
- Available in steel, aluminum (raw painted or anodized) or stainless steel construction with powder-coated finish available in eight standard colors or special-ordered RAL colors
- Available for applications up to 400 amp, 120V, 208V, 240V, 277V, 480V - 1Ø or 3Ø

## Accessories



**K3865**  
Fifth terminal kit for use with ringless meter sockets

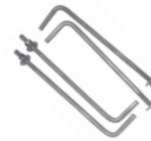

**CP-ABK5/8**  
Anchor bolt kit (includes four 5/8 - 13 x 18" anchor bolts)



**105J**  
Fifth terminal kit for use with ring type meter sockets



**CP-TC7D**  
7-day time clock kit  
**CP-TC24H**  
24-hour time clock kit  
**CP-TCWIRE**  
Male 4-pin connector and wiring harness for use with time clocks other than above

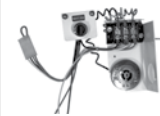

**CP-PE-HOA-3POS**  
HOA switch for field installation



**CP-16PDMNT-CALT**  
16" pedestal mounting base  
**CP-24PDMNT-CALT**  
24" pedestal mounting base (includes mounting hardware)

Please consult serving utility for their requirements prior to ordering or installing, as specifications and approvals vary by utility, and may require local electrical inspector approval. All installations must be installed by a licensed electrician and must comply with all national and local codes, laws and regulations. Milbank reserves the right to make changes in specifications and features shown without notice or obligation.



### CP3B "ML" Series

Main Load Center Series

1Ø3 wire 120/240V or 208Y/120V

Application: remote site service for multiple loads

The **Milbank Main Load Center Commercial Pedestals** are designed to handle the vast majority of all requirements in a standard, stocked configuration.

- All units feature a load center with a plug-on, back-fed main breaker.
- Load center has 16 positions for the 100 amp pedestals and 24 circuits for the 200 amp pedestals.
- Both sizes include sub-feed lugs to allow feeding an external panel.

If your application requires turning loads on based on "dusk-to-dawn" requirements, be sure to see the Milbank Switched Load Center Commercial Pedestal products on the following page.

#### Features

These units include everything required for remote site service:

- NEMA 3R construction.
- Expandable: load centers allow for future expansion without costly modifications.
- All units feature 200 amp meter socket with optional field installable fifth terminal kit available.
- 22K ampere interrupting capacity (AIC) standard.
- Optional mounting base can be embedded in concrete for fast, easy installation.
- Separate sealable and lockable utility termination section.
- Separate sealable and lockable metering section.
- Separate sealable and lockable customer section with a load center for "always on" loads that include a main circuit breaker, 20 (125 or 200 amp model) or 14 (100 amp model) blank breaker spaces and a circuit directory to document configuration.



**CP3B11115A22**

#### Typical Applications

Remote site service for multiple loads.

Stocked Pedestals	Optional Fifth Terminal Kit	Main CB		Load Center Circuits	Meter Socket Type
		Amp	Spaces		
<b>CP3B51115A22</b>	K3865	100	1,2	16	Ringless socket with lever bypass
<b>CP3B52119A22</b>	K3865	200	1,2,3,4	24	Ringless socket with lever bypass

#### Notes

- Chart shows standard, stocked items. Other options and features are available. Contact factory for options, details and availability.



Please consult serving utility for their requirements prior to ordering or installing, as specifications and approvals vary by utility, and may require local electrical inspector approval. All installations must be installed by a licensed electrician and must comply with all national and local codes, laws and regulations. Milbank reserves the right to make changes in specifications and features shown without notice or obligation.

# Commercial Pedestals

## Switched Load Center Series

### CP3B "SL" Series

Switched Load Center Series  
1Ø3 wire 120/240V or 208Y/120V

Milbank's Switched Load Center Commercial Pedestals are designed not only to provide power for various loads, but also to switch specific loads on and off under certain conditions. A photoelectric cell is used for these controlled loads, and an optional time clock is also available.

#### Features

These units include everything required for remote site service:

- NEMA 3R construction.
- Expandable: load centers allow for future expansion without costly modifications.
- All units feature 200 amp meter socket with optional field installable fifth terminal kit available.
- 22K ampere interrupting capacity (AIC) standard.
- Optional mounting base can be embedded in concrete for fast, easy installation.
- Separate sealable and lockable utility termination section.
- Separate sealable and lockable metering section.
- Separate sealable and lockable customer section with a control circuit including PE receptacle, Lexan® window, glare shield, Hand-Off-Auto (HOA) switch, contractor controlling a 16-circuit load center for controlled loads, a pre-mounted DIN rail and pre-wired connector to add an optional "plug-and-play" time clock kit for PE on and TC off operation and a circuit directory to document configuration.
- A load center for "always on" loads that includes a main circuit breaker, a control power circuit breaker, a switched load center main breaker, nine (125 or 200 amp model) or 11 (100 amp model) blank breaker spaces and a circuit directory to document configuration.



CP3B11110A22SL1

#### Typical Applications

Traffic signals, parking lots, highways & athletic field lighting

Stocked Pedestals	Optional Fifth Terminal Kit	Main CB		Contactor Amperage	Meter Socket Type
		Amp	Spaces		
CP3B51110A22SL1	K3865	100	1,3	60	Ringless socket with lever bypass
CP3B52110A22SL1	K3865	200	1,2,3,4	100	Ringless socket with lever bypass

#### Notes

- Chart shows standard, stocked items. Other options and features are available. Contact factory for options, details and availability.

Please consult serving utility for their requirements prior to ordering or installing, as specifications and approvals vary by utility, and may require local electrical inspector approval. All installations must be installed by a licensed electrician and must comply with all national and local codes, laws and regulations. Milbank reserves the right to make changes in specifications and features shown without notice or obligation.





**CP3B1411JB22**

### Typical Applications

Remote site service for residential and commercial job sites.

**Milbank's 400 Amp Commercial Pedestal** is designed to provide a weather and vandal resistant metered enclosure for various loads and distribution. Each pedestal has been designed to handle a wide range of applications using standard, stocked configurations.

- Choice of a single main breaker or twin service disconnect breakers gives flexibility to the pedestal design.
- Optional distribution with feed-thru lugs below the service disconnect breakers allows the pedestal to handle numerous applications.
- Typical applications include remote homes where the metering is best located at the curb side or other remote area. The pedestal can also provide power to secondary residence, on-site business, workshop, irrigation, lighting, security or other secondary load.
- Available in custom colors to match home or landscaping.

### Features

These units include everything required for remote service:

- Type 3R construction
- Main circuit breaker or dual service disconnects
- Expandable: load center units allow for future expansion without costly modifications
- Optional mounting base can be embedded in concrete for fast, easy installation
- Separate sealable and lockable utility termination section with lug termination
- Separate sealable and lockable metering section
- A separate sealable and lockable customer section with a circuit directory and a print pocket to hold all documentation
- Meter socket options include ring type with bypass studs, ringless with heavy duty lever bypass, or K-Type bolt-on

Standard Pedestals	Optional fifth Terminal Kit	Main CB	Load Center Circuits	Meter Socket Type
<b>CP3B54120B22</b>	K3865	2-200 amp	(2) 12 circuit	Ringless with lever bypass
<b>CP3B5411JB22</b>	K3865	320 amp (400 max)	0	Ringless with lever bypass

### Notes

- Chart shows standard, stocked items. Other options and features are available. Contact factory for options, details and availability.
- Stud utility landing is standard. Lug kits are available from factory.
- Units with load centers have (2) #6-250 sub-feed lugs on each load center. (Each load center is 200 amp rated and UL Listed with: Siemens, General Electric and Cutler-Hammer plug-in style circuit breakers.)



Please consult serving utility for their requirements prior to ordering or installing, as specifications and approvals vary by utility, and may require local electrical inspector approval. All installations must be installed by a licensed electrician and must comply with all national and local codes, laws and regulations. Milbank reserves the right to make changes in specifications and features shown without notice or obligation.

# Commercial Pedestals

## Irrigation Control Series



CP3B0281UMWIR04

Milbank's "IR" Series Irrigation Pedestals install quickly and simply – often in less than an hour with a single technician – a fraction of the time typically needed for strut farm and other installation set ups. Additionally, the pedestal comes pre-wired, so the technician simply drops in the pre-drilled concrete box pad, fastens the pedestal and runs the wires. Prewired landing lugs are provided in a separate utility side so that there is no more need to wrestle with hard-to-bend wires. Simply run the utility wire up and land on the lugs. With both the motor starter and disconnect in the same enclosure, all the controls are housed in a safe, lockable pedestal that protects against vandalism and energy theft.

### Features

- 3Ø4W, 480Y/277 volt
- One technician can install in under an hour with use of Milbank's pre-drilled box pad
- All units are UL listed and service entrance rated
- Fused disconnect with accessible handle through the deadfront
- HOA and push button start
- Separate accessible utility side with pre-wired landing lugs
- NEMA rated starters (sizes 1-5)
- Soft start units sizes 30HP-150HP
- 30 amp fuse block for pivot pre-wired in the unit
- White powder coated paint finish helps keep components cooler
  - Options include:
    - Hour meter
    - Chemical injection receptacle
    - Multiple injection receptacle
    - Multiple 30A fuse blocks possible

### Typical Applications

Power pedestal for irrigation systems or other pump control applications.

Stocked Pedestals	Exterior Cabinet	NEMA Rating
CP3B0281UMWIR04	White	4
CP3B0281UMWIR03	White	3
CP3B0181UMWIR02	White	2

### Notes

- Chart shows standard, stocked items. Other options and features are available. Contact factory for options, details and availability.

Please consult serving utility for their requirements prior to ordering or installing, as specifications and approvals vary by utility, and may require local electrical inspector approval. All installations must be installed by a licensed electrician and must comply with all national and local codes, laws and regulations. Milbank reserves the right to make changes in specifications and features shown without notice or obligation.



# Commercial Pedestals

## CP3B "BBS" Battery Backup Series



CP3B5111TCAWSP1

### Typical Applications

Metered emergency uninterrupted power for traffic intersections, wireless, phone and communications equipment, parking lots, camera and security locations.

**Milbank's BBS Series Commercial Pedestals** are designed to provide battery backup power for various loads, and to switch specific loads on and off under certain conditions; a photoelectric cell or time clock to control lighting circuits, as an example. Metered and non-metered power distribution options are available. The back-up power pedestal is designed to handle the vast majority of today's back-up power requirements. By using 19" rack design, shelves can be adjusted to accommodate the required batteries and manufactures DC to AC inverters, transfer switches and other related equipment. This design gives the user a wide range of design and configuration options. Complete turnkey, ready to power-up pedestals are offered along with basic units ready to accept batteries and inverters supplied by others.

### Features

- Type 3R construction
- 100 through 320 amp meter socket with the option of either a ring type socket (conforms to EUSERC 308) with or without test / bypass blocks or a heavy duty ringless socket with lever bypass
- Separate sealable utility termination compartment
- An isolated separate customer section with service disconnects, power distribution options and power control
- 19" wide rack in customer compartment for easy layout of equipment
- Battery trays
- Thermostat with cooling fan
- Filtered louvers for heat rise flow through ventilation
- Three point door latch (key or pad lockable)

### Options

- Manual bypass switch
- Transfer switch for generator power back-up
- Generator inlet receptacles 30A through 200A
- Pad lockable provision for receptacles
- Police access door
- Metered load center distribution
- Non metered load center distribution
- Photo electric controls (for street lighting)
- Time clocks
- HOA switches
- Contactors
- GFI duplex receptacles
- Thermostat for heating control
- Heating pads or elements
- Roll out shelves for batteries
- Surge arrestors and lighting arrestors



Please consult serving utility for their requirements prior to ordering or installing, as specifications and approvals vary by utility, and may require local electrical inspector approval. All installations must be installed by a licensed electrician and must comply with all national and local codes, laws and regulations. Milbank reserves the right to make changes in specifications and features shown without notice or obligation.

# Commercial Pedestals

## CP3B "Power Transfer" Series

**35**  
COMMERCIAL  
PEDESTALS



**Milbank's Power Transfer Series Pedestals** provide non metered AC power, distribution, surge suppression, mechanical interlock and stand-by generator receptacle all in a neat, compact pedestal.

### Features

- 120/240V 1Ø3W thru 277/480V 3Ø4W ratings
- Metered or unmetered units
- Choice of EUSERC ring type or ringless meter sockets
- 60 Amp thru 400 amp ratings
- UL Listed Type 3R rated
- Pad lockable, isolated utility compartments
- 20 amp GFI convenience receptacle
- Lockable recessed generator receptacle door
- Utility and generator indicator light options
- All stainless steel hardware
- Galvanized steel, aluminum or stainless steel cabinet options
- Custom designs available



### Typical Applications

Traffic intersections, cell sites, cable TV, pump and lift stations requiring utility power with backup generator power

Please consult serving utility for their requirements prior to ordering or installing, as specifications and approvals vary by utility, and may require local electrical inspector approval. All installations must be installed by a licensed electrician and must comply with all national and local codes, laws and regulations. Milbank reserves the right to make changes in specifications and features shown without notice or obligation.



# Commercial Pedestals

## CP3BB "CT Metered" Series



### Milbank's CT Metered Series

**Commercial Pedestals** are designed to be used where a smaller service package would be a better choice over large 3R rated combination switchboards. These pedestals have amperage ratings of 400 to 800 amp at voltages up through 480 volt three phase.

### Features

- UL Listed, freestanding Type 3R service
- A low profile CT pedestal
- All utility equipment is isolated in separated pad lockable and sealable compartments
- Separate customer compartment designed to hold distribution and control equipment
- Dead front customer construction
- Optional mounting base
- Optional construction in steel, aluminum and stainless steel.
- Wide choice of powder paint colors

### Typical Applications

Large homes, pumping and lift stations, motor control, water treatment plants, EV charging stations, commercial buildings, large remote service requirements, commercial and industrial control systems.



Please consult serving utility for their requirements prior to ordering or installing, as specifications and approvals vary by utility, and may require local electrical inspector approval. All installations must be installed by a licensed electrician and must comply with all national and local codes, laws and regulations. Milbank reserves the right to make changes in specifications and features shown without notice or obligation.



# Commercial Pedestals

## CP3A "Slimline" Series



Milbank's Slimline Series Commercial Pedestals provide a sleeker, smaller footprint and wireway access on the side of the unit rather than the back, allowing maximum flexibility to place the pedestal in tighter spaces.

### Features

- UL Listed as service equipment
- 100 or 200 amp
- Vandal-resistant, secure and attractive design
- Customer compartment with distribution and control equipment with swing dead front door, secured with both a hasp/latch and draw latch outer door
- Utility metering compartment protected with a hinged hood, increasing resistance to meter vandalism
- Small footprint
- Wireway located on left side of pedestal for utility incoming wire, allowing pedestal to be mounted with back very close to a wall (14")
- Available in 12" and 20" widths and 50" and 63" (metered) and 43" (nonmetered) heights
- Includes a print pocket for plans and drawings
- 200 amp main available
- Voltage range: 120V–480V
- Compatible with both ringless and ring type meter sockets, 4–7 terminals
- Available in a wide array of colors, including but not limited too all ANSI powder coated paint colors upon request
- Pedestal mounting base option saves time and labor to install on a cement pad—no anchor bolts required
- Powder-coated G90 galvanized steel, raw, anodized or powder-coated aluminum and stainless steel exterior options

### "Slimline" Series Direct Bury Extension

- No need for concrete
- Bolts directly to unit
- Easy, modular design
- Ships in a smaller package
- Increases project flexibility
- Easier to handle and install
- Utilizes a stabilizer foot to prevent leaning over time
- Pedestal and extension can be installed within 30 minutes

### Notes

- Currently only built in 14 guage steel
- Only available for 12" pedestals

#### Typical Applications

Roadway lighting and signage, wastewater treatment facilities, parks and landscaping, and any application where physical space is at a premium



Please consult serving utility for their requirements prior to ordering or installing, as specifications and approvals vary by utility, and may require local electrical inspector approval. All installations must be installed by a licensed electrician and must comply with all national and local codes, laws and regulations. Milbank reserves the right to make changes in specifications and features shown without notice or obligation.





**UQFP  
UQFPH**



**UQFP-M  
UQFPH-M**



**UQFB-X1**



**UQFB-X**



**UQFB**

### 200 amp Frame | Plug-In | 10,000 AIC & 22,000 AIC | Two-Pole - Common Trip

amp	10K AIC Plug-In	22K AIC Plug-In	10K AIC Plug-In	22K AIC Plug-In	Wire Range	
					CU	AL
100	UQFP-100	UQFPH-100	UQFP-M-100	UQFPH-M-100	#3-#1	#1-1/0
125	UQFP-125	UQFPH-125	UQFP-M-125	UQFPH-M-125	#3-#1	#1-1/0
150	UQFP-150	UQFPH-150	UQFP-M-150	UQFPH-M-150	1/0-300	2/0-300
175	UQFP-175	UQFPH-175	UQFP-M-175	UQFPH-M-175	1/0-300	2/0-300
200	UQFP-200	UQFPH-200	UQFP-M-200	UQFPH-M-200	1/0-300	2/0-300

### 200 amp Frame | Bolt-On | 10,000 AIC & 22,000 AIC | Two-Pole - Common Trip

amp	10K AIC Bolt-On	22K AIC Bolt-On	10K AIC Bolt-On	22K AIC Bolt-On	Wire Range	
					CU	AL
100	UQFB-100	UQFBH-100	UQFB-100-X1	UQFBH-M-100	#3-#1	#1-1/0
125	UQFB-125	UQFBH-125	UQFB-125-X1	UQFBH-M-125	#3-#1	#1-1/0
150	UQFB-150	UQFBH-150	UQFB-150-X1	UQFBH-M-150	1/0-300	2/0-300
175	UQFB-175	UQFBH-175	UQFB-175-X1	UQFBH-M-175	1/0-300	2/0-300
200	UQFB-200	UQFBH-200	UQFB-200-X1	UQFBH-M-200	1/0-300	2/0-300

### Notes

- **UL Listed:** For use with 60°C or 75°C wire.
- **UQFP:** For parallel main circuit breaker applications.
- **UQFP-M:** For series main circuit breaker applications Split load tab features allow for feed-through capability.
- **UQFB:** (2) 1/0-300 lugs provided on load and line side (cable-in, cable-out).
- **UQFB3:** Three-pole available. Consult factory.
- **UQFB-X:** (2) 1/0-300 lugs provided on load side and (2) line bar bus connections on line side.
- **UQFB-M:** For series main circuit breaker applications. Split load tab features allow for feed-through capability.
- **UQFB-X-MOD:** Replacement circuit breaker with line barriers removed.



Please consult serving utility for their requirements prior to ordering or installing, as specifications and approvals vary by utility, and may require local electrical inspector approval. All installations must be installed by a licensed electrician and must comply with all national and local codes, laws and regulations. Milbank reserves the right to make changes in specifications and features shown without notice or obligation.

# Accessories

## Hubs and Closing Plates

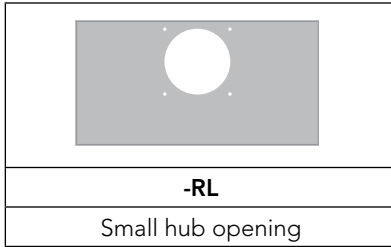

<b>-WL</b> <b>A7514</b>	<b>-YL</b> <b>A7515</b>	<b>-ZL</b> <b>A7516</b>	<b>-DL</b> <b>A7517</b>	<b>-EL</b> <b>A7518</b>	<b>-XL</b> <b>A7551</b>
1" hub	1¼" hub	1½" hub	2" hub	2½" hub	Small closing plate

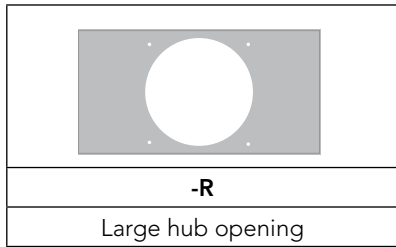

<b>-F</b> <b>A8110</b>	<b>-G</b> <b>A8111</b>	<b>H</b> <b>A8112</b>	<b>-X</b> <b>A9064</b>	<b>-RRL</b> <b>S8324</b>
3" hub	3½" hub	4" hub	Large closing plate	Large hub opening adapted to small hub opening

Please consult serving utility for their requirements prior to ordering or installing, as specifications and approvals vary by utility, and may require local electrical inspector approval. All installations must be installed by a licensed electrician and must comply with all national and local codes, laws and regulations. Milbank reserves the right to make changes in specifications and features shown without notice or obligation.



## Connector Kits, Closing Kits and Sealing Rings

### Connector Kits | For Use with 3/8"-16 Stud Type Units Only

Single			Twin		
Suffix	Part #	(3 per set) - 1Ø	Suffix	Part #	(3 per set) - 1Ø
K1	<b>K1539</b>	6-350	K2	<b>K1350</b>	6-350
K3	<b>K1540</b>	4-600 or (2) 1/0-250	K2L	<b>K1350L</b>	6-350 (non rotating)
K3L	<b>K1540L</b>	4-600 or (2) 1/0-250 (non rotating)	K4	<b>K1541</b>	4-600
Suffix	Part #	(4 per set) - 3Ø	Suffix	Part #	(4 per set) - 3Ø
K5	<b>K3082</b>	6-350	K6	<b>K3442</b>	6-350
K7	<b>K3441</b>	4-600 or (2) 1/0-250	K8	<b>K3083</b>	4-600

### Bypass Link



**K8180** (sold in pairs)

### Closing Covers

Meter Closing Plate (Ring Type / Ringless)	Metal Closing Plate (For Ringless Sockets)
<b>6003</b> - Grey Plastic	<b>CP-21</b>
<b>6116</b> - Clear Plastic	

### Generator Interlock

<b>K5815</b> - large QN with small frame Q
<b>K5820</b> - large frame QN with large frame QN
<b>K5830</b> - small frame Q to small frame Q

### Sealing Rings

<b>MR-2</b> - Snap Action	<b>MR-4</b> - Screw Type (Stainless Steel)
<b>MR2-SS</b> - Stainless Steel	

### Touch-Up Paint







**A-GP** - Light Grey

# Accessories

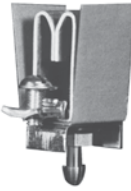
## Fifth Terminal and Tap Connectors

### Fifth Terminal

			
<b>5T8K2</b> - 100-200 amp "Plug-In"	<b>K5T</b> - 200 amp (Block with Square Hole)	<b>K3865</b> - Heavy Duty Jaw Clamping ( <b>K3866</b> without Neutral Wire)	This is for the U2852-56 and U2862-66 Condo metering Banks (125-200 amp) <b>K2381</b>

### Tap Connectors (3 per set)

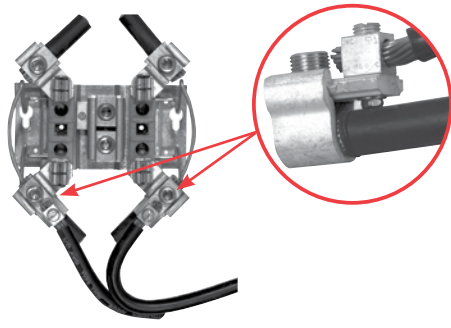
	Replaces the load or line side slide-in nut assembly on Milbank 200 amp sockets. Allows for a 100 amp tap location in addition to the #6-350 kcmil load-side connector. <b>K5022</b> includes safety barrier extensions for applications over 300 VAC. Three lugs per kit.
<b>K4977-INT</b> - Internal Hex	
<b>K4977-EXT</b> - External Hex	
<b>K5022-INT</b> - Internal Hex (set of 4 w/ barrier)	

### Pedestal Extension Units

Catalog Number	D"	W"	H"
<b>S8988</b>	4½	8¾	15
<b>S3488</b>	6	11	15
<b>S2571</b>	4⅞	10	12
<b>S1848</b>	4⅞	13	15
<b>K4694</b>	6	9	24
<b>K5800</b>	4⅞	9	15

### Isolated Neutral Kit



### Anti-Inversion Clip

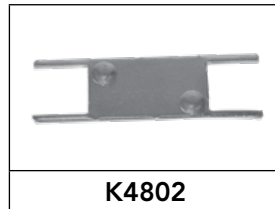

### Disconnect Sleeve



### Triplex Ground



\*Isolated neutrals are specific to the meter socket. Consult factory for correct isolated neutral.

Please consult serving utility for their requirements prior to ordering or installing, as specifications and approvals vary by utility, and may require local electrical inspector approval. All installations must be installed by a licensed electrician and must comply with all national and local codes, laws and regulations. Milbank reserves the right to make changes in specifications and features shown without notice or obligation.



### MAXIMUM NUMBER OF CONDUCTORS IN CONDUIT

Table from 2008 NEC Code Reference: Rigid Metal Conduit

Type	Conductor Size (AWG/kcmil)	Conduit Trade Sizes (Inches)									
		1/2	3/4	1	1 1/4	1 1/2	2	2 1/2	3	3 1/2	4
THHN, THWN, THWN-2	12	9	16	26	46	62	102	146	225	301	387
	10	6	10	17	29	39	64	92	142	189	244
	8	3	6	9	16	22	37	53	82	109	140
	6	2	4	4	12	16	27	38	59	79	101
	4	1	2	4	7	10	16	23	36	48	62
	3	1	1	3	6	8	14	20	31	41	53
	2	1	1	3	5	7	11	19	26	34	44
	1	1	1	1	4	5	8	12	19	25	35
	1/0	1	1	1	3	4	7	10	16	21	27
	2/0	0	1	1	2	3	6	8	13	18	23
3/0	0	1	1	1	3	5	7	11	15	19	
4/0	0	1	1	1	2	4	6	9	12	16	
XHH, XHHW, XHHW-2	4	1	2	4	7	10	16	24	37	49	63
	2	1	1	3	5	7	12	17	26	35	45
	1/0	1	1	1	3	4	7	10	16	22	28
	2/0	0	1	1	2	3	6	9	13	18	23
	4/0	0	1	1	1	2	4	6	9	12	16
	250	0	0	1	1	1	3	5	7	10	13
	350	0	0	1	1	1	2	3	6	7	10
500	0	0	0	1	1	1	2	4	5	7	
750	0	0	0	0	1	1	1	3	4	5	

This table is for concentric stranded conductors only. For cables with compact conductors refer to NEC. Refer to latest NEC Code or Local Codes for updated requirements.

### SAMPLE RATING LABEL

**CATALOG NUMBERS U5952 & U5953**  
100A MAXIMUM, 120/240 VAC SINGLE PHASE, THREE WIRE  
RAINPROOF NEMA TYPE 3R

---

SHORT CIRCUIT CURRENT RATING IS 10,000 RMS SYMMETRICAL AMPERE AT 240 VAC MAXIMUM, BUT IS LIMITED TO THE LOWEST SHORT CIRCUIT CURRENT RATING OF ANY INSTALLED CIRCUIT BREAKER. WATTHOUR METER NOT INCLUDED IN SHORT CIRCUIT CURRENT RATING. REPLACEMENT CIRCUIT BREAKER MUST BE THE SAME TYPE AND RATING. USE SIEMENS CP, QT, CUTLER-HAMMER CP, BD, BR, SQUARE D HOMELINE; G.E. TO, THQ, THQL.

---

SUITABLE FOR USE AS RECREATIONAL VEHICLE SITE SUPPLY EQUIPMENT

---

UNDERGROUND FEED ONLY

---

ON  
TRIP  
OFF

TO RESET BREAKER MOVE TO "OFF" THEN TO "ON"

---

**DANGER**  
HAZARD OF ELECTRICAL SHOCK OR BURN  
TURN OFF POWER  
SUPPLYING THIS EQUIPMENT BEFORE WORKING INSIDE

---

WIRE TERMINAL INFORMATION USE AL-CU CONDUCTORS		
TERMINAL	WIRE RANGE	TORQUE LB-IN
LINE AND LINE NEUTRAL	350 kcmil - # 6	250
GROUND CONNECTOR	2# 20 AWG - #14 AWG	120
LOAD NEUTRAL SLOTTED HEAD (LARGE HOLE)	14 - 10	35
	8	40
	6 - 4	45
LOAD NEUTRAL SLOTTED HEAD (SMALL HOLE)	3 - 1/0	50
	14 - 10	20
	8	25
	6	35

SHIPPING TENDS TO LOOSEN BOLTED CONNECTIONS. CHECK AND TIGHTEN ALL HARDWARE BEFORE ENERGIZING UNIT.

SIZE OF FIELD INSTALLED CONDUCTORS SHALL BE 60°C/75°C SIZED TO 60°C RATINGS FOR 110 AMPS OR LESS AND 75°C SIZED TO 75°C FOR 125 AMPS AND ABOVE.

#### \* ALLOWABLE AMPACITIES OF INSULATED COPPER & ALUMINUM CONDUCTORS (3W IN CONDUIT) 75°C (167°F)

*CU		AL or **Cu-Clad AL	
A	B	A	C
18	-	-	-
16	-	-	-
14	20†	-	-
12	25†	12	20†
10	35†	10	30†
8	50	8	40
6	65	6	50
4	85	4	65
3	100	3	75
2	115	2	90
1	130	1	100
1/0	150	1/0	120
2/0	175	2/0	135
3/0	200	3/0	155
4/0	230	4/0	180
250	255	250	205
300	285	300	230
350	310	350	250
400	335	400	270
500	380	500	310
600	420	600	340
700	460	700	375
750	475	750	385

A = Size: AWG/MCM  
 \*B = Ampere Rating for Insulation Types:  
**FEPW, RH, RHW, THW, THWN, XHHW, USE, 2W.**  
 \*\*C = Ampere Rating for Insulation Types:  
**RH, RHW, THW, THWN, XHHW, USE**  
 (Per NEC table 310-16)

#### AMPACITY CORRECTION FACTORS

AMBIENT TEMP. C°	CORRECTION FACTOR	AMBIENT TEMP. F°
21 - 25	1.05	70 - 77
26 - 30	1.00	78 - 86
31 - 35	.94	87 - 95
36 - 40	.88	96 - 104
41 - 45	.82	105 - 113
46 - 50	.75	114 - 122
51 - 55	.67	123 - 131
56 - 60	.58	132 - 140
61 - 65	.33	141 - 158

Overall ampere ratings of U/L listed Milbank multiple position meter sockets are based on 2008 N.E.C. Handbook Article 220-84 and ANSI / UL-414 (except where restricted by line connector size.) These requirements provide for a diversity factor / demand factor being utilized in determining the overall (main bus / lug) rating of a gang socket. All Milbank U/L listed gang sockets meet or exceed these diversity factor/demand factor requirements. Standard overall ampacity ratings for U/L listed and non U/L listed gang sockets are as shown in the chart below. Ampere ratings of meter sockets are based on the meter socket being wired with 75° C insulated wire conductor, sized in accordance with Table 310-16 of the National Electric Code.

#### GANG SOCKET OVERALL AMPACITIES

NO. OF METER POSITIONS	100A / POS. AMPACITY	125A / POS. AMPACITY	150A / POS. AMPACITY	200A / POS. AMPACITY
2	200A	200A	200A	200A #
3	200A	225A	225A	270A
4	200A	250A	270A	360A
5	225A	285A	338A	450A
6	270A	330A	396A	528A

† Unless otherwise permitted elsewhere in the Code, the overcurrent protection for conductor types marked with an obelisk (†) shall not exceed 15 amps for 14 AWG, 20 amps for 12 AWG, and 30 amps for 10 AWG copper; or 15 amps for 12 AWG and 25 amps for 10 AWG aluminum and copper-clad aluminum after any correction factors for ambient temperature and number of conductors have been applied.

# Some constructions are rated at 400 amps overall. Contact your sales representative for more information. Refer to latest NEC Code or Local Codes for updated requirements.



Please consult serving utility for their requirements prior to ordering or installing, as specifications and approvals vary by utility, and may require local electrical inspector approval. All installations must be installed by a licensed electrician and must comply with all national and local codes, laws and regulations. Milbank reserves the right to make changes in specifications and features shown without notice or obligation.

# Energization of Electrical Equipment

## Important Information for Installers

### Important Note

In addition to national and local electrical codes, many utilities have specific requirements for metering equipment. Always consult the serving utility for their specifications and requirements prior to ordering or installing Milbank meter mounting equipment.

### Before Energizing

1. Give equipment a thorough visual examination to determine that:
  - a) No shipping or installation damage exists.
  - b) Proper clearances have been maintained.
  - c) All connections have been made.
  - d) Equipment is clean and dry.
2. Make a thorough examination to:
  - a) Verify tightness of all bolted connections (see table below).
  - b) Manually operate all circuit breakers, switches, relays, etc.
  - c) Check rigidity of all mountings, bus bars and components.
  - d) Use test equipment to check continuity of circuitry and integrity of insulation.
3. All switches and circuit breakers should be in the OFF position.
4. Verify that manual meter bypass (if applicable) is in non-bypass position.
5. Install cover and/or close doors.
6. If installation is not being energized at this time, follow "after-energizing" steps listed below. These steps will secure the installation in case of accidental energization.

### When Energizing

1. Use caution and follow established safety procedures:
  - a) Wear safety apparel.
  - b) Use safety equipment.
  - c) Take action to prevent injury to yourself and others in the event of failure of the installation.
  - d) Take action to prevent/decrease damage to property in the event of failure of the installation.
  - e) If you are unsure how to safely energize the installation, get someone who is knowledgeable to do it.

### After Energizing

1. Secure the installation:
  - a) To prevent accidental contact with energized parts, cover all openings with approved filler devices.
  - b) To prevent unauthorized access, secure all covers and/or doors with approved security devices.
  - c) Attach/post information to advise others of potential hazards associated with the installation.

### Recommended Torque for General Applications\*

Nominal Size	Joint Description		Head Type	Torque (Inch Lbs.)
	Screw	Nut		
10	Brass	Brass Nut or Extruded Hole	All	20-25 inch lbs.
10	Steel	Copper or Aluminum Busbar $\leq 1/8"$	All	25-30 inch lbs.
10	Steel	Steel Nut or Extruded Hole; CU or AL Busbar $> 1/8"$	All	30-35 inch lbs.
12	Steel	Aluminum Extruded Hole	All	30-35 inch lbs.
12	Steel	Steel Nut or Extruded Hole	All	40-50 inch lbs.
1/4	Steel	Aluminum Extruded Hole	All	40-50 inch lbs.
1/4	Steel	Steel Nut or Extruded Hole; CU or AL Busbar	All	50-60 inch lbs.
5/16	Steel	Aluminum Extruded Hole	Hex	60-70 inch lbs.
5/16	Steel	Steel Nut or Extruded Hole; CU or AL Busbar	Hex	100-150 inch lbs.
3/8	Steel	Steel Nut	Hex	150-200 inch lbs.
1/2	Steel	Steel Nut	Hex	200-250 inch lbs.

\* Interior labels typically indicate the required torque for wire connectors and studs, and should be referenced first.  
CU: Copper  
AL: Aluminum

Please consult serving utility for their requirements prior to ordering or installing, as specifications and approvals vary by utility, and may require local electrical inspector approval. All installations must be installed by a licensed electrician and must comply with all national and local codes, laws and regulations. Milbank reserves the right to make changes in specifications and features shown without notice or obligation.



## Materials

### Steel Quality

---

The meter equipment listed in this catalog is made of galvanized steel (AISI\* G90) to afford the best possible weather proofing.  
\*American Iron and Steel Institute.

### Steel Sheet

---

16 gauge, galvanized, sheet: 1 1/4 oz./ sq.ft. class zinc-coated. (AISI G90)  
14 gauge, galvanized, sheet: 1 1/4 oz./ sq.ft. class zinc-coated.

### Aluminum Extrusion

---

Wire-Terminal: Alloy; 6061-T6, Tin-plated for CU/AL wire.  
Bus Bar: Alloy; 6101-O & 6063-O

### Aluminum Sheet

---

3000 series aluminum sheet, H14, or 5052 series aluminum sheet, H32. Where applicable thicknesses range from .064-.125

### Copper Sheet & Bus

---

Electrolytic copper with tin plating in most applications.

### Insulating Materials

---

- In most units, support bases for current-carrying components are molded from fiberglass reinforced high-strength, track resistant, thermoset polyester molding compounds.
- Clear or black safety shields and polarity barriers are molded from high-strength, track resistant, polycarbonate molding compounds.
- Various sheet insulating materials, as appropriate for the application are utilized in the fabrication of flat, formed and punched component parts and barriers.

## Finish

### Process

---

Light gray state-of-the-art electrostatically applied powder paint offers a durable, non-fading finish. For further information concerning the chemical analysis of the weather resistant finish, please contact the factory.

### Metal Fasteners

---

Zinc-coated with a chromate dip.

## Ratings & Compliance

### Ratings & Compliance

---

All Milbank electrical enclosures in this catalog are rated "Type 3R Enclosure" unless specified otherwise on the product's page. All enclosures with a UL designation are constructed per the appropriate UL Standard and may be installed per the National Electric Code. UL procedure files associated with the UL Standards are listed as follows: Meter Sockets (UL 414, File E30202), Test Switches (UL 414, File E62531), Power Outlets (UL 231, File E90945), Panelboards (UL 67, File E32628) and Pullout Switches (UL 1429, File E133062). Additional standards are utilized as applicable: Meter Sockets (ANSI C12.7), Test Switches (ANSI C12.9) and Panelboards (NEMA PB-1).



Please consult serving utility for their requirements prior to ordering or installing, as specifications and approvals vary by utility, and may require local electrical inspector approval. All installations must be installed by a licensed electrician and must comply with all national and local codes, laws and regulations. Milbank reserves the right to make changes in specifications and features shown without notice or obligation.



**DIAGRAM A**  
1 $\emptyset$ 2w with 1 P.T. & 1 C.T.  
Single Stator Meter(2W1 $\emptyset$ ) - Form 35  
5T Socket, Test Switch #TS04-0101

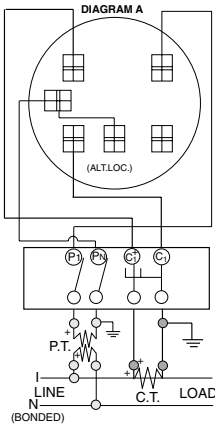

**DIAGRAM B**  
1 $\emptyset$ 3w with 1 C.T.  
Single Stator Meter(2W1 $\emptyset$ ) - Form 35  
5T Socket, Test Switch #TS04-0101

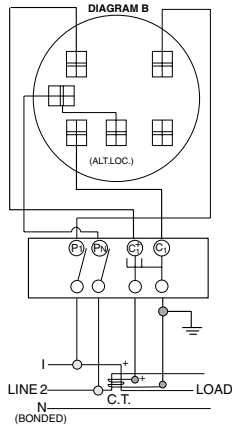

**DIAGRAM C**  
1 $\emptyset$ 3w with 2 C.T.'s  
Single Stator Meter(3W1 $\emptyset$ ) - Form 45  
6T Socket, Test Switch #TS07-0105

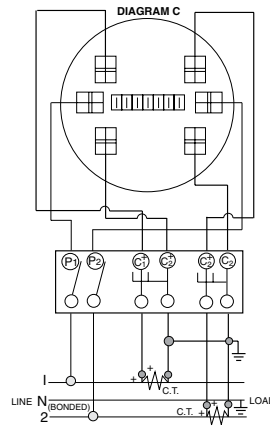

**DIAGRAM D**  
1 $\emptyset$ 3w or 3W Network with 2 C.T.'s  
2 Stator Meter - Form 55  
8T Socket, Test Switch #TS07-0105

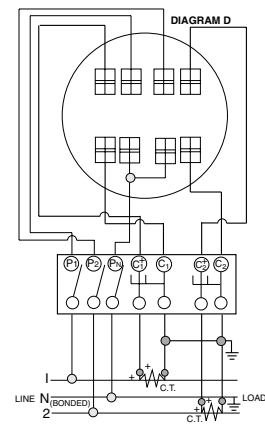

**DIAGRAM E**  
3 $\emptyset$ 3w "Δ" with 2 P.T.'s & 2 C.T.'s  
2 Stator Meter - Form 55  
8T Socket, Test Switch #TS07-0105

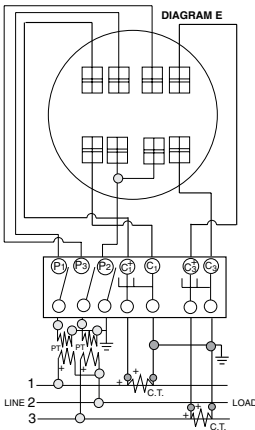

**DIAGRAM F**  
3 $\emptyset$ 3w "Δ" with 2 C.T.'s  
2 Stator Meter - Form 55  
8T Socket, Test Switch #TS07-0105

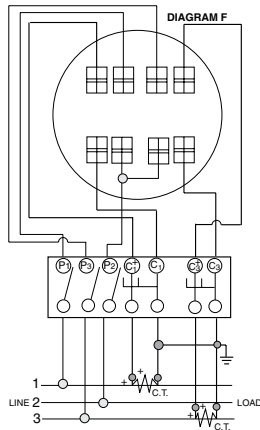

**DIAGRAM G**  
3 $\emptyset$ 4w "Y" with 3 C.T.'s  
2 1/2 Stator Meter - Form 65  
13T Socket, Test Switch #TS10-0109

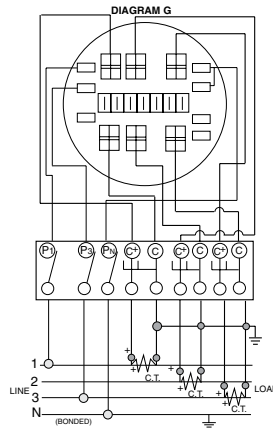

**DIAGRAM H**  
3 $\emptyset$ 4w "Y" with 2 P.T.'s & 3 C.T.'s  
1 1/2 Stator Meter - Form 65  
13T Socket, Test Switch #TS10-0109

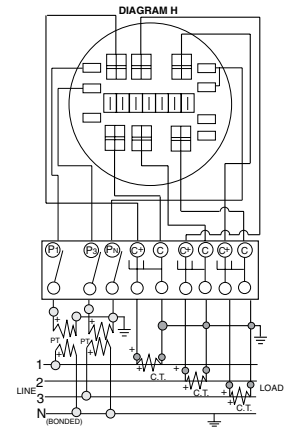

**DIAGRAM I**  
3 $\emptyset$ 4w "Y" or "Δ" with 3 C.T.'s  
"Y" 3 Stator Meter - Form 9S  
"Δ" 2 Stator Meter - Form 8S  
13T Socket, Test Switch #TS10-0109

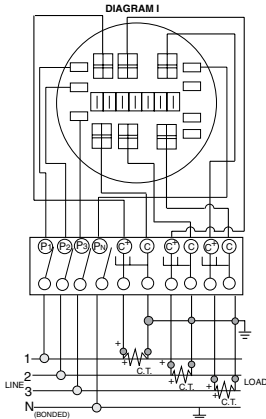

**DIAGRAM J**  
3 $\emptyset$ 4w "Y" with 3 P.T.'s & 3 C.T.'s  
3 Stator Meter - Form 9S  
13T Socket, Test Switch #TS10-0109

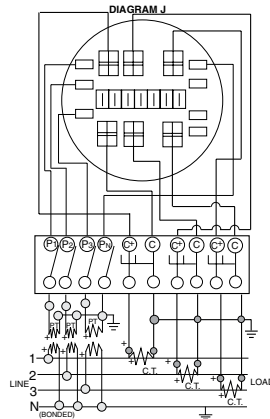

**Prewiring:** If standard factory prewiring is required, refer to wiring diagrams on this page. Determine appropriate diagram and send a copy with order. If custom factory prewiring is required, specify on order. Be sure to include meter socket catalog number, test switch make and catalog number, meter form number and provide a copy of your wiring diagram.

Please consult serving utility for their requirements prior to ordering or installing, as specifications and approvals vary by utility, and may require local electrical inspector approval. All installations must be installed by a licensed electrician and must comply with all national and local codes, laws and regulations. Milbank reserves the right to make changes in specifications and features shown without notice or obligation.



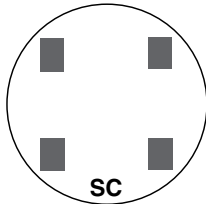

**SC**  
2 and 3-WIRE FORMS  
1S & 2S

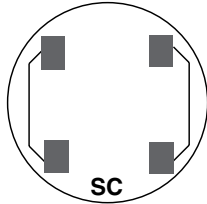

**SC**  
2 and 3-WIRE FORMS  
1S & 2S with BYPASS

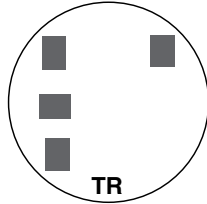

**TR**  
2-WIRE FORM 3S  
5th Term. 9 o'clock

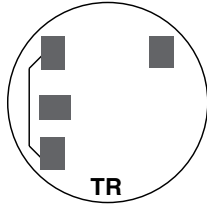

**TR**  
2-WIRE FORM 3S  
with BYPASS

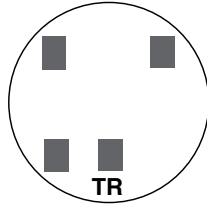

**TR**  
2-WIRE FORM 3S  
5th Term. 6 o'clock

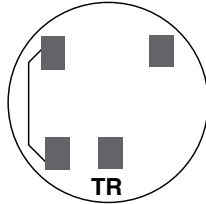

**TR**  
2-WIRE FORM 3S  
with BYPASS

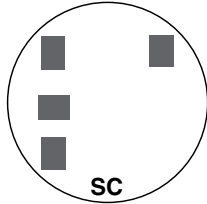

**SC**  
2 ELEMENT  
3-WIRE NETWORK  
FORM 12S 5th  
TERM. 9 o'clock

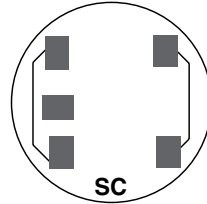

**SC**  
2 ELEMENT 3-WIRE  
NETWORK FORM 12S  
with BYPASS  
5th Term. 9 o'clock

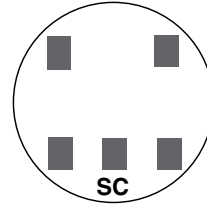

**SC**  
2 ELEMENT  
3-WIRE NETWORK  
FORM 12S 5th  
TERM. 6 o'clock

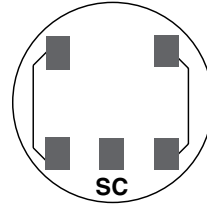

**SC**  
2 ELEMENT 3-WIRE  
NETWORK FORM 12S  
with BYPASS  
5th Term. 6 o'clock

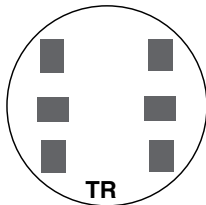

**TR**  
3-WIRE FORM 4S

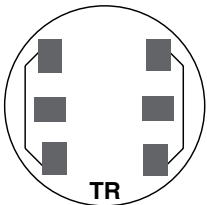

**TR**  
3-WIRE FORM 4S  
WITH BYPASS

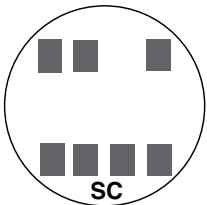

**SC**  
2 or 3 ELEMENT  
3Ø4W Y or  
Y FORM 14S  
FORM 15S  
Y FORM 16S

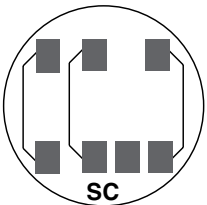

**SC**  
2 or 3 ELEMENT  
3Ø4W Y or  
FORMS 14S & 15S  
with BYPASS

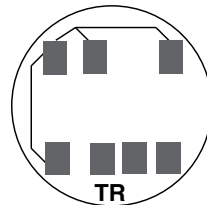

**TR**  
2 ELEMENT  
3Ø4W Y or  
Y FORM 7S  
FORM 24S  
with BYPASS

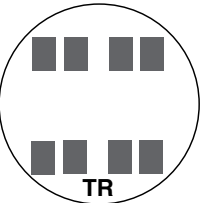

**TR**  
2 ELEMENT  
2Ø3W, 2Ø4W, 3Ø3W  
FORM 5S

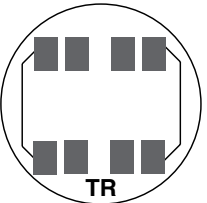

**TR**  
2 ELEMENT Ø3W,  
2Ø4W, 3Ø3W  
FORM 5S with  
BYPASS

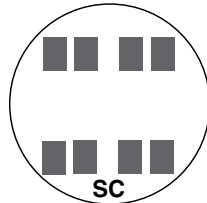

**SC**  
2 ELEMENT  
2Ø3W, 2Ø4W, 3Ø3W  
FORM 13S

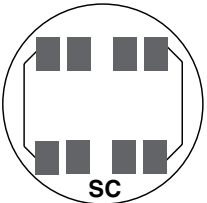

**SC**  
2 or 3 ELEMENT  
2Ø3W, 2Ø4W, 3Ø3W  
FORM 13S with  
BYPASS

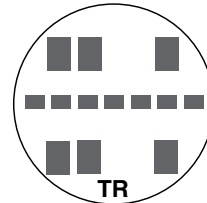

**TR**  
2 or 3 ELEMENT  
3Ø4W Y or  
Y FORM 9S  
FORM 8S

TR = TRANSFORMER RATED  
SC = SELF CONTAINED

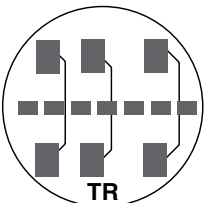

**TR**  
2 or 3 ELEMENT  
3Ø4W Y or  
FORMS 8S & 9S  
FORMS 8S & 9S  
with BYPASS

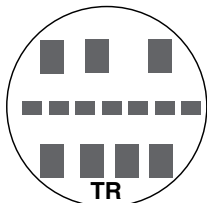

**TR**  
2 ELEMENT  
3Ø4W Y  
FORM 6S

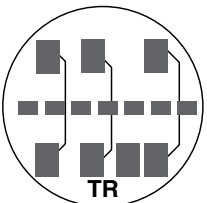

**TR**  
2 ELEMENT  
3Ø4W Y  
FORM 6S  
with BYPASS



Please consult serving utility for their requirements prior to ordering or installing, as specifications and approvals vary by utility, and may require local electrical inspector approval. All installations must be installed by a licensed electrician and must comply with all national and local codes, laws and regulations. Milbank reserves the right to make changes in specifications and features shown without notice or obligation.

# Standard NEMA Configurations

Reference Information Only

## 2 Pole | 3 Wire | Grounding Receptacles

Straight Blade Wiring Devices				Twist-Lock Wiring Devices				
Volts	Code	15 amp	20 amp	30 amp	50 amp	15 amp	20 amp	30 amp
125	5							
		5-15R	5-20R	5-30R	5-50R	L5-15R	L5-20R	L5-30R
250	6							
		6-15R	6-20R	6-30R	6-50R	L6-15R	L6-20R	L6-30R
277 VAC	7							
		7-15R	7-20R	7-30R	7-50R	L7-15R	L7-20R	L7-30R

## 3 Pole | 3 Wire | Special Applications

Straight Blade Wiring Devices			Twist-Lock Wiring Devices			
Volts	Code	20 amp	30 amp	50 amp	20 amp	30 amp
125V 250V	10					
		10-20R	10-30R	10-50R	L10-20R	L10-30R

## 3 Pole | 4 Wire | Grounding

Straight Blade Wiring Devices				Twist-Lock			
Volts	Code	15 amp	20 amp	30 amp	50 amp	20 amp	30 amp
125V 250V	14						
		14-15R	14-20R	14-30R	14-50R	L14-20R	L14-30R

## 2 Pole | 3 Wire | Grounding | NEMA Trailer

Straight Blade Wiring Devices		
Volts	Code	30 amp
125V	TT	

Please consult serving utility for their requirements prior to ordering or installing, as specifications and approvals vary by utility, and may require local electrical inspector approval. All installations must be installed by a licensed electrician and must comply with all national and local codes, laws and regulations. Milbank reserves the right to make changes in specifications and features shown without notice or obligation.



# Utility Approval Chart

Catalog Number	C.H.	NYS EG	National Grid NY	RGE
U3802				
U3812				
U3832				
U3862				
U3822-20GWR				
U4175-RL-BLG			X	
U7021-RL-TG-KK-RGE		X	X	X
U7040-RL-TG-KK-RGE	X	X		X
U7487-RL-TG-KK	X	X		
U9090-O			X	
U2048-RL	X		X	
U9551-RL				X
U9551-RXL				
U9801-R	X			
U2046-O			X	
U2047-O			X	
U2049-RL			X	
U9701-R	X			
U2448-X-RGE	X		X	X
U2594-X	X		X	X
U4013-X			X	X
U5161-X			X	X
U5168-XTL-100-KK	X	X	X	X
U5168-XTL-100-KK-PL	X	X	X	X
U5168-XTL-150-KK	X	X	X	X
U5168-XTL-200-KK	X	X	X	X
U5168-XTL-200-KK-PL	X	X	X	X
U5268-XTL-150-KK				
U5268-XTL-200-KK				
U1252-R-KK-RGE	X	X	X	X
U1253-R-KK-RGE	X	X	X	X
U1254-R-KK-EX-RGE	X	X	X	X
U1255-R-KK-EX-RGE	X	X	X	X
U1256-R-KK-EX-RGE	X	X	X	X
U2852-X			X	
U2853-X			X	
U2854-X			X	
U2855-X			X	

Catalog Number	C.H.	NYS EG	National Grid NY	RGE
U2856-X			X	
U2862-X			X	
U2863-X			X	X
U2864-X			X	X
U2865-X			X	X
U2866-X			X	X
U5882-X-KK-BL		x	x	x
U5882-X-KK-BLG		x	x	x
U5883-X-KK-BL		x	x	x
U5883-X-KK-BLG		x	x	x
U5884-X-KK-BL		x	x	x
U5884-X-KK-BLG		x	x	x
U5885-X-KK-BL		x	x	x
U5885-X-KK-BLG		x	x	x
U5886-X-KK-BL		x	x	x
U5886-X-KK-BLG		x	x	x
U5902-X-KK-BL		x	x	x
U5902-X-KK-BLG		x	x	x
U5903-X-KK-BL		x	x	x
U5903-X-KK-BLG		x	x	x
U5904-X-KK-BL		x	x	x
U5904-X-KK-BLG		x	x	x
U5905-X-KK-BL		x	x	x
U5905-X-KK-BLG		x	x	x
U5906-X-KK-BL		x	x	x
U5906-X-KK-BLG		x	x	x
U2872-XT			X	
U2873-XT			X	
U2874-XT			X	
U2875-XT			X	
U2876-XT			X	
U2732-XT			X	
U2733-XT			X	
U2734-XT			X	
U2735-XT			X	



Please consult serving utility for their requirements prior to ordering or installing, as specifications and approvals vary by utility, and may require local electrical inspector approval. All installations must be installed by a licensed electrician and must comply with all national and local codes, laws and regulations. Milbank reserves the right to make changes in specifications and features shown without notice or obligation.

# Utility Approval Chart

Catalog Number	C.H.	NYS EG	National Grid NY	RGE
U2736-XT			X	
U4093N-O			X	X
U5136-O			X	
U5136-O-100S			X	
U5136-O-200S			X	
U5137-O			X	
U5137-O-100S			X	
U5137-O-200S			X	
U5138-O				
U5138-O-200S				
U5139-O				
U4493-XL	X			
S1855-O	X			
S1856-O-HUD				
363010-CT3R			X	
363016-CT3R			X	
363610-CT3R			X	
363612-CT3R			X	
363616-CT3R			X	
483616-CT3R			X	
484812-CT3R			X	
606013-CT3R			X	
363610-TC3R-H-BP-SP			X	

Please consult serving utility for their requirements prior to ordering or installing, as specifications and approvals vary by utility, and may require local electrical inspector approval. All installations must be installed by a licensed electrician and must comply with all national and local codes, laws and regulations. Milbank reserves the right to make changes in specifications and features shown without notice or obligation.



6003.....	40	K4802 .....	41	U2866-X.....	16
6116.....	40	K4977-EXT.....	41	U2872-XT.....	19
363010-CT3R.....	26	K4977-INT .....	41	U2873-XT.....	19
363016-CT3R.....	26	K5022-INT .....	41	U2874-XT.....	19
363610-CT3R.....	26	K5800 .....	41	U2875-XT.....	19
363610-TC3R-H-BP-SP .....	27	K5815 .....	40	U2876-XT.....	19
363612-CT3R.....	26	K5820 .....	40	U3802 .....	6
363616-CT3R.....	26	K5830 .....	40	U3812 .....	6
483616-CT3R.....	26	K5T .....	41	U3822-20GWR.....	7
484812-CT3R.....	26	M5-144 .....	41	U3832 .....	6
5T8K2 .....	41	MR-2 .....	40	U3862 .....	6
606013-CT3R.....	26	MR2-SS.....	40	U4013-X.....	13
A7514 .....	39	MR-4 .....	40	U4093N-O .....	21
A7515 .....	39	-R .....	39	U4175-RL-BLG .....	8
A7516 .....	39	-RL.....	39	U4493-XL.....	24
A7517 .....	39	S1848.....	41	U5136-O .....	23
A7518 .....	39	S1855-O.....	25	U5136-O-100S.....	23
A7551 .....	39	S1856-O-HUD.....	25	U5136-O-200S.....	23
A8110 .....	39	S2571.....	41	U5137-O .....	23
A8111 .....	39	S3488.....	41	U5137-O-100S.....	23
A8112 .....	39	S8324.....	39	U5137-O-200S.....	23
A9064 .....	39	S8988.....	41	U5138-O .....	23
A-GP.....	40	U1252-R-KK-RGE.....	15	U5138-O-200S.....	23
CP-21.....	40	U1253-R-KK-RGE.....	15	U5139-O .....	23
CP3B51110A22SL1.....	31	U1254-R-KK-EX-RGE.....	15	U5161-X.....	13
CP3B51115A22 .....	30	U1255-R-KK-EX-RGE.....	15	U5168-XTL-100-KK.....	14
CP3B5111RASP .....	33	U1256-R-KK-EX-RGE.....	15	U5168-XTL-100-KK-PL.....	14
CP3B52110A22SL1.....	31	U2046-O .....	12	U5168-XTL-150-KK.....	14
CP3B52119A22 .....	30	U2047-O .....	12	U5168-XTL-200-KK.....	14
CP3B54111JB22.....	32	U2048-RL.....	11	U5168-XTL-200-KK-PL.....	14
CP3B54120B22.....	32	U2049-RL.....	12	U5268-XTL-150-KK.....	14
K1047 .....	41	U2448-X-RGE.....	13	U5268-XTL-200-KK.....	14
K1190 .....	41	U2594-X.....	13	U5882-X-KK-BL.....	17
K1350 .....	40	U2732-XT.....	20	U5882-X-KK-BLG.....	17
K1350L.....	40	U2733-XT.....	20	U5883-X-KK-BL.....	17
K1539 .....	40	U2734-XT.....	20	U5883-X-KK-BLG.....	17
K1540 .....	40	U2735-XT.....	20	U5884-X-KK-BL.....	17
K1540L.....	40	U2736-XT.....	20	U5884-X-KK-BLG.....	17
K1541 .....	40	U2852-X.....	16	U5885-X-KK-BL.....	17
K2381 .....	41	U2853-X.....	16	U5885-X-KK-BLG.....	17
K3082 .....	40	U2854-X.....	16	U5886-X-KK-BL.....	17
K3083 .....	40	U2855-X.....	16	U5886-X-KK-BLG.....	17
K3441 .....	40	U2856-X.....	16	U5902-X-KK-BL.....	17
K3442 .....	40	U2862-X.....	16	U5902-X-KK-BLG.....	17
K3865 .....	41	U2863-X.....	16	U5903-X-KK-BL.....	17
K3866 .....	41	U2864-X.....	16	U5903-X-KK-BLG.....	17
K4694 .....	41	U2865-X.....	16	U5904-X-KK-BL.....	17



Please consult serving utility for their requirements prior to ordering or installing, as specifications and approvals vary by utility, and may require local electrical inspector approval. All installations must be installed by a licensed electrician and must comply with all national and local codes, laws and regulations. Milbank reserves the right to make changes in specifications and features shown without notice or obligation.

U5904-X-KK-BLG .....	17	UQFP-M-100.....	38
U5905-X-KK-BL.....	17	UQFP-M-125.....	38
U5905-X-KK-BLG .....	17	UQFP-M-150.....	38
U5906-X-KK-BL.....	17	UQFP-M-175.....	38
U5906-X-KK-BLG .....	17	UQFP-M-200.....	38
U7021-RL-TG-KK-RGE .....	9		
U7040-RL-TG-KK-RGE .....	9		
U7487-RL-TG-KK .....	9		
U9090-O .....	10		
U9551-RL .....	11		
U9551-RXL.....	11		
U9701-R.....	12		
U9801-R.....	11		
UQFB-100.....	38		
UQFB-100-X1 .....	38		
UQFB-125.....	38		
UQFB-125-X1 .....	38		
UQFB-150.....	38		
UQFB-150-X1 .....	38		
UQFB-175.....	38		
UQFB-175-X1 .....	38		
UQFB-200.....	38		
UQFB-200-X1 .....	38		
UQFBH-100 .....	38		
UQFBH-125 .....	38		
UQFBH-150 .....	38		
UQFBH-175 .....	38		
UQFBH-200 .....	38		
UQFBH-M-100.....	38		
UQFBH-M-125.....	38		
UQFBH-M-150.....	38		
UQFBH-M-175.....	38		
UQFBH-M-200.....	38		
UQFP-100.....	38		
UQFP-125.....	38		
UQFP-150.....	38		
UQFP-175.....	38		
UQFP-200.....	38		
UQFPH-100 .....	38		
UQFPH-125 .....	38		
UQFPH-150 .....	38		
UQFPH-175 .....	38		
UQFPH-200 .....	38		
UQFPH-M-100.....	38		
UQFPH-M-125.....	38		
UQFPH-M-150.....	38		
UQFPH-M-175.....	38		
UQFPH-M-200.....	38		

Please consult serving utility for their requirements prior to ordering or installing, as specifications and approvals vary by utility, and may require local electrical inspector approval. All installations must be installed by a licensed electrician and must comply with all national and local codes, laws and regulations. Milbank reserves the right to make changes in specifications and features shown without notice or obligation.



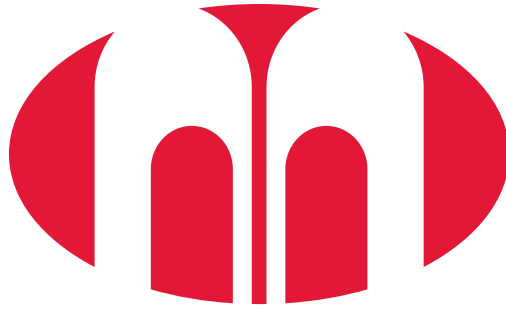

# MILBANK<sup>®</sup>

ENERGY AT WORK

