

Twist-Lock® Devices
 30A, 3 Phase 250V AC, 3 Pole, 4 Wire
 Grounding
 Insulgrip® Plug

HUBBELL

Features

- Superior cord grip design protects terminations from excess strain.
- Clear, funnel shaped wire entry for ease of termination.
- Integral dust shield protects wiring chamber from dust or contaminants.

Ordering Information

Description	Cord Diameter	UPC	Catalog Number
Black and white nylon.	.350"-1.150" (9-29)	783585039220	HBL2721

Listings

Listed to UL 498
 Fed.Spec. W-C-596
 Certified to CSA C22.2 No.42

Specifications

Housing / Cord Clamp	Nylon
Terminal Retainer	Clear polycarbonate
Blades	Brass
Terminal Screws	#10-32 Brass (Phillips / Slotted / Robertson)
Terminal Clamp	Cold rolled steel – nickel plated
Assembly Screws	Steel - nickel plated

Performance

Electrical	
Current Interrupting	Certified for current interrupting at full rated current
Dielectric Voltage	Withstands 2,000V minimum

Mechanical	
Terminal Accommodation	#16 AWG - #8 AWG stranded copper wire only.

Terminal Identification	Terminals identified in accordance with UL 498
-------------------------	--

Environmental	
Flammability	HB or better per UL94/CSA 22.2 No.0.17
Moisture Resistance	IP20 Suitability
Operating Temperatures	Maximum Continuous 75°C; Minimum -40°C (w/o impact)



30A 3Ø 250V AC
 NEMA L15-30P
 UL/CSA
 3 HP

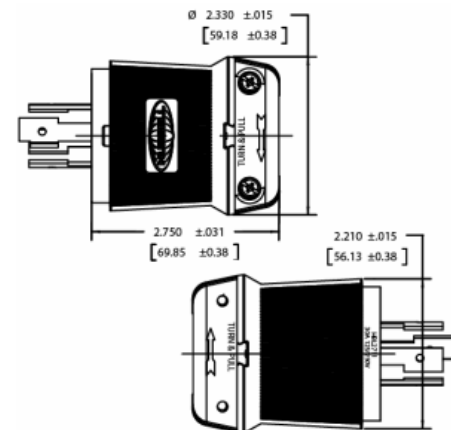

Accessories

Connector	HBL2723
Single Receptacle	HBL2720
Flanged Receptacle	HBL2726
Weatherproof Boot	HBL6035

Resources

Customer Use Drawing
 eCatalog

Dimensions in Inches (mm)

Hubbell Wiring Device-Kellems • Hubbell Incorporated (Delaware) • 40 Waterview Drive • Shelton, CT 06484

Phone (800) 288-6000 • Fax (800) 255-1031 • Specifications subject to change without notice.



Twist-Lock® Devices
 30A, 3 Phase 250V AC, 3 Pole, 4 Wire
 Grounding
 Insulgrip® Plug

HUBBELL

Features

- Superior cord grip design protects terminations from excess strain.
- Clear, funnel shaped wire entry for ease of termination.
- Integral dust shield protects wiring chamber from dust or contaminants.

Ordering Information

Description	Cord Diameter	UPC	Catalog Number
Black and white nylon.	.350"-1.150" (9-29)	783585039220	HBL2721

Listings

Listed to UL 498
 Fed.Spec. W-C-596
 Certified to CSA C22.2 No.42

Specifications

Housing / Cord Clamp	Nylon
Terminal Retainer	Clear polycarbonate
Blades	Brass
Terminal Screws	#10-32 Brass (Phillips / Slotted / Robertson)
Terminal Clamp	Cold rolled steel – nickel plated
Assembly Screws	Steel - nickel plated

Performance

Electrical

Current Interrupting	Certified for current interrupting at full rated current
Dielectric Voltage	Withstands 2,000V minimum

Mechanical

Terminal Accommodation	#16 AWG - #8 AWG stranded copper wire only.
------------------------	---

Terminal Identification	Terminals identified in accordance with UL 498
-------------------------	--

Environmental

Flammability	HB or better per UL94/CSA 22.2 No.0.17
Moisture Resistance	IP20 Suitability
Operating Temperatures	Maximum Continuous 75°C; Minimum -40°C (w/o impact)



30A 3Ø 250V AC
 NEMA L15-30P
 UL/CSA
 3 HP

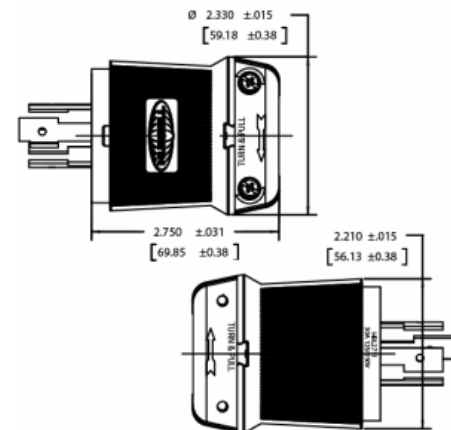

Accessories

Connector	HBL2723
Single Receptacle	HBL2720
Flanged Receptacle	HBL2726
Weatherproof Boot	HBL6035

Resources

Customer Use Drawing
 eCatalog

Dimensions in Inches (mm)

Hubbell Wiring Device-Kellems • Hubbell Incorporated (Delaware) • 40 Waterview Drive • Shelton, CT 06484

Phone (800) 288-6000 • Fax (800) 255-1031 • Specifications subject to change without notice.

