

Accessories and Modification Codes

Side-Mounted Auxiliary Contact

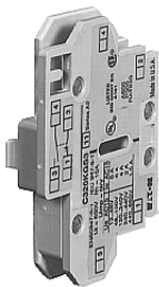

Auxiliary Contact



Type 1 Enclosure



Electrically Held Base Contactor



Surge Suppressor



15.1 Accessories

Freedom NEMA	V10-T15-2
A200 NEMA	V10-T15-18
XT IEC	V10-T15-23
Enclosures	V10-T15-28
Lighting Contactors	V10-T15-30
IT Solid-State Soft Starters	V10-T15-36

15.2 Modification Codes

Modification Codes	V10-T15-39
--------------------------	------------

Freedom NEMA

Auxiliary Contacts

NEMA Sizes 00–2

The auxiliary contacts listed below are designed for installation on Freedom Series starters and contactors. Snap-on design facilitates quick, easy installation.

These bifurcated design contact blocks, featuring silver cadmium alloy contacts, are well suited for use in very low energy (logic level) circuits.

Product Selection

Side-Mounted

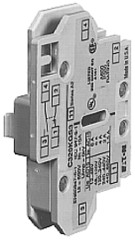

Top-Mounted



Description	Contact Configuration Code ^①	Catalog Number
Side-Mounted		
1NO	10	C320KGS1
1NC	01	C320KGS2
1NO-1NC	11	C320KGS3
2NO	20	C320KGS4
2NC	02	C320KGS5
1NO-1NCI	N/A	C320KGS6
1NO (EC)-1NC (LO)	N/A	C320KGS7
1NCI	N/A	C320KGS8
Top-Mounted		
1NO	10	C320KGT1
1NC	01	C320KGT2
1NO-1NC	11	C320KGT3
2NO	20	C320KGT4
2NC	02	C320KGT5
1NO-1NCI	N/A	C320KGT6
1NO (EC)-1NC (LO)	N/A	C320KGT7
1NCI	N/A	C320KGT8
3NO	30	C320KGT9
2NO-1NC	21	C320KGT10
1NO-2NC	12	C320KGT11
3NC	03	C320KGT12
4NO	40	C320KGT13
3NO-1NC	31	C320KGT14
2NO-2NC	22	C320KGT15
1NO-3NC	13	C320KGT16
4NC	04	C320KGT17
3NO-1NCI	N/A	C320KGT18
2NO-1NCI-1NC	N/A	C320KGT19
2NO-1NO (EC)-1NC (LO)	N/A	C320KGT20
1NO-1NC-1NO (EC)-1NC (LO)	N/A	C320KGT21

Notes

NCI = Normally Closed early opening designed for use in reversing applications. EC = Early Closing. LO = Late Opening.

^① For reference only—not part of catalog number. See **Page V10-T15-3**.

Contact Configuration Code

This two-digit code is found on the auxiliary contact to assist in identifying the specific contact configuration.

The first digit indicates the quantity of NO contacts and the second indicates the quantity of NC contacts.

NEMA Sizes 3–8

Product Selection

Circuit	Contact Configuration Code ^①	NEMA Size	Catalog Number
Base Auxiliary Contact			
Base Auxiliary Contacts—NEMA Sizes 3–5			
NO	10	3	C320KGS31
NO-NC	11	3	C320KGS32
NO	10	4–5	C320KGS42
NO-NC	11	4–5	C320KGS42
Auxiliary Contact			
Auxiliary Contacts—NEMA Sizes 3–5			
NO	10	3–5	C320KGS20
NC	01	3–5	C320KGS21
NO-NC ^②	11	3–5	C320KGS22
Auxiliary Contacts—NEMA Sizes 6–8			
NO-NC	11	8	C320KA5
2NO-2NC	22	6–7	C320KA6

Auxiliary Contact Ratings (Amperes)

Ratings—NEMA A600

Current	AC Volts			
	120V	240V	480V	600V
Make and interrupting	60	30	15	12
Break	6	3	1.5	1
Continuous	10	10	10	10

Ratings—NEMA P300

DC Volts	Make/Break Amperes
Continuous Thermal Rating: 5A	
125	1.10
250	0.55

Ratings—Logic Level

Current	Rating
Minimum Ratings for Logic Level and Hostile Atmosphere Application	
Minimum amperes	20 mA
Minimum volts	24 Vac/Vdc

Ratings—C320KGS20L, C320KGS21L, C320KGS22L

DC-12		AC-12	
U_e	I_e	U_e	I_e
80	0.1	250	0.1

Notes

^① For reference only—not part of catalog number. See above.

^② NO-NC occupies two positions—L2 and L3, or R2 and R3. See **Page V10-T15-5**.

15.1

Accessories and Modification Codes

Accessories

Auxiliary Contact Location

NEMA Sizes 00–2

The sketches below illustrate the maximum number of auxiliary contacts that can be

assembled to a contactor or starter and their locations.

Auxiliary Contacts

Size	Poles	Available Mounting Positions ①②		Catalog Number
		Open Type	Enclosed	
00	3	T1, L1, R1	L1	AN16
0–2	3	T1, L1	L1	
00–2	3	T1, T2	—	AN56
00	2–4	T1, L1, R1	L1	CN15
0–2	2–3	T1, L1	L1	
1, 2	4	T1, L1	—	
1, 2	5	T1, L1	—	
10A	2–4	T1, L1, R1	L1	CN35
20–60A	2–3	T1, L1	L1	
60A	4	T1, L1	—	
60A	5	T1, L1	—	
00–2	3	T1, T2	—	CN55

Auxiliary Contact Location

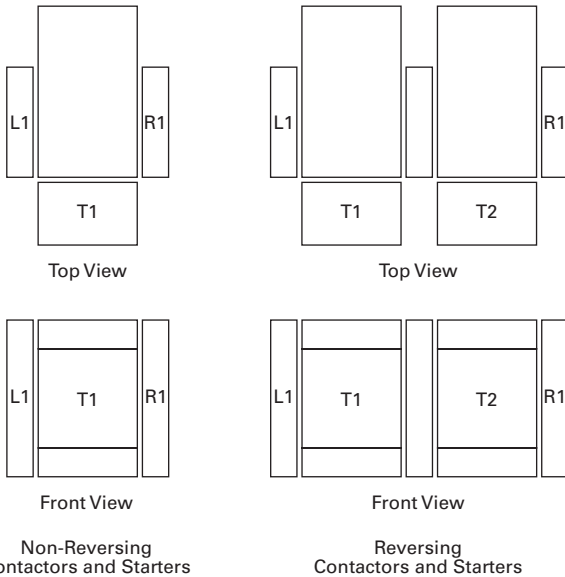

Notes

- ① Available positions on contactors or starters other than what is factory installed.
- ② When a pneumatic timer is mounted on contactor, only side-mounted auxiliary contact positions are available. The solid-state timer, when added, takes up side-mounted auxiliary contact position.

NEMA Sizes 3–8

The sketches below illustrate the maximum number of auxiliary contacts that can be assembled to a contactor and their locations.

Note: A base auxiliary contact must be added in position R1 before additional auxiliary contacts can be mounted on NEMA Size 3 or in L1 on NEMA Sizes 4–5.

Mounting Positions

Size	Available Mounting Positions ^①
NEMA Size 3	R2, R3, L1, L2, L3
NEMA Sizes 4–5	L2, L3, R1, R2, R3
NEMA Sizes 6–7	R1
NEMA Size 8	L2, R2

Auxiliary Contact Location

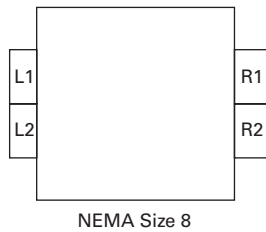
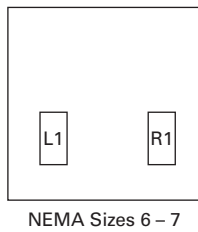
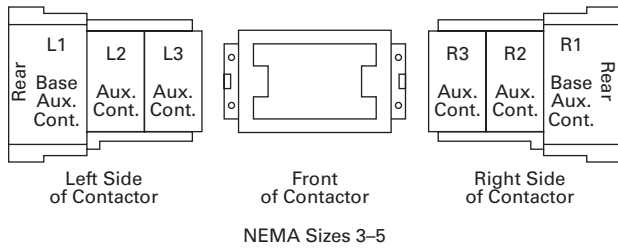

Note

① Available positions on contactors or starters other than what is factory installed.

Heater Pack Selection

Heater packs H2001B to H2017B and H2101B to H2117B are to be used only with Series B overload relays Catalog Numbers C306DN3B (Part No. 10-7016) and C306GN3B (Part No. 10-7020). The load lugs are built into the overload relay base to allow load wiring prior to heater pack installation. The

previous heater design had integral load lugs. The Series B heater packs are electrically equivalent to the previous heater design. Heaters H2018-3 to H2024-3 have not changed.

Note: The series of a starter is the last digit of the listed catalog number. Example: AN16DN0A**B**.

Starters with Series B Overload Relays

Size	Series
NEMA—AN Type	
00-0	C
1-2	B
5	B
6	C
7-8	B

Fast Trip—Class 10 Heater Selection

Overload Relay Size	Motor Full Load Ampere Rating Dial Position				Catalog Number (Includes Three Heater Packs) ①
	A	B	C	D	
For Use with NEMA Sizes 00-0 Series C, NEMA Sizes 1-2 Series B					
32A or 75A	0.260	0.313	0.367	0.420	H2101B-3
	0.384	0.464	0.543	0.623	H2102B-3
	0.570	0.688	0.806	0.924	H2103B-3
	0.846	1.02	1.20	1.37	H2104B-3
	1.28	1.55	1.83	2.10	H2105B-3
	1.92	2.33	2.74	3.15	H2106B-3
	2.30	2.79	3.28	3.77	H2107B-3
	3.38	4.10	4.82	5.54	H2108B-3
	7.07	6.03	7.09	8.16	H2109B-3
	7.07	8.58	10.1	11.6	H2110B-3
	9.60	11.2	12.8	14.4	H2111B-3
	14.4	17.5	20.7	23.8	H2112B-3
	18.7	21.8	25.0	28.1	H2113B-3
23.5	27.3	31.0	34.8	H2114B-3	
For Use with NEMA Size 2—Series B					
75A	28.3	32.6	37.0	41.3	H2115B-3
	36.6	42.3	48.1	53.8	H2116B-3
	53.8	60.8	67.9	74.9	H2117B-3
For Use with Size 5 Starters Only—Series B					
32A ②	51	61	72	82	H2104B-3
	77	93	110	126	H2105B-3
	115	140	164	189	H2106B-3
	138	167	197	226	H2107B-3
	203	246	289	—	H2108B-3
For Use with Size 6 Starters Only—Series B					
32A ②	154	186	220	252	H2105B-3
	230	280	329	378	H2106B-3
	276	335	394	452	H2107B-3
	406	492	578	—	H2108B-3
For Use with Size 7 Starters Only—Series B					
32A ②	169	204	240	274	H2104B-3
	256	310	366	420	H2105B-3
	384	466	543	630	H2106B-3
	460	558	656	754	H2107B-3
	676	820	—	—	H2108B-3
For Use with Size 8 Starters Only—Series B					
32A ②	254	306	360	411	H2104B-3
	384	465	549	630	H2105B-3
	576	699	822	945	H2106B-3
	690	837	984	1131	H2107B-3
	1014	1230	—	—	H2108B-3

Notes

- ① Heater packs are shipped three to a carton. Catalog numbers are for three heater packs.
- ② Sizes 5-8 use the 32A overload relay with current transformers.

Standard Trip—Class 20 Heater Selection

Overload Relay Size	Motor Full Load Ampere Rating Dial Position				Catalog Number (Includes Three Heater Packs) ①
	A	B	C	D	
For Use with NEMA Sizes 00–0 Series C, NEMA Sizes 1–2 Series B					
32A or 75A	0.254	0.306	0.359	0.411	H2001B-3
	0.375	0.452	0.530	0.607	H2002B-3
	0.560	0.676	0.791	0.907	H2003B-3
	0.814	0.983	1.15	1.32	H2004B-3
	1.20	1.45	1.71	1.96	H2005B-3
	1.79	2.16	2.53	2.90	H2006B-3
	2.15	2.60	3.04	3.49	H2007B-3
	3.23	3.90	4.56	5.23	H2008B-3
	4.55	5.50	6.45	7.40	H2009B-3
	6.75	8.17	9.58	11.0	H2010B-3
	9.14	10.8	12.4	14.0	H2011B-3
	14.0	16.9	19.9	22.8	H2012B-3
	18.7	22.7	26.7	30.7	H2013B-3
	23.5	28.5	33.5	38.5	H2014B-3
For Use with NEMA Size 2—Series B					
75A	29.0	34.0	39.1	44.1	H2015B-3
	39.6	45.5	51.5	57.4	H2016B-3
	53.9	60.9	67.9	74.9	H2017B-3
For Use with NEMA Sizes 3–4—Series A					
105A or 144A	8.0	9.2	10.3	11.5	H2025-3
	11.4	12.8	14.3	15.7	H2026-3
	14.3	15.7	17.4	19.0	H2027-3
	18.0	20.2	22.3	24.5	H2018-3
	24.6	27.6	30.5	33.4	H2019-3
	33.5	37.5	41.5	45.6	H2020-3
	45.7	51.2	56.7	62.1	H2021-3
	62.2	69.7	77.1	84.6	H2022-3
	84.7	95.0	105.0	115.0	H2023-3
	106.0	118.0	131.0	144.0	H2024-3
For Use with Size 5 Starters—Series B					
32A ②	49	59	69	79	H2004B-3
	72	87	103	118	H2005B-3
	107	130	152	174	H2006B-3
	129	156	182	209	H2007B-3
	194	234	274	—	H2008B-3
For Use with Size 6 Starters Only—Series B					
32A ②	144	174	205	235	H2005B-3
	215	259	304	348	H2006B-3
	258	312	365	419	H2007B-3
	388	468	547	627	H2008B-3
For Use with Size 7 Starters Only—Series B					
32A ②	163	197	230	264	H2004B-3
	240	290	342	392	H2005B-3
	358	432	506	580	H2006B-3
	430	520	608	698	H2007B-3
	646	780	912	—	H2008B-3
For Use with Size 8 Starters Only—Series B					
32A ②	244	295	345	396	H2004B-3
	360	435	513	588	H2005B-3
	537	648	759	870	H2006B-3
	645	780	912	1047	H2007B-3
	969	1170	1368	—	H2008B-3

Notes

① Heater packs are shipped three to a carton. Catalog numbers are for three heater packs.

② Sizes 5–8 use the 32A overload relay with current transformers.

DC Magnet Coils

When Ordering Specify

Conversion Kit for Field Assembly

- Catalog number

Factory Installed DC Coil

- For factory installed DC magnet coil on AC contactors or non-combination starters (open type only), substitute the code suffix from table below for the magnet coil identifier in the device catalog number.

Example: For Size 0 AC contactor with a 24 Vdc coil, change CN15BN3AC to CN15BN3T1C

Application

- Connect for separate control
- Not for use with cover control switch operators
- Use twin break, heavy-duty pilot devices
- Designed for +10%, -20% rated voltage, continuous duty operation

Non-Reversing Kit Consists of:

- One encapsulated DC magnet coil
 - One NCI or NO/NCI side-mounted auxiliary contact
- Note:** These kits are supplied with a NO/NCI side-mounted auxiliary contact in place of the NCI contact.
- Two blue colored connection wires
 - One instruction publication

Operation

These DC coil kits have separate pickup and seal windings. A **special** (side-mounted) early-break NCI auxiliary contact is used to either disconnect the pickup winding or insert the seal winding in series with the pickup winding, depending on the frame size of the contactor. DC coil kits come in two styles, a suffix **1** and a suffix **4**. The 1 suffix contains only the **special** (side-mounted) early break NCI auxiliary contact. The 4 suffix contains a NO contact in the same package as the **special** (side-mounted) early-break NCI auxiliary contact.

Note: NEMA Sizes 00 and 0 contactors may use either suffix 1 or 4 DC coil kits; starters

may use suffix 4 DC coil kits only. For NEMA Sizes 1 and 2, both contactors and starters may use a suffix 4 DC coil kit only.

On the above sizes only, when the **special** auxiliary package is mounted on the side of a contactor or starter, **no** standard auxiliary contact may be mounted on the same side.

Note: For NEMA Sizes 3–5, the special coil NCI clearing contact is an add-on auxiliary (**must** mount on a base mount auxiliary contact; normally a 1NO). This arrangement will normally account for two of the three contact positions on the side of each contactor or starter.

See figure on **Page V10-T15-9**.

Product Selection

Contactor or Starter Size	Conversion Data				NCI Interlock Number	Factory Installed Code Suffix	Complete Conversion Kit	
	NEMA	Volts	Magnet Coil Coil Number	Amps P.U./Seal			Watts P.U./Seal	Ship Wt. Lbs (kg)
Non-Reversing — Kit includes NCI Side-Mounted Auxiliary Contact								
00 and 0 CN35-A, B, D D15 relays	12	9-2988-11	6.4/0.28	76.8/3.36	C320KGD1	R1	1.0 (0.5)	C335KD3R1
	24	9-2988-12	3.2/0.14	76.8/3.36	C320KGD1	T1		C335KD3T1
	48	9-2988-13	1.6/0.07	76.8/3.36	C320KGD1	W1		C335KD3W1
	120	9-2988-14	0.64/0.028	76.8/3.36	C320KGD1	A1		C335KD3A1
① 00 and 0 CN35-A, B, D D15 relays	12	9-2988-11	6.4/0.28	76.8/3.36	C320KGD2 ①	R4	1.0 (0.5)	C335KD3R4
	24	9-2988-12	3.2/0.14	76.8/3.36	C320KGD2 ①	T4		C335KD3T4
	48	9-2988-13	1.6/0.07	76.8/3.36	C320KGD2 ①	W4		C335KD3W4
	120	9-2988-14	0.64/0.028	76.8/3.36	C320KGD2 ①	A4		C335KD3A4
1 and 2 CN35-G	12	9-2990-1	15.4/0.42	185/4.98	C320KGD5	R4	1.0 (0.5)	C335KD4R4
	24	9-2990-2	7.7/0.21	185/4.96	C320KGD5	T4		C335KD4T4
	48	9-2990-3	3.9/0.11	185/5.04	C320KGD5	W4		C335KD4W4
	120	9-2990-4	1.5/0.041	185/4.87	C320KGD5	A4		C335KD4A4
3 CN35-K	12	9-3002-1	24/0.40	293/4.84	C320KGD3	R1	2.0 (0.9)	C335KD5R1
	24	9-3002-2	12/0.20	288/4.75	C320KGD3	T1		C335KD5T1
	48	9-3002-3	6.1/0.097	295/4.67	C320KGD3	W1		C335KD5W1
	120	9-3002-4	2.5/0.038	298/4.57	C320KGD3	A1		C335KD5A1
4 and 5 CN35-N, S	24	9-2026-4	18/0.22	400/5.3	C320KGD3	T1B	2.5 (1.1)	C335KA3T1
	48	9-2026-3	9/0.11	400/5.2	C320KGD3	W1B		C335KA3W1
	120	9-2026-2	3.3/0.05	450/5.4	C320KGD3	A1B		C335KA3A1
	240	9-2026-1	1.7/0.02	440/4.9	C320KGD3	B1B		C335KA3B1

Note

① These kits are supplied with a NO/NCI side-mounted auxiliary contact in place of the NCI contact.

Product Selection, continued

Contactor or Starter Size	Conversion Data				NCI Interlock Number	Factory Installed Code Suffix	Complete Conversion Kit	
	Volts	Magnet Coil Coil Number	Amps P.U./Seal	Watts P.U./Seal			Ship Wt. Lbs (kg)	Catalog Number
NEMA	Volts	Coil Number	Amps P.U./Seal	Watts P.U./Seal	NCI Interlock Number	Factory Installed Code Suffix	Ship Wt. Lbs (kg)	Catalog Number
Reversing								
00 and 0 CN35-A, B, D D15 relays	12	9-2988-1	6.4/0.28	76.8/3.36	C320KGD1	R1 ①	1.0 (0.9)	C335KD3R1 ②
	24	9-2988-2	3.2/0.14	76.8/3.36	C320KGD1	T1 ①		C335KD3T1 ②
	48	9-2988-3	1.6/0.07	76.8/3.36	C320KGD1	W1 ①		C335KD3W1 ②
	120	9-2988-4	0.64/0.028	76.8/3.36	C320KGD1	A1 ①		C335KD3A1 ②
1 and 2 CN35-G	12	9-2990-1	15.4/0.42	185/4.98	C320KGD3	R1 ①	—	③
	24	9-2990-2	7.7/0.21	185/4.96	C320KGD3	T1 ①		③
	48	9-2990-3	3.9/0.11	185/5.04	C320KGD3	W1 ①		③
	120	9-2990-4	1.5/0.041	185/4.87	C320KGD3	A1 ①		③

Elementary Diagrams

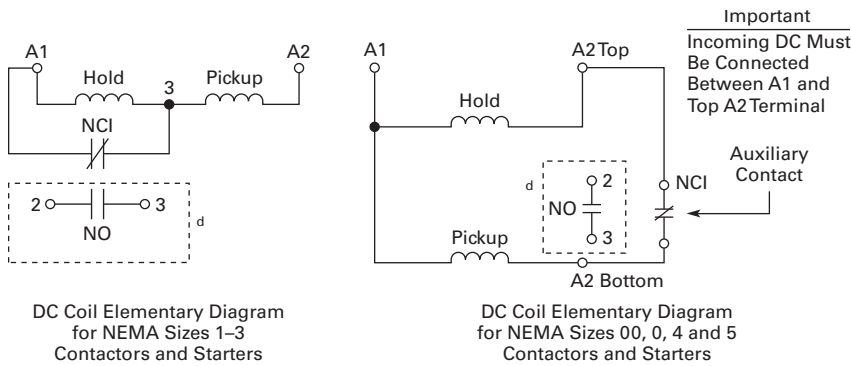

Notes

- ① Factory installed DC coils on NEMA contactors and starters include a NO/NC top-mounted auxiliary contact on each contactor for electrical interlocking.
- ② Kit does not include mechanical interlock or crossover wiring. Two NO/NCI top-mounted auxiliary contacts are supplied for electrical interlocking.
- ③ Available factory assembled only.
- ④ 1NO available in suffix 4 kits only.

15.1 Accessories and Modification Codes

Accessories

Remote Reset Module (32A Overload Relay)

The C316RR remote reset module for the C316F, C316S and C316U overload relays allows remote resetting of tripped (32A) overload relays by means of an electrical solenoid attachment that mounts on the side of the overload relay.

Product Selection

Remote Reset Module Operating Voltage	Catalog Number
24V 50/60 Hz	C316RR1U
110V 50/60 Hz	C316RR1A

Dimensions

Approximate Dimensions in Inches (mm)

Note: The operating coil is not suitable for a continuous duty. Recommended impulse duration 0.2–0.35 seconds with 15 operations maximum per hour.

Remote Reset Module

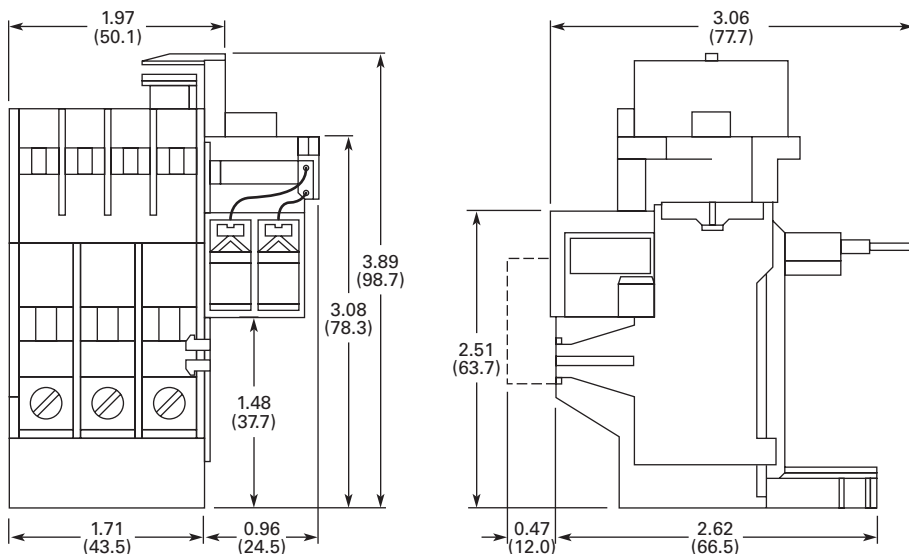

Three-Pole Top-Mounted Fuse Block Kit

NEMA Sizes 00–2

Field mount to Freedom Series starters and contactors. Designed to save space and reduce installation costs. They provide short-circuit protection for branch circuits.

Mounted Fuse Block Kit

Fuse Block Kit

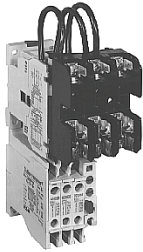

Fuse Block Kits

Fuse Type	Catalog Number	Fuse Type	Catalog Number
Class H — 30A 250V	C350KH21	Class T — 60A 300V	C350KT32
Class R — 30A 250V	C350KR21	Class J — 30A 600V	C350KJ61
Class G — 15A 300V	C350KG37	Class J — 60A 600V	C350KJ62
Class G — 20A 300V	C350KG38	Type M — 30A 600V ①	C350KM61
Class G — 30A 300V	C350KG31	Class CC — 30A 600V	C350KC63
Class G — 60A 300V	C350KG32	Class T — 30A 600V	C350KT61
Class T — 30A 300V	C350KT31	Class T — 60A 600V	C350KT62

Dimensions

Approximate Dimensions in Inches (mm)

Mounted Fuse Block

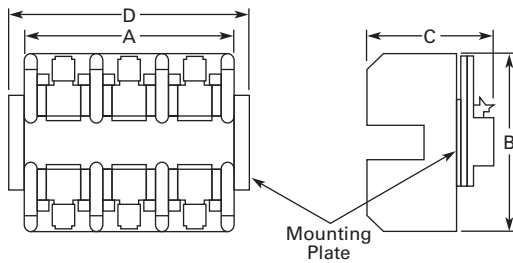

Fuse Block

Class	Amperes	Volts	Wide A	High B	Deep C	D
G	15, 20, 30	300	2.40 (61.0)	3.00 (76.2)	2.04 (51.8)	—
	60	300	2.62 (66.5)	4.25 (108.0)	2.08 (52.8)	—
H	30	250	3.00 (76.2)	3.10 (78.7)	2.23 (56.6)	3.62 (91.9)
J	30, 60	600	4.81 (122.2)	4.12 (104.6)	2.82 (71.6)	—
M, CC	30	600	2.40 (61.0)	3.00 (76.2)	2.04 (51.8)	—
R	30	250	3.00 (76.2)	3.10 (78.7)	2.23 (56.6)	3.62 (91.9)
T	30, 60	300	3.44 (87.4)	3.00 (76.2)	2.33 (59.2)	—
	30	600	3.75 (95.3)	3.31 (84.1)	2.26 (57.4)	—
	60	600	4.87 (123.7)	3.00 (76.2)	2.58 (65.5)	—

Note

① Type M fuse block not approved for branch circuit protection.

Mechanical Interlock and Reversing Kits

Mechanical interlocks and reversing kits are designed for field assembly of reversing contactors or starters from Freedom Series components. The reversing kits include a mechanical

interlock, stabilizer bar and a pre-cut, trimmed and formed wire set. Auxiliary contacts, if required, must be ordered separately. See **Page V10-T15-2**.

Mechanical Interlock



Mechanical Interlock Only ①②

Application		
NEMA Size	Contactors Mounting	Catalog Number
00-2	Horizontal	C321KM60B
3	Horizontal	C321KM30
3 to 4	Horizontal	C321KM43
4	Horizontal	C321KM40
4 to 5	Horizontal	C321KM45
4 to 6	Horizontal	C321KM80
5	Horizontal	C321KM50
5 to 6	Horizontal	C321KM56
6	Horizontal	C321KM70
6 to 7	Horizontal	C321KM90
7	Horizontal	C321KM34
4 or 5 to 6	Vertical	C321KM55
5 to 6	Vertical	C321KM65
6	Vertical	C321KM66
6 to 7	Vertical	C321KM67

Reversing Kits (Horizontal Contactor Mounting Only)

Application		Application	
NEMA Size	Catalog Number	NEMA Size	Catalog Number
00	C321KM60K14B	—	C321KM60K21 ③
0	C321KM60K13B	—	C321KM60K18 ③
1	C321KM60K15B	4	C321KM60K19 ③
2	C321KM60K16B	5	C321KM60K20 ③
3	C321KM60K17 ③	—	C321KM60K44 ③

Solid-State Timers

Solid-State ON DELAY Timer—Side-Mounted on Freedom Series NEMA 00-2 and C25D, C25E and C25F Frame

This timer is designed to be **wired in series with the load** (typically a coil). When the START button is pushed (power applied to timer), the

ON DELAY timing function starts. At the completion of the set timing period, timer and series wired load will both be energized.

Solid-State Timer



Mounted Timer Product Selection

Timing Range	Catalog Number ④⑤⑥
0.1-1.0 seconds	C320TDN1_
1-30 seconds	C320TDN30_
30-300 seconds	C320TDN300_
5-30 minutes	C320TDN2000_

Pneumatic Timers—Top-Mounted

Attachment mounts on top of any NEMA Size 00-2 Freedom Series starter or contactor (top-mounted auxiliary contacts can not be installed on device when timer

is used). Timer unit has 1NO-1NC isolated timed contacts—circuits in each pole must be the same polarity. Units are convertible from OFF to ON DELAY or vice-versa.

Pneumatic Timer



Product Selection

Timing Range	Catalog Number
0.1-30 seconds	C320TP1
10-180 seconds	C320TP2

Maximum Ampere Ratings

Description	Volts AC			
	120	240	480	600
Make	30	15	7.5	6
Break	3	1.5	0.75	0.6

Notes

- ① Without cross-wiring.
- ② For use with latest series product.
- ③ Kit includes two NC auxiliary contacts.
- ④ Add operating voltage suffix to catalog number. **A** = 120V, **B** = 240V, **E** = 208V.
- ⑤ Rated 0.5A pilot duty—not to be used on larger contactors.
- ⑥ Terminal connections are quick connects only. Two per side.

Locking Cover for Overload Relay—C306 Only

Snap-on transparent or opaque plastic panel for covering access port to the overload relay trip setting

dial—helps prevent accidental or unauthorized changes to trip and reset setting.

Locking Cover



Product Selection

Description	Minimum Ordering Qty. (Std. Pkg.)	Catalog Number
Clear cover, no accessibility	50	C320PC3
Gray cover, no accessibility, with auto only nib	50	C320PC4
Gray cover, no accessibility, with manual only nib	50	C320PC5
Gray cover with FLA dial accessibility, A, B, C, D positions and auto only nib	50	C320PC6
Gray cover with FLA dial accessibility, A, B, C, D positions and manual only nib	50	C320PC7

Control Circuit Fuse Block

These panel mounted fuse holders, designed for control circuit protection or other similar low current requirements, have extractor type fuse caps. The Class CC rejection type fuses (KTK-R) used in these holders are intended for use with

equipment designated as being suitable for use on systems having high available fault currents. If branch circuit protective device is 45A or greater, C320FBR fuse kit may be required for control circuit protection per NEC 430-72.

Control Circuit Fuse Block



Product Selection

Type	Maximum Amperes	Catalog Number
Fuse holder only	15	C320FB ①
	30	C320FBR ②

Dimensions

Approximate Dimensions in Inches (mm)

Control Circuit Fuse Block

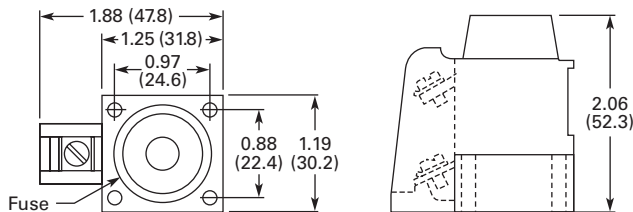

Transient Suppressor Kits

NEMA Sizes 00–2

These kits limit high voltage transients produced in the control circuit when power is removed from the contactor or starter coil. There are three separate suppressors for use on 24–120V, 208–240V or 277–480V coils respectively.

These devices mount directly to the coil terminals of Freedom Series contactors or starters NEMA Sizes 00–2 and lighting contactors 10–60A. Reversing devices will require two.

Transient Suppressor NEMA Sizes 00–2



Product Selection

Description	Coil Voltage 50/60 Hz ③	Catalog Number
Transient suppressor	24–120V	C320TS1
	208–240V	C320TS2
	277–480V	C320TS3

NEMA Sizes 3–5

This device mounts on top of any side-mounted auxiliary contact on Freedom Series NEMA Sizes 3–5 and lighting contactors 100–300A. It connects across coil terminals on any 120V contactor or starter magnet

coil (reversing starters or contactors require 2).

Limits high voltage transients produced in the circuit when power is removed from the coil.

Transient Suppressor NEMA Sizes 3–5



Product Selection

Description	Coil Voltage	Catalog Number
Transient suppressor	120V	C320AS1

Shorting Bar Kits

These kits provide phase-to-phase power connections of contactors for field assembly. The kits include bus

connections and mounting hardware. The shorting bars connect all three phases of a single contactor.

Product Selection

Description	Catalog Number	Description	Catalog Number
NEMA Size 3	C321SB18	NEMA Size 5	C321SB21
NEMA Size 4	C321SB19	NEMA Size 6	C321SB22

Notes

- ① A fuse is not supplied, but holder will accept a Bussman Type KTK or KTK-R (13/32 in x 1-1/2 in) fuse, 600V maximum.
- ② Includes a 5A, 600V KTK-R fuse.
- ③ Suppressor is compatible with coil voltages/ranges as shown, 50 and 60 Hz.

15.1

Accessories and Modification Codes

Accessories

DC/AC Interface Module

The catalog number C320DC Interface Module is an optically isolated solid-state switch which provides a means of operating AC coils with 5–48 Vdc control signal. It acts as a space saving interposing relay which can switch a specified 50/60 Hz AC source to the contactor or starter coil.

The module may be directly attached to the coil terminals of any Freedom Series contactor or starter—NEMA Sizes 00–3 and lighting contactors 10–100A. It also has provisions for DIN rail mounting.

The module will operate coils within the voltage ranges shown in the table below.

Design Characteristics

- DC Input: 5–48 Vdc at mA nominal
- AC operating voltage: 240 Vac (360 VA) $\pm 10\%$ 50/60 Hz
- DC operating voltage: 30 Vdc maximum (0.5A)
- AC current rating
 - 10A make (inrush)
 - 1A break (sealed)

Controller Coil Voltage Ranges

Controller Catalog Number Prefix	Controller Size or Rating	Coil Range Volts AC
AN16, AN56, CN15, CN55	00–0	24–240
	1–2	48–240
	3	110–240
CN35	10–30A	24–240
	60A	48–240
	100A	110–240

Typical Application

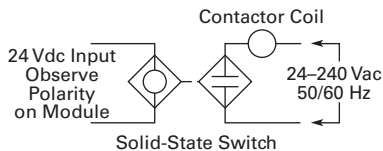

DC/AC Interface Module



Product Selection

Coil Voltage	Catalog Number
5 Vdc	C320DC2V5
6 Vdc	C320DC2V6
9 Vdc	C320DC2V9
12 Vdc	C320DC2V12
48 Vdc	C320DC2V48

Finger Protection Shields

Snap-on shields for both contactors and starters provide Type IP20 finger

protection. Prevents accidental contact with line/load terminals.

Product Selection

Application	Catalog Number
NEMA Size 00	C320LS1
NEMA Size 0	C320LS2
NEMA Sizes 1–2	
Contactors	C320LS3
Reversing contactors	C320LS4
NEMA Size 1	
Starters	C320LS5
Reversing starters	C320LS6
NEMA Size 2	
Starters	C320LS7
Reversing starters	C320LS8

Adapter to DIN Rail Mount

NEMA 1–2 Contactors

Designed to allow DIN rail mounting of NEMA 1–2 contactors. Includes all hardware required to convert contactors from panel mounting to 35 mm DIN rail mounting.

Product Selection

Description	Catalog Number
Adapter to DIN rail mount	C320DN65

Adhesive Dust Cover

NEMA Sizes 00–2

These adhesive stickers come 25 to a package and provide extra protection from contaminants when applied to the sides of Freedom NEMA Sizes 00–2.

Adhesive covers are easily applied to side opening where auxiliaries are not installed and provide extra protection from metal filings and other debris.

Product Selection

Description	Catalog Number
25 to a package	C320DSTCVR

Add-On Power Pole Kit

NEMA Sizes 00–2

This device mounts on the side of Freedom NEMA Size 00–2 contactors. One unit can be mounted on each side and carries UL, cUL and IEC ratings. The device is rated for resistive, inductive and lighting applications.

Product Selection—Add-On Power Pole Kit

UL Ampere Rating				IEC 947 Ampere Rating					
Inductive 600V	Resistive 600V	hp Single-Phase		Locked Rotor 240V	Lighting Ballast Tungsten 480V	AC-1 600V	AC-3 600V	AC-5a AC-5b 480V	1NO Power Pole Catalog Number
		115V	230V						
15	20	1/2	2	96	20	20	12	18	C320PPD10

Fuse Clips

C351 Fuse Clip Kit



C351—Fuse Clip Selection—Three Poles

Starter Size	Motor Voltage	Maximum hp (Three-Phase) Dual Element Fuses	Fuse Clip Rating		Fuse Clip Kit Factory Installed Position 10 Alpha ^①	Fuse Clip Kit for Field Installation in Non-Fusible Starter For Non-Rejection Type Fuses		For Use with "R" Rejection Type Fuses	
			Amperes	Volts		Catalog Number	Catalog Number		
Non-Fusible—without Fuse Clips Installed						A			
0	200/230	3	30	250	B	C351KC21	C351KC21R		
	460/575	5	30	600	C	C351KD22-61	C351KD22-61R		
1	200/230	7-1/2	30	250	B	C351KC21	C351KC21R		
	460/575	10	30	600	C	C351KD22-61	C351KD22-61R		
2	200	10	60	250	D	C351KD22-61	C351KD22-61R		
	230	15	60	250	D	C351KD22-61	C351KD22-61R		
	460/575	25	60	600	E	C351KD62	C351KD62R		
3	200	25	100	250	F	C351KE23-63 ^②	C351KE23-63 ^②		
	230	30	100	250	F	C351KE23-63 ^②	C351KE23-63 ^②		
	460/575	50	100	600	G	C351KE23-63 ^②	C351KE23-63 ^②		
4	200	40	200	250	H	C351KF24-64 ^②	C351KF24-64 ^②		
	230	50	200	250	H	C351KF24-64 ^②	C351KF24-64 ^②		
	460/575	100	200	600	J	C351KF24-64 ^②	C351KF24-64 ^②		
5	200	75	400	250	K	Not available in kit form	Not available in kit form		
	230	100	400	250	K				
	460/575	200	400	600	L				

Notes

- ① These fuse clips are for Class R fuses.
 - ② Fuse clip "R" rejection members for use with Class R fuses are supplied loose in the fuse clip kits.
- Kits do not include fuses.

Control Power Transformer Kits

These control transformer kits provide a convenient on-the-job addition of control transformers to the following Type 1, 3R, 4/4X and 12 enclosed starters. Adding or changing these kits does not affect the UL listing in most instances.

The transformer kit consists of:

- Control transformer
- Two primary and one secondary fuse
- Wires
- Mounting instruction publication

For Non-Combination Starters

These kits may be used for transformer voltage conversion on Freedom NEMA starters furnished from the factory with control transformers installed. Non-combination starters with CPTs factory installed are Class ECN07, ECA07, ECE07 and ECE11. These kits may also be installed in oversize enclosures that have been designed to accept transformers.

Combination Starters

Most combination starters have space for standard size (and 100 VA extra capacity) control power transformers. The panels are pre-drilled for mounting.

UL/CSA

UL Listed—File Number E10156, Guide XPTO.

When Ordering Specify

- Catalog number

Standard Transformer Sizes ^①

Size	VA Capacity	
	Freedom	Vacuum
0	50	—
1, 2	100	—
3	150	—
4	200	100
5	200	150
6	250	350

Control Transformer Kits

Control Transformer Kit



Continuous VA	Primary 208/277V Secondary 120V, 60 Hz	Primary 240/480V, 60 Hz 220/440V, 50 Hz Secondary 120V, 60 Hz 110V, 50 Hz	Primary 380V Secondary 110V, 50 Hz	Primary 600V, 60 Hz 550V, 50 Hz Secondary 120V, 60 Hz 110V, 50 Hz	Primary 240/480V Secondary 24V, 60 Hz
	Catalog Number	Catalog Number	Catalog Number	Catalog Number	Catalog Number
50	C341AE	C341AC	C341AL	C341AD	C341AS
75	C341BE	C341BC	C341BL	C341BD	C341BS
100	C341CE	C341CC	C341CL	C341CD	C341CS
150	C341DE	C341DC	C341DL	C341DD	C341DS
200	C341EE	C341EC	C341EL	C341ED	C341ES
250	C341FE	C341FC	C341FL	C341FD	C341FS
300	C341GE	C341GC	C341GL	C341GD	C341GS
350	C341HE	C341HC	C341HL	C341HD	C341HS
500	C341JE	C341JC	C341JL	C341JD	C341JS

Note

^① Non-reversing, single contactor only.

Dimensions

Approximate Dimensions in Inches (mm)

Open Type—50–500 VA with Fuse Block

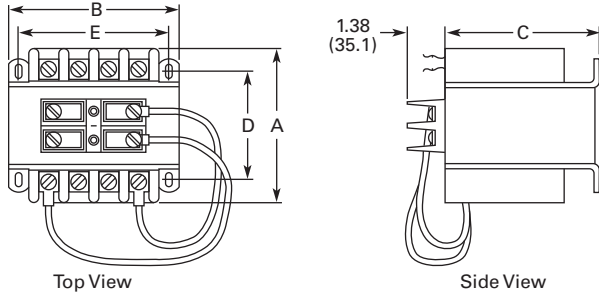

Continuous VA	Wide A	High B	Deep C	Mounting D	E	Slots	Ship Wt. Lbs (kg)
50	3.00 (76.2)	3.00 (76.2)	2.56 (65.0)	2.00 (50.8)	2.50 (63.5)	0.203 x 0.375 (5.2 x 9.5)	3.0 (1.4)
75	3.50 (88.9)	3.00 (76.2)	2.56 (65.0)	2.50 (63.5)	2.50 (63.5)	0.203 x 0.375 (5.2 x 9.5)	4.3 (2.0)
100	3.38 (85.9)	3.38 (85.9)	2.88 (73.2)	2.38 (60.5)	2.81 (71.4)	0.203 x 0.375 (5.2 x 9.5)	4.6 (2.1)
150	4.00 (101.6)	3.75 (95.3)	3.18 (80.8)	2.88 (73.2)	3.12 (79.2)	0.203 x 0.375 (5.2 x 9.5)	7.0 (3.2)
200	4.00 (101.6)	4.50 (114.3)	3.81 (96.8)	2.50 (63.5)	3.75 (95.3)	0.203 x 0.375 (5.2 x 9.5)	7.7 (3.5)
250	4.38 (111.3)	4.50 (114.3)	3.81 (96.8)	2.88 (73.2)	3.75 (95.3)	0.203 x 0.375 (5.2 x 9.5)	10.0 (4.5)
300	4.75 (120.7)	4.50 (114.3)	3.81 (96.8)	3.25 (82.6)	3.75 (95.3)	0.203 x 0.375 (5.2 x 9.5)	13.0 (5.9)
350	5.25 (133.4)	4.50 (114.3)	3.81 (96.8)	3.75 (95.3)	3.75 (95.3)	0.203 x 0.375 (5.2 x 9.5)	14.0 (6.4)
500	5.50 (139.7)	5.25 (133.4)	4.75 (120.7)	4.25 (108.0)	4.38 (111.3)	0.312 x 0.688 (7.9 x 17.5)	18.0 (8.2)

A200 NEMA

Factory Modifications

A200 Factory Modifications

Modification	Description	NEMA Size									Catalog Number Suffix
		00-1	2	3	4	5	6	7	8	9	
Control circuit	1 Extra auxiliary contact (1NO-1NC)										J1
	Non-reversing, reversing	✓	✓	✓	✓	✓	✓	✓	✓	✓	
	Two-speed unwired	✓	✓	✓	✓	✓	✓	✓	✓	✓	
	2 Extra auxiliary contact										J2
	Non-reversing	✓	✓	✓	✓	✓	✓	✓	✓	✓	
	Reversing, two-speed unwired	✓	✓	✓	✓	✓	✓	✓	✓	✓	
	3 Extra auxiliary contact										J3
Non-reversing, unwired	✓	✓	✓	✓	—	—	—	—	—		
4 Extra auxiliary contact										J4	
Non-reversing, unwired	✓	✓	✓	✓	—	—	—	—	—		
	Wired for separate control (NC)	—	—	—	—	—	—	—	—	—	C
	Omit control wiring (NC)	✓	✓	✓	✓	✓	✓	✓	✓	✓	X
Overload relays (substitutions)	Ambient compensated with auto reset (NC)	—	—	—	—	—	—	—	—	—	D
	Fast trip—ambient compensated (specify motor FLA)	✓	✓	✓	✓	✓	✓	—	—	—	D7
	Overload relay alarm contact (NO) per overload	✓	✓	✓	✓	✓	✓	—	—	—	E

Type J Auxiliary Contact

- Capable of being field mounted in a contactor or starter (Classes A200, A900 Sizes 00-6, V200, V201 vacuum and definite purpose controllers)
- Provides two separate electrical contact sets which wire vertically and are color coded; black designates NC and silver designates NO. Please note that the vertical wiring is contrary to the horizontal wiring of the L-56 auxiliary contacts
- Designed to fit within dimensions of starter; no additional panel space is required
- Provides circuit isolation (no polarity restrictions) and single break bifurcated contacts

Auxiliary Contact Ratings

Voltage	Make	Break
NEMA A600		
120-600 Vac	7200 VA	720 VA
72-120 Vac	60A	720 VA
28-72 Vac	60 VA	10A
NEMA R300		
28-300 Vdc	28 VA	28 VA

Auxiliary Contact



Auxiliary Contact Types

Contact Type	Maximum	Catalog Number
1NO and 1NC	4	J11
2NC	4	J02
2NO	4	J20
1 coil clearing NC and 1NO	4	J1C

Heater Selection

General Information on Heater Coil Selection

For maximum motor protection and compliance with Article 430-32 of the National Electrical Code, select heater coils from the tables in this section on the basis of motor nameplate full load current.

When the full load current is unknown, selection may be made on the basis of average full load currents. **Caution—The average ratings could be high or low for a specific motor and therefore**

selection on this basis always involves risk. For fully reliable motor protection, select heater coils on the basis of full load current rating as shown on the motor nameplate.

Heater coils are rated to protect 40°C rise motors, and open and drip-proof motors having a **service factor of 1.15** where the motor and the controller are at the same ambient temperature.

For other conditions:

1. For 50°C, 55°C, 75°C rise motors and **enclosed motors having a service factor of 1.0, select one size smaller coil.**
2. Ambient temperature of controller lower than motor by 26°C (47°F), use one size smaller coil.
3. Ambient temperature of controller higher than motor by 26°C (47°F), use one size larger coil.

Ultimate tripping current of heater coils is approximately 1.25 times the minimum current rating listed in the tables.

Heater Selection—Type A and B Overload Relays, Sizes 3 and 4

Size Starter	Ambient Compensated Enclosed Starters	Non-Compensating Enclosed Starters	Heater (One Heater per Catalog Number)
	All Applications	Full Load Current of Motor Amps	Catalog Number
For Size 4 Starters	12.8–14.1	11.9–13.0	FH68
	14.2–15.5	13.1–14.3	FH69
	15.6–17.1	14.4–15.9	FH70
	17.2–18.9	16.0–17.4	FH71
	19.0–20.8	17.5–19.1	FH72
	20.9–22.9	19.2–21.1	FH73
	23.0–25.2	21.2–23.2	FH74
	25.3–27.8	23.3–25.6	FH75
	27.9–30.6	25.7–28.1	FH76
	30.7–33.5	28.2–30.8	FH77
For Size 3 Starters	33.6–37.5	30.9–34.5	FH78
	37.6–41.5	34.6–38.2	FH79
	41.6–56.3	38.3–42.6	FH80
	46.4–50	42.7–46	FH81

Size Starter	Ambient Compensated Enclosed Starters	Non-Compensating Enclosed Starters	Heater (One Heater per Catalog Number)
	All Applications	Full Load Current of Motor Amps	Catalog Number
For Size 4 Starters	51–55	47–51	FH82
	56–61	52–56	FH83
	62–66	57–61	FH84
	67–73	62–67	FH85
	74–78	68–72	FH86
	79–84	73–77	FH87
	85–92	78–84	FH88
	93–101	85–91	FH89
	102–110	92–99	FH90
	111–122	100–110	FH91
For Size 3 Starters	123–129	111–122	FH92
	130–133	123–128	FH93
	—	129–133	FH94

Heater Selection—Type A and B Overload Relays, Sizes 5 and 6

Compensated Overload Relay		Heater (One Heater per Catalog Number)
Open Starter	Enclosed Starter	
Full Load Current of Motor (Amps)		Catalog Number
Size 5 (with 300/5 Current Transformers)		
—	—	FH23
118–129	118–129	FH24
130–141	130–141	FH25
142–155	142–155	FH26
156–170	156–170	FH27
171–187	171–187	FH28
188–205	188–205	FH29
206–224	206–224	FH30
225–244	225–244	FH31
245–263	245–263	FH32
264–292	264–292	FH33
293–300	—	FH34

Compensated Overload Relay		Heater (One Heater per Catalog Number)
Open Starter	Enclosed Starter	
Full Load Current of Motor (Amps)		Catalog Number
Size 6 (with 600/5 Current Transformers)		
—	—	FH23
236–259	236–259	FH24
260–283	260–283	FH25
284–310	284–310	FH26
311–340	311–340	FH27
341–374	341–374	FH28
375–411	375–411	FH29
412–448	412–448	FH30
449–489	449–489	FH31
490–527	490–527	FH32
528–585	528–540	FH33
586–600	—	FH34

Note

Size 7 and larger—advise full load current.

15.1

Accessories and Modification Codes

Accessories

Heater Selection—Type A and B Overload Relays, Sizes 0, 1 and 2

Size Starter	Non-Compensated Open Starters and Ambient Comp. Open and Enclosed Starters Block Type Overload Using Three Heaters Full Load Current of Motor (Amps)	Single-Pole Type Overload	Heater (One Heater per Catalog Number) Catalog Number	Non-Compensating Enclosed Starters Block Type Overload Using Three Heaters Full Load Current of Motor (Amps)	Single-Pole Type Overload	Heater Catalog Number
	0.25–0.27	0.29–0.31	FH03	0.24–0.25	0.28–0.30	FH03
	0.28–0.31	0.32–0.35	FH04	0.26–0.28	0.31–0.34	FH04
	0.32–0.34	0.36–0.39	FH05	0.29–0.31	0.35–0.37	FH05
	0.35–0.38	0.44–0.48	FH06	0.32–0.35	0.38–0.42	FH06
	0.39–0.42	0.44–0.48	FH07	0.36–0.39	0.43–0.47	FH07
	0.43–0.46	0.49–0.53	FH08	0.40–0.43	0.48–0.52	FH08
	0.47–0.50	0.54–0.58	FH09	0.44–0.47	0.53–0.56	FH09
	0.51–0.55	0.59–0.64	FH10	0.48–0.51	0.57–0.63	FH10
	0.56–0.62	0.65–0.71	FH11	0.52–0.57	0.64–0.70	FH11
	0.63–0.68	0.72–0.79	FH12	0.58–0.63	0.71–0.77	FH12
	0.69–0.75	0.80–0.87	FH13	0.64–0.70	0.78–0.85	FH13
	0.76–0.83	0.88–0.96	FH14	0.71–0.77	0.86–0.94	FH14
	0.84–0.91	0.97–1.06	FH15	0.78–0.85	0.95–1.03	FH15
	0.92–1.00	1.07–1.16	FH16	0.86–0.93	1.04–1.13	FH16
	1.01–1.11	1.17–1.28	FH17	0.94–1.03	1.14–1.25	FH17
	1.12–1.22	1.29–1.41	FH18	1.04–1.13	1.26–1.38	FH18
	1.23–1.34	1.42–1.55	FH19	1.14–1.25	1.39–1.52	FH19
	1.35–1.47	1.56–1.71	FH20	1.26–1.37	1.53–1.67	FH20
	1.48–1.62	1.72–1.87	FH21	1.38–1.51	1.68–1.83	FH21
	1.63–1.78	1.88–2.06	FH22	1.52–1.65	1.84–2.01	FH22
	1.79–1.95	2.07–2.26	FH23	1.66–1.81	2.02–2.21	FH23
	1.96–2.15	2.27–2.48	FH24	1.82–1.99	2.22–2.43	FH24
	2.16–2.35	2.49–2.72	FH25	2.00–2.19	2.44–2.66	FH25
	2.36–2.58	2.73–2.99	FH26	2.20–2.39	2.67–2.92	FH26
	2.59–2.83	3.00–3.28	FH27	2.40–2.63	2.93–3.21	FH27
	2.84–3.11	3.29–3.60	FH28	2.64–2.89	3.22–3.53	FH28
	3.12–3.42	3.61–3.95	FH29	2.90–3.17	3.54–3.87	FH29
	3.43–3.73	3.96–4.31	FH30	3.18–3.47	3.88–4.22	FH30
	3.74–4.07	4.32–4.71	FH31	3.48–3.79	4.23–4.61	FH31
	4.08–4.39	4.72–5.14	FH32	3.80–4.11	4.62–4.9	FH32
	4.40–4.87	5.15–5.6	FH33	4.12–4.55	5.0–5.5	FH33
	4.88–5.3	5.7–6.2	FH34	4.56–5.0	5.6–6.0	FH34
	5.4–5.9	6.3–6.8	FH35	5.1–5.5	6.1–6.6	FH35
	6.0–6.4	6.9–7.5	FH36	5.6–5.9	6.7–7.3	FH36
	6.5–7.1	7.6–8.2	FH37	6.0–6.6	7.4–8.0	FH37
	7.2–7.8	8.3–9.0	FH38	6.7–7.2	8.1–8.7	FH38
	7.9–8.5	9.1–9.9	FH39	7.3–7.9	8.8–9.7	FH39
	8.6–9.4	10.0–10.8	FH40	8.0–8.7	9.8–10.5	FH40
	9.5–10.3	10.9–11.9	FH41	8.8–9.5	10.6–11.7	FH41
	10.4–11.3	12.0–13.1	FH42	9.6–10.5	11.8–12.7	FH42
	11.4–12.4	13.2–14.3	FH43	10.6–11.5	12.8–14.0	FH43
	12.5–13.5	14.4–15.7	FH44	11.6–12.6	14.1–15.3	FH44
	13.6–14.9	15.8–17.2	FH45	12.7–13.8	15.4–16.6	FH45
	15.0–16.3	17.3–18.9	FH46	13.9–15.1	16.7–18.3	FH46
	16.4–18.0	19.0–20.8	FH47	15.2–16.7	18.4–20.0	FH47
	18.1–19.8	20.9–22.9	FH48	16.8–18.3	20.1–21.9	FH48
	19.9–21.7	23.0–25.2	FH49	18.4–20.2	22.0–23.9	FH49
	21.8–23.9	25.3–27.6	FH50	20.3–22.2	24.0–26.2	FH50
	24.0–26.2	27.7–30.3	FH51	22.3–24.3	26.3–28.8	FH51
	26.3–28.7	30.4–33.3	FH52	24.4–26.6	28.9–31.4	FH52
	28.8–31.4	33.4–36.4	FH53	26.7–29.1	31.5–34.5	FH53
	31.5–34.5	36.5–39.9	FH54	29.2–32.0	34.6–37.9	FH54
	34.6–37.9	40.0–43.9	FH55	32.1–35.2	38.0–41.9	FH55
	38.0–41.5		FH56	35.3–38.5	42.0–45.0	FH56
	41.6–45.0		FH57	38.6–42.3		FH57

SS-56 Surge Suppressor

- Designed to be used with magnetic motor controllers through Size 4 in 120V, 60 Hz control circuit applications where electronic equipment is used
- Steady state coil volts: 120, 60 Hz, rms
- Peak input volts: 169.6, 60 Hz, maximum amplitude
- Maximum ambient temperature: 65°C
- Nominal limiting volts: 270 peak
- Nominal rate of volt rise: 0.5 per ms

SS-56 Surge Suppressor



Surge Suppressor ①

Type Mounting	Kit Catalog Number
Starter	SS-56

F-56 Fuse Block

- Facilitates installation of fuses (15A, 600V max.) in control circuits
- Utilizes Bussman type KTK fuses, or equivalent
- Mounts in same cavity as Type J auxiliary contact
- No tools or mounting hardware needed
- Fuse not included

Fuse Block

Mounting	Kit Catalog Number
Starter	F56
Panel	F56-P

R-56 Interposing Relay

The R-56AA interposing relay is a low energy solid-state device with a single NO solid-state contact. It can be used as a 120 Vac control relay, and will operate on as little as 40 Vac input. Is useful in

applications requiring long control wiring runs where excessive voltage drop would prevent the contactor or relay from energizing. Will operate a Size 4 contactor from 10,000 ft using 18 AWG wire.

Interposing Relay

Type Mounting	Kit Catalog Number
Starter or panel	R56-AA

Mechanical Interlock

- Prevents closing of one member of a reversing or multi-speed contactor until the opposite member is completely open
- Lever type mechanism assures positive action
- Can be factory assembled or field mounted on A200 and A900 starters and contactors

Mechanical Interlock

Contact Arrangement (Number of Poles, Horizontal or Vertical)	Continuous Size	Interlock Catalog Number
3 x 3 horizontal	0, 1	M-33-1B
4 x 4 horizontal	0, 1	M-33-1B
5 x 3 horizontal	0, 1	M-33-1B
All pole combination, vertical	0, 1	M-34-1A
3 x 3 horizontal reversing	2	M-33-2B
3 x 3 vertical reversing	2	M-34-2A
5 x 3 horizontal	2	M-35-2A
4 x 4 horizontal	2	M-36-2A
All pole combination horizontal	3, 4	M-33-3B
All pole combination vertical	3, 4	M-34-3

B3NO Bell Alarm Contact

- Isolated normally open bell alarm contact
- Mounts in Type B block-type overload relay

Bell Alarm Contact

Kit Catalog Number
B3NO-2
B3NO-4 ②

Control Contact Ratings (B600)

AC Volts	Maximum Amperes	
	Make	Break
24–120	30	3.00
121–600	3600 VA	360 VA

Continuous current rating: 5A

Overload Relay Reset Extension

- Used to adjust overload reset rod depth of Class A200 Model J starters and current design overload relays to same dimensions as obsolete B200 starters and overloads identified by suffix **B**, that is **BA13B**

When replacing obsolete B200 device with Class A200 starter and Type B overload, order Style 6710C11H03. No charge.

When replacing obsolete B200 device with Class A200 starter and Type A overload, order Style 1490C15H10. No charge.

Notes

- ① Can be used on Sizes 5 and 6 with 120V coil. Mounting bracket required—order separately. Mounting bracket 177C043G04.
- ② For Size 3 and 4.

15.1

Accessories and Modification Codes

Accessories

Power Pole Kit

- Adds 1NO or 1NC power pole to Size 00–1 A201 Class contactors
- Factory installed or field mountable in load side auxiliary cavities
- 600 Vac
- Continuous current rating of 18A for Size 0, 27A for Size 1

Power Pole Kit ①

Continuous Current Rating	Kit Size	Kit Catalog Number
Normally Open		
18	0	PN0-0
27	1	PN0-1
Normally Closed		
18	0	PNC-0
27	1	PNC-1

Replacement Auxiliary Contacts

Replacement Auxiliary Contacts

Contactor Size	Contact Arrangement	Aux. Elect. Contact	
		Catalog Number	Style Number
5, 6	1NO + 1NC	J11	9084A17G01
	2NO	J20	9084A17G02
	2NC	J02	9084A17G03
7, 8	1NO	—	578D461G01
	1NC	—	578D461G03
9	1NO + 1NC	—	843D943G04
	2NO	—	843D943G05
	2NC	—	843D943G06

Extra Auxiliary Contact Kits

All starters include an auxiliary contact with 1NO and 1NC contact. These kits include an auxiliary contact

with contacts as shown, plus operating arm and mounting bracket when required.

Extra Auxiliary Contact Kits

Contactor Size	Contact Arrangement	Style Number
5, 6	1NO + 1NC	3463D94G18
	2NO	3463D94G04
	2NC	3463D94G19
7, 8 ②	2NO	818D498G06
	1NO	818D498G04

DC Coil Conversion Kits

Kits listed below include all necessary parts to convert from AC to DC control including the DC coil with

built-in diode, rectifier, auxiliary interlock and all mounting hardware.

DC Coil Conversion Kits

Size	Voltage	Kit Style Number
5	110-120	7864A28G01
	220-240	7864A28G02
	440-480	7864A28G03
6	110-120	7864A29G01
	220-240	7864A29G02
	440-480	7864A29G03

Mechanical Interlocks

Mechanical Interlocks

Contactor Sizes	Style Numbers	
	Horizontal	Vertical
3, 4 and 5	2050A11G75	2050A11G65
5 and 5	2050A11G25	2050A11G15
5 and 6	2050A11G27	2050A11G17
6 and 6	2050A11G26	2050A11G16
6 and 7, 8	—	2050A11G55
7, 8 and 7, 8	No (rear conn.)	567D624G01
7, 8 and 9	No (rear conn.)	9944D56G06
9 and 9	No (rear conn.)	9944D56G01

Overload Protection

Overload Protection Size 5 Starters

Type B overload protection is a three-pole, block type, thermal ambient compensated device with manual reset mounted integrally. Current transformers

are enclosed in a protective case and integrally mounted to save panel space. Standard ratio is 300:5.

Overload Protection Size 6 Starters

Overload protection assembly consists of three current transformers, Type B three-pole block overload relay and an optional interposing relay. These parts are mounted on a panel which connects directly to the load terminal of the

contactor. Current transformers are 600:5 ratio as standard.

If automatic reset is required, the Type A, three-pole block, ambient compensated relay is available upon request.

Notes

- ① Do not use with DC operated contactors.
- ② Size 7 and larger use DC coils as standard.

Overload Relay Kits

Each kit includes three current transformers (standard ratio) and one Type B, three-pole block overload relay, ambient compensated with manual reset.

Overload Relay Kits

Kit Size	Kit Part Number
5	2057A34G01
6	6379D80G10

Replacement Terminal Lugs ①

Contactor Size	Cable Size	Terminals		Kit Style Number
		Qty. in Kit	Qty. Req'd. per Pole	
5	1-500 kcmil	6	2	2119A76G01
6	2-500 kcmil	6	2	7858A96G01
7	4-500 kcmil	12	4	7858A96G02
8	4-500 kcmil	12	4	7858A96G03

XTIEC

Auxiliary Contacts

Front mounted snap-on auxiliary contacts for **XT** contactors are available with screw or spring cage terminals in a variety of contact configurations.

The 7–32A XTCE contactors have positively driven contacts between the integrated auxiliary contact and the auxiliary contact module as well as within the auxiliary contact modules.

The 40–65A XTCE contactors have positively driven contacts within the auxiliary contact module. Six auxiliary contacts are possible with a combination of side-mounted and front-mount auxiliary contacts.

Frame B–C contactors with 1NC built-in auxiliary are mirror contacts (XTCE...B01_–XTCE...C01_).

XTCE and XTCS Auxiliary Contact Overview

Frame	A	B	C	D	F	G	L–R
Catalog numbers	XTMC6A_– XTMC9A_	XTCE007B_– XTCE015B_	XTCE018C_– XTCE032C_	XTCE040D00_– XTCE065D00_	XTCE080F00_– XTCE095F00_	XTCE115G00_– XTCE150G00_	XTCE185L22_– XTCEC20R22_ ②
Contactor width	45 mm	45 mm	45 mm	55 mm	90 mm	90 mm	Various
Built-in auxiliary	1NO or 1NC	1NO or 1NC	1NO or 1NC	—	—	—	2NO-2NC
Contact sequence							
Front- (top) mount auxiliary	Two- and four-pole (screw or spring cage): 	Standard two- and four-pole versions (screw or spring cage): 		Two-pole (screw only): 		Four-pole (screw or spring cage): 	N/A
Side-mount auxiliary	N/A	N/A	Two-pole (screw only): 	Two-pole (screw or spring cage): 			

Notes











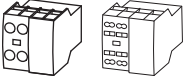



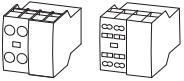

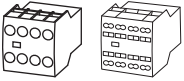

- ① All mounting hardware is included in kit.
- ② Frame L–R auxiliary contacts also apply to XTCS185_–XTCS500M_ contactors.

15.1

Accessories and Modification Codes

Accessories













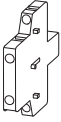

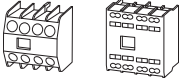

Auxiliary Contacts

		Conventional Thermal Current, Open at 60°C $I_{th} = I_e$ AC-1 in Amps	Poles	Contact Configuration	Circuit Symbol	Pkg. Qty.	Screw Terminals Catalog Number	Spring Cage Terminals Catalog Number
Frame B-C – Front- (Top) Mount								
	16		2	2NO		5	XTCEXFAC20	XTCEXFACC20
	16		2	1NO-1NC		5	XTCEXFAC11	XTCEXFACC11
	16		2	2NC		5	XTCEXFAC02	XTCEXFACC02
	16		2	1NO _E -1NC _L		5	XTCEXFALC11 ①	XTCEXFALCC11 ①
	16		2	1NO-1NC		5	XTCEXFDC11 ②	XTCEXFDC11 ②
	16		2	2NC		5	XTCEXFCC02 ②	XTCEXFCC02 ②
	16		4	4NO		5	XTCEXFAC40	XTCEXFACC40
	16		4	3NO-1NC		5	XTCEXFAC31	XTCEXFACC31
	16		4	2NO-2NC		5	XTCEXFAC22	XTCEXFACC22
	16		4	1NO-3NC		5	XTCEXFAC13	XTCEXFACC13
	16		4	4NC		5	XTCEXFAC04	XTCEXFACC04
	16		4	1NO _E -1NC _L		5	XTCEXFCLC22 ①	XTCEXFCLCC22 ①
	16		4	2NO-2NC		5	XTCEXFCC22 ②	XTCEXFCC22 ②
Frame B-C – Front- (Top) Mount – Tall Version ③								
	16		2	2NO		5	XTCEXFATC20	—
	16		2	1NO-1NC		5	XTCEXFATC11	—
	16		2	2NC		5	XTCEXFATC02	—

Notes

- ① One early-make contact (1NO_E), one late-break contact (1NC_L).
- ② To avoid duplicate terminal numbers in contact sequence, these auxiliary contacts should only be used with contactors having a built-in 1NO contact (XTCE...B10_, XTCE...C10_).
- ③ Front- (top) mount tall version is for use with Frame B electrical wire bridges and link kits and toolless plug combination connection kits: XTCEXRLL, XTCEXSDLB, XTPAXTPCB, XTPAXTPCRB, XTPAX.

Auxiliary Contacts, continued

	Conventional Thermal Current, Open at 60°C I _{th} = I _e , AC-1 in Amps	Poles	Contact Configuration	Circuit Symbol	Pkg. Qty.	Screw Terminals Catalog Number	Spring Cage Terminals Catalog Number
Frame B-C—Front- (Top) Mount—Tall Version, continued ①							
	16	4	2NO-2NC		5	XTCEXFATC22	—
Frame C—Side-Mount							
	10	2	1NO-1NC		1	XTCEXSCC11 ②	—
Frame D-G							
	16	2	2NO		5	XTCEXFBG20	—
	16	2	1NO-1NC		5	XTCEXFAG11	—
	16	2	1NO-1NC		5	XTCEXFBG11	—
	16	2	2NC		5	XTCEXFBG02	—
	16	4	4NO-0NC		5	XTCEXFBG40	XTCEXFBGC40
	16	4	3NO-1NC		5	XTCEXFBG31	XTCEXFBGC31
	16	4	2NO-2NC		5	XTCEXFBG22	XTCEXFBGC22
	16	4	2NO-2NC		5	XTCEXFAG22	XTCEXFAGC22
	16	4	1NO-3NC		5	XTCEXFBG13	XTCEXFBGC13
	16	4	0NO-4NC		5	XTCEXFBG04	XTCEXFBGC04
	16	4	1NO _E -1NC _L		5	XTCEXFBG22 ③	XTCEXFBGC22 ③

Notes





- ① Front- (top) mount tall version is for use with Frame B electrical wire bridges and link kits and toolless plug combination connection kits: XTCEXRLB, XTCEXSDLB, XTPAXTPCB, XTPAXTPCRB, XTPAX.
 - ② Can be mounted to the left side of contactor only. Cannot be used in combination with front- (top) mount auxiliary contacts or mechanical interlocks.
 - ③ One early-make contact (1NO_E), one late-break contact (1NC_L).
- Interlocked opposing contacts, to IEC/EN 60947-5-1 Annex L (positively driven), within the auxiliary contact modules (not NO [early make] and NC [late break] contacts) and for the built-in auxiliary contacts of the XTCE007B_–XTCE032C_.
- Auxiliary break contact can be used as mirror contact to IEC/EN 60947-4-1 Annex F (not NC [late break] contact).
- No auxiliary contacts can be fitted between two contactors.

15.1



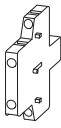















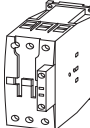

Accessories and Modification Codes

Accessories

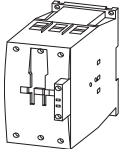
Side-Mount Auxiliary Contacts for Frame D–R, 40–2000A

	Conventional Free Air Thermal Current, $I_{th} = I_e$, AC-1 in Amps	Poles	Contact Configuration	Circuit Symbol	Pkg. Qty.	Screw Terminal Catalog Number	Spring Cage Terminal Catalog Number
	10	2	1NO-1NC		1	XTCEXSBN11	XTCEXSBN11
	10	2	1NO _E -1NC _L		1	XTCEXSBLN11 ①	—
	10	2	1NO-1NC		1	XTCEXSCN11 ②	XTCEXSCN11 ②

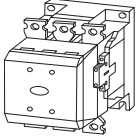
Auxiliary Contacts Possible Combinations

Frame Size	Contactor	Built-In Auxiliary	Front- (Top) Mount		Side-Mount Two-Pole	Total Auxiliary Contacts Available	Catalog Number
			Two-Pole	Four-Pole			
A		1NO or 1NC	1	—	—	3	XTMC6A_
			—	1	—	5	XTMC9A_
					—	—	
B		1NO or 1NC	1	—	—	3	XTCE007B_
			—	1	—	5	XTCE015B_
					—	—	
C		1NO or 1NC	1	—	—	3	XTCE018C_
			—	1	—	5	XTCE032C_
			—	—	1	3	—
						—	—
D		—	1	—	2	6	XTCE040D00_
			—	1	1	6	XTCE065D00_
						—	—
F–G		—	1	—	2	6	XTCE080F00_
			—	1	2	8	XTCE150G00_
			—	—	4	8	—
						—	—
L–R		2NO-2NC	—	—	2	8	XTCE185L22_
			—	—	—	—	XTCEC20R22_
			—	—		—	—

Notes

- ① One early-make contact (1NO_E), one late-break contact (1NC_L).
 - ② To maintain proper terminal marking, XTCEXSCN_ should not be used with Frame D contactors and only used with Frame F–G contactors in combination with XTCEXSBN_.
- Forced operation contact to IEC/EN 60947-5-1 Appendix L (positively driven), inside the auxiliary contact unit (not early close and late opening).
 Auxiliary normally closed contact can be used as mirror contact to IEC/EN 60947-4-1 Appendix F (not late opening).
 No auxiliary contacts can be fitted between two contactors.

Auxiliary Contact Combinations

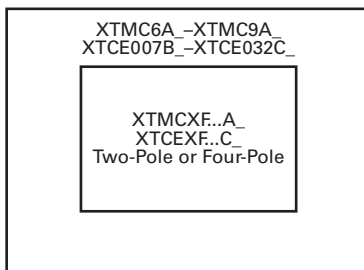

Frame A–B

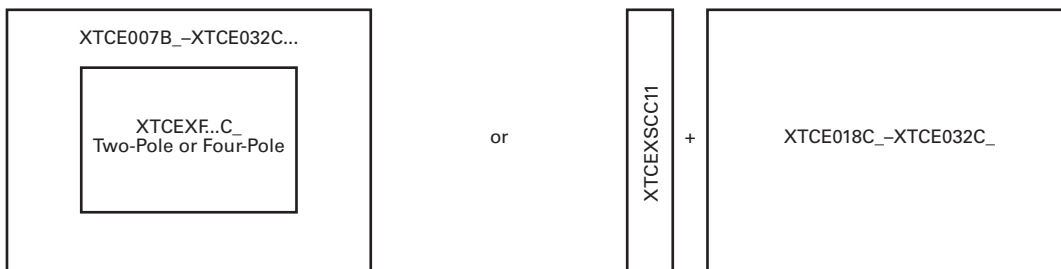

Frame C

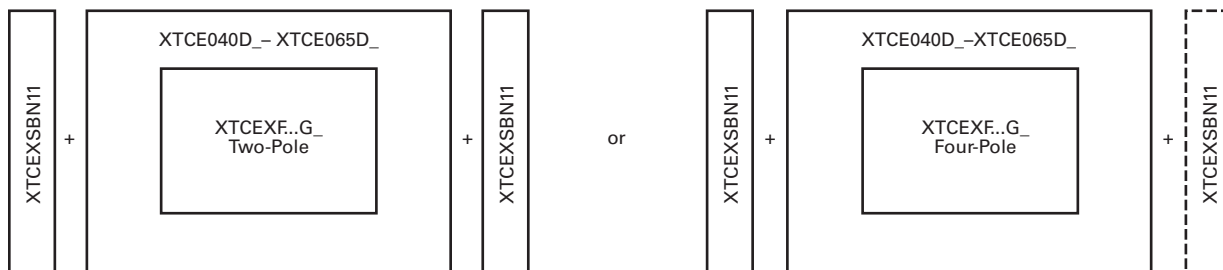

Frame D

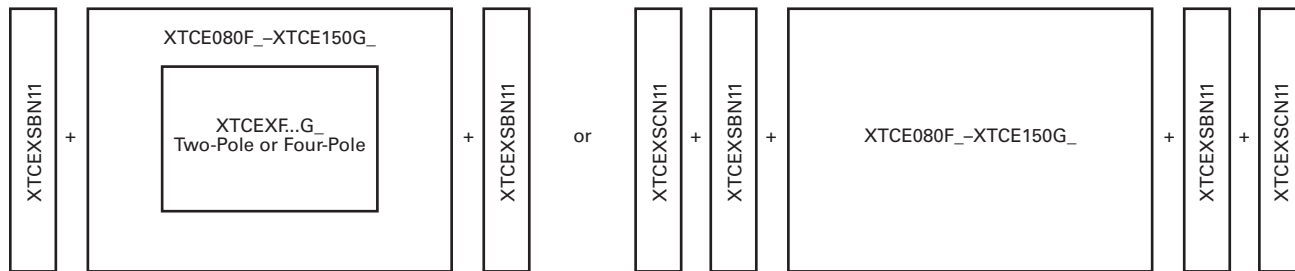

Frame F–G

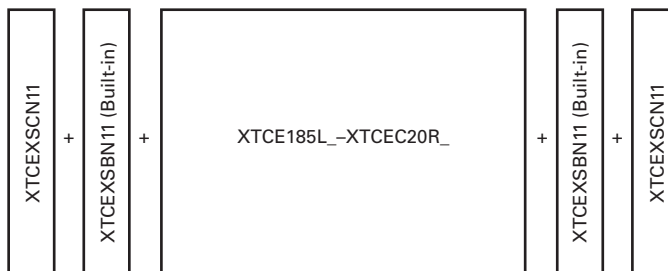

Frame L–R

Enclosures

Type 1 Enclosures

C899 Type 1 Enclosure



Type 1 Enclosures—NEMA (Freedom)

Starter Type	Box Number	NEMA Size	Catalog Number
Non-reversing starter	1	00-1 AN16	C899B001 ^①
	1	00-2 AN19	C899B001 ^①
	2	2 AN16	C799B13
	4	3-4	C799B15
	10	5	C799B17
Non-reversing starter with space for CPT	3	00-2	C799B14 ^②
	4	3-4	C799B15 ^③
Reversing starter	2	00-0	C799B13
	3	1-2	C799B14
	4	3	C799B15
	9	4	C799B16
	10	5	C799B17

Notes

- ① C899B001 is a universal enclosure that requires a specific reset rod length based on starter size. See Volume 10 Tab 2.
- ② Sub panel drilled for 50-200 VA CPTs.
- ③ Enclosure drilled for 150-300 VA CPTs.

Type 3R, 4X and 12 Enclosures

Type 3R Enclosure



Type 3R, 4X and 12 Enclosures—NEMA (Freedom)

Starter Type	Box Number	NEMA Size AN16	Type 3R Catalog Number	Type 12 Catalog Number	Type 4X Catalog Number
Non-reversing starter	5	00-1	C799B21	C799B81	C799B41
	6	2	C799B24	C799B84	C799B43
	6	—	C799B25	C799B85	C799B44
	8	3	C799B210	C799B810	C799B47
	8	—	C799B212	C799B812	C799B49
	8	4	C799B211	C799B811	C799B48
	10	5	C799B218	C799B818	C799B413
Non-reversing starter with space for CPT	6	00-2	C799B24	C799B84	C799B43
	6	—	C799B25	C799B85	C799B44
	8	3	C799B210	C799B810	C799B47
	8	—	C799B212	C799B812	C799B49
	8	4	C799B211	C799B811	C799B48
	10	5	C799B218	C799B818	C799B413
	Reversing starter	6	00-2	C799B24	C799B84
6		—	C799B25	C799B85	C799B44
8		3	C799B210	C799B810	C799B47
8		—	C799B212	C799B812	C799B49
9		4	C799B215	C799B815	C799B411
10		5	C799B218	C799B818	C799B413
Multispeed	7 ^①	0-2	C799B223	C799B823	C799B417

C899 Type 1 Enclosure



Enclosures—IEC (XT Type)

Starter Type	Box Number	IEC Size	Catalog Number
XT starters, SSOL	1	B-C	C899B001 ^②
XT starters, bi-metallic	1	B	C899B001 ^②
XT contactors/starters, bi-metallic	1	C	C899B001 ^②
XT contactors/starters without reset	2	D	C799B34
XT contactors/starters with resets	2	D	C799B35

Notes

- ① Blank cover provided.
- ② C899B001 is a universal enclosure that requires a specific reset rod length based on starter size. See Volume 10 Tab 3.

Lighting Contactors

Electrically Held Base Contactor for C30CN/ECC

The C30CNE20_0 electrically held base contactor contains a 2NO power pole as standard and will allow the addition of power poles to build an electrically held contactor up to 12 poles

maximum. A mechanically held module kit can also be added to convert the electrically held contactor into a mechanically held contactor in the field.

Electrically Held Base Contactor



Electrically Held Base Contactor

Power Poles	Catalog Number ^①
2NO	C30CNE20_0

Coil Base Voltage (Digit 9)

Voltage (Digit 9)	Code Suffix	Voltage (Digit 9)	Code Suffix
115–120V 60 Hz/110V 50 Hz	A	265–277V 60 Hz/240V 50 Hz	H
230–240V 60 Hz/220V 50 Hz	B	24V 60 Hz/20V 50 Hz	T
460–480V 60 Hz/440V 50 Hz	C	28V 60 Hz/24V 50 Hz	V
575–600V 60 Hz/550V 50 Hz	D	347V 60 Hz	X
200–208V 60 Hz	E		

Power Poles for C30CNM/ECC

The C30CNM contactor accepts up to a maximum six single- or two-pole (or combinations) power poles. These can be used to form up to:

- 12 NO poles maximum when 6 two-poles are used in NO positions (1–6) or
- 8 NC poles maximum with 4 two-poles in the NC position (1–4) and 4 NO poles with 2 two-poles in the 2 NO positions (5–6)

Power Poles



Power Poles

Power Poles	Catalog Number
Single-pole	C320PRP1
Two-pole	C320PRP2

Mechanically Held Module Kits for C30CN/ECC

These kits are for converting electrically held contactors to mechanically held units. Kits include control module, latch, latch cover and auxiliary

contacts plus installation instructions. Conversion kits are suitable for coil voltages of 277V and below.

C30CNM Components—Exploded View

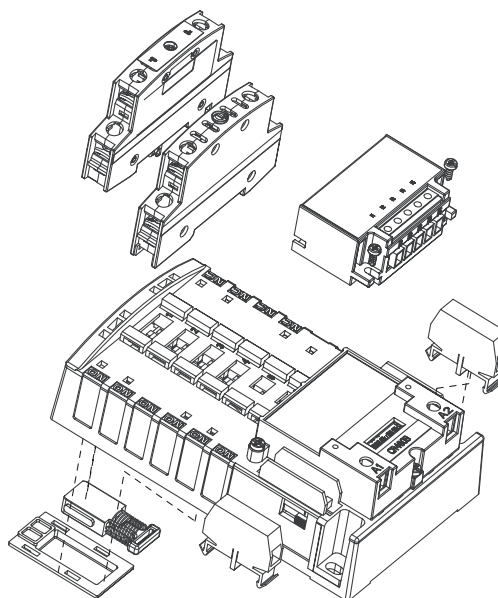

Conversion Kit



Mechanically Held Module Kits

Coil Volts	Control Volts	Catalog Number
Two-Wire		
24–277 Vac	110–120 Vac	C320MH2WA0
	200–277 Vac	C320MH2WH0
	24 Vac	C320MH2WT0
	12–24 Vdc	C320MH2WT1
Three-Wire		
24–277 Vac	110–120 Vac	C320MH3WA0
	200–277 Vac	C320MH3WH0
	24 Vac	C320MH3WT0
	12–24 Vdc	C320MH3WT1

Note

- ^① When ordering, select required contactor by catalog number and replace the magnet coil alpha designation in the catalog number () with the proper code suffix from the Coil Base Voltage table above.

Auxiliary Contacts for C30CN/ECC

A mechanically held contactor with a two-wire control module uses 1NC auxiliary contact as standard for the control wiring circuit. The mechanically held contactor with a three-wire control

module uses 1NO-1NC auxiliary contacts as standard for the control wiring circuit. See the table below for possible additional auxiliary contact configurations.

Auxiliary Contact Configurations

Two-Wire	Three-Wire
None	1NC (two-pole)
1NO (single-pole)	1NO (two-pole)
2NO (two-pole)	1NO-1NC (two-pole)
1NC (two-pole)	
1NO-1NC (NO single-pole, NC two-pole)	
2NO-1NC (two-pole)	

Auxiliary Contacts



Auxiliary Contacts

Auxiliary Block	Catalog Number
Single-pole	C320AMH1
Two-pole	C320AMH2

Transient Suppressor Kits for CN35/ECL

10–60A Contactors

These kits limit high voltage transients produced in the control circuit when power is removed from the contactor or starter coil. There are three separate suppressors for use

on 24–120V, 240V or 480V coils respectively.

These devices mount directly to the coil terminals of lighting contactors 10–60A.

C320TS2



Kits for 10–60A

Description	Coil Voltage	Catalog Number
Transient suppressor	24–120V	C320TS1
	240V	C320TS2
	480V	C320TS3

100–300A Contactors

This device mounts on top of any side-mounted auxiliary contact on lighting contactors 100–300A. It connects across coil terminals on any 120V contactor magnet coil.

Limits high voltage transients produced in the circuit when power is removed from the coil.

C320AS1



Kits for 100–300A

Description	Coil Voltage	Catalog Number
Transient suppressor	120V	C320AS1

Auxiliary Contacts for CN35/ECL

CN35 lighting contactors include a 1NO maintaining auxiliary contact mounted on right hand side (on 10A, two- and three-pole devices, auxiliary contact occupies fourth power pole position—no increase in width). The 10–60A devices will accept additional auxiliary contacts on the top and/or sides.

Auxiliary contact blocks are designed for snap-on installation—fast, easy installation (no tools required up to 60A). All auxiliary

contacts are of the bifurcated design with parallel circuit paths. This redundant path provides very high reliability. Auxiliary contacts can be snapped on the side (up to two circuits—per auxiliary contact) and on the top (up to four circuits). Auxiliary contacts for larger contactors, 100–400A sizes, will accept side-mounted auxiliaries only and easily attach to the side of the contactor with two screws.

Contact Configuration Code

This two-digit code is found on the auxiliary contact to assist in identifying the specific contact configuration.

The first digit indicates the quantity of NO contacts and the second indicates the quantity of NC contacts.

Auxiliary Contacts—10–60A Contactors

Description	Contact Configuration Code ^①	Catalog Number
Side-Mounted		
1NO	10	C320KGS1
1NC	01	C320KGS2
1NO-1NC	11	C320KGS3
2NO	20	C320KGS4
2NC	02	C320KGS5
Top-Mounted ^②		
1NO	10	C320KGT1
1NC	01	C320KGT2
1NO-1NC	11	C320KGT3
2NO	20	C320KGT4
2NC	02	C320KGT5
3NO	30	C320KGT9
2NO-1NC	21	C320KGT10
1NO-2NC	12	C320KGT11
3NC	03	C320KGT12
4NO	40	C320KGT13
3NO-1NC	31	C320KGT14
2NO-2NC	22	C320KGT15
1NO-3NC	13	C320KGT16
4NC	04	C320KGT17

Side-Mounted



Top-Mounted



Notes

- ① For reference only—not part of catalog number.
- ② Cannot be added to contactors or starters mounted in Box 1 (Type 1).

15.1

Accessories and Modification Codes

Accessories

Base Auxiliary Contact



Base Auxiliary Contacts—100–400A Contactors

Circuit	Contact Configuration Code ^①	100A Contactors Catalog Number	200 and 300A Contactors Catalog Number
NO	10	C320KGS31	C320KGS41
NO-NC	11	C320KGS32	C320KGS42

Auxiliary Contact



Auxiliary Contacts—100–400A Contactors

Circuit	Contact Configuration Code ^①	Catalog Number
NO	10	C320KGS20
NC	01	C320KGS21
NO-NC ^②	11	C320KGS22

Auxiliary Contact Ratings (Amperes)—NEMA A600

Current	AC Volts			
	120V	240V	480V	600V
Make and interrupting	60.0	30.0	15.0	12.0
Break	6.0	3.0	1.5	1.0
Continuous	10.0	10.0	10.0	10.0

Auxiliary Contact 5A Continuous Thermal Rating—NEMA P300

DC Volts	Make/Break Amperes
125	1.10
250	0.55

Notes

- ^① For reference only—not part of catalog number.
- ^② NO-NC occupies two positions—L2 and L3 or R2 and R3. See table on [Page V10-T15-33](#).

Auxiliary Contact Location for CN35/ECL

Auxiliary Contacts—Mounting Positions

The sketches below illustrate the maximum number of auxiliary contacts that can be assembled to a contactor and their locations in standard enclosures.

Auxiliary Contact Mounting Positions

Size	Poles	Available Mounting Positions ①②③		
		Open Type	Type 1	Type 3R, 4X, 12
10A	2–4	T1, L1, R1	L1	L1, T1
20–60A	2–3	T1, L1	L1	L1, T1
60A	4	T1, L1	—	L1, T1
60A	5	T1, L1	—	L1, T1
100A	2–3	R2, R3, L1, L2, L3	R2, R3, L1, L2, L3	R2, R3, L1, L2, L3
200A	2–3	R2, R3, L1, L2, L3	R2, R3, L1, L2, L3	R2, R3, L1, L2, L3
300A	2–3	R2, R3, L1, L2, L3	R2, R3, L1, L2, L3	R2, R3, L1, L2, L3
400A	2–3	R2, R3, L1, L2, L3	R2, R3, L1, L2, L3	R2, R3, L1, L2, L3

Auxiliary Contact Location

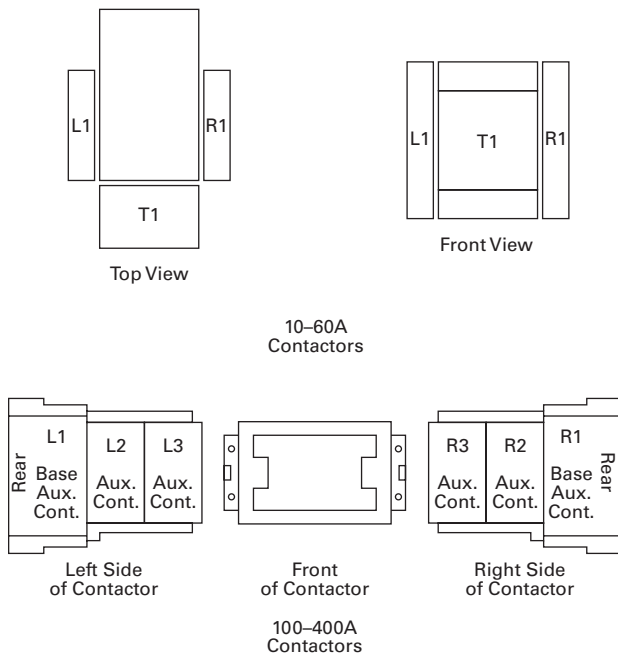

Pneumatic Timers—Top-Mounted for CN35/ECL

Attachment mounts on top of 10–60A lighting contactors (top-mounted auxiliary contacts cannot be installed on device when timer is used). Timer unit has DPST

timed contacts—circuits in each pole must be the same polarity. Units are convertible from OFF to ON delay or vice-versa.

Pneumatic Timer



Pneumatic Timers

Timing Range	Catalog Number
0.1–30 seconds	C320TP1
10–180 seconds	C320TP2

Maximum Ampere Ratings

Description	Volts AC			
	120	240	480	600
Make	30.0	15.0	7.5	6.0
Break	3.0	1.5	0.75	0.6

Solid-State Timers for CN35/ECL

Solid-State ON DELAY Timer—Side-Mounted on CN35 Freedom Series Lighting Contactors Through 60A

This timer is designed to be **wired in SERIES with the load** (typically a coil). When the START button is pushed (power applied to timer), the

ON DELAY timing function starts. At the completion of the set timing period, timer and series wired load will both be energized.

Solid-State Timer



Product Selection—Mounted Timer

Timing Range	Catalog Number ④⑤⑥
0.1–1.0 seconds	C320TDN1_
1–30 seconds	C320TDN30_
30–300 seconds	C320TDN300_
5–30 minutes	C320TDN3000_

Notes

- ① Available positions on contactors or starters other than what is factory installed.
- ② When a pneumatic timer is mounted on contactor, only side-mounted auxiliary contact positions are available. The solid-state timer, when added, takes up side-mounted auxiliary contact position.
- ③ For 100–400A contactors, a base auxiliary contact must be added in position L1 before additional contacts can be mounted.
- ④ Add operating voltage suffix to catalog number. **A** = 120V, **B** = 240V, **E** = 208V.
- ⑤ Rated 0.5A pilot duty—not to be used on larger contactors.
- ⑥ Terminal connections are quick connects only. Two per side.

15.1

Accessories and Modification Codes

Accessories

Type J Auxiliary Contact for A202/ECL

- Capable of being field mounted in a contactor or starter (Classes A200, A900 Sizes 00–6, V200, V201 vacuum and definite purpose controllers)
- Provides two separate electrical contact sets which wire vertically and are color coded; black designates NC and silver designates NO. Please note that the vertical wiring is contrary to the horizontal wiring of the L-56 auxiliary contacts
- Designed to fit within dimensions of starter; no additional panel space is required
- Provides circuit isolation (no polarity restrictions) and single break bifurcated contacts

Auxiliary Contact Ratings

Voltage	Make	Break
NEMA A600		
120–600 Vac	7200 VA	720 VA
72–120 Vac	60A	720 VA
28–72 Vac	60 VA	10A
NEMA R300		
28–300 Vdc	28 VA	28 VA

Type J Auxiliary Contact



Auxiliary Contact Types

Contact Type	Max.	Catalog Number
1NO and 1NC	4	J11
2NC	4	J02
2NO	4	J20
1 coil clearing NC and 1NO	4	J1C

SS-56 Surge Suppressor for A202/ECL

- Designed to be used with magnetic motor controllers through Size 4 in 120V, 60 Hz control circuit applications where electronic equipment is used
- Steady state coil volts: 120, 60 Hz, rms
- Peak input volts: 169.6, 60 Hz, max. amplitude
- Max. ambient temperature: 65°C
- Nominal limiting volts: 270 peak
- Nominal rate of volt rise: 0.5 per ms

SS-56 Surge Suppressor



Surge Suppressor^①

Type Mounting	Kit Catalog Number
Starter	SS-56

F-56 Fuse Block for A202/ECL

- Facilitates installation of fuses (15A, 600V maximum) in control circuits
- Uses Bussman type KTK fuses, or equivalent
- Mounts in same cavity as Type J auxiliary contact
- No tools or mounting hardware needed
- Fuse not included

Fuse Block

Mounting	Kit Catalog Number
Starter	F56
Panel	F56-P

R-56 Interposing Relay for A202/ECL

The R-56AA interposing relay is a low energy solid-state device with a single NO solid-state contact. It can be used as a 120 Vac control relay, and will operate on as little as 40 Vac input. Is useful in

applications requiring long control wiring runs where excessive voltage drop would prevent the contactor or relay from energizing. Will operate a Size 4 contactor from 10,000 ft using 18 AWG wire.

Interposing Relay

Type Mounting	Kit Catalog Number
Starter or panel	R56-AA

Power Pole Kit for A202/ECL

- Adds 1NO or 1NC power pole to Size 00–1 A201 Class contactors
- Factory installed or field mountable in load side auxiliary cavities
- 600 Vac
- Continuous current rating of 18A for Size 0, 27A for Size 1

Power Pole Kit^②

Continuous Current Rating	Kit Size	Kit Catalog Number
Normally Open		
18	0	PNO-0
27	1	PNO-1
Normally Closed		
18	0	PNC-0
27	1	PNC-1

Notes

- Can be used on Sizes 5 and 6 with 120V coil. Mounting bracket required—order separately. Mounting bracket 177C043G04.
- Do not use with DC operated contactors.

Replacement Auxiliary Contacts for A202/ECL**Replacement Auxiliary Contacts**

Contactor Size	Contact Arrangement	Aux. Elect. Contact Catalog Number	Style Number
5, 6	1NO + 1NC	J11	9084A17G01
	2NO	J20	9084A17G02
	2NC	J02	9084A17G03
7, 8	1NO	—	578D461G01
	1NC	—	578D461G03
9	1NO + 1NC	—	843D943G04
	2NO	—	843D943G05
	2NC	—	843D943G06

Extra Auxiliary Contact Kits for A202/ECL

All starters include an auxiliary contact with 1NO and 1NC contact. These kits include an auxiliary contact

with contacts as shown, plus operating arm and mounting bracket when required.

Extra Auxiliary Contact Kits

Contactor Size	Contact Arrangement	Style Number
5, 6	1NO + 1NC	3463D94G18
	2NO	3463D94G04
	2NC	3463D94G19
7, 8 ^①	2NO	818D498G06
	1NO	818D498G04

DC Coil Conversion Kits for A202/ECL

Kits listed below include all necessary parts to convert from AC to DC control including the DC coil with

built-in diode, rectifier, auxiliary interlock and all mounting hardware.

DC Coil Conversion Kits

Size	Voltage	Kit Style Number
5	110-120	7864A28G01
	220-240	7864A28G02
	440-480	7864A28G03
6	110-120	7864A29G01
	220-240	7864A29G02
	440-480	7864A29G03

Note

① Size 7 and larger use DC coils as standard.

IT Solid-State Soft Starters

Surge Suppressors for S801+/S811+

The surge suppressor can mount on either the line or load side of the IT soft

starter. It is designed to clip the line voltage (or load side induced voltage).

Surge Suppressor



Surge Suppressors

Description	Catalog Number
600V MOV for IT soft starters	EMS39
690V MOV for IT soft starters	EMS41

Lug Kits for S801+/S811+

The 200 mm and 290 mm soft starters do not include lugs.

The 200 mm and 290 mm soft starters each have different lug options based on

your wiring needs. Each lug kit contains three lugs which can be mounted on either the load or line side.

Lug Kits



Lug Kits

Frame Size	Frame Designation	Description	Catalog Number
200 mm SSRV	T, U	2 cable connections, 4 AWG to 1/0 cable	EML22
		1 cable connection, 4/0 to 500 kcmil cable	EML23
		2 cable connections, 4/0 to 500 kcmil cable	EML24
		1 cable connection, 2/0 to 300 kcmil cable	EML25
		2 cable connections, 2/0 to 300 kcmil cable	EML26
		290 mm SSRV	V
4 cable connections, 4/0 to 500 kcmil cable	EML30		
6 cable connections, 4/0 to 500 kcmil cable	EML32		
4 cable connections, 2/0 to 300 kcmil cable	EML33 ①		

Lug Cover Kits for S801+/S811+

Replacement covers for the T and V Frame are available in case of damage to the existing covers.

Lug Cover Kits

Description	Catalog Number
Lug cover T, U Frame	EML27
Lug cover V Frame	EML34

Digital Interface Module and Control Interface Module

The Digital Interface Module (DIM) and control interface module are available as replacement parts.

DIM and CIM

Description	Catalog Number
Blank cover (filler)	EMA68
DIM for S811+	EMA91
CIM for S801+	EMA71
CIM for S801+ pump control option	EMA72
Panel mounting kit	
3 ft cable	EMA69A
5 ft cable	EMA69B
8 ft cable	EMA69C
10 ft cable	EMA69D

Control Wire Connector

Control Wire Connector

Description	Catalog Number
12-pin, 5 mm pitch connector for control wiring	EMA75L

User Manual for S811+

A comprehensive user manual is available and can be downloaded free of charge

from www.eaton.com by performing a document search for MN03902002E.

Mounting Plates for S801+/S811+

The mounting plates are designed to help make it easy to install or retrofit the soft starter into enclosures and MCCs. The soft starter can

be mounted onto the plate prior to installation. The mounting plate is designed with tear drop mounting holes for easier installation.

Mounting Plates

Description	Catalog Number
Mounting plate N Frame	EMM13N
Mounting plate R Frame	EMM13R
Mounting plate T, U Frame	EMM13T
Mounting plate V Frame	EMM13V
Fan/hood accessory	EMM18

Note

① The EML33 does not have a CSA Listing.

Adapter Plates

The adapter plate allows customers to retrofit a V Frame 290 mm soft starter with the U Frame 200 mm soft starter.

Adapter Plates

Description	Catalog Number
Adapter Plates ^①	EMM13U

Vibration Plates for S801+/S811+

The vibration plates allow the soft starter to be applied in high shock and vibration applications. The vibration plate allows vibration up to 5g

and shock in up to 40g. The soft starter is mounted onto the vibration plate prior to installation in the panel.

Vibration Plates

Description	Catalog Number
Vibration plate N Frame	EMM14N
Vibration plate R Frame	EMM14R
Vibration plate T, U Frame	EMM14T
Vibration plate V Frame	EMM14V

Power Supplies

24 Vdc power supply that can be used with the S801+ or S811+ SSRV or as a standalone device.

Power Supplies

Description	SSRV	Catalog Number
115 Vac input	S801+/S811+	PSG240E
230 Vac input	S801+/S811+	PSG240E
380–480 Vac input	S801+/S811+	PSG240F

DIN Rail Power Supply Mounting Kit (35 mm)**DIN Rail Mounting Kit**

Description	Catalog Number
DIN rail mounting kit (35 mm)	PSSDIN

NEMA Vacuum Break Control**Lug Sizes**

- Size 4—12–4/0
- NEMA Size 5 and 6 and 320A, 540A and 610A—supplied without line or load lugs

Lug Kits—Consist of 6 Lugs

Size	Description	Catalog Number
5 and 320A	1/0–500 kcmil	C325KAL8
6, 540A and 610A	1/0–500 kcmil double barrel	C325KAL9
610A	1/0–600 kcmil double barrel	80-19825-2

Field Modification Kits**Auxiliary Electrical Contacts**

Size 4—Three Type J auxiliary contacts may be mounted on the top of Size 4 contactors to provide six auxiliary, isolated 600V, 10A contacts for use in control circuits.

Sizes 5–6—Two Type J auxiliary contacts may be mounted on each side of Size 5 and 6 contactors to provide four auxiliary, isolated 600V, 10A contacts for use in control circuits.

Auxiliary Electrical Contacts

Contact Arrangement	Catalog Number
1NO, 1NC	J11
2NO	J20
2NC	J02

Horizontal Mechanical Interlock

Size	Catalog Number
4	180C113G04
5	180C113G16
6	180C113G17

Note

^① For more information see Pub51719.

Heater Coils

Heater Coil Selection for Type B Overload Relay

Motor Full Load Current in Amperes for Use with 3 Heaters Only
Open Starter

Ambient Compensated Overload Relay	Heater Catalog Number ^①
Size 4 and 160A	
12.8–14.1	FH68
14.2–15.5	FH69
15.6–17.1	FH70
17.2–18.9	FH71
19.0–20.8	FH72
20.9–22.9	FH73
23.0–25.2	FH74
25.3–27.8	FH75
27.9–30.6	FH76
30.7–33.5	FH77
33.6–37.5	FH78
37.6–41.5	FH79
41.6–46.3	FH80
46.4–50	FH81
51–55	FH82
56–61	FH83
62–66	FH84
67–73	FH85
74–78	FH86
79–84	FH87
85–92	FH88
93–101	FH89
102–110	FH90
111–122	FH91
123–129	FH92
130–133	FH93
—	FH94

Motor Full Load Current in Amperes for Use with 3 Heaters Only
Open Starter

Ambient Compensated Overload Relay	Heater Catalog Number ^①
Size 5 and 320A with 300/5 Current Transformers	
107–117	FH23
118–129	FH24
130–141	FH25
142–155	FH26
156–170	FH27
171–187	FH28
188–205	FH29
206–224	FH30
225–244	FH31
245–263	FH32
264–292	FH33
293–318	FH34
319–350	FH35
Size 6 and 540A with 600/5 Current Transformers	
236–259	FH24
260–283	FH25
284–310	FH26
311–340	FH27
341–374	FH28
375–411	FH29
412–448	FH30
449–489	FH31
490–527	FH32
528–585	FH33
586–600	FH34

Notes

^① Three are required per overload relay.

For information on H2001 heaters, see **Page V10-T15-6**.

Modification Codes

A—Ammeters, Auxiliary Contacts, Accelerating Relays, Autotransformers

Modification	Description	Catalog Number Suffix
Ammeter	Panel type wired to current transformer in Line 1, Type 1, 12	A1
	Panel type wired to current transformer in Line 1, Type 3R, 4X	
	Panel type, selector switch and three current transformers wired to ammeter via switch, Type 1, 12	A2
	Panel type, selector switch and three current transformers wired to ammeter via switch, Type 3R, 4X	
	Miniature (single-phase), Type 1, 12	A3
	Miniature with selector switch, Type 1, 12	A4
	Switchboard (single-phase), Type 1, 12	A5
	Switchboard (single-phase), Type 3R, 4X	
	Switchboard with selector switch, Type 1, 12	A6
	Switchboard with selector switch, Type 3R, 4X	
	Three-panel type (single-phase), Type 1, 12	A7
	Three-panel type (single-phase), Type 3R, 4X	
	Three miniature (single-phase), Type 1, 3R, 4X, 12	A10
	Three switchboard type (single-phase), Type 1, 12	A11
Three switchboard type (single-phase), Type 3R, 4X		
Ammeter order by description, Type 1, 3R, 4X, 12	A12	
Auto-transformers	Hp rating selection, see Tab 5	A8
	Order by description	A9
Top-mounted auxiliary contacts ^① (unwired)	1NO	A13
	1NC	A14
NEMA Sizes 00–2 only (unwired)	1NO-1NC	A15
	2NO	A16
IEC Sizes B–L only (unwired) XT Series	2NC	A17
	2NO-1NC	A18
	1NO-2NC	A19
	3NO	A20
	3NC	A21
	3NO-1NC	A22
	2NO-2NC	A23
	1NO-3NC	A24
	4NO	A25
	4NC	A26

Note

^① Top-mounted auxiliary contacts cannot be added to contactors in Box 1 (Type 1).

A—Ammeters, Auxiliary Contacts, Accelerating Relays, Autotransformers, continued

Modification	Description	Catalog Number Suffix
Side-mounted auxiliary contacts ①	1NO	A27
	1NC	A28
	1NO-1NC	A29
	2NO	A30
	2NC	A31
	2NO-1NC	A32
	1NO-2NC	A33
	3NO	A34
	3NC	A35
	3NO-1NC	A36
	2NO-2NC	A37
	1NO-3NC	A38
	4NO	A39
	4NC	A40
Auxiliary contacts	Contacts mounted on operating mechanism of disconnect switch, 1NO-1NC	A42
	Contacts mounted on operating mechanism of disconnect switch, 2NO-2NC	A43
	With auxiliary contact omitted	A44
Accelerating relay	For two-speed	A46
	2NO/2NC 24 Vdc auxiliary relay— IT only	A47

B—Breaker Modifications, Backspin Timer, Undervoltage Release, Bell Alarm, Bus Choke

Modification	Description	Catalog Number Suffix
Breaker	1NO-1NC auxiliary contact on breaker	B1
	2NO-2NC auxiliary contacts on breaker	B2
	Shunt trip on circuit breaker—48–127 Vac or Vdc	B3
	Shunt trip on circuit breaker—9–24 Vac or Vdc	B4
	Shunt trip on circuit breaker—208–380 Vac	B5
	Shunt trip on circuit breaker—415–600 Vac or 220–250 Vdc	B6
	Undervoltage release for breaker	B8
	Current limiter mounted to breaker	B9
	Breaker—order by description	B10
	Thermal magnetic breaker	B11
	Backspin timer	180 seconds
Undervoltage release	Undervoltage release for circuit breaker—208–240 Vac	B13
	Undervoltage release for circuit breaker—380–480 Vac	B14
	Undervoltage release for circuit breaker—525–600 Vac	B15
Bell alarm	Bell alarm for circuit breaker	B16

Note

① Available on **XT** starters for 40A and greater only.

C—Control Power Transformer, Power Supplies, Control Relays, Cover Control (not elsewhere defined), Current Transformers, Compelling Relay, Control Wiring, Control Circuit Breaker, Separate Control, Customer-Supplied Components, Contactors, Counter, E-Stop Relay, DC/AC Interface, Separate Source Disconnect, Bypass Contactors

Modification	Description	Catalog Number Suffix
Control power transformers	Standard size control transformer, 120V/60 Hz, 110V/50 Hz secondary with two primary and one secondary fuse	C1
Make sure eighth character specifies primary/secondary voltage	Standard size control transformer, 24V/60 Hz secondary with two primary and one secondary fuse	C2
	50 VA extra capacity CPT 120V/60 Hz, 110V/50 Hz with two primary and one secondary	C42
	100 VA extra capacity CPT, 120V/60 Hz, 110V/50 Hz secondary with two primary and one secondary fuse	C3
	100 VA extra capacity CPT, 24V/60 Hz secondary with two primary and one secondary fuse	C4
	200 VA extra capacity CPT, 120V/60 Hz, 110V/50 Hz secondary with two primary and one secondary fuse	C5
	200 VA extra capacity CPT, 24V/60 Hz secondary with two primary and one secondary fuse	C6
	300 VA extra capacity CPT, 120V/60 Hz, 110V/50 Hz secondary with two primary and one secondary fuse	C7
	400 VA extra capacity CPT, 120V/60 Hz, 110V/50 Hz secondary with two primary and one secondary fuse	C8
	1 kVA extra capacity CPT, 120V/60 Hz, 110V/50 Hz secondary with two primary and one secondary fuse	C9
	2 kVA extra capacity CPT, 120V/60 Hz, 110V/50 Hz secondary with two primary and one secondary fuse	C10
	Control transformer—order by description	C11
	CPT with power supply for XT	C34
	Power supplies (XT only)	Separate control 120 Vac to 24 Vdc
Power supply with extra capacity—order by description		C28
Control relays	Four-pole interposing relay, 600V (2NO/2NC)	C12
	Four-pole, unwired, A600 rtg.—2NO-2NC	C14
	Eight-pole, unwired, A600 rtg.—4NO-4NC	C15
	Control relay—order by description	C16
	Three-wire control module (C30 lighting)	C18 ①
	Two-wire control relay for mechanical/magnetic lighting contactors	C20 ①
Cover control	Convert position seven to E30 type cover control	C17
	Lock-off attachment added on cover control	C19
	Change to M22 (22 mm) cover controls	C29
Current transformer(s)	In phase 1	C21
	In phases 1 and 2	C22
	In 3 phases	C23
Compelling relay	—	C25
Control wiring	Omit control wiring	C26
	With separate control wiring and two 250V fuses in holder	C30
	With common control wiring and two 600V (Class C) fuses in holder	C31
	Control wiring type—order by description	C33
Control circuit breaker	Order by description	C32
Separate control	Wired for separate control (reduced voltage)	C35
Customer supplied components	Customer supplied components to be installed	C36
	Customer supplied wiring diagram to use	C37

Note

① Not available for **XT** starters.

Modification Codes

C—Control Power Transformer, IT Power Supplies, Control Relays, Cover Control (not elsewhere defined), Current Transformers, Compelling Relay, Control Wiring, Control Circuit Breaker, Separate Control, Customer-Supplied Components, Contactors, Counter, E-Stop Relay, DC/AC Interface, Separate Source Disconnect, Bypass Contactors, continued

Modification	Description	Catalog Number Suffix
Contactors/starter	Contactors/starter—order by description	C40
Counter	Operations counter	C41
E-stop relay	E-stop relay (DeviceNet)	C43
DC/AC interface	DC/AC interface module	C44 ^①
Separate source disconnect	IEC separate source disconnect for control circuitry	C45
Bypass contactors for IT RVSS	Isolation contactor	C46/J1
	Output contactor	C46/J2
	Bypass contactor	C46/J3
	Isolation/output/bypass contactor	C46/J4

D—Device Labels, Deceleration Relay, Drain and Breather, Duplex Modifications

Modification	Description	Catalog Number Suffix
Device labels	(Each label)	D1
Decel. relay ^①	Two-speed	D2
Drain and breather (Type 7/9 enclosure) ^①	Drain and breather	D5
	Drain only	D6
	Breather only	D7
Duplex modifications	Alternator omitted (deduct price)	D12
	START/STOP pushbuttons—supplied for each motor	D14
	HAND/OFF/AUTO selector switch—supplied for each motor	D15
	No. 1 lead—No. 2 lead selector switch for manual selection of lead pump (alternator is omitted)	D16
	Red RUN pilot light—supplied for each motor	D17
	Push-to-test red RUN pilot light—supplied for each motor	D18
	TEST pushbutton for each motor	D19
	CPT, 120V secondary, two primary fuses and one secondary fuse—supplied for each motor	D20
	CPT with 100VA extra capacity, 120V secondary, two primary fuses and one secondary fuse—supplied for each motor	D21
	CPT with 200VA extra capacity, 120V secondary, two primary fuses and one secondary fuse—supplied for each motor	D22
	CPT for duplex—order by description	D23
	Add two relays to modify controller to operate with single-pole pilot devices	D24
	Add three relays to modify controller to operate with single-pole pilot devices	D25
	Green—OFF for each starter	D26
	Green—push-to-test OFF for each starter	D27
	Green—RUN light (duplex pump)	D28
Red—STOP light (duplex pump)	D29	
P-T—green RUN light (duplex pump)	D30	
P-T—red STOP light (duplex pump)	D31	
Elapsed time meter (duplex pump)	D32	

Note

^① Not available for **XT** starters.

E—Enclosure Modifications, Elapsed Time Meter, Duplex Outlet, Enclosure for Starter, Enclosure Clear Cover, Enclosure Material

Modification	Description	Catalog Number Suffix
Enclosure modifications	Oversize enclosure	E3
	Enclosure—order by description	E4
	Enclosure with pole mounting hardware	E5
	Removable end plates	E6
	Service entrance rating (ground/neutral banding SE labels)	E7
	Service entrance rating with ground bar	E8
	Safety door interlock	E11
Elapsed time meter	Wired across coil, Type 1, 12	E9
	Wired across coil, Type 3R, 4X	
	Elapsed time meter—order by description	E10
Duplex outlet	Convenience duplex outlet mounted in side of enclosure	E12
Enclosure for starter ^①	Horizontal combination starter, Size 0–2	E13
	Narrow combination starter, Size 0–2	E14
Enclosure clear cover for XT	Clear cover for Halyester enclosure non-metallic	E19
Enclosure material	Convert to 316 stainless steel	E16
	Convert from Type 3R to stainless steel	E21
Irrigation pump panel	Bottom entry	E17

F—Fuse Clips, Fuse Blocks, Fungus Protection, Fingerproof Covers, EMI Filter

Modification	Description	Catalog Number Suffix
Fuse clips ^①	Change fuse clips in position eight to Class J	F1
	Change fuse clips in position eight to Class H and K (30A and 60A only)	F2
Fuse blocks	Power fuses included—order by description	F4
	30A control circuit fuseholder (KTK) mounted on panel (unwired), fuse not supplied	F5
	30A control circuit fuseholder mounted on panel (unwired), FNQR fuse supplied	F6
	Three-pole power fuseholder mounted on front contactor	F7
	Separate fusing of control power supply— IT .	F8
	Blown fuse indicator (not for PFC)	F10
	Class CC fuses	F21

G—Ground Fault Relay, Grounding

Modification	Description	Catalog Number Suffix
Ground fault relay	Ground fault relay (wired)	G1
	Ground fault relay (unwired)	G3
Grounding	Special grounding—order by description	G5
	Ground fault protection and monitoring panel	G7

Note

^① Not available for **XT** starters.

15.2

Accessories and Modification Codes

Modification Codes

H—Heater (Space), Heater Packs Installed

Modification	Description	Catalog Number Suffix
Space heater	Space heater and thermostat	H1
	Space heater and NC interlock	H2
Install heater packs (Freedom Series)	Class 20	Class 10
	/D1 H2001B-3	/D25 H2101B-3
	/D2 H2002B-3	/D26 H2102B-3
	/D3 H2003B-3	/D27 H2103B-3
	/D4 H2004B-3	/D28 H2104B-3
	/D5 H2005B-3	/D29 H2105B-3
	/D6 H2006B-3	/D30 H2106B-3
	/D7 H2007B-3	/D31 H2107B-3
	/D8 H2008B-3	/D32 H2108B-3
	/D9 H2009B-3	/D33 H2109B-3
	/D10 H2010B-3	/D34 H2110B-3
	/D11 H2011B-3	/D35 H2111B-3
	/D12 H2012B-3	/D36 H2112B-3
	/D13 H2013B-3	/D37 H2113B-3
	/D14 H2014B-3	/D38 H2114B-3
	/D15 H2015B-3	/D39 H2115-3
	/D16 H2016B-3	/D40 H2116-3
	/D17 H2017B-3	/D41 H2117-3
	/D18 H2018-3	
	/D19 H2019-3	
	/D20 H2020-3	
	/D21 H2021-3	
	/D22 H2022-3	
	/D23 H2023-3	
	/D24 H2024-3	

15

K—Keypad

Modification	Description	Catalog Number Suffix
Keypad	Door mounted keypad (RVSS)	K5

L—Labels and Lighting Contactors

Modification	Description	Catalog Number Suffix
Lighting arrestor	Lighting arrestor installed in enclosure on panel	L3
Lugs	Special lugs (order by description)	L9
Carton label	Customer marking—specify	L10
Lighting contactors	1 NC pole	L21
	2 NC pole	L22
	3 NC pole	L23
	4 NC pole	L24
	5 NC pole	L25
	6 NC pole	L26
	7 NC pole	L27
	8 NC pole	L28
	Three-wire 120 Vac	L29A
	Three-wire 240 Vac	L29B
	Three-wire 24 Vac	L29C
	Three-wire 24 Vdc	L29D
	Two-wire 120 Vac	L29E
	Two-wire 240 Vac	L29F
Two-wire 24 Vac	L29G	

N—Nameplates

Modification	Description	Catalog Number Suffix
Nameplates	Enclosure nameplates	N1

15.2

Accessories and Modification Codes

Modification Codes

P—Pilot Lights, Pushbuttons, Phase Relays, Potential Transformers, Power Factor Correction Capacitors, Program Timer, Percentage Timer, Photocell

Modification	Description	Catalog Number Suffix
Push-to-test pilot lights	Push-to-test pilot light (red RUN) wired to coil	P1
	Push-to-test pilot light (green OFF) wired in series with auxiliary contact	P2
	Combination of P1 and P2 above	P3
	Push-to-test pilot light (amber RUN) wired to coil	P4
	Push-to-test pilot light—green RUN	P49
	Push-to-test pilot light—green STOP	P57
Pushbuttons	EMERGENCY STOP—mushroom head	P5
	Pushbutton omitted	P6
	START/STOP	P7
	ON/OFF	P8
	START	P9
	ON	P10
	OFF	P11
	FORWARD/REVERSE/STOP	P12
	FAST/SLOW/STOP	P13
	FAST/OFF/SLOW	P14
	HIGH/LOW/STOP	P15
	HIGH/LOW	P16
	SLOW/FAST	P17
	Pushbutton with legend plate	P18
	UP/STOP/DOWN	P52
	OPEN/STOP/CLOSE	P53
	Red STOP pushbutton	P72
START/STOP pushbuttons (located in top two holes)	P73	
Green START pushbutton	P74	
Pilot lights	With one amber pilot light marked POWER AVAILABLE wired to load side of two fuses or circuit breaker	P19
	Pilot light (amber RUN) wired to coil	P20
	With one red pilot light marked RUN wired thru NO auxiliary contact	P21
	With one push-to-test red light marked RUN Wired thru NO auxiliary contact	P22
	Pilot light—red RUN	P23
	Pilot light—red ON	P24
	Pilot light—green OFF	P25
	Pilot light—order by description	P26
	Pilot light—red STOP	P29
	Pilot light—green STOP	P61
	FORWARD/REVERSE red pilot lights	P62
	UP/DOWN red pilot lights	P63
	OPEN/CLOSE red pilot lights	P64
	HIGH/LOW red pilot lights	P65
	FAST/SLOW red pilot lights	P66
	Green RUN light	P67
	LED bulbs	P68
	Blue OVERLOAD light	P69
	Amber fault pilot light	P71

P—Pilot Lights, Pushbuttons, Phase Relays, Potential Transformers, Power Factor Correction Capacitors, Program Timer, Percentage Timer, Photocell, continued

Modification	Description	Catalog Number Suffix
Illuminated pushbutton	Illuminated pushbutton—order by description	P27
Phase loss relay	Phase loss relay	P28
Phase reversal relay	Phase reversal relay	P30
Phase unbalance relay	Phase unbalance relay	P32
Phase monitoring relay	Phase monitoring relay	P34
Power factor correction capacitors	/F1 20 kVar /F9 70 kVar /F17 200 kVar	P38
	/F2 25 kVar /F10 75 kVar /F18 225 kVar	
	/F3 30 kVar /F11 80 kVar /F19 250 kVar	
	/F4 35 kVar /F12 90 kVar /F20 300 kVar	
	/F5 40 kVar /F13 100 kVar /F21 350 kVar	
	/F6 45 kVar /F14 125 kVar /F22 400 kVar	
	/F7 50 kVar /F15 150 kVar	
	/F8 60 kVar /F16 175 kVar	
Potential transformers	Potential transformer—wired L1–L2	P39
	Potential transformer—wired L1– L2 and L2–L3	P40
	Potential transformer—three phases	P41
Pump controller	Pump controller for <i>IT</i> .	P42
Program timers	15-minute program timer	P43
	24-hour program timer	P44
	7-day program timer with day omission feature	P45
Percentage timers	15-minute percentage timer	P47
	60-minute percentage timer	P48
Photocell	Photoelectric receptacle with photocell	P70

Q—IQ Products, DN50

Modification	Description	Catalog Number Suffix
IQ products	IQ 500	Q1
	IQ100	Q2
	IQ 1000	Q3
	IQ 4000	Q5
IQ data metering module	IQ data metering module	Q12
	IQ 220 with cable	Q14
DN50	DeviceNet input/output module	Q13

R—Ramp, Relays, Solid-State Electronic Overload Relays, Resets, Overload Relay Modifications, Reversing, DeviceNet Interface

Modification	Description	Catalog Number Suffix
Ramp	Extended ramp of <i>IT</i> .	R1
Relay	Overvoltage relay	R2
	Omit overload relay	R4

R—Ramp, Relays, Solid-State Electronic Overload Relays, Resets, Overload Relay Modifications, Reversing, DeviceNet Interface, continued

Modification	IEC Size	NEMA Size	Full Load Current Adjustment Range (A)	Three-Phase without Ground Fault Auto/Manual Reset Overload Selectable Class 10/20/30	Three-Phase with Ground Fault Auto/Manual Reset Overload Selectable Class 10/20/30
Solid-state electronic overload relay ^①	B and C	00	0.33–1.65 ^②	R63/A	R64/A
			1–5	R63/B	R64/B
			4–20	R63/C	R64/C
	C and D	0 and 1	0.33–1.65 ^②	R63/A	R64/A
			1–5	R63/B	R64/B
			4–20	R63/C	R64/C
			9–45	R63/D	R64/D
	D	2	9–45	R63/D	R64/D
	D, F and G	3	20–100	R63/E	R64/E
	G	4	28–140	R63/F	R64/F
	N/A	5	60–300 ^③	R63/G	R64/G
	N/A	6	120–600 ^④	R63/H	R64/H

Modification	Description	Catalog Number Suffix
Resets ^⑤	Change external reset to internal reset—hole covered with plug	R5
	Internal reset—no hole plug	R6
	Overload reset (order by description)	R7
	Manual reset only on overload relay	R44
	Auto reset only on overload relay	R45
	Internal trip indicator—no external reset	R47
	External reset with external trip indicator	R48
	External reset with bell alarm	R49
	N3R reset boot added (Type 1/12 only)	R71
Reversing ^⑥	Reversing contactor/starter	R54
Overload relay mods	Anti plug-in	R53
DeviceNet interface	DeviceNet interface	R69
	Standard reset for DeviceNet	R65
	Lighted reset for DeviceNet	R66
	Trip indicator for DeviceNet	R67

Notes

^① Features:

- Self-powered
- Phase loss protection
- Current adjustment knob
- ±1% repeat accuracy
- 1NO and 1NC isolated contacts

^② Not UL Listed.

^③ NEMA Size 5 starter available with 60–300A panel mounted CTs. Starter as an assembled unit with 1–5A C440 overload relay (C440A1A005SELAX or C440A2A005SELAX).

^④ NEMA Size 6 starter available with 120–600A panel mounted CTs. Starter as an assembled unit with 1–5A C440 overload relay (C440A1A005SELAX or C440A2A005SELAX).

^⑤ Not available for **XT** starters.

S—System Voltage, Selector Switches, Suppressor, Incomplete Sequence Protection, Single-Phase Jumper, Surge Capacitor, Speed Potentiometer

Modification	Description	Catalog Number Suffix
System voltage selection	System voltage selection for internal components	S1
	/H1 208V 60 Hz	
	/H2 240V 60 Hz	
	/H3 277V 60 Hz, single-phase	
	/H4 480V 60 Hz	
	/H5 600V 60 Hz	
	/H6 796V 60 Hz	
	/H7 220V 50 Hz	
	/H8 380V 50 Hz	
	/H9 415V 50 Hz	
	/H10 550V 50 Hz	
	/H11 660V 50 Hz	
	/H12 380V 60 Hz	
	/H13 1500V 60 Hz	
	System voltage selection—specify on order	S2
Selector switches ^①	HAND/OFF/AUTO	S3
	HAND/AUTO	S4
	HAND/OFF/AUTO selector switch with one red RUN pilot light	S5
	RUN/OFF/AUTO	S6
	AUTO/OFF/TEST	S7
	AUTO/OFF/TEST selector switch with one red RUN pilot light	S8
	AUTO/OFF/TEST selector switch with one red RUN pilot light and one green pilot light	S9
	OFF/AUTO	S10
	START/STOP	S11
	OFF/ON	S12
	HIGH/LOW	S13
	FAST/OFF/SLOW	S14
	SLOW/FAST	S15
	FORWARD/REVERSE	S16
	HIGH/OFF/LOW	S17
	HIGH/LOW/OFF/AUTO	S18
	Selector switch omitted (pumps only)	S19
	HAND/OFF/AUTO spring return from left	S21
	OPEN/OFF/CLOSE	S41
	FORWARD/OFF/REVERSE	S42
FAST/OFF/SLOW/AUTO	S43	
Selector switch omitted (pump panels only)	S19	
Selector switch—order by description	S40	
RVSS/BYPASS (soft starters only)	S44	
LOCAL/REMOTE selector switch	S45	
RUN/OFF selector switch	S46	
Suppressor	Transient suppressor mounted on magnet coil	S24
Surge suppression	MOV (IT)	S20
Sequence timer	Sequence timer (pump panels)	S26
Sequence protection	Incomplete sequence protection	S27
Pump	480V BP9000 pump	S28
Single-phase	Convert contactor or starter from three-phase to single-phase—install jumper	S29
	Single-phase rev. 120V	S30
	Single-phase rev. 240V	S31
Surge capacitor	Surge capacitor wired to disconnect line side	S37

Note

^① When using three-position selector switch with magnetic lighting contactor, mod **C20** must also be used (ECL04, ECL13, ECL15).

15.2

Accessories and Modification Codes

Modification Codes

T—Timers, Time Delay Relays, Terminal Blocks, Terminal Points, Ring Lug Connections

Modification	Description	Catalog Number Suffix
Timers	Pneumatic timer installed on contactor, unwired, 30 seconds maximum	T1
	Pneumatic timer installed on contactor, unwired, 180 seconds maximum	T2
	Pneumatic timer mounted in enclosure, unwired, 180 seconds maximum	T3
	Solid-state ON delay timer (1–30 seconds)	T4
	Solid-state ON delay timer (30–300 seconds)	T5
	Timer—order by description	T25
Time delay relays	Time delay relay, 3 minutes maximum, unwired, ON DELAY	T6
	Time delay relay, 3 minutes maximum, unwired, OFF DELAY	T7
	Time delay low voltage release relay	T8
Terminal blocks	With one single circuit terminal block, unwired	T9
	With two single circuit terminal block, unwired	T10
Terminal points	With 6 terminal points, unwired	T11
	With 12 terminal points, unwired	T12
	With 18 terminal points, unwired	T13
	Terminal point per customer specification, unwired (price each)	T14
	Terminal point per customer specification, wired (unwired without customer diagram)	T15
	Three terminals mounted between contactor and overload for power factor capacitors—Sizes 0–2	T21
	Three terminals mounted between contactor and overload for power factor capacitors—Sizes 3–4	T22
	Quick-connect terminals added to DP contactor/starter	T23
Ring lug connections	Ring lug connections on power wires	T16 ^①
	Ring lug connections on control wires	T17

15 U—Undervoltage Relay, Time Delay Undervoltage Relay

Modification	Description	Catalog Number Suffix
Undervoltage relays	Undervoltage relay, non-adjustable	U1
	Undervoltage relay, adjustable	U2
Time delay undervoltage relays	Time delay undervoltage relay, non-adjustable	U4
	Time delay undervoltage relay, adjustable	U5
Under- and overvoltage relay	Under- and overvoltage relay	U7

Note

① Not available for **XT** starters.

V— Voltmeter, Varmeter, Vacuum Starter

Modification	Description	Catalog Number Suffix
Voltmeters	One panel type voltmeter wired L1–L2	V1
	Panel type voltmeter and selector switch wired to read three-line voltages	V2
	Miniature voltmeter wired L1–L2	V3 ①
	Miniature voltmeter and selector switch wired to read three-line voltages	V4 ①
	Switchboard type voltmeter wired L1 – L2	V5
	Switchboard type voltmeter and selector switch wired to read three-line voltage	V6 ①
	Three panel type voltmeters wired in each phase	V7
	Three miniature voltmeters wired in each phase	V8 ①
	Three switchboard type voltmeters wired in each phase	V9 ①
	Voltmeter—order by description	V10
Varmeter ②	Varmeter	V11
	Varmeter—order by description	V12
Vacuum starter ②	Vacuum starter—1500V rating	V13

W— Wattmeter, Watt-Hour Meter, Wiremarkers, Wiring Diagram

Modification	Description	Catalog Number Suffix
Wattmeter ①	Wattmeter	W1
Watt-hour meter ①	Watt-hour meter	W3
	Watt-hour meter with demand attachment	W5
Wiremarkers	Wiremarkers	W7
	Wiremarkers—order per customer diagram or specifications	W8
	Wiremarkers—order by description	W9
WYE-Delta hp	See Tab 5	W10 ②
Windows in enclosure	Enclosure windows	W11
Wiring diagram	Reduced copy of custom wiring diagram laminated on inside of door	W12

Notes

① Type 1/12 only.

② Not available for **XT** starters.

Accessories and Modification Codes

Side-Mounted Auxiliary Contact



Auxiliary Contact



Type 1 Enclosure



Electrically Held Base Contactor



Surge Suppressor



15.1 Accessories

Freedom NEMA	V10-T15-2
A200 NEMA	V10-T15-18
XT IEC	V10-T15-23
Enclosures	V10-T15-28
Lighting Contactors	V10-T15-30
IT Solid-State Soft Starters	V10-T15-36

15.2 Modification Codes

Modification Codes	V10-T15-39
--------------------------	------------

Freedom NEMA**Auxiliary Contacts****NEMA Sizes 00–2**

The auxiliary contacts listed below are designed for installation on Freedom Series starters and contactors. Snap-on design facilitates quick, easy installation.

These bifurcated design contact blocks, featuring silver cadmium alloy contacts, are well suited for use in very low energy (logic level) circuits.

Product Selection

	Description	Contact Configuration Code ^①	Catalog Number
Side-Mounted	Side-Mounted		
	1NO	10	C320KGS1
	1NC	01	C320KGS2
	1NO-1NC	11	C320KGS3
	2NO	20	C320KGS4
	2NC	02	C320KGS5
	1NO-1NCI	N/A	C320KGS6
	1NO (EC)-1NC (LO)	N/A	C320KGS7
	1NCI	N/A	C320KGS8
Top-Mounted	Top-Mounted		
	1NO	10	C320KGT1
	1NC	01	C320KGT2
	1NO-1NC	11	C320KGT3
	2NO	20	C320KGT4
	2NC	02	C320KGT5
	1NO-1NCI	N/A	C320KGT6
	1NO (EC)-1NC (LO)	N/A	C320KGT7
	1NCI	N/A	C320KGT8
	3NO	30	C320KGT9
	2NO-1NC	21	C320KGT10
	1NO-2NC	12	C320KGT11
	3NC	03	C320KGT12
	4NO	40	C320KGT13
	3NO-1NC	31	C320KGT14
	2NO-2NC	22	C320KGT15
	1NO-3NC	13	C320KGT16
	4NC	04	C320KGT17
	3NO-1NCI	N/A	C320KGT18
	2NO-1NCI-1NC	N/A	C320KGT19
	2NO-1NO (EC)-1NC (LO)	N/A	C320KGT20
1NO-1NC-1NO (EC)-1NC (LO)	N/A	C320KGT21	

Notes

NCI = Normally Closed early opening designed for use in reversing applications. EC = Early Closing. LO = Late Opening.

^① For reference only—not part of catalog number. See **Page V10-T15-3**.

Contact Configuration Code

This two-digit code is found on the auxiliary contact to assist in identifying the specific contact configuration.

The first digit indicates the quantity of NO contacts and the second indicates the quantity of NC contacts.

NEMA Sizes 3–8

Product Selection

Circuit	Contact Configuration Code ^①	NEMA Size	Catalog Number
Base Auxiliary Contact			
Base Auxiliary Contacts—NEMA Sizes 3–5			
NO	10	3	C320KGS31
NO-NC	11	3	C320KGS32
NO	10	4–5	C320KGS42
NO-NC	11	4–5	C320KGS42
Auxiliary Contact			
Auxiliary Contacts—NEMA Sizes 3–5			
NO	10	3–5	C320KGS20
NC	01	3–5	C320KGS21
NO-NC ^②	11	3–5	C320KGS22
Auxiliary Contacts—NEMA Sizes 6–8			
NO-NC	11	8	C320KA5
2NO-2NC	22	6–7	C320KA6

Auxiliary Contact Ratings (Amperes)

Ratings—NEMA A600

Current	AC Volts			
	120V	240V	480V	600V
Make and interrupting	60	30	15	12
Break	6	3	1.5	1
Continuous	10	10	10	10

Ratings—NEMA P300

DC Volts	Make/Break Amperes
Continuous Thermal Rating: 5A	
125	1.10
250	0.55

Ratings—Logic Level

Current	Rating
Minimum Ratings for Logic Level and Hostile Atmosphere Application	
Minimum amperes	20 mA
Minimum volts	24 Vac/Vdc

Ratings—C320KGS20L, C320KGS21L, C320KGS22L

DC-12		AC-12	
U_e	I_e	U_e	I_e
80	0.1	250	0.1

Notes

^① For reference only—not part of catalog number. See above.

^② NO-NC occupies two positions—L2 and L3, or R2 and R3. See **Page V10-T15-5**.

15.1

Accessories and Modification Codes

Accessories

Auxiliary Contact Location

NEMA Sizes 00–2

The sketches below illustrate the maximum number of auxiliary contacts that can be assembled to a contactor or starter and their locations.

Auxiliary Contacts

Size	Poles	Available Mounting Positions ①②		Catalog Number
		Open Type	Enclosed	
00	3	T1, L1, R1	L1	AN16
0–2	3	T1, L1	L1	
00–2	3	T1, T2	—	AN56
00	2–4	T1, L1, R1	L1	CN15
0–2	2–3	T1, L1	L1	
1, 2	4	T1, L1	—	
1, 2	5	T1, L1	—	
10A	2–4	T1, L1, R1	L1	CN35
20–60A	2–3	T1, L1	L1	
60A	4	T1, L1	—	
60A	5	T1, L1	—	
00–2	3	T1, T2	—	CN55

Auxiliary Contact Location

15

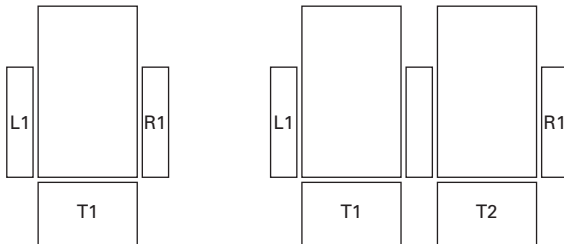

Top View

Top View

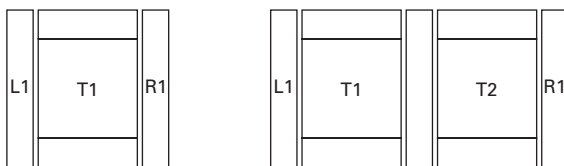

Front View

Front View

Non-Reversing
Contactors and Starters

Reversing
Contactors and Starters

Notes

- ① Available positions on contactors or starters other than what is factory installed.
- ② When a pneumatic timer is mounted on contactor, only side-mounted auxiliary contact positions are available. The solid-state timer, when added, takes up side-mounted auxiliary contact position.

NEMA Sizes 3–8

The sketches below illustrate the maximum number of auxiliary contacts that can be assembled to a contactor and their locations.

Note: A base auxiliary contact must be added in position R1 before additional auxiliary contacts can be mounted on NEMA Size 3 or in L1 on NEMA Sizes 4–5.

Mounting Positions

Size	Available Mounting Positions ^①
NEMA Size 3	R2, R3, L1, L2, L3
NEMA Sizes 4–5	L2, L3, R1, R2, R3
NEMA Sizes 6–7	R1
NEMA Size 8	L2, R2

Auxiliary Contact Location

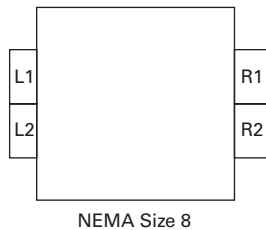
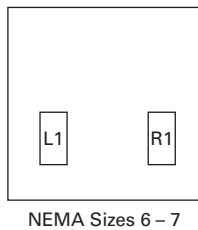
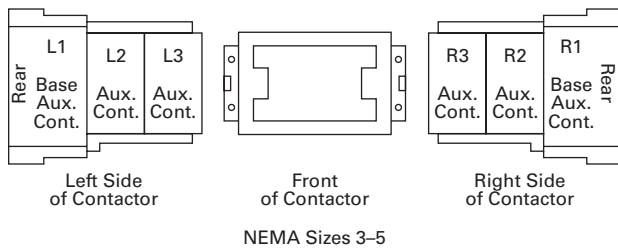

Note

^① Available positions on contactors or starters other than what is factory installed.

Heater Pack Selection

Heater packs H2001B to H2017B and H2101B to H2117B are to be used only with Series B overload relays Catalog Numbers C306DN3B (Part No. 10-7016) and C306GN3B (Part No. 10-7020). The load lugs are built into the overload relay base to allow load wiring prior to heater pack installation. The

previous heater design had integral load lugs. The Series B heater packs are electrically equivalent to the previous heater design. Heaters H2018-3 to H2024-3 have not changed.

Note: The series of a starter is the last digit of the listed catalog number. Example: AN16DN0A**B**.

Starters with Series B Overload Relays

Size	Series
NEMA—AN Type	
00-0	C
1-2	B
5	B
6	C
7-8	B

Fast Trip—Class 10 Heater Selection

Overload Relay Size	Motor Full Load Ampere Rating Dial Position				Catalog Number (Includes Three Heater Packs) ①
	A	B	C	D	
For Use with NEMA Sizes 00-0 Series C, NEMA Sizes 1-2 Series B					
32A or 75A	0.260	0.313	0.367	0.420	H2101B-3
	0.384	0.464	0.543	0.623	H2102B-3
	0.570	0.688	0.806	0.924	H2103B-3
	0.846	1.02	1.20	1.37	H2104B-3
	1.28	1.55	1.83	2.10	H2105B-3
	1.92	2.33	2.74	3.15	H2106B-3
	2.30	2.79	3.28	3.77	H2107B-3
	3.38	4.10	4.82	5.54	H2108B-3
	7.07	6.03	7.09	8.16	H2109B-3
	7.07	8.58	10.1	11.6	H2110B-3
	9.60	11.2	12.8	14.4	H2111B-3
	14.4	17.5	20.7	23.8	H2112B-3
	18.7	21.8	25.0	28.1	H2113B-3
23.5	27.3	31.0	34.8	H2114B-3	
For Use with NEMA Size 2—Series B					
75A	28.3	32.6	37.0	41.3	H2115B-3
	36.6	42.3	48.1	53.8	H2116B-3
	53.8	60.8	67.9	74.9	H2117B-3
For Use with Size 5 Starters Only—Series B					
32A ②	51	61	72	82	H2104B-3
	77	93	110	126	H2105B-3
	115	140	164	189	H2106B-3
	138	167	197	226	H2107B-3
	203	246	289	—	H2108B-3
For Use with Size 6 Starters Only—Series B					
32A ②	154	186	220	252	H2105B-3
	230	280	329	378	H2106B-3
	276	335	394	452	H2107B-3
	406	492	578	—	H2108B-3
For Use with Size 7 Starters Only—Series B					
32A ②	169	204	240	274	H2104B-3
	256	310	366	420	H2105B-3
	384	466	543	630	H2106B-3
	460	558	656	754	H2107B-3
	676	820	—	—	H2108B-3
For Use with Size 8 Starters Only—Series B					
32A ②	254	306	360	411	H2104B-3
	384	465	549	630	H2105B-3
	576	699	822	945	H2106B-3
	690	837	984	1131	H2107B-3
	1014	1230	—	—	H2108B-3

Notes

- ① Heater packs are shipped three to a carton. Catalog numbers are for three heater packs.
- ② Sizes 5-8 use the 32A overload relay with current transformers.

Standard Trip—Class 20 Heater Selection

Overload Relay Size	Motor Full Load Ampere Rating Dial Position				Catalog Number (Includes Three Heater Packs) ①
	A	B	C	D	
For Use with NEMA Sizes 00–0 Series C, NEMA Sizes 1–2 Series B					
32A or 75A	0.254	0.306	0.359	0.411	H2001B-3
	0.375	0.452	0.530	0.607	H2002B-3
	0.560	0.676	0.791	0.907	H2003B-3
	0.814	0.983	1.15	1.32	H2004B-3
	1.20	1.45	1.71	1.96	H2005B-3
	1.79	2.16	2.53	2.90	H2006B-3
	2.15	2.60	3.04	3.49	H2007B-3
	3.23	3.90	4.56	5.23	H2008B-3
	4.55	5.50	6.45	7.40	H2009B-3
	6.75	8.17	9.58	11.0	H2010B-3
	9.14	10.8	12.4	14.0	H2011B-3
	14.0	16.9	19.9	22.8	H2012B-3
	18.7	22.7	26.7	30.7	H2013B-3
	23.5	28.5	33.5	38.5	H2014B-3
For Use with NEMA Size 2—Series B					
75A	29.0	34.0	39.1	44.1	H2015B-3
	39.6	45.5	51.5	57.4	H2016B-3
	53.9	60.9	67.9	74.9	H2017B-3
For Use with NEMA Sizes 3–4—Series A					
105A or 144A	8.0	9.2	10.3	11.5	H2025-3
	11.4	12.8	14.3	15.7	H2026-3
	14.3	15.7	17.4	19.0	H2027-3
	18.0	20.2	22.3	24.5	H2018-3
	24.6	27.6	30.5	33.4	H2019-3
	33.5	37.5	41.5	45.6	H2020-3
	45.7	51.2	56.7	62.1	H2021-3
	62.2	69.7	77.1	84.6	H2022-3
	84.7	95.0	105.0	115.0	H2023-3
	106.0	118.0	131.0	144.0	H2024-3
For Use with Size 5 Starters—Series B					
32A ②	49	59	69	79	H2004B-3
	72	87	103	118	H2005B-3
	107	130	152	174	H2006B-3
	129	156	182	209	H2007B-3
	194	234	274	—	H2008B-3
For Use with Size 6 Starters Only—Series B					
32A ②	144	174	205	235	H2005B-3
	215	259	304	348	H2006B-3
	258	312	365	419	H2007B-3
	388	468	547	627	H2008B-3
For Use with Size 7 Starters Only—Series B					
32A ②	163	197	230	264	H2004B-3
	240	290	342	392	H2005B-3
	358	432	506	580	H2006B-3
	430	520	608	698	H2007B-3
	646	780	912	—	H2008B-3
For Use with Size 8 Starters Only—Series B					
32A ②	244	295	345	396	H2004B-3
	360	435	513	588	H2005B-3
	537	648	759	870	H2006B-3
	645	780	912	1047	H2007B-3
	969	1170	1368	—	H2008B-3

Notes

① Heater packs are shipped three to a carton. Catalog numbers are for three heater packs.

② Sizes 5–8 use the 32A overload relay with current transformers.

DC Magnet Coils

When Ordering Specify

Conversion Kit for Field Assembly

- Catalog number

Factory Installed DC Coil

- For factory installed DC magnet coil on AC contactors or non-combination starters (open type only), substitute the code suffix from table below for the magnet coil identifier in the device catalog number.

Example: For Size 0 AC contactor with a 24 Vdc coil, change CN15BN3AC to CN15BN3T1C

Application

- Connect for separate control
- Not for use with cover control switch operators
- Use twin break, heavy-duty pilot devices
- Designed for +10%, -20% rated voltage, continuous duty operation

Non-Reversing Kit Consists of:

- One encapsulated DC magnet coil
 - One NCI or NO/NCI side-mounted auxiliary contact
- Note:** These kits are supplied with a NO/NCI side-mounted auxiliary contact in place of the NCI contact.
- Two blue colored connection wires
 - One instruction publication

Operation

These DC coil kits have separate pickup and seal windings. A **special** (side-mounted) early-break NCI auxiliary contact is used to either disconnect the pickup winding or insert the seal winding in series with the pickup winding, depending on the frame size of the contactor. DC coil kits come in two styles, a suffix **1** and a suffix **4**. The 1 suffix contains only the **special** (side-mounted) early break NCI auxiliary contact. The 4 suffix contains a NO contact in the same package as the **special** (side-mounted) early-break NCI auxiliary contact.

Note: NEMA Sizes 00 and 0 contactors may use either suffix 1 or 4 DC coil kits; starters

may use suffix 4 DC coil kits only. For NEMA Sizes 1 and 2, both contactors and starters may use a suffix 4 DC coil kit only.

On the above sizes only, when the **special** auxiliary package is mounted on the side of a contactor or starter, **no** standard auxiliary contact may be mounted on the same side.

Note: For NEMA Sizes 3–5, the special coil NCI clearing contact is an add-on auxiliary (**must** mount on a base mount auxiliary contact; normally a 1NO). This arrangement will normally account for two of the three contact positions on the side of each contactor or starter.

See figure on **Page V10-T15-9**.

Product Selection

Contactor or Starter Size	Conversion Data				NCI Interlock Number	Factory Installed Code Suffix	Complete Conversion Kit	
	NEMA	Volts	Magnet Coil Coil Number	Amps P.U./Seal			Watts P.U./Seal	Ship Wt. Lbs (kg)
Non-Reversing — Kit includes NCI Side-Mounted Auxiliary Contact								
00 and 0 CN35-A, B, D D15 relays	12	9-2988-11	6.4/0.28	76.8/3.36	C320KGD1	R1	1.0 (0.5)	C335KD3R1
	24	9-2988-12	3.2/0.14	76.8/3.36	C320KGD1	T1		C335KD3T1
	48	9-2988-13	1.6/0.07	76.8/3.36	C320KGD1	W1		C335KD3W1
	120	9-2988-14	0.64/0.028	76.8/3.36	C320KGD1	A1		C335KD3A1
① 00 and 0 CN35-A, B, D D15 relays	12	9-2988-11	6.4/0.28	76.8/3.36	C320KGD2 ①	R4	1.0 (0.5)	C335KD3R4
	24	9-2988-12	3.2/0.14	76.8/3.36	C320KGD2 ①	T4		C335KD3T4
	48	9-2988-13	1.6/0.07	76.8/3.36	C320KGD2 ①	W4		C335KD3W4
	120	9-2988-14	0.64/0.028	76.8/3.36	C320KGD2 ①	A4		C335KD3A4
1 and 2 CN35-G	12	9-2990-1	15.4/0.42	185/4.98	C320KGD5	R4	1.0 (0.5)	C335KD4R4
	24	9-2990-2	7.7/0.21	185/4.96	C320KGD5	T4		C335KD4T4
	48	9-2990-3	3.9/0.11	185/5.04	C320KGD5	W4		C335KD4W4
	120	9-2990-4	1.5/0.041	185/4.87	C320KGD5	A4		C335KD4A4
3 CN35-K	12	9-3002-1	24/0.40	293/4.84	C320KGD3	R1	2.0 (0.9)	C335KD5R1
	24	9-3002-2	12/0.20	288/4.75	C320KGD3	T1		C335KD5T1
	48	9-3002-3	6.1/0.097	295/4.67	C320KGD3	W1		C335KD5W1
	120	9-3002-4	2.5/0.038	298/4.57	C320KGD3	A1		C335KD5A1
4 and 5 CN35-N, S	24	9-2026-4	18/0.22	400/5.3	C320KGD3	T1B	2.5 (1.1)	C335KA3T1
	48	9-2026-3	9/0.11	400/5.2	C320KGD3	W1B		C335KA3W1
	120	9-2026-2	3.3/0.05	450/5.4	C320KGD3	A1B		C335KA3A1
	240	9-2026-1	1.7/0.02	440/4.9	C320KGD3	B1B		C335KA3B1

Note

① These kits are supplied with a NO/NCI side-mounted auxiliary contact in place of the NCI contact.

Product Selection, continued

Contactor or Starter Size	Conversion Data				NCI Interlock Number	Factory Installed Code Suffix	Complete Conversion Kit	
	Volts	Magnet Coil Coil Number	Amps P.U./Seal	Watts P.U./Seal			Ship Wt. Lbs (kg)	Catalog Number
NEMA								
Reversing								
00 and 0 CN35-A, B, D D15 relays	12	9-2988-1	6.4/0.28	76.8/3.36	C320KGD1	R1 ①	1.0 (0.9)	C335KD3R1 ②
	24	9-2988-2	3.2/0.14	76.8/3.36	C320KGD1	T1 ①		C335KD3T1 ②
	48	9-2988-3	1.6/0.07	76.8/3.36	C320KGD1	W1 ①		C335KD3W1 ②
	120	9-2988-4	0.64/0.028	76.8/3.36	C320KGD1	A1 ①		C335KD3A1 ②
1 and 2 CN35-G	12	9-2990-1	15.4/0.42	185/4.98	C320KGD3	R1 ①	—	③
	24	9-2990-2	7.7/0.21	185/4.96	C320KGD3	T1 ①		③
	48	9-2990-3	3.9/0.11	185/5.04	C320KGD3	W1 ①		③
	120	9-2990-4	1.5/0.041	185/4.87	C320KGD3	A1 ①		③

Elementary Diagrams

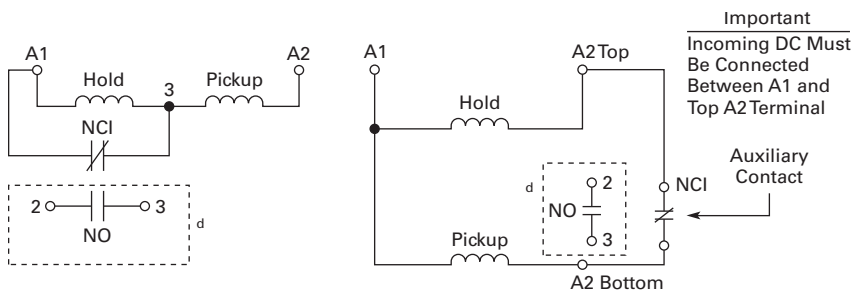

DC Coil Elementary Diagram for NEMA Sizes 1-3 Contactors and Starters

DC Coil Elementary Diagram for NEMA Sizes 00, 0, 4 and 5 Contactors and Starters

Notes

- ① Factory installed DC coils on NEMA contactors and starters include a NO/NC top-mounted auxiliary contact on each contactor for electrical interlocking.
- ② Kit does not include mechanical interlock or crossover wiring. Two NO/NCI top-mounted auxiliary contacts are supplied for electrical interlocking.
- ③ Available factory assembled only.
- ④ 1NO available in suffix 4 kits only.

15.1 Accessories and Modification Codes

Accessories

Remote Reset Module (32A Overload Relay)

The C316RR remote reset module for the C316F, C316S and C316U overload relays allows remote resetting of tripped (32A) overload relays by means of an electrical solenoid attachment that mounts on the side of the overload relay.

Product Selection

Remote Reset Module Operating Voltage	Catalog Number
24V 50/60 Hz	C316RR1U
110V 50/60 Hz	C316RR1A

Dimensions

Approximate Dimensions in Inches (mm)

Note: The operating coil is not suitable for a continuous duty. Recommended impulse duration 0.2–0.35 seconds with 15 operations maximum per hour.

Remote Reset Module

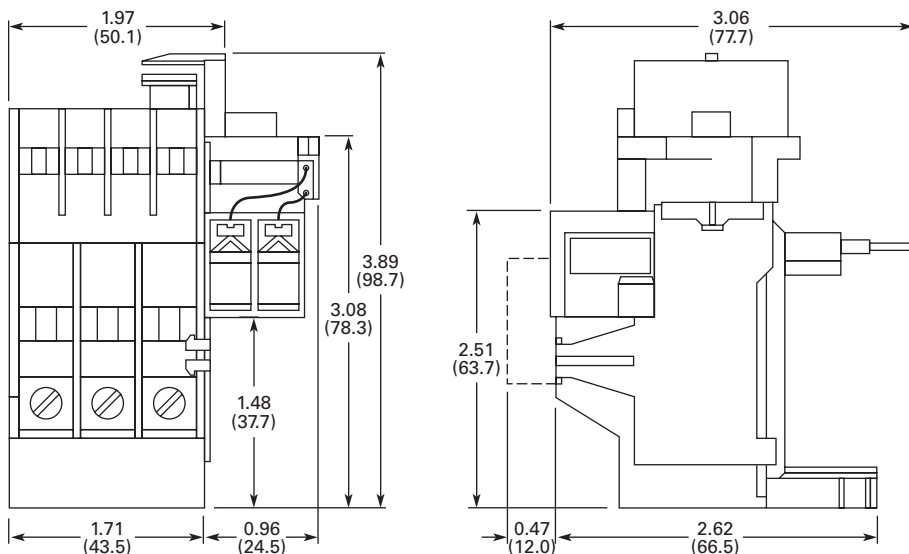

Three-Pole Top-Mounted Fuse Block Kit

NEMA Sizes 00–2

Field mount to Freedom Series starters and contactors. Designed to save space and reduce installation costs. They provide short-circuit protection for branch circuits.

Mounted Fuse Block Kit

Fuse Block Kit

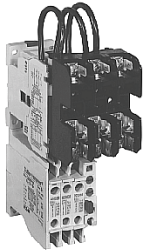

Fuse Block Kits

Fuse Type	Catalog Number	Fuse Type	Catalog Number
Class H — 30A 250V	C350KH21	Class T — 60A 300V	C350KT32
Class R — 30A 250V	C350KR21	Class J — 30A 600V	C350KJ61
Class G — 15A 300V	C350KG37	Class J — 60A 600V	C350KJ62
Class G — 20A 300V	C350KG38	Type M — 30A 600V ①	C350KM61
Class G — 30A 300V	C350KG31	Class CC — 30A 600V	C350KC63
Class G — 60A 300V	C350KG32	Class T — 30A 600V	C350KT61
Class T — 30A 300V	C350KT31	Class T — 60A 600V	C350KT62

Dimensions

Approximate Dimensions in Inches (mm)

Mounted Fuse Block

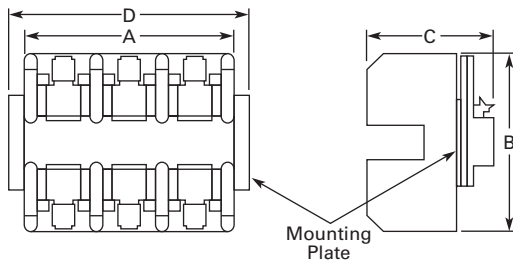

Fuse Block

Class	Amperes	Volts	Wide A	High B	Deep C	D
G	15, 20, 30	300	2.40 (61.0)	3.00 (76.2)	2.04 (51.8)	—
	60	300	2.62 (66.5)	4.25 (108.0)	2.08 (52.8)	—
H	30	250	3.00 (76.2)	3.10 (78.7)	2.23 (56.6)	3.62 (91.9)
J	30, 60	600	4.81 (122.2)	4.12 (104.6)	2.82 (71.6)	—
M, CC	30	600	2.40 (61.0)	3.00 (76.2)	2.04 (51.8)	—
R	30	250	3.00 (76.2)	3.10 (78.7)	2.23 (56.6)	3.62 (91.9)
T	30, 60	300	3.44 (87.4)	3.00 (76.2)	2.33 (59.2)	—
	30	600	3.75 (95.3)	3.31 (84.1)	2.26 (57.4)	—
	60	600	4.87 (123.7)	3.00 (76.2)	2.58 (65.5)	—

Note

① Type M fuse block not approved for branch circuit protection.

Mechanical Interlock and Reversing Kits

Mechanical interlocks and reversing kits are designed for field assembly of reversing contactors or starters from Freedom Series components. The reversing kits include a mechanical

interlock, stabilizer bar and a pre-cut, trimmed and formed wire set. Auxiliary contacts, if required, must be ordered separately. See **Page V10-T15-2**.

Mechanical Interlock



Mechanical Interlock Only ^{①②}

Application		
NEMA Size	Contactors Mounting	Catalog Number
00-2	Horizontal	C321KM60B
3	Horizontal	C321KM30
3 to 4	Horizontal	C321KM43
4	Horizontal	C321KM40
4 to 5	Horizontal	C321KM45
4 to 6	Horizontal	C321KM80
5	Horizontal	C321KM50
5 to 6	Horizontal	C321KM56
6	Horizontal	C321KM70
6 to 7	Horizontal	C321KM90
7	Horizontal	C321KM34
4 or 5 to 6	Vertical	C321KM55
5 to 6	Vertical	C321KM65
6	Vertical	C321KM66
6 to 7	Vertical	C321KM67

Reversing Kits (Horizontal Contactor Mounting Only)

Application		Application	
NEMA Size	Catalog Number	NEMA Size	Catalog Number
00	C321KM60K14B	—	C321KM60K21 ^③
0	C321KM60K13B	—	C321KM60K18 ^③
1	C321KM60K15B	4	C321KM60K19 ^③
2	C321KM60K16B	5	C321KM60K20 ^③
3	C321KM60K17 ^③	—	C321KM60K44 ^③

Solid-State Timers

Solid-State ON DELAY Timer—Side-Mounted on Freedom Series NEMA 00-2 and C25D, C25E and C25F Frame

This timer is designed to be **wired in series with the load** (typically a coil). When the START button is pushed (power applied to timer), the

ON DELAY timing function starts. At the completion of the set timing period, timer and series wired load will both be energized.

Solid-State Timer



Mounted Timer Product Selection

Timing Range	Catalog Number ^{④⑤⑥}
0.1-1.0 seconds	C320TDN1_
1-30 seconds	C320TDN30_
30-300 seconds	C320TDN300_
5-30 minutes	C320TDN2000_

Pneumatic Timers—Top-Mounted

Attachment mounts on top of any NEMA Size 00-2 Freedom Series starter or contactor (top-mounted auxiliary contacts can not be installed on device when timer

is used). Timer unit has 1NO-1NC isolated timed contacts—circuits in each pole must be the same polarity. Units are convertible from OFF to ON DELAY or vice-versa.

Pneumatic Timer



Product Selection

Timing Range	Catalog Number
0.1-30 seconds	C320TP1
10-180 seconds	C320TP2

Maximum Ampere Ratings

Description	Volts AC			
	120	240	480	600
Make	30	15	7.5	6
Break	3	1.5	0.75	0.6

Notes

- ① Without cross-wiring.
- ② For use with latest series product.
- ③ Kit includes two NC auxiliary contacts.
- ④ Add operating voltage suffix to catalog number. **A** = 120V, **B** = 240V, **E** = 208V.
- ⑤ Rated 0.5A pilot duty—not to be used on larger contactors.
- ⑥ Terminal connections are quick connects only. Two per side.

Locking Cover for Overload Relay—C306 Only

Snap-on transparent or opaque plastic panel for covering access port to the overload relay trip setting

dial—helps prevent accidental or unauthorized changes to trip and reset setting.

Locking Cover



Product Selection

Description	Minimum Ordering Qty. (Std. Pkg.)	Catalog Number
Clear cover, no accessibility	50	C320PC3
Gray cover, no accessibility, with auto only nib	50	C320PC4
Gray cover, no accessibility, with manual only nib	50	C320PC5
Gray cover with FLA dial accessibility, A, B, C, D positions and auto only nib	50	C320PC6
Gray cover with FLA dial accessibility, A, B, C, D positions and manual only nib	50	C320PC7

Control Circuit Fuse Block

These panel mounted fuse holders, designed for control circuit protection or other similar low current requirements, have extractor type fuse caps. The Class CC rejection type fuses (KTK-R) used in these holders are intended for use with

equipment designated as being suitable for use on systems having high available fault currents. If branch circuit protective device is 45A or greater, C320FBR fuse kit may be required for control circuit protection per NEC 430-72.

Control Circuit Fuse Block



Product Selection

Type	Maximum Amperes	Catalog Number
Fuse holder only	15	C320FB ①
	30	C320FBR ②

Dimensions

Approximate Dimensions in Inches (mm)

Control Circuit Fuse Block

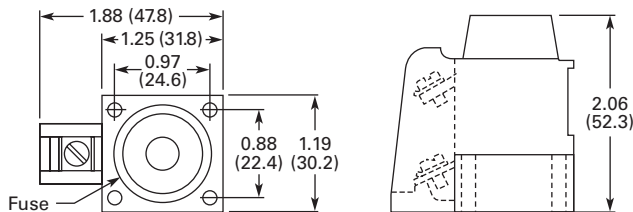

Transient Suppressor Kits

NEMA Sizes 00–2

These kits limit high voltage transients produced in the control circuit when power is removed from the contactor or starter coil. There are three separate suppressors for use on 24–120V, 208–240V or 277–480V coils respectively.

These devices mount directly to the coil terminals of Freedom Series contactors or starters NEMA Sizes 00–2 and lighting contactors 10–60A. Reversing devices will require two.

Transient Suppressor NEMA Sizes 00–2



Product Selection

Description	Coil Voltage 50/60 Hz ③	Catalog Number
Transient suppressor	24–120V	C320TS1
	208–240V	C320TS2
	277–480V	C320TS3

NEMA Sizes 3–5

This device mounts on top of any side-mounted auxiliary contact on Freedom Series NEMA Sizes 3–5 and lighting contactors 100–300A. It connects across coil terminals on any 120V contactor or starter magnet

coil (reversing starters or contactors require 2).

Limits high voltage transients produced in the circuit when power is removed from the coil.

Transient Suppressor NEMA Sizes 3–5



Product Selection

Description	Coil Voltage	Catalog Number
Transient suppressor	120V	C320AS1

Shorting Bar Kits

These kits provide phase-to-phase power connections of contactors for field assembly. The kits include bus

connections and mounting hardware. The shorting bars connect all three phases of a single contactor.

Product Selection

Description	Catalog Number	Description	Catalog Number
NEMA Size 3	C321SB18	NEMA Size 5	C321SB21
NEMA Size 4	C321SB19	NEMA Size 6	C321SB22

Notes

- ① A fuse is not supplied, but holder will accept a Bussman Type KTK or KTK-R (13/32 in x 1-1/2 in) fuse, 600V maximum.
- ② Includes a 5A, 600V KTK-R fuse.
- ③ Suppressor is compatible with coil voltages/ranges as shown, 50 and 60 Hz.

15.1

Accessories and Modification Codes

Accessories

DC/AC Interface Module

The catalog number C320DC Interface Module is an optically isolated solid-state switch which provides a means of operating AC coils with 5–48 Vdc control signal. It acts as a space saving interposing relay which can switch a specified 50/60 Hz AC source to the contactor or starter coil.

The module may be directly attached to the coil terminals of any Freedom Series contactor or starter—NEMA Sizes 00–3 and lighting contactors 10–100A. It also has provisions for DIN rail mounting.

The module will operate coils within the voltage ranges shown in the table below.

Design Characteristics

- DC Input: 5–48 Vdc at mA nominal
- AC operating voltage: 240 Vac (360 VA) $\pm 10\%$ 50/60 Hz
- DC operating voltage: 30 Vdc maximum (0.5A)
- AC current rating
 - 10A make (inrush)
 - 1A break (sealed)

Controller Coil Voltage Ranges

Controller Catalog Number Prefix	Controller Size or Rating	Coil Range Volts AC
AN16, AN56, CN15, CN55	00–0	24–240
	1–2	48–240
	3	110–240
CN35	10–30A	24–240
	60A	48–240
	100A	110–240

Typical Application

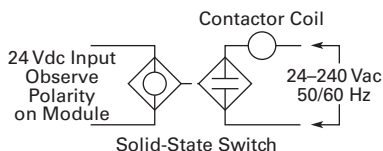

DC/AC Interface Module



Product Selection

Coil Voltage	Catalog Number
5 Vdc	C320DC2V5
6 Vdc	C320DC2V6
9 Vdc	C320DC2V9
12 Vdc	C320DC2V12
48 Vdc	C320DC2V48

Finger Protection Shields

Snap-on shields for both contactors and starters provide Type IP20 finger

protection. Prevents accidental contact with line/load terminals.

Product Selection

Application	Catalog Number
NEMA Size 00	C320LS1
NEMA Size 0	C320LS2
NEMA Sizes 1–2	
Contactors	C320LS3
Reversing contactors	C320LS4
NEMA Size 1	
Starters	C320LS5
Reversing starters	C320LS6
NEMA Size 2	
Starters	C320LS7
Reversing starters	C320LS8

Adapter to DIN Rail Mount

NEMA 1–2 Contactors

Designed to allow DIN rail mounting of NEMA 1–2 contactors. Includes all hardware required to convert contactors from panel mounting to 35 mm DIN rail mounting.

Product Selection

Description	Catalog Number
Adapter to DIN rail mount	C320DN65

Adhesive Dust Cover

NEMA Sizes 00–2

These adhesive stickers come 25 to a package and provide extra protection from contaminants when applied to the sides of Freedom NEMA Sizes 00–2.

Adhesive covers are easily applied to side opening where auxiliaries are not installed and provide extra protection from metal filings and other debris.

Product Selection

Description	Catalog Number
25 to a package	C320DSTCVR

Add-On Power Pole Kit

NEMA Sizes 00–2

This device mounts on the side of Freedom NEMA Size 00–2 contactors. One unit can be mounted on each side and carries UL, cUL and IEC ratings. The device is rated for resistive, inductive and lighting applications.

Product Selection—Add-On Power Pole Kit

UL Ampere Rating				IEC 947 Ampere Rating					
Inductive 600V	Resistive 600V	hp Single-Phase		Locked Rotor 240V	Lighting Ballast Tungsten 480V	AC-1 600V	AC-3 600V	AC-5a AC-5b 480V	1NO Power Pole Catalog Number
		115V	230V						
15	20	1/2	2	96	20	20	12	18	C320PPD10

Fuse Clips

C351 Fuse Clip Kit



C351—Fuse Clip Selection—Three Poles

Starter Size	Motor Voltage	Maximum hp (Three-Phase) Dual Element Fuses	Fuse Clip Rating		Fuse Clip Kit Factory Installed Position 10 Alpha ^①	Fuse Clip Kit for Field Installation in Non-Fusible Starter For Non-Rejection Type Fuses		For Use with "R" Rejection Type Fuses	
			Amperes	Volts		Catalog Number	Catalog Number		
Non-Fusible—without Fuse Clips Installed						A			
0	200/230	3	30	250	B	C351KC21	C351KC21R		
	460/575	5	30	600	C	C351KD22-61	C351KD22-61R		
1	200/230	7-1/2	30	250	B	C351KC21	C351KC21R		
	460/575	10	30	600	C	C351KD22-61	C351KD22-61R		
2	200	10	60	250	D	C351KD22-61	C351KD22-61R		
	230	15	60	250	D	C351KD22-61	C351KD22-61R		
	460/575	25	60	600	E	C351KD62	C351KD62R		
3	200	25	100	250	F	C351KE23-63 ^②	C351KE23-63 ^②		
	230	30	100	250	F	C351KE23-63 ^②	C351KE23-63 ^②		
	460/575	50	100	600	G	C351KE23-63 ^②	C351KE23-63 ^②		
4	200	40	200	250	H	C351KF24-64 ^②	C351KF24-64 ^②		
	230	50	200	250	H	C351KF24-64 ^②	C351KF24-64 ^②		
	460/575	100	200	600	J	C351KF24-64 ^②	C351KF24-64 ^②		
5	200	75	400	250	K	Not available in kit form	Not available in kit form		
	230	100	400	250	K				
	460/575	200	400	600	L				

Notes

- ① These fuse clips are for Class R fuses.
 - ② Fuse clip "R" rejection members for use with Class R fuses are supplied loose in the fuse clip kits.
- Kits do not include fuses.

Control Power Transformer Kits

These control transformer kits provide a convenient on-the-job addition of control transformers to the following Type 1, 3R, 4/4X and 12 enclosed starters. Adding or changing these kits does not affect the UL listing in most instances.

The transformer kit consists of:

- Control transformer
- Two primary and one secondary fuse
- Wires
- Mounting instruction publication

For Non-Combination Starters

These kits may be used for transformer voltage conversion on Freedom NEMA starters furnished from the factory with control transformers installed. Non-combination starters with CPTs factory installed are Class ECN07, ECA07, ECE07 and ECE11. These kits may also be installed in oversize enclosures that have been designed to accept transformers.

Combination Starters

Most combination starters have space for standard size (and 100 VA extra capacity) control power transformers. The panels are pre-drilled for mounting.

UL/CSA

UL Listed—File Number E10156, Guide XPTO.

When Ordering Specify

- Catalog number

Standard Transformer Sizes ^①

Size	VA Capacity	
	Freedom	Vacuum
0	50	—
1, 2	100	—
3	150	—
4	200	100
5	200	150
6	250	350

Control Transformer Kits

Control Transformer Kit



Continuous VA	Primary 208/277V Secondary 120V, 60 Hz	Primary 240/480V, 60 Hz 220/440V, 50 Hz Secondary 120V, 60 Hz 110V, 50 Hz	Primary 380V Secondary 110V, 50 Hz	Primary 600V, 60 Hz 550V, 50 Hz Secondary 120V, 60 Hz 110V, 50 Hz	Primary 240/480V Secondary 24V, 60 Hz
	Catalog Number	Catalog Number	Catalog Number	Catalog Number	Catalog Number
50	C341AE	C341AC	C341AL	C341AD	C341AS
75	C341BE	C341BC	C341BL	C341BD	C341BS
100	C341CE	C341CC	C341CL	C341CD	C341CS
150	C341DE	C341DC	C341DL	C341DD	C341DS
200	C341EE	C341EC	C341EL	C341ED	C341ES
250	C341FE	C341FC	C341FL	C341FD	C341FS
300	C341GE	C341GC	C341GL	C341GD	C341GS
350	C341HE	C341HC	C341HL	C341HD	C341HS
500	C341JE	C341JC	C341JL	C341JD	C341JS

Note

^① Non-reversing, single contactor only.

Dimensions

Approximate Dimensions in Inches (mm)

Open Type—50–500 VA with Fuse Block

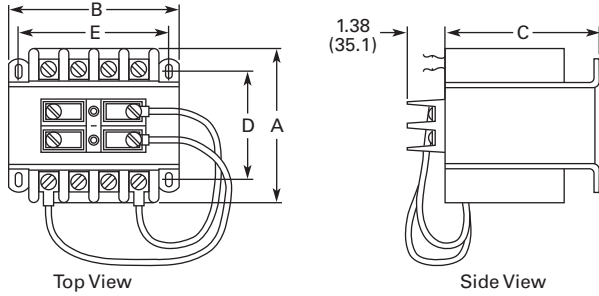

Continuous VA	Wide A	High B	Deep C	Mounting D	E	Slots	Ship Wt. Lbs (kg)
50	3.00 (76.2)	3.00 (76.2)	2.56 (65.0)	2.00 (50.8)	2.50 (63.5)	0.203 x 0.375 (5.2 x 9.5)	3.0 (1.4)
75	3.50 (88.9)	3.00 (76.2)	2.56 (65.0)	2.50 (63.5)	2.50 (63.5)	0.203 x 0.375 (5.2 x 9.5)	4.3 (2.0)
100	3.38 (85.9)	3.38 (85.9)	2.88 (73.2)	2.38 (60.5)	2.81 (71.4)	0.203 x 0.375 (5.2 x 9.5)	4.6 (2.1)
150	4.00 (101.6)	3.75 (95.3)	3.18 (80.8)	2.88 (73.2)	3.12 (79.2)	0.203 x 0.375 (5.2 x 9.5)	7.0 (3.2)
200	4.00 (101.6)	4.50 (114.3)	3.81 (96.8)	2.50 (63.5)	3.75 (95.3)	0.203 x 0.375 (5.2 x 9.5)	7.7 (3.5)
250	4.38 (111.3)	4.50 (114.3)	3.81 (96.8)	2.88 (73.2)	3.75 (95.3)	0.203 x 0.375 (5.2 x 9.5)	10.0 (4.5)
300	4.75 (120.7)	4.50 (114.3)	3.81 (96.8)	3.25 (82.6)	3.75 (95.3)	0.203 x 0.375 (5.2 x 9.5)	13.0 (5.9)
350	5.25 (133.4)	4.50 (114.3)	3.81 (96.8)	3.75 (95.3)	3.75 (95.3)	0.203 x 0.375 (5.2 x 9.5)	14.0 (6.4)
500	5.50 (139.7)	5.25 (133.4)	4.75 (120.7)	4.25 (108.0)	4.38 (111.3)	0.312 x 0.688 (7.9 x 17.5)	18.0 (8.2)

A200 NEMA

Factory Modifications

A200 Factory Modifications

Modification	Description	NEMA Size									Catalog Number Suffix	
		00-1	2	3	4	5	6	7	8	9		
Control circuit	1 Extra auxiliary contact (1NO-1NC)											J1
	Non-reversing, reversing	✓	✓	✓	✓	✓	✓	✓	✓	✓	✓	
	Two-speed unwired	✓	✓	✓	✓	✓	✓	✓	✓	✓	✓	
	2 Extra auxiliary contact											J2
	Non-reversing	✓	✓	✓	✓	✓	✓	✓	✓	✓	✓	
	Reversing, two-speed unwired	✓	✓	✓	✓	✓	✓	✓	✓	✓	✓	
	3 Extra auxiliary contact											J3
Non-reversing, unwired	✓	✓	✓	✓	—	—	—	—	—	—		
4 Extra auxiliary contact											J4	
Non-reversing, unwired	✓	✓	✓	✓	—	—	—	—	—	—		
	Wired for separate control (NC)	—	—	—	—	—	—	—	—	—	C	
	Omit control wiring (NC)	✓	✓	✓	✓	✓	✓	✓	✓	✓	X	
Overload relays (substitutions)	Ambient compensated with auto reset (NC)	—	—	—	—	—	—	—	—	—	D	
	Fast trip—ambient compensated (specify motor FLA)	✓	✓	✓	✓	✓	✓	—	—	—	D7	
	Overload relay alarm contact (NO) per overload	✓	✓	✓	✓	✓	✓	—	—	—	E	

Type J Auxiliary Contact

- Capable of being field mounted in a contactor or starter (Classes A200, A900 Sizes 00-6, V200, V201 vacuum and definite purpose controllers)
- Provides two separate electrical contact sets which wire vertically and are color coded; black designates NC and silver designates NO. Please note that the vertical wiring is contrary to the horizontal wiring of the L-56 auxiliary contacts
- Designed to fit within dimensions of starter; no additional panel space is required
- Provides circuit isolation (no polarity restrictions) and single break bifurcated contacts

Auxiliary Contact Ratings

Voltage	Make	Break
NEMA A600		
120-600 Vac	7200 VA	720 VA
72-120 Vac	60A	720 VA
28-72 Vac	60 VA	10A
NEMA R300		
28-300 Vdc	28 VA	28 VA

Auxiliary Contact



Auxiliary Contact Types

Contact Type	Maximum	Catalog Number
1NO and 1NC	4	J11
2NC	4	J02
2NO	4	J20
1 coil clearing NC and 1NO	4	J1C

Heater Selection

General Information on Heater Coil Selection

For maximum motor protection and compliance with Article 430-32 of the National Electrical Code, select heater coils from the tables in this section on the basis of motor nameplate full load current.

When the full load current is unknown, selection may be made on the basis of average full load currents. **Caution—The average ratings could be high or low for a specific motor and therefore**

selection on this basis always involves risk. For fully reliable motor protection, select heater coils on the basis of full load current rating as shown on the motor nameplate.

Heater coils are rated to protect 40°C rise motors, and open and drip-proof motors having a **service factor of 1.15** where the motor and the controller are at the same ambient temperature.

For other conditions:

1. For 50°C, 55°C, 75°C rise motors and **enclosed motors having a service factor of 1.0, select one size smaller coil.**
2. Ambient temperature of controller lower than motor by 26°C (47°F), use one size smaller coil.
3. Ambient temperature of controller higher than motor by 26°C (47°F), use one size larger coil.

Ultimate tripping current of heater coils is approximately 1.25 times the minimum current rating listed in the tables.

Heater Selection—Type A and B Overload Relays, Sizes 3 and 4

Size Starter	Ambient Compensated Enclosed Starters	Non-Compensating Enclosed Starters	Heater (One Heater per Catalog Number)
	All Applications	Full Load Current of Motor Amps	Catalog Number
For Size 4 Starters	12.8–14.1	11.9–13.0	FH68
	14.2–15.5	13.1–14.3	FH69
	15.6–17.1	14.4–15.9	FH70
	17.2–18.9	16.0–17.4	FH71
	19.0–20.8	17.5–19.1	FH72
	20.9–22.9	19.2–21.1	FH73
	23.0–25.2	21.2–23.2	FH74
	25.3–27.8	23.3–25.6	FH75
	27.9–30.6	25.7–28.1	FH76
	30.7–33.5	28.2–30.8	FH77
For Size 3 Starters	33.6–37.5	30.9–34.5	FH78
	37.6–41.5	34.6–38.2	FH79
	41.6–56.3	38.3–42.6	FH80
	46.4–50	42.7–46	FH81

Size Starter	Ambient Compensated Enclosed Starters	Non-Compensating Enclosed Starters	Heater (One Heater per Catalog Number)
	All Applications	Full Load Current of Motor Amps	Catalog Number
For Size 4 Starters	51–55	47–51	FH82
	56–61	52–56	FH83
	62–66	57–61	FH84
	67–73	62–67	FH85
	74–78	68–72	FH86
	79–84	73–77	FH87
	85–92	78–84	FH88
	93–101	85–91	FH89
	102–110	92–99	FH90
	111–122	100–110	FH91
For Size 3 Starters	123–129	111–122	FH92
	130–133	123–128	FH93
	—	129–133	FH94

Heater Selection—Type A and B Overload Relays, Sizes 5 and 6

Compensated Overload Relay		Heater (One Heater per Catalog Number)
Open Starter	Enclosed Starter	
Full Load Current of Motor (Amps)		Catalog Number
Size 5 (with 300/5 Current Transformers)		
—	—	FH23
118–129	118–129	FH24
130–141	130–141	FH25
142–155	142–155	FH26
156–170	156–170	FH27
171–187	171–187	FH28
188–205	188–205	FH29
206–224	206–224	FH30
225–244	225–244	FH31
245–263	245–263	FH32
264–292	264–292	FH33
293–300	—	FH34

Compensated Overload Relay		Heater (One Heater per Catalog Number)
Open Starter	Enclosed Starter	
Full Load Current of Motor (Amps)		Catalog Number
Size 6 (with 600/5 Current Transformers)		
—	—	FH23
236–259	236–259	FH24
260–283	260–283	FH25
284–310	284–310	FH26
311–340	311–340	FH27
341–374	341–374	FH28
375–411	375–411	FH29
412–448	412–448	FH30
449–489	449–489	FH31
490–527	490–527	FH32
528–585	528–540	FH33
586–600	—	FH34

Note

Size 7 and larger—advise full load current.

15.1

Accessories and Modification Codes

Accessories

Heater Selection—Type A and B Overload Relays, Sizes 0, 1 and 2

Size Starter	Non-Compensated Open Starters and Ambient Comp. Open and Enclosed Starters Block Type Overload Using Three Heaters Full Load Current of Motor (Amps)	Single-Pole Type Overload	Heater (One Heater per Catalog Number) Catalog Number	Non-Compensating Enclosed Starters Block Type Overload Using Three Heaters Full Load Current of Motor (Amps)	Single-Pole Type Overload	Heater Catalog Number
	0.25–0.27	0.29–0.31	FH03	0.24–0.25	0.28–0.30	FH03
	0.28–0.31	0.32–0.35	FH04	0.26–0.28	0.31–0.34	FH04
	0.32–0.34	0.36–0.39	FH05	0.29–0.31	0.35–0.37	FH05
	0.35–0.38	0.44–0.48	FH06	0.32–0.35	0.38–0.42	FH06
	0.39–0.42	0.44–0.48	FH07	0.36–0.39	0.43–0.47	FH07
	0.43–0.46	0.49–0.53	FH08	0.40–0.43	0.48–0.52	FH08
	0.47–0.50	0.54–0.58	FH09	0.44–0.47	0.53–0.56	FH09
	0.51–0.55	0.59–0.64	FH10	0.48–0.51	0.57–0.63	FH10
	0.56–0.62	0.65–0.71	FH11	0.52–0.57	0.64–0.70	FH11
	0.63–0.68	0.72–0.79	FH12	0.58–0.63	0.71–0.77	FH12
	0.69–0.75	0.80–0.87	FH13	0.64–0.70	0.78–0.85	FH13
	0.76–0.83	0.88–0.96	FH14	0.71–0.77	0.86–0.94	FH14
	0.84–0.91	0.97–1.06	FH15	0.78–0.85	0.95–1.03	FH15
	0.92–1.00	1.07–1.16	FH16	0.86–0.93	1.04–1.13	FH16
	1.01–1.11	1.17–1.28	FH17	0.94–1.03	1.14–1.25	FH17
	1.12–1.22	1.29–1.41	FH18	1.04–1.13	1.26–1.38	FH18
	1.23–1.34	1.42–1.55	FH19	1.14–1.25	1.39–1.52	FH19
	1.35–1.47	1.56–1.71	FH20	1.26–1.37	1.53–1.67	FH20
	1.48–1.62	1.72–1.87	FH21	1.38–1.51	1.68–1.83	FH21
	1.63–1.78	1.88–2.06	FH22	1.52–1.65	1.84–2.01	FH22
	1.79–1.95	2.07–2.26	FH23	1.66–1.81	2.02–2.21	FH23
	1.96–2.15	2.27–2.48	FH24	1.82–1.99	2.22–2.43	FH24
	2.16–2.35	2.49–2.72	FH25	2.00–2.19	2.44–2.66	FH25
	2.36–2.58	2.73–2.99	FH26	2.20–2.39	2.67–2.92	FH26
	2.59–2.83	3.00–3.28	FH27	2.40–2.63	2.93–3.21	FH27
	2.84–3.11	3.29–3.60	FH28	2.64–2.89	3.22–3.53	FH28
	3.12–3.42	3.61–3.95	FH29	2.90–3.17	3.54–3.87	FH29
	3.43–3.73	3.96–4.31	FH30	3.18–3.47	3.88–4.22	FH30
	3.74–4.07	4.32–4.71	FH31	3.48–3.79	4.23–4.61	FH31
	4.08–4.39	4.72–5.14	FH32	3.80–4.11	4.62–4.9	FH32
	4.40–4.87	5.15–5.6	FH33	4.12–4.55	5.0–5.5	FH33
	4.88–5.3	5.7–6.2	FH34	4.56–5.0	5.6–6.0	FH34
	5.4–5.9	6.3–6.8	FH35	5.1–5.5	6.1–6.6	FH35
	6.0–6.4	6.9–7.5	FH36	5.6–5.9	6.7–7.3	FH36
	6.5–7.1	7.6–8.2	FH37	6.0–6.6	7.4–8.0	FH37
	7.2–7.8	8.3–9.0	FH38	6.7–7.2	8.1–8.7	FH38
	7.9–8.5	9.1–9.9	FH39	7.3–7.9	8.8–9.7	FH39
	8.6–9.4	10.0–10.8	FH40	8.0–8.7	9.8–10.5	FH40
	9.5–10.3	10.9–11.9	FH41	8.8–9.5	10.6–11.7	FH41
	10.4–11.3	12.0–13.1	FH42	9.6–10.5	11.8–12.7	FH42
	11.4–12.4	13.2–14.3	FH43	10.6–11.5	12.8–14.0	FH43
	12.5–13.5	14.4–15.7	FH44	11.6–12.6	14.1–15.3	FH44
	13.6–14.9	15.8–17.2	FH45	12.7–13.8	15.4–16.6	FH45
	15.0–16.3	17.3–18.9	FH46	13.9–15.1	16.7–18.3	FH46
	16.4–18.0	19.0–20.8	FH47	15.2–16.7	18.4–20.0	FH47
	18.1–19.8	20.9–22.9	FH48	16.8–18.3	20.1–21.9	FH48
	19.9–21.7	23.0–25.2	FH49	18.4–20.2	22.0–23.9	FH49
	21.8–23.9	25.3–27.6	FH50	20.3–22.2	24.0–26.2	FH50
	24.0–26.2	27.7–30.3	FH51	22.3–24.3	26.3–28.8	FH51
	26.3–28.7	30.4–33.3	FH52	24.4–26.6	28.9–31.4	FH52
	28.8–31.4	33.4–36.4	FH53	26.7–29.1	31.5–34.5	FH53
	31.5–34.5	36.5–39.9	FH54	29.2–32.0	34.6–37.9	FH54
	34.6–37.9	40.0–43.9	FH55	32.1–35.2	38.0–41.9	FH55
	38.0–41.5		FH56	35.3–38.5	42.0–45.0	FH56
	41.6–45.0		FH57	38.6–42.3		FH57

SS-56 Surge Suppressor

- Designed to be used with magnetic motor controllers through Size 4 in 120V, 60 Hz control circuit applications where electronic equipment is used
- Steady state coil volts: 120, 60 Hz, rms
- Peak input volts: 169.6, 60 Hz, maximum amplitude
- Maximum ambient temperature: 65°C
- Nominal limiting volts: 270 peak
- Nominal rate of volt rise: 0.5 per ms

SS-56 Surge Suppressor



Surge Suppressor ①

Type Mounting	Kit Catalog Number
Starter	SS-56

F-56 Fuse Block

- Facilitates installation of fuses (15A, 600V max.) in control circuits
- Utilizes Bussman type KTK fuses, or equivalent
- Mounts in same cavity as Type J auxiliary contact
- No tools or mounting hardware needed
- Fuse not included

Fuse Block

Mounting	Kit Catalog Number
Starter	F56
Panel	F56-P

R-56 Interposing Relay

The R-56AA interposing relay is a low energy solid-state device with a single NO solid-state contact. It can be used as a 120 Vac control relay, and will operate on as little as 40 Vac input. Is useful in

applications requiring long control wiring runs where excessive voltage drop would prevent the contactor or relay from energizing. Will operate a Size 4 contactor from 10,000 ft using 18 AWG wire.

Interposing Relay

Type Mounting	Kit Catalog Number
Starter or panel	R56-AA

Mechanical Interlock

- Prevents closing of one member of a reversing or multi-speed contactor until the opposite member is completely open
- Lever type mechanism assures positive action
- Can be factory assembled or field mounted on A200 and A900 starters and contactors

Mechanical Interlock

Contact Arrangement (Number of Poles, Horizontal or Vertical)	Continuous Size	Interlock Catalog Number
3 x 3 horizontal	0, 1	M-33-1B
4 x 4 horizontal	0, 1	M-33-1B
5 x 3 horizontal	0, 1	M-33-1B
All pole combination, vertical	0, 1	M-34-1A
3 x 3 horizontal reversing	2	M-33-2B
3 x 3 vertical reversing	2	M-34-2A
5 x 3 horizontal	2	M-35-2A
4 x 4 horizontal	2	M-36-2A
All pole combination horizontal	3, 4	M-33-3B
All pole combination vertical	3, 4	M-34-3

B3NO Bell Alarm Contact

- Isolated normally open bell alarm contact
- Mounts in Type B block-type overload relay

Bell Alarm Contact

Kit Catalog Number
B3NO-2
B3NO-4 ②

Control Contact Ratings (B600)

AC Volts	Maximum Amperes	
	Make	Break
24–120	30	3.00
121–600	3600 VA	360 VA

Continuous current rating: 5A

Overload Relay Reset Extension

- Used to adjust overload reset rod depth of Class A200 Model J starters and current design overload relays to same dimensions as obsolete B200 starters and overloads identified by suffix **B**, that is BA13B

When replacing obsolete B200 device with Class A200 starter and Type B overload, order Style 6710C11H03. No charge.

When replacing obsolete B200 device with Class A200 starter and Type A overload, order Style 1490C15H10. No charge.

Notes

- ① Can be used on Sizes 5 and 6 with 120V coil. Mounting bracket required—order separately. Mounting bracket 177C043G04.
- ② For Size 3 and 4.

15.1

Accessories and Modification Codes

Accessories

Power Pole Kit

- Adds 1NO or 1NC power pole to Size 00–1 A201 Class contactors
- Factory installed or field mountable in load side auxiliary cavities
- 600 Vac
- Continuous current rating of 18A for Size 0, 27A for Size 1

Power Pole Kit ①

Continuous Current Rating	Kit Size	Kit Catalog Number
Normally Open		
18	0	PN0-0
27	1	PN0-1
Normally Closed		
18	0	PNC-0
27	1	PNC-1

Replacement Auxiliary Contacts

Replacement Auxiliary Contacts

Contactor Size	Contact Arrangement	Aux. Elect. Contact Catalog Number	Style Number
5, 6	1NO + 1NC	J11	9084A17G01
	2NO	J20	9084A17G02
	2NC	J02	9084A17G03
7, 8	1NO	—	578D461G01
	1NC	—	578D461G03
9	1NO + 1NC	—	843D943G04
	2NO	—	843D943G05
	2NC	—	843D943G06

Extra Auxiliary Contact Kits

All starters include an auxiliary contact with 1NO and 1NC contact. These kits include an auxiliary contact

with contacts as shown, plus operating arm and mounting bracket when required.

Extra Auxiliary Contact Kits

Contactor Size	Contact Arrangement	Style Number
5, 6	1NO + 1NC	3463D94G18
	2NO	3463D94G04
	2NC	3463D94G19
7, 8 ②	2NO	818D498G06
	1NO	818D498G04

DC Coil Conversion Kits

Kits listed below include all necessary parts to convert from AC to DC control including the DC coil with

built-in diode, rectifier, auxiliary interlock and all mounting hardware.

DC Coil Conversion Kits

Size	Voltage	Kit Style Number
5	110-120	7864A28G01
	220-240	7864A28G02
	440-480	7864A28G03
6	110-120	7864A29G01
	220-240	7864A29G02
	440-480	7864A29G03

Mechanical Interlocks

Mechanical Interlocks

Contactor Sizes	Style Numbers	
	Horizontal	Vertical
3, 4 and 5	2050A11G75	2050A11G65
5 and 5	2050A11G25	2050A11G15
5 and 6	2050A11G27	2050A11G17
6 and 6	2050A11G26	2050A11G16
6 and 7, 8	—	2050A11G55
7, 8 and 7, 8	No (rear conn.)	567D624G01
7, 8 and 9	No (rear conn.)	9944D56G06
9 and 9	No (rear conn.)	9944D56G01

Overload Protection

Overload Protection Size 5 Starters

Type B overload protection assembly consists of three current transformers, Type B three-pole block overload relay and an optional interposing relay. These parts are mounted on a panel which connects directly to the load terminal of the

contactor. Current transformers are 600:5 ratio as standard.

Overload Protection Size 6 Starters

Overload protection assembly consists of three current transformers, Type B three-pole block overload relay and an optional interposing relay. These parts are mounted on a panel which connects directly to the load terminal of the

contactor. Current transformers are 600:5 ratio as standard.

If automatic reset is required, the Type A, three-pole block, ambient compensated relay is available upon request.

Notes

- ① Do not use with DC operated contactors.
- ② Size 7 and larger use DC coils as standard.

Overload Relay Kits

Each kit includes three current transformers (standard ratio) and one Type B, three-pole block overload relay, ambient compensated with manual reset.

Overload Relay Kits

Kit Size	Kit Part Number
5	2057A34G01
6	6379D80G10

Replacement Terminal Lugs ^①

Contactor Size	Cable Size	Terminals		Kit Style Number
		Qty. in Kit	Qty. Req'd. per Pole	
5	1-500 kcmil	6	2	2119A76G01
6	2-500 kcmil	6	2	7858A96G01
7	4-500 kcmil	12	4	7858A96G02
8	4-500 kcmil	12	4	7858A96G03

XTIEC

Auxiliary Contacts

Front mounted snap-on auxiliary contacts for **XT** contactors are available with screw or spring cage terminals in a variety of contact configurations.

The 7–32A XTCE contactors have positively driven contacts between the integrated auxiliary contact and the auxiliary contact module as well as within the auxiliary contact modules.

The 40–65A XTCE contactors have positively driven contacts within the auxiliary contact module. Six auxiliary contacts are possible with a combination of side-mounted and front-mount auxiliary contacts.

Frame B–C contactors with 1NC built-in auxiliary are mirror contacts (XTCE...B01_–XTCE...C01_).

XTCE and XTCS Auxiliary Contact Overview

Frame	A	B	C	D	F	G	L–R
Catalog numbers	XTMC6A_– XTMC9A_	XTCE007B_– XTCE015B_	XTCE018C_– XTCE032C_	XTCE040D00_– XTCE065D00_	XTCE080F00_– XTCE095F00_	XTCE115G00_– XTCE150G00_	XTCE185L22_– XTCEC20R22_ ^②
Contactor width	45 mm	45 mm	45 mm	55 mm	90 mm	90 mm	Various
Built-in auxiliary	1NO or 1NC	1NO or 1NC	1NO or 1NC	—	—	—	2NO-2NC
Contact sequence							
Front- (top) mount auxiliary	Two- and four-pole (screw or spring cage): 	Standard two- and four-pole versions (screw or spring cage): Tall version (screw only): 		Two-pole (screw only): Four-pole (screw or spring cage): 			N/A
Side-mount auxiliary	N/A	N/A	Two-pole (screw only): 	Two-pole (screw or spring cage): 			

Notes

- ① All mounting hardware is included in kit.
- ② Frame L–R auxiliary contacts also apply to XTCS185_–XTCS500M_ contactors.

15.1

Accessories and Modification Codes

Accessories













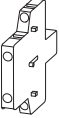

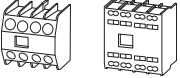

Auxiliary Contacts

		Conventional Thermal Current, Open at 60°C $I_{th} = I_e$ AC-1 in Amps	Poles	Contact Configuration	Circuit Symbol	Pkg. Qty.	Screw Terminals Catalog Number	Spring Cage Terminals Catalog Number
Frame B-C—Front- (Top) Mount								
		16	2	2NO		5	XTCEXFAC20	XTCEXFACC20
		16	2	1NO-1NC		5	XTCEXFAC11	XTCEXFACC11
		16	2	2NC		5	XTCEXFAC02	XTCEXFACC02
		16	2	1NO _E -1NC _L		5	XTCEXFALC11 ①	XTCEXFALCC11 ①
		16	2	1NO-1NC		5	XTCEXFDC11 ②	XTCEXFDC11 ②
		16	2	2NC		5	XTCEXFCC02 ②	XTCEXFCC02 ②
		16	4	4NO		5	XTCEXFAC40	XTCEXFACC40
		16	4	3NO-1NC		5	XTCEXFAC31	XTCEXFACC31
		16	4	2NO-2NC		5	XTCEXFAC22	XTCEXFACC22
		16	4	1NO-3NC		5	XTCEXFAC13	XTCEXFACC13
		16	4	4NC		5	XTCEXFAC04	XTCEXFACC04
		16	4	1NO _E -1NC _L		5	XTCEXFCLC22 ①	XTCEXFCLCC22 ①
		16	4	2NO-2NC		5	XTCEXFCC22 ②	XTCEXFCC22 ②
Frame B-C—Front- (Top) Mount—Tall Version ③								
		16	2	2NO		5	XTCEXFATC20	—
		16	2	1NO-1NC		5	XTCEXFATC11	—
		16	2	2NC		5	XTCEXFATC02	—

Notes

- ① One early-make contact (1NO_E), one late-break contact (1NC_L).
- ② To avoid duplicate terminal numbers in contact sequence, these auxiliary contacts should only be used with contactors having a built-in 1NO contact (XTCE...B10_, XTCE...C10_).
- ③ Front- (top) mount tall version is for use with Frame B electrical wire bridges and link kits and toolless plug combination connection kits: XTCEXRLL, XTCEXSDLB, XTPAXTPCB, XTPAXTPCRB, XTPAX.

Auxiliary Contacts, continued

	Conventional Thermal Current, Open at 60°C I _{th} = I _e , AC-1 in Amps	Poles	Contact Configuration	Circuit Symbol	Pkg. Qty.	Screw Terminals Catalog Number	Spring Cage Terminals Catalog Number
Frame B-C—Front- (Top) Mount—Tall Version, continued ①							
	16	4	2NO-2NC		5	XTCEXFATC22	—
Frame C—Side-Mount							
	10	2	1NO-1NC		1	XTCEXSCC11 ②	—
Frame D-G							
	16	2	2NO		5	XTCEXFBG20	—
	16	2	1NO-1NC		5	XTCEXFAG11	—
	16	2	1NO-1NC		5	XTCEXFBG11	—
	16	2	2NC		5	XTCEXFBG02	—
	16	4	4NO-0NC		5	XTCEXFBG40	XTCEXFBGC40
	16	4	3NO-1NC		5	XTCEXFBG31	XTCEXFBGC31
	16	4	2NO-2NC		5	XTCEXFBG22	XTCEXFBGC22
	16	4	2NO-2NC		5	XTCEXFAG22	XTCEXFAGC22
	16	4	1NO-3NC		5	XTCEXFBG13	XTCEXFBGC13
	16	4	0NO-4NC		5	XTCEXFBG04	XTCEXFBGC04
	16	4	1NO _E -1NC _L		5	XTCEXFBG22 ③	XTCEXFBGC22 ③

Notes

① Front- (top) mount tall version is for use with Frame B electrical wire bridges and link kits and toolless plug combination connection kits: XTCEXRLB, XTCEXSDLB, XTPAXTPCB, XTPAXTPCRB, XTPAX.

② Can be mounted to the left side of contactor only. Cannot be used in combination with front- (top) mount auxiliary contacts or mechanical interlocks.

③ One early-make contact (1NO_E), one late-break contact (1NC_L).

Interlocked opposing contacts, to IEC/EN 60947-5-1 Annex L (positively driven), within the auxiliary contact modules (not NO [early make] and NC [late break] contacts) and for the built-in auxiliary contacts of the XTCE007B_–XTCE032C_.

Auxiliary break contact can be used as mirror contact to IEC/EN 60947-4-1 Annex F (not NC [late break] contact).





No auxiliary contacts can be fitted between two contactors.

15.1



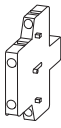















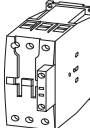

Accessories and Modification Codes

Accessories

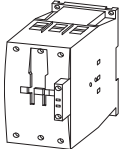
Side-Mount Auxiliary Contacts for Frame D–R, 40–2000A

	Conventional Free Air Thermal Current, $I_{th} = I_e$, AC-1 in Amps	Poles	Contact Configuration	Circuit Symbol	Pkg. Qty.	Screw Terminal Catalog Number	Spring Cage Terminal Catalog Number
	10	2	1NO-1NC		1	XTCEXSBN11	XTCEXSBN11
	10	2	1NO _E -1NC _L		1	XTCEXSBLN11 ①	—
	10	2	1NO-1NC		1	XTCEXSCN11 ②	XTCEXSCN11 ②

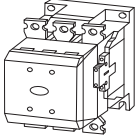
Auxiliary Contacts Possible Combinations

Frame Size	Contactor	Built-In Auxiliary	Front- (Top) Mount		Side-Mount Two-Pole	Total Auxiliary Contacts Available	Catalog Number
			Two-Pole	Four-Pole			
A		1NO or 1NC	1	—	—	3	XTMC6A_
			—	1	—	5	XTMC9A_
					—	—	
B		1NO or 1NC	1	—	—	3	XTCE007B_
			—	1	—	5	XTCE015B_
					—	—	
C		1NO or 1NC	1	—	—	3	XTCE018C_
			—	1	—	5	XTCE032C_
			—	—	1	3	—
						—	—
D		—	1	—	2	6	XTCE040D00_
			—	1	1	6	XTCE065D00_
						—	—
F–G		—	1	—	2	6	XTCE080F00_
			—	1	2	8	XTCE150G00_
			—	—	4	8	—
						—	—
L–R		2NO-2NC	—	—	2	8	XTCE185L22_
			—	—	—	—	XTCEC20R22_
			—	—		—	—

Notes

- ① One early-make contact (1NO_E), one late-break contact (1NC_L).
 - ② To maintain proper terminal marking, XTCEXSCN_ should not be used with Frame D contactors and only used with Frame F–G contactors in combination with XTCEXSBN_.
- Forced operation contact to IEC/EN 60947-5-1 Appendix L (positively driven), inside the auxiliary contact unit (not early close and late opening).
 Auxiliary normally closed contact can be used as mirror contact to IEC/EN 60947-4-1 Appendix F (not late opening).
 No auxiliary contacts can be fitted between two contactors.

Auxiliary Contact Combinations

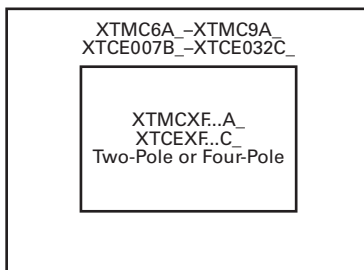

Frame A–B

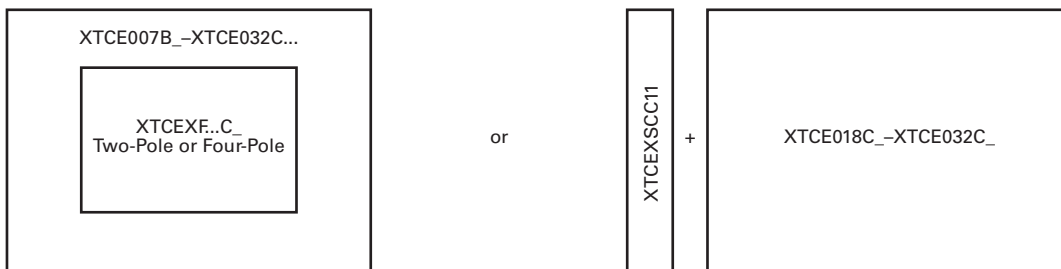

Frame C

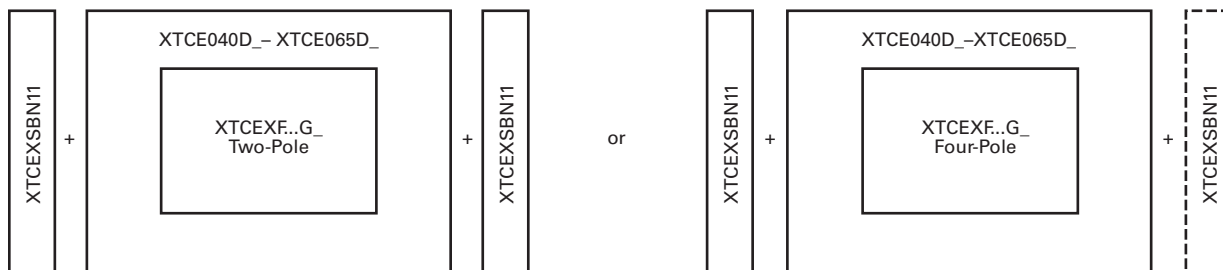

Frame D

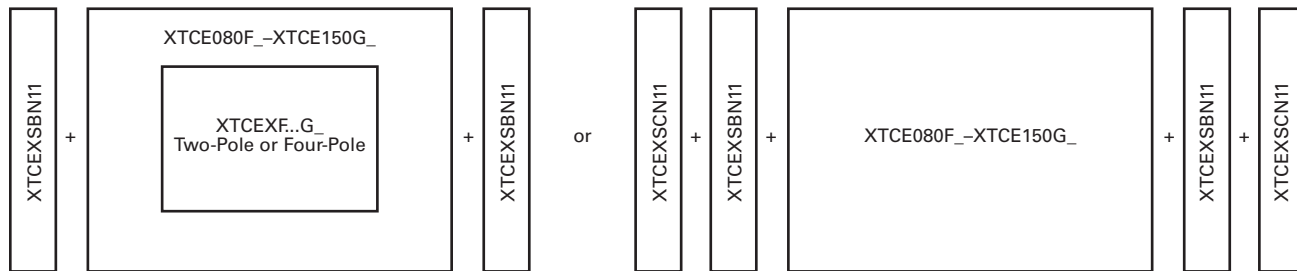

Frame F–G

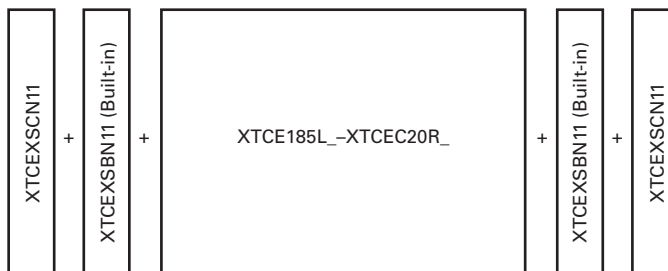

Frame L–R

Enclosures

Type 1 Enclosures

C899 Type 1 Enclosure



Type 1 Enclosures—NEMA (Freedom)

Starter Type	Box Number	NEMA Size	Catalog Number
Non-reversing starter	1	00-1 AN16	C899B001 ^①
	1	00-2 AN19	C899B001 ^①
	2	2 AN16	C799B13
	4	3-4	C799B15
	10	5	C799B17
Non-reversing starter with space for CPT	3	00-2	C799B14 ^②
	4	3-4	C799B15 ^③
Reversing starter	2	00-0	C799B13
	3	1-2	C799B14
	4	3	C799B15
	9	4	C799B16
	10	5	C799B17

Notes

- ① C899B001 is a universal enclosure that requires a specific reset rod length based on starter size. See Volume 10 Tab 2.
- ② Sub panel drilled for 50-200 VA CPTs.
- ③ Enclosure drilled for 150-300 VA CPTs.

Type 3R, 4X and 12 Enclosures

Type 3R Enclosure



Type 3R, 4X and 12 Enclosures—NEMA (Freedom)

Starter Type	Box Number	NEMA Size AN16	Type 3R Catalog Number	Type 12 Catalog Number	Type 4X Catalog Number
Non-reversing starter	5	00-1	C799B21	C799B81	C799B41
	6	2	C799B24	C799B84	C799B43
	6	—	C799B25	C799B85	C799B44
	8	3	C799B210	C799B810	C799B47
	8	—	C799B212	C799B812	C799B49
	8	4	C799B211	C799B811	C799B48
	10	5	C799B218	C799B818	C799B413
Non-reversing starter with space for CPT	6	00-2	C799B24	C799B84	C799B43
	6	—	C799B25	C799B85	C799B44
	8	3	C799B210	C799B810	C799B47
	8	—	C799B212	C799B812	C799B49
	8	4	C799B211	C799B811	C799B48
	10	5	C799B218	C799B818	C799B413
	Reversing starter	6	00-2	C799B24	C799B84
6		—	C799B25	C799B85	C799B44
8		3	C799B210	C799B810	C799B47
8		—	C799B212	C799B812	C799B49
9		4	C799B215	C799B815	C799B411
10		5	C799B218	C799B818	C799B413
Multispeed	7 ^①	0-2	C799B223	C799B823	C799B417

C899 Type 1 Enclosure



Enclosures—IEC (XT Type)

Starter Type	Box Number	IEC Size	Catalog Number
XT starters, SSOL	1	B-C	C899B001 ^②
XT starters, bi-metallic	1	B	C899B001 ^②
XT contactors/starters, bi-metallic	1	C	C899B001 ^②
XT contactors/starters without reset	2	D	C799B34
XT contactors/starters with resets	2	D	C799B35

Notes

① Blank cover provided.

② C899B001 is a universal enclosure that requires a specific reset rod length based on starter size. See Volume 10 Tab 3.

Lighting Contactors

Electrically Held Base Contactor for C30CN/ECC

The C30CNE20_0 electrically held base contactor contains a 2NO power pole as standard and will allow the addition of power poles to build an electrically held contactor up to 12 poles

maximum. A mechanically held module kit can also be added to convert the electrically held contactor into a mechanically held contactor in the field.

Electrically Held Base Contactor



Electrically Held Base Contactor

Power Poles	Catalog Number ^①
2NO	C30CNE20_0

Coil Base Voltage (Digit 9)

Voltage (Digit 9)	Code Suffix	Voltage (Digit 9)	Code Suffix
115–120V 60 Hz/110V 50 Hz	A	265–277V 60 Hz/240V 50 Hz	H
230–240V 60 Hz/220V 50 Hz	B	24V 60 Hz/20V 50 Hz	T
460–480V 60 Hz/440V 50 Hz	C	28V 60 Hz/24V 50 Hz	V
575–600V 60 Hz/550V 50 Hz	D	347V 60 Hz	X
200–208V 60 Hz	E		

Power Poles for C30CNM/ECC

The C30CNM contactor accepts up to a maximum six single- or two-pole (or combinations) power poles. These can be used to form up to:

- 12 NO poles maximum when 6 two-poles are used in NO positions (1–6) or
- 8 NC poles maximum with 4 two-poles in the NC position (1–4) and 4 NO poles with 2 two-poles in the 2 NO positions (5–6)

Power Poles



Power Poles

Power Poles	Catalog Number
Single-pole	C320PRP1
Two-pole	C320PRP2

Mechanically Held Module Kits for C30CN/ECC

These kits are for converting electrically held contactors to mechanically held units. Kits include control module, latch, latch cover and auxiliary

contacts plus installation instructions. Conversion kits are suitable for coil voltages of 277V and below.

C30CNM Components—Exploded View

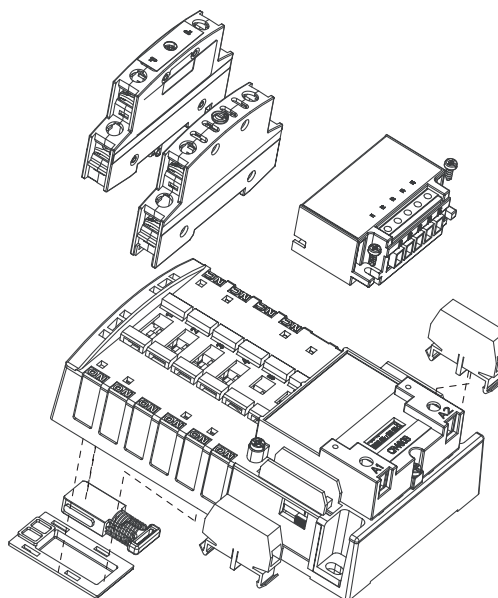

Conversion Kit



Mechanically Held Module Kits

Coil Volts	Control Volts	Catalog Number
Two-Wire		
24–277 Vac	110–120 Vac	C320MH2WA0
	200–277 Vac	C320MH2WH0
	24 Vac	C320MH2WT0
	12–24 Vdc	C320MH2WT1
Three-Wire		
24–277 Vac	110–120 Vac	C320MH3WA0
	200–277 Vac	C320MH3WH0
	24 Vac	C320MH3WT0
	12–24 Vdc	C320MH3WT1

Note

- ^① When ordering, select required contactor by catalog number and replace the magnet coil alpha designation in the catalog number () with the proper code suffix from the Coil Base Voltage table above.

Auxiliary Contacts for C30CN/ECC

A mechanically held contactor with a two-wire control module uses 1NC auxiliary contact as standard for the control wiring circuit. The mechanically held contactor with a three-wire control

module uses 1NO-1NC auxiliary contacts as standard for the control wiring circuit. See the table below for possible additional auxiliary contact configurations.

Auxiliary Contact Configurations

Two-Wire	Three-Wire
None	1NC (two-pole)
1NO (single-pole)	1NO (two-pole)
2NO (two-pole)	1NO-1NC (two-pole)
1NC (two-pole)	
1NO-1NC (NO single-pole, NC two-pole)	
2NO-1NC (two-pole)	

Auxiliary Contacts



Auxiliary Contacts

Auxiliary Block	Catalog Number
Single-pole	C320AMH1
Two-pole	C320AMH2

Transient Suppressor Kits for CN35/ECL

10–60A Contactors

These kits limit high voltage transients produced in the control circuit when power is removed from the contactor or starter coil. There are three separate suppressors for use

on 24–120V, 240V or 480V coils respectively.

These devices mount directly to the coil terminals of lighting contactors 10–60A.

C320TS2



Kits for 10–60A

Description	Coil Voltage	Catalog Number
Transient suppressor	24–120V	C320TS1
	240V	C320TS2
	480V	C320TS3

100–300A Contactors

This device mounts on top of any side-mounted auxiliary contact on lighting contactors 100–300A. It connects across coil terminals on any 120V contactor magnet coil.

Limits high voltage transients produced in the circuit when power is removed from the coil.

C320AS1



Kits for 100–300A

Description	Coil Voltage	Catalog Number
Transient suppressor	120V	C320AS1

Auxiliary Contacts for CN35/ECL

CN35 lighting contactors include a 1NO maintaining auxiliary contact mounted on right hand side (on 10A, two- and three-pole devices, auxiliary contact occupies fourth power pole position—no increase in width). The 10–60A devices will accept additional auxiliary contacts on the top and/or sides.

contacts are of the bifurcated design with parallel circuit paths. This redundant path provides very high reliability. Auxiliary contacts can be snapped on the side (up to two circuits—per auxiliary contact) and on the top (up to four circuits). Auxiliary contacts for larger contactors, 100–400A sizes, will accept side-mounted auxiliaries only and easily attach to the side of the contactor with two screws.

Auxiliary contact blocks are designed for snap-on installation—fast, easy installation (no tools required up to 60A). All auxiliary

Contact Configuration Code

This two-digit code is found on the auxiliary contact to assist in identifying the specific contact configuration.

The first digit indicates the quantity of NO contacts and the second indicates the quantity of NC contacts.

Auxiliary Contacts—10–60A Contactors

Description	Contact Configuration Code ^①	Catalog Number
Side-Mounted		
1NO	10	C320KGS1
1NC	01	C320KGS2
1NO-1NC	11	C320KGS3
2NO	20	C320KGS4
2NC	02	C320KGS5
Top-Mounted ^②		
1NO	10	C320KGT1
1NC	01	C320KGT2
1NO-1NC	11	C320KGT3
2NO	20	C320KGT4
2NC	02	C320KGT5
3NO	30	C320KGT9
2NO-1NC	21	C320KGT10
1NO-2NC	12	C320KGT11
3NC	03	C320KGT12
4NO	40	C320KGT13
3NO-1NC	31	C320KGT14
2NO-2NC	22	C320KGT15
1NO-3NC	13	C320KGT16
4NC	04	C320KGT17

Side-Mounted



Top-Mounted



Notes

- ① For reference only—not part of catalog number.
- ② Cannot be added to contactors or starters mounted in Box 1 (Type 1).

15.1

Accessories and Modification Codes

Accessories

Base Auxiliary Contact



Base Auxiliary Contacts—100–400A Contactors

Circuit	Contact Configuration Code ^①	100A Contactors Catalog Number	200 and 300A Contactors Catalog Number
NO	10	C320KGS31	C320KGS41
NO-NC	11	C320KGS32	C320KGS42

Auxiliary Contact



Auxiliary Contacts—100–400A Contactors

Circuit	Contact Configuration Code ^①	Catalog Number
NO	10	C320KGS20
NC	01	C320KGS21
NO-NC ^②	11	C320KGS22

Auxiliary Contact Ratings (Amperes)—NEMA A600

Current	AC Volts			
	120V	240V	480V	600V
Make and interrupting	60.0	30.0	15.0	12.0
Break	6.0	3.0	1.5	1.0
Continuous	10.0	10.0	10.0	10.0

Auxiliary Contact 5A Continuous Thermal Rating—NEMA P300

DC Volts	Make/Break Amperes
125	1.10
250	0.55

Notes

- ① For reference only—not part of catalog number.
- ② NO-NC occupies two positions—L2 and L3 or R2 and R3. See table on [Page V10-T15-33](#).

Auxiliary Contact Location for CN35/ECL

Auxiliary Contacts—Mounting Positions

The sketches below illustrate the maximum number of auxiliary contacts that can be assembled to a contactor and their locations in standard enclosures.

Auxiliary Contact Mounting Positions

Size	Poles	Available Mounting Positions ①②③		
		Open Type	Type 1	Type 3R, 4X, 12
10A	2–4	T1, L1, R1	L1	L1, T1
20–60A	2–3	T1, L1	L1	L1, T1
60A	4	T1, L1	—	L1, T1
60A	5	T1, L1	—	L1, T1
100A	2–3	R2, R3, L1, L2, L3	R2, R3, L1, L2, L3	R2, R3, L1, L2, L3
200A	2–3	R2, R3, L1, L2, L3	R2, R3, L1, L2, L3	R2, R3, L1, L2, L3
300A	2–3	R2, R3, L1, L2, L3	R2, R3, L1, L2, L3	R2, R3, L1, L2, L3
400A	2–3	R2, R3, L1, L2, L3	R2, R3, L1, L2, L3	R2, R3, L1, L2, L3

Auxiliary Contact Location

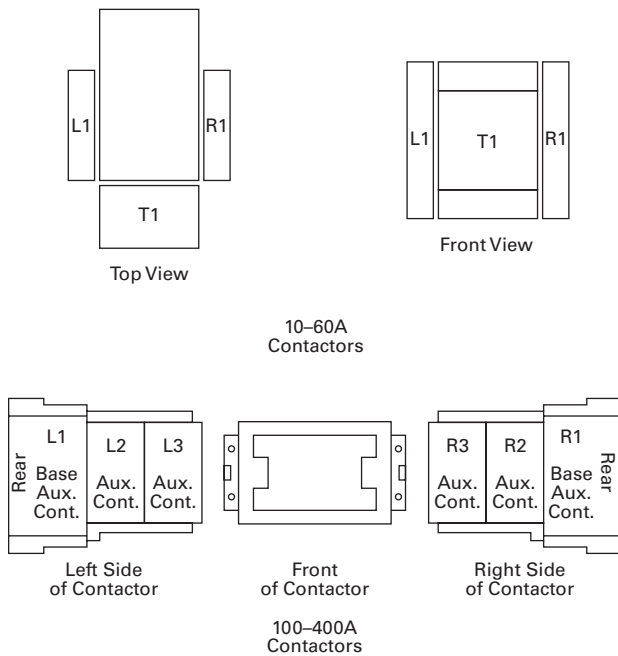

Pneumatic Timers—Top-Mounted for CN35/ECL

Attachment mounts on top of 10–60A lighting contactors (top-mounted auxiliary contacts cannot be installed on device when timer is used). Timer unit has DPST

timed contacts—circuits in each pole must be the same polarity. Units are convertible from OFF to ON delay or vice-versa.

Pneumatic Timer



Pneumatic Timers

Timing Range	Catalog Number
0.1–30 seconds	C320TP1
10–180 seconds	C320TP2

Maximum Ampere Ratings

Description	Volts AC			
	120	240	480	600
Make	30.0	15.0	7.5	6.0
Break	3.0	1.5	0.75	0.6

Solid-State Timers for CN35/ECL

Solid-State ON DELAY Timer—Side-Mounted on CN35 Freedom Series Lighting Contactors Through 60A

This timer is designed to be **wired in SERIES with the load** (typically a coil). When the START button is pushed (power applied to timer), the

ON DELAY timing function starts. At the completion of the set timing period, timer and series wired load will both be energized.

Solid-State Timer



Product Selection—Mounted Timer

Timing Range	Catalog Number ④⑤⑥
0.1–1.0 seconds	C320TDN1_
1–30 seconds	C320TDN30_
30–300 seconds	C320TDN300_
5–30 minutes	C320TDN3000_

Notes

- ① Available positions on contactors or starters other than what is factory installed.
- ② When a pneumatic timer is mounted on contactor, only side-mounted auxiliary contact positions are available. The solid-state timer, when added, takes up side-mounted auxiliary contact position.
- ③ For 100–400A contactors, a base auxiliary contact must be added in position L1 before additional contacts can be mounted.
- ④ Add operating voltage suffix to catalog number. **A** = 120V, **B** = 240V, **E** = 208V.
- ⑤ Rated 0.5A pilot duty—not to be used on larger contactors.
- ⑥ Terminal connections are quick connects only. Two per side.

15.1

Accessories and Modification Codes

Accessories

Type J Auxiliary Contact for A202/ECL

- Capable of being field mounted in a contactor or starter (Classes A200, A900 Sizes 00–6, V200, V201 vacuum and definite purpose controllers)
- Provides two separate electrical contact sets which wire vertically and are color coded; black designates NC and silver designates NO. Please note that the vertical wiring is contrary to the horizontal wiring of the L-56 auxiliary contacts
- Designed to fit within dimensions of starter; no additional panel space is required
- Provides circuit isolation (no polarity restrictions) and single break bifurcated contacts

Auxiliary Contact Ratings

Voltage	Make	Break
NEMA A600		
120–600 Vac	7200 VA	720 VA
72–120 Vac	60A	720 VA
28–72 Vac	60 VA	10A
NEMA R300		
28–300 Vdc	28 VA	28 VA

Type J Auxiliary Contact



Auxiliary Contact Types

Contact Type	Max.	Catalog Number
1NO and 1NC	4	J11
2NC	4	J02
2NO	4	J20
1 coil clearing NC and 1NO	4	J1C

SS-56 Surge Suppressor for A202/ECL

- Designed to be used with magnetic motor controllers through Size 4 in 120V, 60 Hz control circuit applications where electronic equipment is used
- Steady state coil volts: 120, 60 Hz, rms
- Peak input volts: 169.6, 60 Hz, max. amplitude
- Max. ambient temperature: 65°C
- Nominal limiting volts: 270 peak
- Nominal rate of volt rise: 0.5 per ms

SS-56 Surge Suppressor



Surge Suppressor^①

Type Mounting	Kit Catalog Number
Starter	SS-56

F-56 Fuse Block for A202/ECL

- Facilitates installation of fuses (15A, 600V maximum) in control circuits
- Uses Bussman type KTK fuses, or equivalent
- Mounts in same cavity as Type J auxiliary contact
- No tools or mounting hardware needed
- Fuse not included

Fuse Block

Mounting	Kit Catalog Number
Starter	F56
Panel	F56-P

R-56 Interposing Relay for A202/ECL

The R-56AA interposing relay is a low energy solid-state device with a single NO solid-state contact. It can be used as a 120 Vac control relay, and will operate on as little as 40 Vac input. Is useful in

applications requiring long control wiring runs where excessive voltage drop would prevent the contactor or relay from energizing. Will operate a Size 4 contactor from 10,000 ft using 18 AWG wire.

Interposing Relay

Type Mounting	Kit Catalog Number
Starter or panel	R56-AA

Power Pole Kit for A202/ECL

- Adds 1NO or 1NC power pole to Size 00–1 A201 Class contactors
- Factory installed or field mountable in load side auxiliary cavities
- 600 Vac
- Continuous current rating of 18A for Size 0, 27A for Size 1

Power Pole Kit^②

Continuous Current Rating	Kit Size	Kit Catalog Number
Normally Open		
18	0	PNO-0
27	1	PNO-1
Normally Closed		
18	0	PNC-0
27	1	PNC-1

Notes

- ① Can be used on Sizes 5 and 6 with 120V coil. Mounting bracket required—order separately. Mounting bracket 177C043G04.
- ② Do not use with DC operated contactors.

Replacement Auxiliary Contacts for A202/ECL**Replacement Auxiliary Contacts**

Contactor Size	Contact Arrangement	Aux. Elect. Contact Catalog Number	Style Number
5, 6	1NO + 1NC	J11	9084A17G01
	2NO	J20	9084A17G02
	2NC	J02	9084A17G03
7, 8	1NO	—	578D461G01
	1NC	—	578D461G03
9	1NO + 1NC	—	843D943G04
	2NO	—	843D943G05
	2NC	—	843D943G06

Extra Auxiliary Contact Kits for A202/ECL

All starters include an auxiliary contact with 1NO and 1NC contact. These kits include an auxiliary contact

with contacts as shown, plus operating arm and mounting bracket when required.

Extra Auxiliary Contact Kits

Contactor Size	Contact Arrangement	Style Number
5, 6	1NO + 1NC	3463D94G18
	2NO	3463D94G04
	2NC	3463D94G19
7, 8 ^①	2NO	818D498G06
	1NO	818D498G04

DC Coil Conversion Kits for A202/ECL

Kits listed below include all necessary parts to convert from AC to DC control including the DC coil with

built-in diode, rectifier, auxiliary interlock and all mounting hardware.

DC Coil Conversion Kits

Size	Voltage	Kit Style Number
5	110-120	7864A28G01
	220-240	7864A28G02
	440-480	7864A28G03
6	110-120	7864A29G01
	220-240	7864A29G02
	440-480	7864A29G03

Note

① Size 7 and larger use DC coils as standard.

IT Solid-State Soft Starters

Surge Suppressors for S801+/S811+

The surge suppressor can mount on either the line or load side of the IT soft

starter. It is designed to clip the line voltage (or load side induced voltage).

Surge Suppressor



Surge Suppressors

Description	Catalog Number
600V MOV for IT soft starters	EMS39
690V MOV for IT soft starters	EMS41

Lug Kits for S801+/S811+

The 200 mm and 290 mm soft starters do not include lugs.

The 200 mm and 290 mm soft starters each have different lug options based on

your wiring needs. Each lug kit contains three lugs which can be mounted on either the load or line side.

Lug Kits



Lug Kits

Frame Size	Frame Designation	Description	Catalog Number
200 mm SSRV	T, U	2 cable connections, 4 AWG to 1/0 cable	EML22
		1 cable connection, 4/0 to 500 kcmil cable	EML23
		2 cable connections, 4/0 to 500 kcmil cable	EML24
		1 cable connection, 2/0 to 300 kcmil cable	EML25
		2 cable connections, 2/0 to 300 kcmil cable	EML26
		290 mm SSRV	V
4 cable connections, 4/0 to 500 kcmil cable	EML30		
6 cable connections, 4/0 to 500 kcmil cable	EML32		
4 cable connections, 2/0 to 300 kcmil cable	EML33 ①		

Lug Cover Kits for S801+/S811+

Replacement covers for the T and V Frame are available in case of damage to the existing covers.

Lug Cover Kits

Description	Catalog Number
Lug cover T, U Frame	EML27
Lug cover V Frame	EML34

Digital Interface Module and Control Interface Module

The Digital Interface Module (DIM) and control interface module are available as replacement parts.

DIM and CIM

Description	Catalog Number
Blank cover (filler)	EMA68
DIM for S811+	EMA91
CIM for S801+	EMA71
CIM for S801+ pump control option	EMA72
Panel mounting kit	
3 ft cable	EMA69A
5 ft cable	EMA69B
8 ft cable	EMA69C
10 ft cable	EMA69D

Control Wire Connector

Control Wire Connector

Description	Catalog Number
12-pin, 5 mm pitch connector for control wiring	EMA75L

User Manual for S811+

A comprehensive user manual is available and can be downloaded free of charge

from www.eaton.com by performing a document search for MN03902002E.

Mounting Plates for S801+/S811+

The mounting plates are designed to help make it easy to install or retrofit the soft starter into enclosures and MCCs. The soft starter can

be mounted onto the plate prior to installation. The mounting plate is designed with tear drop mounting holes for easier installation.

Mounting Plates

Description	Catalog Number
Mounting plate N Frame	EMM13N
Mounting plate R Frame	EMM13R
Mounting plate T, U Frame	EMM13T
Mounting plate V Frame	EMM13V
Fan/hood accessory	EMM18

Note

① The EML33 does not have a CSA Listing.

Adapter Plates

The adapter plate allows customers to retrofit a V Frame 290 mm soft starter with the U Frame 200 mm soft starter.

Adapter Plates

Description	Catalog Number
Adapter Plates ^①	EMM13U

Vibration Plates for S801+/S811+

The vibration plates allow the soft starter to be applied in high shock and vibration applications. The vibration plate allows vibration up to 5g

and shock in up to 40g. The soft starter is mounted onto the vibration plate prior to installation in the panel.

Vibration Plates

Description	Catalog Number
Vibration plate N Frame	EMM14N
Vibration plate R Frame	EMM14R
Vibration plate T, U Frame	EMM14T
Vibration plate V Frame	EMM14V

Power Supplies

24 Vdc power supply that can be used with the S801+ or S811+ SSRV or as a standalone device.

Power Supplies

Description	SSRV	Catalog Number
115 Vac input	S801+/S811+	PSG240E
230 Vac input	S801+/S811+	PSG240E
380–480 Vac input	S801+/S811+	PSG240F

DIN Rail Power Supply Mounting Kit (35 mm)**DIN Rail Mounting Kit**

Description	Catalog Number
DIN rail mounting kit (35 mm)	PSSDIN

NEMA Vacuum Break Control**Lug Sizes**

- Size 4—12–4/0
- NEMA Size 5 and 6 and 320A, 540A and 610A—supplied without line or load lugs

Lug Kits—Consist of 6 Lugs

Size	Description	Catalog Number
5 and 320A	1/0–500 kcmil	C325KAL8
6, 540A and 610A	1/0–500 kcmil double barrel	C325KAL9
610A	1/0–600 kcmil double barrel	80-19825-2

Field Modification Kits**Auxiliary Electrical Contacts**

Size 4—Three Type J auxiliary contacts may be mounted on the top of Size 4 contactors to provide six auxiliary, isolated 600V, 10A contacts for use in control circuits.

Sizes 5–6—Two Type J auxiliary contacts may be mounted on each side of Size 5 and 6 contactors to provide four auxiliary, isolated 600V, 10A contacts for use in control circuits.

Auxiliary Electrical Contacts

Contact Arrangement	Catalog Number
1NO, 1NC	J11
2NO	J20
2NC	J02

Horizontal Mechanical Interlock

Size	Catalog Number
4	180C113G04
5	180C113G16
6	180C113G17

Note

^① For more information see Pub51719.

Heater Coils

Heater Coil Selection for Type B Overload Relay

Motor Full Load Current in Amperes for Use with 3 Heaters Only
Open Starter

Ambient Compensated Overload Relay	Heater Catalog Number ①
Size 4 and 160A	
12.8–14.1	FH68
14.2–15.5	FH69
15.6–17.1	FH70
17.2–18.9	FH71
19.0–20.8	FH72
20.9–22.9	FH73
23.0–25.2	FH74
25.3–27.8	FH75
27.9–30.6	FH76
30.7–33.5	FH77
33.6–37.5	FH78
37.6–41.5	FH79
41.6–46.3	FH80
46.4–50	FH81
51–55	FH82
56–61	FH83
62–66	FH84
67–73	FH85
74–78	FH86
79–84	FH87
85–92	FH88
93–101	FH89
102–110	FH90
111–122	FH91
123–129	FH92
130–133	FH93
—	FH94

Motor Full Load Current in Amperes for Use with 3 Heaters Only
Open Starter

Ambient Compensated Overload Relay	Heater Catalog Number ①
Size 5 and 320A with 300/5 Current Transformers	
107–117	FH23
118–129	FH24
130–141	FH25
142–155	FH26
156–170	FH27
171–187	FH28
188–205	FH29
206–224	FH30
225–244	FH31
245–263	FH32
264–292	FH33
293–318	FH34
319–350	FH35
Size 6 and 540A with 600/5 Current Transformers	
236–259	FH24
260–283	FH25
284–310	FH26
311–340	FH27
341–374	FH28
375–411	FH29
412–448	FH30
449–489	FH31
490–527	FH32
528–585	FH33
586–600	FH34

Notes

① Three are required per overload relay.

For information on H2001 heaters, see **Page V10-T15-6**.

Modification Codes

A—Ammeters, Auxiliary Contacts, Accelerating Relays, Autotransformers

Modification	Description	Catalog Number Suffix
Ammeter	Panel type wired to current transformer in Line 1, Type 1, 12	A1
	Panel type wired to current transformer in Line 1, Type 3R, 4X	
	Panel type, selector switch and three current transformers wired to ammeter via switch, Type 1, 12	A2
	Panel type, selector switch and three current transformers wired to ammeter via switch, Type 3R, 4X	
	Miniature (single-phase), Type 1, 12	A3
	Miniature with selector switch, Type 1, 12	A4
	Switchboard (single-phase), Type 1, 12	A5
	Switchboard (single-phase), Type 3R, 4X	
	Switchboard with selector switch, Type 1, 12	A6
	Switchboard with selector switch, Type 3R, 4X	
	Three-panel type (single-phase), Type 1, 12	A7
	Three-panel type (single-phase), Type 3R, 4X	
	Three miniature (single-phase), Type 1, 3R, 4X, 12	A10
	Three switchboard type (single-phase), Type 1, 12	A11
Three switchboard type (single-phase), Type 3R, 4X		
Ammeter order by description, Type 1, 3R, 4X, 12	A12	
Auto-transformers	Hp rating selection, see Tab 5	A8
	Order by description	A9
Top-mounted auxiliary contacts ^① (unwired)	1NO	A13
	1NC	A14
NEMA Sizes 00–2 only (unwired)	1NO-1NC	A15
	2NO	A16
IEC Sizes B–L only (unwired) XT Series	2NC	A17
	2NO-1NC	A18
	1NO-2NC	A19
	3NO	A20
	3NC	A21
	3NO-1NC	A22
	2NO-2NC	A23
	1NO-3NC	A24
	4NO	A25
	4NC	A26

Note

^① Top-mounted auxiliary contacts cannot be added to contactors in Box 1 (Type 1).

A—Ammeters, Auxiliary Contacts, Accelerating Relays, Autotransformers, continued

Modification	Description	Catalog Number Suffix
Side-mounted auxiliary contacts ^①	1NO	A27
	1NC	A28
	1NO-1NC	A29
	2NO	A30
	2NC	A31
	2NO-1NC	A32
	1NO-2NC	A33
	3NO	A34
	3NC	A35
	3NO-1NC	A36
	2NO-2NC	A37
	1NO-3NC	A38
	4NO	A39
	4NC	A40
Auxiliary contacts	Contacts mounted on operating mechanism of disconnect switch, 1NO-1NC	A42
	Contacts mounted on operating mechanism of disconnect switch, 2NO-2NC	A43
	With auxiliary contact omitted	A44
Accelerating relay	For two-speed	A46
	2NO/2NC 24 Vdc auxiliary relay— IT only	A47

B—Breaker Modifications, Backspin Timer, Undervoltage Release, Bell Alarm, Bus Choke

Modification	Description	Catalog Number Suffix
Breaker	1NO-1NC auxiliary contact on breaker	B1
	2NO-2NC auxiliary contacts on breaker	B2
	Shunt trip on circuit breaker—48–127 Vac or Vdc	B3
	Shunt trip on circuit breaker—9–24 Vac or Vdc	B4
	Shunt trip on circuit breaker—208–380 Vac	B5
	Shunt trip on circuit breaker—415–600 Vac or 220–250 Vdc	B6
	Undervoltage release for breaker	B8
	Current limiter mounted to breaker	B9
	Breaker—order by description	B10
	Thermal magnetic breaker	B11
	Backspin timer	180 seconds
Undervoltage release	Undervoltage release for circuit breaker—208–240 Vac	B13
	Undervoltage release for circuit breaker—380–480 Vac	B14
	Undervoltage release for circuit breaker—525–600 Vac	B15
Bell alarm	Bell alarm for circuit breaker	B16

Note

^① Available on **XT** starters for 40A and greater only.

C—Control Power Transformer, Power Supplies, Control Relays, Cover Control (not elsewhere defined), Current Transformers, Compelling Relay, Control Wiring, Control Circuit Breaker, Separate Control, Customer-Supplied Components, Contactors, Counter, E-Stop Relay, DC/AC Interface, Separate Source Disconnect, Bypass Contactors

Modification	Description	Catalog Number Suffix
Control power transformers	Standard size control transformer, 120V/60 Hz, 110V/50 Hz secondary with two primary and one secondary fuse	C1
Make sure eighth character specifies primary/secondary voltage	Standard size control transformer, 24V/60 Hz secondary with two primary and one secondary fuse	C2
	50 VA extra capacity CPT 120V/60 Hz, 110V/50 Hz with two primary and one secondary	C42
	100 VA extra capacity CPT, 120V/60 Hz, 110V/50 Hz secondary with two primary and one secondary fuse	C3
	100 VA extra capacity CPT, 24V/60 Hz secondary with two primary and one secondary fuse	C4
	200 VA extra capacity CPT, 120V/60 Hz, 110V/50 Hz secondary with two primary and one secondary fuse	C5
	200 VA extra capacity CPT, 24V/60 Hz secondary with two primary and one secondary fuse	C6
	300 VA extra capacity CPT, 120V/60 Hz, 110V/50 Hz secondary with two primary and one secondary fuse	C7
	400 VA extra capacity CPT, 120V/60 Hz, 110V/50 Hz secondary with two primary and one secondary fuse	C8
	1 kVA extra capacity CPT, 120V/60 Hz, 110V/50 Hz secondary with two primary and one secondary fuse	C9
	2 kVA extra capacity CPT, 120V/60 Hz, 110V/50 Hz secondary with two primary and one secondary fuse	C10
	Control transformer—order by description	C11
	CPT with power supply for XT	C34
	Power supplies (XT only)	Separate control 120 Vac to 24 Vdc
Power supply with extra capacity—order by description		C28
Control relays	Four-pole interposing relay, 600V (2NO/2NC)	C12
	Four-pole, unwired, A600 rtg.—2NO-2NC	C14
	Eight-pole, unwired, A600 rtg.—4NO-4NC	C15
	Control relay—order by description	C16
	Three-wire control module (C30 lighting)	C18 ①
	Two-wire control relay for mechanical/magnetic lighting contactors	C20 ①
Cover control	Convert position seven to E30 type cover control	C17
	Lock-off attachment added on cover control	C19
	Change to M22 (22 mm) cover controls	C29
Current transformer(s)	In phase 1	C21
	In phases 1 and 2	C22
	In 3 phases	C23
Compelling relay	—	C25
Control wiring	Omit control wiring	C26
	With separate control wiring and two 250V fuses in holder	C30
	With common control wiring and two 600V (Class C) fuses in holder	C31
	Control wiring type—order by description	C33
Control circuit breaker	Order by description	C32
Separate control	Wired for separate control (reduced voltage)	C35
Customer supplied components	Customer supplied components to be installed	C36
	Customer supplied wiring diagram to use	C37

Note

① Not available for **XT** starters.

Modification Codes

C—Control Power Transformer, IT Power Supplies, Control Relays, Cover Control (not elsewhere defined), Current Transformers, Compelling Relay, Control Wiring, Control Circuit Breaker, Separate Control, Customer-Supplied Components, Contactors, Counter, E-Stop Relay, DC/AC Interface, Separate Source Disconnect, Bypass Contactors, continued

Modification	Description	Catalog Number Suffix
Contactor/starter	Contactor/starter—order by description	C40
Counter	Operations counter	C41
E-stop relay	E-stop relay (DeviceNet)	C43
DC/AC interface	DC/AC interface module	C44 ^①
Separate source disconnect	IEC separate source disconnect for control circuitry	C45
Bypass contactors for IT RVSS	Isolation contactor	C46/J1
	Output contactor	C46/J2
	Bypass contactor	C46/J3
	Isolation/output/bypass contactor	C46/J4

D—Device Labels, Deceleration Relay, Drain and Breather, Duplex Modifications

Modification	Description	Catalog Number Suffix
Device labels	(Each label)	D1
Decel. relay ^①	Two-speed	D2
Drain and breather (Type 7/9 enclosure) ^①	Drain and breather	D5
	Drain only	D6
	Breather only	D7
Duplex modifications	Alternator omitted (deduct price)	D12
	START/STOP pushbuttons—supplied for each motor	D14
	HAND/OFF/AUTO selector switch—supplied for each motor	D15
	No. 1 lead—No. 2 lead selector switch for manual selection of lead pump (alternator is omitted)	D16
	Red RUN pilot light—supplied for each motor	D17
	Push-to-test red RUN pilot light—supplied for each motor	D18
	TEST pushbutton for each motor	D19
	CPT, 120V secondary, two primary fuses and one secondary fuse—supplied for each motor	D20
	CPT with 100VA extra capacity, 120V secondary, two primary fuses and one secondary fuse—supplied for each motor	D21
	CPT with 200VA extra capacity, 120V secondary, two primary fuses and one secondary fuse—supplied for each motor	D22
	CPT for duplex—order by description	D23
	Add two relays to modify controller to operate with single-pole pilot devices	D24
	Add three relays to modify controller to operate with single-pole pilot devices	D25
	Green—OFF for each starter	D26
	Green—push-to-test OFF for each starter	D27
	Green—RUN light (duplex pump)	D28
Red—STOP light (duplex pump)	D29	
P-T—green RUN light (duplex pump)	D30	
P-T—red STOP light (duplex pump)	D31	
Elapsed time meter (duplex pump)	D32	

Note

^① Not available for **XT** starters.

E—Enclosure Modifications, Elapsed Time Meter, Duplex Outlet, Enclosure for Starter, Enclosure Clear Cover, Enclosure Material

Modification	Description	Catalog Number Suffix
Enclosure modifications	Oversize enclosure	E3
	Enclosure—order by description	E4
	Enclosure with pole mounting hardware	E5
	Removable end plates	E6
	Service entrance rating (ground/neutral banding SE labels)	E7
	Service entrance rating with ground bar	E8
	Safety door interlock	E11
Elapsed time meter	Wired across coil, Type 1, 12	E9
	Wired across coil, Type 3R, 4X	
	Elapsed time meter—order by description	E10
Duplex outlet	Convenience duplex outlet mounted in side of enclosure	E12
Enclosure for starter ^①	Horizontal combination starter, Size 0–2	E13
	Narrow combination starter, Size 0–2	E14
Enclosure clear cover for XT	Clear cover for Halyester enclosure non-metallic	E19
Enclosure material	Convert to 316 stainless steel	E16
	Convert from Type 3R to stainless steel	E21
Irrigation pump panel	Bottom entry	E17

F—Fuse Clips, Fuse Blocks, Fungus Protection, Fingerproof Covers, EMI Filter

Modification	Description	Catalog Number Suffix
Fuse clips ^①	Change fuse clips in position eight to Class J	F1
	Change fuse clips in position eight to Class H and K (30A and 60A only)	F2
Fuse blocks	Power fuses included—order by description	F4
	30A control circuit fuseholder (KTK) mounted on panel (unwired), fuse not supplied	F5
	30A control circuit fuseholder mounted on panel (unwired), FNQR fuse supplied	F6
	Three-pole power fuseholder mounted on front contactor	F7
	Separate fusing of control power supply— IT .	F8
	Blown fuse indicator (not for PFC)	F10
	Class CC fuses	F21

G—Ground Fault Relay, Grounding

Modification	Description	Catalog Number Suffix
Ground fault relay	Ground fault relay (wired)	G1
	Ground fault relay (unwired)	G3
Grounding	Special grounding—order by description	G5
	Ground fault protection and monitoring panel	G7

Note

^① Not available for **XT** starters.

Modification Codes

H—Heater (Space), Heater Packs Installed

Modification	Description	Catalog Number Suffix
Space heater	Space heater and thermostat	H1
	Space heater and NC interlock	H2
Install heater packs (Freedom Series)	Class 20	Class 10
	/D1 H2001B-3	/D25 H2101B-3
	/D2 H2002B-3	/D26 H2102B-3
	/D3 H2003B-3	/D27 H2103B-3
	/D4 H2004B-3	/D28 H2104B-3
	/D5 H2005B-3	/D29 H2105B-3
	/D6 H2006B-3	/D30 H2106B-3
	/D7 H2007B-3	/D31 H2107B-3
	/D8 H2008B-3	/D32 H2108B-3
	/D9 H2009B-3	/D33 H2109B-3
	/D10 H2010B-3	/D34 H2110B-3
	/D11 H2011B-3	/D35 H2111B-3
	/D12 H2012B-3	/D36 H2112B-3
	/D13 H2013B-3	/D37 H2113B-3
	/D14 H2014B-3	/D38 H2114B-3
	/D15 H2015B-3	/D39 H2115-3
	/D16 H2016B-3	/D40 H2116-3
	/D17 H2017B-3	/D41 H2117-3
	/D18 H2018-3	
	/D19 H2019-3	
	/D20 H2020-3	
	/D21 H2021-3	
	/D22 H2022-3	
	/D23 H2023-3	
	/D24 H2024-3	

K—Keypad

Modification	Description	Catalog Number Suffix
Keypad	Door mounted keypad (RVSS)	K5

L—Labels and Lighting Contactors

Modification	Description	Catalog Number Suffix
Lighting arrestor	Lighting arrestor installed in enclosure on panel	L3
Lugs	Special lugs (order by description)	L9
Carton label	Customer marking—specify	L10
Lighting contactors	1 NC pole	L21
	2 NC pole	L22
	3 NC pole	L23
	4 NC pole	L24
	5 NC pole	L25
	6 NC pole	L26
	7 NC pole	L27
	8 NC pole	L28
	Three-wire 120 Vac	L29A
	Three-wire 240 Vac	L29B
	Three-wire 24 Vac	L29C
	Three-wire 24 Vdc	L29D
	Two-wire 120 Vac	L29E
	Two-wire 240 Vac	L29F
Two-wire 24 Vac	L29G	

N—Nameplates

Modification	Description	Catalog Number Suffix
Nameplates	Enclosure nameplates	N1

15.2

Accessories and Modification Codes

Modification Codes

P—Pilot Lights, Pushbuttons, Phase Relays, Potential Transformers, Power Factor Correction Capacitors, Program Timer, Percentage Timer, Photocell

Modification	Description	Catalog Number Suffix
Push-to-test pilot lights	Push-to-test pilot light (red RUN) wired to coil	P1
	Push-to-test pilot light (green OFF) wired in series with auxiliary contact	P2
	Combination of P1 and P2 above	P3
	Push-to-test pilot light (amber RUN) wired to coil	P4
	Push-to-test pilot light—green RUN	P49
	Push-to-test pilot light—green STOP	P57
Pushbuttons	EMERGENCY STOP—mushroom head	P5
	Pushbutton omitted	P6
	START/STOP	P7
	ON/OFF	P8
	START	P9
	ON	P10
	OFF	P11
	FORWARD/REVERSE/STOP	P12
	FAST/SLOW/STOP	P13
	FAST/OFF/SLOW	P14
	HIGH/LOW/STOP	P15
	HIGH/LOW	P16
	SLOW/FAST	P17
	Pushbutton with legend plate	P18
	UP/STOP/DOWN	P52
	OPEN/STOP/CLOSE	P53
	Red STOP pushbutton	P72
START/STOP pushbuttons (located in top two holes)	P73	
Green START pushbutton	P74	
Pilot lights	With one amber pilot light marked POWER AVAILABLE wired to load side of two fuses or circuit breaker	P19
	Pilot light (amber RUN) wired to coil	P20
	With one red pilot light marked RUN wired thru NO auxiliary contact	P21
	With one push-to-test red light marked RUN Wired thru NO auxiliary contact	P22
	Pilot light—red RUN	P23
	Pilot light—red ON	P24
	Pilot light—green OFF	P25
	Pilot light—order by description	P26
	Pilot light—red STOP	P29
	Pilot light—green STOP	P61
	FORWARD/REVERSE red pilot lights	P62
	UP/DOWN red pilot lights	P63
	OPEN/CLOSE red pilot lights	P64
	HIGH/LOW red pilot lights	P65
	FAST/SLOW red pilot lights	P66
	Green RUN light	P67
	LED bulbs	P68
	Blue OVERLOAD light	P69
	Amber fault pilot light	P71

P—Pilot Lights, Pushbuttons, Phase Relays, Potential Transformers, Power Factor Correction Capacitors, Program Timer, Percentage Timer, Photocell, continued

Modification	Description	Catalog Number Suffix
Illuminated pushbutton	Illuminated pushbutton—order by description	P27
Phase loss relay	Phase loss relay	P28
Phase reversal relay	Phase reversal relay	P30
Phase unbalance relay	Phase unbalance relay	P32
Phase monitoring relay	Phase monitoring relay	P34
Power factor correction capacitors	/F1 20 kVar /F9 70 kVar /F17 200 kVar	P38
	/F2 25 kVar /F10 75 kVar /F18 225 kVar	
	/F3 30 kVar /F11 80 kVar /F19 250 kVar	
	/F4 35 kVar /F12 90 kVar /F20 300 kVar	
	/F5 40 kVar /F13 100 kVar /F21 350 kVar	
	/F6 45 kVar /F14 125 kVar /F22 400 kVar	
	/F7 50 kVar /F15 150 kVar	
	/F8 60 kVar /F16 175 kVar	
Potential transformers	Potential transformer—wired L1–L2	P39
	Potential transformer—wired L1– L2 and L2–L3	P40
	Potential transformer—three phases	P41
Pump controller	Pump controller for <i>IT</i> .	P42
Program timers	15-minute program timer	P43
	24-hour program timer	P44
	7-day program timer with day omission feature	P45
Percentage timers	15-minute percentage timer	P47
	60-minute percentage timer	P48
Photocell	Photoelectric receptacle with photocell	P70

Q—IQ Products, DN50

Modification	Description	Catalog Number Suffix
IQ products	IQ 500	Q1
	IQ100	Q2
	IQ 1000	Q3
	IQ 4000	Q5
IQ data metering module	IQ data metering module	Q12
	IQ 220 with cable	Q14
DN50	DeviceNet input/output module	Q13

R—Ramp, Relays, Solid-State Electronic Overload Relays, Resets, Overload Relay Modifications, Reversing, DeviceNet Interface

Modification	Description	Catalog Number Suffix
Ramp	Extended ramp of <i>IT</i> .	R1
Relay	Overvoltage relay	R2
	Omit overload relay	R4

R—Ramp, Relays, Solid-State Electronic Overload Relays, Resets, Overload Relay Modifications, Reversing, DeviceNet Interface, continued

Modification	IEC Size	NEMA Size	Full Load Current Adjustment Range (A)	Three-Phase without Ground Fault Auto/Manual Reset Overload Selectable Class 10/20/30	Three-Phase with Ground Fault Auto/Manual Reset Overload Selectable Class 10/20/30
Solid-state electronic overload relay ^①	B and C	00	0.33–1.65 ^②	R63/A	R64/A
			1–5	R63/B	R64/B
			4–20	R63/C	R64/C
	C and D	0 and 1	0.33–1.65 ^②	R63/A	R64/A
			1–5	R63/B	R64/B
			4–20	R63/C	R64/C
			9–45	R63/D	R64/D
	D	2	9–45	R63/D	R64/D
	D, F and G	3	20–100	R63/E	R64/E
	G	4	28–140	R63/F	R64/F
	N/A	5	60–300 ^③	R63/G	R64/G
	N/A	6	120–600 ^④	R63/H	R64/H

Modification	Description	Catalog Number Suffix
Resets ^⑤	Change external reset to internal reset—hole covered with plug	R5
	Internal reset—no hole plug	R6
	Overload reset (order by description)	R7
	Manual reset only on overload relay	R44
	Auto reset only on overload relay	R45
	Internal trip indicator—no external reset	R47
	External reset with external trip indicator	R48
	External reset with bell alarm	R49
	N3R reset boot added (Type 1/12 only)	R71
Reversing ^⑥	Reversing contactor/starter	R54
Overload relay mods	Anti plug-in	R53
DeviceNet interface	DeviceNet interface	R69
	Standard reset for DeviceNet	R65
	Lighted reset for DeviceNet	R66
	Trip indicator for DeviceNet	R67

Notes

^① Features:

- Self-powered
- Phase loss protection
- Current adjustment knob
- ±1% repeat accuracy
- 1NO and 1NC isolated contacts

^② Not UL Listed.

^③ NEMA Size 5 starter available with 60–300A panel mounted CTs. Starter as an assembled unit with 1–5A C440 overload relay (C440A1A005SELAX or C440A2A005SELAX).

^④ NEMA Size 6 starter available with 120–600A panel mounted CTs. Starter as an assembled unit with 1–5A C440 overload relay (C440A1A005SELAX or C440A2A005SELAX).

^⑤ Not available for **XT** starters.

S—System Voltage, Selector Switches, Suppressor, Incomplete Sequence Protection, Single-Phase Jumper, Surge Capacitor, Speed Potentiometer

Modification	Description	Catalog Number Suffix
System voltage selection	System voltage selection for internal components	S1
	/H1 208V 60 Hz	
	/H2 240V 60 Hz	
	/H3 277V 60 Hz, single-phase	
	/H4 480V 60 Hz	
	/H5 600V 60 Hz	
	/H6 796V 60 Hz	
	/H7 220V 50 Hz	
	/H8 380V 50 Hz	
	/H9 415V 50 Hz	
	/H10 550V 50 Hz	
	/H11 660V 50 Hz	
	/H12 380V 60 Hz	
	/H13 1500V 60 Hz	
	System voltage selection—specify on order	S2
Selector switches ^①	HAND/OFF/AUTO	S3
	HAND/AUTO	S4
	HAND/OFF/AUTO selector switch with one red RUN pilot light	S5
	RUN/OFF/AUTO	S6
	AUTO/OFF/TEST	S7
	AUTO/OFF/TEST selector switch with one red RUN pilot light	S8
	AUTO/OFF/TEST selector switch with one red RUN pilot light and one green pilot light	S9
	OFF/AUTO	S10
	START/STOP	S11
	OFF/ON	S12
	HIGH/LOW	S13
	FAST/OFF/SLOW	S14
	SLOW/FAST	S15
	FORWARD/REVERSE	S16
	HIGH/OFF/LOW	S17
	HIGH/LOW/OFF/AUTO	S18
	Selector switch omitted (pumps only)	S19
	HAND/OFF/AUTO spring return from left	S21
	OPEN/OFF/CLOSE	S41
	FORWARD/OFF/REVERSE	S42
FAST/OFF/SLOW/AUTO	S43	
Selector switch omitted (pump panels only)	S19	
Selector switch—order by description	S40	
RVSS/BYPASS (soft starters only)	S44	
LOCAL/REMOTE selector switch	S45	
RUN/OFF selector switch	S46	
Suppressor	Transient suppressor mounted on magnet coil	S24
Surge suppression	MOV (IT)	S20
Sequence timer	Sequence timer (pump panels)	S26
Sequence protection	Incomplete sequence protection	S27
Pump	480V BP9000 pump	S28
Single-phase	Convert contactor or starter from three-phase to single-phase—install jumper	S29
	Single-phase rev. 120V	S30
	Single-phase rev. 240V	S31
Surge capacitor	Surge capacitor wired to disconnect line side	S37

Note

^① When using three-position selector switch with magnetic lighting contactor, mod **C20** must also be used (ECL04, ECL13, ECL15).

T—Timers, Time Delay Relays, Terminal Blocks, Terminal Points, Ring Lug Connections

Modification	Description	Catalog Number Suffix
Timers	Pneumatic timer installed on contactor, unwired, 30 seconds maximum	T1
	Pneumatic timer installed on contactor, unwired, 180 seconds maximum	T2
	Pneumatic timer mounted in enclosure, unwired, 180 seconds maximum	T3
	Solid-state ON delay timer (1–30 seconds)	T4
	Solid-state ON delay timer (30–300 seconds)	T5
	Timer—order by description	T25
Time delay relays	Time delay relay, 3 minutes maximum, unwired, ON DELAY	T6
	Time delay relay, 3 minutes maximum, unwired, OFF DELAY	T7
	Time delay low voltage release relay	T8
Terminal blocks	With one single circuit terminal block, unwired	T9
	With two single circuit terminal block, unwired	T10
Terminal points	With 6 terminal points, unwired	T11
	With 12 terminal points, unwired	T12
	With 18 terminal points, unwired	T13
	Terminal point per customer specification, unwired (price each)	T14
	Terminal point per customer specification, wired (unwired without customer diagram)	T15
	Three terminals mounted between contactor and overload for power factor capacitors—Sizes 0–2	T21
	Three terminals mounted between contactor and overload for power factor capacitors—Sizes 3–4	T22
Ring lug connections	Quick-connect terminals added to DP contactor/starter	T23
	Ring lug connections on power wires	T16 ^①
	Ring lug connections on control wires	T17

15 U—Undervoltage Relay, Time Delay Undervoltage Relay

Modification	Description	Catalog Number Suffix
Undervoltage relays	Undervoltage relay, non-adjustable	U1
	Undervoltage relay, adjustable	U2
Time delay undervoltage relays	Time delay undervoltage relay, non-adjustable	U4
	Time delay undervoltage relay, adjustable	U5
Under- and overvoltage relay	Under- and overvoltage relay	U7

Note

^① Not available for **XT** starters.

V— Voltmeter, Varmeter, Vacuum Starter

Modification	Description	Catalog Number Suffix
Voltsmeters	One panel type voltmeter wired L1–L2	V1
	Panel type voltmeter and selector switch wired to read three-line voltages	V2
	Miniature voltmeter wired L1–L2	V3 ①
	Miniature voltmeter and selector switch wired to read three-line voltages	V4 ①
	Switchboard type voltmeter wired L1 – L2	V5
	Switchboard type voltmeter and selector switch wired to read three-line voltage	V6 ①
	Three panel type voltmeters wired in each phase	V7
	Three miniature voltmeters wired in each phase	V8 ①
	Three switchboard type voltmeters wired in each phase	V9 ①
	Voltmeter—order by description	V10
Varmeter ②	Varmeter	V11
	Varmeter—order by description	V12
Vacuum starter ②	Vacuum starter—1500V rating	V13

W— Wattmeter, Watt-Hour Meter, Wiremarkers, Wiring Diagram

Modification	Description	Catalog Number Suffix
Wattmeter ①	Wattmeter	W1
Watt-hour meter ①	Watt-hour meter	W3
	Watt-hour meter with demand attachment	W5
Wiremarkers	Wiremarkers	W7
	Wiremarkers—order per customer diagram or specifications	W8
	Wiremarkers—order by description	W9
WYE-Delta hp	See Tab 5	W10 ②
Windows in enclosure	Enclosure windows	W11
Wiring diagram	Reduced copy of custom wiring diagram laminated on inside of door	W12

Notes

① Type 1/12 only.

② Not available for **XT** starters.