

Metalux AP Series

DESCRIPTION

FM series is a versatile LED ceiling or wall mount series which can be used in a broad range of residential and commercial applications. This series provides customers with a high quality luminaire utilizing the latest LED, solid state lighting and electronic driver technology for optimal performance and maximized energy efficiency. With a traditional opal white lens, the FM series produces even, uniform light distribution and ideal choice for offices, corridors, stairways, bedroom, closet and foyers applications where customers are replacing incandescent, circline or compact fluorescent lamps.

Catalog #		Type
Project		
Comments		Date
Prepared by		

SPECIFICATION FEATURES

Construction

Housing consists of die formed steel which is post painted to offer the ideal aesthetics. Diffuser are white opal injection molded acrylic blends offering the ideal light distribution. These lens are offered in three different sizes: 9, 11, 15, 19 inch models. Lens are attached with easy mount tabs.

Controls

Equipped standard with triac dimmable electronic drivers which provides extensive energy savings over existing fluorescent lamp options. All drivers are suitable for 120V applications. Dimmable to 10%; compatible with most Triac dimmers.

Electrical

Long-Life LED system coupled with electrical driver to deliver optimal performance. LEDs are 3000K or 4000K with a typical CRI 80. Projected life is 50,000 hours at 70% lumen output.

Shielding

Specially developed LED lens blend allows this product series to offer optimal light out and providing smooth even illumination with no pixilation. Lenses are designed from smooth opal white acrylic and provide 360° uniform light distribution. Lens is securely held in place by swing clips and can be easily removed for installation and maintenance.

Installation

Fixture may be surface (wall or ceiling) mounted.

Compliance

UL/CUL Listed. Energy Star Qualified. Lighting Facts Approved. Suitable for Damp locations.



FM LED Flushmount

Wall or Ceiling Mount

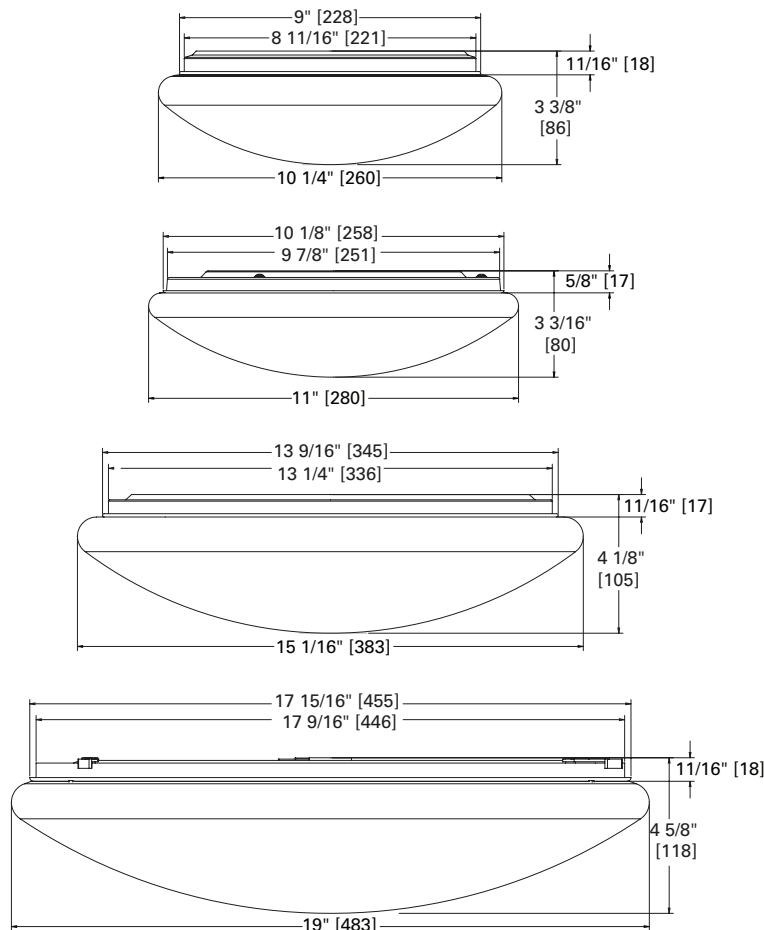

Wattage

Size	3000K	4000K	Watts
9"	950	950	12.2
11"	1050	1100	13.5
15"	1600	1700	21.3
19"	2350	2450	30.5

ORDERING INFORMATION

Application FM	Fixture Size	Color W	Fixture Shape R	CCT	Voltage R
FM = Flush Mount	9 = 9" 11 = 11" 15 = 15" 19 = 19"	W = White	R = Round	30 = 3000K 40 = 4000K	R = 120V

Specifications & dimensions subject to change without notice.
Consult your Eaton Representative for availability and ordering information.

3000K LIGHTING FACTS

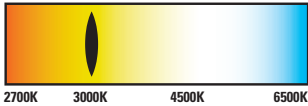
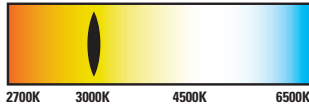
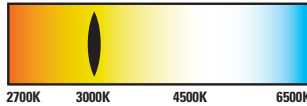
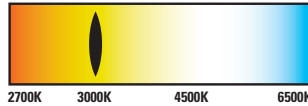
PRODUCT SPECIFICATIONS	PRODUCT SPECIFICATIONS	PRODUCT SPECIFICATIONS	PRODUCT SPECIFICATIONS
Lumens (Light Output) 950	Lumens (Light Output) 1050	Lumens (Light Output) 1600	Lumens (Light Output) 2350
Watts 12.2	Watts 13.5	Watts 21.3	Watts 30.4
Lumens Per Watt (Efficacy) 78	Lumens Per Watt (Efficacy) 78	Lumens Per Watt (Efficacy) 75	Lumens Per Watt (Efficacy) 77
Color Accuracy (CRI) 80	Color Accuracy (CRI) 80	Color Accuracy (CRI) 80	Color Accuracy (CRI) 80
Light Color (CCT) 3000K <small>Correlated Color Temperature (CCT)</small>	Light Color (CCT) 3000K <small>Correlated Color Temperature (CCT)</small>	Light Color (CCT) 3000K <small>Correlated Color Temperature (CCT)</small>	Light Color (CCT) 3000K <small>Correlated Color Temperature (CCT)</small>
			
FM9WR30R	FM11WR30R	FM15WR30R	FM19WR30R

4000K LIGHTING FACTS

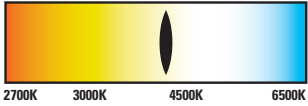
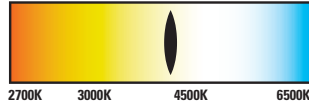
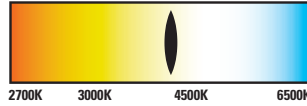
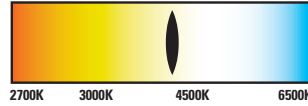
PRODUCT SPECIFICATIONS	PRODUCT SPECIFICATIONS	PRODUCT SPECIFICATIONS	PRODUCT SPECIFICATIONS
Lumens (Light Output) 950	Lumens (Light Output) 1100	Lumens (Light Output) 1700	Lumens (Light Output) 2450
Watts 11.4	Watts 13.3	Watts 20.2	Watts 30.5
Lumens Per Watt (Efficacy) 83	Lumens Per Watt (Efficacy) 83	Lumens Per Watt (Efficacy) 83	Lumens Per Watt (Efficacy) 80
Color Accuracy (CRI) 80	Color Accuracy (CRI) 80	Color Accuracy (CRI) 80	Color Accuracy (CRI) 80
Light Color (CCT) 4000K <small>Correlated Color Temperature (CCT)</small>	Light Color (CCT) 4000K <small>Correlated Color Temperature (CCT)</small>	Light Color (CCT) 4000K <small>Correlated Color Temperature (CCT)</small>	Light Color (CCT) 4000K <small>Correlated Color Temperature (CCT)</small>
			
FM9WR40R	FM11WR40R	FM15WR40R	FM19WR40R

Shipping Data

Catalog No.	Individual Wt.	Master Pack
FM9	1.0 lbs.	8
FM11	1.8 lbs.	4
FM15	3.5 lbs.	4
FM19	5.6 lbs.	2

Retail Catalog Data

Catalog No.	UPC	I2of5
FM9WR30R	080083757510	10080083757517
FM9WR40R	080083770168	10080083757494
FM11WR30R	080083757473	10080083757470
FM11WR40R	080083770083	10080083770080
FM15WR30R	080083757435	10080083757432
FM15WR40R	080083760466	10080083760463
FM19WR30R	080083757398	10080083757395
FM19WR40R	080083760473	10080083760470

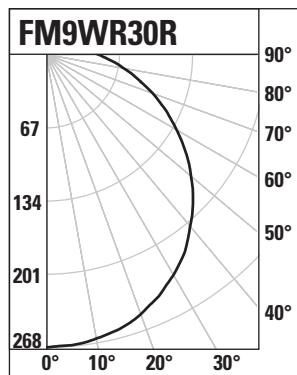

Description
9° Circular LED flush mount luminaire

CCT = 3000K
Lumens = 1048.1
Input Watts = 12.2
Efficacy = 85.9
Test Report = P27993

Zonal Lumen Summary table with columns for Zone, Lumens, and % Fixture.

Coefficients of Utilization

Effective floor cavity reflectance 20%

Table with columns for rc, rw, RCR, and utilization coefficients for 80%, 70%, 50%, 30%, 10%, and 0% reflectance.

Candlepower

Candlepower table with columns for 0° and Flux values at various angles (0° to 90°).

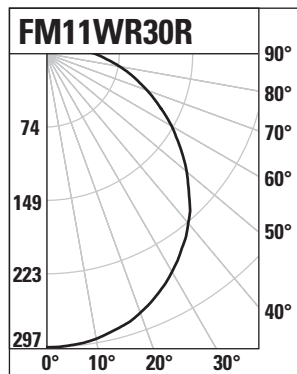

Description
11° Circular LED flush mount luminaire

CCT = 3000K
Lumens = 1098.5
Input Watts = 13.5
Efficacy = 81.4
Test Report = P27995

Zonal Lumen Summary table with columns for Zone, Lumens, and % Fixture.

Coefficients of Utilization

Effective floor cavity reflectance 20%

Table with columns for rc, rw, RCR, and utilization coefficients for 80%, 70%, 50%, 30%, 10%, and 0% reflectance.

Candlepower

Candlepower table with columns for 0° and Flux values at various angles (0° to 90°).

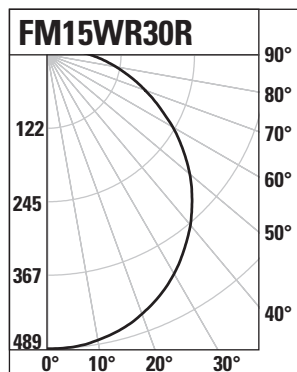

Description
15° Circular LED flush mount luminaire

CCT = 3000K
Lumens = 1793.9
Input Watts = 21.4
Efficacy = 83.8
Test Report = P27997

Zonal Lumen Summary table with columns for Zone, Lumens, and % Fixture.

Coefficients of Utilization

Effective floor cavity reflectance 20%

Table with columns for rc, rw, RCR, and utilization coefficients for 80%, 70%, 50%, 30%, 10%, and 0% reflectance.

Candlepower

Candlepower table with columns for 0° and Flux values at various angles (0° to 90°).

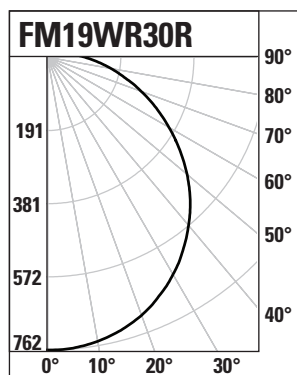

Description
19° Circular LED flush mount luminaire

CCT = 3000K
Lumens = 2669.6
Input Watts = 30.5
Efficacy = 87.5
Test Report = P27999

Zonal Lumen Summary table with columns for Zone, Lumens, and % Fixture.

Coefficients of Utilization

Effective floor cavity reflectance 20%

Table with columns for rc, rw, RCR, and utilization coefficients for 80%, 70%, 50%, 30%, 10%, and 0% reflectance.

Candlepower

Candlepower table with columns for 0° and Flux values at various angles (0° to 90°).

Metalux AP Series

DESCRIPTION

FM series is a versatile LED ceiling or wall mount series which can be used in a broad range of residential and commercial applications. This series provides customers with a high quality luminaire utilizing the latest LED, solid state lighting and electronic driver technology for optimal performance and maximized energy efficiency. With a traditional opal white lens, the FM series produces even, uniform light distribution and ideal choice for offices, corridors, stairways, bedroom, closet and foyers applications where customers are replacing incandescent, circline or compact fluorescent lamps.

Catalog #		Type
Project		
Comments		Date
Prepared by		

SPECIFICATION FEATURES

Construction

Housing consists of die formed steel which is post painted to offer the ideal aesthetics. Diffuser are white opal injection molded acrylic blends offering the ideal light distribution. These lens are offered in three different sizes: 9, 11, 15, 19 inch models. Lens are attached with easy mount tabs.

Controls

Equipped standard with triac dimmable electronic drivers which provides extensive energy savings over existing fluorescent lamp options. All drivers are suitable for 120V applications. Dimmable to 10%; compatible with most Triac dimmers.

Electrical

Long-Life LED system coupled with electrical driver to deliver optimal performance. LEDs are 3000K or 4000K with a typical CRI 80. Projected life is 50,000 hours at 70% lumen output.

Shielding

Specially developed LED lens blend allows this product series to offer optimal light out and providing smooth even illumination with no pixilation. Lenses are designed from smooth opal white acrylic and provide 360° uniform light distribution. Lens is securely held in place by swing clips and can be easily removed for installation and maintenance.

Installation

Fixture may be surface (wall or ceiling) mounted.

Compliance

UL/CUL Listed. Energy Star Qualified. Lighting Facts Approved. Suitable for Damp locations.



FM LED Flushmount

Wall or Ceiling Mount

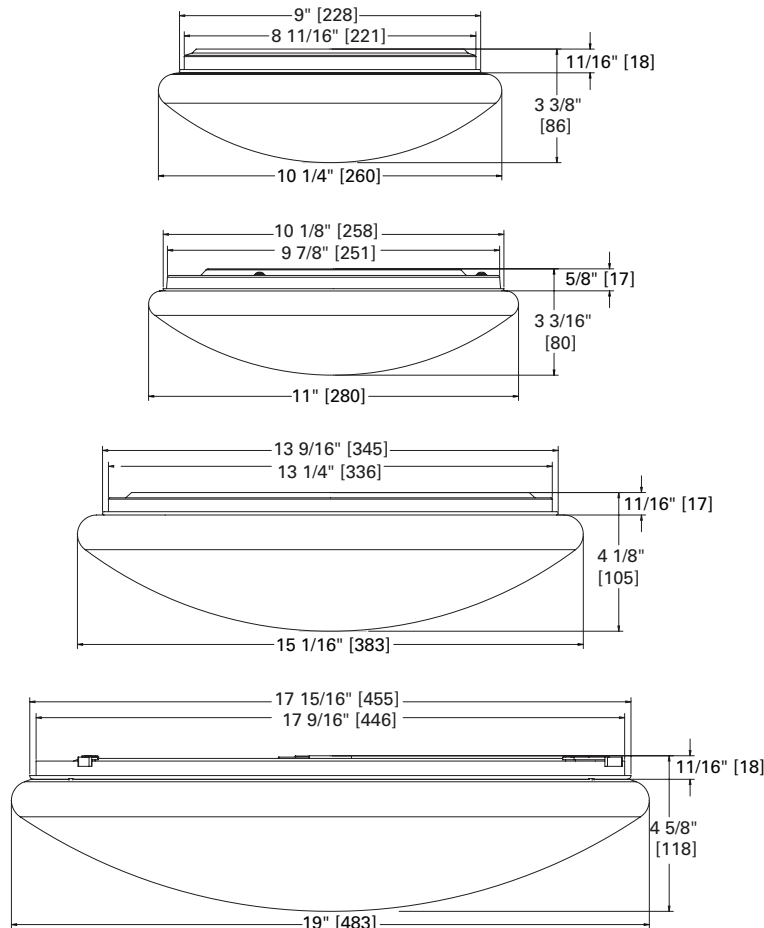

Wattage

Size	3000K	4000K	Watts
9"	950	950	12.2
11"	1050	1100	13.5
15"	1600	1700	21.3
19"	2350	2450	30.5

ORDERING INFORMATION

Application FM	Fixture Size	Color W	Fixture Shape R	CCT	Voltage R
FM = Flush Mount	9 = 9" 11 = 11" 15 = 15" 19 = 19"	W = White	R = Round	30 = 3000K 40 = 4000K	R = 120V

Specifications & dimensions subject to change without notice.
Consult your Eaton Representative for availability and ordering information.

3000K LIGHTING FACTS

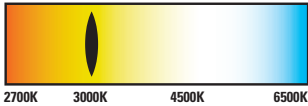
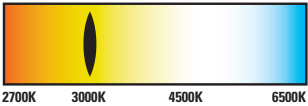
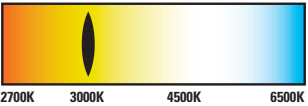
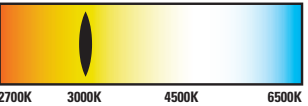
PRODUCT SPECIFICATIONS	PRODUCT SPECIFICATIONS	PRODUCT SPECIFICATIONS	PRODUCT SPECIFICATIONS
Lumens (Light Output) 950	Lumens (Light Output) 1050	Lumens (Light Output) 1600	Lumens (Light Output) 2350
Watts 12.2	Watts 13.5	Watts 21.3	Watts 30.4
Lumens Per Watt (Efficacy) 78	Lumens Per Watt (Efficacy) 78	Lumens Per Watt (Efficacy) 75	Lumens Per Watt (Efficacy) 77
Color Accuracy (CRI) 80	Color Accuracy (CRI) 80	Color Accuracy (CRI) 80	Color Accuracy (CRI) 80
Light Color (CCT) 3000K <small>Correlated Color Temperature (CCT)</small>	Light Color (CCT) 3000K <small>Correlated Color Temperature (CCT)</small>	Light Color (CCT) 3000K <small>Correlated Color Temperature (CCT)</small>	Light Color (CCT) 3000K <small>Correlated Color Temperature (CCT)</small>
			
FM9WR30R	FM11WR30R	FM15WR30R	FM19WR30R

4000K LIGHTING FACTS

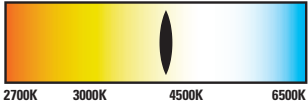
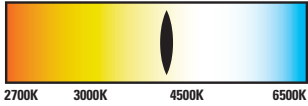
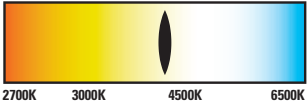
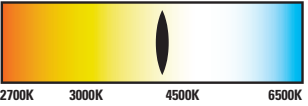
PRODUCT SPECIFICATIONS	PRODUCT SPECIFICATIONS	PRODUCT SPECIFICATIONS	PRODUCT SPECIFICATIONS
Lumens (Light Output) 950	Lumens (Light Output) 1100	Lumens (Light Output) 1700	Lumens (Light Output) 2450
Watts 11.4	Watts 13.3	Watts 20.2	Watts 30.5
Lumens Per Watt (Efficacy) 83	Lumens Per Watt (Efficacy) 83	Lumens Per Watt (Efficacy) 83	Lumens Per Watt (Efficacy) 80
Color Accuracy (CRI) 80	Color Accuracy (CRI) 80	Color Accuracy (CRI) 80	Color Accuracy (CRI) 80
Light Color (CCT) 4000K <small>Correlated Color Temperature (CCT)</small>	Light Color (CCT) 4000K <small>Correlated Color Temperature (CCT)</small>	Light Color (CCT) 4000K <small>Correlated Color Temperature (CCT)</small>	Light Color (CCT) 4000K <small>Correlated Color Temperature (CCT)</small>
			
FM9WR40R	FM11WR40R	FM15WR40R	FM19WR40R

Shipping Data

Catalog No.	Individual Wt.	Master Pack
FM9	1.0 lbs.	8
FM11	1.8 lbs.	4
FM15	3.5 lbs.	4
FM19	5.6 lbs.	2

Retail Catalog Data

Catalog No.	UPC	I2of5
FM9WR30R	080083757510	10080083757517
FM9WR40R	080083770168	10080083757494
FM11WR30R	080083757473	10080083757470
FM11WR40R	080083770083	10080083770080
FM15WR30R	080083757435	10080083757432
FM15WR40R	080083760466	10080083760463
FM19WR30R	080083757398	10080083757395
FM19WR40R	080083760473	10080083760470

