

# FF70

Compact, tough and good looking cast aluminum housing with hinged framed glass lens. Integra Hood glare shield and stainless steel clip. Lamp supplied.

Color: Bronze

Weight: 6.8 lbs

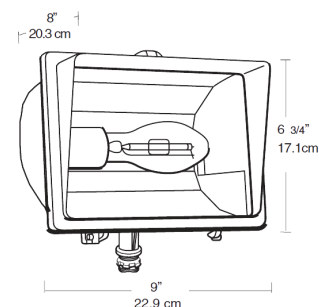

## Lamp Info

Type: ED17  
 Watts: 70W  
 Shape/Size: N/A  
 Base: N/A  
 ANSI: N/A  
 Hours: 24,000  
 Lamp Lumens: 6,400  
 Efficacy: 74 LPW

## Ballast Info

Type: R-NPF 120V  
 120V: 2.1/1.6A  
 208V: N/A  
 240V: N/A  
 277V: N/A  
 Input Watts: 86W  
 Efficiency: 81%

## Technical Specifications

### UL Listing:

Suitable for wet locations. Suitable for mounting within 1.2m (4ft) of the ground.

### Sockets:

Porcelain with all copper current carrying components.

### Housing:

Precision die cast aluminum, 1/2" NPS threaded arm with locking swivel fits all standard mounting boxes .

### Reflector:

Anodized semi-specular aluminum.

### Lens:

Thermal tempered shock resistant glass.

### Lens Gasket:

High temperature tubular silicone set in die cast retaining groove remains in place during relamping .

### Socket:

Glazed porcelain 4kv pulse rated with nickel plated screw shell and spring contacts .

### Finish:

Our environmentally friendly polyester powder coatings are formulated for high-durability and long-lasting color, and contains no VOC or toxic heavy metals.

### EPA:

0.43.

### Patents:

Pat. D420,458.

# FF70

Compact, tough and good looking cast aluminum housing with hinged framed glass lens. Integra Hood glare shield and stainless steel clip. Lamp supplied.

Color: Bronze

Weight: 6.8 lbs

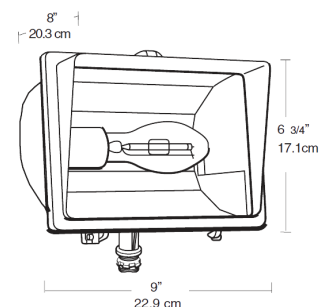

## Lamp Info

Type: ED17  
 Watts: 70W  
 Shape/Size: N/A  
 Base: N/A  
 ANSI: N/A  
 Hours: 24,000  
 Lamp Lumens: 6,400  
 Efficacy: 74 LPW

## Ballast Info

Type: R-NPF 120V  
 120V: 2.1/1.6A  
 208V: N/A  
 240V: N/A  
 277V: N/A  
 Input Watts: 86W  
 Efficiency: 81%

## Technical Specifications

### UL Listing:

Suitable for wet locations. Suitable for mounting within 1.2m (4ft) of the ground.

### Sockets:

Porcelain with all copper current carrying components.

### Housing:

Precision die cast aluminum, 1/2" NPS threaded arm with locking swivel fits all standard mounting boxes .

### Reflector:

Anodized semi-specular aluminum.

### Lens:

Thermal tempered shock resistant glass.

### Lens Gasket:

High temperature tubular silicone set in die cast retaining groove remains in place during relamping .

### Socket:

Glazed porcelain 4kv pulse rated with nickel plated screw shell and spring contacts .

### Finish:

Our environmentally friendly polyester powder coatings are formulated for high-durability and long-lasting color, and contains no VOC or toxic heavy metals.

### EPA:

0.43.

### Patents:

Pat. D420,458.