

Miniature Circuit Breakers FAZ, FAZ-PN, FAZ-HS

SG55812



FAZ

- High-quality miniature circuit breakers for industrial applications and residential applications
- Contact position indicator red - green
- Guide for secure terminal connection
- 3-position DIN rail clip, permits removal from existing busbar system
- Comprehensive range of accessories suitable for subsequent installation
- Rated currents up to 63 A
- Tripping characteristics B, C, D, K, S, Z
- Rated breaking capacity up to 15 kA according to IEC/EN 60947-2

FAZ-PN

- Tripping characteristic B
- Rated breaking capacity up to 6 kA according to IEC/EN 60898-1
- Module width 1MU (1+N-poles)

FAZ-HS

- Tripping characteristic B
- Rated breaking capacity up to 10 kA according to IEC/EN 60898-1
- 1- and 2-poles available

FAZ Miniature Circuit Breakers (MCBs)

Characteristic B

	Rated current I_n (A)	Rated voltage (V)	Breaking capacity acc. to IEC/EN 60947-2 (kA)	Rated voltage UL1077 (V)	Breaking capacity acc. to UL1077 (kA)	Type Designation	Article No.	Units per package
1-pole								
1	240/415	15	277	10		FAZ-B1/1	182114	12
1.5	240/415	15	277	10		FAZ-B1,5/1	182115	12
1.6	240/415	15	277	10		FAZ-B1,6/1	182116	12
2	240/415	15	277	10		FAZ-B2/1	182117	12
3	240/415	15	277	10		FAZ-B3/1	182119	12
3.5	240/415	15	277	10		FAZ-B3,5/1	182120	12
4	240/415	15	277	10		FAZ-B4/1	182121	12
5	240/415	15	277	10		FAZ-B5/1	182122	12
6	240/415	15	277	10		FAZ-B6/1	182123	12
8	240/415	15	277	10		FAZ-B8/1	182124	12
10	240/415	15	277	10		FAZ-B10/1	182125	12
12	240/415	15	277	10		FAZ-B12/1	182126	12
13	240/415	15	277	10		FAZ-B13/1	182127	12
15	240/415	15	277	10		FAZ-B15/1	182128	12
16	240/415	15	277	10		FAZ-B16/1	182129	12
20	240/415	15	277	10		FAZ-B20/1	182130	12
25	240/415	15	277	10		FAZ-B25/1	182131	12
32	240/415	15	277	10		FAZ-B32/1	182132	12
40	240/415	15	277	5		FAZ-B40/1	182133	12
50	240/415	15	277	5		FAZ-B50/1	182134	12
63	240/415	15	277	5		FAZ-B63/1	182135	12

SG53112



SG56612



1+N-pole								
1	240	15	277	10		FAZ-B1/1N	182136	6
1.5	240	15	277	10		FAZ-B1,5/1N	182137	6
1.6	240	15	277	10		FAZ-B1,6/1N	182138	6
2	240	15	277	10		FAZ-B2/1N	182139	6
2.5	240	15	277	10		FAZ-B2,5/1N	182140	6
3	240	15	277	10		FAZ-B3/1N	182141	6
3.5	240	15	277	10		FAZ-B3,5/1N	182142	6
4	240	15	277	10		FAZ-B4/1N	182143	6
5	240	15	277	10		FAZ-B5/1N	182144	6
6	240	15	277	10		FAZ-B6/1N	182145	6
8	240	15	277	10		FAZ-B8/1N	182146	6
10	240	15	277	10		FAZ-B10/1N	182147	6
12	240	15	277	10		FAZ-B12/1N	182148	6
13	240	15	277	10		FAZ-B13/1N	182149	6
15	240	15	277	10		FAZ-B15/1N	182150	6
16	240	15	277	10		FAZ-B16/1N	182151	6
20	240	15	277	10		FAZ-B20/1N	182152	6
25	240	15	277	10		FAZ-B25/1N	182153	6
32	240	15	277	10		FAZ-B32/1N	182154	6
40	240	15	277	5		FAZ-B40/1N	182155	6
50	240	15	277	5		FAZ-B50/1N	182156	6
63	240	15	277	5		FAZ-B63/1N	182157	6

SG55112



Rated current I_n (A)	Rated voltage (V)	Breaking capacity acc. to IEC/EN 60947-2 (kA)	Rated voltage UL1077 (V)	Breaking capacity acc. to UL1077 (kA)	Type Designation	Article No.	Units per package
----------------------------	----------------------	---	--------------------------------	--	---------------------	-------------	-------------------------

2-pole

1	415	15	480Y/277	10	FAZ-B1/2	182158	6
1.5	415	15	480Y/277	10	FAZ-B1,5/2	182159	6
1.6	415	15	480Y/277	10	FAZ-B1,6/2	182160	6
2	415	15	480Y/277	10	FAZ-B2/2	182161	6
2.5	415	15	480Y/277	10	FAZ-B2,5/2	182162	6
3	415	15	480Y/277	10	FAZ-B3/2	182112	6
3.5	415	15	480Y/277	10	FAZ-B3,5/2	182113	6
4	415	15	480Y/277	10	FAZ-B4/2	182175	6
5	415	15	480Y/277	10	FAZ-B5/2	182176	6
6	415	15	480Y/277	10	FAZ-B6/2	182177	6
7	415	15	480Y/277	10	FAZ-B7/2	182178	6
8	415	15	480Y/277	10	FAZ-B8/2	182179	6
10	415	15	480Y/277	10	FAZ-B10/2	182180	6
12	415	15	480Y/277	10	FAZ-B12/2	182181	6
13	415	15	480Y/277	10	FAZ-B13/2	182182	6
15	415	15	480Y/277	10	FAZ-B15/2	182183	6
16	415	15	480Y/277	10	FAZ-B16/2	182184	6
20	415	15	480Y/277	10	FAZ-B20/2	182185	6
25	415	15	480Y/277	10	FAZ-B25/2	182186	6
32	415	15	480Y/277	10	FAZ-B32/2	182188	6
40	415	15	480Y/277	5	FAZ-B40/2	182189	6
50	415	15	480Y/277	5	FAZ-B50/2	182190	6
63	415	15	480Y/277	5	FAZ-B63/2	182191	6

SG53412



3-pole

1	415	15	480Y/277	10	FAZ-B1/3	182192	4
1.5	415	15	480Y/277	10	FAZ-B1,5/3	182193	4
1.6	415	15	480Y/277	10	FAZ-B1,6/3	182194	4
2	415	15	480Y/277	10	FAZ-B2/3	182195	4
2.5	415	15	480Y/277	10	FAZ-B2,5/3	182196	4
3	415	15	480Y/277	10	FAZ-B3/3	182197	4
3.5	415	15	480Y/277	10	FAZ-B3,5/3	182198	4
4	415	15	480Y/277	10	FAZ-B4/3	182199	4
5	415	15	480Y/277	10	FAZ-B5/3	182200	4
6	415	15	480Y/277	10	FAZ-B6/3	182201	4
7	415	15	480Y/277	10	FAZ-B7/3	182202	4
8	415	15	480Y/277	10	FAZ-B8/3	182203	4
10	415	15	480Y/277	10	FAZ-B10/3	182204	4
12	415	15	480Y/277	10	FAZ-B12/3	182205	4
13	415	15	480Y/277	10	FAZ-B13/3	182206	4
15	415	15	480Y/277	10	FAZ-B15/3	182207	4
16	415	15	480Y/277	10	FAZ-B16/3	182208	4
20	415	15	480Y/277	10	FAZ-B20/3	182209	4
25	415	15	480Y/277	10	FAZ-B25/3	182210	4
32	415	15	480Y/277	10	FAZ-B32/3	182212	4
40	415	15	480Y/277	5	FAZ-B40/3	182213	4
50	415	15	480Y/277	5	FAZ-B50/3	182214	4
63	415	15	480Y/277	5	FAZ-B63/3	182215	4

SG55712



Rated current I_n (A)	Rated voltage (V)	Breaking capacity acc. to IEC/EN 60947-2 (kA)	Rated voltage UL1077 (V)	Breaking capacity acc. to UL1077 (kA)	Type Designation	Article No.	Units per package
----------------------------	----------------------	---	--------------------------------	--	---------------------	-------------	-------------------------

3+N-pole

1	415	15	480Y/277	10	FAZ-B1/3N	182216	3
1.5	415	15	480Y/277	10	FAZ-B1,5/3N	182217	3
1.6	415	15	480Y/277	10	FAZ-B1,6/3N	182218	3
2	415	15	480Y/277	10	FAZ-B2/3N	182219	3
2.5	415	15	480Y/277	10	FAZ-B2,5/3N	182220	3
3	415	15	480Y/277	10	FAZ-B3/3N	182221	3
3.5	415	15	480Y/277	10	FAZ-B3,5/3N	182222	3
4	415	15	480Y/277	10	FAZ-B4/3N	182223	3
5	415	15	480Y/277	10	FAZ-B5/3N	182224	3
6	415	15	480Y/277	10	FAZ-B6/3N	182225	3
8	415	15	480Y/277	10	FAZ-B8/3N	182226	3
10	415	15	480Y/277	10	FAZ-B10/3N	182227	3
12	415	15	480Y/277	10	FAZ-B12/3N	182228	3
13	415	15	480Y/277	10	FAZ-B13/3N	182229	3
15	415	15	480Y/277	10	FAZ-B15/3N	182230	3
16	415	15	480Y/277	10	FAZ-B16/3N	182231	3
20	415	15	480Y/277	10	FAZ-B20/3N	182232	3
25	415	15	480Y/277	10	FAZ-B25/3N	182233	3
32	415	15	480Y/277	10	FAZ-B32/3N	182234	3
40	415	15	480Y/277	5	FAZ-B40/3N	182235	3
50	415	15	480Y/277	5	FAZ-B50/3N	182236	3
63	415	15	480Y/277	5	FAZ-B63/3N	182237	3

SG55812



4-pole

1	415	15	480Y/277	10	FAZ-B1/4	182238	3
1.5	415	15	480Y/277	10	FAZ-B1,5/4	182239	3
1.6	415	15	480Y/277	10	FAZ-B1,6/4	182240	3
2	415	15	480Y/277	10	FAZ-B2/4	182241	3
2.5	415	15	480Y/277	10	FAZ-B2,5/4	182242	3
3	415	15	480Y/277	10	FAZ-B3/4	182243	3
3.5	415	15	480Y/277	10	FAZ-B3,5/4	182244	3
4	415	15	480Y/277	10	FAZ-B4/4	182245	3
5	415	15	480Y/277	10	FAZ-B5/4	182246	3
6	415	15	480Y/277	10	FAZ-B6/4	182247	3
7	415	15	480Y/277	10	FAZ-B7/4	182248	3
8	415	15	480Y/277	10	FAZ-B8/4	182249	3
10	415	15	480Y/277	10	FAZ-B10/4	182250	3
12	415	15	480Y/277	10	FAZ-B12/4	182251	3
13	415	15	480Y/277	10	FAZ-B13/4	182252	3
15	415	15	480Y/277	10	FAZ-B15/4	182253	3
16	415	15	480Y/277	10	FAZ-B16/4	182254	3
20	415	15	480Y/277	10	FAZ-B20/4	182255	3
25	415	15	480Y/277	10	FAZ-B25/4	182256	3
32	415	15	480Y/277	10	FAZ-B32/4	182257	3
40	415	15	480Y/277	5	FAZ-B40/4	182258	3
50	415	15	480Y/277	5	FAZ-B50/4	182259	3
63	415	15	480Y/277	5	FAZ-B63/4	182260	3

FAZ Miniature Circuit Breakers (MCBs)

Characteristic C

Rated current I_n (A)	Rated voltage (V)	Breaking capacity acc. to IEC/EN 60947-2 (kA)	Rated voltage UL1077 (V)	Breaking capacity acc. to UL1077 (kA)	Type Designation	Article No.	Units per package
1-pole							
0.16	240/415	15	277	5	FAZ-C0,16/1	182261	12
0.25	240/415	15	277	5	FAZ-C0,25/1	182262	12
0.5	240/415	15	277	10	FAZ-C0,5/1	182263	12
0.75	240/415	15	277	10	FAZ-C0,75/1	182264	12
1	240/415	15	277	10	FAZ-C1/1	182265	12
1.5	240/415	15	277	10	FAZ-C1,5/1	182266	12
1.6	240/415	15	277	10	FAZ-C1,6/1	182267	12
2	240/415	15	277	10	FAZ-C2/1	182268	12
2.5	240/415	15	277	10	FAZ-C2,5/1	182269	12
3	240/415	15	277	10	FAZ-C3/1	182270	12
3.5	240/415	15	277	10	FAZ-C3,5/1	182271	12
4	240/415	15	277	10	FAZ-C4/1	182272	12
5	240/415	15	277	10	FAZ-C5/1	182273	12
6	240/415	15	277	10	FAZ-C6/1	182274	12
8	240/415	15	277	10	FAZ-C8/1	182275	12
10	240/415	15	277	10	FAZ-C10/1	182276	12
12	240/415	15	277	10	FAZ-C12/1	182277	12
13	240/415	15	277	10	FAZ-C13/1	182278	12
15	240/415	15	277	10	FAZ-C15/1	182279	12
16	240/415	15	277	10	FAZ-C16/1	182280	12
20	240/415	15	277	10	FAZ-C20/1	182281	12
25	240/415	15	277	10	FAZ-C25/1	182282	12
32	240/415	15	277	10	FAZ-C32/1	182283	12
40	240/415	15	277	5	FAZ-C40/1	182284	12
50	240/415	15	277	5	FAZ-C50/1	182285	12
63	240/415	15	277	5	FAZ-C63/1	182286	12

SG53112



SG55612



1+N-pole

0.16	240	15	277	5	FAZ-C0,16/1N	182287	6
0.25	240	15	277	5	FAZ-C0,25/1N	182288	6
0.5	240	15	277	10	FAZ-C0,5/1N	182289	6
0.75	240	15	277	10	FAZ-C0,75/1N	182290	6
1	240	15	277	10	FAZ-C1/1N	182291	6
1.5	240	15	277	10	FAZ-C1,5/1N	182292	6
1.6	240	15	277	10	FAZ-C1,6/1N	182293	6
2	240	15	277	10	FAZ-C2/1N	182294	6
2.5	240	15	277	10	FAZ-C2,5/1N	182295	6
3	240	15	277	10	FAZ-C3/1N	182296	6
3.5	240	15	277	10	FAZ-C3,5/1N	182297	6
4	240	15	277	10	FAZ-C4/1N	182298	6
5	240	15	277	10	FAZ-C5/1N	182299	6
6	240	15	277	10	FAZ-C6/1N	182300	6
8	240	15	277	10	FAZ-C8/1N	182301	6
10	240	15	277	10	FAZ-C10/1N	182302	6
12	240	15	277	10	FAZ-C12/1N	182303	6
13	240	15	277	10	FAZ-C13/1N	182304	6
15	240	15	277	10	FAZ-C15/1N	182305	6
16	240	15	277	10	FAZ-C16/1N	182306	6
20	240	15	277	10	FAZ-C20/1N	182307	6
25	240	15	277	10	FAZ-C25/1N	182308	6
32	240	15	277	10	FAZ-C32/1N	182309	6
40	240	15	277	5	FAZ-C40/1N	182310	6
50	240	15	277	5	FAZ-C50/1N	182311	6
63	240	15	277	5	FAZ-C63/1N	182312	6

SG55112



Rated current I_n (A)	Rated voltage (V)	Breaking capacity acc. to IEC/EN 60947-2 (kA)	Rated voltage UL1077 (V)	Breaking capacity acc. to UL1077 (kA)	Type Designation	Article No.	Units per package
----------------------------	----------------------	---	--------------------------------	--	---------------------	-------------	-------------------------

2-pole

0.16	415	15	480Y/277	5	FAZ-C0,16/2	182313	6
0.25	415	15	480Y/277	5	FAZ-C0,25/2	182314	6
0.5	415	15	480Y/277	10	FAZ-C0,5/2	182315	6
0.75	415	15	480Y/277	10	FAZ-C0,75/2	182316	6
1	415	15	480Y/277	10	FAZ-C1/2	182317	6
1.5	415	15	480Y/277	10	FAZ-C1,5/2	182318	6
1.6	415	15	480Y/277	10	FAZ-C1,6/2	182319	6
2	415	15	480Y/277	10	FAZ-C2/2	182320	6
2.5	415	15	480Y/277	10	FAZ-C2,5/2	182321	6
3	415	15	480Y/277	10	FAZ-C3/2	182322	6
3.5	415	15	480Y/277	10	FAZ-C3,5/2	182323	6
4	415	15	480Y/277	10	FAZ-C4/2	182324	6
5	415	15	480Y/277	10	FAZ-C5/2	182325	6
6	415	15	480Y/277	10	FAZ-C6/2	182326	6
7	415	15	480Y/277	10	FAZ-C7/2	182327	6
8	415	15	480Y/277	10	FAZ-C8/2	182328	6
10	415	15	480Y/277	10	FAZ-C10/2	182329	6
12	415	15	480Y/277	10	FAZ-C12/2	182330	6
13	415	15	480Y/277	10	FAZ-C13/2	182331	6
15	415	15	480Y/277	10	FAZ-C15/2	182332	6
16	415	15	480Y/277	10	FAZ-C16/2	182333	6
20	415	15	480Y/277	10	FAZ-C20/2	182334	6
25	415	15	480Y/277	10	FAZ-C25/2	182335	6
30	415	15	480Y/277	10	FAZ-C30/2	182336	6
32	415	15	480Y/277	10	FAZ-C32/2	182337	6
40	415	15	480Y/277	5	FAZ-C40/2	182338	6
50	415	15	480Y/277	5	FAZ-C50/2	182339	6
63	415	15	480Y/277	5	FAZ-C63/2	182340	6

SG53412



3-pole

0.16	415	15	480Y/277	5	FAZ-C0,16/3	182341	4
0.25	415	15	480Y/277	5	FAZ-C0,25/3	182342	4
0.5	415	15	480Y/277	10	FAZ-C0,5/3	182163	4
0.75	415	15	480Y/277	10	FAZ-C0,75/3	182164	4
1	415	15	480Y/277	10	FAZ-C1/3	182165	4
1.5	415	15	480Y/277	10	FAZ-C1,5/3	182166	4
1.6	415	15	480Y/277	10	FAZ-C1,6/3	182167	4
2	415	15	480Y/277	10	FAZ-C2/3	182168	4
2.5	415	15	480Y/277	10	FAZ-C2,5/3	182169	4
3	415	15	480Y/277	10	FAZ-C3/3	182170	4
3.5	415	15	480Y/277	10	FAZ-C3,5/3	182171	4
4	415	15	480Y/277	10	FAZ-C4/3	182172	4
5	415	15	480Y/277	10	FAZ-C5/3	182173	4
6	415	15	480Y/277	10	FAZ-C6/3	182174	4
7	415	15	480Y/277	10	FAZ-C7/3	181651	4
8	415	15	480Y/277	10	FAZ-C8/3	181652	4
10	415	15	480Y/277	10	FAZ-C10/3	181653	4
12	415	15	480Y/277	10	FAZ-C12/3	181654	4
13	415	15	480Y/277	10	FAZ-C13/3	181655	4
15	415	15	480Y/277	10	FAZ-C15/3	181656	4
16	415	15	480Y/277	10	FAZ-C16/3	181657	4
20	415	15	480Y/277	10	FAZ-C20/3	181658	4
25	415	15	480Y/277	10	FAZ-C25/3	181659	4
30	415	15	480Y/277	10	FAZ-C30/3	181660	4
32	415	15	480Y/277	10	FAZ-C32/3	181661	4
40	415	15	480Y/277	5	FAZ-C40/3	181662	4
50	415	15	480Y/277	5	FAZ-C50/3	181663	4
63	415	15	480Y/277	5	FAZ-C63/3	181664	4

SG55712



Rated current I_n (A)	Rated voltage (V)	Breaking capacity acc. to IEC/EN 60947-2 (kA)	Rated voltage UL1077 (V)	Breaking capacity acc. to UL1077 (kA)	Type Designation	Article No.	Units per package
----------------------------	----------------------	---	--------------------------------	--	---------------------	-------------	-------------------------

3+N-pole

0.16	415	15	480Y/277	5	FAZ-C0,16/3N	181665	3
0.25	415	15	480Y/277	5	FAZ-C0,25/3N	181666	3
0.5	415	15	480Y/277	10	FAZ-C0,5/3N	181667	3
0.75	415	15	480Y/277	10	FAZ-C0,75/3N	181668	3
1	415	15	480Y/277	10	FAZ-C1/3N	181669	3
1.5	415	15	480Y/277	10	FAZ-C1,5/3N	181670	3
1.6	415	15	480Y/277	10	FAZ-C1,6/3N	181671	3
2	415	15	480Y/277	10	FAZ-C2/3N	181672	3
2.5	415	15	480Y/277	10	FAZ-C2,5/3N	181673	3
3	415	15	480Y/277	10	FAZ-C3/3N	181674	3
3.5	415	15	480Y/277	10	FAZ-C3,5/3N	181675	3
4	415	15	480Y/277	10	FAZ-C4/3N	181676	3
5	415	15	480Y/277	10	FAZ-C5/3N	181677	3
6	415	15	480Y/277	10	FAZ-C6/3N	181678	3
8	415	15	480Y/277	10	FAZ-C8/3N	181679	3
10	415	15	480Y/277	10	FAZ-C10/3N	181680	3
12	415	15	480Y/277	10	FAZ-C12/3N	181681	3
13	415	15	480Y/277	10	FAZ-C13/3N	181682	3
15	415	15	480Y/277	10	FAZ-C15/3N	181683	3
16	415	15	480Y/277	10	FAZ-C16/3N	181684	3
20	415	15	480Y/277	10	FAZ-C20/3N	181685	3
25	415	15	480Y/277	10	FAZ-C25/3N	181686	3
32	415	15	480Y/277	10	FAZ-C32/3N	181687	3
40	415	15	480Y/277	5	FAZ-C40/3N	181688	3
50	415	15	480Y/277	5	FAZ-C50/3N	181689	3
63	415	15	480Y/277	5	FAZ-C63/3N	181690	3

SG55812



4-pole

0.16	415	15	480Y/277	5	FAZ-C0,16/4	181691	3
0.25	415	15	480Y/277	5	FAZ-C0,25/4	181692	3
0.5	415	15	480Y/277	10	FAZ-C0,5/4	181693	3
0.75	415	15	480Y/277	10	FAZ-C0,75/4	181694	3
1	415	15	480Y/277	10	FAZ-C1/4	181695	3
1.5	415	15	480Y/277	10	FAZ-C1,5/4	181696	3
1.6	415	15	480Y/277	10	FAZ-C1,6/4	181697	3
2	415	15	480Y/277	10	FAZ-C2/4	181698	3
2.5	415	15	480Y/277	10	FAZ-C2,5/4	181699	3
3	415	15	480Y/277	10	FAZ-C3/4	181700	3
3.5	415	15	480Y/277	10	FAZ-C3,5/4	181701	3
4	415	15	480Y/277	10	FAZ-C4/4	181702	3
5	415	15	480Y/277	10	FAZ-C5/4	181703	3
6	415	15	480Y/277	10	FAZ-C6/4	181704	3
7	415	15	480Y/277	10	FAZ-C7/4	181705	3
8	415	15	480Y/277	10	FAZ-C8/4	181706	3
10	415	15	480Y/277	10	FAZ-C10/4	181707	3
12	415	15	480Y/277	10	FAZ-C12/4	181708	3
13	415	15	480Y/277	10	FAZ-C13/4	181709	3
15	415	15	480Y/277	10	FAZ-C15/4	181710	3
16	415	15	480Y/277	10	FAZ-C16/4	181711	3
20	415	15	480Y/277	10	FAZ-C20/4	181712	3
25	415	15	480Y/277	10	FAZ-C25/4	181713	3
32	415	15	480Y/277	10	FAZ-C32/4	181714	3
40	415	15	480Y/277	5	FAZ-C40/4	181715	3
50	415	15	480Y/277	5	FAZ-C50/4	181716	3
63	415	15	480Y/277	5	FAZ-C63/4	181717	3

FAZ Miniature Circuit Breakers (MCBs)

Characteristic D

SG53112



Rated current I_n (A)	Rated voltage (V)	Breaking capacity acc. to IEC/EN 60947-2 (kA)	Rated voltage UL1077 (V)	Breaking capacity acc. to UL1077 (kA)	Type Designation	Article No.	Units per package
----------------------------	----------------------	---	--------------------------------	--	---------------------	-------------	-------------------------

1-pole

0.5	240/415	15	277	5	FAZ-D0,5/1	181718	12
1	240/415	15	277	5	FAZ-D1/1	181719	12
1.5	240/415	15	277	5	FAZ-D1,5/1	181720	12
1.6	240/415	15	277	5	FAZ-D1,6/1	181721	12
2	240/415	15	277	5	FAZ-D2/1	181722	12
2.5	240/415	15	277	5	FAZ-D2,5/1	181723	12
3	240/415	15	277	5	FAZ-D3/1	181724	12
3.5	240/415	15	277	5	FAZ-D3,5/1	181725	12
4	240/415	15	277	5	FAZ-D4/1	181726	12
5	240/415	15	277	5	FAZ-D5/1	181727	12
6	240/415	15	277	5	FAZ-D6/1	181728	12
8	240/415	15	277	5	FAZ-D8/1	181729	12
10	240/415	15	277	5	FAZ-D10/1	181730	12
12	240/415	15	277	5	FAZ-D12/1	181731	12
13	240/415	15	277	5	FAZ-D13/1	181732	12
15	240/415	15	277	5	FAZ-D15/1	181733	12
16	240/415	15	277	5	FAZ-D16/1	181734	12
20	240/415	15	277	5	FAZ-D20/1	181735	12
25	240/415	15	277	5	FAZ-D25/1	181736	12
32	240/415	15	277	5	FAZ-D32/1	181737	12
40	240/415	15	277	5	FAZ-D40/1	181738	12
50	240/415	10	-	-	FAZ-D50/1	181739	12
63	240/415	10	-	-	FAZ-D63/1	181740	12

SG55612



1+N-pole

0.5	240	15	277	5	FAZ-D0,5/1N	181741	6
1	240	15	277	5	FAZ-D1/1N	181742	6
1.5	240	15	277	5	FAZ-D1,5/1N	181743	6
1.6	240	15	277	5	FAZ-D1,6/1N	181744	6
2	240	15	277	5	FAZ-D2/1N	181745	6
2.5	240	15	277	5	FAZ-D2,5/1N	181746	6
3	240	15	277	5	FAZ-D3/1N	181747	6
3.5	240	15	277	5	FAZ-D3,5/1N	181748	6
4	240	15	277	5	FAZ-D4/1N	181749	6
5	240	15	277	5	FAZ-D5/1N	181750	6
6	240	15	277	5	FAZ-D6/1N	181751	6
8	240	15	277	5	FAZ-D8/1N	181752	6
10	240	15	277	5	FAZ-D10/1N	181753	6
12	240	15	277	5	FAZ-D12/1N	181754	6
13	240	15	277	5	FAZ-D13/1N	181755	6
15	240	15	277	5	FAZ-D15/1N	181756	6
16	240	15	277	5	FAZ-D16/1N	181757	6
20	240	15	277	5	FAZ-D20/1N	181758	6
25	240	15	277	5	FAZ-D25/1N	181759	6
32	240	15	277	5	FAZ-D32/1N	181760	6
40	240	15	277	5	FAZ-D40/1N	181761	6
50	240	10	-	-	FAZ-D50/1N	181762	6
63	240	10	-	-	FAZ-D63/1N	181763	6

SG55112



Rated current I_n (A)	Rated voltage (V)	Breaking capacity acc. to IEC/EN 60947-2 (kA)	Rated voltage UL1077 (V)	Breaking capacity acc. to UL1077 (kA)	Type Designation	Article No.	Units per package
----------------------------	----------------------	---	--------------------------------	--	---------------------	-------------	-------------------------

2-pole

0.5	415	15	480Y/277	5	FAZ-D0,5/2	181764	6
1	415	15	480Y/277	5	FAZ-D1/2	181765	6
1.5	415	15	480Y/277	5	FAZ-D1,5/2	181766	6
1.6	415	15	480Y/277	5	FAZ-D1,6/2	181767	6
2	415	15	480Y/277	5	FAZ-D2/2	181768	6
2.5	415	15	480Y/277	5	FAZ-D2,5/2	181769	6
3	415	15	480Y/277	5	FAZ-D3/2	181770	6
3.5	415	15	480Y/277	5	FAZ-D3,5/2	181771	6
4	415	15	480Y/277	5	FAZ-D4/2	181772	6
5	415	15	480Y/277	5	FAZ-D5/2	181773	6
6	415	15	480Y/277	5	FAZ-D6/2	181774	6
7	415	15	480Y/277	5	FAZ-D7/2	181775	6
8	415	15	480Y/277	5	FAZ-D8/2	181776	6
10	415	15	480Y/277	5	FAZ-D10/2	181777	6
12	415	15	480Y/277	5	FAZ-D12/2	181778	6
13	415	15	480Y/277	5	FAZ-D13/2	181779	6
15	415	15	480Y/277	5	FAZ-D15/2	181780	6
16	415	15	480Y/277	5	FAZ-D16/2	181781	6
20	415	15	480Y/277	5	FAZ-D20/2	181782	6
25	415	15	480Y/277	5	FAZ-D25/2	181783	6
32	415	15	480Y/277	5	FAZ-D32/2	181785	6
40	415	15	480Y/277	5	FAZ-D40/2	181786	6
50	415	10	-	-	FAZ-D50/2	181787	6
63	415	10	-	-	FAZ-D63/2	181788	6

SG53412



3-pole

0.5	415	15	480Y/277	5	FAZ-D0,5/3	181789	4
1	415	15	480Y/277	5	FAZ-D1/3	181790	4
1.5	415	15	480Y/277	5	FAZ-D1,5/3	181791	4
1.6	415	15	480Y/277	5	FAZ-D1,6/3	181792	4
2	415	15	480Y/277	5	FAZ-D2/3	181793	4
2.5	415	15	480Y/277	5	FAZ-D2,5/3	181794	4
3	415	15	480Y/277	5	FAZ-D3/3	181795	4
3.5	415	15	480Y/277	5	FAZ-D3,5/3	181796	4
4	415	15	480Y/277	5	FAZ-D4/3	181797	4
5	415	15	480Y/277	5	FAZ-D5/3	181798	4
6	415	15	480Y/277	5	FAZ-D6/3	181799	4
7	415	15	480Y/277	5	FAZ-D7/3	181800	4
8	415	15	480Y/277	5	FAZ-D8/3	181801	4
10	415	15	480Y/277	5	FAZ-D10/3	181802	4
12	415	15	480Y/277	5	FAZ-D12/3	181803	4
13	415	15	480Y/277	5	FAZ-D13/3	181804	4
15	415	15	480Y/277	5	FAZ-D15/3	181805	4
16	415	15	480Y/277	5	FAZ-D16/3	181806	4
20	415	15	480Y/277	5	FAZ-D20/3	181807	4
25	415	15	480Y/277	5	FAZ-D25/3	181808	4
30	415	15	480Y/277	5	FAZ-D30/3	181809	4
32	415	15	480Y/277	5	FAZ-D32/3	181810	4
40	415	10	480Y/277	5	FAZ-D40/3	181811	4
50	415	10	-	-	FAZ-D50/3	181812	4
63	415	10	-	-	FAZ-D63/3	181813	4

SG55712



3+N-pole

Rated current I_n (A)	Rated voltage (V)	Breaking capacity acc. to IEC/EN 60947-2 (kA)	Rated voltage UL1077 (V)	Breaking capacity acc. to UL1077 (kA)	Type Designation	Article No.	Units per package
0.5	415	15	480Y/277	5	FAZ-D0,5/3N	181814	3
1	415	15	480Y/277	5	FAZ-D1/3N	181815	3
1.5	415	15	480Y/277	5	FAZ-D1,5/3N	181816	3
1.6	415	15	480Y/277	5	FAZ-D1,6/3N	181817	3
2	415	15	480Y/277	5	FAZ-D2/3N	181818	3
2.5	415	15	480Y/277	5	FAZ-D2,5/3N	181819	3
3	415	15	480Y/277	5	FAZ-D3/3N	181820	3
3.5	415	15	480Y/277	5	FAZ-D3,5/3N	181821	3
4	415	15	480Y/277	5	FAZ-D4/3N	181822	3
5	415	15	480Y/277	5	FAZ-D5/3N	181823	3
6	415	15	480Y/277	5	FAZ-D6/3N	181824	3
8	415	15	480Y/277	5	FAZ-D8/3N	181825	3
10	415	15	480Y/277	5	FAZ-D10/3N	181826	3
12	415	15	480Y/277	5	FAZ-D12/3N	181827	3
13	415	15	480Y/277	5	FAZ-D13/3N	181828	3
15	415	15	480Y/277	5	FAZ-D15/3N	181829	3
16	415	15	480Y/277	5	FAZ-D16/3N	181830	3
20	415	15	480Y/277	5	FAZ-D20/3N	181639	3
25	415	15	480Y/277	5	FAZ-D25/3N	181640	3
32	415	15	480Y/277	5	FAZ-D32/3N	181641	3
40	415	15	480Y/277	5	FAZ-D40/3N	181642	3
50	415	10	-	-	FAZ-D50/3N	181643	3
63	415	10	-	-	FAZ-D63/3N	181644	3

SG55812



4-pole

Rated current I_n (A)	Rated voltage (V)	Breaking capacity acc. to IEC/EN 60947-2 (kA)	Rated voltage UL1077 (V)	Breaking capacity acc. to UL1077 (kA)	Type Designation	Article No.	Units per package
0.5	415	15	480Y/277	5	FAZ-D0,5/4	181645	3
1	415	15	480Y/277	5	FAZ-D1/4	181646	3
1.5	415	15	480Y/277	5	FAZ-D1,5/4	181647	3
1.6	415	15	480Y/277	5	FAZ-D1,6/4	181648	3
2	415	15	480Y/277	5	FAZ-D2/4	181649	3
2.5	415	15	480Y/277	5	FAZ-D2,5/4	181650	3
3	415	15	480Y/277	5	FAZ-D3/4	181843	3
3.5	415	15	480Y/277	5	FAZ-D3,5/4	181844	3
4	415	15	480Y/277	5	FAZ-D4/4	181845	3
5	415	15	480Y/277	5	FAZ-D5/4	181846	3
6	415	15	480Y/277	5	FAZ-D6/4	181847	3
7	415	15	480Y/277	5	FAZ-D7/4	181848	3
8	415	15	480Y/277	5	FAZ-D8/4	181849	3
10	415	15	480Y/277	5	FAZ-D10/4	181850	3
12	415	15	480Y/277	5	FAZ-D12/4	181851	3
13	415	15	480Y/277	5	FAZ-D13/4	181852	3
15	415	15	480Y/277	5	FAZ-D15/4	181853	3
16	415	15	480Y/277	5	FAZ-D16/4	181854	3
20	415	15	480Y/277	5	FAZ-D20/4	181855	3
25	415	15	480Y/277	5	FAZ-D25/4	181856	3
32	415	15	480Y/277	5	FAZ-D32/4	181857	3
40	415	10	480Y/277	5	FAZ-D40/4	181858	3
50	415	10	-	-	FAZ-D50/4	181859	3
63	415	10	-	-	FAZ-D63/4	181860	3

FAZ Miniature Circuit Breakers (MCBs)

Characteristic K

	Rated current I_n (A)	Rated voltage (V)	Breaking capacity acc. to IEC/EN 60947-2 (kA)	Rated voltage UL1077 (V)	Breaking capacity acc. to UL1077 (kA)	Type Designation	Article No.	Units per package
1-pole								
0.5	240/415	15	277	5		FAZ-K0,5/1	278589	12/120
1	240/415	15	277	5		FAZ-K1/1	278590	12/120
1.6	240/415	15	277	5		FAZ-K1,6/1	278591	12/120
2	240/415	15	277	5		FAZ-K2/1	278592	12/120
3	240/415	15	277	5		FAZ-K3/1	278593	12/120
4	240/415	15	277	5		FAZ-K4/1	278594	12/120
6	240/415	15	277	5		FAZ-K6/1	278595	12/120
8	240/415	15	277	5		FAZ-K8/1	278596	12/120
10	240/415	15	277	5		FAZ-K10/1	278597	12/120
13	240/415	15	277	5		FAZ-K13/1	278598	12/120
16	240/415	15	277	5		FAZ-K16/1	278599	12/120
20	240/415	15	277	5		FAZ-K20/1	278600	12/120
25	240/415	15	277	5		FAZ-K25/1	278601	12/120
32	240/415	15	277	5		FAZ-K32/1	278602	12/120
40	240/415	15	277	5		FAZ-K40/1	278603	12/120
50	240/415	15	277	5		FAZ-K50/1	278604	12/120
63	240/415	15	277	5		FAZ-K63/1	278605	12/120

SG53112



SG55612



1+N-pole								
0.5	240	15	277	5		FAZ-K0,5/1N	278702	1/60
1	240	15	277	5		FAZ-K1/1N	278703	1/60
1.6	240	15	277	5		FAZ-K1,6/1N	278704	1/60
2	240	15	277	5		FAZ-K2/1N	278705	1/60
3	240	15	277	5		FAZ-K3/1N	278706	1/60
4	240	15	277	5		FAZ-K4/1N	278707	1/60
6	240	15	277	5		FAZ-K6/1N	278708	1/60
8	240	15	277	5		FAZ-K8/1N	278709	1/60
10	240	15	277	5		FAZ-K10/1N	278710	1/60
13	240	15	277	5		FAZ-K13/1N	278711	1/60
16	240	15	277	5		FAZ-K16/1N	278712	1/60
20	240	15	277	5		FAZ-K20/1N	278713	1/60
25	240	15	277	5		FAZ-K25/1N	278714	1/60
32	240	15	277	5		FAZ-K32/1N	278715	1/60
40	240	15	277	5		FAZ-K40/1N	278716	1/60
50	240	15	277	5		FAZ-K50/1N	278717	1/60
63	240	15	277	5		FAZ-K63/1N	278718	1/60

SG55112



Rated current I_n (A)	Rated voltage (V)	Breaking capacity acc. to IEC/EN 60947-2 (kA)	Rated voltage UL1077 (V)	Breaking capacity acc. to UL1077 (kA)	Type Designation	Article No.	Units per package
----------------------------	----------------------	---	--------------------------------	--	---------------------	-------------	-------------------------

2-pole

0.5	415	15	480Y/277	5	FAZ-K0,5/2	278788	1/60
1	415	15	480Y/277	5	FAZ-K1/2	278789	1/60
1.6	415	15	480Y/277	5	FAZ-K1,6/2	278790	1/60
2	415	15	480Y/277	5	FAZ-K2/2	278791	1/60
3	415	15	480Y/277	5	FAZ-K3/2	278792	1/60
4	415	15	480Y/277	5	FAZ-K4/2	278793	1/60
6	415	15	480Y/277	5	FAZ-K6/2	278794	1/60
8	415	15	480Y/277	5	FAZ-K8/2	278795	1/60
10	415	15	480Y/277	5	FAZ-K10/2	278796	1/60
13	415	15	480Y/277	5	FAZ-K13/2	278797	1/60
16	415	15	480Y/277	5	FAZ-K16/2	278798	1/60
20	415	15	480Y/277	5	FAZ-K20/2	278799	1/60
25	415	15	480Y/277	5	FAZ-K25/2	278800	1/60
32	415	15	480Y/277	5	FAZ-K32/2	278801	1/60
40	415	15	480Y/277	5	FAZ-K40/2	278802	1/60
50	415	15	480Y/277	5	FAZ-K50/2	278803	1/60
63	415	15	480Y/277	5	FAZ-K63/2	278804	1/60

SG53412



3-pole

0.5	415	15	480Y/277	5	FAZ-K0,5/3	278901	1/40
1	415	15	480Y/277	5	FAZ-K1/3	278902	1/40
1.6	415	15	480Y/277	5	FAZ-K1,6/3	278903	1/40
2	415	15	480Y/277	5	FAZ-K2/3	278904	1/40
3	415	15	480Y/277	5	FAZ-K3/3	278905	1/40
4	415	15	480Y/277	5	FAZ-K4/3	278906	1/40
6	415	15	480Y/277	5	FAZ-K6/3	278907	1/40
8	415	15	480Y/277	5	FAZ-K8/3	278908	1/40
10	415	15	480Y/277	5	FAZ-K10/3	278909	1/40
13	415	15	480Y/277	5	FAZ-K13/3	278910	1/40
16	415	15	480Y/277	5	FAZ-K16/3	278911	1/40
20	415	15	480Y/277	5	FAZ-K20/3	278912	1/40
25	415	15	480Y/277	5	FAZ-K25/3	278913	1/40
32	415	15	480Y/277	5	FAZ-K32/3	278914	1/40
40	415	15	480Y/277	5	FAZ-K40/3	278915	1/40
50	415	15	480Y/277	5	FAZ-K50/3	278916	1/40
63	415	15	480Y/277	5	FAZ-K63/3	278917	1/40

SG55712



Rated current I_n (A)	Rated voltage (V)	Breaking capacity acc. to IEC/EN 60947-2 (kA)	Rated voltage UL1077 (V)	Breaking capacity acc. to UL1077 (kA)	Type Designation	Article No.	Units per package
----------------------------	----------------------	---	--------------------------------	--	---------------------	-------------	-------------------------

3+N-pole

0.5	415	15	480Y/277	5	FAZ-K0,5/3N	279003	1/30
1	415	15	480Y/277	5	FAZ-K1/3N	279004	1/30
1.6	415	15	480Y/277	5	FAZ-K1,6/3N	279005	1/30
2	415	15	480Y/277	5	FAZ-K2/3N	279006	1/30
3	415	15	480Y/277	5	FAZ-K3/3N	279007	1/30
4	415	15	480Y/277	5	FAZ-K4/3N	279008	1/30
6	415	15	480Y/277	5	FAZ-K6/3N	279009	1/30
8	415	15	480Y/277	5	FAZ-K8/3N	279010	1/30
10	415	15	480Y/277	5	FAZ-K10/3N	279011	1/30
13	415	15	480Y/277	5	FAZ-K13/3N	279012	1/30
16	415	15	480Y/277	5	FAZ-K16/3N	279013	1/30
20	415	15	480Y/277	5	FAZ-K20/3N	279014	1/30
25	415	15	480Y/277	5	FAZ-K25/3N	279015	1/30
32	415	15	480Y/277	5	FAZ-K32/3N	279016	1/30
40	415	15	480Y/277	5	FAZ-K40/3N	279017	1/30
50	415	15	480Y/277	5	FAZ-K50/3N	279018	1/30
63	415	15	480Y/277	5	FAZ-K63/3N	279019	1/30

SG55812



4-pole

0.5	415	15	480Y/277	5	FAZ-K0,5/4	279089	1/30
1	415	15	480Y/277	5	FAZ-K1/4	279090	1/30
1.6	415	15	480Y/277	5	FAZ-K1,6/4	279091	1/30
2	415	15	480Y/277	5	FAZ-K2/4	279092	1/30
3	415	15	480Y/277	5	FAZ-K3/4	279093	1/30
4	415	15	480Y/277	5	FAZ-K4/4	279094	1/30
6	415	15	480Y/277	5	FAZ-K6/4	279095	1/30
8	415	15	480Y/277	5	FAZ-K8/4	279096	1/30
10	415	15	480Y/277	5	FAZ-K10/4	279097	1/30
13	415	15	480Y/277	5	FAZ-K13/4	279098	1/30
16	415	15	480Y/277	5	FAZ-K16/4	279099	1/30
20	415	15	480Y/277	5	FAZ-K20/4	279100	1/30
25	415	15	480Y/277	5	FAZ-K25/4	279101	1/30
32	415	15	480Y/277	5	FAZ-K32/4	279102	1/30
40	415	15	480Y/277	5	FAZ-K40/4	279103	1/30
50	415	15	480Y/277	5	FAZ-K50/4	279104	1/30
63	415	15	480Y/277	5	FAZ-K63/4	279105	1/30

FAZ Miniature Circuit Breakers (MCBs)

Characteristic S

	Rated current I_n (A)	Rated voltage (V)	Breaking capacity acc. to IEC/EN 60947-2 (kA)	Rated voltage UL1077 (V)	Breaking capacity acc. to UL1077 (kA)	Type Designation	Article No.	Units per package
1-pole								
	1	240/415	10	277	5	FAZ-S1/1	181861	12
	2	240/415	10	277	5	FAZ-S2/1	181862	12
	3	240/415	10	277	5	FAZ-S3/1	181863	12
	4	240/415	10	277	5	FAZ-S4/1	181864	12
	6	240/415	10	277	5	FAZ-S6/1	181865	12
	10	240/415	10	277	5	FAZ-S10/1	181866	12
	16	240/415	10	277	5	FAZ-S16/1	181867	12
	20	240/415	10	277	5	FAZ-S20/1	181868	12
	25	240/415	10	277	5	FAZ-S25/1	181869	12
	32	240/415	10	277	5	FAZ-S32/1	181870	12
	40	240/415	10	277	5	FAZ-S40/1	181871	12

SG53112



SG55112



2-pole

	1	415	10	480Y/277	5	FAZ-S1/2	181872	6
	2	415	10	480Y/277	5	FAZ-S2/2	181873	6
	3	415	10	480Y/277	5	FAZ-S3/2	181874	6
	4	415	10	480Y/277	5	FAZ-S4/2	181875	6
	6	415	10	480Y/277	5	FAZ-S6/2	181876	6
	10	415	10	480Y/277	5	FAZ-S10/2	181877	6
	16	415	10	480Y/277	5	FAZ-S16/2	181878	6
	20	415	10	480Y/277	5	FAZ-S20/2	181879	6
	25	415	10	480Y/277	5	FAZ-S25/2	181880	6
	32	415	10	480Y/277	5	FAZ-S32/2	181881	6
	40	415	10	480Y/277	5	FAZ-S40/2	181882	6

FAZ Miniature Circuit Breakers (MCBs)

Characteristic Z

Rated current I_n (A)	Rated voltage (V)	Breaking capacity acc. to IEC/EN 60947-2 (kA)	Rated voltage UL1077 (V)	Breaking capacity acc. to UL1077 (kA)	Type Designation	Article No.	Units per package
1-pole							
0,5	240/415	15	277	5	FAZ-Z0,5/1	278617	12/120
1	240/415	15	277	5	FAZ-Z1/1	278618	12/120
1.6	240/415	15	277	5	FAZ-Z1,6/1	278619	12/120
2	240/415	15	277	5	FAZ-Z2/1	278620	12/120
3	240/415	15	277	5	FAZ-Z3/1	278621	12/120
4	240/415	15	277	5	FAZ-Z4/1	278622	12/120
6	240/415	15	277	5	FAZ-Z6/1	278623	12/120
8	240/415	15	277	5	FAZ-Z8/1	278624	12/120
10	240/415	15	277	5	FAZ-Z10/1	278625	12/120
13	240/415	15	277	5	FAZ-Z13/1	106020	12/120
16	240/415	15	277	5	FAZ-Z16/1	278626	12/120
20	240/415	15	277	5	FAZ-Z20/1	278627	12/120
25	240/415	15	277	5	FAZ-Z25/1	278628	12/120
32	240/415	15	277	5	FAZ-Z32/1	278629	12/120
40	240/415	15	277	5	FAZ-Z40/1	278630	12/120
50	240/415	15	277	5	FAZ-Z50/1	278631	12/120
63	240/415	15	277	5	FAZ-Z63/1	278632	12/120

SG53112



SG55112



2-pole							
0,5	415	15	480Y/277	5	FAZ-Z0,5/2	278816	1/60
1	415	15	480Y/277	5	FAZ-Z1/2	278817	1/60
1.6	415	15	480Y/277	5	FAZ-Z1,6/2	278818	1/60
2	415	15	480Y/277	5	FAZ-Z2/2	278819	1/60
3	415	15	480Y/277	5	FAZ-Z3/2	278820	1/60
4	415	15	480Y/277	5	FAZ-Z4/2	278821	1/60
6	415	15	480Y/277	5	FAZ-Z6/2	278822	1/60
8	415	15	480Y/277	5	FAZ-Z8/2	278823	1/60
10	415	15	480Y/277	5	FAZ-Z10/2	278824	1/60
13	415	15	480Y/277	5	FAZ-Z13/2	106021	1/60
16	415	15	480Y/277	5	FAZ-Z16/2	278825	1/60
20	415	15	480Y/277	5	FAZ-Z20/2	278826	1/60
25	415	15	480Y/277	5	FAZ-Z25/2	278827	1/60
32	415	15	480Y/277	5	FAZ-Z32/2	278828	1/60
40	415	15	480Y/277	5	FAZ-Z40/2	278829	1/60
50	415	15	480Y/277	5	FAZ-Z50/2	278830	1/60
63	415	15	480Y/277	5	FAZ-Z63/2	278831	1/60

SG53412



3-pole

Rated current I_n (A)	Rated voltage (V)	Breaking capacity acc. to IEC/EN 60947-2 (kA)	Rated voltage UL1077 (V)	Breaking capacity acc. to UL1077 (kA)	Type Designation	Article No.	Units per package
0.5	415	15	480Y/277	5	FAZ-Z0,5/3	278918	1/40
1	415	15	480Y/277	5	FAZ-Z1/3	278919	1/40
1.6	415	15	480Y/277	5	FAZ-Z1,6/3	278920	1/40
2	415	15	480Y/277	5	FAZ-Z2/3	278921	1/40
3	415	15	480Y/277	5	FAZ-Z3/3	278922	1/40
4	415	15	480Y/277	5	FAZ-Z4/3	278923	1/40
6	415	15	480Y/277	5	FAZ-Z6/3	278924	1/40
8	415	15	480Y/277	5	FAZ-Z8/3	278925	1/40
10	415	15	480Y/277	5	FAZ-Z10/3	278926	1/40
13	415	15	480Y/277	5	FAZ-Z13/3	106022	1/40
16	415	15	480Y/277	5	FAZ-Z16/3	278927	1/40
20	415	15	480Y/277	5	FAZ-Z20/3	278928	1/40
25	415	15	480Y/277	5	FAZ-Z25/3	278929	1/40
32	415	15	480Y/277	5	FAZ-Z32/3	278930	1/40
40	415	15	480Y/277	5	FAZ-Z40/3	278931	1/40
50	415	15	480Y/277	5	FAZ-Z50/3	278932	1/40
63	415	15	480Y/277	5	FAZ-Z63/3	278933	1/40

SG55812



4-pole

Rated current I_n (A)	Rated voltage (V)	Breaking capacity acc. to IEC/EN 60947-2 (kA)	Rated voltage UL1077 (V)	Breaking capacity acc. to UL1077 (kA)	Type Designation	Article No.	Units per package
0.5	415	15	480Y/277	5	FAZ-Z0,5/4	279106	1/60
1	415	15	480Y/277	5	FAZ-Z1/4	279107	1/60
1.6	415	15	480Y/277	5	FAZ-Z1,6/4	279108	1/60
2	415	15	480Y/277	5	FAZ-Z2/4	279109	1/60
3	415	15	480Y/277	5	FAZ-Z3/4	279110	1/60
4	415	15	480Y/277	5	FAZ-Z4/4	279111	1/60
6	415	15	480Y/277	5	FAZ-Z6/4	279112	1/60
8	415	15	480Y/277	5	FAZ-Z8/4	279113	1/60
10	415	15	480Y/277	5	FAZ-Z10/4	279114	1/60
13	415	15	480Y/277	5	FAZ-Z13/4	106023	1/60
16	415	15	480Y/277	5	FAZ-Z16/4	279115	1/60
20	415	15	480Y/277	5	FAZ-Z20/4	279116	1/60
25	415	15	480Y/277	5	FAZ-Z25/4	279117	1/60
32	415	15	480Y/277	5	FAZ-Z32/4	279118	1/60
40	415	15	480Y/277	5	FAZ-Z40/4	279119	1/60
50	415	15	480Y/277	5	FAZ-Z50/4	279120	1/60
63	415	15	480Y/277	5	FAZ-Z63/4	279121	1/60

FAZ-PN Miniature Circuit Breakers (MCBs)

Characteristic B

Rated current I_n (A)	Rated voltage (V)	Breaking capacity acc. to IEC/EN 60898-1 (kA)	Breaking capacity acc. to IEC/EN 60947-2 (kA)	Type Designation	Article No.	Units per package
1+N-pole (1MU)						
6	240	6	10	FAZ-PN-B6/1N	279146	12/120
10	240	6	10	FAZ-PN-B10/1N	279147	12/120
13	240	6	10	FAZ-PN-B13/1N	279148	12/120
16	240	6	10	FAZ-PN-B16/1N	279149	12/120
20	240	6	10	FAZ-PN-B20/1N	279150	12/120
25	240	6	10	FAZ-PN-B25/1N	279151	12/120
32	240	6	10	FAZ-PN-B32/1N	279152	12/120
40	240	6	10	FAZ-PN-B40/1N	279153	12/120

SG54212



FAZ-PN Miniature Circuit Breakers (MCBs)

Characteristic C



Rated current I_n (A)	Rated voltage (V)	Breaking capacity acc. to IEC/EN 60898-1 (kA)	Breaking capacity acc. to IEC/EN 60947-2 (kA)	Type Designation	Article No.	Units per package
1+N-pole (1MU)						
2	240	6	10	FAZ-PN-C2/1N	279154	12/120
4	240	6	10	FAZ-PN-C4/1N	279155	12/120
6	240	6	10	FAZ-PN-C6/1N	279156	12/120
10	240	6	10	FAZ-PN-C10/1N	279157	12/120
13	240	6	10	FAZ-PN-C13/1N	279158	12/120
16	240	6	10	FAZ-PN-C16/1N	279159	12/120
20	240	6	10	FAZ-PN-C20/1N	279160	12/120
25	240	6	10	FAZ-PN-C25/1N	279161	12/120
32	240	6	10	FAZ-PN-C32/1N	279162	12/120
40	240	6	10	FAZ-PN-C40/1N	279163	12/120

SG54212



FAZ-...-HS Miniature Circuit Breakers (MCBs)

Characteristic B

	Rated current I_n (A)	Rated voltage (V)	Breaking capacity acc. to IEC/EN 60898-1 (kA)	Type Designation	Article No.	Units per package
1-pole						
 wa_sg00114	4	240	10	FAZ-B4/1-HS	279274	12/120
2-pole						
 SG55512	4	240	10	FAZ-B4/2-HS	279275	1/60

FAZ Miniature Circuit Breakers

Accessories:

Auxiliary switch for subsequent installation	ZP-IHK	286052
Auxiliary switch for subsequent installation	ZP-WHK	286053
Tripping signal contact for subsequent installation	ZP-NHK	248437
Shunt trip release	ZP-ASA	248438, 248439
Undervoltage release	Z-USA	258288, 248289, 248290
	Z-USD	248292, 248291
Switching interlock	Z-IS/SPE-1TE	274418
Terminal cover		
1-pole	Z7-AK-1TE	750754200
2-pole	Z-CV/SD-2P	221954800
3-pole	Z-CV/SD-3P	221954900
4-pole	Z-CV/SD-4P	221953900

Specifications FAZ

Technical data

	B Curve	C Curve	D Curve
Electrical			
Approvals	UR (UL 1077), CSA (CSA 22.2 No. 235), CE, CB (Not for D50 and D63)		
Standards	IEC/EN 60947-2		
Short-circuit trip response	3–5 I_n	5–10 I_n	10–20 I_n
Supplementary Protectors – UL/CSA			
Current range	1–63A	0.5–63A	0.5–40A
Maximum voltage ratings – UL/CSA			
Single-pole	277 Vac 48 Vdc	277 Vac 48 Vdc	277 Vac 48 Vdc
Two-, three-pole	480Y/277 Vac	480Y/277 Vac	480Y/277 Vac
Two poles in series	96 Vdc	96 Vdc	96 Vdc
Thermal tripping characteristics			
Single-pole	< 1 hour @ 1.35 x I_n @ 40°C	< 1 hour @ 1.35 x I_n @ 40°C	< 1 hour @ 1.35 x I_n @ 40°C
Multi-pole	< 1 hour @ 1.45 x I_n @ 40°C	< 1 hour @ 1.45 x I_n @ 40°C	< 1 hour @ 1.45 x I_n @ 40°C
Short-circuit ratings (at max. voltage)			
Single-pole	10 kA (5 kA for 40–63A device)	10 kA (5 kA for 40–63A device)	5 kA
Two-, three-pole	10 kA (5 kA for 40–63A device)	10 kA (5 kA for 40–63A device)	5 kA
Single-pole	10 kA @ 48 Vdc	10 kA @ 48 Vdc	10 kA @ 48 Vdc
Two poles in series	10 kA @ 96 Vdc	10 kA @ 96 Vdc	10 kA @ 96 Vdc
Miniature Circuit Breaker – IEC			
Current range	1–63A	0.5–63A	0.5–63A
Maximum voltage ratings – IEC 60947-2			
Single-pole	230 Vac 60 Vdc	230 Vac 60 Vdc	230 Vac 60 Vdc
Two-, three-pole	230/400 Vac	230/400 Vac	230/400 Vac
Maximum Voltage Ratings – IEC 60898			
Single-pole	240 Vac	240 Vac	240 Vac
Two-, three-pole	240/415 Vac	240/415 Vac	240/415 Vac
Thermal tripping characteristics			
	> 1 hour @ 1.05 x I_n @ 40°C < 1 hour @ 1.3 x I_n @ 40°C	> 1 hour @ 1.05 x I_n @ 40°C < 1 hour @ 1.3 x I_n @ 40°C	> 1 hour @ 1.05 x I_n @ 40°C < 1 hour @ 1.3 x I_n @ 40°C
Interrupt ratings (at max. voltage)			
IEC 60947-2	15 kA	15 kA	15 kA (type D50 and D63: 10kA)
IEC 60898	10 kA	10 kA	10 kA (type D50 and D63: 6kA)
Operational switching capacity	7.5 kA	7.5 kA	7.5 kA (type D50 and D63: 6kA)
Max. back-up fuse [gL/gG]	125A	125A	125A
Rated impulse withstand – U_{imp}	4000 Vac	4000 Vac	4000 Vac
Rated insulation voltage – U_i	440 Vac	440 Vac	440 Vac
Environmental/General			
Selectivity class	3	3	3
Lifespan (operations)	> 10000 (1 operation = ON/OFF)	> 10000 (1 operation = ON/OFF)	> 10000 (1 operation = ON/OFF)
Shock (IEC 68-2-22)	10g–120 ms	10g–120 ms	10g–120 ms
Operating temperature range	-40 to +75°C	-40 to +75°C	-40 to +75°C
Mechanical			
Standard front dimension			
Device height	80 mm	80 mm	80 mm
Terminal protection	Finger and back-of-hand proof	Finger and back-of-hand proof	Finger and back-of-hand proof
Mounting width per pole	17.5 mm	17.5 mm	17.5 mm
Mounting	IEC/EN 60715 top-hat rail	IEC/EN 60715 top-hat rail	IEC/EN 60715 top-hat rail
Degree of protection	IP20	IP20	IP20
Terminals top and bottom	Twin-purpose terminals	Twin-purpose terminals	Twin-purpose terminals
Supply connection	Line or load side	Line or load side	Line or load side
Terminal capacity [mm ²]	1 x 25 / 2 x 10	1 x 25 / 2 x 10	1 x 25 / 2 x 10
Torque	2.4 Nm	2.4 Nm	2.4 Nm
Thickness of busbar material	0.8–2 mm	0.8–2 mm	0.8–2 mm
Mounting position	As required	As required	As required

Specifications FAZ

Technical Data (continued)

	K Curve	S Curve	Z Curve
Electrical			
Approvals	UR (UL 1077), CE	UR (UL 1077), CSA (CSA 22.2 No. 235) for 1-16 A, CE, CB	UR (UL 1077), CE
Standards	IEC/EN 60947-2		
Short-circuit trip response	8–12 I_n	13–17 I_n	2–3 I_n
Supplementary Protectors—UL/CSA			
Current range	0.5–63A	0.5–40A	1–63A
Maximum voltage ratings—UL/CSA			
Single-pole, single-pole + neutral	277 Vac 48 Vdc	277 Vac 48 Vdc	277 Vac 48 Vdc
Two-, three-, four-pole and three-pole + neutral	480Y/277 Vac	480Y/277 Vac	480Y/277 Vac
Two poles in series	96 Vdc	96 Vdc	96 Vdc
Thermal tripping characteristics			
Single-pole	< 1 hour @ 1.35 x I_n @ 40°C	< 1 hour @ 1.35 x I_n @ 40°C	< 1 hour @ 1.35 x I_n @ 40°C
Multi-pole	< 1 hour @ 1.45 x I_n @ 40°C	< 1 hour @ 1.45 x I_n @ 40°C	< 1 hour @ 1.45 x I_n @ 40°C
Short-circuit ratings (at max. voltage)			
Single-pole	5 kA @ 277 Vac	5 kA @ 277 Vac	5 kA @ 277 Vac
Single-pole + neutral	5 kA @ 277 Vac	5 kA @ 277 Vac	5 kA @ 277 Vac
Two-, three-, four-pole	5 kA @ 480Y/277 Vac	5 kA @ 480Y/277 Vac	5 kA @ 480Y/277 Vac
Miniature Circuit Breaker—IEC			
Current range	0.5–63A	0.5–40A	1–63A
Maximum voltage ratings—IEC 60947-2			
Single-pole, single-pole + neutral	240 Vac	240 Vac	240 Vac
Single-pole	60 Vdc	60 Vdc	60 Vdc
Two-, three-, four-pole, three-pole + neutral	240/415 Vac	240/415 Vac	240/415 Vac
Thermal tripping characteristics			
	> 1 hour @ 1.05 x I_n @ 30°C < 1 hour @ 1.3 x I_n @ 30°C	> 1 hour @ 1.05 x I_n @ 30°C < 1 hour @ 1.3 x I_n @ 30°C	> 1 hour @ 1.05 x I_n @ 30°C < 1 hour @ 1.3 x I_n @ 30°C
Interrupt ratings (at max. voltage)			
IEC 60947-2	15 kA	10 kA	10 kA
Operational switching capacity	7.5 kA	7.5 kA	7.5 kA
Max. back-up fuse [gL/gG]	125A	125A	125A
Rated impulse withstand— U_{imp}	4000 Vac	4000 Vac	4000 Vac
Rated insulation voltage— U_i	440 Vac	440 Vac	440 Vac
Environmental/General			
Selectivity class	3	3	3
Lifespan (operations)	> 10000 (1 operation = ON/OFF)	> 10000 (1 operation = ON/OFF)	> 10000 (1 operation = ON/OFF)
Shock (IEC 68-2-22)	10g–120 ms	10g–120 ms	10g–120 ms
Operating temperature range	-40°C to +75°C	-40°C to +75°C	-40°C to +75°C
Mechanical			
Standard front dimension			
Device height	80 mm	80 mm	80 mm
Terminal protection	Finger and back-of-hand proof	Finger and back-of-hand proof	Finger and back-of-hand proof
Mounting width per pole	17.5 mm	17.5 mm	17.5 mm
Mounting			
Degree of protection	IP20	IP20	IP20
Terminals top and bottom	Twin-purpose terminals	Twin-purpose terminals	Twin-purpose terminals
Supply connection	Line or load side	Line or load side	Line or load side
Terminal capacity [mm ²]	1 x 25 / 2 x 10	1 x 25 / 2 x 10	1 x 25 / 2 x 10
Torque	2.4 Nm	2.4 Nm	2.4 Nm
Thickness of busbar material	0.8–2 mm	0.8–2 mm	0.8–2 mm
Mounting position	As required	As required	As required

Connection diagram

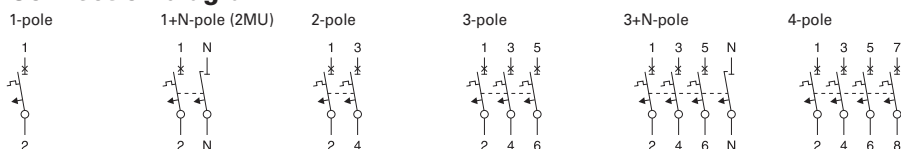

Dimensions (mm) FAZ

1-pole

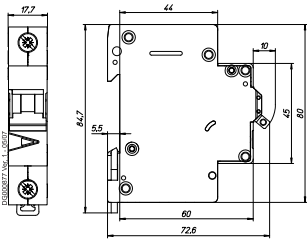

1+N-pole, 2-pole

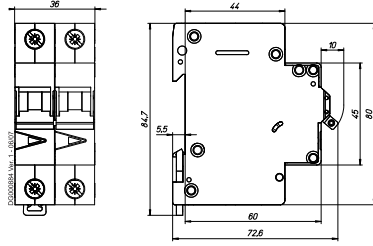

3-pole

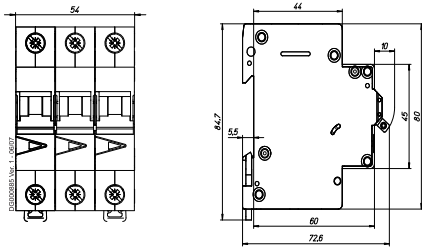

3+N-pole, 4-pole

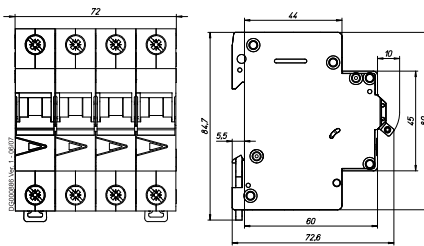

Tripping Characteristic FAZ

Characteristics B, C and D - IEC/EN60898-1

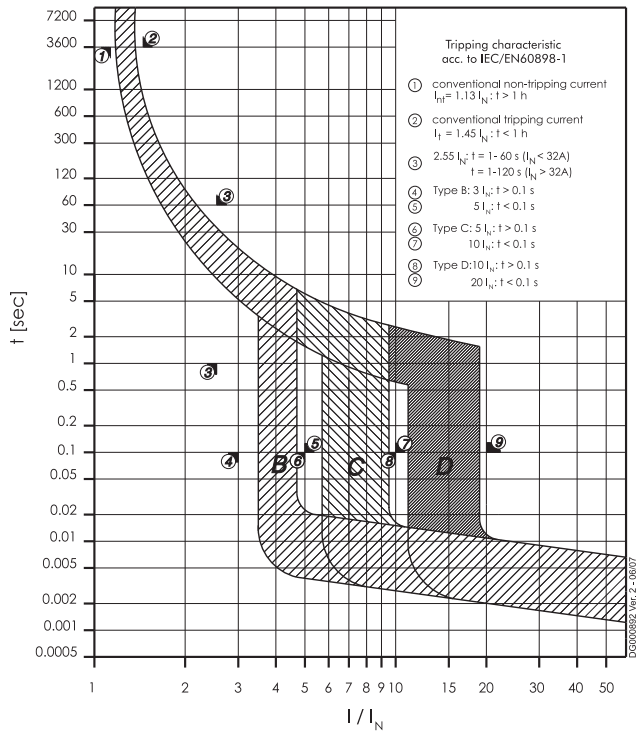

Characteristic K - IEC/EN 60947-2

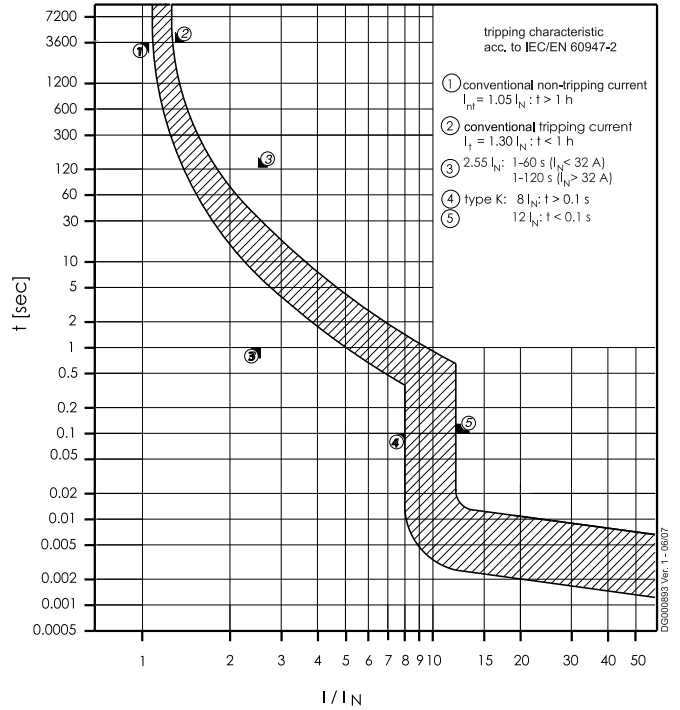

Characteristic S - IEC/EN 60947-2

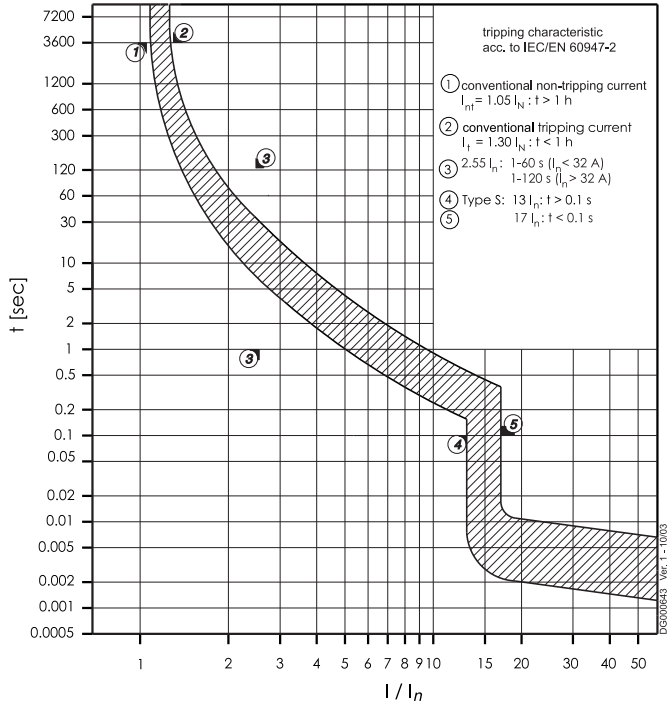

Characteristic S - UL1077

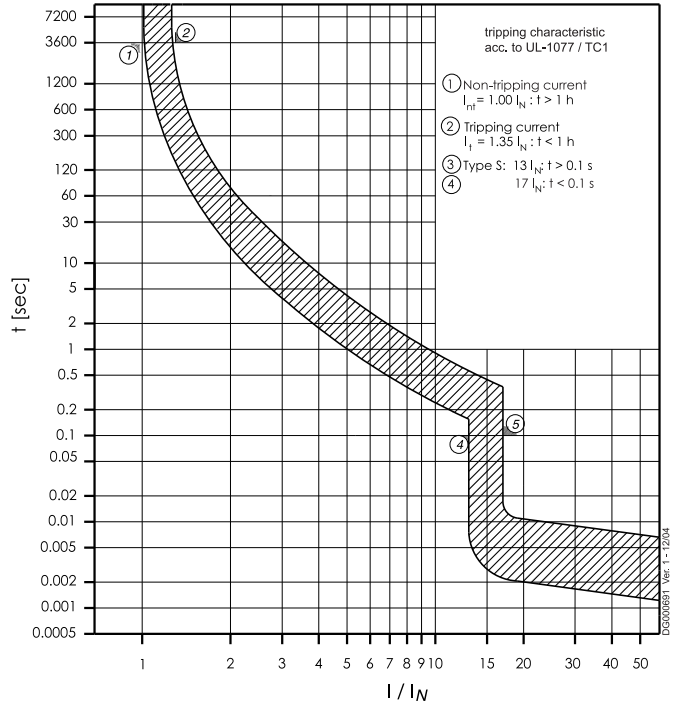

Tripping Characteristic FAZ

Characteristic Z - IEC/EN 60947-2

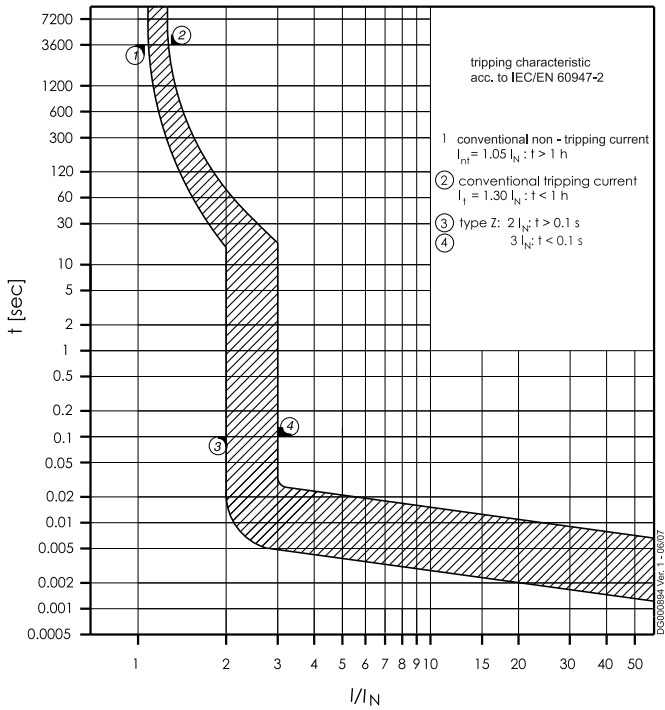

Characteristic Z - UL1077

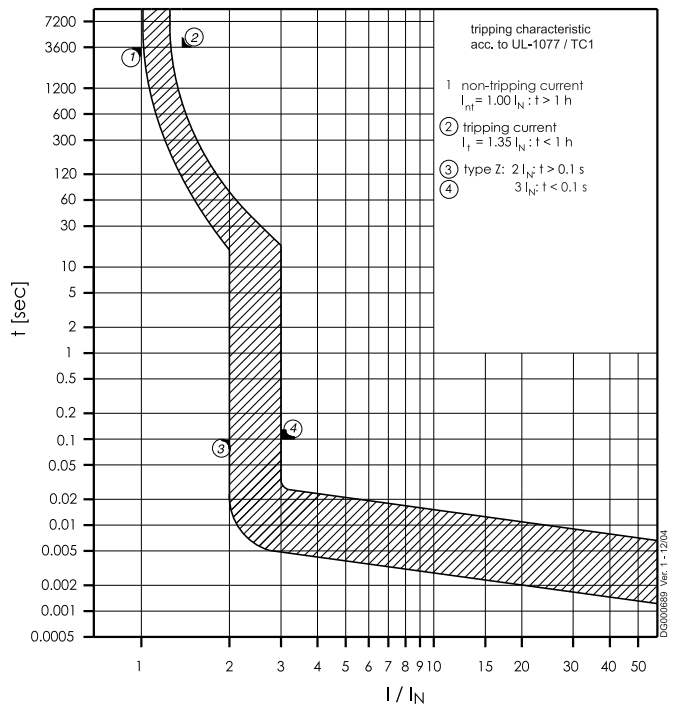

Internal Resistance FAZ

Type B

At room temperature (single pole)

In [A]	Z* [mΩ]	R [mΩ]
1	1120	1102
1.5	922	912
1.6	922	912
2	335	333
2.5	234	230
3	211	208
3.5	184	180
4	87.7	87.2
5	73.5	72.8
6	46.8	46.3
8	30.5	30.4
10	17.5	17.4
12	16.9	16.8
13	13.4	13.3
15	8.0	7.9
16	8.0	7.9
20	7.2	7.1
25	5.0	4.9
32	3.7	3.7
40	2.6	2.5
50	2.1	2.1
63	2.0	2.0

* 50Hz

Type C

At room temperature (single pole)

In [A]	Z* [mΩ]	R [mΩ]
0.16	68500	68300
0.25	27500	27400
0.5	4680	4670
0.75	2280	2250
1	1120	1100
1.5	589	587
1.6	589	587
2	335	333
2.5	234	230
3	131	130
3.5	143	141
4	87.7	87.2
5	73.5	72.8
6	39.3	39.1
8	30.5	30.4
10	14.1	14.0
12	13.5	13.4
13	13.4	13.3
15	8.0	7.9
16	8.0	7.9
20	7.2	7.1
25	5.0	4.9
32	3.7	3.7
40	2.6	2.5
50	2.1	2.1
63	2.0	2.0

* 50Hz

Type D

At room temperature (single pole)

In [A]	Z* [mΩ]	R [mΩ]
0.5	4680	4670
1	772	770
1.5	512	508
1.6	512	508
2	250	249
2.5	153	153
3	131	130
3.5	143	141
4	87.7	87.2
5	65.4	65.1
6	39.3	39.1
8	19.5	19.5
10	14.1	14.0
12	11.3	11.2
13	10.1	10.1
15	8.0	7.9
16	8.0	7.9
20	4.9	4.9
25	3.9	3.8
32	3.5	3.4
40	2.7	2.6

* 50Hz

Fault Loop Impedance FAZ

Max. allowed value for the Fault Loop Impedance Z_s
(acc. to DIN VDE 0100, part 410)

$$U_0 = 230 \text{ V}$$

Tripping time I_n/A	Type B		Type C		Type D	
	0,4s $Z_s (\Omega)$	5s $Z_s (\Omega)$	0,4s $Z_s (\Omega)$	5s $Z_s (\Omega)$	0,4s $Z_s (\Omega)$	5s $Z_s (\Omega)$
1	40,4	40,4	24,3	40,4	12,4	40,4
1.5	26,9	26,9	16,2	26,9	8,3	26,9
2	20,2	20,2	12,2	20,2	6,2	20,2
2.5	16,1	16,1	9,7	16,1	5,0	16,1
3	13,5	13,5	8,1	13,5	4,1	13,5
3.5	11,5	11,5	7,0	11,5	3,6	11,5
4	10,1	10,1	6,1	10,1	3,1	10,1
5	8,1	8,1	4,9	8,1	2,5	8,1
6	6,7	6,7	4,1	6,7	2,1	6,7
8	5,0	5,0	3,0	5,0	1,6	5,0
10	4,0	4,0	2,4	4,0	1,2	4,0
12	3,4	3,4	2,0	3,4	1,0	3,4
13	3,1	3,1	1,9	3,1	1,0	3,1
15	2,7	2,7	1,6	2,7	0,8	2,7
16	2,5	2,5	1,5	2,5	0,8	2,5
20	2,0	2,0	1,2	2,0	0,6	2,0
25	1,6	1,6	1,0	1,6	0,5	1,6
32	1,3	1,3	0,8	1,3	0,4	1,3
40	1,0	1,0	0,6	1,0	0,3	1,0
50	0,8	0,8	0,5	0,8	0,2	0,8
63	0,6	0,6	0,4	0,6	0,2	0,6

$$Z_s = R_{M.C.B.} + R_{Loop}$$

Data/factors taken from the time-current characteristic FAZ

For other rated voltages U_0 :

$$U_0 = 240 \text{ V: } Z_s * 1,04 \text{ applies}$$

$$U_0 = 127 \text{ V: } Z_s * 0,55 \text{ applies}$$

Power Loss at I_n FAZ

Type B

I_n [A]	1p P [W]	1pN P [W]	2p P [W]	3p P [W]	3pN* P [W]
1	1.6	1.7	3.1	4.7	4.8
1.5	2.3	2.5	4.6	6.9	7.2
1.6	2.5	2.7	4.9	7.4	7.6
2	1.4	1.5	2.8	4.1	4.3
2.5	1.5	1.7	3.1	4.6	4.7
3	2.5	2.7	5.0	7.6	7.8
3.5	2.5	2.8	5.1	7.8	8.0
4	1.4	1.6	2.9	4.4	4.5
5	1.9	2.1	3.8	5.8	6.0
6	1.8	2.0	3.6	5.5	5.6
8	2.1	2.3	4.1	6.3	6.5
10	1.9	2.1	3.9	5.9	6.1
12	2.8	3.2	5.9	8.7	9.0
13	2.5	2.9	5.3	7.8	8.1
15	2.1	2.4	4.4	6.5	6.7
16	2.2	2.6	4.7	6.9	7.2
20	3.2	3.6	6.6	9.8	10.1
25	3.0	3.5	6.4	9.4	9.7
32	3.7	4.4	8.1	12.1	12.5
40	3.4	4.1	7.5	11.2	11.5
50	4.5	5.4	9.9	14.9	15.3
63	5.2	6.3	11.5	17.2	17.7

*symmetrical load

Type C

I_n [A]	1p P [W]	1pN P [W]	2p P [W]	3p P [W]	3pN* P [W]
0.16	2.2	2.4	4.4	6.7	6.9
0.25	2.0	2.2	4.0	6.1	6.3
0.5	1.2	1.3	2.4	3.5	3.7
0.75	1.3	1.4	2.6	3.9	4.1
1	1.6	1.7	3.1	4.7	4.8
1.5	1.5	1.6	2.9	4.4	4.6
1.6	1.6	1.7	3.1	4.7	4.9
2	1.4	1.5	2.8	4.1	4.3
2.5	1.5	1.7	3.1	4.6	4.7
3	1.2	1.3	2.4	3.6	3.7
3.5	1.3	1.4	2.6	3.9	4.0
4	1.4	1.6	2.9	4.4	4.5
5	1.9	2.1	3.8	5.8	6.0
6	1.5	1.6	2.9	4.4	4.6
8	2.1	2.3	4.1	6.3	6.5
10	1.5	1.7	3.0	4.6	4.7
12	2.1	2.4	4.4	6.5	6.8
13	2.5	2.9	5.3	7.8	8.1
15	2.1	2.4	4.4	6.5	6.7
16	2.2	2.6	4.7	6.9	7.2
20	3.2	3.6	6.6	9.8	10.1
25	3.0	3.5	6.4	9.4	9.7
32	3.7	4.4	8.1	12.1	12.5
40	3.4	4.1	7.5	11.2	11.5
50	4.5	5.4	9.9	14.9	15.3
63	5.2	6.3	11.5	17.2	17.7

*symmetrical load

Type D

I_n [A]	1p P [W]	1pN P [W]	2p P [W]	3p P [W]	3pN* P [W]
0.5	1.2	1.3	2.4	3.5	3.7
1	0.8	0.9	1.6	2.4	2.5
1.5	1.2	1.3	2.3	3.5	3.6
1.6	1.3	1.4	2.5	3.8	3.9
2	1.0	1.1	2.0	3.0	3.1
2.5	1.0	1.1	1.9	2.9	3.0
3	1.2	1.3	2.4	3.6	3.7
3.5	1.3	1.4	2.6	3.9	4.0
4	1.4	1.6	2.9	4.4	4.5
5	1.7	1.8	3.3	5.1	5.3
6	1.5	1.6	2.9	4.4	4.6
8	1.3	1.5	2.6	4.0	4.2
10	1.5	1.7	3.0	4.6	4.7
12	1.7	2.0	3.6	5.3	5.4
13	1.9	2.2	4.0	5.9	6.1
15	2.1	2.4	4.4	6.5	6.7
16	2.2	2.6	4.7	6.9	7.2
20	2.0	2.2	4.1	6.1	6.2
25	2.5	2.9	5.2	7.7	7.9
32	3.4	4.0	7.4	11.1	11.4
40	3.2	3.8	7.0	10.4	10.7

*symmetrical load

Influence of Ambient Temperature FAZ

On Load Carrying Capacity (temperature derating)

I _N [A]	Ambient temperature T [°C]																
	-40	-30	-20	-10	0	10	20	30	35	40	45	50	55	60	65	70	75
0.16	0.2	0.2	0.19	0.19	0.18	0.17	0.17	0.16	0.16	0.15	0.15	0.15	0.14	0.14	0.14	0.14	0.13
0.25	0.32	0.31	0.3	0.29	0.28	0.27	0.26	0.25	0.25	0.24	0.24	0.23	0.23	0.22	0.22	0.21	0.21
0.5	0.64	0.62	0.6	0.58	0.56	0.54	0.52	0.5	0.49	0.48	0.47	0.46	0.45	0.44	0.43	0.42	0.41
0.75	0.96	0.93	0.9	0.87	0.84	0.81	0.78	0.75	0.74	0.73	0.71	0.69	0.68	0.66	0.65	0.64	0.62
1	1.3	1.2	1.2	1.2	1.1	1.1	1	1	0.99	0.97	0.95	0.93	0.9	0.89	0.87	0.85	0.83
1.5	1.9	1.9	1.8	1.7	1.7	1.6	1.6	1.5	1.5	1.5	1.4	1.4	1.4	1.3	1.3	1.3	1.2
1.6	2	2	1.9	1.9	1.8	1.7	1.7	1.6	1.6	1.5	1.5	1.5	1.4	1.4	1.4	1.4	1.3
2	2.6	2.5	2.4	2.3	2.2	2.2	2.1	2	2	1.9	1.9	1.9	1.8	1.8	1.7	1.7	1.7
2.5	3.2	3.1	3	2.9	2.8	2.7	2.6	2.5	2.5	2.4	2.4	2.3	2.3	2.2	2.2	2.1	2.1
3	3.8	3.7	3.6	3.5	3.4	3.3	3.1	3	3	2.9	2.8	2.8	2.7	2.7	2.6	2.5	2.5
3.5	4.5	4.4	4.2	4.1	3.9	3.8	3.7	3.5	3.4	3.4	3.3	3.2	3.2	3.1	3	3	2.9
4	5.1	5	4.8	4.7	4.5	4.3	4.2	4	3.9	3.9	3.8	3.7	3.6	3.5	3.5	3.4	3.3
5	6.4	6.2	6	5.8	5.6	5.4	5.2	5	4.9	4.8	4.7	4.6	4.5	4.4	4.3	4.2	4.1
6	7.7	7.5	7.2	7	6.7	6.5	6.3	6	5.9	5.8	5.7	5.6	5.4	5.3	5.2	5.1	5
8	10.2	9.9	9.6	9.3	9	8.7	8.4	8	7.9	7.7	7.6	7.4	7.2	7.1	6.9	6.8	6.6
10	13	12	12	12	11	11	10	10	9.9	9.7	9.5	9.3	9	8.9	8.7	8.5	8.3
12	15	15	14	14	13	13	13	12	12	12	11	11	11	11	10	10	10
13	17	16	16	15	15	14	14	13	13	13	12	12	12	12	11	11	11
15	19	19	18	17	17	16	16	15	15	15	14	14	14	13	13	13	12
16	20	20	19	19	18	17	17	16	16	15	15	15	14	14	14	14	13
20	26	25	24	23	22	22	21	20	20	19	19	19	18	18	17	17	17
25	32	31	30	29	28	27	26	25	25	24	24	23	23	22	22	21	21
32	41	40	38	37	36	35	33	32	32	31	30	30	29	28	28	27	26
40	51	50	48	47	45	43	42	40	39	39	38	37	36	35	35	34	33
50	64	62	60	58	56	54	52	50	49	48	47	46	45	44	43	42	41
63	81	78	76	73	71	68	66	63	62	61	60	58	57	56	55	53	52

Maximum Let-Through Energy FAZ

Type B (IEC/EN60947-2)

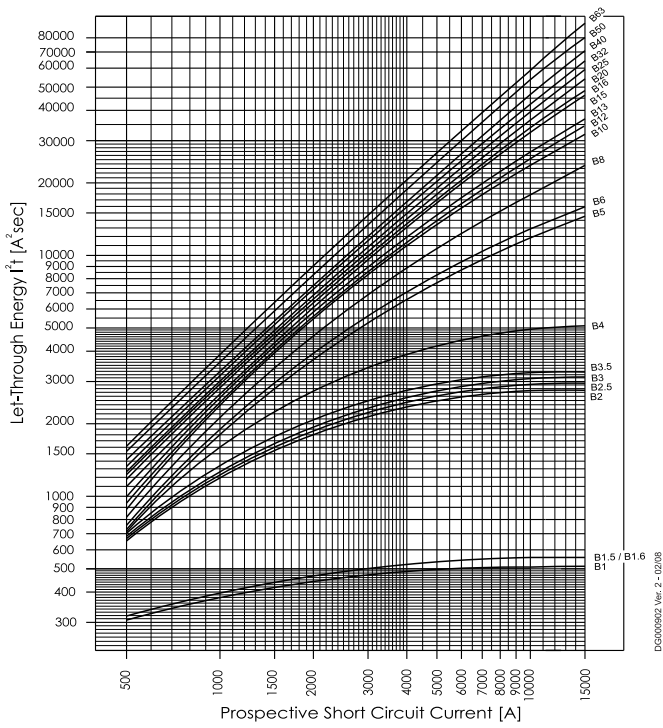

Type C (IEC/EN60947-2)

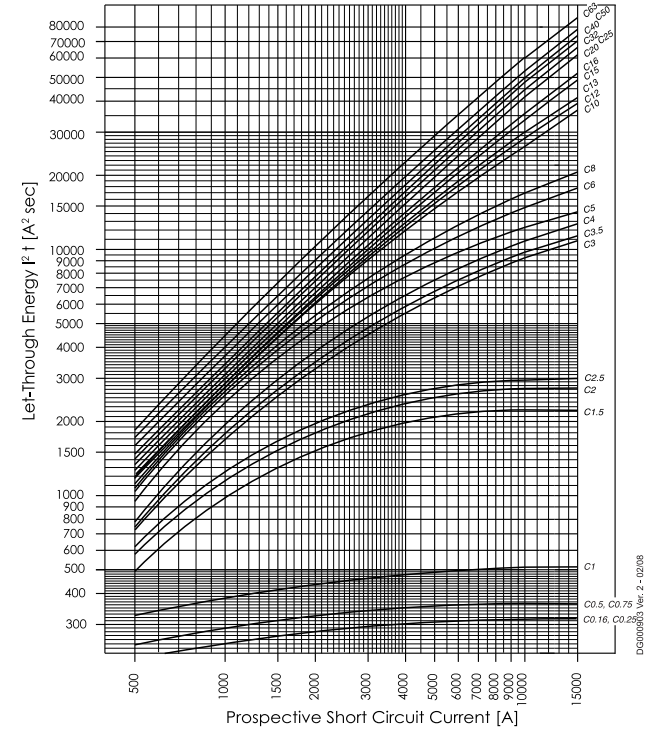

Type D (IEC/EN60947-2)

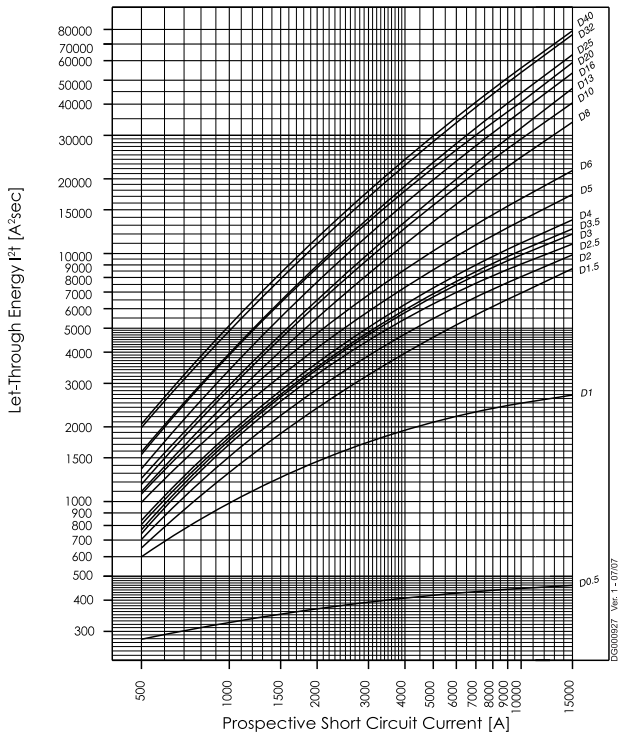

Type K

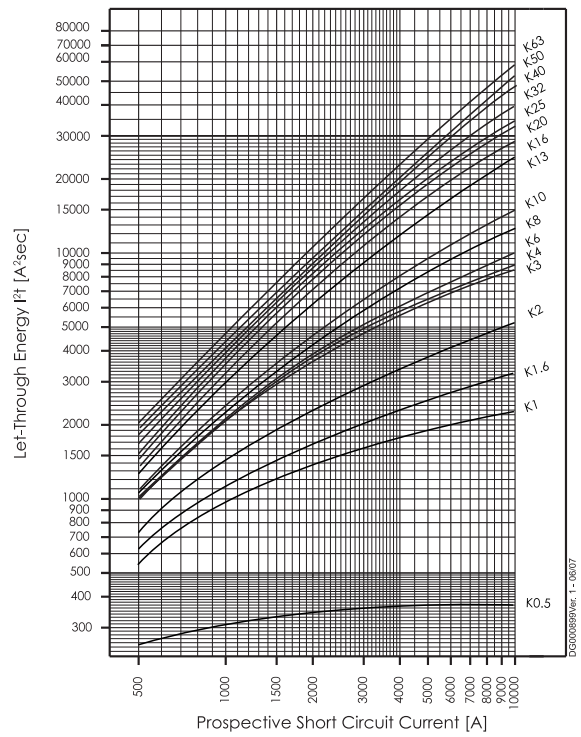

Maximum Let-Through Energy FAZ

Type S

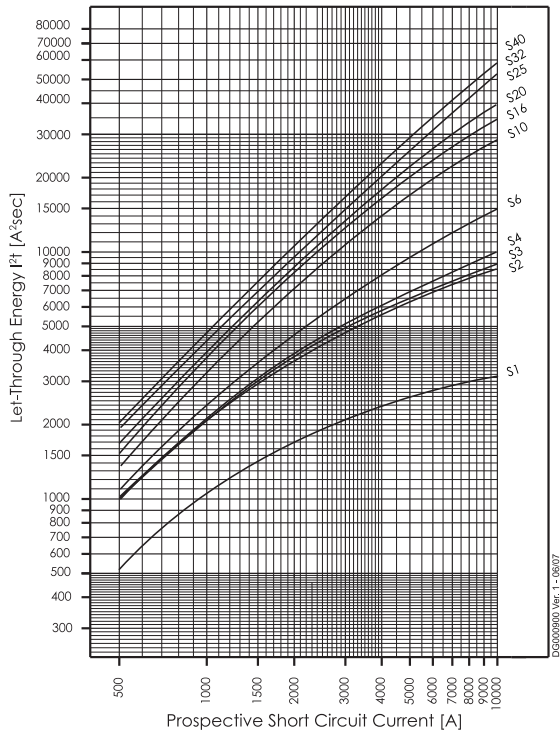

Type Z

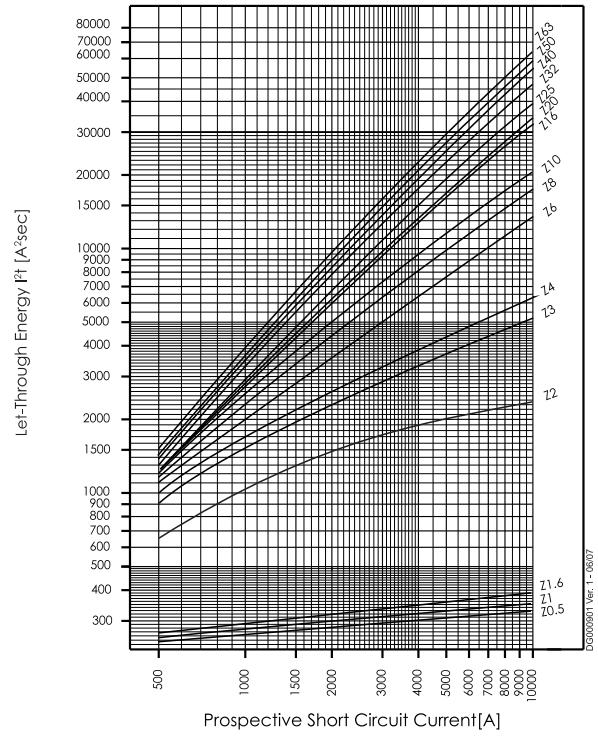

Type FAZ...-HS

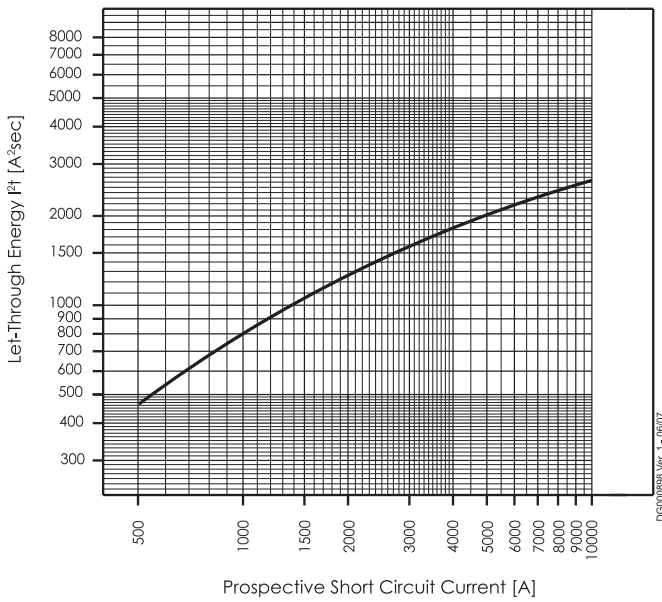

Maximum Let-Through Current FAZ

Type B (IEC/EN60898)

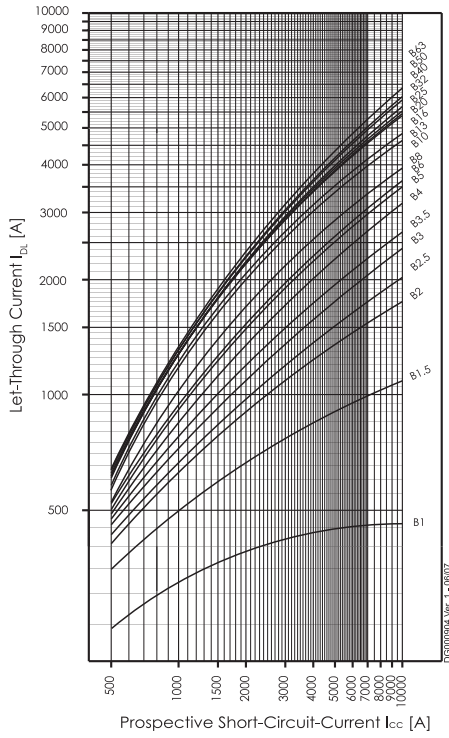

Type C (IEC/EN60898)

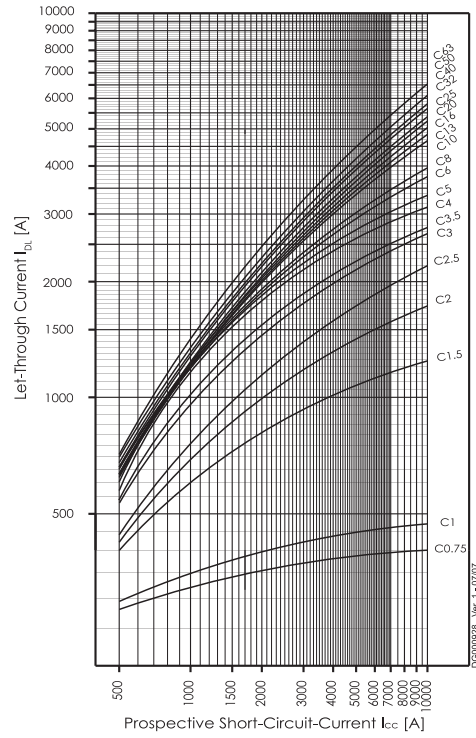

Type D (IEC/EN60898)

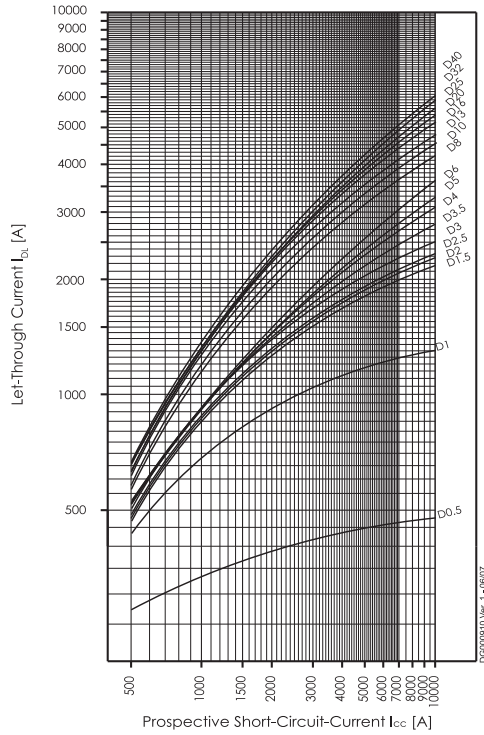

Type K

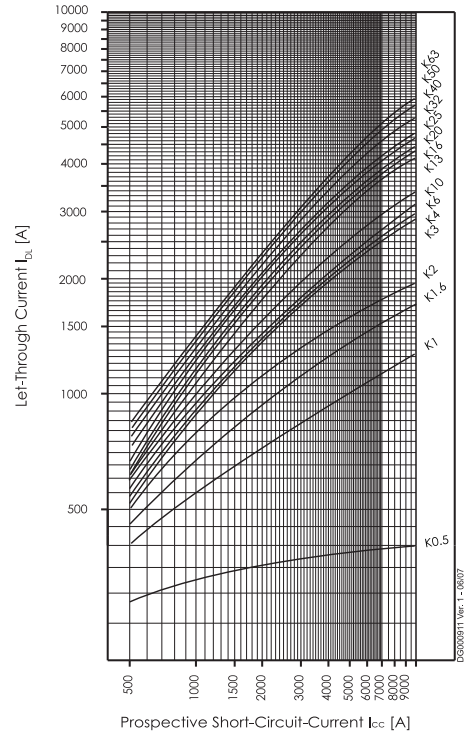

Maximum Let-Through Current FAZ

Type S

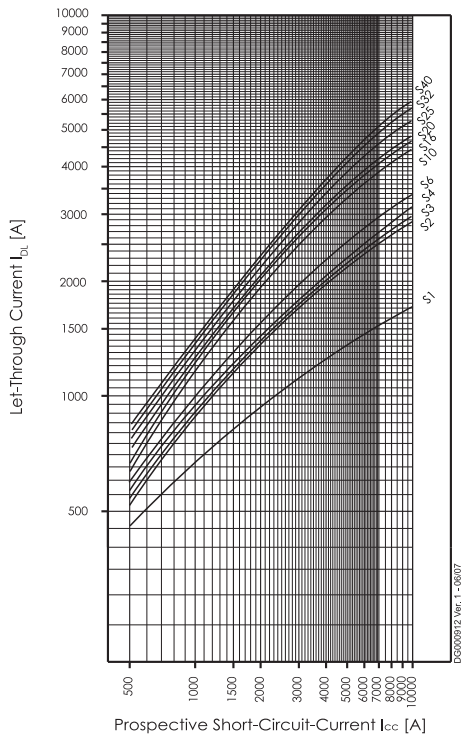

Type B (IEC/EN60947-2)

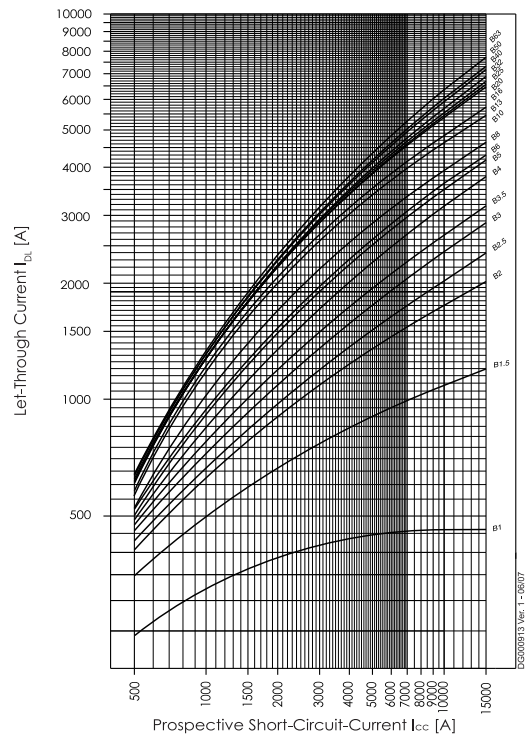

Type C (IEC/EN60947-2)

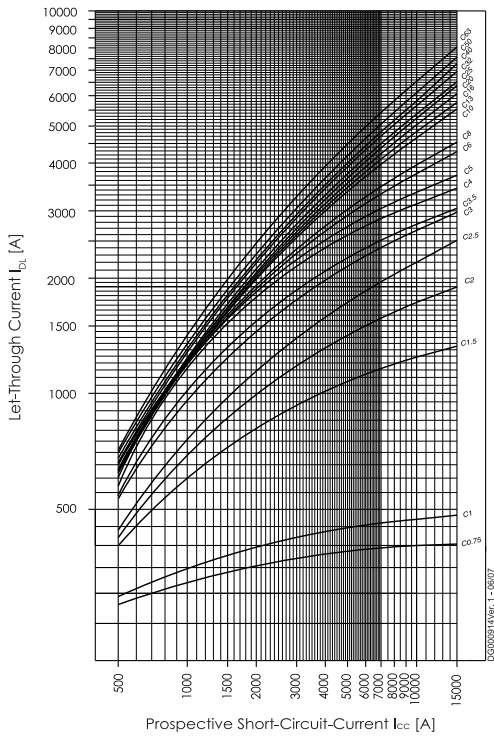

Type D (IEC/EN60947-2)

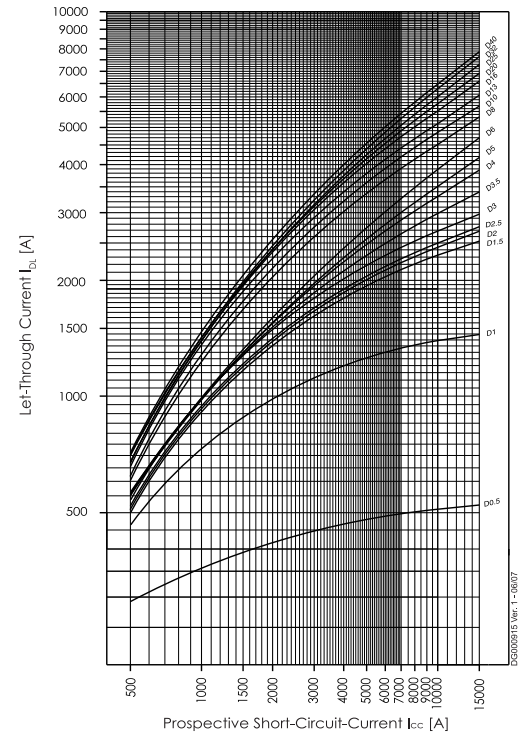

Short Circuit Selectivity FAZ

In case of short circuit, there is selectivity between the miniature circuit breakers FAZ and the upstream protection devices up to the specified values of the selectivity limit current I_s [kA] (i. e. in case of short-circuit currents I_{ks} under I_s , only the MCB will trip, in case of short circuit currents above this value both protective devices will respond).

*) basically in accordance with EN 60898-1 D.5.2.b

FAZ towards NH-00 Fuses

Short circuit selectivity **characteristic B** towards fuse link **NH-00***)

FAZ	NH-00 gL/gG											
I_n [A]	16	20	25	32	35	40	50	63	80	100	125	160
1.0	0.9	10.0 ²⁾	10.0 ²⁾	10.0 ²⁾	10.0 ²⁾	10.0 ²⁾	10.0 ²⁾	10.0 ²⁾	10.0 ²⁾	10.0 ²⁾	10.0 ²⁾	10.0 ²⁾
1.5	0.8	10.0 ²⁾	10.0 ²⁾	10.0 ²⁾	10.0 ²⁾	10.0 ²⁾	10.0 ²⁾	10.0 ²⁾	10.0 ²⁾	10.0 ²⁾	10.0 ²⁾	10.0 ²⁾
2.0	<0.5 ¹⁾	0.5	1.0	2.5	10.0 ²⁾	10.0 ²⁾	10.0 ²⁾	10.0 ²⁾	10.0 ²⁾	10.0 ²⁾	10.0 ²⁾	10.0 ²⁾
2.5	<0.5 ¹⁾	0.5	1.0	2.3	10.0 ²⁾	10.0 ²⁾	10.0 ²⁾	10.0 ²⁾	10.0 ²⁾	10.0 ²⁾	10.0 ²⁾	10.0 ²⁾
3.0	<0.5 ¹⁾	0.5	0.9	2.1	8.0	10.0 ²⁾	10.0 ²⁾	10.0 ²⁾	10.0 ²⁾	10.0 ²⁾	10.0 ²⁾	10.0 ²⁾
3.5	<0.5 ¹⁾	0.5	0.9	1.8	5.5	10.0 ²⁾	10.0 ²⁾	10.0 ²⁾	10.0 ²⁾	10.0 ²⁾	10.0 ²⁾	10.0 ²⁾
4	<0.5 ¹⁾	<0.5 ¹⁾	0.8	1.3	2.3	4.3	10.0 ²⁾	10.0 ²⁾	10.0 ²⁾	10.0 ²⁾	10.0 ²⁾	10.0 ²⁾
5	<0.5 ¹⁾	<0.5 ¹⁾	0.7	1.1	1.6	2.2	3.6	4.8	8.9	10.0 ²⁾	10.0 ²⁾	10.0 ²⁾
6	<0.5 ¹⁾	<0.5 ¹⁾	0.7	1.1	1.5	2.0	3.3	4.3	7.6	10.0 ²⁾	10.0 ²⁾	10.0 ²⁾
8	<0.5 ¹⁾	<0.5 ¹⁾	0.6	1.0	1.3	1.7	2.6	3.3	5.2	10.0 ²⁾	10.0 ²⁾	10.0 ²⁾
10		<0.5 ¹⁾	0.6	0.9	1.2	1.5	2.2	2.7	4.0	9.0	10.0 ²⁾	10.0 ²⁾
13		<0.5 ¹⁾	0.6	0.8	1.1	1.4	2.1	2.6	3.8	7.9	10.0 ²⁾	10.0 ²⁾
16			0.5	0.7	1.0	1.3	1.9	2.4	3.4	6.4	9.3	10.0 ²⁾
20				0.7	1.0	1.3	1.9	2.4	3.3	6.0	8.7	10.0 ²⁾
25				0.7	1.0	1.3	1.8	2.3	3.2	5.7	8.0	10.0 ²⁾
32					0.9	1.2	1.7	2.2	3.1	5.4	7.6	10.0 ²⁾
40								2.1	3.0	5.1	7.2	10.0 ²⁾
50								1.9	2.8	4.7	6.6	9.5
63										4.4	6.3	8.6

Short circuit selectivity **characteristic C** towards fuse link **NH-00***)

FAZ	NH-00 gL/gG											
I_n [A]	16	20	25	32	35	40	50	63	80	100	125	160
0.75	10.0 ²⁾	10.0 ²⁾	10.0 ²⁾	10.0 ²⁾	10.0 ²⁾	10.0 ²⁾	10.0 ²⁾	10.0 ²⁾	10.0 ²⁾	10.0 ²⁾	10.0 ²⁾	10.0 ²⁾
1.0	0.9	10.0 ²⁾	10.0 ²⁾	10.0 ²⁾	10.0 ²⁾	10.0 ²⁾	10.0 ²⁾	10.0 ²⁾	10.0 ²⁾	10.0 ²⁾	10.0 ²⁾	10.0 ²⁾
1.5	<0.5 ¹⁾	0.6	1.3	4.2	10.0 ²⁾	10.0 ²⁾	10.0 ²⁾	10.0 ²⁾	10.0 ²⁾	10.0 ²⁾	10.0 ²⁾	10.0 ²⁾
2.0	<0.5 ¹⁾	0.6	1.0	2.5	10.0 ²⁾	10.0 ²⁾	10.0 ²⁾	10.0 ²⁾	10.0 ²⁾	10.0 ²⁾	10.0 ²⁾	10.0 ²⁾
2.5	<0.5 ¹⁾	0.5	1.0	2.1	10.0 ²⁾	10.0 ²⁾	10.0 ²⁾	10.0 ²⁾	10.0 ²⁾	10.0 ²⁾	10.0 ²⁾	10.0 ²⁾
3.0	<0.5 ¹⁾	<0.5 ¹⁾	0.7	1.2	1.8	2.6	4.7	6.6	10.0 ²⁾	10.0 ²⁾	10.0 ²⁾	10.0 ²⁾
3.5	<0.5 ¹⁾	<0.5 ¹⁾	0.7	1.1	1.7	2.4	4.2	6.0	10.0 ²⁾	10.0 ²⁾	10.0 ²⁾	10.0 ²⁾
4	<0.5 ¹⁾	<0.5 ¹⁾	0.7	1.0	1.5	2.1	3.6	5.0	10.0	10.0 ²⁾	10.0 ²⁾	10.0 ²⁾
5	<0.5 ¹⁾	<0.5 ¹⁾	0.6	0.8	1.2	1.7	2.8	3.8	8.7	10.0 ²⁾	10.0 ²⁾	10.0 ²⁾
6	<0.5 ¹⁾	<0.5 ¹⁾	0.5	0.8	1.2	1.5	2.5	3.3	5.7	10.0 ²⁾	10.0 ²⁾	10.0 ²⁾
8	<0.5 ¹⁾	<0.5 ¹⁾	0.5	0.8	1.1	1.5	2.3	2.9	4.9	10.0 ²⁾	10.0 ²⁾	10.0 ²⁾
10			0.5	0.7	1.0	1.4	2.0	2.5	3.8	8.0	10.0 ²⁾	10.0 ²⁾
13					1.0	1.3	1.9	2.4	3.6	7.0	10.0 ²⁾	10.0 ²⁾
16					1.0	1.3	1.8	2.3	3.3	6.0	8.8	10.0 ²⁾
20					1.0	1.2	1.7	2.2	3.2	5.5	7.7	10.0 ²⁾
25						1.6	2.1	3.0	5.2	7.3	10.0 ²⁾	
32							2.1	2.9	5.0	7.0	10.0 ²⁾	
40								2.8	4.8	6.7	10.0	
50									4.5	6.3	9.5	
63										5.9	8.4	

Short circuit selectivity **characteristic D** towards fuse link **NH-00***)

FAZ	NH-00 gL/gG											
I_n [A]	16	20	25	32	35	40	50	63	80	100	125	160
0.5	2.1	10.0 ²⁾	10.0 ²⁾	10.0 ²⁾	10.0 ²⁾	10.0 ²⁾	10.0 ²⁾	10.0 ²⁾	10.0 ²⁾	10.0 ²⁾	10.0 ²⁾	10.0 ²⁾
1.0	<0.5 ¹⁾	0.6	1.4	4.3	10.0 ²⁾	10.0 ²⁾	10.0 ²⁾	10.0 ²⁾	10.0 ²⁾	10.0 ²⁾	10.0 ²⁾	10.0 ²⁾
1.5	<0.5 ¹⁾	<0.5 ¹⁾	0.9	1.6	2.7	4.0	8.0	10.0 ²⁾	10.0 ²⁾	10.0 ²⁾	10.0 ²⁾	10.0 ²⁾
2.0	<0.5 ¹⁾	<0.5 ¹⁾	0.8	1.3	2.1	3.1	6.0	8.6	10.0 ²⁾	10.0 ²⁾	10.0 ²⁾	10.0 ²⁾
2.5	<0.5 ¹⁾	<0.5 ¹⁾	0.7	1.2	1.8	2.6	4.8	6.9	10.0 ²⁾	10.0 ²⁾	10.0 ²⁾	10.0 ²⁾
3.0	<0.5 ¹⁾	<0.5 ¹⁾	0.7	1.1	1.7	2.4	4.3	6.0	10.0 ²⁾	10.0 ²⁾	10.0 ²⁾	10.0 ²⁾
3.5	<0.5 ¹⁾	<0.5 ¹⁾	0.7	1.1	1.7	2.4	4.2	5.6	10.0 ²⁾	10.0 ²⁾	10.0 ²⁾	10.0 ²⁾
4	<0.5 ¹⁾	<0.5 ¹⁾	0.7	1.0	1.6	2.2	3.8	5.2	10.0	10.0 ²⁾	10.0 ²⁾	10.0 ²⁾
5		<0.5 ¹⁾	0.6	0.9	1.4	1.9	3.2	4.1	7.1	10.0 ²⁾	10.0 ²⁾	10.0 ²⁾
6		<0.5 ¹⁾	0.5	0.8	1.2	1.6	2.6	3.3	5.5	10.0 ²⁾	10.0 ²⁾	10.0 ²⁾
8			0.5	0.8	1.1	1.5	2.2	2.7	4.1	8.7	10.0 ²⁾	10.0 ²⁾
10			0.5	0.7	1.0	1.3	1.9	2.5	3.6	7.2	10.0 ²⁾	10.0 ²⁾
13				1.0	1.3	1.9	2.3	3.4	6.5	9.5	10.0 ²⁾	
16					1.1	1.6	2.0	3.0	5.5	8.0	10.0 ²⁾	
20						1.4	1.8	2.8	5.0	7.5	10.0 ²⁾	
25							1.8	2.7	4.8	7.0	10.0 ²⁾	
32								2.4	4.1	6.2	9.3	
40									4.0	6.0	9.0	

¹⁾ Selectivity limit current I_s under 0.5 kA

²⁾ Selectivity limit current I_s = rated breaking capacity I_{cn} of the MCB

Shaded fields: no selectivity

FAZ towards D01-D03 fuse link

Short circuit selectivity **characteristic B** towards fuse link **D01-D03***)

FAZ	D01-D03 gL/gG									
	I _n [A]	10	16	20	25	35	50	63	80	100
1.0	<0.5 ¹⁾	10.0 ²⁾	10.0 ²⁾	10.0 ²⁾	10.0 ²⁾	10.0 ²⁾	10.0 ²⁾	10.0 ²⁾	10.0 ²⁾	10.0 ²⁾
1.5	<0.5 ¹⁾	4.1	10.0 ²⁾	10.0 ²⁾	10.0 ²⁾	10.0 ²⁾	10.0 ²⁾	10.0 ²⁾	10.0 ²⁾	10.0 ²⁾
2.0	<0.5 ¹⁾	<0.5 ¹⁾	0.6	1.0	10.0 ²⁾	10.0 ²⁾	10.0 ²⁾	10.0 ²⁾	10.0 ²⁾	10.0 ²⁾
2.5	<0.5 ¹⁾	<0.5 ¹⁾	0.6	1.0	10.0 ²⁾	10.0 ²⁾	10.0 ²⁾	10.0 ²⁾	10.0 ²⁾	10.0 ²⁾
3.0	<0.5 ¹⁾	<0.5 ¹⁾	0.5	1.0	10.0 ²⁾	10.0 ²⁾	10.0 ²⁾	10.0 ²⁾	10.0 ²⁾	10.0 ²⁾
3.5	<0.5 ¹⁾	<0.5 ¹⁾	0.5	0.9	7.0	10.0 ²⁾	10.0 ²⁾	10.0 ²⁾	10.0 ²⁾	10.0 ²⁾
4	<0.5 ¹⁾	<0.5 ¹⁾	0.5	0.9	2.5	10.0 ²⁾	10.0 ²⁾	10.0 ²⁾	10.0 ²⁾	10.0 ²⁾
5		<0.5 ¹⁾	0.5	0.8	1.7	4.0	7.0	10.0 ²⁾	10.0 ²⁾	10.0 ²⁾
6		<0.5 ¹⁾	0.5	0.8	1.6	3.6	6.0	10.0 ²⁾	10.0 ²⁾	10.0 ²⁾
8			0.5	0.8	1.4	2.8	4.3	8.2	10.0 ²⁾	10.0 ²⁾
10			0.5	0.7	1.3	2.4	3.4	6.0	10.0 ²⁾	10.0 ²⁾
13			<0.5 ¹⁾	0.7	1.2	2.3	3.2	5.3	10.0 ²⁾	10.0 ²⁾
16				0.6	1.1	2.2	2.9	4.6	10.0	10.0
20					1.1	2.1	2.8	4.4	9.3	9.3
25					1.1	2.0	2.7	4.2	8.7	8.7
32						2.0	2.6	4.0	8.0	8.0
40							2.5	3.8	7.5	7.5
50							2.3	3.4	6.7	6.7
63									6.2	6.2

Short circuit selectivity **characteristic C** towards fuse link **D01-D03***)

FAZ	D01-D03 gL/gG									
	I _n [A]	10	16	20	25	35	50	63	80	100
0.75	<0.5 ¹⁾	10.0 ²⁾	10.0 ²⁾	10.0 ²⁾	10.0 ²⁾	10.0 ²⁾	10.0 ²⁾	10.0 ²⁾	10.0 ²⁾	10.0 ²⁾
1.0	<0.5 ¹⁾	10.0 ²⁾	10.0 ²⁾	10.0 ²⁾	10.0 ²⁾	10.0 ²⁾	10.0 ²⁾	10.0 ²⁾	10.0 ²⁾	10.0 ²⁾
1.5	<0.5 ¹⁾	0.5	0.6	0.9	10.0 ²⁾	10.0 ²⁾	10.0 ²⁾	10.0 ²⁾	10.0 ²⁾	10.0 ²⁾
2.0	<0.5 ¹⁾	<0.5 ¹⁾	0.5	0.7	10.0 ²⁾	10.0 ²⁾	10.0 ²⁾	10.0 ²⁾	10.0 ²⁾	10.0 ²⁾
2.5	<0.5 ¹⁾	<0.5 ¹⁾	0.5	0.7	10.0 ²⁾	10.0 ²⁾	10.0 ²⁾	10.0 ²⁾	10.0 ²⁾	10.0 ²⁾
3.0	<0.5 ¹⁾	<0.5 ¹⁾	<0.5 ¹⁾	0.6	1.9	5.2	10.0 ²⁾	10.0 ²⁾	10.0 ²⁾	10.0 ²⁾
3.5	<0.5 ¹⁾	<0.5 ¹⁾	<0.5 ¹⁾	0.6	1.8	4.7	9.5	10.0 ²⁾	10.0 ²⁾	10.0 ²⁾
4	<0.5 ¹⁾	<0.5 ¹⁾	<0.5 ¹⁾	0.6	1.6	4.0	7.6	10.0 ²⁾	10.0 ²⁾	10.0 ²⁾
5		<0.5 ¹⁾	<0.5 ¹⁾	0.5	1.3	3.1	5.7	10.0 ²⁾	10.0 ²⁾	10.0 ²⁾
6		<0.5 ¹⁾	<0.5 ¹⁾	<0.5 ¹⁾	1.2	2.7	4.5	10.0 ²⁾	10.0 ²⁾	10.0 ²⁾
8		<0.5 ¹⁾	<0.5 ¹⁾	<0.5 ¹⁾	1.2	2.5	4.0	8.6	10.0 ²⁾	10.0 ²⁾
10			<0.5 ¹⁾	<0.5 ¹⁾	1.2	2.3	3.1	5.4	10.0 ²⁾	10.0 ²⁾
13					1.1	2.2	3.0	4.9	10.0 ²⁾	10.0 ²⁾
16					1.1	2.1	2.8	4.4	9.5	9.5
20					1.0	2.0	2.6	4.0	8.3	8.3
25						1.9	2.5	3.8	7.8	7.8
32							2.5	3.7	7.3	7.3
40								3.5	7.0	7.0
50									6.5	6.5
63										6.2

Short circuit selectivity **characteristic D** towards fuse link **D01-D03***)

FAZ	D01-D03 gL/gG									
	I _n [A]	10	16	20	25	35	50	63	80	100
0.5	<0.5 ¹⁾	10.0 ²⁾	10.0 ²⁾	10.0 ²⁾	10.0 ²⁾	10.0 ²⁾	10.0 ²⁾	10.0 ²⁾	10.0 ²⁾	10.0 ²⁾
1.0	<0.5 ¹⁾	<0.5 ¹⁾	0.7	1.3	10.0 ²⁾	10.0 ²⁾	10.0 ²⁾	10.0 ²⁾	10.0 ²⁾	10.0 ²⁾
1.5	<0.5 ¹⁾	<0.5 ¹⁾	0.6	0.9	2.8	9.0	10.0 ²⁾	10.0 ²⁾	10.0 ²⁾	10.0 ²⁾
2.0	<0.5 ¹⁾	<0.5 ¹⁾	0.6	0.8	2.2	6.7	10.0 ²⁾	10.0 ²⁾	10.0 ²⁾	10.0 ²⁾
2.5	<0.5 ¹⁾	<0.5 ¹⁾	0.5	0.7	1.9	5.4	10.0 ²⁾	10.0 ²⁾	10.0 ²⁾	10.0 ²⁾
3.0	<0.5 ¹⁾	<0.5 ¹⁾	0.5	0.7	1.8	4.8	9.3	10.0 ²⁾	10.0 ²⁾	10.0 ²⁾
3.5	<0.5 ¹⁾	<0.5 ¹⁾	0.5	0.7	1.7	4.7	8.6	10.0 ²⁾	10.0 ²⁾	10.0 ²⁾
4		<0.5 ¹⁾	0.5	0.7	1.7	4.6	7.7	10.0 ²⁾	10.0 ²⁾	10.0 ²⁾
5		<0.5 ¹⁾	<0.5 ¹⁾	0.6	1.5	3.5	5.8	10.0 ²⁾	10.0 ²⁾	10.0 ²⁾
6			<0.5 ¹⁾	0.5	1.3	2.9	4.5	9.0	10.0 ²⁾	10.0 ²⁾
8			<0.5 ¹⁾	0.5	1.2	2.4	3.5	6.0	10.0 ²⁾	10.0 ²⁾
10				0.5	1.1	2.2	3.0	5.0	10.0 ²⁾	10.0 ²⁾
13					1.1	2.1	2.9	4.6	10.0 ²⁾	10.0 ²⁾
16						1.9	2.6	3.9	9.0	9.0
20						1.7	2.3	3.5	8.0	8.0
25							2.2	3.4	7.5	7.5
32								2.9	6.0	6.0
40									5.7	5.7

¹⁾ Selectivity limit current I_s under 0.5 kA

²⁾ Selectivity limit current I_s = rated breaking capacity I_{cn} of the MCB

Shaded fields: no selectivity

FAZ towards DII-DIV fuse link

Short circuit selectivity **characteristic B** towards fuse link **DII-DIV***)

FAZ	DII-DIV gL/gG								
I _n [A]	10	16	20	25	35	50	63	80	100
1.0	<0.5 ¹⁾	1.2	10.0 ²⁾	10.0 ²⁾	10.0 ²⁾	10.0 ²⁾	10.0 ²⁾	10.0 ²⁾	10.0 ²⁾
1.5	<0.5 ¹⁾	1.0	10.0 ²⁾	10.0 ²⁾	10.0 ²⁾	10.0 ²⁾	10.0 ²⁾	10.0 ²⁾	10.0 ²⁾
2.0	<0.5 ¹⁾	<0.5 ¹⁾	0.8	1.6	10.0 ²⁾	10.0 ²⁾	10.0 ²⁾	10.0 ²⁾	10.0 ²⁾
2.5	<0.5 ¹⁾	<0.5 ¹⁾	0.8	1.5	10.0 ²⁾	10.0 ²⁾	10.0 ²⁾	10.0 ²⁾	10.0 ²⁾
3.0	<0.5 ¹⁾	<0.5 ¹⁾	0.8	1.4	10.0 ²⁾	10.0 ²⁾	10.0 ²⁾	10.0 ²⁾	10.0 ²⁾
3.5	<0.5 ¹⁾	<0.5 ¹⁾	0.7	1.3	10.0 ²⁾	10.0 ²⁾	10.0 ²⁾	10.0 ²⁾	10.0 ²⁾
4	<0.5 ¹⁾	<0.5 ¹⁾	0.6	1.0	3.6	10.0 ²⁾	10.0 ²⁾	10.0 ²⁾	10.0 ²⁾
5	<0.5 ¹⁾	<0.5 ¹⁾	0.6	0.9	2.0	3.5	8.5	10.0 ²⁾	10.0 ²⁾
6		<0.5 ¹⁾	0.6	0.9	1.8	3.2	7.4	10.0 ²⁾	10.0 ²⁾
8		<0.5 ¹⁾	0.5	0.8	1.6	2.6	5.2	8.3	10.0 ²⁾
10			0.5	0.8	1.4	2.2	3.9	6.0	10.0 ²⁾
13			0.5	0.7	1.3	2.0	3.6	5.4	10.0 ²⁾
16				0.6	1.2	1.9	3.2	4.6	8.4
20					1.2	1.8	3.1	4.4	7.8
25					1.2	1.8	3.0	4.2	7.3
32						1.7	2.8	3.9	6.8
40							2.7	3.8	6.5
50							2.5	3.5	5.7
63									5.3

Short circuit selectivity **characteristic C** towards fuse link **DII-DIV***)

FAZ	DII-DIV gL/gG								
I _n [A]	10	16	20	25	35	50	63	80	100
0.75	1.0	10.0 ²⁾	10.0 ²⁾	10.0 ²⁾	10.0 ²⁾	10.0 ²⁾	10.0 ²⁾	10.0 ²⁾	10.0 ²⁾
1.0	<0.5 ¹⁾	1.2	10.0 ²⁾	10.0 ²⁾	10.0 ²⁾	10.0 ²⁾	10.0 ²⁾	10.0 ²⁾	10.0 ²⁾
1.5	<0.5 ¹⁾	<0.5 ¹⁾	1.0	2.2	10.0 ²⁾	10.0 ²⁾	10.0 ²⁾	10.0 ²⁾	10.0 ²⁾
2.0	<0.5 ¹⁾	<0.5 ¹⁾	0.8	1.6	10.0 ²⁾	10.0 ²⁾	10.0 ²⁾	10.0 ²⁾	10.0 ²⁾
2.5	<0.5 ¹⁾	<0.5 ¹⁾	0.8	1.4	10.0 ²⁾	10.0 ²⁾	10.0 ²⁾	10.0 ²⁾	10.0 ²⁾
3.0	<0.5 ¹⁾	<0.5 ¹⁾	0.8	0.9	10.0 ²⁾	10.0 ²⁾	10.0 ²⁾	10.0 ²⁾	10.0 ²⁾
3.5	<0.5 ¹⁾	<0.5 ¹⁾	0.6	0.9	2.2	4.5	10.0 ²⁾	10.0 ²⁾	10.0 ²⁾
4	<0.5 ¹⁾	<0.5 ¹⁾	0.6	0.8	1.8	3.6	9.7	10.0 ²⁾	10.0 ²⁾
5	<0.5 ¹⁾	<0.5 ¹⁾	0.6	0.7	1.5	2.7	7.3	10.0 ²⁾	10.0 ²⁾
6		<0.5 ¹⁾	0.5	0.6	1.4	2.4	5.5	10.0 ²⁾	10.0 ²⁾
8		<0.5 ¹⁾	<0.5 ¹⁾	0.6	1.3	2.2	4.7	8.7	10.0 ²⁾
10			<0.5 ¹⁾	0.6	1.3	2.0	3.6	5.4	10.0 ²⁾
13					1.3	1.9	3.3	5.0	9.4
16					1.2	1.8	3.2	4.4	8.0
20					1.2	1.8	3.1	4.1	7.0
25						1.7	2.8	3.8	6.5
32							2.7	3.7	6.2
40								3.5	5.9
50									5.5
63									

Short circuit selectivity **characteristic D** towards fuse link **DII-DIV***)

FAZ	DII-DIV gL/gG								
I _n [A]	10	16	20	25	35	50	63	80	100
0.5	0.5	3.0	10.0 ²⁾	10.0 ²⁾	10.0 ²⁾	10.0 ²⁾	10.0 ²⁾	10.0 ²⁾	10.0 ²⁾
1.0	<0.5 ¹⁾	<0.5 ¹⁾	1.0	2.4	10.0 ²⁾	10.0 ²⁾	10.0 ²⁾	10.0 ²⁾	10.0 ²⁾
1.5	<0.5 ¹⁾	<0.5 ¹⁾	0.7	1.2	3.5	7.7	10.0 ²⁾	10.0 ²⁾	10.0 ²⁾
2.0	<0.5 ¹⁾	<0.5 ¹⁾	0.6	1.0	2.8	5.8	10.0 ²⁾	10.0 ²⁾	10.0 ²⁾
2.5	<0.5 ¹⁾	<0.5 ¹⁾	0.6	1.4	2.3	4.6	10.0 ²⁾	10.0 ²⁾	10.0 ²⁾
3.0	<0.5 ¹⁾	<0.5 ¹⁾	0.6	0.9	2.3	4.3	10.0 ²⁾	10.0 ²⁾	10.0 ²⁾
3.5	<0.5 ¹⁾	<0.5 ¹⁾	0.6	0.9	2.1	4.0	10.0 ²⁾	10.0 ²⁾	10.0 ²⁾
4		<0.5 ¹⁾	0.6	0.9	2.0	3.8	9.5	10.0 ²⁾	10.0 ²⁾
5		<0.5 ¹⁾	0.5	0.7	1.7	3.1	7.0	10.0 ²⁾	10.0 ²⁾
6			0.5	0.7	1.5	2.6	5.3	9.1	10.0 ²⁾
8			<0.5 ¹⁾	0.7	1.4	2.2	3.9	6.0	10.0 ²⁾
10				0.7	1.2	1.9	3.4	5.0	9.5
13					1.2	1.8	3.2	4.6	8.6
16						1.6	2.7	4.0	7.4
20						1.5	2.5	3.5	6.7
25							2.4	3.4	6.2
32								2.8	5.0
40									4.8

¹⁾ Selectivity limit current I_s under 0.5 kA

²⁾ Selectivity limit current I_s = rated breaking capacity I_{cn} of the MCB

Shaded fields: no selectivity

FAZ-B and NZM 1/2

Selectivity-limit current I_g [kA] for selectivity between FAZ-B and NZM (overload and short-circuit release unit NZM at max. value).

I_n [A]	NZM...1-A...						NZM...2-A...								
	$I_{cu} = 25 (50) \text{ kA}$						$I_{cu} = 25 (50)(100)(150) \text{ kA}$								
FAZ-B	40	50	63	80	100	125	40	50	63	80	100	125	160	200	250
1	15	15	15	15	15	15	15	15	15	15	15	15	15	15	15
2	2	15	15	15	15	15	3	15	15	15	15	15	15	15	15
3	1.2	2	3	3	10	15	1.5	1.5	3	5	15	15	15	15	15
4	1.2	2	3	3	8	15	1.2	1.5	3	4	15	15	15	15	15
6	1.2	2	2.5	3	5	10	1.2	1.5	2.5	3	15	15	15	15	15
10	1.2	1.5	2	2	4	10	1	1.5	2.5	3	10	10	10	10	10
13	1	1.5	2	2	4	10	1	1.2	2	3	10	10	10	10	10
16	1	1.2	1.5	2	3	8	1	1.2	1.5	2.5	10	10	10	10	10
20	0.8	1.2	1.5	1.5	3	8	1	1.2	1.5	1.5	10	10	10	10	10
25	0.7	1.2	1.5	1.5	3	7	0.8	1	1.5	2	10	10	10	10	10
32	-	1.2	1	1.5	2	6	-	1	1.5	2	8	8	8	8	10
40	-	-	1	1.5	2	5	-	-	1.2	1.5	7	7	7	7	10
50	-	-	-	1.2	1.5	4	-	-	-	1.5	6	6	6	6	10
63	-	-	-	-	1.5	3	-	-	-	-	6	6	6	6	10

FAZ-C and NZM 1/2

Selectivity-limit current I_g [kA] for selectivity between FAZ-C and NZM (overload and short-circuit release unit NZM at max. value).

I_n [A]	NZM...1-A...						NZM...2-A...								
	$I_{cu} = 25 (50) \text{ kA}$						$I_{cu} = 25 (50)(100)(150) \text{ kA}$								
FAZ-C	40	50	63	80	100	125	40	50	63	80	100	125	160	200	250
0.5	15	15	15	15	15	15	15	15	15	15	15	15	15	15	15
1	15	15	15	15	15	15	15	15	15	15	15	15	15	15	15
2	2	15	15	15	15	15	3	15	15	15	15	15	15	15	15
3	1.2	2	3	3	10	15	1.5	1.5	3	5	15	15	15	15	15
4	1.2	2	3	3	8	15	1.2	1.5	3	4	15	15	15	15	15
6	1.2	2	2.5	3	5	10	1.2	1.5	2.5	3	15	15	15	15	15
10	1.2	1.5	2	2	4	10	1	1.5	2.5	3	10	10	10	10	10
13	1	1.5	2	2	4	10	1	1.2	2	3	10	10	10	10	10
16	1	1.2	1.5	2	3	8	1	1.2	1.5	2.5	10	10	10	10	10
20	0.8	1.2	1.5	1.5	3	8	1	1.2	1.5	1.5	10	10	10	10	10
25	0.7	1.2	1.5	1.5	3	7	0.8	1	1.5	2	10	10	10	10	10
32	-	1.2	1	1.5	2	6	-	1	1.5	2	8	8	8	8	10
40	-	-	1	1.5	2	5	-	-	1.2	1.5	7	7	7	7	10
50	-	-	-	1.2	1.5	4	-	-	-	1.5	6	6	6	6	10
63	-	-	-	-	1.5	3	-	-	-	-	6	6	6	6	10

FAZ-D and NZM 1/2

Selectivity-limit current I_s [kA] for selectivity between FAZ-D and NZM (overload and short-circuit release unit NZM at max. value).

I_n [A]	NZM...1-A...						NZM...2-A...								
	$I_{cu} = 25 (50) \text{ kA}$						$I_{cu} = 25 (50)(100)(150) \text{ kA}$								
FAZ-D	40	50	63	80	100	125	40	50	63	80	100	125	160	200	250
0.5	9	15	15	15	15	15	9	15	15	15	15	15	15	15	15
1	0.5	0.7	1.1	1.9	4.2	15	0.5	0.7	1.1	1.9	4.2	15	15	15	15
1.5	0.3	0.6	0.8	1.1	1.6	2.6	0.3	0.6	0.8	1.1	1.6	2.6	5	15	15
2	0.3	0.5	0.75	0.95	1.4	2.4	0.3	0.5	0.75	0.95	1.4	2.4	4.5	10	15
2.5	0.3	0.5	0.75	0.95	1.3	2.3	0.3	0.5	0.75	0.95	1.3	2.3	4.2	9	15
3	0.3	0.5	0.7	0.9	1.3	2.1	0.3	0.5	0.7	0.9	1.3	2.1	3.6	7	15
3.5	0.3	0.5	0.7	0.9	1.3	2	0.3	0.5	0.7	0.9	1.3	2	3.3	5.6	10
4	0.3	0.5	0.7	0.9	1.3	1.9	0.3	0.5	0.7	0.9	1.3	1.9	3	4.7	8
5	0.3	0.5	0.7	0.9	1.3	1.9	0.3	0.5	0.7	0.9	1.3	1.9	3	4.4	7
6	0.3	0.5	0.6	0.9	1.3	1.8	0.3	0.5	0.6	0.9	1.3	1.8	2.8	4	6
8	0.3	0.3	0.6	0.75	1	1.3	0.3	0.3	0.6	0.75	1	1.3	1.8	2.7	4
10	0.3	0.3	0.6	0.75	0.95	1.2	0.3	0.3	0.6	0.75	0.95	1.2	1.7	2.4	3.6
13	0.3	0.3	0.5	0.7	0.9	1.1	0.3	0.3	0.5	0.7	0.9	1.1	1.6	2.2	3.2
16	-	0.3	0.5	0.65	0.8	1.1	-	0.3	0.5	0.65	0.8	1.1	1.5	2.1	3
20	-	-	0.5	0.65	0.8	1.1	-	-	0.5	0.65	0.8	1.1	1.4	2.1	3
25	-	-	0.5	0.65	0.8	1.1	-	-	0.5	0.65	0.8	1.1	1.4	1.9	2.7
32	-	-	-	-	0.8	1.1	-	-	-	-	0.8	1.1	1.4	1.9	2.7
40	-	-	-	-	-	1	-	-	-	-	-	1	1.4	1.8	2.6

Back-up Protection FAZ

The up-stream protective devices will protect the down-stream FAZ up to the short-circuit current specified.

FAZ/C and AZ/C

I_n [A]	AZ/C								
	I_n [A]								
FAZ/C	20	25	32	40	50	63	80	100	125
1	25	25	25	25	25	25	20	20	15 kA
2	25	25	25	25	25	25	20	20	15 kA
4	25	25	25	25	25	25	20	20	15 kA
6	25	25	25	25	25	25	20	20	15 kA
10	25	25	25	25	25	25	20	20	15 kA
13	25	25	25	25	25	25	20	20	15 kA
16	25	25	25	25	25	25	20	20	15 kA
20	1)	25	25	25	25	25	20	20	15 kA
25	1)	1)	25	25	25	25	20	20	15 kA
32	1)	1)	1)	25	25	25	20	20	-
40	1)	1)	1)	1)	25	25	20	20	-
50	1)	1)	1)	1)	1)	25	20	20	-
63	1)	1)	1)	1)	1)	1)	-	-	-

1) I_n (AZ) \leq I_n (FAZ)

FAZ and CL-PKZ0

Back-up tests acc. to EN/IEC 60947-2, App. A: $U = 1.05 U_e$, (O - t - CO)

I_n [A]	FAZ- $I_n/1(2,3,4)/B(C) + CL-PKZ0$ $U_e = 230/400 V$
0.16	65 kA
0.25	65 kA
0.5	65 kA
0.75	65 kA
1	65 kA
1.5	65 kA
2	65 kA
2.5	65 kA
3	65 kA
3.5	65 kA
4	65 kA
5	45 kA
6	45 kA
8	45 kA
10	45 kA
12	45 kA
13	45 kA
15	45 kA
16	45 kA
20	45 kA
25	45 kA
32	45 kA
40	25 kA
50	25 kA
63	25 kA

FAZ and NZM7

I_n [A]	FAZ- $I_n/1(2,3,4)/B(C) + NZM7-40(...100)$ $U_e = 230/400 V$
0.16	25 kA
0.25	25 kA
0.5	25 kA
0.75	25 kA
1	25 kA
1.5	25 kA
2	25 kA
2.5	25 kA
3	25 kA
3.5	25 kA
4	25 kA
5	20 kA
6	20 kA
8	20 kA
10	20 kA
12	20 kA
13	20 kA
15	20 kA
16	20 kA
20	18 kA
25	18 kA
32	18 kA
40	18 kA
50	15 kA
63	15 kA

FAZ and NZMB1

$U_e = 230/400\text{ V}$: I_{cu} (FAZ) = 15 kA

$U_e = 230/400\text{ V}$: I_{cu} (NZMB1) = 25 kA

Back-up test acc. EN/IEC 60947-2, app. A: $U = 1.05U_e$, (O - t - CO)

(Settings NZMB1: I_r , I_{rm} at max. volumes)

I_n [A]	FAZ-$I_n/1(2,3,4)/B(C)$ + NZMB1 $U_e = 230/400\text{ V}$
0.16	25 kA
0.25	25 kA
0.5	25 kA
0.75	25 kA
1	25 kA
1.5	25 kA
2	25 kA
2.5	25 kA
3	25 kA
3.5	25 kA
4	25 kA
5	25 kA
6	25 kA
8	25 kA
10	25 kA
12	25 kA
13	25 kA
15	25 kA
16	25 kA
20	20 kA
25	20 kA
32	20 kA
40	20 kA
50	15 kA
63	15 kA

FAZ and NZMN1

$U_e = 230/400\text{ V}$: I_{cu} (FAZ) = 15 kA

$U_e = 230/400\text{ V}$: I_{cu} (NZMN1) = 25 kA

Back-up test acc. EN/IEC 60947-2, app. A: $U = 1.05U_e$, (O - t - CO)

(Settings NZM at max. values)

I_n [A]	FAZ-$I_n/1(2,3,4)/B(C)$ + NZMN1 $U_e = 230/400\text{ V}$
0.16	25 kA
0.25	25 kA
0.5	25 kA
0.75	25 kA
1	25 kA
1.5	25 kA
2	25 kA
2.5	25 kA
3	25 kA
3.5	25 kA
4	25 kA
5	25 kA
6	25 kA
8	25 kA
10	25 kA
12	25 kA
13	25 kA
15	25 kA
16	25 kA
20	20 kA
25	20 kA
32	20 kA
40	20 kA
50	15 kA
63	15 kA

FAZ and NZMB2

$U_e = 230/400\text{ V}$: I_{cu} (FAZ) = 15 kA
 $U_e = 230/400\text{ V}$: I_{cu} (NZMB2) = 25 kA
 $U_e = 133/230\text{ V}$: I_{cu} (FAZ) = 20 kA
 $U_e = 133/230\text{ V}$: I_{cu} (NZMB2) = 30 kA
 Back-up test acc. EN/IEC 60947-2, app. A: $U = 1.05U_e$, (O - t - CO)
 (Settings NZM at max. values)

I_n [A]	FAZ-$I_n/1(2,3,4)/B(C)$ + NZMB2	
	$U_e = 230/400\text{ V}$	$U_e = 133/230\text{ V}$
0.16	25 kA	30 kA
0.25	25 kA	30 kA
0.5	25 kA	30 kA
0.75	25 kA	30 kA
1	25 kA	30 kA
1.5	25 kA	30 kA
2	25 kA	30 kA
2.5	25 kA	30 kA
3	25 kA	30 kA
3.5	25 kA	30 kA
4	25 kA	30 kA
5	25 kA	25 kA
6	25 kA	25 kA
8	25 kA	25 kA
10	25 kA	25 kA
12	20 kA	25 kA
13	20 kA	25 kA
15	20 kA	25 kA
16	20 kA	25 kA
20	20 kA	25 kA
25	20 kA	25 kA
32	20 kA	25 kA
40	15 kA	20 kA
50	15 kA	20 kA
63	15 kA	20 kA

FAZ and NZMN2

$U_e = 230/400\text{ V}$: I_{cu} (FAZ) = 15 kA
 $U_e = 230/400\text{ V}$: I_{cu} (NZMN2) = 50 kA
 $U_e = 133/230\text{ V}$: I_{cu} (FAZ) = 20 kA
 $U_e = 133/230\text{ V}$: I_{cu} (NZMN2) = 85 kA
 Back-up test acc. EN/IEC 60947-2, app. A: $U = 1.05U_e$, (O - t - CO)
 (Settings NZM at max. values)

I_n [A]	FAZ-$I_n/1(2,3,4)/B(C)$ + NZMN2	
	$U_e = 230/400\text{ V}$	$U_e = 133/230\text{ V}$
0.16	50 kA	85 kA
0.25	50 kA	85 kA
0.5	50 kA	85 kA
0.75	50 kA	85 kA
1	50 kA	85 kA
1.5	50 kA	85 kA
2	50 kA	85 kA
2.5	50 kA	85 kA
3	50 kA	85 kA
3.5	50 kA	85 kA
4	50 kA	85 kA
5	50 kA	80 kA
6	50 kA	80 kA
8	50 kA	80 kA
10	50 kA	80 kA
12	30 kA	60 kA
13	30 kA	60 kA
15	30 kA	60 kA
16	30 kA	60 kA
20	30 kA	60 kA
25	30 kA	60 kA
32	30 kA	60 kA
40	20 kA	40 kA
50	20 kA	40 kA
63	20 kA	40 kA

FAZ and NZMH2

$U_e = 230/400\text{ V}$: I_{cu} (FAZ) = 15 kA
 $U_e = 230/400\text{ V}$: I_{cu} (NZMH2) = 150 kA
 $U_e = 133/230\text{ V}$: I_{cu} (FAZ) = 20 kA
 $U_e = 133/230\text{ V}$: I_{cu} (NZMH2) = 150 kA
 Back-up test acc. EN/IEC 60947-2, app. A: $U = 1.05U_e$, (O - t - CO)
 (Settings NZM at max. values)

I_n [A]	FAZ-$I_n/1(2,3,4)/B(C)$ + NZMH2	
	$U_e = 230/400\text{ V}$	$U_e = 133/230\text{ V}$
0.16	50 kA	85 kA
0.25	50 kA	85 kA
0.5	50 kA	85 kA
0.75	50 kA	85 kA
1	50 kA	85 kA
1.5	50 kA	85 kA
2	50 kA	85 kA
2.5	50 kA	85 kA
3	50 kA	85 kA
3.5	50 kA	85 kA
4	50 kA	85 kA
5	50 kA	80 kA
6	50 kA	80 kA
8	50 kA	80 kA
10	50 kA	80 kA
12	30 kA	60 kA
13	30 kA	60 kA
15	30 kA	60 kA
16	30 kA	60 kA
20	30 kA	60 kA
25	30 kA	60 kA
32	30 kA	60 kA
40	20 kA	40 kA
50	20 kA	40 kA
63	20 kA	40 kA

FAZ and NZML2

$U_e = 230/400\text{ V}$: I_{cu} (FAZ) = 15 kA
 $U_e = 230/400\text{ V}$: I_{cu} (NZML2) = 150 kA
 $U_e = 133/230\text{ V}$: I_{cu} (FAZ) = 20 kA
 $U_e = 133/230\text{ V}$: I_{cu} (NZML2) = 150 kA
 Back-up test acc. EN/IEC 60947-2, app. A: $U = 1.05U_e$, (O - t - CO)
 (Settings NZM at max. values)

I_n [A]	FAZ-$I_n/1(2,3,4)/B(C)$ + NZML2	
	$U_e = 230/400\text{ V}$	$U_e = 133/230\text{ V}$
0.16	50 kA	85 kA
0.25	50 kA	85 kA
0.5	50 kA	85 kA
0.75	50 kA	85 kA
1	50 kA	85 kA
1.5	50 kA	85 kA
2	50 kA	85 kA
2.5	50 kA	85 kA
3	50 kA	85 kA
3.5	50 kA	85 kA
4	50 kA	85 kA
5	50 kA	80 kA
6	50 kA	80 kA
8	50 kA	80 kA
10	50 kA	80 kA
12	30 kA	60 kA
13	30 kA	60 kA
15	30 kA	60 kA
16	30 kA	60 kA
20	30 kA	60 kA
25	30 kA	60 kA
32	30 kA	60 kA
40	20 kA	40 kA
50	20 kA	40 kA
63	20 kA	40 kA

FAZ and NH

$U_e = 230\text{ V}$: I_{cu} (FAZ) = 15 (10) kA (acc. to IEC/EN 60947)

$U_e = 500\text{ V}$: I_{cu} (NH00 125 A gL / gG) = 120kA

I_n [A]	FAZ-I_n/B,(C),(D)... + NH00 125 A gL/gG IT-system U = 230 V
0.5	50 kA
1	50 kA
2	50 kA
3	50 kA
4	50 kA
6	50 kA
10	50 kA
13	50 kA
16	50 kA
20	50 kA
25	50 kA
32	50 kA
40	50 kA
50	50 kA
63	50 kA

Overload Selectivity FAZ

FAZ-B(C)(D) to FAZ-B

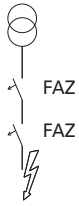

Upstream side FAZ, Characteristic B
Downstream side FAZ, Characteristic B, C, D

x ... Selectivity range (i.e. only the downstream switch drops in case $I < I_s$)

Upstream side	FAZ Characteristic B													
Type B rated current I_n [A]		2	3	4	6	10	13	16	20	25	32	40	50	63
Selectivity limiting current I_s [A]		7	10.5	14	21	35	45.5	56	70	87.5	112	140	175	220.5
Downstream side FAZ Characteristic B	2		x	x	x	x	x	x	x	x	x	x	x	x
	3			x	x	x	x	x	x	x	x	x	x	x
	4				x	x	x	x	x	x	x	x	x	x
	6					x	x	x	x	x	x	x	x	x
	10						x	x	x	x	x	x	x	x
	13							x	x	x	x	x	x	x
	16								x	x	x	x	x	x
	20									x	x	x	x	x
	25										x	x	x	x
	32											x	x	x
	40												x	x
	50													x
	63													

Upstream side	FAZ Characteristic B															
Type B rated current I_n [A]		2	3	4	6	10	13	16	20	25	32	40	50	63		
Selectivity limiting current I_s [A]		7	10.5	14	21	35	45.5	56	70	87.5	112	140	175	220.5		
Downstream side FAZ Characteristic C	0.5	x	x	x	x	x	x	x	x	x	x	x	x	x		
	1	x	x	x	x	x	x	x	x	x	x	x	x	x		
	2			x	x	x	x	x	x	x	x	x	x	x		
	3				x	x	x	x	x	x	x	x	x	x		
	4					x	x	x	x	x	x	x	x	x		
	6						x	x	x	x	x	x	x	x		
	8							x	x	x	x	x	x	x		
	10								x	x	x	x	x	x		
	13									x	x	x	x	x		
	16										x	x	x	x		
	20											x	x	x		
	25												x	x		
	32													x		
	40														x	
	50															x
63																x

Upstream side	FAZ Characteristic B															
Type B rated current I_n [A]		2	3	4	6	10	13	16	20	25	32	40	50	63		
Selectivity limiting current I_s [A]		7	10.5	14	21	35	45.5	56	70	87.5	112	140	175	220.5		
Downstream side FAZ Characteristic D	2					x	x	x	x	x	x	x	x	x		
	4							x	x	x	x	x	x	x		
	6								x	x	x	x	x	x		
	10										x	x	x	x		
	13											x	x	x		
	16												x	x		
	20													x		
	25														x	
	32															x
40																x

Overload Selectivity FAZ

FAZ-B(C)(D) to FAZ-C

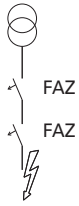

Upstream side FAZ, Characteristic C
Downstream side FAZ, Characteristic B, C, D

x ... Selectivity range (i.e. only the downstream switch drops in case $I < I_g$)

Upstream side →		FAZ Characteristic C																
Type B rated current I_n [A]		0.5	1	2	3	4	6	8	10	13	16	20	25	32	40	50	63	
Selectivity limiting current I_g [A]		2.85	5.7	11.4	17.1	22.8	34.2	45.6	57	74.1	91.2	114	142.5	182.4	228	285	359.1	
Downstream side FAZ Characteristic B	2				x	x	x	x	x	x	x	x	x	x	x	x	x	
	3					x	x	x	x	x	x	x	x	x	x	x	x	
	4						x	x	x	x	x	x	x	x	x	x	x	
	6							x	x	x	x	x	x	x	x	x	x	
	10									x	x	x	x	x	x	x	x	
	13										x	x	x	x	x	x	x	
	16											x	x	x	x	x	x	
	20												x	x	x	x	x	
	25													x	x	x	x	
	32														x	x	x	
	40															x	x	
	50																x	x
	63																	x

Upstream side →		FAZ Characteristic C															
Type B rated current I_n [A]		0.5	1	2	3	4	6	8	10	13	16	20	25	32	40	50	63
Selectivity limiting current I_g [A]		2.85	5.7	11.4	17.1	22.8	34.2	45.6	57	74.1	91.2	114	142.5	182.4	228	285	359.1
Downstream side FAZ Characteristic C	0.5		x	x	x	x	x	x	x	x	x	x	x	x	x	x	x
	1			x	x	x	x	x	x	x	x	x	x	x	x	x	x
	2				x	x	x	x	x	x	x	x	x	x	x	x	x
	3					x	x	x	x	x	x	x	x	x	x	x	x
	4						x	x	x	x	x	x	x	x	x	x	x
	6							x	x	x	x	x	x	x	x	x	x
	8								x	x	x	x	x	x	x	x	x
	10									x	x	x	x	x	x	x	x
	13										x	x	x	x	x	x	x
	16											x	x	x	x	x	x
	20												x	x	x	x	x
	25													x	x	x	x
	32														x	x	x
	40															x	x
	50																x
63																	x

Upstream side →		FAZ Characteristic C															
Type B rated current I_n [A]		0.5	1	2	3	4	6	8	10	13	16	20	25	32	40	50	63
Selectivity limiting current I_g [A]		2.85	5.7	11.4	17.1	22.8	34.2	45.6	57	74.1	91.2	114	142.5	182.4	228	285	359.1
Downstream side FAZ Characteristic D	2						x	x	x	x	x	x	x	x	x	x	x
	4							x	x	x	x	x	x	x	x	x	x
	6								x	x	x	x	x	x	x	x	x
	10										x	x	x	x	x	x	x
	13											x	x	x	x	x	x
	16												x	x	x	x	x
	20													x	x	x	x
	25														x	x	x
	32															x	x
40																x	x

Overload Selectivity FAZ

FAZ-B(C)(D) to FAZ-D

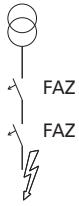

Upstream side FAZ, Characteristic D
Downstream side FAZ, Characteristic B, C, D

x ... Selectivity range (i.e. only the downstream switch drops in case $I < I_g$)

Upstream side →		FAZ Characteristic D									
Type B rated current I_n [A]		2	4	6	10	13	16	20	25	32	40
Selectivity limiting current I_g [A]		21	42	63	105	136.5	168	210	262.5	336	420
Downstream side FAZ Characteristic B	2	x	x	x	x	x	x	x	x	x	x
	3		x	x	x	x	x	x	x	x	x
	4			x	x	x	x	x	x	x	x
	6				x	x	x	x	x	x	x
	10					x	x	x	x	x	x
	13						x	x	x	x	x
	16							x	x	x	x
	20								x	x	x
	25									x	x
	32										x
	40										
	50										
63											

Upstream side →		FAZ Characteristic D									
Type B rated current I_n [A]		2	4	6	10	13	16	20	25	32	40
Selectivity limiting current I_g [A]		21	42	63	105	136.5	168	210	262.5	336	420
Downstream side FAZ Characteristic C	0.5	x	x	x	x	x	x	x	x	x	x
	1	x	x	x	x	x	x	x	x	x	x
	2		x	x	x	x	x	x	x	x	x
	3			x	x	x	x	x	x	x	x
	4				x	x	x	x	x	x	x
	6					x	x	x	x	x	x
	8						x	x	x	x	x
	10							x	x	x	x
	13								x	x	x
	16									x	x
	20										x
	25										
	32										
	40										
	50										
63											

Upstream side →		FAZ Characteristic D									
Type B rated current I_n [A]		2	4	6	10	13	16	20	25	32	40
Selectivity limiting current I_g [A]		21	42	63	105	136.5	168	210	262.5	336	420
Downstream side FAZ Characteristic D	2	x	x	x	x	x	x	x	x	x	x
	4			x	x	x	x	x	x	x	x
	6				x	x	x	x	x	x	x
	10					x	x	x	x	x	x
	13						x	x	x	x	x
	16							x	x	x	x
	20								x	x	x
	25									x	x
	32										x
40											

Overload Selectivity FAZ

FAZ-B(C)(D) to AZ-C

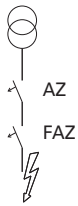

Upstream side AZ, Characteristic C
Downstream side FAZ, Characteristic B, C, D

x ... Selectivity range (i.e. only the downstream switch drops in case $I < I_g$)

Upstream side →		AZ Characteristic C									
Type B rated current I_n [A]		20	25	32	40	50	63	80	100	125	
Selectivity limiting current I_g [A]		130	163	208	260	325	410	520	650	813	
Downstream side FAZ Characteristic B	2	x	x	x	x	x	x	x	x	x	x
	3	x	x	x	x	x	x	x	x	x	x
	4	x	x	x	x	x	x	x	x	x	x
	6	x	x	x	x	x	x	x	x	x	x
	10	x	x	x	x	x	x	x	x	x	x
	13	x	x	x	x	x	x	x	x	x	x
	16	x	x	x	x	x	x	x	x	x	x
	20		x	x	x	x	x	x	x	x	x
	25			x	x	x	x	x	x	x	x
	32				x	x	x	x	x	x	x
	40					x	x	x	x	x	x
	50						x	x	x	x	x
63							x	x	x	x	

Upstream side →		AZ Characteristic C									
Type B rated current I_n [A]		20	25	32	40	50	63	80	100	125	
Selectivity limiting current I_g [A]		130	163	208	260	325	410	520	650	813	
Downstream side FAZ Characteristic C	0.5	x	x	x	x	x	x	x	x	x	x
	1	x	x	x	x	x	x	x	x	x	x
	2	x	x	x	x	x	x	x	x	x	x
	3	x	x	x	x	x	x	x	x	x	x
	4	x	x	x	x	x	x	x	x	x	x
	6	x	x	x	x	x	x	x	x	x	x
	8	x	x	x	x	x	x	x	x	x	x
	10	x	x	x	x	x	x	x	x	x	x
	13	x	x	x	x	x	x	x	x	x	x
	16	x	x	x	x	x	x	x	x	x	x
	20		x	x	x	x	x	x	x	x	x
	25			x	x	x	x	x	x	x	x
	32				x	x	x	x	x	x	x
	40					x	x	x	x	x	x
50						x	x	x	x	x	
63							x	x	x	x	

Upstream side →		AZ Characteristic C									
Type B rated current I_n [A]		20	25	32	40	50	63	80	100	125	
Selectivity limiting current I_g [A]		130	163	208	260	325	410	520	650	813	
Downstream side FAZ Characteristic D	2	x	x	x	x	x	x	x	x	x	x
	4	x	x	x	x	x	x	x	x	x	x
	6	x	x	x	x	x	x	x	x	x	x
	10	x	x	x	x	x	x	x	x	x	x
	13		x	x	x	x	x	x	x	x	x
	16			x	x	x	x	x	x	x	x
	20				x	x	x	x	x	x	x
	25					x	x	x	x	x	x
	32						x	x	x	x	x
	40							x	x	x	x

Overload Selectivity FAZ

FAZ-B(C)(D) to AZ-D

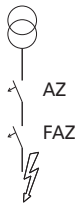

Upstream side AZ, Characteristic D
Downstream side FAZ, Characteristic B, C, D

x ... Selectivity range (i.e. only the downstream switch drops in case $I < I_g$)

Upstream side →		AZ Characteristic D							
Type B rated current I_n [A]		20	25	32	40	50	63	80	100
Selectivity limiting current I_g [A]		230	285	365	450	550	680	850	1020
Downstream side FAZ Characteristic B	2	x	x	x	x	x	x	x	x
	3	x	x	x	x	x	x	x	x
	4	x	x	x	x	x	x	x	x
	6	x	x	x	x	x	x	x	x
	10	x	x	x	x	x	x	x	x
	13	x	x	x	x	x	x	x	x
	16	x	x	x	x	x	x	x	x
	20		x	x	x	x	x	x	x
	25			x	x	x	x	x	x
	32				x	x	x	x	x
	40					x	x	x	x
	50						x	x	x
	63							x	x

Upstream side →		AZ Characteristic D							
Type B rated current I_n [A]		20	25	32	40	50	63	80	100
Selectivity limiting current I_g [A]		230	285	365	450	550	680	850	1020
Downstream side FAZ Characteristic C	0.5	x	x	x	x	x	x	x	x
	1	x	x	x	x	x	x	x	x
	2	x	x	x	x	x	x	x	x
	3	x	x	x	x	x	x	x	x
	4	x	x	x	x	x	x	x	x
	6	x	x	x	x	x	x	x	x
	8	x	x	x	x	x	x	x	x
	10	x	x	x	x	x	x	x	x
	13	x	x	x	x	x	x	x	x
	16	x	x	x	x	x	x	x	x
	20		x	x	x	x	x	x	x
	25			x	x	x	x	x	x
	32				x	x	x	x	x
	40					x	x	x	x
	50						x	x	x
63							x	x	

Upstream side →		AZ Characteristic D							
Type B rated current I_n [A]		20	25	32	40	50	63	80	100
Selectivity limiting current I_g [A]		230	285	365	450	550	680	850	1020
Downstream side FAZ Characteristic D	2	x	x	x	x	x	x	x	x
	4	x	x	x	x	x	x	x	x
	6	x	x	x	x	x	x	x	x
	10	x	x	x	x	x	x	x	x
	13	x	x	x	x	x	x	x	x
	16	x	x	x	x	x	x	x	x
	20		x	x	x	x	x	x	x
	25			x	x	x	x	x	x
	32				x	x	x	x	x
40					x	x	x	x	

Influence of the Line Frequency FAZ

On the Instantaneous Tripping Current I_{MA}

	Line Frequency f [Hz]						
	16 ² / ₃	50	60	100	200	300	400
$I_{MA}(f)/I_{MA}(50\text{Hz})$ [%]	91	100	101	106	115	134	141

Miniature Circuit Breakers FAZ-T

SG56012



FAZ-T

- High-quality miniature circuit breakers for industrial and commercial applications
- Contact position indicator red - green
- Accessories suitable for subsequent installation
- Rated currents up to 40 A
- Tripping characteristics B, C, D
- Rated breaking capacity up to 25 kA according to EN 60947-2

FAZ-T Miniature Circuit Breakers (MCBs)

Characteristic B

Rated current I_n (A)	Rated voltage IEC/EN 60898-1 (V)	Breaking capacity acc. to IEC/EN 60898-1 (kA)	Rated voltage IEC/EN 60947-2 (V)	Breaking capacity acc. to IEC/EN 60947-2 (kA)	Type Designation	Article No.	Units per package
----------------------------	---	---	---	---	---------------------	-------------	-------------------------

SG53212



1-pole

1	240/415	15	240	25	FAZT-B1/1	240770	12/120
2	240/415	15	240	25	FAZT-B2/1	240771	12/120
3	240/415	15	240	25	FAZT-B3/1	240772	12/120
4	240/415	15	240	25	FAZT-B4/1	240777	12/120
6	240/415	15	240	25	FAZT-B6/1	240782	12/120
10	240/415	15	240	25	FAZT-B10/1	240787	12/120
12	240/415	15	240	25	FAZT-B12/1	240792	12/120
13	240/415	15	240	25	FAZT-B13/1	240793	12/120
15	240/415	15	240	25	FAZT-B15/1	240794	12/120
16	240/415	15	240	25	FAZT-B16/1	240795	12/120
20	240/415	15	240	25	FAZT-B20/1	240796	12/120
25	240/415	15	240	25	FAZT-B25/1	240797	12/120
32	240/415	10	240	20	FAZT-B32/1	141907	12/120
40	240/415	10	240	20	FAZT-B40/1	141908	12/120

SG55412



1+N-pole

1	240	15	240	25	FAZT-B1/1N	240994	1/60
2	240	15	240	25	FAZT-B2/1N	240995	1/60
3	240	15	240	25	FAZT-B3/1N	240996	1/60
4	240	15	240	25	FAZT-B4/1N	240997	1/60
6	240	15	240	25	FAZT-B6/1N	240998	1/60
10	240	15	240	25	FAZT-B10/1N	240999	1/60
12	240	15	240	25	FAZT-B12/1N	241000	1/60
13	240	15	240	25	FAZT-B13/1N	241001	1/60
15	240	15	240	25	FAZT-B15/1N	241005	1/60
16	240	15	240	25	FAZT-B16/1N	241009	1/60
20	240	15	240	25	FAZT-B20/1N	241015	1/60
25	240	15	240	25	FAZT-B25/1N	241019	1/60
32	240	10	240	20	FAZT-B32/1N	142509	1/60
40	240	10	240	20	FAZT-B40/1N	142510	1/60

SG55212



2-pole

1	415	15	240/415	25	FAZT-B1/2	240820	1/60
2	415	15	240/415	25	FAZT-B2/2	240821	1/60
3	415	15	240/415	25	FAZT-B3/2	240822	1/60
4	415	15	240/415	25	FAZT-B4/2	240823	1/60
6	415	15	240/415	25	FAZT-B6/2	240824	1/60
10	415	15	240/415	25	FAZT-B10/2	240825	1/60
12	415	15	240/415	25	FAZT-B12/2	240826	1/60
13	415	15	240/415	25	FAZT-B13/2	240827	1/60
15	415	15	240/415	25	FAZT-B15/2	240828	1/60
16	415	15	240/415	25	FAZT-B16/2	240829	1/60
20	415	15	240/415	25	FAZT-B20/2	240830	1/60
25	415	15	240/415	25	FAZT-B25/2	240831	1/60
32	415	10	240/415	20	FAZT-B32/2	142485	1/60
40	415	10	240/415	20	FAZT-B40/2	142486	1/60

Rated current I_n (A)	Rated voltage IEC/EN 60898-1 (V)	Breaking capacity acc. to IEC/EN 60898-1 (kA)	Rated voltage IEC/EN 60947-2 (V)	Breaking capacity acc. to IEC/EN 60947-2 (kA)	Type Designation	Article No.	Units per package
----------------------------	---	---	---	---	---------------------	-------------	-------------------------

SG53512



3-pole

1	415	15	240/415	25	FAZT-B1/3	240874	1/40
2	415	15	240/415	25	FAZT-B2/3	240875	1/40
3	415	15	240/415	25	FAZT-B3/3	240876	1/40
4	415	15	240/415	25	FAZT-B4/3	240877	1/40
6	415	15	240/415	25	FAZT-B6/3	240878	1/40
10	415	15	240/415	25	FAZT-B10/3	240879	1/40
12	415	15	240/415	25	FAZT-B12/3	240880	1/40
13	415	15	240/415	25	FAZT-B13/3	240881	1/40
15	415	15	240/415	25	FAZT-B15/3	240882	1/40
16	415	15	240/415	25	FAZT-B16/3	240883	1/40
20	415	15	240/415	25	FAZT-B20/3	240884	1/40
25	415	15	240/415	25	FAZT-B25/3	240885	1/40
32	415	10	240/415	20	FAZT-B32/3	142493	1/40
40	415	10	240/415	20	FAZT-B40/3	142494	1/40

SG55912



3+N-pole

1	415	15	240/415	25	FAZT-B1/3N	241060	1/30
2	415	15	240/415	25	FAZT-B2/3N	241065	1/30
3	415	15	240/415	25	FAZT-B3/3N	241070	1/30
4	415	15	240/415	25	FAZT-B4/3N	241075	1/30
6	415	15	240/415	25	FAZT-B6/3N	241080	1/30
10	415	15	240/415	25	FAZT-B10/3N	241085	1/30
12	415	15	240/415	25	FAZT-B12/3N	241090	1/30
13	415	15	240/415	25	FAZT-B13/3N	241095	1/30
15	415	15	240/415	25	FAZT-B15/3N	241100	1/30
16	415	15	240/415	25	FAZT-B16/3N	241105	1/30
20	415	15	240/415	25	FAZT-B20/3N	241110	1/30
25	415	15	240/415	25	FAZT-B25/3N	241115	1/30
32	415	10	240/415	20	FAZT-B32/3N	142517	1/30
40	415	10	240/415	20	FAZT-B40/3N	142518	1/30

SG56012



4-pole

1	415	15	240/415	25	FAZT-B1/4	240922	1/30
2	415	15	240/415	25	FAZT-B2/4	240927	1/30
3	415	15	240/415	25	FAZT-B3/4	240930	1/30
4	415	15	240/415	25	FAZT-B4/4	240931	1/30
6	415	15	240/415	25	FAZT-B6/4	240932	1/30
10	415	15	240/415	25	FAZT-B10/4	240933	1/30
12	415	15	240/415	25	FAZT-B12/4	240934	1/30
13	415	15	240/415	25	FAZT-B13/4	240935	1/30
15	415	15	240/415	25	FAZT-B15/4	240936	1/30
16	415	15	240/415	25	FAZT-B16/4	240937	1/30
20	415	15	240/415	25	FAZT-B20/4	240938	1/30
25	415	15	240/415	25	FAZT-B25/4	240939	1/30
32	415	10	240/415	20	FAZT-B32/4	142501	1/30
40	415	10	240/415	20	FAZT-B40/4	142502	1/30

FAZ-T Miniature Circuit Breakers (MCBs)

Characteristic C

Rated current I_n (A)	Rated voltage IEC/EN 60898-1 (V)	Breaking capacity acc. to IEC/EN 60898-1 (kA)	Rated voltage IEC/EN 60947-2 (V)	Breaking capacity acc. to IEC/EN 60947-2 (kA)	Type Designation	Article No.	Units per package
----------------------------	---	---	---	---	---------------------	-------------	-------------------------

SG53212



1-pole

1	240/415	15	240	25	FAZT-C1/1	240798	12/120
2	240/415	15	240	25	FAZT-C2/1	240799	12/120
3	240/415	15	240	25	FAZT-C3/1	240800	12/120
4	240/415	15	240	25	FAZT-C4/1	240801	12/120
6	240/415	15	240	25	FAZT-C6/1	240802	12/120
10	240/415	15	240	25	FAZT-C10/1	240803	12/120
12	240/415	15	240	25	FAZT-C12/1	240804	12/120
13	240/415	15	240	25	FAZT-C13/1	240805	12/120
15	240/415	15	240	25	FAZT-C15/1	240806	12/120
16	240/415	15	240	25	FAZT-C16/1	240807	12/120
20	240/415	15	240	25	FAZT-C20/1	240808	12/120
25	240/415	15	240	25	FAZT-C25/1	240809	12/120
32	240/415	10	240	20	FAZT-C32/1	141909	12/120
40	240/415	10	240	20	FAZT-C40/1	142480	12/120

SG55412



1+N-pole

1	240	15	240	25	FAZT-C1/1N	241022	1/60
2	240	15	240	25	FAZT-C2/1N	241023	1/60
3	240	15	240	25	FAZT-C3/1N	241024	1/60
4	240	15	240	25	FAZT-C4/1N	241025	1/60
6	240	15	240	25	FAZT-C6/1N	241026	1/60
10	240	15	240	25	FAZT-C10/1N	241027	1/60
12	240	15	240	25	FAZT-C12/1N	241028	1/60
13	240	15	240	25	FAZT-C13/1N	241029	1/60
15	240	15	240	25	FAZT-C15/1N	241030	1/60
16	240	15	240	25	FAZT-C16/1N	241034	1/60
20	240	15	240	25	FAZT-C20/1N	241038	1/60
25	240	15	240	25	FAZT-C25/1N	241044	1/60
32	240	10	240	20	FAZT-C32/1N	142511	1/60
40	240	10	240	20	FAZT-C40/1N	142512	1/60

SG55212



2-pole

1	415	15	240/415	25	FAZT-C1/2	240832	1/60
2	415	15	240/415	25	FAZT-C2/2	240833	1/60
3	415	15	240/415	25	FAZT-C3/2	240838	1/60
4	415	15	240/415	25	FAZT-C4/2	240843	1/60
6	415	15	240/415	25	FAZT-C6/2	240850	1/60
10	415	15	240/415	25	FAZT-C10/2	240855	1/60
12	415	15	240/415	25	FAZT-C12/2	240858	1/60
13	415	15	240/415	25	FAZT-C13/2	240859	1/60
15	415	15	240/415	25	FAZT-C15/2	240860	1/60
16	415	15	240/415	25	FAZT-C16/2	240861	1/60
20	415	15	240/415	25	FAZT-C20/2	240862	1/60
25	415	15	240/415	25	FAZT-C25/2	240863	1/60
32	415	10	240/415	20	FAZT-C32/2	142487	1/60
40	415	10	240/415	20	FAZT-C40/2	142488	1/60

SG53512



3-pole

	Rated current I_n (A)	Rated voltage IEC/EN 60898-1 (V)	Breaking capacity acc. to IEC/EN 60898-1 (kA)	Rated voltage IEC/EN 60947-2 (V)	Breaking capacity acc. to IEC/EN 60947-2 (kA)	Type Designation	Article No.	Units per package
1	415	15	240/415	25		FAZT-C1/3	240886	1/40
2	415	15	240/415	25		FAZT-C2/3	240887	1/40
3	415	15	240/415	25		FAZT-C3/3	240888	1/40
4	415	15	240/415	25		FAZT-C4/3	240889	1/40
6	415	15	240/415	25		FAZT-C6/3	240890	1/40
10	415	15	240/415	25		FAZT-C10/3	240891	1/40
12	415	15	240/415	25		FAZT-C12/3	240892	1/40
13	415	15	240/415	25		FAZT-C13/3	240893	1/40
15	415	15	240/415	25		FAZT-C15/3	240894	1/40
16	415	15	240/415	25		FAZT-C16/3	240895	1/40
20	415	15	240/415	25		FAZT-C20/3	240896	1/40
25	415	15	240/415	25		FAZT-C25/3	240897	1/40
32	415	10	240/415	20		FAZT-C32/3	142495	1/40
40	415	10	240/415	20		FAZT-C40/3	142496	1/40

SG55912



3+N-pole

1	415	15	240/415	25		FAZT-C1/3N	241120	1/30
2	415	15	240/415	25		FAZT-C2/3N	241125	1/30
3	415	15	240/415	25		FAZT-C3/3N	241130	1/30
4	415	15	240/415	25		FAZT-C4/3N	241135	1/30
6	415	15	240/415	25		FAZT-C6/3N	241140	1/30
10	415	15	240/415	25		FAZT-C10/3N	241145	1/30
12	415	15	240/415	25		FAZT-C12/3N	241150	1/30
13	415	15	240/415	25		FAZT-C13/3N	241155	1/30
15	415	15	240/415	25		FAZT-C15/3N	241160	1/30
16	415	15	240/415	25		FAZT-C16/3N	241165	1/30
20	415	15	240/415	25		FAZT-C20/3N	241170	1/30
25	415	15	240/415	25		FAZT-C25/3N	241175	1/30
32	415	10	240/415	20		FAZT-C32/3N	142519	1/30
40	415	10	240/415	20		FAZT-C40/3N	142520	1/30

SG56012



4-pole

1	415	15	240/415	25		FAZT-C1/4	240940	1/30
2	415	15	240/415	25		FAZT-C2/4	240941	1/30
3	415	15	240/415	25		FAZT-C3/4	240945	1/30
4	415	15	240/415	25		FAZT-C4/4	240949	1/30
6	415	15	240/415	25		FAZT-C6/4	240955	1/30
10	415	15	240/415	25		FAZT-C10/4	240959	1/30
12	415	15	240/415	25		FAZT-C12/4	240962	1/30
13	415	15	240/415	25		FAZT-C13/4	240963	1/30
15	415	15	240/415	25		FAZT-C15/4	240964	1/30
16	415	15	240/415	25		FAZT-C16/4	240965	1/30
20	415	15	240/415	25		FAZT-C20/4	240966	1/30
25	415	15	240/415	25		FAZT-C25/4	240967	1/30
32	415	10	240/415	20		FAZT-C32/4	142503	1/30
40	415	10	240/415	20		FAZT-C40/4	142504	1/30

FAZ-T Miniature Circuit Breakers (MCBs)

Characteristic D

	Rated current I_n (A)	Rated voltage IEC/EN 60898-1 (V)	Breaking capacity acc. to IEC/EN 60898-1 (kA)	Rated voltage IEC/EN 60947-2 (V)	Breaking capacity acc. to IEC/EN 60947-2 (kA)	Type Designation	Article No.	Units per package
1-pole								
1	240/415	15	240	25	FAZT-D1/1	240810	12/120	
2	240/415	15	240	25	FAZT-D2/1	240811	12/120	
3	240/415	15	240	25	FAZT-D3/1	240812	12/120	
4	240/415	15	240	25	FAZT-D4/1	240813	12/120	
6	240/415	15	240	25	FAZT-D6/1	240814	12/120	
10	240/415	15	240	25	FAZT-D10/1	240815	12/120	
12	240/415	15	240	25	FAZT-D12/1	240816	12/120	
13	240/415	15	240	25	FAZT-D13/1	240817	12/120	
15	240/415	15	240	20	FAZT-D15/1	240818	12/120	
16	240/415	15	240	20	FAZT-D16/1	240819	12/120	
20	240/415	10	240	20	FAZT-D20/1	142481	12/120	
25	240/415	10	240	15	FAZT-D25/1	142482	12/120	
32	240/415	10	240	15	FAZT-D32/1	142483	12/120	
40	240/415	10	240	15	FAZT-D40/1	142484	12/120	
1+N-pole								
1	240	15	240	25	FAZT-D1/1N	241048	1/60	
2	240	15	240	25	FAZT-D2/1N	241051	1/60	
3	240	15	240	25	FAZT-D3/1N	241052	1/60	
4	240	15	240	25	FAZT-D4/1N	241053	1/60	
6	240	15	240	25	FAZT-D6/1N	241054	1/60	
10	240	15	240	25	FAZT-D10/1N	241055	1/60	
12	240	15	240	25	FAZT-D12/1N	241056	1/60	
13	240	15	240	25	FAZT-D13/1N	241057	1/60	
15	240	15	240	20	FAZT-D15/1N	241058	1/60	
16	240	15	240	20	FAZT-D16/1N	241059	1/60	
20	240	10	240	20	FAZT-D20/1N	142513	1/60	
25	240	10	240	15	FAZT-D25/1N	142514	1/60	
32	240	10	240	15	FAZT-D32/1N	142515	1/60	
40	240	10	240	15	FAZT-D40/1N	142516	1/60	
2-pole								
1	415	15	240/415	25	FAZT-D1/2	240864	1/60	
2	415	15	240/415	25	FAZT-D2/2	240865	1/60	
3	415	15	240/415	25	FAZT-D3/2	240866	1/60	
4	415	15	240/415	25	FAZT-D4/2	240867	1/60	
6	415	15	240/415	25	FAZT-D6/2	240868	1/60	
10	415	15	240/415	25	FAZT-D10/2	240869	1/60	
12	415	15	240/415	25	FAZT-D12/2	240870	1/60	
13	415	15	240/415	25	FAZT-D13/2	240871	1/60	
15	415	15	240/415	20	FAZT-D15/2	240872	1/60	
16	415	15	240/415	20	FAZT-D16/2	240873	1/60	
20	415	10	240/415	20	FAZT-D20/2	142489	1/60	
25	415	10	240/415	15	FAZT-D25/2	142490	1/60	
32	415	10	240/415	15	FAZT-D32/2	142491	1/60	
40	415	10	240/415	15	FAZT-D40/2	142492	1/60	

SG53212



SG55412



SG55212



Rated current I_n (A)	Rated voltage IEC/EN 60898-1 (V)	Breaking capacity acc. to IEC/EN 60898-1 (kA)	Rated voltage IEC/EN 60947-2 (V)	Breaking capacity acc. to IEC/EN 60947-2 (kA)	Type Designation	Article No.	Units per package
----------------------------	---	---	---	---	---------------------	-------------	-------------------------

SG53512



3-pole

1	415	15	240/415	25	FAZT-D1/3	240898	1/40
2	415	15	240/415	25	FAZT-D2/3	240899	1/40
3	415	15	240/415	25	FAZT-D3/3	240900	1/40
4	415	15	240/415	25	FAZT-D4/3	240901	1/40
6	415	15	240/415	25	FAZT-D6/3	240902	1/40
10	415	15	240/415	25	FAZT-D10/3	240903	1/40
12	415	15	240/415	25	FAZT-D12/3	240904	1/40
13	415	15	240/415	25	FAZT-D13/3	240905	1/40
15	415	15	240/415	25	FAZT-D15/3	240910	1/40
16	415	15	240/415	25	FAZT-D16/3	240915	1/40
20	415	10	240/415	20	FAZT-D20/3	142497	1/40
25	415	10	240/415	15	FAZT-D25/3	142498	1/40
32	415	10	240/415	15	FAZT-D32/3	142499	1/40
40	415	10	240/415	15	FAZT-D40/3	142500	1/40

SG55912



3+N-pole

1	415	15	240/415	25	FAZT-D1/3N	241180	1/30
2	415	15	240/415	25	FAZT-D2/3N	241181	1/30
3	415	15	240/415	25	FAZT-D3/3N	241182	1/30
4	415	15	240/415	25	FAZT-D4/3N	241183	1/30
6	415	15	240/415	25	FAZT-D6/3N	241184	1/30
10	415	15	240/415	25	FAZT-D10/3N	241185	1/30
12	415	15	240/415	25	FAZT-D12/3N	241186	1/30
13	415	15	240/415	25	FAZT-D13/3N	241187	1/30
15	415	15	240/415	25	FAZT-D15/3N	241188	1/30
16	415	15	240/415	25	FAZT-D16/3N	241189	1/30
20	415	10	240/415	20	FAZT-D20/3N	142521	1/30
25	415	10	240/415	15	FAZT-D25/3N	142522	1/30
32	415	10	240/415	15	FAZT-D32/3N	142523	1/30
40	415	10	240/415	15	FAZT-D40/3N	142524	1/30

SG56012



4-pole

1	415	15	240/415	25	FAZT-D1/4	240968	1/30
2	415	15	240/415	25	FAZT-D2/4	240969	1/30
3	415	15	240/415	25	FAZT-D3/4	240970	1/30
4	415	15	240/415	25	FAZT-D4/4	240971	1/30
6	415	15	240/415	25	FAZT-D6/4	240975	1/30
10	415	15	240/415	25	FAZT-D10/4	240979	1/30
12	415	15	240/415	25	FAZT-D12/4	240985	1/30
13	415	15	240/415	25	FAZT-D13/4	240989	1/30
15	415	15	240/415	25	FAZT-D15/4	240992	1/30
16	415	15	240/415	25	FAZT-D16/4	240993	1/30
20	415	10	240/415	20	FAZT-D20/4	142505	1/30
25	415	10	240/415	15	FAZT-D25/4	142506	1/30
32	415	10	240/415	15	FAZT-D32/4	142507	1/30
40	415	10	240/415	15	FAZT-D40/4	142508	1/30

Specifications FAZ-T

Technical data

	FAZ-T
Productstandard	IEC/EN 60947-2 IEC/EN 60898-1
Number of poles	1, 1p+N, 2, 3, 3p+N, 4

Mechanical specifications

Device width	17.7 mm (1p), 27 mm (1p+N), 36 mm (2p), 54 mm (3p), 72mm (3p+N), 72 mm (4p)
Frame size	45 mm
Socket size	80 mm
Device depth	60 mm
Terminals	lift terminal
Terminal capacity rigid solid/stranded wire	1-25 mm ²
Terminal screw	M5 (with slotted screw acc. to EN ISO 4757-Z2, PZ2)
Terminal torque	max. 2.4 Nm
Snap on fixing	tristable (on DIN rail acc. to EN 50022)
Finger proof	acc. to VBG4, ÖVE EN-6
Degree of Protection (DIN VDE 0470)	
Surface mounted	IP 20
Built-in behind panel	IP 40
Contact position indicator	red / green

Electrical specifications

Rated voltage	U_n	240/415Vac 60Vdc per pole
Rated current	I_n	Type B, C, D: 1, 2, 3, 4, 6, 10, 12, 13, 15, 16, 20, 25, 32, 40 A
Rated insulation voltage	U_i	440 V
Rated impulse withstand voltage	U_{imp}	4 kV (1.2/50) μ sec

Tripping characteristic

Conventional non-tripping current	I_{nt}	$1.13 I_n$
Conventional tripping current	I_t	$1.45 I_n$
Reference temperature		30 °C
Temperature factor		0.4% /K
Instantaneous tripping current	I_{mt}	type B: $3 I_n < I_{mt} = 5 I_n \cdot t (I_{mt}) < 0.1 \text{ sec}$ type C: $5 I_n < I_{mt} = 10 I_n \cdot t (I_{mt}) < 0.1 \text{ sec}$ type D: $10 I_n < I_{mt} = 20 I_n \cdot t (I_{mt}) < 0.1 \text{ sec}$

Rated ultimate short-circuit braking capacity I_{cu} (IEC/EN 60947-2)		type B 1-25 A: 25 kA, 32-40 A: 20 kA type C 1-25 A: 25 kA, 32-40 A: 20 kA type D 1p/1p+N/2p - 1-13 A: 25 kA, 15-20 A: 20 kA, 25-40 A: 15 kA 3p/3p+N/4p - 1-16 A: 25 kA, 20 A: 20 kA, 25-40 A: 15 kA
---	--	--

Rated service short-circuit braking capacity I_{cs} (IEC/EN 60947-2)		for $I_{cu} = 25 \text{ kA} \rightarrow I_{cs} = 12.5 \text{ kA}$ for $I_{cu} = 20 \text{ kA} \rightarrow I_{cs} = 10 \text{ kA}$ for $I_{cu} = 15 \text{ kA} \rightarrow I_{cs} = 7.5 \text{ kA}$
--	--	--

Rated short-circuit braking capacity I_{cn} (IEC/EN 60898-1)		type B 1-25 A: 15 kA, 32-40 A: 10 kA type C 1-25 A: 15 kA, 32-40 A: 10 kA type D 1-16 A: 15 kA, 20-40 A: 10 kA
--	--	--

Selectivity class		3 (acc. to EN 60898)
Number of electrical operations		> 4000 (IEC/EN 60898)
Number of mechanical operations		> 10000 (IEC/EN 60947)
Climatic conditions		acc. to IEC 68-2 (25..55°C / 90..95% RH)
Operating temperature range		-40°C to +75°C

Connection diagram

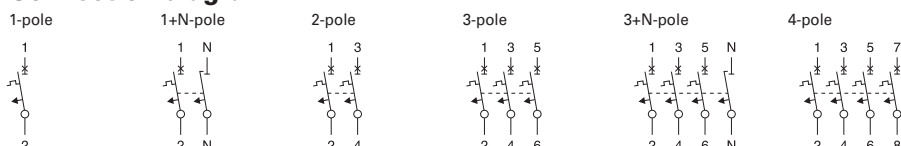

Dimensions (mm) FAZ-T

1-pole

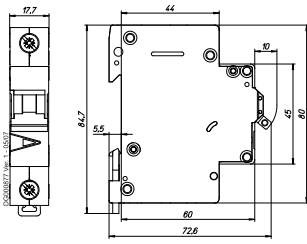

1+N-pole

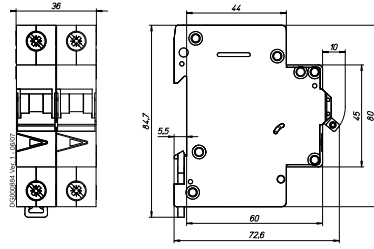

2-pole

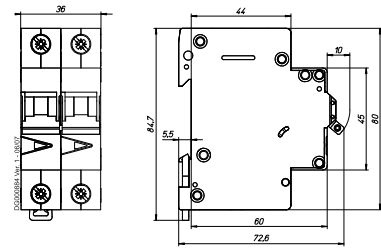

3-pole

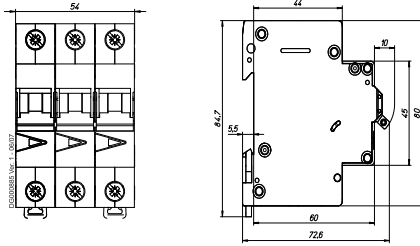

3+N-pole, 4-pole

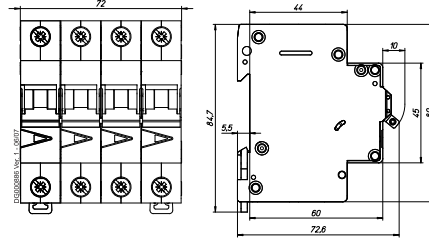

Tripping Characteristic FAZ-T

Characteristics B, C and D - EN60898

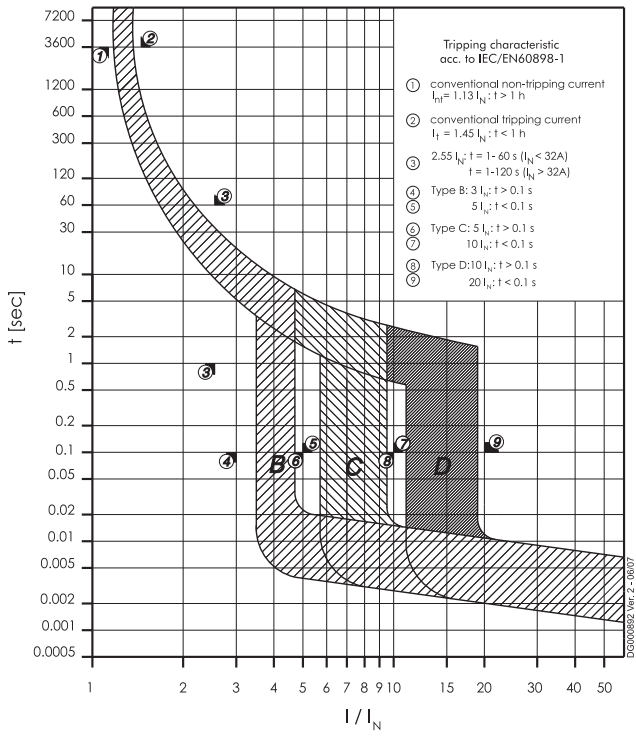

Power Loss at I_n FAZ-T

Type B

	1p	1pN	2p	3p	3pN*	4p
I_n [A]	P [W]	P [W]	P [W]	P [W]	P [W]	P [W]
1	1.6	1.7	3.1	4.7	4.8	6.3
2	1.4	1.5	2.8	4.1	4.3	5.5
3	2.5	2.7	5.0	7.6	7.8	10.1
4	1.4	1.6	2.9	4.4	4.5	5.8
6	1.8	2.0	3.6	5.5	5.6	7.3
10	1.9	2.1	3.9	5.9	6.1	7.8
12	2.8	3.2	5.9	8.7	9.0	11.5
13	2.5	2.9	5.3	7.8	8.1	10.3
15	2.1	2.4	4.4	6.5	6.7	8.6
16	2.2	2.6	4.7	6.9	7.2	9.1
20	3.2	3.6	6.6	9.8	10.1	13.0
25	3.0	3.5	6.4	9.4	9.7	12.4
32	3.7	4.4	8.1	12.1	12.5	15.8
40	3.4	4.1	7.5	11.2	11.5	14.6

*symmetrical load

Type C

	1p	1pN	2p	3p	3pN*	4p
I_n [A]	P [W]	P [W]	P [W]	P [W]	P [W]	P [W]
1	1.6	1.7	3.1	4.7	4.8	6.3
2	1.4	1.5	2.8	4.1	4.3	5.5
3	1.2	1.3	2.4	3.6	3.7	4.8
4	1.4	1.6	2.9	4.4	4.5	5.8
6	1.5	1.6	2.9	4.4	4.6	5.9
10	1.5	1.7	3.0	4.6	4.7	6.1
12	2.1	2.4	4.4	6.5	6.8	8.6
13	2.5	2.9	5.3	7.8	8.1	10.3
15	2.1	2.4	4.4	6.5	6.7	8.6
16	2.2	2.6	4.7	6.9	7.2	9.1
20	3.2	3.6	6.6	9.8	10.1	13.0
25	3.0	3.5	6.4	9.4	9.7	12.4
32	3.7	4.4	8.1	12.1	12.5	15.8
40	3.4	4.1	7.5	11.2	11.5	14.6

*symmetrical load

Type D

	1p	1pN	2p	3p	3pN*	4p
I_n [A]	P [W]	P [W]	P [W]	P [W]	P [W]	P [W]
1	0.8	0.9	1.6	2.4	2.5	3.2
2	1.0	1.1	2.0	3.0	3.1	4.0
3	1.2	1.3	2.4	3.6	3.7	4.8
4	1.4	1.6	2.9	4.4	4.5	5.8
6	1.5	1.6	2.9	4.4	4.6	5.9
10	1.5	1.7	3.0	4.6	4.7	6.1
12	1.7	2.0	3.6	5.3	5.4	7.0
13	1.9	2.2	4.0	5.9	6.1	7.8
15	2.1	2.4	4.4	6.5	6.7	8.6
16	2.2	2.6	4.7	6.9	7.2	9.1
20	2.0	2.2	4.1	6.1	6.2	8.1
25	2.5	2.9	5.2	7.7	7.9	10.2
32	3.4	4.0	7.4	11.1	11.4	14.5
40	3.2	3.8	7.0	10.4	10.7	13.6

*symmetrical load

Influence of Ambient Temperature FAZ-T

On Load Carrying Capacity (temperature derating)

I_N [A]	Ambient temperature T [°C]																
	-40	-30	-20	-10	0	10	20	30	35	40	45	50	55	60	65	70	75
1	1.3	1.2	1.2	1.2	1.1	1.1	1	1	0.99	0.97	0.95	0.93	0.9	0.89	0.87	0.85	0.83
2	2.6	2.5	2.4	2.3	2.2	2.2	2.1	2	2	1.9	1.9	1.9	1.8	1.8	1.7	1.7	1.7
3	3.8	3.7	3.6	3.5	3.4	3.3	3.1	3	3	2.9	2.8	2.8	2.7	2.7	2.6	2.5	2.5
4	5.1	5	4.8	4.7	4.5	4.3	4.2	4	3.9	3.9	3.8	3.7	3.6	3.5	3.5	3.4	3.3
6	7.7	7.5	7.2	7	6.7	6.5	6.3	6	5.9	5.8	5.7	5.6	5.4	5.3	5.2	5.1	5
10	13	12	12	12	11	11	10	10	9.9	9.7	9.5	9.3	9	8.9	8.7	8.5	8.3
12	15	15	14	14	13	13	13	12	12	12	11	11	11	11	10	10	10
13	17	16	16	15	15	14	14	13	13	13	12	12	12	12	11	11	11
15	19	19	18	17	17	16	16	15	15	15	14	14	14	13	13	13	12
16	20	20	19	19	18	17	17	16	16	15	15	15	14	14	14	14	13
20	26	25	24	23	22	22	21	20	20	19	19	19	18	18	17	17	17
25	32	31	30	29	28	27	26	25	25	24	24	23	23	22	22	21	21
32	41	40	38	37	36	35	33	32	32	31	30	30	29	28	28	27	26
40	51	50	48	47	45	43	42	40	39	39	38	37	36	35	35	34	33

Maximum Let-Through Energy FAZ-T

Type B

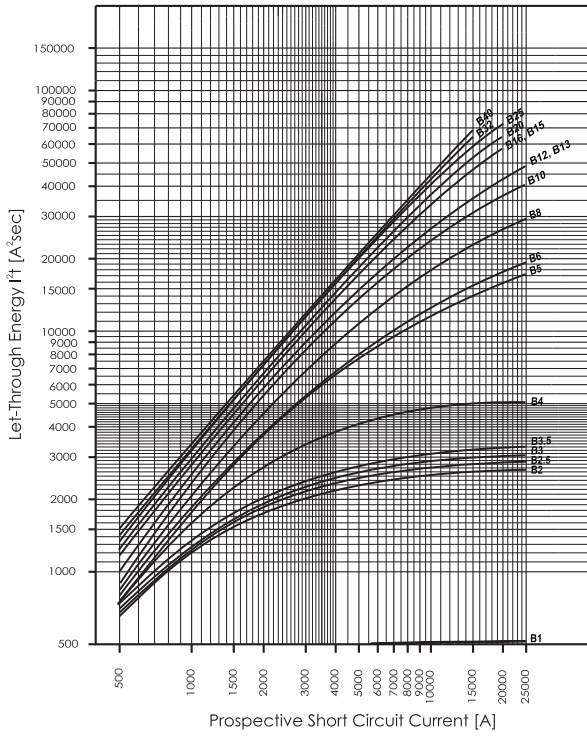

Type C

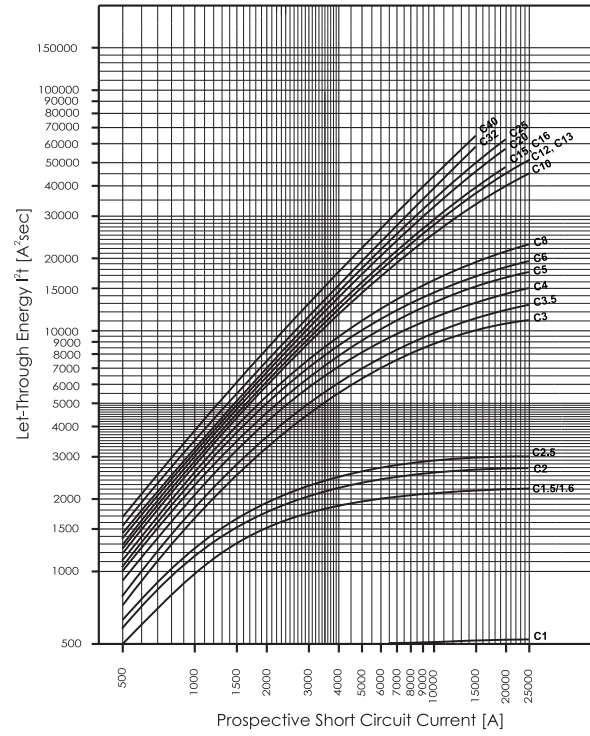

Type D

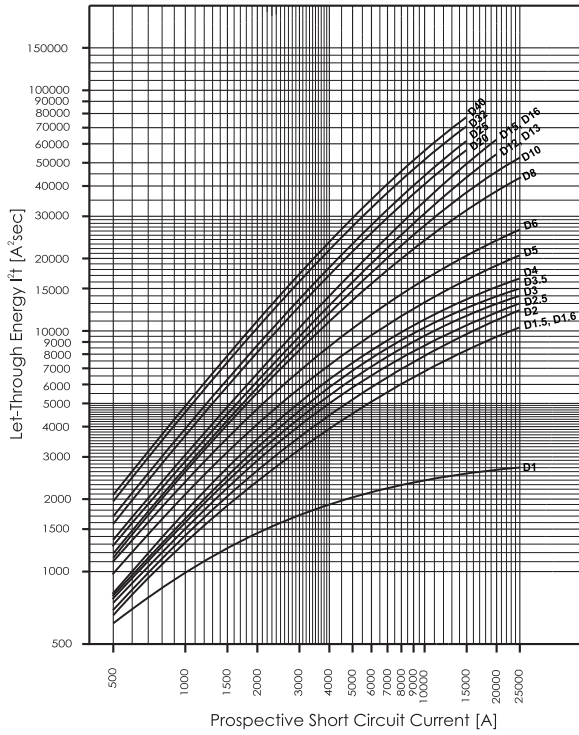

Maximum Let-Through Current FAZ-T

Type B

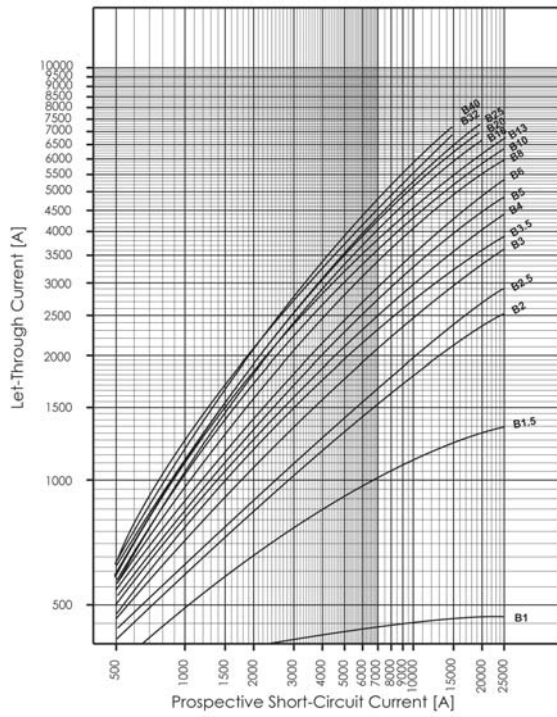

Type C

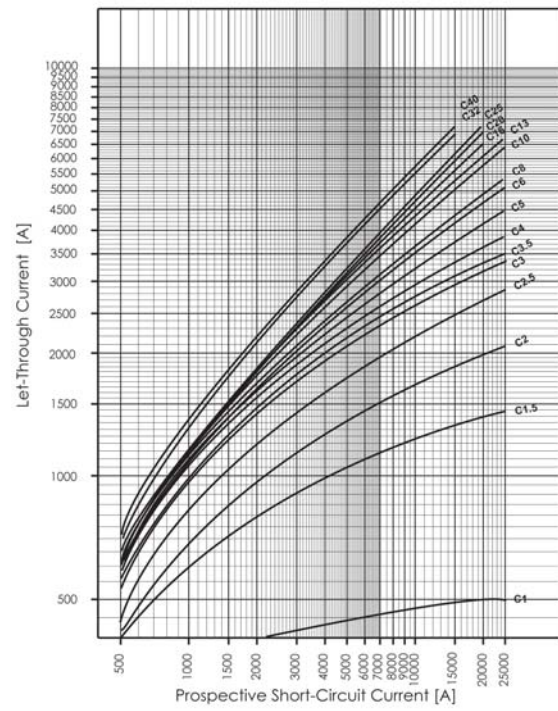

Type D

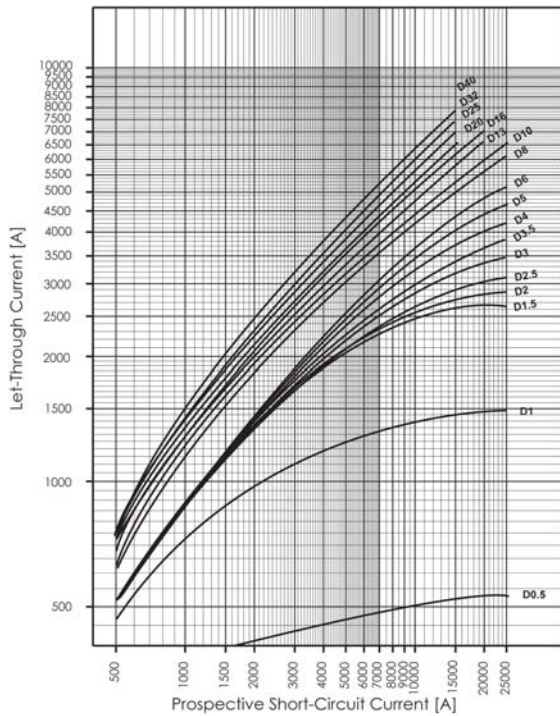

Influence of the Line Frequency FAZ-T

On the Instantaneous Tripping Current I_{MA}

	Line Frequency f [Hz]						
	$16\frac{2}{3}$	50	60	100	200	300	400
$I_{MA}(f)/I_{MA}(50\text{Hz})$ [%]	91	100	101	106	115	134	141

Load rating in case of circuit breakers arranged one next to the other FAZ-T

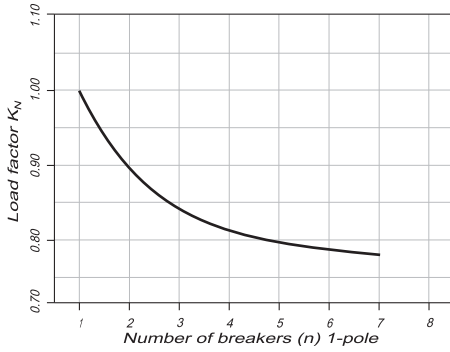

Miniature Circuit Breakers FAZ-DC

SG53312





FAZ-DC

- High-quality miniature circuit breakers for DC-applications
- Contact position indicator red - green
- Guide for secure terminal connection (not for FAZ-NA)
- 3-position DIN rail clip, permits removal from existing busbar system
- Comprehensive range of accessories suitable for subsequent installation
- Rated currents up to 50 A
- Tripping characteristic C
- Rated breaking capacity 10 kA according to IEC/EN 60947-2
- Up to 250 V DC pro pole

FAZ-...-DC Miniature Circuit Breakers (MCBs)

Characteristic C

	Rated current I_n (A)	Rated voltage IEC/EN 60947-2 (V DC)	Breaking capacity acc. to IEC/EN 60947-2 (kA)	Type Designation	Article No.	Units per package
1-pole						
	2	220	10	FAZ-C2/1-DC	279122	12/120
	3	250	10	FAZ-C3/1-DC	279123	12/120
	4	250	10	FAZ-C4/1-DC	279124	12/120
	6	250	10	FAZ-C6/1-DC	279125	12/120
	10	250	10	FAZ-C10/1-DC	279126	12/120
	13	250	10	FAZ-C13/1-DC	279127	12/120
	16	250	10	FAZ-C16/1-DC	279128	12/120
	20	250	10	FAZ-C20/1-DC	279129	12/120
	25	250	10	FAZ-C25/1-DC	279130	12/120
	32	250	10	FAZ-C32/1-DC	279131	12/120
	40	250	10	FAZ-C40/1-DC	279132	12/120
	50	250	10	FAZ-C50/1-DC	279133	12/120
2-pole						
	2	440	10	FAZ-C2/2-DC	279134	1/60
	3	500	10	FAZ-C3/2-DC	279135	1/60
	4	500	10	FAZ-C4/2-DC	279136	1/60
	6	500	10	FAZ-C6/2-DC	279137	1/60
	10	500	10	FAZ-C10/2-DC	279138	1/60
	13	500	10	FAZ-C13/2-DC	279139	1/60
	16	500	10	FAZ-C16/2-DC	279140	1/60
	20	500	10	FAZ-C20/2-DC	279141	1/60
	25	500	10	FAZ-C25/2-DC	279142	1/60
	32	500	10	FAZ-C32/2-DC	279143	1/60
	40	500	10	FAZ-C40/2-DC	279144	1/60
	50	500	10	FAZ-C50/2-DC	279145	1/60

Specifications FAZ-DC

Technical data

	FAZ-DC *)
Productstandard	IEC/EN 60947-2
Number of poles	1, 2

Mechanical specifications

Device width	17.7 mm (1p), 36 mm (2p)
Frame size	45 mm
Socket size	80 mm
Device depth	60 mm
Terminals	lift terminal
Terminal capacity rigid solid/stranded wire	1-25 mm ²
Terminal screw	M5 (with slotted screw acc. to EN ISO 4757-Z2, PZ2)
Terminal torque	max. 2.4 Nm
Snap on fixing	tristable (on DIN rail acc. to EN 50022)
Finger proof	acc. to VBG4, ÖVE EN-6
Degree of Protection (DIN VDE 0470)	
Surface mounted	IP 20
Built-in behind panel	IP 40
Contact position indicator	red / green

Electrical specifications

Rated voltage DC	U_n	2 A type: 220V (per pole) 3-50 A types: 250V (per pole)
Rated current	I_n	Type C: 2, 3, 4, 6, 10, 13, 16, 20, 25, 32, 40, 50 A
Rated insulation voltage	U_i	440 V
Rated impulse withstand voltage	U_{imp}	4 kV (1.2/50)µsec

Tripping characteristic

Conventional non-tripping current		$I_{nt}=1.13 I_n$
Conventional tripping current		$I_t=1.45 I_n$
Reference temperature		30 °C
Temperature factor		0.4% /K
Instantaneous tripping current	I_{mt}	type C: $7 I_n < I_{mt} = 15 I_n$; $t(I_{mt}) < 0.1$ sec
Rated short-circuit braking capacity	I_{cu}	10 kA
Selectivity class		3
Number of electrical operations		> 4000
Number of mechanical operations		> 20000
Climatic conditions		acc. to IEC 68-2 (25..55°C / 90..95% RH)
Operating temperature range		-40°C to +75°C

*) not for PV string protection!

Connection diagram

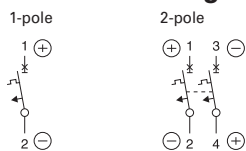

Dimensions (mm) FAZ-...-DC

1-pole

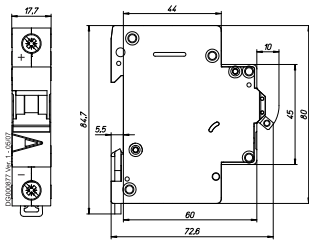

2-pole

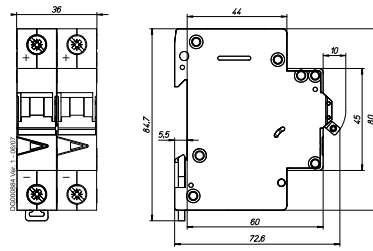

Connection examples FAZ-...-DC

Connection example at 250V=, 1-pole

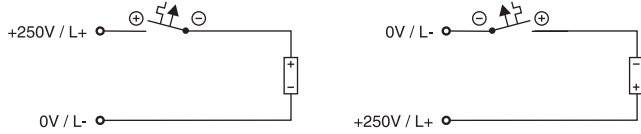

Connection example at 500V=, 2-pole

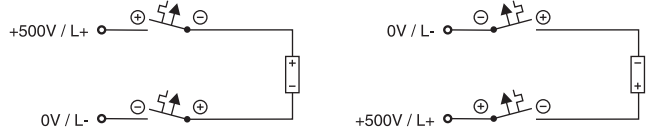

Tripping Characteristic FAZ-...-DC

Characteristics C - IEC/EN 60947-2

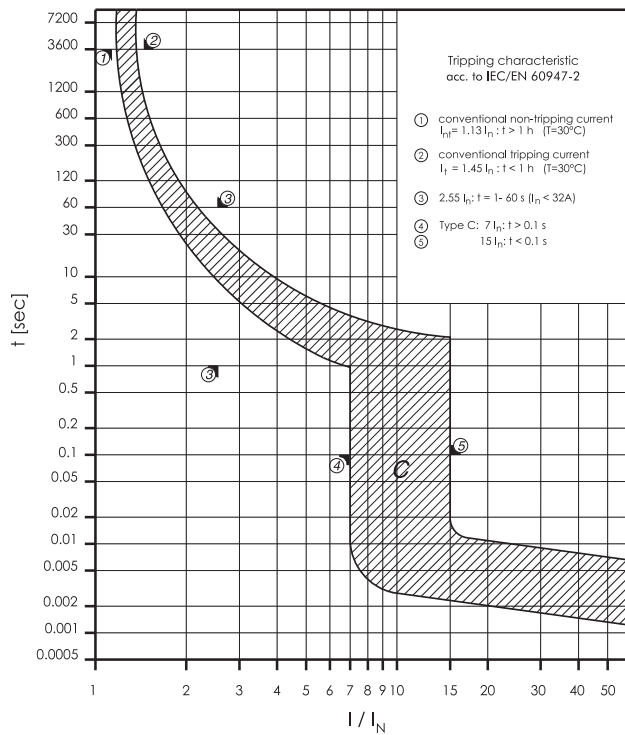

Maximum Let-Through Energy FAZ-...-DC

Type C

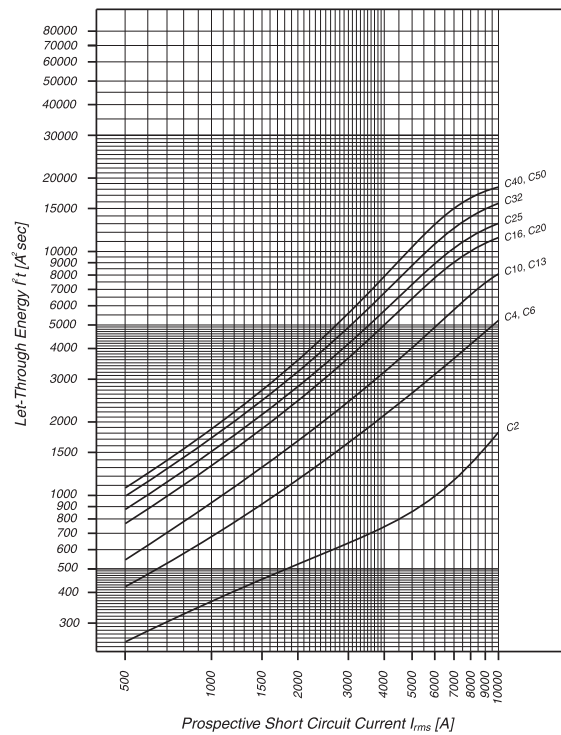

Miniature Circuit Breakers FAZ-NA, FAZ-RT, FAZ-DU

SG56912



FAZ-NA/-RT/-DU

- According to UL 489, CSA C22.2 No. 5 and also IEC 60947-2 standard
- For Applications, which are permitted for UL 1077 or CSA C22.2 No. 235
- Auxiliary switch and voltage trips suitable for subsequent installation
- Series with removable terminal screws (Type FAZ-...-RT/-DU), for use with ring cable lug
- Contact position indicator red - green
- Easy mounting at DIN-rail

FAZ-...-NA Miniature Circuit Breakers (MCBs)

Characteristic B

	Rated current I_n (A)	Rated voltage IEC/EN 60947-2 (V)	Breaking capacity acc. to IEC/EN 60947-2 (kA)	Rated voltage UL489 (V)	Breaking capacity acc. to UL489 (kA)	SWD	NFPA 79	Type Designation	Article No.	Units per package
1-pole										
1	240/415	15	277	10	SWD	AWG 18	FAZ-B1/1-NA	132414	12/120	
1.5	240/415	15	277	10	SWD	AWG 18	FAZ-B1,5/1-NA	132415	12/120	
2	240/415	15	277	10	SWD	AWG 18	FAZ-B2/1-NA	132416	12/120	
3	240/415	15	277	10	SWD	AWG 18	FAZ-B3/1-NA	132417	12/120	
4	240/415	15	277	10	SWD	AWG 18	FAZ-B4/1-NA	132418	12/120	
5	240/415	15	277	10	SWD	AWG 18	FAZ-B5/1-NA	132419	12/120	
6	240/415	15	277	10	SWD	AWG 18	FAZ-B6/1-NA	132680	12/120	
7	240/415	15	277	10	SWD	AWG 18	FAZ-B7/1-NA	132681	12/120	
8	240/415	15	277	10	SWD	AWG 16	FAZ-B8/1-NA	132682	12/120	
10	240/415	15	277	10	SWD	AWG 16	FAZ-B10/1-NA	132683	12/120	
13	240/415	15	277	10	SWD		FAZ-B13/1-NA	132684	12/120	
15	240/415	15	277	14	SWD		FAZ-B15/1-NA	132685	12/120	
16	240/415	15	277	14	SWD		FAZ-B16/1-NA	132686	12/120	
20	240/415	15	277	14	SWD		FAZ-B20/1-NA	132687	12/120	
25	240/415	15	277	14			FAZ-B25/1-NA	132688	12/120	
30	240/415	15	277	10			FAZ-B30/1-NA	132689	12/120	
32	240/415	15	277	10			FAZ-B32/1-NA	132690	12/120	
35	240/415	15	240	10			FAZ-B35/1-NA	132691	12/120	
40	240/415	15	240	10			FAZ-B40/1-NA	132692	12/120	
2-pole										
1	415	15	480Y/277	10	SWD	AWG 18	FAZ-B1/2-NA	132693	1/60	
1.5	415	15	480Y/277	10	SWD	AWG 18	FAZ-B1,5/2-NA	132694	1/60	
2	415	15	480Y/277	10	SWD	AWG 18	FAZ-B2/2-NA	132695	1/60	
3	415	15	480Y/277	10	SWD	AWG 18	FAZ-B3/2-NA	132696	1/60	
4	415	15	480Y/277	10	SWD	AWG 18	FAZ-B4/2-NA	132697	1/60	
5	415	15	480Y/277	10	SWD	AWG 18	FAZ-B5/2-NA	132698	1/60	
6	415	15	480Y/277	10	SWD	AWG 18	FAZ-B6/2-NA	132699	1/60	
7	415	15	480Y/277	10	SWD	AWG 18	FAZ-B7/2-NA	132700	1/60	
8	415	15	480Y/277	10	SWD	AWG 16	FAZ-B8/2-NA	132701	1/60	
10	415	15	480Y/277	10	SWD	AWG 16	FAZ-B10/2-NA	132702	1/60	
13	415	15	480Y/277	10	SWD		FAZ-B13/2-NA	132703	1/60	
15	415	15	480Y/277	14	SWD		FAZ-B15/2-NA	132704	1/60	
16	415	15	480Y/277	14	SWD		FAZ-B16/2-NA	132705	1/60	
20	415	15	480Y/277	14	SWD		FAZ-B20/2-NA	132706	1/60	
25	415	15	480Y/277	14			FAZ-B25/2-NA	132707	1/60	
30	415	15	480Y/277	10			FAZ-B30/2-NA	132708	1/60	
32	415	15	480Y/277	10			FAZ-B32/2-NA	132709	1/60	
35	415	15	240	10			FAZ-B35/2-NA	132710	1/60	
40	415	15	240	10			FAZ-B40/2-NA	132711	1/60	
3-pole										
1	415	15	480Y/277	10	SWD	AWG 18	FAZ-B1/3-NA	132712	1/40	
1.5	415	15	480Y/277	10	SWD	AWG 18	FAZ-B1,5/3-NA	132713	1/40	
2	415	15	480Y/277	10	SWD	AWG 18	FAZ-B2/3-NA	132714	1/40	
3	415	15	480Y/277	10	SWD	AWG 18	FAZ-B3/3-NA	132715	1/40	
4	415	15	480Y/277	10	SWD	AWG 18	FAZ-B4/3-NA	132716	1/40	
5	415	15	480Y/277	10	SWD	AWG 18	FAZ-B5/3-NA	132717	1/40	
6	415	15	480Y/277	10	SWD	AWG 18	FAZ-B6/3-NA	132718	1/40	
7	415	15	480Y/277	10	SWD	AWG 18	FAZ-B7/3-NA	132719	1/40	
8	415	15	480Y/277	10	SWD	AWG 16	FAZ-B8/3-NA	132720	1/40	
10	415	15	480Y/277	10	SWD	AWG 16	FAZ-B10/3-NA	132721	1/40	
13	415	15	480Y/277	10	SWD		FAZ-B13/3-NA	132722	1/40	
15	415	15	480Y/277	14	SWD		FAZ-B15/3-NA	132723	1/40	
16	415	15	480Y/277	14	SWD		FAZ-B16/3-NA	132724	1/40	
20	415	15	480Y/277	14	SWD		FAZ-B20/3-NA	132725	1/40	
25	415	15	480Y/277	14			FAZ-B25/3-NA	132726	1/40	
30	415	15	480Y/277	10			FAZ-B30/3-NA	132727	1/40	
32	415	15	480Y/277	10			FAZ-B32/3-NA	132728	1/40	
35	415	15	240	10			FAZ-B35/3-NA	132729	1/40	
40	415	15	240	10			FAZ-B40/3-NA	132730	1/40	

SG53012



SG56812



SG56912



FAZ...-NA Miniature Circuit Breakers (MCBs)

Characteristic C

	Rated current I_n (A)	Rated voltage IEC/EN 60947-2 (V)	Breaking capacity acc. to IEC/EN 60947-2 (kA)	Rated voltage UL489 (V)	Breaking capacity acc. to UL489 (kA)	SWD	NFPA 79	Type Designation	Article No.	Units per package
1-pole										
	0.5	240/415	15	277	10	SWD	AWG 18	FAZ-C0,5/1-NA	181883	12/120
	1	240/415	15	277	10	SWD	AWG 18	FAZ-C1/1-NA	181885	12/120
	1.5	240/415	15	277	10	SWD	AWG 18	FAZ-C1,5/1-NA	181887	12/120
	2	240/415	15	277	10	SWD	AWG 18	FAZ-C2/1-NA	181889	12/120
	3	240/415	15	277	10	SWD	AWG 18	FAZ-C3/1-NA	181891	12/120
	4	240/415	15	277	10	SWD	AWG 18	FAZ-C4/1-NA	181893	12/120
	5	240/415	15	277	10	SWD	AWG 18	FAZ-C5/1-NA	181895	12/120
	6	240/415	15	277	10	SWD	AWG 18	FAZ-C6/1-NA	181897	12/120
	7	240/415	15	277	10	SWD	AWG 18	FAZ-C7/1-NA	181899	12/120
	8	240/415	15	277	10	SWD	AWG 16	FAZ-C8/1-NA	181901	12/120
	10	240/415	15	277	10	SWD	AWG 16	FAZ-C10/1-NA	181903	12/120
	13	240/415	15	277	10	SWD		FAZ-C13/1-NA	181905	12/120
	15	240/415	15	277	14	SWD		FAZ-C15/1-NA	181907	12/120
	16	240/415	15	277	14	SWD		FAZ-C16/1-NA	181909	12/120
	20	240/415	15	277	14	SWD		FAZ-C20/1-NA	181911	12/120
	25	240/415	15	277	14			FAZ-C25/1-NA	181913	12/120
	30	240/415	15	277	10			FAZ-C30/1-NA	181915	12/120
	32	240/415	15	277	10			FAZ-C32/1-NA	181917	12/120
	35	240/415	15	240	10			FAZ-C35/1-NA	181919	12/120
	40	240/415	15	240	10			FAZ-C40/1-NA	181921	12/120
2-pole										
	0.5	415	15	480Y/277	10	SWD	AWG 18	FAZ-C0,5/2-NA	181923	1/60
	1	415	15	480Y/277	10	SWD	AWG 18	FAZ-C1/2-NA	181925	1/60
	1.5	415	15	480Y/277	10	SWD	AWG 18	FAZ-C1,5/2-NA	181927	1/60
	2	415	15	480Y/277	10	SWD	AWG 18	FAZ-C2/2-NA	181929	1/60
	3	415	15	480Y/277	10	SWD	AWG 18	FAZ-C3/2-NA	181931	1/60
	4	415	15	480Y/277	10	SWD	AWG 18	FAZ-C4/2-NA	181933	1/60
	5	415	15	480Y/277	10	SWD	AWG 18	FAZ-C5/2-NA	181935	1/60
	6	415	15	480Y/277	10	SWD	AWG 18	FAZ-C6/2-NA	181937	1/60
	7	415	15	480Y/277	10	SWD	AWG 18	FAZ-C7/2-NA	181939	1/60
	8	415	15	480Y/277	10	SWD	AWG 16	FAZ-C8/2-NA	181941	1/60
	10	415	15	480Y/277	10	SWD	AWG 16	FAZ-C10/2-NA	181943	1/60
	13	415	15	480Y/277	10	SWD		FAZ-C13/2-NA	181945	1/60
	15	415	15	480Y/277	14	SWD		FAZ-C15/2-NA	181947	1/60
	16	415	15	480Y/277	14	SWD		FAZ-C16/2-NA	181949	1/60
	20	415	15	480Y/277	14	SWD		FAZ-C20/2-NA	181951	1/60
	25	415	15	480Y/277	14			FAZ-C25/2-NA	181953	1/60
	30	415	15	480Y/277	10			FAZ-C30/2-NA	181955	1/60
	32	415	15	480Y/277	10			FAZ-C32/2-NA	181957	1/60
	35	415	15	240	10			FAZ-C35/2-NA	181959	1/60
	40	415	15	240	10			FAZ-C40/2-NA	181961	1/60
3-pole										
	0.5	415	15	480Y/277	10	SWD	AWG 18	FAZ-C0,5/3-NA	181963	1/40
	1	415	15	480Y/277	10	SWD	AWG 18	FAZ-C1/3-NA	181965	1/40
	1.5	415	15	480Y/277	10	SWD	AWG 18	FAZ-C1,5/3-NA	181967	1/40
	2	415	15	480Y/277	10	SWD	AWG 18	FAZ-C2/3-NA	181969	1/40
	3	415	15	480Y/277	10	SWD	AWG 18	FAZ-C3/3-NA	181971	1/40
	4	415	15	480Y/277	10	SWD	AWG 18	FAZ-C4/3-NA	181973	1/40
	5	415	15	480Y/277	10	SWD	AWG 18	FAZ-C5/3-NA	181975	1/40
	6	415	15	480Y/277	10	SWD	AWG 18	FAZ-C6/3-NA	181977	1/40
	7	415	15	480Y/277	10	SWD	AWG 18	FAZ-C7/3-NA	181979	1/40
	8	415	15	480Y/277	10	SWD	AWG 16	FAZ-C8/3-NA	181981	1/40
	10	415	15	480Y/277	10	SWD	AWG 16	FAZ-C10/3-NA	181983	1/40
	13	415	15	480Y/277	10	SWD		FAZ-C13/3-NA	181985	1/40
	15	415	15	480Y/277	14	SWD		FAZ-C15/3-NA	181987	1/40
	16	415	15	480Y/277	14	SWD		FAZ-C16/3-NA	181989	1/40
	20	415	15	480Y/277	14	SWD		FAZ-C20/3-NA	181991	1/40
	25	415	15	480Y/277	14			FAZ-C25/3-NA	181993	1/40
	30	415	15	480Y/277	10			FAZ-C30/3-NA	181995	1/40
	32	415	15	480Y/277	10			FAZ-C32/3-NA	181997	1/40
	35	415	15	240	10			FAZ-C35/3-NA	181999	1/40
	40	415	15	240	10			FAZ-C40/3-NA	182001	1/40

SG53012



SG56812



SG56912



FAZ...-NA Miniature Circuit Breakers (MCBs)

Characteristic D

	Rated current I_n (A)	Rated voltage IEC/EN 60947-2 (V)	Breaking capacity acc. to IEC/EN 60947-2 (kA)	Rated voltage UL489 (V)	Breaking capacity acc. to UL489 (kA)	SWD	NFPA 79	Type Designation	Article No.	Units per package
1-pole										
	0.5	240/415	15	277	10	SWD	AWG 18	FAZ-D0,5/1-NA	182003	12/120
	1	240/415	15	277	10	SWD	AWG 18	FAZ-D1/1-NA	182005	12/120
	1.5	240/415	15	277	10	SWD	AWG 18	FAZ-D1,5/1-NA	182007	12/120
	2	240/415	15	277	10	SWD	AWG 18	FAZ-D2/1-NA	182009	12/120
	3	240/415	15	277	10	SWD	AWG 18	FAZ-D3/1-NA	182011	12/120
	4	240/415	15	277	10	SWD	AWG 18	FAZ-D4/1-NA	182013	12/120
	5	240/415	15	277	10	SWD	AWG 18	FAZ-D5/1-NA	182015	12/120
	6	240/415	15	277	10	SWD	AWG 18	FAZ-D6/1-NA	182017	12/120
	7	240/415	15	277	10	SWD	AWG 18	FAZ-D7/1-NA	182019	12/120
	8	240/415	15	277	10	SWD	AWG 16	FAZ-D8/1-NA	182021	12/120
	10	240/415	15	277	10	SWD	AWG 16	FAZ-D10/1-NA	181831	12/120
	13	240/415	15	277	14	SWD		FAZ-D13/1-NA	181833	12/120
	15	240/415	15	277	14	SWD		FAZ-D15/1-NA	181835	12/120
	16	240/415	15	277	14	SWD		FAZ-D16/1-NA	181837	12/120
	20	240/415	15	277	14	SWD		FAZ-D20/1-NA	181839	12/120
	25	240/415	15	277	10			FAZ-D25/1-NA	181841	12/120
	30	240/415	15	277	10			FAZ-D30/1-NA	182023	12/120
	32	240/415	15	277	10			FAZ-D32/1-NA	182025	12/120
	35	240/415	15	240	10			FAZ-D35/1-NA	182027	12/120
	40	240/415	15	240	10			FAZ-D40/1-NA	182029	12/120
2-pole										
	0.5	415	15	480Y/277	10	SWD	AWG 18	FAZ-D0,5/2-NA	182031	1/60
	1	415	15	480Y/277	10	SWD	AWG 18	FAZ-D1/2-NA	182033	1/60
	1.5	415	15	480Y/277	10	SWD	AWG 18	FAZ-D1,5/2-NA	182035	1/60
	2	415	15	480Y/277	10	SWD	AWG 18	FAZ-D2/2-NA	182037	1/60
	3	415	15	480Y/277	10	SWD	AWG 18	FAZ-D3/2-NA	182039	1/60
	4	415	15	480Y/277	10	SWD	AWG 18	FAZ-D4/2-NA	182041	1/60
	5	415	15	480Y/277	10	SWD	AWG 18	FAZ-D5/2-NA	182043	1/60
	6	415	15	480Y/277	10	SWD	AWG 18	FAZ-D6/2-NA	182045	1/60
	7	415	15	480Y/277	10	SWD	AWG 18	FAZ-D7/2-NA	182047	1/60
	8	415	15	480Y/277	10	SWD	AWG 16	FAZ-D8/2-NA	182049	1/60
	10	415	15	480Y/277	10	SWD	AWG 16	FAZ-D10/2-NA	182051	1/60
	13	415	15	480Y/277	14	SWD		FAZ-D13/2-NA	182053	1/60
	15	415	15	480Y/277	14	SWD		FAZ-D15/2-NA	182055	1/60
	16	415	15	480Y/277	14	SWD		FAZ-D16/2-NA	182057	1/60
	20	415	15	480Y/277	14	SWD		FAZ-D20/2-NA	182059	1/60
	25	415	15	480Y/277	10			FAZ-D25/2-NA	182061	1/60
	30	415	15	480Y/277	10			FAZ-D30/2-NA	182063	1/60
	32	415	15	480Y/277	10			FAZ-D32/2-NA	182065	1/60
	35	415	15	240	10			FAZ-D35/2-NA	182067	1/60
	40	415	15	240	10			FAZ-D40/2-NA	182069	1/60
3-pole										
	0.5	415	15	480Y/277	10	SWD	AWG 18	FAZ-D0,5/3-NA	182071	1/40
	1	415	15	480Y/277	10	SWD	AWG 18	FAZ-D1/3-NA	182073	1/40
	1.5	415	15	480Y/277	10	SWD	AWG 18	FAZ-D1,5/3-NA	182075	1/40
	2	415	15	480Y/277	10	SWD	AWG 18	FAZ-D2/3-NA	182077	1/40
	3	415	15	480Y/277	10	SWD	AWG 18	FAZ-D3/3-NA	182079	1/40
	4	415	15	480Y/277	10	SWD	AWG 18	FAZ-D4/3-NA	182081	1/40
	5	415	15	480Y/277	10	SWD	AWG 18	FAZ-D5/3-NA	182083	1/40
	6	415	15	480Y/277	10	SWD	AWG 18	FAZ-D6/3-NA	182085	1/40
	7	415	15	480Y/277	10	SWD	AWG 18	FAZ-D7/3-NA	182087	1/40
	8	415	15	480Y/277	10	SWD	AWG 16	FAZ-D8/3-NA	182089	1/40
	10	415	15	480Y/277	10	SWD	AWG 16	FAZ-D10/3-NA	182091	1/40
	13	415	15	480Y/277	14	SWD		FAZ-D13/3-NA	182093	1/40
	15	415	15	480Y/277	14	SWD		FAZ-D15/3-NA	182095	1/40
	16	415	15	480Y/277	14	SWD		FAZ-D16/3-NA	182097	1/40
	20	415	15	480Y/277	14	SWD		FAZ-D20/3-NA	182099	1/40
	25	415	15	480Y/277	10			FAZ-D25/3-NA	182101	1/40
	30	415	15	480Y/277	10			FAZ-D30/3-NA	182103	1/40
	32	415	15	480Y/277	10			FAZ-D32/3-NA	182105	1/40
	35	415	15	240	10			FAZ-D35/3-NA	182107	1/40
	40	415	15	240	10			FAZ-D40/3-NA	182109	1/40

SG53012



SG56812



SG56912



FAZ-...-RT/-DU Miniature Circuit Breakers (MCBs)

Characteristic B

	Rated current I_n (A)	Rated voltage IEC/EN 60947-2 (V)	Breaking capacity acc. to IEC/EN 60947-2 (kA)	Rated voltage UL489 (V)	Breaking capacity acc. to UL489 (kA)	SWD	NFPA 79	Type Designation	Article No.	Units per package
1-pole										
1	240/415	15	277	10	SWD	AWG 18	FAZ-B1/1-RT	132731	12/120	
1.5	240/415	15	277	10	SWD	AWG 18	FAZ-B1,5/1-RT	132732	12/120	
2	240/415	15	277	10	SWD	AWG 18	FAZ-B2/1-RT	132733	12/120	
3	240/415	15	277	10	SWD	AWG 18	FAZ-B3/1-RT	132734	12/120	
4	240/415	15	277	10	SWD	AWG 18	FAZ-B4/1-RT	132735	12/120	
5	240/415	15	277	10	SWD	AWG 18	FAZ-B5/1-RT	132736	12/120	
6	240/415	15	277	10	SWD	AWG 18	FAZ-B6/1-RT	132737	12/120	
7	240/415	15	277	10	SWD	AWG 18	FAZ-B7/1-RT	132738	12/120	
8	240/415	15	277	10	SWD	AWG 16	FAZ-B8/1-RT	132739	12/120	
10	240/415	15	277	10	SWD	AWG 16	FAZ-B10/1-RT	132740	12/120	
13	240/415	15	277	10	SWD		FAZ-B13/1-RT	132741	12/120	
15	240/415	15	277	14	SWD		FAZ-B15/1-RT	132742	12/120	
16	240/415	15	277	14	SWD		FAZ-B16/1-RT	132743	12/120	
20	240/415	15	277	14	SWD		FAZ-B20/1-RT	132744	12/120	
25	240/415	15	277	14			FAZ-B25/1-RT	132745	12/120	
30	240/415	15	277	10			FAZ-B30/1-RT	132746	12/120	
32	240/415	15	277	10			FAZ-B32/1-RT	132747	12/120	
35	240/415	15	240	10			FAZ-B35/1-RT	132748	12/120	
40	240/415	15	240	10			FAZ-B40/1-RT	132749	12/120	
2-pole										
1	415	15	480Y/277	10	SWD	AWG 18	FAZ-B1/2-RT	132750	1/60	
1.5	415	15	480Y/277	10	SWD	AWG 18	FAZ-B1,5/2-RT	132751	1/60	
2	415	15	480Y/277	10	SWD	AWG 18	FAZ-B2/2-RT	132752	1/60	
3	415	15	480Y/277	10	SWD	AWG 18	FAZ-B3/2-RT	132753	1/60	
4	415	15	480Y/277	10	SWD	AWG 18	FAZ-B4/2-RT	132754	1/60	
5	415	15	480Y/277	10	SWD	AWG 18	FAZ-B5/2-RT	132755	1/60	
6	415	15	480Y/277	10	SWD	AWG 18	FAZ-B6/2-RT	132756	1/60	
7	415	15	480Y/277	10	SWD	AWG 18	FAZ-B7/2-RT	132757	1/60	
8	415	15	480Y/277	10	SWD	AWG 16	FAZ-B8/2-RT	132758	1/60	
10	415	15	480Y/277	10	SWD	AWG 16	FAZ-B10/2-RT	132759	1/60	
13	415	15	480Y/277	10	SWD		FAZ-B13/2-RT	132760	1/60	
15	415	15	480Y/277	14	SWD		FAZ-B15/2-RT	132761	1/60	
16	415	15	480Y/277	14	SWD		FAZ-B16/2-RT	132762	1/60	
20	415	15	480Y/277	14	SWD		FAZ-B20/2-RT	132763	1/60	
25	415	15	480Y/277	14			FAZ-B25/2-RT	132764	1/60	
30	415	15	480Y/277	10			FAZ-B30/2-RT	132765	1/60	
32	415	15	480Y/277	10			FAZ-B32/2-RT	132766	1/60	
35	415	15	240	10			FAZ-B35/2-RT	132767	1/60	
40	415	15	240	10			FAZ-B40/2-RT	132768	1/60	
3-pole										
1	415	15	480Y/277	10	SWD	AWG 18	FAZ-B1/3-RT	132769	1/40	
1.5	415	15	480Y/277	10	SWD	AWG 18	FAZ-B1,5/3-RT	132770	1/40	
2	415	15	480Y/277	10	SWD	AWG 18	FAZ-B2/3-RT	132771	1/40	
3	415	15	480Y/277	10	SWD	AWG 18	FAZ-B3/3-RT	132772	1/40	
4	415	15	480Y/277	10	SWD	AWG 18	FAZ-B4/3-RT	132773	1/40	
5	415	15	480Y/277	10	SWD	AWG 18	FAZ-B5/3-RT	132774	1/40	
6	415	15	480Y/277	10	SWD	AWG 18	FAZ-B6/3-RT	132775	1/40	
7	415	15	480Y/277	10	SWD	AWG 18	FAZ-B7/3-RT	132776	1/40	
8	415	15	480Y/277	10	SWD	AWG 16	FAZ-B8/3-RT	132777	1/40	
10	415	15	480Y/277	10	SWD	AWG 16	FAZ-B10/3-RT	132778	1/40	
13	415	15	480Y/277	10	SWD		FAZ-B13/3-RT	132779	1/40	
15	415	15	480Y/277	14	SWD		FAZ-B15/3-RT	132780	1/40	
16	415	15	480Y/277	14	SWD		FAZ-B16/3-RT	132781	1/40	
20	415	15	480Y/277	14	SWD		FAZ-B20/3-RT	132782	1/40	
25	415	15	480Y/277	14			FAZ-B25/3-RT	132783	1/40	
30	415	15	480Y/277	10			FAZ-B30/3-RT	132784	1/40	
32	415	15	480Y/277	10			FAZ-B32/3-RT	132785	1/40	
35	415	15	240	10			FAZ-B35/3-RT	132786	1/40	
40	415	15	240	10			FAZ-B40/3-RT	132787	1/40	

SG56412



SG56712



SG57012



FAZ...-RT/-DU Miniature Circuit Breakers (MCBs)

Characteristic C



FAZ-RT has the plastic limiter at both terminals, as showed in red circle; While FAZ-DU doesn't have

SG56412



Rated current I_n (A)	Rated voltage IEC/EN 60947-2 (V)	Breaking capacity acc. to IEC/EN 60947-2 (kA)	Rated voltage UL489 (V)	Breaking capacity acc. to UL489 (kA)	SWD	NFPA 79	RT Type Designation	RT Article No.	DU Type Designation	DU Article No.	Units per package
----------------------------	---	---	-------------------------------	---	-----	---------	------------------------	-------------------	------------------------	-------------------	-------------------------

1-pole

0.5	240/415	15	277	10	SWD	AWG 18	FAZ-C0,5/1-RT	181884	FAZ-C0,5/1-DU	185095	12/120
1	240/415	15	277	10	SWD	AWG 18	FAZ-C1/1-RT	181886	FAZ-C1/1-DU	185096	12/120
1.5	240/415	15	277	10	SWD	AWG 18	FAZ-C1,5/1-RT	181888	FAZ-C1,5/1-DU	185097	12/120
2	240/415	15	277	10	SWD	AWG 18	FAZ-C2/1-RT	181890	FAZ-C2/1-DU	185098	12/120
3	240/415	15	277	10	SWD	AWG 18	FAZ-C3/1-RT	181892	FAZ-C3/1-DU	185099	12/120
4	240/415	15	277	10	SWD	AWG 18	FAZ-C4/1-RT	181894	FAZ-C4/1-DU	185100	12/120
5	240/415	15	277	10	SWD	AWG 18	FAZ-C5/1-RT	181896	FAZ-C5/1-DU	185101	12/120
6	240/415	15	277	10	SWD	AWG 18	FAZ-C6/1-RT	181898	FAZ-C6/1-DU	185102	12/120
7	240/415	15	277	10	SWD	AWG 18	FAZ-C7/1-RT	181900	FAZ-C7/1-DU	185103	12/120
8	240/415	15	277	10	SWD	AWG 16	FAZ-C8/1-RT	181902	FAZ-C8/1-DU	184990	12/120
10	240/415	15	277	10	SWD	AWG 16	FAZ-C10/1-RT	181904	FAZ-C10/1-DU	184991	12/120
13	240/415	15	277	10	SWD		FAZ-C13/1-RT	181906	FAZ-C13/1-DU	184992	12/120
15	240/415	15	277	14	SWD		FAZ-C15/1-RT	181908	FAZ-C15/1-DU	184993	12/120
16	240/415	15	277	14	SWD		FAZ-C16/1-RT	181910	FAZ-C16/1-DU	184994	12/120
20	240/415	15	277	14	SWD		FAZ-C20/1-RT	181912	FAZ-C20/1-DU	184995	12/120
25	240/415	15	277	14			FAZ-C25/1-RT	181914	FAZ-C25/1-DU	184996	12/120
30	240/415	15	277	10			FAZ-C30/1-RT	181916	FAZ-C30/1-DU	184997	12/120
32	240/415	15	277	10			FAZ-C32/1-RT	181918	FAZ-C32/1-DU	184998	12/120
35	240/415	15	240	10			FAZ-C35/1-RT	181920	FAZ-C35/1-DU	184999	12/120
40	240/415	15	240	10			FAZ-C40/1-RT	181922	FAZ-C40/1-DU	185000	12/120

SG56712



2-pole

0.5	415	15	480Y/277	10	SWD	AWG 18	FAZ-C0,5/2-RT	181924	FAZ-C0,5/2-DU	185021	1/60
1	415	15	480Y/277	10	SWD	AWG 18	FAZ-C1/2-RT	181926	FAZ-C1/2-DU	185022	1/60
1.5	415	15	480Y/277	10	SWD	AWG 18	FAZ-C1,5/2-RT	181928	FAZ-C1,5/2-DU	185023	1/60
2	415	15	480Y/277	10	SWD	AWG 18	FAZ-C2/2-RT	181930	FAZ-C2/2-DU	185024	1/60
3	415	15	480Y/277	10	SWD	AWG 18	FAZ-C3/2-RT	181932	FAZ-C3/2-DU	185025	1/60
4	415	15	480Y/277	10	SWD	AWG 18	FAZ-C4/2-RT	181934	FAZ-C4/2-DU	185026	1/60
5	415	15	480Y/277	10	SWD	AWG 18	FAZ-C5/2-RT	181936	FAZ-C5/2-DU	185027	1/60
6	415	15	480Y/277	10	SWD	AWG 18	FAZ-C6/2-RT	181938	FAZ-C6/2-DU	185028	1/60
7	415	15	480Y/277	10	SWD	AWG 18	FAZ-C7/2-RT	181940	FAZ-C7/2-DU	185029	1/60
8	415	15	480Y/277	10	SWD	AWG 16	FAZ-C8/2-RT	181942	FAZ-C8/2-DU	185030	1/60
10	415	15	480Y/277	10	SWD	AWG 16	FAZ-C10/2-RT	181944	FAZ-C10/2-DU	185031	1/60
13	415	15	480Y/277	10	SWD		FAZ-C13/2-RT	181946	FAZ-C13/2-DU	185032	1/60
15	415	15	480Y/277	14	SWD		FAZ-C15/2-RT	181948	FAZ-C15/2-DU	185033	1/60
16	415	15	480Y/277	14	SWD		FAZ-C16/2-RT	181950	FAZ-C16/2-DU	185034	1/60
20	415	15	480Y/277	14	SWD		FAZ-C20/2-RT	181952	FAZ-C20/2-DU	185035	1/60
25	415	15	480Y/277	14			FAZ-C25/2-RT	181954	FAZ-C25/2-DU	185036	1/60
30	415	15	480Y/277	10			FAZ-C30/2-RT	181956	FAZ-C30/2-DU	185037	1/60
32	415	15	480Y/277	10			FAZ-C32/2-RT	181958	FAZ-C32/2-DU	185038	1/60
35	415	15	240	10			FAZ-C35/2-RT	181960	FAZ-C35/2-DU	185039	1/60
40	415	15	240	10			FAZ-C40/2-RT	181962	FAZ-C40/2-DU	185040	1/60

SG57012



3-pole

0.5	415	15	480Y/277	10	SWD	AWG 18	FAZ-C0,5/3-RT	181964	FAZ-C0,5/3-DU	185061	1/40
1	415	15	480Y/277	10	SWD	AWG 18	FAZ-C1/3-RT	181966	FAZ-C1/3-DU	185062	1/40
1.5	415	15	480Y/277	10	SWD	AWG 18	FAZ-C1,5/3-RT	181968	FAZ-C1,5/3-DU	185063	1/40
2	415	15	480Y/277	10	SWD	AWG 18	FAZ-C2/3-RT	181970	FAZ-C2/3-DU	185064	1/40
3	415	15	480Y/277	10	SWD	AWG 18	FAZ-C3/3-RT	181972	FAZ-C3/3-DU	185065	1/40
4	415	15	480Y/277	10	SWD	AWG 18	FAZ-C4/3-RT	181974	FAZ-C4/3-DU	185066	1/40
5	415	15	480Y/277	10	SWD	AWG 18	FAZ-C5/3-RT	181976	FAZ-C5/3-DU	185067	1/40
6	415	15	480Y/277	10	SWD	AWG 18	FAZ-C6/3-RT	181978	FAZ-C6/3-DU	185068	1/40
7	415	15	480Y/277	10	SWD	AWG 18	FAZ-C7/3-RT	181980	FAZ-C7/3-DU	185069	1/40
8	415	15	480Y/277	10	SWD	AWG 16	FAZ-C8/3-RT	181982	FAZ-C8/3-DU	185070	1/40
10	415	15	480Y/277	10	SWD	AWG 16	FAZ-C10/3-RT	181984	FAZ-C10/3-DU	185071	1/40
13	415	15	480Y/277	10	SWD		FAZ-C13/3-RT	181986	FAZ-C13/3-DU	185072	1/40
15	415	15	480Y/277	14	SWD		FAZ-C15/3-RT	181988	FAZ-C15/3-DU	185073	1/40
16	415	15	480Y/277	14	SWD		FAZ-C16/3-RT	181990	FAZ-C16/3-DU	185074	1/40
20	415	15	480Y/277	14	SWD		FAZ-C20/3-RT	181992	FAZ-C20/3-DU	185075	1/40
25	415	15	480Y/277	14			FAZ-C25/3-RT	181994	FAZ-C25/3-DU	185076	1/40
30	415	15	480Y/277	10			FAZ-C30/3-RT	181996	FAZ-C30/3-DU	185077	1/40
32	415	15	480Y/277	10			FAZ-C32/3-RT	181998	FAZ-C32/3-DU	185078	1/40
35	415	15	240	10			FAZ-C35/3-RT	182000	FAZ-C35/3-DU	185079	1/40
40	415	15	240	10			FAZ-C40/3-RT	182002	FAZ-C40/3-DU	185080	1/40

FAZ-...-RT/-DU Miniature Circuit Breakers (MCBs)

Characteristic D

	Rated current I_n (A)	Rated voltage IEC/EN 60947-2 (V)	Breaking capacity acc. to IEC/EN 60947-2 (kA)	Rated voltage UL489 (V)	Breaking capacity acc. to UL489 (kA)	SWD	NFPA 79 AWG	RT Type Designation	RT Article No.	DU Type Designation	DU Article No.	Units per package
1-pole												
0.5	240/415	15	277	10	SWD	AWG 18	FAZ-D0,5/1-RT	182004	FAZ-D0,5/1-DU	185001	12/120	
1	240/415	15	277	10	SWD	AWG 18	FAZ-D1/1-RT	182006	FAZ-D1/1-DU	185002	12/120	
1.5	240/415	15	277	10	SWD	AWG 18	FAZ-D1,5/1-RT	182008	FAZ-D1,5/1-DU	185003	12/120	
2	240/415	15	277	10	SWD	AWG 18	FAZ-D2/1-RT	182010	FAZ-D2/1-DU	185004	12/120	
3	240/415	15	277	10	SWD	AWG 18	FAZ-D3/1-RT	182012	FAZ-D3/1-DU	185005	12/120	
4	240/415	15	277	10	SWD	AWG 18	FAZ-D4/1-RT	182014	FAZ-D4/1-DU	185006	12/120	
5	240/415	15	277	10	SWD	AWG 18	FAZ-D5/1-RT	182016	FAZ-D5/1-DU	185007	12/120	
6	240/415	15	277	10	SWD	AWG 18	FAZ-D6/1-RT	182018	FAZ-D6/1-DU	185008	12/120	
7	240/415	15	277	10	SWD	AWG 18	FAZ-D7/1-RT	182020	FAZ-D7/1-DU	185009	12/120	
8	240/415	15	277	10	SWD	AWG 16	FAZ-D8/1-RT	182022	FAZ-D8/1-DU	185010	12/120	
10	240/415	15	277	10	SWD	AWG 16	FAZ-D10/1-RT	181832	FAZ-D10/1-DU	185011	12/120	
13	240/415	15	277	14	SWD		FAZ-D13/1-RT	181834	FAZ-D13/1-DU	185012	12/120	
15	240/415	15	277	14	SWD		FAZ-D15/1-RT	181836	FAZ-D15/1-DU	185013	12/120	
16	240/415	15	277	14	SWD		FAZ-D16/1-RT	181838	FAZ-D16/1-DU	185014	12/120	
20	240/415	15	277	14	SWD		FAZ-D20/1-RT	181840	FAZ-D20/1-DU	185015	12/120	
25	240/415	15	277	10			FAZ-D25/1-RT	181842	FAZ-D25/1-DU	185016	12/120	
30	240/415	15	277	10			FAZ-D30/1-RT	182024	FAZ-D30/1-DU	185017	12/120	
32	240/415	15	277	10			FAZ-D32/1-RT	182026	FAZ-D32/1-DU	185018	12/120	
35	240/415	15	240	10			FAZ-D35/1-RT	182028	FAZ-D35/1-DU	185019	12/120	
40	240/415	15	240	10			FAZ-D40/1-RT	182030	FAZ-D40/1-DU	185020	12/120	
2-pole												
0.5	415	15	480Y/277	10	SWD	AWG 18	FAZ-D0,5/2-RT	182032	FAZ-D0,5/2-DU	185041	1/60	
1	415	15	480Y/277	10	SWD	AWG 18	FAZ-D1/2-RT	182034	FAZ-D1/2-DU	185042	1/60	
1.5	415	15	480Y/277	10	SWD	AWG 18	FAZ-D1,5/2-RT	182036	FAZ-D1,5/2-DU	185043	1/60	
2	415	15	480Y/277	10	SWD	AWG 18	FAZ-D2/2-RT	182038	FAZ-D2/2-DU	185044	1/60	
3	415	15	480Y/277	10	SWD	AWG 18	FAZ-D3/2-RT	182040	FAZ-D3/2-DU	185045	1/60	
4	415	15	480Y/277	10	SWD	AWG 18	FAZ-D4/2-RT	182042	FAZ-D4/2-DU	185046	1/60	
5	415	15	480Y/277	10	SWD	AWG 18	FAZ-D5/2-RT	182044	FAZ-D5/2-DU	185047	1/60	
6	415	15	480Y/277	10	SWD	AWG 18	FAZ-D6/2-RT	182046	FAZ-D6/2-DU	185048	1/60	
7	415	15	480Y/277	10	SWD	AWG 18	FAZ-D7/2-RT	182048	FAZ-D7/2-DU	185049	1/60	
8	415	15	480Y/277	10	SWD	AWG 16	FAZ-D8/2-RT	182050	FAZ-D8/2-DU	185050	1/60	
10	415	15	480Y/277	10	SWD	AWG 16	FAZ-D10/2-RT	182052	FAZ-D10/2-DU	185051	1/60	
13	415	15	480Y/277	14	SWD		FAZ-D13/2-RT	182054	FAZ-D13/2-DU	185052	1/60	
15	415	15	480Y/277	14	SWD		FAZ-D15/2-RT	182056	FAZ-D15/2-DU	185053	1/60	
16	415	15	480Y/277	14	SWD		FAZ-D16/2-RT	182058	FAZ-D16/2-DU	185054	1/60	
20	415	15	480Y/277	14	SWD		FAZ-D20/2-RT	182060	FAZ-D20/2-DU	185055	1/60	
25	415	15	480Y/277	10			FAZ-D25/2-RT	182062	FAZ-D25/2-DU	185056	1/60	
30	415	15	480Y/277	10			FAZ-D30/2-RT	182064	FAZ-D30/2-DU	185057	1/60	
32	415	15	480Y/277	10			FAZ-D32/2-RT	182066	FAZ-D32/2-DU	185058	1/60	
35	415	15	240	10			FAZ-D35/2-RT	182068	FAZ-D35/2-DU	185059	1/60	
40	415	15	240	10			FAZ-D40/2-RT	182070	FAZ-D40/2-DU	185060	1/60	
3-pole												
0.5	415	15	480Y/277	10	SWD	AWG 18	FAZ-D0,5/3-RT	182072	FAZ-D0,5/3-DU	185081	1/40	
1	415	15	480Y/277	10	SWD	AWG 18	FAZ-D1/3-RT	182074	FAZ-D1/3-DU	185082	1/40	
1.5	415	15	480Y/277	10	SWD	AWG 18	FAZ-D1,5/3-RT	182076	FAZ-D1,5/3-DU	185083	1/40	
2	415	15	480Y/277	10	SWD	AWG 18	FAZ-D2/3-RT	182078	FAZ-D2/3-DU	185084	1/40	
3	415	15	480Y/277	10	SWD	AWG 18	FAZ-D3/3-RT	182080	FAZ-D3/3-DU	185085	1/40	
4	415	15	480Y/277	10	SWD	AWG 18	FAZ-D4/3-RT	182082	FAZ-D4/3-DU	185086	1/40	
5	415	15	480Y/277	10	SWD	AWG 18	FAZ-D5/3-RT	182084	FAZ-D5/3-DU	185087	1/40	
6	415	15	480Y/277	10	SWD	AWG 18	FAZ-D6/3-RT	182086	FAZ-D6/3-DU	185088	1/40	
7	415	15	480Y/277	10	SWD	AWG 18	FAZ-D7/3-RT	182088	FAZ-D7/3-DU	185089	1/40	
8	415	15	480Y/277	10	SWD	AWG 16	FAZ-D8/3-RT	182090	FAZ-D8/3-DU	185090	1/40	
10	415	15	480Y/277	10	SWD	AWG 16	FAZ-D10/3-RT	182092	FAZ-D10/3-DU	185091	1/40	
13	415	15	480Y/277	14	SWD		FAZ-D13/3-RT	182094	FAZ-D13/3-DU	185092	1/40	
15	415	15	480Y/277	14	SWD		FAZ-D15/3-RT	182096	FAZ-D15/3-DU	185093	1/40	
16	415	15	480Y/277	14	SWD		FAZ-D16/3-RT	182098	FAZ-D16/3-DU	185094	1/40	
20	415	15	480Y/277	14	SWD		FAZ-D20/3-RT	182100	FAZ-D20/3-DU	184984	1/40	
25	415	15	480Y/277	10			FAZ-D25/3-RT	182102	FAZ-D25/3-DU	184985	1/40	
30	415	15	480Y/277	10			FAZ-D30/3-RT	182104	FAZ-D30/3-DU	184986	1/40	
32	415	15	480Y/277	10			FAZ-D32/3-RT	182106	FAZ-D32/3-DU	184987	1/40	
35	415	15	240	10			FAZ-D35/3-RT	182108	FAZ-D35/3-DU	184988	1/40	
40	415	15	240	10			FAZ-D40/3-RT	182110	FAZ-D40/3-DU	184989	1/40	

FAZ-NA, -RT, -DU Miniature Circuit Breakers

Accessories:

Auxiliary switch for subsequent installation	Z-IHK-NA	113895
Tripping signal contact for subsequent installation	Z-NHK	248434
Shunt trip release	FAZ-XAA-NA12-110VAC	102037
	FAZ-XAA-NA110-415VAC	102036
Switching interlock	IS/SPE-1TE	101911
	Z-IS/SPE-1TE	274418

Specifications FAZ-NA, -RT, -DU

Technical data IEC/EN

	FAZ-...-NA, -RT, -DU	
Productstandard	IEC/EN 60947-2	
Number of poles	1, 2, 3	
Mechanical specifications		
Device width	17.7mm (1-pole), 35.4 mm (2-poles), 53.1 mm (3-poles)	
Frame size	45 mm	
Socket size	105 mm	
Device depth	60 mm	
Terminals	lift terminal / ring-tongue	
Terminal capacity rigid solid/stranded wire	1-25 mm ²	
Terminal screw	M5 (with slotted screw Pozidriv PZ2)	
Terminal torque	max. 2.4 Nm	
Snap on fixing	tristable (on DIN Rail acc. to IEC/EN 60715)	
Degree of Protection (DIN VDE 0470)		
Surface mounted	IP 20	
Built-in behind panel	IP 40	
Contact position indicator	red / green	
Electrical specifications		
Rated voltage	U_n	240/415 V AC
Rated current	I_n	0.5, 1, 1.5, 2, 3, 4, 5, 6, 7, 8, 10, 13, 15, 16, 20, 25, 30, 32, 35, 40 A
Rated insulation voltage	U_i	440 V AC
Rated impulse withstand voltage	U_{imp}	4 kV (1.2/50)µsec
Tripping characteristic		
Conventional non-tripping current	I_{nt}	$I_{nt}=1.05 I_n$
Conventional tripping current	I_t	$I_t=1.30 I_n$
Reference temperature	30 °C	
Temperature factor	0.5% /K	
Instantaneous tripping current	I_{mt}	type B: $3 I_n < I_{mt} = 5 I_n$; $t(I_{mt}) < 0.1$ sec (IEC/EN 60898-1) type C: $5 I_n < I_{mt} = 10 I_n$; $t(I_{mt}) < 0.1$ sec (IEC/EN 60898-1) type D: $10 I_n < I_{mt} = 20 I_n$; $t(I_{mt}) < 0.1$ sec (IEC/EN 60898-1)
Rated short-circuit braking capacity	I_{cu}	15 kA
Service short circuit capacity	I_{cs}	7.5 kA
Selectivity class	3 (acc. to EN 60898)	
Number of electrical operations	> 1500	
Number of mechanical operations	> 10000	
Climatic conditions	acc. to IEC 68-2 (25..55°C / 90..95% RH)	
Operating temperature range	-40°C to +75°C	

Connection diagram

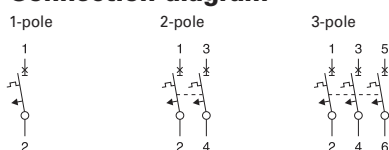

Specifications FAZ-NA, -RT, -DU

Technical data UL

		FAZ-...-NA, -RT, -DU
Productstandard		UL 489 CSA C22.2 No. 5-02
Number of poles		1, 2, 3
Mechanical specifications		
Device width		0.697 in. (1-pole), 1.394 in. (2-poles), 2.090 in. (3-poles)
Frame size		1.772 in.
Socket size		4.134 in.
Device depth		2.362 in.
Terminals		lift terminal / ring-tongue
Terminal capacity		1 Wire: #18-6 AWG (Cu only) 2 Wires: #18-10 AWG (Cu only)
Terminal screw		M5 (with slotted screw Pozidriv PZ2)
Terminal torque		#18-12 AWG: 21 lb-in #10-8 AWG: 25 lb-in #6 AWG: 36 lb-in
Snap on fixing		tristable (on DIN Rail acc. to IEC/EN 60715)
Contact position indicator		red / green
Electrical specifications		
Rated voltage	U_n	0.5-32 A: 480Y/277 V AC, 35-40 A: 240 V AC
Rated current	I_n	0.5, 1, 1.5, 2, 3, 4, 5, 6, 7, 8, 10, 13, 15, 16, 20, 25, 30, 32, 35, 40 A
Tripping characteristic		
Conventional non-tripping current		$I_{nt}=1.00 I_n$
Conventional tripping current		$I_t=1.35 I_n$
Reference temperature		40 °C
Temperature factor		0.5% /K
Instantaneous tripping current	I_{mt}	type C: $5 I_n < I_{mt} = 10 I_n$; $t(I_{mt}) < 0.1$ sec type D: $10 I_n < I_{mt} = 20 I_n$; $t(I_{mt}) < 0.1$ sec
Current interrupting rating		10 kA, 14 kA (types D13, B/C/D15, 16, 20, B/C25 A)
Current-Limiting at 240 V / 10 kA		1p, 2p, 3p to $I^2t = 43 \text{ kA}^2\text{s}$ and $I_{peak} = 6.2 \text{ kA}$
Current-Limiting at 480Y/277 V / 10 kA		1p, 2p, 3p to $I^2t = 60 \text{ kA}^2\text{s}$ and $I_{peak} = 6.2 \text{ kA}$
Current-Limiting at 480Y/277 V / 14 kA		1p, 2p, 3p to $I^2t = 65 \text{ kA}^2\text{s}$ and $I_{peak} = 7.5 \text{ kA}$
Selectivity class		3 (acc. to EN 60898)
Number of electrical operations		6000
Number of mechanical operations		10000
Climatic conditions		acc. to IEC 68-2 (25..55°C / 90..95% RH)
Operating temperature range		-5°C to +40°C

Connection diagram

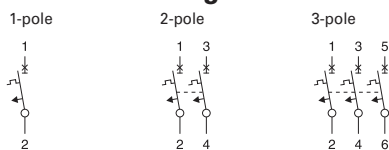

Dimensions (mm) FAZ-...-NA, -RT, -DU

1-pole

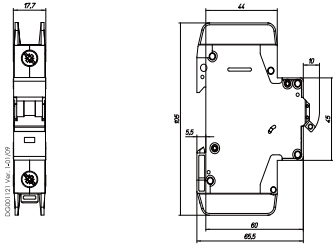

2-pole

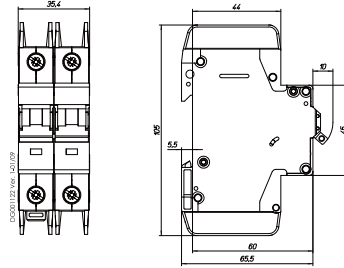

3-pole

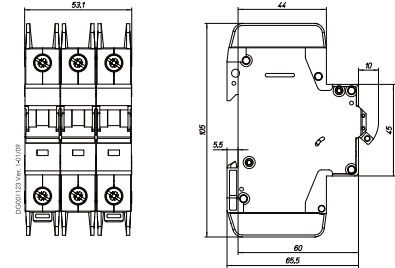

Tripping Characteristic FAZ-...-NA, -RT, -DU

Characteristics C and D - EN/IEC 60947-2

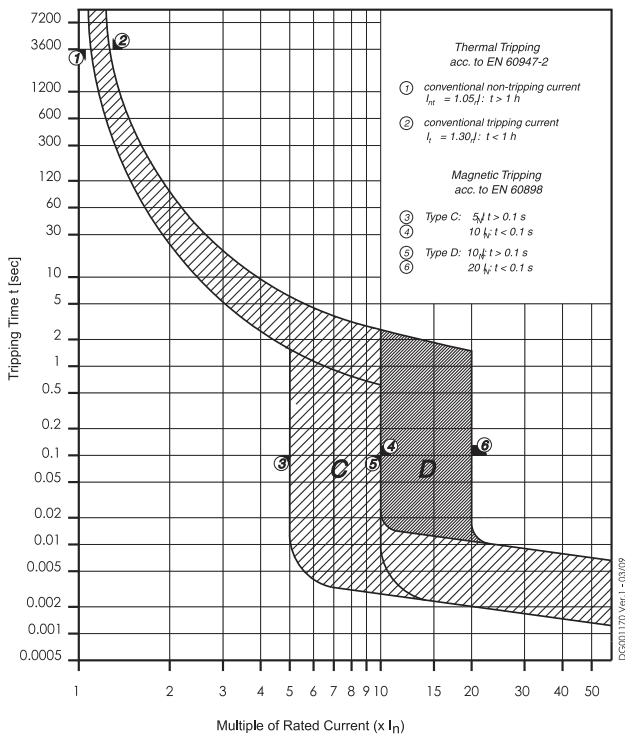

Characteristics C and D - UL 489

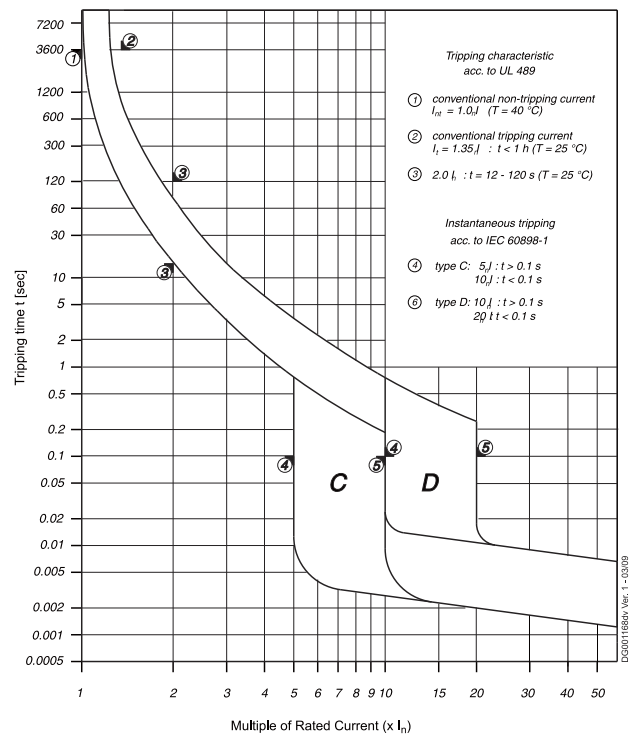

Internal Resistance FAZ-...-NA, -RT, -DU

Type C

At room temperature (single pole)

In [A]	Z* [mΩ]	R [mΩ]
0.5	6400	6300
1	1100	1080
1.5	560	550
2	340	330
3	132	130
4	86	85
5	70	69
6	31	30
7	28	27
8	20	19.6
10	15.8	15.5
13	12.3	12.1
15	7.1	7.0
16	7.1	7.0
20	6.0	5.9
25	4.1	4.0
30	2.8	2.7
32	2.8	2.7
35	2.5	2.5
40	2.1	2.1

* 50Hz

Type D

At room temperature (single pole)

In [A]	Z* [mΩ]	R [mΩ]
0.5	6400	6300
1	770	755
1.5	460	450
2	250	245
3	132	130
4	86	85
5	57	56
6	31	30
7	28	27
8	18	17.6
10	13.5	13.2
13	10.5	10.3
15	5.9	5.8
16	5.9	5.8
20	4.0	3.9
25	3.4	3.3
30	2.5	2.5
32	2.5	2.5
35	2.5	2.5
40	2.0	2.0

* 50Hz

Power Loss at I_n FAZ-...-NA, -RT, -DU

Type C

In [A]	1p	2p	3p
	P* [W]	P* [W]	P* [W]
0.5	1.6	3.2	4.7
1	1.1	2.2	3.4
1.5	1.3	2.6	3.9
2	1.4	2.8	4.3
3	1.2	2.4	3.6
4	1.4	2.9	4.3
5	1.9	3.7	5.6
6	1.2	2.3	3.5
7	1.4	2.8	4.3
8	1.4	2.8	4.2
10	1.8	3.6	5.3
13	2.4	4.7	7.1
15	1.9	3.8	5.6
16	2.1	4.3	6.4
20	2.9	5.8	8.7
25	3.1	6.2	9.3
30	3.0	6.0	9.0
32	3.4	6.8	10.2
35	3.7	7.4	11.0
40	4.0	8.1	12.1

*50Hz

Type D

In [A]	1p	2p	3p
	P* [W]	P* [W]	P* [W]
0.5	1.6	3.2	4.8
1	0.8	1.5	2.3
1.5	1.0	2.1	3.1
2	1.0	2.1	3.1
3	1.2	2.4	3.6
4	1.4	2.9	4.3
5	1.5	2.9	4.4
6	1.2	2.3	3.5
7	1.4	2.8	4.3
8	1.2	2.4	3.7
10	1.5	3.0	4.5
13	2.0	4.1	6.1
15	1.5	3.1	4.6
16	1.7	3.5	5.2
20	1.8	3.7	5.5
25	2.6	5.1	7.7
30	2.7	5.4	8.1
32	3.1	6.2	9.3
35	3.8	7.6	11.3
40	3.9	7.8	11.6

*50Hz

Maximum Let-Through Energy FAZ-...-NA, -RT, -DU

Type C (0.5 - 32 A), 277 V

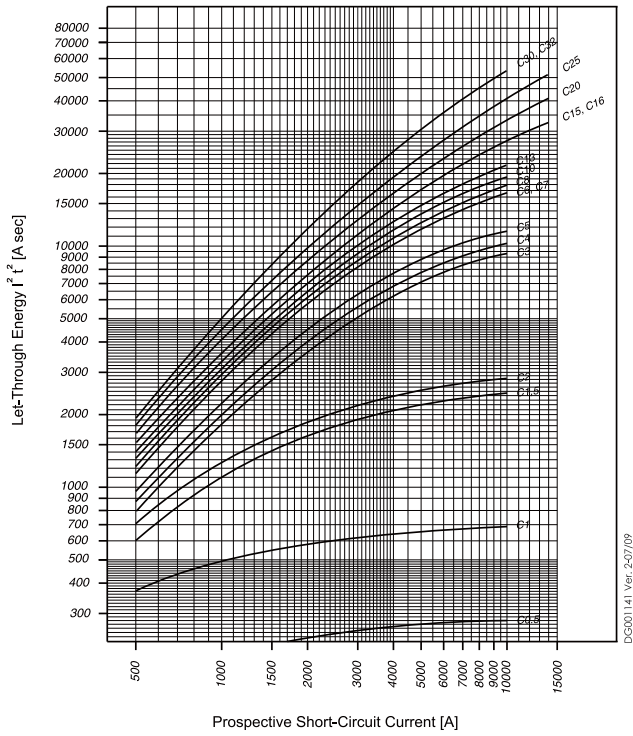

Type C (35 - 40 A), 240 V

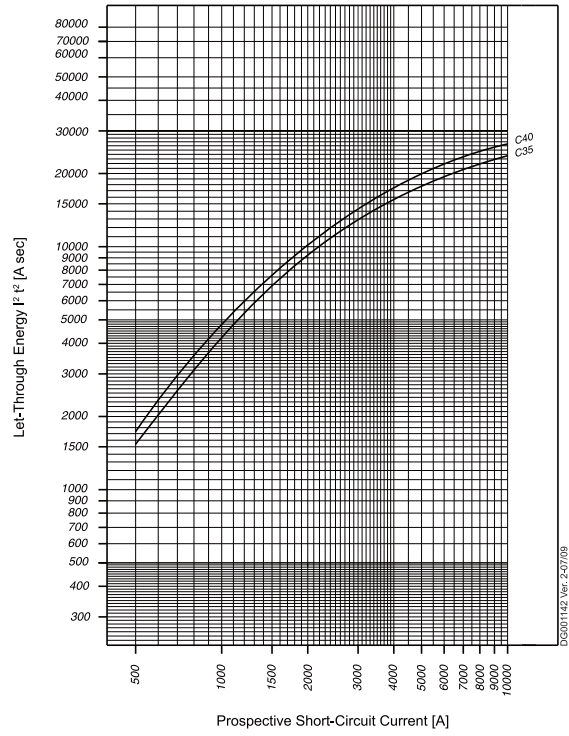

Type D (0.5 - 32 A), 277 V

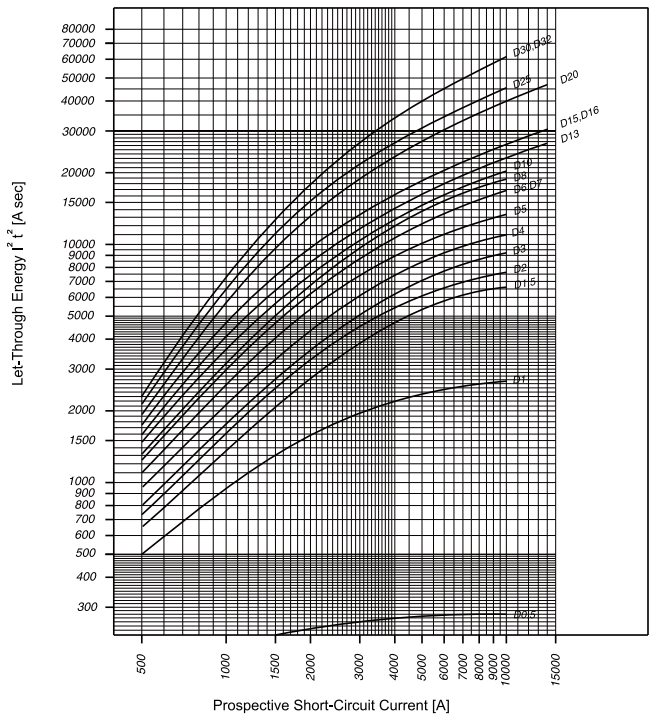

Type D (35 - 40 A), 240 V

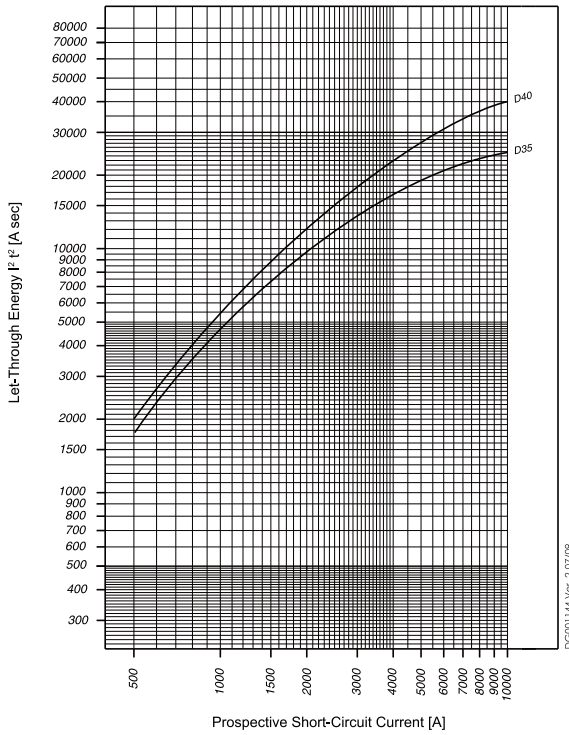

Maximum Let-Through Current FAZ-...-NA, -RT, -DU

Type C (0.5 - 32 A), 277 V

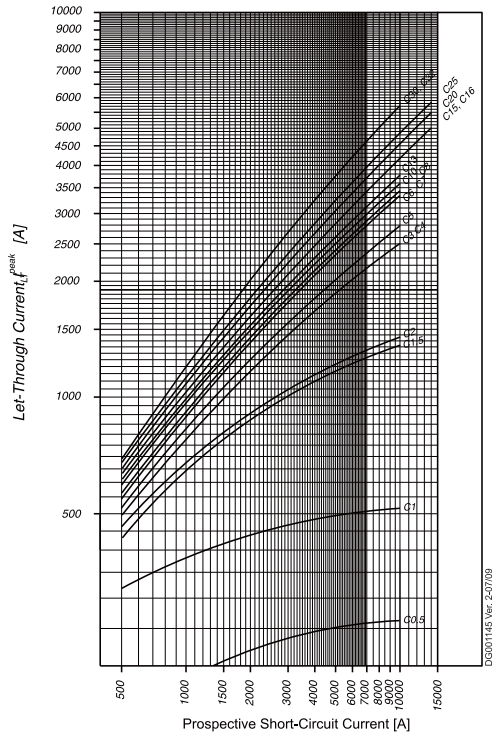

Type C (35 - 40 A), 240 V

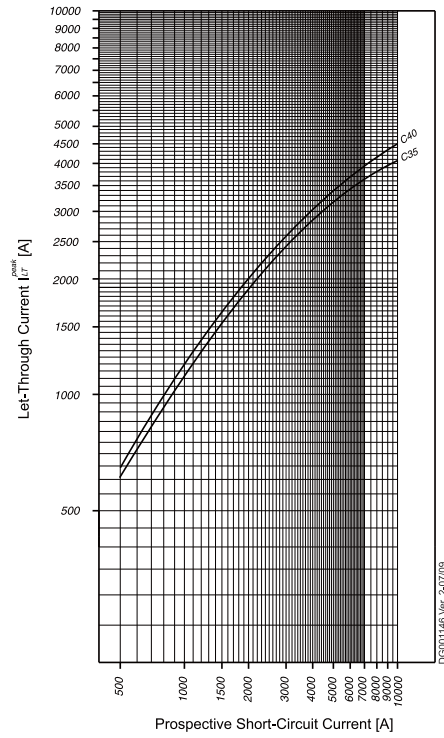

Type D (0.5 - 32 A), 277 V

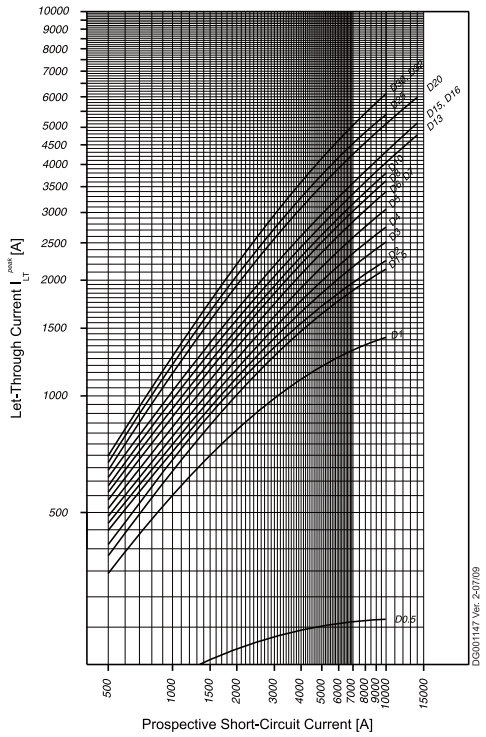

Type D (35 - 40 A), 240 V

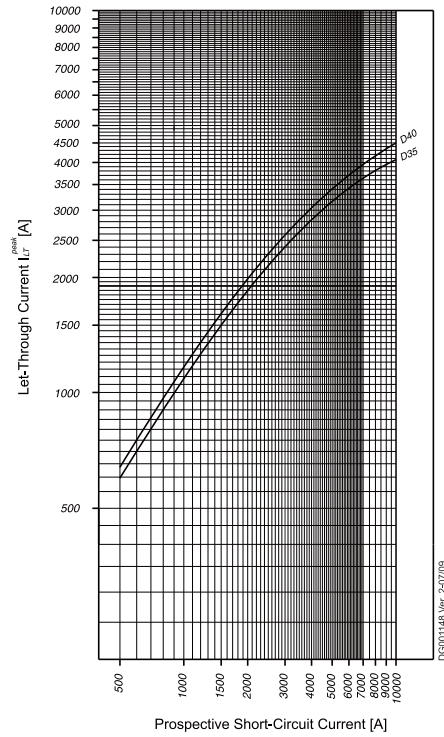

Miniature Circuit Breakers FAZ-NA-DC

SG56612



FAZ-NA-DC

- High-quality miniature circuit breakers for DC-applications
- Contact position indicator red - green
- Guide for secure terminal connection (not for FAZ-NA)
- 3-position DIN rail clip, permits removal from existing busbar system
- Comprehensive range of accessories suitable for subsequent installation
- Rated currents up to 40 A
- Tripping characteristic C
- Rated breaking capacity 10 kA according to IEC/EN 60947-2
- Up to 125 V DC per pole

FAZ-...-NA-DC Miniature Circuit Breakers (MCBs)

Characteristic C

Rated current I_n (A)	Rated voltage IEC/EN 60947-2 (V DC)	Breaking capacity acc. to IEC/EN 60947-2 (kA)	Rated voltage UL489 (V)	Breaking capacity acc. to UL489 (kA)	SWD	NFPA 79	Type Designation	Article No.	Units per package
1-pole									
2	220	10	125	10			FAZ-C2/1-NA-DC	113752	12/120
3	250	10	125	10			FAZ-C3/1-NA-DC	113753	12/120
4	250	10	125	10			FAZ-C4/1-NA-DC	113754	12/120
5	250	10	125	10			FAZ-C5/1-NA-DC	113755	12/120
6	250	10	125	10			FAZ-C6/1-NA-DC	113756	12/120
7	250	10	125	10			FAZ-C7/1-NA-DC	113757	12/120
8	250	10	125	10			FAZ-C8/1-NA-DC	113758	12/120
10	250	10	125	10			FAZ-C10/1-NA-DC	113759	12/120
13	250	10	125	10			FAZ-C13/1-NA-DC	113760	12/120
15	250	10	125	10			FAZ-C15/1-NA-DC	113761	12/120
16	250	10	125	10			FAZ-C16/1-NA-DC	113762	12/120
20	250	10	125	10			FAZ-C20/1-NA-DC	113763	12/120
25	250	10	125	10			FAZ-C25/1-NA-DC	113764	12/120
30	250	10	125	10			FAZ-C30/1-NA-DC	113765	12/120
32	250	10	125	10			FAZ-C32/1-NA-DC	113766	12/120
35	250	10	125	10			FAZ-C35/1-NA-DC	113767	12/120
40	250	10	125	10			FAZ-C40/1-NA-DC	113768	12/120

SG56512



SG56612



2-pole									
2	440	10	250	10			FAZ-C2/2-NA-DC	137239	1/60
3	500	10	250	10			FAZ-C3/2-NA-DC	137250	1/60
4	500	10	250	10			FAZ-C4/2-NA-DC	137251	1/60
5	500	10	250	10			FAZ-C5/2-NA-DC	137252	1/60
6	500	10	250	10			FAZ-C6/2-NA-DC	120638	1/60
7	500	10	250	10			FAZ-C7/2-NA-DC	120639	1/60
8	500	10	250	10			FAZ-C8/2-NA-DC	120640	1/60
10	500	10	250	10			FAZ-C10/2-NA-DC	120641	1/60
13	500	10	250	10			FAZ-C13/2-NA-DC	120642	1/60
15	500	10	250	10			FAZ-C15/2-NA-DC	120643	1/60
16	500	10	250	10			FAZ-C16/2-NA-DC	120644	1/60
20	500	10	250	10			FAZ-C20/2-NA-DC	120645	1/60
25	500	10	250	10			FAZ-C25/2-NA-DC	120646	1/60
30	500	10	250	10			FAZ-C30/2-NA-DC	120647	1/60
32	500	10	250	10			FAZ-C32/2-NA-DC	120648	1/60
35	500	10	250	10			FAZ-C35/2-NA-DC	120649	1/60
40	500	10	250	10			FAZ-C40/2-NA-DC	120650	1/60

Specifications FAZ-NA-DC

Technical data

		FAZ-NA-DC
Productstandard		UL 489, CSA C22.2 No 5-02
Number of poles		1, 2
Mechanical specifications		
Device width		1 pole = 0.697 inch, 2 poles = 1.394 inch
Frame size		1.772 inch
Socket size		4.134 inch
Device depth		2.362 inch
Terminals		lift terminal / ring-tongue
Terminal capacity rigid solid/stranded wire		1 Wire: AWG 18-6 (Cu only) 2 Wires: AWG 18-10 (Cu only)
Terminal screw		M5 (with slotted screw Pozidriv PZ2)
Terminal torque		#18-12 AWG: 21 lb-in #10-8 AWG: 25 lb-in #6 AWG: 36 lb-in
Snap on fixing		tristable (on DIN Rail acc. to IEC/EN 60715)
Finger proof		acc.to VBG4, ÖVE EN-6
Contact position indicator		red / green
Electrical specifications		
Rated voltage DC	U_n	125 V d.c. (1p) 250 V d.c. (2p)
Rated current	I_n	2, 3, 4, 5, 6, 7, 8, 10, 13, 15, 16, 20, 25, 30, 32, 35, 40 A
Rated impulse withstand voltage	U_{imp}	4 kV (1.2/50) μ sec
Tripping characteristic		
Conventional non-tripping current		$I_{nt}=1.0 I_n$
Conventional tripping current		$I_t=1.35 I_n$
Reference temperature		40 °C
Temperature factor		0.5% /K
Instantaneous tripping current	I_{mt}	$7 I_n < I_{mt} = 15 I_n \cdot t (I_{mt}) < 0.1 \text{ sec}$
Current interrupting rating		10 kA
Number of electrical operating cycles		6000
Number of mechanical operating cycles		10000
Climatic conditions		acc. to IEC 68-2 (25..55°C / 90..95% RH)
Operating temperature range		-25°C to +55°C

Connection diagram

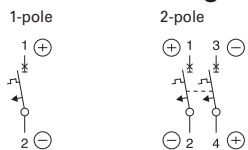

Dimensions (mm) FAZ-NA-DC

1-pole

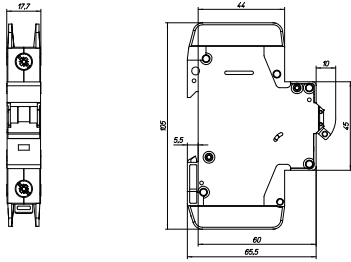

2-pole

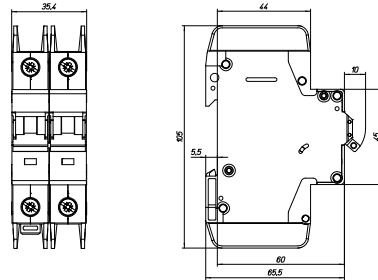

Tripping Characteristic FAZ-NA-DC

Characteristics C - UL 489

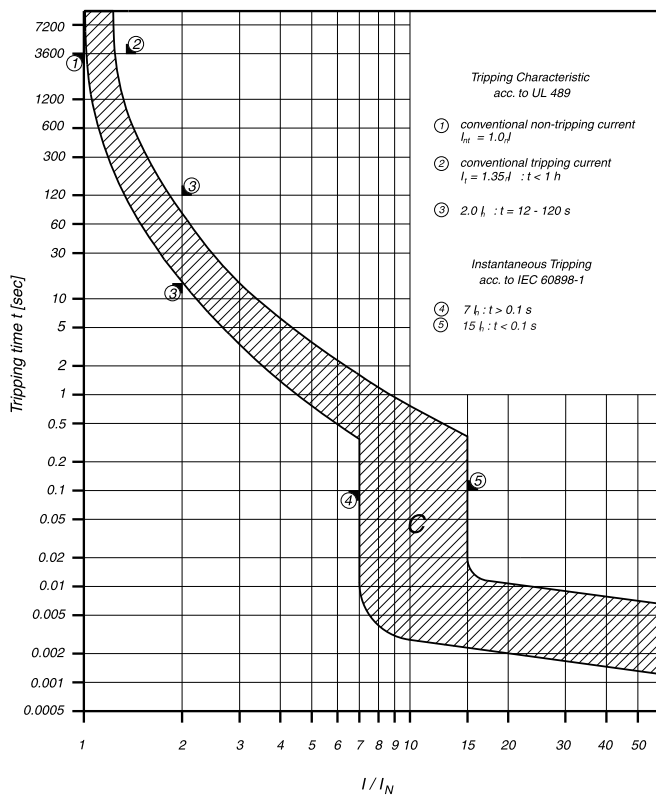





Miniature Circuit Breakers AZ

SG51412







- High-quality miniature circuit breakers for commercial and industrial applications
- Contact position indicator red - green
- Accessories suitable for subsequent installation
- Rated currents up to 125 A
- Tripping characteristics C, D
- Rated breaking capacity up to 25 kA according to EN 60947-2

AZ Miniature Circuit Breakers (MCBs) Characteristic C

	Rated current I_n (A)	Type Designation	Article No.	Units per package
SG51212 	1-pole			
	20	AZ-C20	211769	12
	25	AZ-C25	211774	12
	32	AZ-C32	211779	12
	40	AZ-C40	211784	12
	50	AZ-C50	211789	12
	63	AZ-C63	211794	12
	80	AZ-C80	211799	12
	100	AZ-C100	211804	12
SG51312 	2-pole			
	20	AZ-2-C20	211770	2
	25	AZ-2-C25	211775	2
	32	AZ-2-C32	211780	2
	40	AZ-2-C40	211785	2
	50	AZ-2-C50	211790	2
	63	AZ-2-C63	211795	2
	80	AZ-2-C80	211800	2
	100	AZ-2-C100	211805	2
wa_sg00314 	3-pole			
	20	AZ-3-C20	211771	1
	25	AZ-3-C25	211776	1
	32	AZ-3-C32	211781	1
	40	AZ-3-C40	211786	1
	50	AZ-3-C50	211791	1
	63	AZ-3-C63	211796	1
	80	AZ-3-C80	211801	1
	100	AZ-3-C100	211806	1
wa_sg00214 	3+N-pole			
	20	AZ-3N-C20	211773	1
	25	AZ-3N-C25	211778	1
	32	AZ-3N-C32	211783	1
	40	AZ-3N-C40	211788	1
	50	AZ-3N-C50	211793	1
	63	AZ-3N-C63	211798	1
	80	AZ-3N-C80	211803	1
	100	AZ-3N-C100	211808	1
SG51412 	4-pole			
	20	AZ-4-C20	211772	1
	25	AZ-4-C25	211777	1
	32	AZ-4-C32	211782	1
	40	AZ-4-C40	211787	1
	50	AZ-4-C50	211792	1
	63	AZ-4-C63	211797	1
	80	AZ-4-C80	211802	1
	100	AZ-4-C100	211807	1
	125	AZ-4-C125	211812	1

AZ Miniature Circuit Breakers (MCBs)

Characteristic D

	Rated current I_n (A)	Type Designation	Article No.	Units per package
SG51212 	1-pole			
	50	AZ-D50	211814	12
	63	AZ-D63	211818	12
	80	AZ-D80	211822	12
	100	AZ-D100	211826	12
SG51312 	2-pole			
	50	AZ-2-D50	211815	2
	63	AZ-2-D63	211819	2
	80	AZ-2-D80	211823	2
	100	AZ-2-D100	211827	2
wa_sg00314 	3-pole			
	50	AZ-3-D50	211816	1
	63	AZ-3-D63	211820	1
	80	AZ-3-D80	211824	1
	100	AZ-3-D100	211828	1
wa_sg00214 	3+N-pole			
	50	AZ-3N-D50	211817	1
	63	AZ-3N-D63	211821	1
	80	AZ-3N-D80	211825	1
	100	AZ-3N-D100	211829	1

Maximum Let-Through Current AZ

Type C

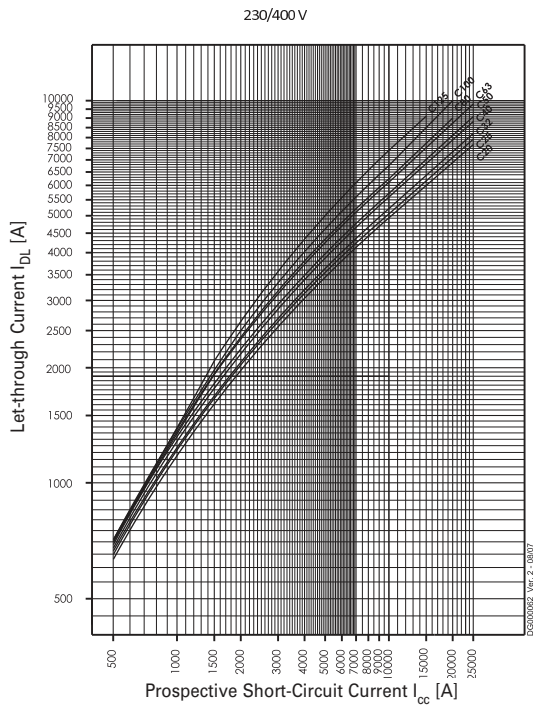

Type D

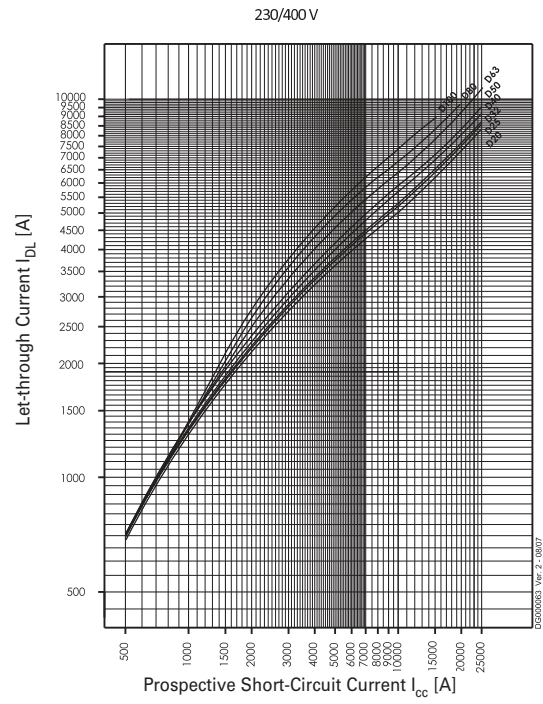

Dimensions (mm)

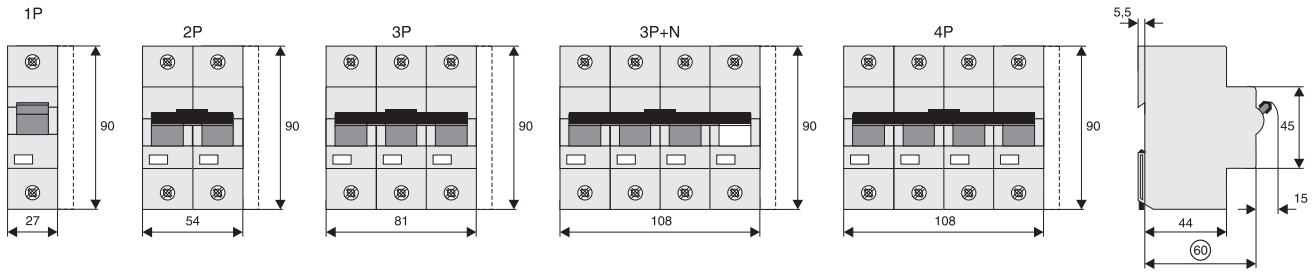

Effect of ambient temperature AZ

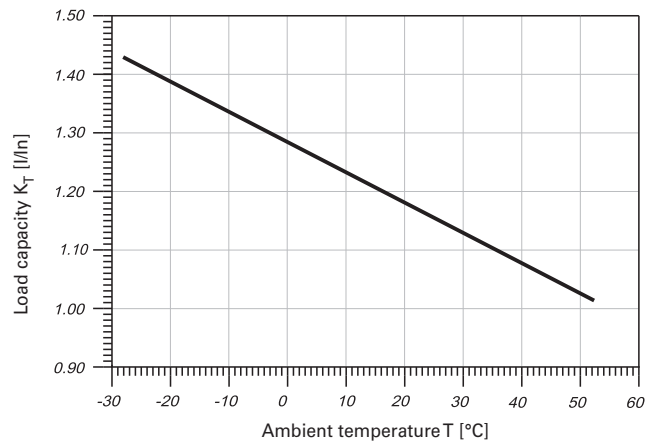

Permitted permanent load at ambient temperature T [°C] with n devices: $I_{DL} = I_n K_T(T) K_N(N)$.

Maximum Let-Through Current AZ

Type C

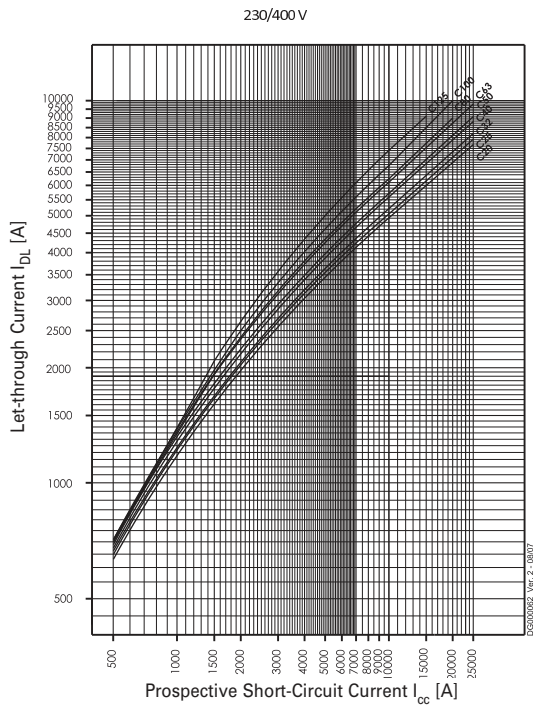

Type D

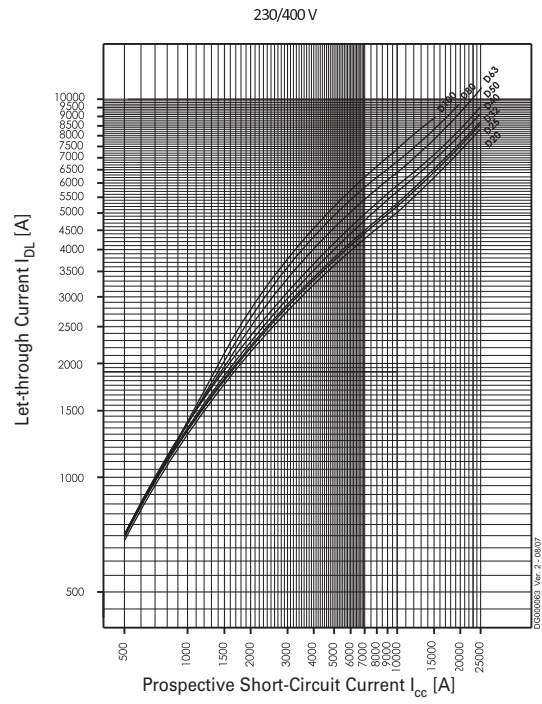

Short Circuit Selectivity AZ

In case of short circuit, there is selectivity between the miniature circuit breakers AZ and the upstream protection devices up to the specified values of the selectivity limit current I_s [kA] (i. e. in case of short-circuit currents I_{ks} under I_s , only the MCB will trip, in case of short circuit currents above this value both protective devices will respond).

AZ towards back-up fuses D01, D02, D03

Rated current I_n AZ in A	Rated current of the back-up fuse in A						
	25	35	50	63	80	100	
C - Characteristic	20	0,5	1,0	2,0	2,9	3,9	7,6
	25		1,0	1,9	2,8	3,8	7,3
	32		1,0	1,8	2,7	3,6	7,0
	40			1,6	2,2	3,0	5,6
	50				2,1	2,8	5,2
	63					2,7	4,8
	80						4,3
	100						
	125						
	D -Characteristic	20	0,5	0,9	1,7	2,5	3,4
25			0,9	1,6	2,3	3,2	6,2
32			0,9	1,5	2,3	3,0	6,0
40				1,4	2,0	2,6	4,7
50					1,8	2,3	4,3
63						2,1	3,7
80							3,1
100							
125							

AZ towards back-up fuses NH Gr. 00

Rated current I_n AZ in A	Rated current of the back-up fuse in A										
	25	35	40	50	63	80	100	125	160	200	
C - Characteristic	20	0,5	1,0	1,3	1,9	2,7	3,7	6,7	17,0	25,0	25,0
	25		0,9	1,3	1,8	2,6	3,5	6,5	17,0	25,0	25,0
	32		0,9	1,2	1,7	2,4	3,3	6,0	15,0	23,0	25,0
	40				1,4	2,1	2,9	4,8	12,0	18,0	25,0
	50					1,9	2,7	4,5	11,0	17,0	25,0
	63							4,2	10,0	15,0	25,0
	80							3,8	8,5	12,0	25,0
	100								7,0	10,0	25,0
	125									7,5	25,0
	D - Characteristic	20	<0,5	0,8	1,1	1,5	2,3	3,1	5,6	16,0	25,0
25			0,7	1,0	1,4	2,1	3,0	5,3	14,0	23,0	25,0
32			0,7	1,0	1,3	2,1	2,9	5,0	13,0	22,0	25,0
40					1,1	1,8	2,5	4,2	10,0	15,0	25,0
50						1,6	2,3	3,8	8,5	13,0	22,0
63							2,1	3,2	7,0	10,5	18,0
80								2,8	5,5	8,4	15,0
100									4,8	7,5	12,5
125											

AZ towards NZM 1

Short circuit selectivity **characteristic C** towards **NZM***)

AZ	NZM...1-A gL/gG					
I _n [A]	40	50	63	80	100	125
20	0.3	0.4	0.5	0.75	0.9	1.25
25	0.3	0.4	0.5	0.7	0.9	1.2
32		0.4	0.5	0.7	0.85	1.2
40			0.5	0.6	0.85	1.1
50				0.6	0.85	1.1
63					0.8	1
80						1
100						
125						

Short circuit selectivity **characteristic D** towards **NZM***)

AZ	NZM...1-A gL/gG					
I _n [A]	40	50	63	80	100	125
50						
63						
80						
100						

 no selectivity

AZ towards NZM 2

Short circuit selectivity **characteristic C** towards **NZM***)

AZ	NZM...2-A gL/gG								
I _n [A]	40	50	63	80	100	125	160	200	250
20	0.3	0.4	0.5	0.75	0.9	1.25	1.8	2.5	3.5
25	0.3	0.4	0.5	0.7	0.9	1.2	1.7	2.4	3.3
32		0.4	0.5	0.7	0.85	1.2	1.65	2.3	3.2
40			0.5	0.6	0.85	1.1	1.5	2.1	2.9
50				0.6	0.85	1.1	1.5	2	2.8
63					0.8	1	1.4	1.8	2.5
80						1	1.4	1.8	2.4
100							1.3	1.7	2.3
125								1.6	2.1

Short circuit selectivity **characteristic D** towards **NZM***)

AZ	NZM...2-A gL/gG								
I _n [A]	40	50	63	80	100	125	160	200	250
50							1	1.4	2.6
63							1	1.3	2.3
80									2.1
100									

 no selectivity

Back-up Protection AZ

The up-stream protective devices will protect the down-stream AZ up to the short-circuit current specified.

AZ and NZM(B)(C)(N)(H)1

I_n [A]	AZ-$I_n/1(2,3,4)$ / C(D) + NZMB1 $U_e = 230/400$ V
20	25 kA
25	25 kA
32	25 kA
40	25 kA
50	25 kA
63	25 kA
80	25 kA
100	25 kA
125	25 kA

I_n [A]	AZ-$I_n/1(2,3,4)$ / C(D) + NZMC1 $U_e = 230/400$ V
20	36 kA
25	36 kA
32	36 kA
40	36 kA
50	36 kA
63	36 kA
80	36 kA
100	36 kA
125	36 kA

I_n [A]	AZ-$I_n/1(2,3,4)$ / C(D) + NZMN1 $U_e = 230/400$ V
20	50 kA
25	50 kA
32	50 kA
40	50 kA
50	50 kA
63	50 kA
80	50 kA
100	50 kA
125	50 kA

I_n [A]	AZ-$I_n/1(2,3,4)$ / C(D) + NZMH1 $U_e = 230/400$ V
20	80 kA
25	80 kA
32	80 kA
40	80 kA
50	80 kA
63	80 kA
80	80 kA
100	80 kA
125	80 kA

AZ and NZM(B)(C)(N)(H)2

I_n [A]	AZ-$I_n/1(2,3,4)$ / C(D) + NZMB2 $U_e = 230/400$ V
20	25 kA
25	25 kA
32	25 kA
40	25 kA
50	25 kA
63	25 kA
80	25 kA
100	25 kA
125	25 kA

I_n [A]	AZ-$I_n/1(2,3,4)$ / C(D) + NZMC2 $U_e = 230/400$ V
20	36 kA
25	36 kA
32	36 kA
40	36 kA
50	36 kA
63	36 kA
80	36 kA
100	36 kA
125	36 kA

I_n [A]	AZ-$I_n/1(2,3,4)$ / C(D) + NZMN2 $U_e = 230/400$ V
20	50 kA
25	50 kA
32	50 kA
40	50 kA
50	50 kA
63	50 kA
80	50 kA
100	50 kA
125	50 kA

I_n [A]	AZ-$I_n/1(2,3,4)$ / C(D) + NZMH2 $U_e = 230/400$ V
20	65 kA
25	65 kA
32	65 kA
40	65 kA
50	65 kA
63	65 kA
80	65 kA
100	65 kA
125	65 kA

Load capacity in case of block installation AZ

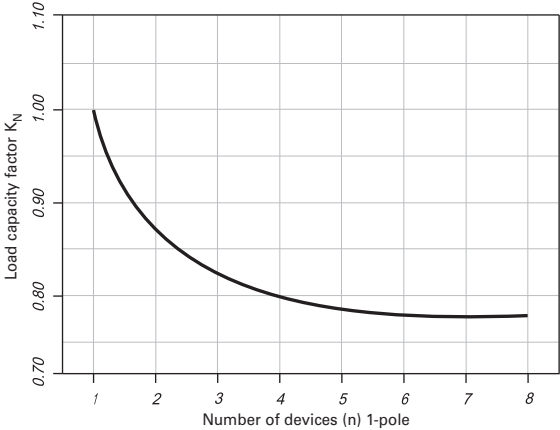





Main Load Disconnecter Switch (Isolator) IS

SG10911



- Load circuit breaker with isolating function
- Highly wear resistant contacts
- Quick make
- Terminal capacity 50 mm²
- Compatible busbars
- 1-, 2-, 3-, 4-pole

Main Load Disconnecter Switch (Isolator) IS

	Rated Current (A)	Poles	Type Designation	Article No.	Units per package	
 SG10611	16	1	IS-16/1	276254	12/120	
	16	2	IS-16/2	276255	1/60	
	16	3	IS-16/3	276256	1/40	
	16	4	IS-16/4	276257	1/30	
	20	1	IS-20/1	276258	12/120	
	20	2	IS-20/2	276259	1/60	
	20	3	IS-20/3	276260	1/40	
	20	4	IS-20/4	276261	1/30	
	 SG10711	25	1	IS-25/1	276262	12/120
		25	2	IS-25/2	276263	1/60
25		3	IS-25/3	276264	1/40	
25		4	IS-25/4	276265	1/30	
32		1	IS-32/1	276266	12/120	
32		2	IS-32/2	276267	1/60	
32		3	IS-32/3	276268	1/40	
32		4	IS-32/4	276269	1/30	
 SG10811		40	1	IS-40/1	276270	12/120
		40	2	IS-40/2	276271	1/60
	40	3	IS-40/3	276272	1/40	
	40	4	IS-40/4	276273	1/30	
	63	1	IS-63/1	276274	12/120	
	63	2	IS-63/2	276275	1/60	
	63	3	IS-63/3	276276	1/40	
	63	4	IS-63/4	276277	1/30	
	 SG10911	80	1	IS-80/1	276278	12/120
		80	2	IS-80/2	276279	1/60
80		3	IS-80/3	276280	1/40	
80		4	IS-80/4	276281	1/30	
100		1	IS-100/1	276282	12/120	
100		2	IS-100/2	276283	1/60	
100		3	IS-100/3	276284	1/40	
100		4	IS-100/4	276285	1/30	
		125	1	IS-125/1	276286	12/120
		125	2	IS-125/2	276287	1/60
	125	3	IS-125/3	276288	1/40	
	125	4	IS-125/4	276289	1/30	

Accessories

	Description	Type Designation	Article No.	Units per package
 SG47812	Switching interlock without lock for Isolators, RCDs, combined RCD/MCBs, ...	IS/SPE-1TE	101911	5/30
	Terminal cover	Z-IS/AK-1TE	276290	10/600

Switching interlock IS/SPE-1TE

- Without lock
- Also suitable for PFIM, CF16, PKNM, CKN6

Terminal Cover Caps Z-IS/AK-1TE

- Can be sealed with leads
- Modular design, width 1 MU

Specifications | Main Load Disconnecter Switch (Isolator) IS

Description

- Load circuit breaker with isolating function
- Design according to IEC/EN 60947-3
- Highly wear resistant contacts
- Quick make, black toggle
- Terminal capacity 50 mm²
- Compatible busbars with switchgear series Xpole by use of the mouth terminal in combination with standard fork busbar

Technical Data

	IS-16	IS-20	IS-25	IS-32	IS-40	IS-63	IS-80	IS-100	IS-125
Electrical									
Design	according to IEC/EN 60947-3								
Rated voltage	240/415 V								
Frequency	50/60 Hz								
Rated insulation voltage	U_i	690 V~							
Rated peak withstand voltage	U_{imp}	6 kV							
Pollution degree	3								
Rated short-time withstand current	I_{cw}	2 kA							
Rated short-circuit making capacity	I_{cm}	2.8 kA							
Rated current									
240/415V, AC23A	16 A	20 A	25 A	32 A	40 A	63 A	80 A	100 A	125 A
Number of poles	1-, 2-, 3-, 4-pole								
Maximum back-up fuse	125 A gG								
Short circuit strength - with back-up fuse acc. to the applicable rules									
IEC/EN 60947-3	12.5 kA	12.5 kA	12.5 kA	12.5 kA	12.5 kA	12.5 kA	12.5 kA	10 kA	10 kA
Endurance									
electrical components operation cycles	≥3.000	≥3.000	≥3.000	≥3.000	≥3.000	≥3.000	≥3.000	≥3.000	≥2.000
mechanical components operation cycles	≥16.000	≥16.000	≥16.000	≥16.000	≥16.000	≥16.000	≥16.000	≥16.000	≥14.000
Mechanical									
Frame size	45 mm								
Device height	80 mm								
Device width	17.5mm/pole								
Mounting	quick fastening with 2 lock-in positions on DIN rail IEC/EN 60715								
Degree of protection, built-in	IP40								
Terminal protection	finger and hand touch safe according to BGV A3								
Terminals	open mouthed/lift terminals								
Terminal capacity	2.5 - 50 mm ²								
Busbar thickness	0.8 - 2 mm								
Fastening torque of terminal screws	2.5 - 5 Nm								
Function	irrespective of the position of installation								

Connection diagram

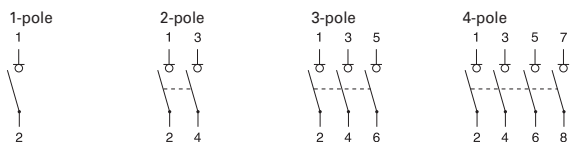

Dimensions (mm)

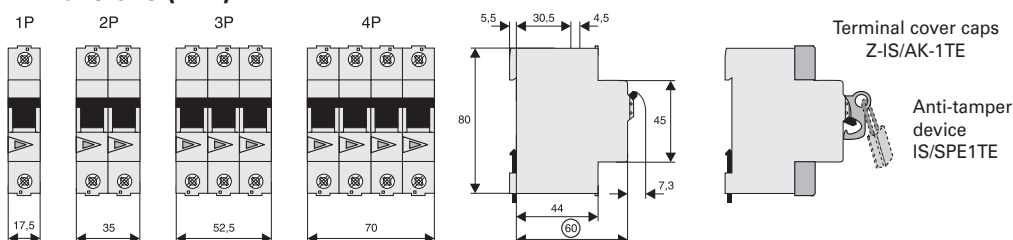

Busbar System xEffect BB-EV

SG13113

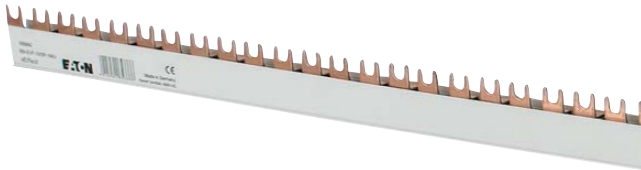

Busbar System xEffect is the modular design system for busbars. xEffect busbars are available as yard goods with 1, 2 or 3 poles. Now, there is a special feature: each bar can easily be extended by one-pole bar as you like. The additional pole can be added completely without tools by easy clamping technique. The lugs or forks in the xEffect bars - available in 10 and 16 mm² and all common distances - can be broken out at a predetermined breaking point. There is actually no more flexibility available.

Busbar System xEffect saves time and material

The yard good can be cut with a saw of course. However, there is no need neither for deburring nor for cutting the conductor. Just cut to the required dimension and close with the fitting end cap -ready! The end caps have also breakable edges, which enable further connecting of the Busbar System xEffect. By overlapping assembly, doubling the cross section can be achieved.

Busbar System xEffect in use

Busbar System xEffect is especially well suited for solving flexible busbar applications rack-mounted models in series. Fork-pin combinations for 1+N applications can be realized by individual combinations - for this also the one-pole version with blue isolation is available besides the one with grey isolation. Even different cross sections can be combined in this case.

Accessories, such as feeder terminals and self adhesive phase marking labels will complete the comfortable total package. Existing contact prevention caps can be used.

Busbar System xEffect at a glance:

- Yard goods can be cut
- No cutting back of copper required
- No deburring required
- Almost no waste during cutting
- End caps available with 1- to 4-poles, end caps can be broken out for further extensions
- 4-pole end cap molded in pairs (left and right)
- Overlapping rail extension possible
- Rails can be extended on demand by 1-pole rails (plug-in technology)
- All step distances
- 10 and 16 mm²
- Fork and stud
- Lugs can be broken out at any predetermined breaking point
- Self adhesive phase indication labels available
- Contact preventing caps (ZV-BS-G) can be used
- Simple, flexible handling
- All assembly requirements can be covered by the Busbar System xEffect
- Low storage space requirements due to modular system
- Less time consuming (no deburring, no cutting back)
- Individual and self configurable
- Fork-pin combination for 1+N application possible, feeding through rail (terminal clamp) not possible.
- Protected technology

Description	Step Distance (mm)	Cu-factor	Type Designation	Article No.	Units per package
-------------	--------------------	-----------	------------------	-------------	-------------------

xEffect busbar 1m 10mm², 16mm² (Fork) BB-EVF

for MCBs, RCCBs, RCBOs, SPDs

- Delivered without end caps

SG13113



SG13413

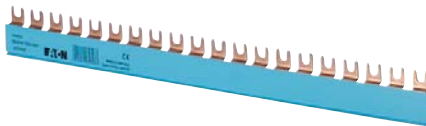

10 mm², Rated Current 63 A

1-phase	17.8	0.22	BB-EVF-10/1P-1MU	168826	10
	27	0.24	BB-EVF-10/1P-2MU	168830	10
	36	0.24	BB-EVF-10/1P-3MU	168834	10
2-phase	17.8	0.31	BB-EVF-10/2P-1MU	168838	10
	27	0.36	BB-EVF-10/2P-2MU	168840	10
3-phase	17.8	0.46	BB-EVF-10/3P-1MU	168842	10
	27	0.58	BB-EVF-10/3P-2MU	168844	10
	36	0.56	BB-EVF-10/3P-3MU	168850	10
3-phase + AUX	3x17.5+1x9	0.58	BB-EVF-10/3P-1MU/AUX	168846	10
	3x17.5+2x9	0.57	BB-EVF-10/3P-1MU2AUX	168848	10
Neutral	17.8	0.22	BB-EVF-10/N-1MU	168828	10
	27	0.24	BB-EVF-10/N-2MU	168832	10
	36	0.24	BB-EVF-10/N-3MU	168836	10

SG13213



SG13613

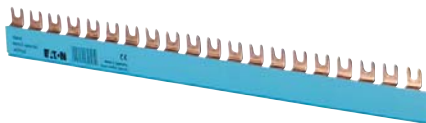

16 mm², Rated Current 80 A

1-phase	17.8	0.33	BB-EVF-16/1P-1MU	168827	10
	27	0.36	BB-EVF-16/1P-2MU	168831	10
	36	0.32	BB-EVF-16/1P-3MU	168835	10
2-phase	17.8	0.46	BB-EVF-16/2P-1MU	168839	10
	27	0.54	BB-EVF-16/2P-2MU	168841	10
3-phase	17.8	0.69	BB-EVF-16/3P-1MU	168843	10
	27	0.87	BB-EVF-16/3P-2MU	168845	10
	36	0.84	BB-EVF-16/3P-3MU	168851	10
3-phase + AUX	3x17.5+1x9	0.87	BB-EVF-16/3P-1MU/AUX	168847	10
	3x17.5+2x9	0.86	BB-EVF-16/3P-1MU2AUX	168849	10
Neutral	17.8	0.33	BB-EVF-16/N-1MU	168829	10
	27	0.36	BB-EVF-16/N-2MU	168833	10
	36	0.32	BB-EVF-16/N-3MU	168837	10

Description	Step Distance (mm)	Cu-factor	Type Designation	Article No.	Units per package
-------------	--------------------	-----------	------------------	-------------	-------------------

xEffect busbar 1m 10mm², 16mm² (Pin) BB-EVP

for MCBs, RCCBs, RCBOs, SPDs

- Delivered without end caps

SG13013



10 mm², Rated Current 63 A

1-phase	17.8	0.22	BB-EVP-10/1P-1MU	168852	10
	27	0.24	BB-EVP-10/1P-2MU	168856	10
	36	0.24	BB-EVP-10/1P-3MU	168860	10
2-phase	17.8	0.31	BB-EVP-10/2P-1MU	168864	10
	27	0.36	BB-EVP-10/2P-2MU	168866	10
3-phase	17.8	0.46	BB-EVP-10/3P-1MU	168868	10
	27	0.58	BB-EVP-10/3P-2MU	168870	10
3-phase + AUX	3x17.5+1x9	0.58	BB-EVP-10/3P-1MU/AUX	168872	10
	3x17.5+2x9	0.57	BB-EVP-10/3P-1MU2AUX	168874	10
Neutral	17.8	0.22	BB-EVP-10/N-1MU	168854	10
	27	0.24	BB-EVP-10/N-2MU	168858	10
	36	0.24	BB-EVP-10/N-3MU	168862	10

SG13513

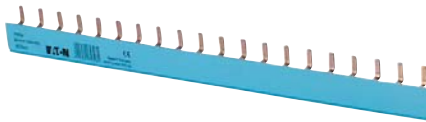

SG12913



16 mm², Rated Current 80 A

1-phase	17.8	0.33	BB-EVP-16/1P-1MU	168853	10
	27	0.36	BB-EVP-16/1P-2MU	168857	10
	36	0.32	BB-EVP-16/1P-3MU	168861	10
2-phase	17.8	0.46	BB-EVP-16/2P-1MU	168865	10
	27	0.54	BB-EVP-16/2P-2MU	168867	10
3-phase	17.8	0.69	BB-EVP-16/3P-1MU	168869	10
	27	0.87	BB-EVP-16/3P-2MU	168871	10
	36	0.84	BB-EVP-16/3P-3MU	168877	10
3-phase + AUX	3x17.5+1x9	0.87	BB-EVP-16/3P-1MU/AUX	168873	10
	3x17.5+2x9	0.86	BB-EVP-16/3P-1MU2AUX	168875	10
Neutral	17.8	0.33	BB-EVP-16/N-1MU	168855	10
	27	0.36	BB-EVP-16/N-2MU	168859	10
	36	0.32	BB-EVP-16/N-3MU	168863	10

SG13313

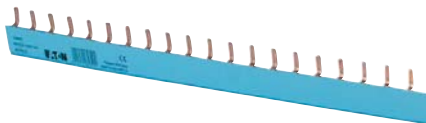

Description	Cu-factor	Type Designation	Article No.	Units per package
-------------	-----------	------------------	-------------	-------------------

Accessories

End caps BB-EV-EC

wa_sg05612



1-phase	-	BB-EV-EC/1P	168878	40
2+3-phase	-	BB-EV-EC/2-3P	168823	40
4-phase	-	BB-EV-EC/4P	168824	20
Neutral	-	BB-EV-EC/N	168879	20

Terminal BB-EV-TE/35

wa_sg05312



	0.04	BB-EV-TE/35	168825	3
--	------	-------------	--------	---

Sticker phase sequence

SG08713



	-	BB-S-PS	169831	5
--	---	---------	--------	---

Busbar Tag Shrouds ZV-BS-G

SG05705



	-	ZV-BS-G	104903	10/600
--	---	---------	--------	--------

Technical Data

BB-EV.	
General	
Heat deflection temperature	≥80°C UL94 V0
Standards	EN 60947-1:2007 / IEC 60947-1:2007 / IEC 60999:2000
Climate stability	according to DIN EN 60068
Insulation coordination	Overvoltage category III / Degree of pollution 2
Electrical	
Impulse voltage strenght	≥4.5 kV
Min. air distance	>5.5 mm
Min. creeping distance	>5 mm
Max. operating voltage	690 V AC/DC 1,000 V DC 1-pole only
Max. current I _g /Phase	
10 mm ²	63 A
16 mm ²	80 A
Protection class	IP20
Short circuit rating I _{CC}	25kA - NH3 355A gC500V JM
Dielectric strenght	PC - ABS >32 kV / mm

Assembly instruction:

Cutting

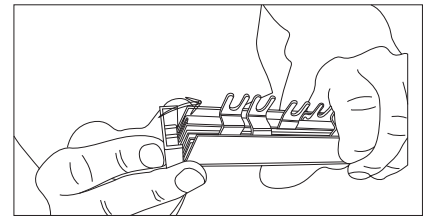
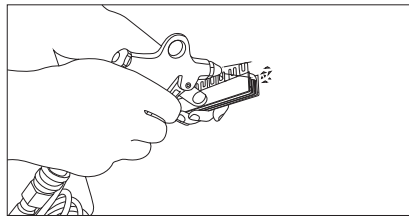
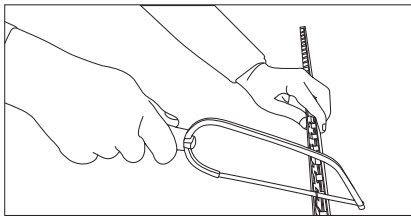

Mounting of an extension busbar

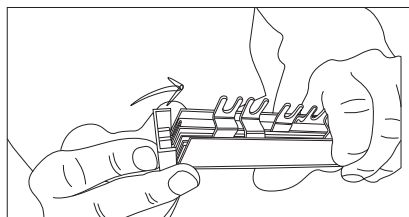
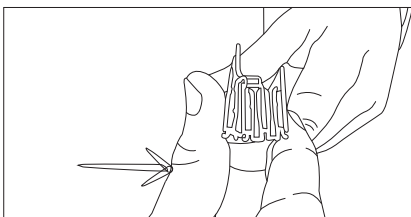
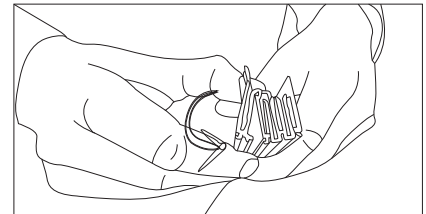
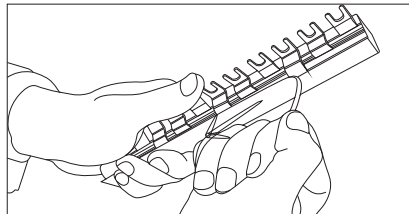
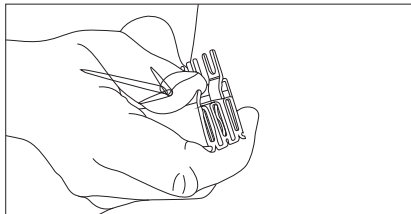

Overlapping mounting or further connection, resp.

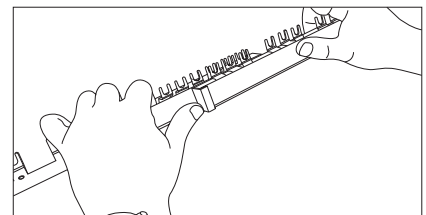
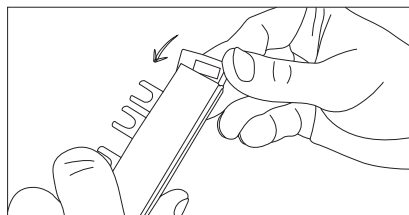
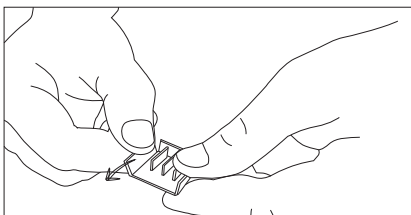

Bracking out of connection lugs

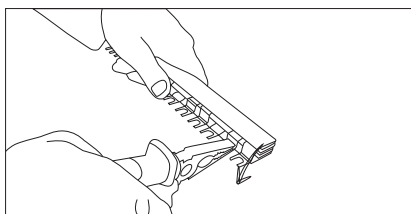

Sticking on phase marking

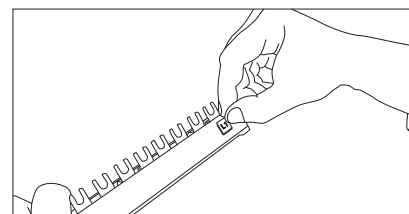

Busbar UL489 Z-BB/UL

SG13713



- For MCB FAZ-NA/RT/DU
- Sliceable
- 18 and 25 mm²
- Pin busbar
- Accessories available:
 - End cap
 - Terminal
 - Busbar tag shrouds
- Length 1 m

Description	Step Distance (mm)	Cu-factor	Type Designation	Article No.	Units per package
-------------	--------------------	-----------	------------------	-------------	-------------------

Busbar UL489 sliceable 1m 18mm², 25mm² (Pin), Z-BB/UL

for FAZ-NA/RT/DU

- Delivered without end caps

SG13713



18 mm², Rated Current 80 A

1-phase	17.6	0.39	Z-BB/UL18/1P1MU/57	171128	10
1-phase + AUX	26.4	0.378	Z-BB/UL18/1P1MU+AUX/37	171134	10
2x 1-phase + AUX	26.4	0.56	Z-BB/UL18/2X1P1MU+AUX/38	171142	10
3x 1-phase + AUX	26.4	0.945	Z-BB/UL18/3X1P1MU+AUX/39	171140	10
2-phase	17.6	0.625	Z-BB/UL18/2P1MU/56	171129	10
2-phase + AUX	17.6 + 26.4	0.625	Z-BB/UL18/2P1MU+AUX/46	171135	10
3-phase	17.6	0.95	Z-BB/UL18/3P1MU/57	171130	10
3-phase + AUX	2x 17.6 + 26.4	0.93	Z-BB/UL18/3P1MU+AUX/48	171136	10

SG14213



25 mm², Rated Current 100 A

1-phase	17.6	0.535	Z-BB/UL25/1P1MU/57	171131	10
1-phase + AUX	26.4	0.745	Z-BB/UL25/1P1MU+AUX/37	171137	10
2x 1-phase + AUX	26.4	0.78	Z-BB/UL25/2X1P1MU+AUX/38	171143	10
3x 1-phase + AUX	26.4	1.315	Z-BB/UL25/3X1P1MU+AUX/39	171141	10
2-phase	17.6	0.888	Z-BB/UL25/2P1MU/56	171132	10
2-phase + AUX	17.6 + 26.4	0.87	Z-BB/UL25/2P1MU+AUX/46	171138	10
3-phase	17.6	1.31	Z-BB/UL25/3P1MU/57	171133	10
3-phase + AUX	2x 17.6 + 26.4	1.28	Z-BB/UL25/3P1MU+AUX/48	171139	10

Description	Cu-factor	Type Designation	Article No.	Units per package
-------------	-----------	------------------	-------------	-------------------

Accessories

End cap Z-ECUL

-	-	Z-ECUL	171145	10
---	---	--------	--------	----

Terminal Z-TEUL35

0,038	-	Z-TEUL35	171144	10
-------	---	----------	--------	----









Busbar Tag Shrouds Z-FPUL

SG08613



-	-	Z-FPUL	171146	10
---	---	--------	--------	----

Description of the Busbar UL489, Z-BB/UL for FAZ-NA, -RT, -DU

									
Z-BB/UL18/1P1MU/57	171128	57	-	-	-	-	-	-	-
Z-BB/UL18/2P1MU/56	171129	-	56	-	-	-	-	-	-
Z-BB/UL18/3P1MU/57	171130	-	-	57	-	-	-	-	-
Z-BB/UL25/1P1MU/57	171131	57	-	-	-	-	-	-	-
Z-BB/UL25/2P1MU/56	171132	-	56	-	-	-	-	-	-
Z-BB/UL25/3P1MU/57	171133	-	-	57	-	-	-	-	-
Z-BB/UL18/1P1MU+AUX/37	171134	-	-	-	37	-	-	-	-
Z-BB/UL18/2P1MU+AUX/46	171135	-	-	-	-	-	-	46	-
Z-BB/UL18/3P1MU+AUX/48	171136	-	-	-	-	-	-	-	48
Z-BB/UL25/1P1MU+AUX/37	171137	-	-	-	37	-	-	-	-
Z-BB/UL25/2P1MU+AUX/46	171138	-	-	-	-	-	-	46	-
Z-BB/UL25/3P1MU+AUX/48	171139	-	-	-	-	-	-	-	48
Z-BB/UL18/3X1MU+AUX/39	171140	-	-	-	-	-	39	-	-
Z-BB/UL25/3X1MU+AUX/39	171141	-	-	-	-	-	39	-	-
Z-BB/UL18/2X1MU+AUX/38	171142	-	-	-	-	38	-	-	-
Z-BB/UL25/2X1MU+AUX/38	171143	-	-	-	-	38	-	-	-
Z-TEUL35	171144	-	-	-	-	-	-	-	-
Z-ECUL	171145	-	-	-	-	-	-	-	-
Z-FPUL	171146	-	-	-	-	-	-	-	-

Technical Data

Z-BB/UL	
General	
Heat deflection temperature	>100°C - UL94 V0
Standards	UL489, EN 60947-1, IEC 60947-1:2004
Climate stability	according to DIN EN 60068
Insulation coordination	Overvoltage category III / Degree of pollution 2
Electrical	
Impulse voltage strenght	≥10 kV
Min. air distance	≥1" ext.
Min. creeping distance	≥2" ext.
Max. operating voltage	
1-pole	1,000 V AC/DC
2-, 3-pole	600 V AC/DC
Max. current I _s /Phase	
18 mm ²	80 A
25 mm ²	100 A
Protection class	IP20
Short circuit rating I _{CC}	10 kA
Dielectric strenght	PA66-V0, >35 kV

Mounting example of busbar UL489, Z-BB/UL for FAZ-NA, -RT, -DU

Z-BB/UL18/XX
Z-BB/UL25/XX

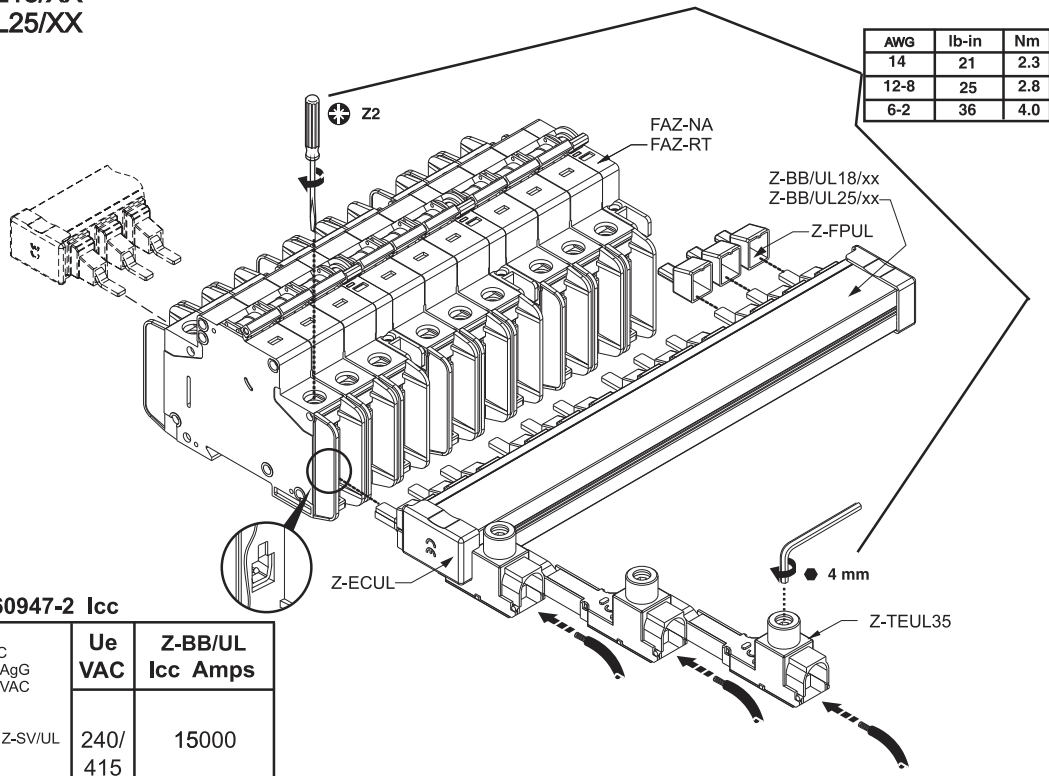

IEC/EN 60947-2 Icc

Ue HRC 315AgG 500VAC	Ue VAC	Z-BB/UL Icc Amps
Z-SV/UL	240/ 415	15000

UL SCCR

Ue Z-SV/UL	FAZ-NA FAZ-RT In Amps	Ue VAC	Z-BB/UL SCCR RMS Sym Amps
FAZ-NA FAZ-RT	0.5-32	480Y/ 277	10000
	35-40	240	10000

Busbar UL508 BB/UL

- For MCB FAZ
- Sliceable
- 18 and 25 mm²
- Pin busbar
- Accessories available:
 - End caps
 - Terminals
 - Busbar tag shrouds
- Length 1 m

Description	Step Distance (mm)	Cu-factor	Type Designation	Article No.	Units per package
-------------	--------------------	-----------	------------------	-------------	-------------------

Busbar UL508 sliceable 1m 18mm², 25mm² (Pin), BB/UL

for FAZ

- Delivered without end caps

18 mm², Rated Current 80 A

1-phase	17.8	0.33	BB-UL-18/1P-1M/57	121981	10
2-phase	17.8	0.508	BB-UL-18/2P-2M/56	121982	10
3-phase	17.8	0.8	BB-UL-18/3P-3M/57	121983	10
1-phase + AUX	27	0.33	BB-UL-18/1P-1,5M/37	121984	10
2-phase + AUX	17.8 + 26.7	0.52	BB-UL-18/2P+AS-2,5M/46	121987	10
3-phase + AUX	2x 17.8 + 26.7	0.8	BB-UL-18/3P+AS-3,5M/48	121988	10

25 mm², Rated Current 100 A

1-phase	17.8	0.45	BB-UL-25/1P-1M/57	121989	10
2-phase	17.8	0.68	BB-UL-25/2P-2M/56	121990	10
3-phase	17.8	1.07	BB-UL-25/3P-3M/57	121991	10
1-phase + AUX	27	0.45	BB-UL-25/1P-1,5M/37	121992	10
2-phase + AUX	17.8 + 26.7	0.69	BB-UL-25/2P+AS-2,5M/46	121995	10
3-phase + AUX	2x 17.8 + 26.7	1.03	BB-UL-25/3P+AS-3,5M/48	121996	10

Description	Cu-factor	Type Designation	Article No.	Units per package
-------------	-----------	------------------	-------------	-------------------

Accessories

End caps BB-UL-EC

1-phasig	-	BB-UL-EC/1	122000	10
3-phasig	-	BB-UL-EC/3	122001	10



Terminals BB-UL-TE

6 - 35mm ² (single and multi wire)	0,035	BB-UL-TEP/35	121997	10
6 - 50mm ²	0,038	BB-UL-TEPA/35	169823	10
6 - 50mm ² (single and multi wire)	0,038	BB-UL-TE/50	121998	10

Busbar Tag Shrouds BB-IP/5

for 5 pins	-	BB-IP/5	121999	10
------------	---	---------	--------	----

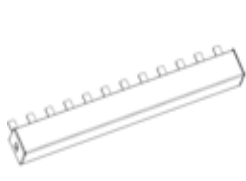
Description of the Busbar UL508, BB/UL for FAZ

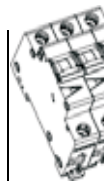
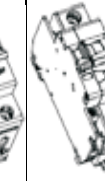
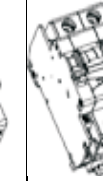
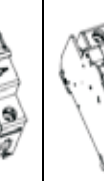

Article No.							
121981	BB-UL-18/1P-1M/57	57	-	-	-	-	-
121982	BB-UL-18/2P-2M/56	-	28	-	-	-	-
121983	BB-UL-18/3P-3M/57	-	-	19	-	-	-
121984	BB-UL-18/1P-1,5M/37	-	-	-	37	-	-
121987	BB-UL-18/2P+AS-2,5M/46	-	-	-	-	23	-
121988	BB-UL-18/3P+AS-3,5M/48	-	-	-	-	-	16
121989	BB-UL-25/1P-1M/57	57	-	-	-	-	-
121990	BB-UL-25/2P-2M/56	-	28	-	-	-	-
121991	BB-UL-25/3P-3M/57	-	-	19	-	-	-
121992	BB-UL-25/1P-1,5M/37	-	-	-	37	-	-
121995	BB-UL-25/2P+AS-2,5M/46	-	-	-	-	23	-
121996	BB-UL-25/3P+AS-3,5M/48	-	-	-	-	-	16
121997	BB-UL-TEP/35	-	-	-	-	-	-
169823	BB-UL-TEPA/35	-	-	-	-	-	-
121998	BB-UL-TE/50	-	-	-	-	-	-
121999	BB-IP/5	-	-	-	-	-	-
122000	BB-UL-EC/1	-	-	-	-	-	-
122001	BB-UL-EC/3	-	-	-	-	-	-

Technical Data

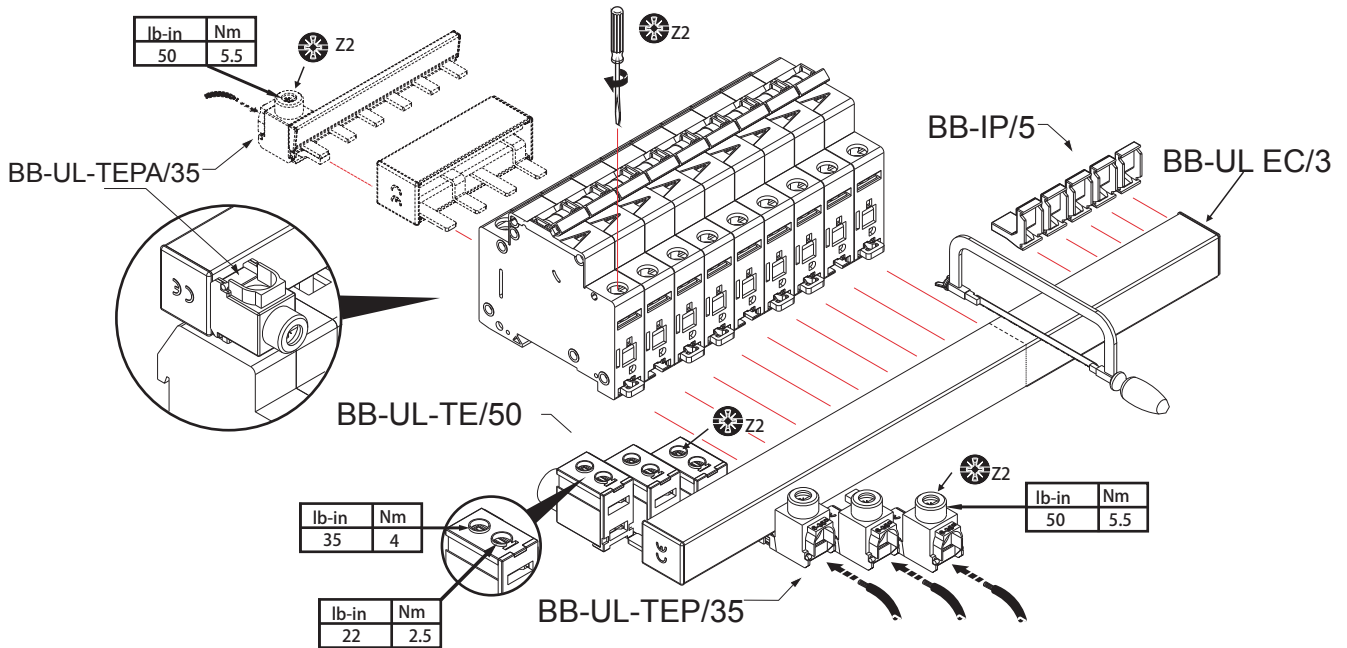

Z-BB/UL	
General	
Heat deflection temperature	125°C - UL94 V0
Standards	DIN EN 60947-2, VDE 0660 - 101 = IEC 60947-2, IEC 60999:2000, UL508, UL486A, CSA C22.2
Climate stability	according to DIN EN 60068
Insulation coordination	Overvoltage category III / Degree of pollution 2
Electrical	
Impulse voltage strenght	≥9.5 kV
Min. air distance	>9.5 mm
Min. creeping distance	>12.7 mm
Max. operating voltage	
1-pole	1,000 V AC/DC
2-, 3-pole	IEC/EN 690 V AC/DC 600 V AC/DC UL Fuse 480 V AC/DC UL-SP
Terminals	1, 000 V AC/DC
Max. current I _g /Phase	
18 mm ²	80 A (feed in the center: 160 A)
25 mm ²	100 A (feed in the center: 200 A)
Protection class	IP20
Short circuit rating	10kA 3 cycles@480V / 100 kA Fuse Class J 175A@18mm ² - 200A@25mm ²
Dielectric strenght	>32 kV/mm

Mounting example of busbar UL508, BB/UL for FAZ

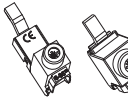

BB-UL-TE/50		
	UL508	EN/IEC 60947-2
U_e	480 V AC	240/690V AC
f	50/60 Hz	50/60 Hz
I_e	115 A @ 40° C	160 A @ 30° C
	#1-14 AWG 60/75° C Cu	1.5 – 50 mm ² Cu
	0.56 in	14 mm

BB-UL		
	UL508	EN/IEC 60947-2
U_e	480 V AC	690V AC
f	50/60 Hz	
I_{pk}	10kA	15kA
I_e	18mm \boxtimes	25mm \boxtimes
Infeed at the start of the busbar	80A@40° C	100A@30° C
Infeed at the center of the busbar	160A@40° C	200A@30° C

BB-UL-TEP/35 / BB-UL-TEPA/35		
	UL508	EN/IEC 60947-2
U_e	480 V AC	240/690V AC
f	50/60 Hz	50/60 Hz
I_e	115 A@40° C	80 A@30° C
	#2-14 AWG 60/75° C Cu	2.5 – 35 mm ² Cu
	0.56 in	14 mm

*-UL508 SHORT CIRCUIT RATINGS

-SUITABLE FOR USE ON A CIRCUIT CAPABLE OF DELIVERING NOT MORE THAN 10,000 RMS SYMMETRICAL AMPERES, 600 VOLTS MAXIMUM.

-SUITABLE FOR USE ON A CIRCUIT CAPABLE OF DELIVERING NOT MORE THAN 100,000 RMS SYMMETRICAL AMPERES, 600 VOLTS MAXIMUM WHEN PROTECTED BY A CLASS J FUSE RATED 175A.

Busbar UL489 Z-SV/UL16

wa_sg03511



- For MCB FAZ-NA/RT/DU
- 16 mm²
- Pin busbar
- Accessories available:
 - Terminals
 - Busbar tag shrouds
- Several length

Description	Step Distance (mm)	Cu-factor	Type Designation	Article No.	Units per package
-------------	--------------------	-----------	------------------	-------------	-------------------

Busbar UL489 16mm² (Pin), Z-SV/UL16

for FAZ-NA/RT/DU, not sliceable!!

- Delivered with end caps

wa_sg03511



16 mm², Rated Current 80 A

1-phase, 6MU	17.6	0.035	Z-SV/UL-16/1P-1MU/6	104892	10
1-phase, 12MU	17.6	0.07	Z-SV/UL-16/1P-1MU/12	104893	10
1-phase, 18MU	17.6	0.105	Z-SV/UL-16/1P-1MU/18	104894	10
2-phase, 6MU	17.6	0.07	Z-SV/UL-16/2P-2MU/6	104895	10
2-phase, 12MU	17.6	0.14	Z-SV/UL-16/2P-2MU/12	104896	10
2-phase, 18MU	17.6	0.21	Z-SV/UL-16/2P-2MU/18	104897	10
3-phase, 6MU	17.6	0.14	Z-SV/UL-16/3P-3MU/6	104898	10
3-phase, 12MU	17.6	0.221	Z-SV/UL-16/3P-3MU/12	104899	10
3-phase, 18MU	17.6	0.332	Z-SV/UL-16/3P-3MU/18	104900	10

Description	Cu-factor	Type Designation	Article No.	Units per package
-------------	-----------	------------------	-------------	-------------------

Accessories

Terminals Z-TEUL35

SG07506



2.5 - 35mm ²	0.035	Z-EK/35/UL	104901	3
1.5 - 50mm ²	0.038	Z-EB/50/UL	104902	3

Busbar Tag Shrouds Z-FPUL

SG07706



for 3 pins	-	ZV-BS-UL	104904	10
------------	---	----------	--------	----

Description of the Busbar UL489, Z-SV/UL-16 for FAZ-NA/RT/DU

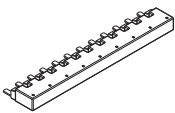
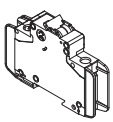
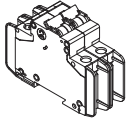
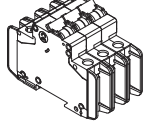
Article No.				
104892	Z-SV/UL-16/1P-1TE/6	6	-	-
104893	Z-SV/UL-16/1P-1TE/12	12	-	-
104894	Z-SV/UL-16/1P-1TE/18	18	-	-
104895	Z-SV/UL-16/2P-2TE/6	-	3	-
104896	Z-SV/UL-16/2P-2TE/12	-	6	-
104897	Z-SV/UL-16/2P-2TE/18	-	9	-
104898	Z-SV/UL-16/3P-3TE/6	-	-	2
104899	Z-SV/UL-16/3P-3TE/12	-	-	4
104900	Z-SV/UL-16/3P-3TE/18	-	-	6
104901	Z-EK/35/UL	-	-	-
104902	Z-EB/50/UL	-	-	-
104904	ZV-BS-UL	-	-	-

Technical Data

Z-SV/UL16	
General	
Heat deflection temperature	125°C - UL94 V0
Standards	
Busbar	UL489, DIN EN 60947-1, VDE 0660 part 100 = IEC 60947-1:2004, IEC 60947-2:2003
Terminal	IEC 60999:2000, UL489, UL486A, CSA C22.2
Climate stability	according to DIN EN 60068
Insulation coordination	Overvoltage category III / Degree of pollution 2
Electrical	
Impulse voltage strenght	≥9.5 kV (1kV / mmLS)
Min. air distance	>9.5mm/25.4mm (intern/external)
Min. creeping distance	>12.7mm/50.8mm (intern/external)
Max. operating voltage	
1-, 3-phase	690 V IEC 480Y/277V & 240V AC
Terminals	1,000 V AC/DC
Max. current I _g /Phase	80 A
Protection class	IP20
Short circuit rating	15kA with NH3 355 A gL 500V JM / 7.5kA 3 cycles @ 600V
Dielectric strenght	>30 kV/mm

Mounting example of busbar UL489, Z-SV/UL-16 for FAZ-NA, -RT, -DU



ATTENTION: Maximum of 3 commoning links allowed. Any combination of same pole configuration.

ATTENTION: 3 liaisons communes autorisées au maximum. Toute combinaison de configurations de polarité identiques.

ACHTUNG: Maximal 3 Schienenblöcke. Beliebige Kombination gleichpoliger Konfigurationen.

ATTENZIONE: Sono consentiti al massimo 3 pettini di collegamento in qualsiasi combinazione della stessa configurazione di poli.

ATENCIÓN: Se permite un máximo de 3 enlaces comunes. Cualquier combinación del mismo tipo de configuración de polo



ATTENTION: Do not cut.

ATTENTION: Ne pas couper.



ACHTUNG: Nicht durchschneiden.

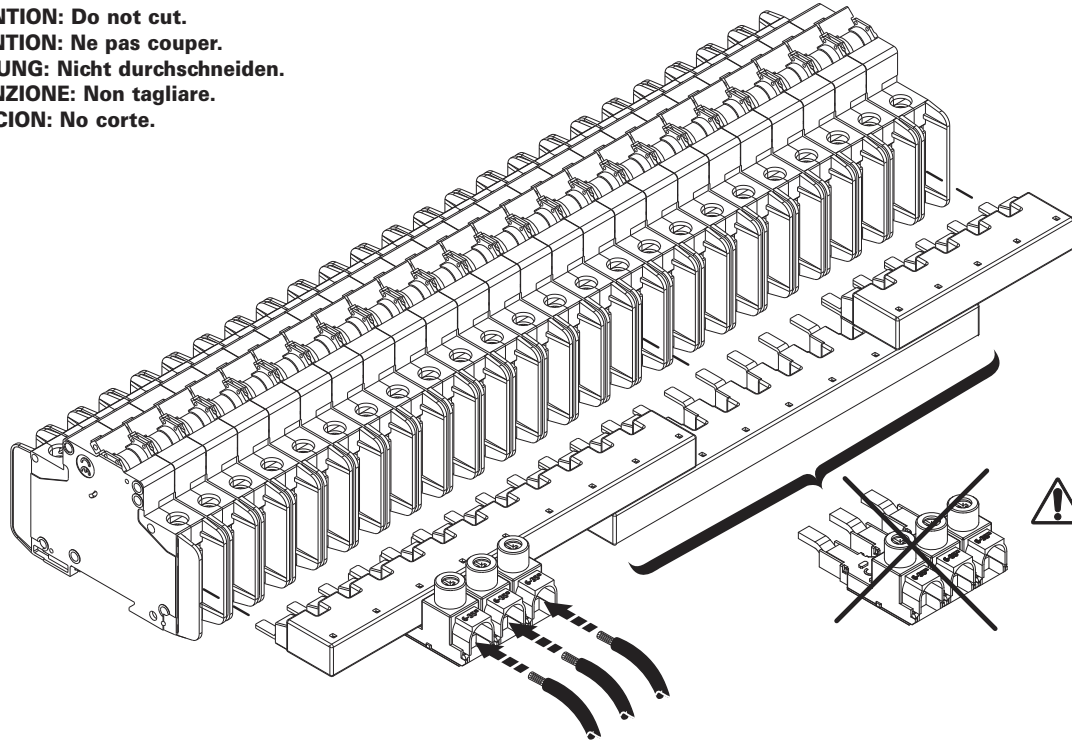

ATTENZIONE: Non tagliare.

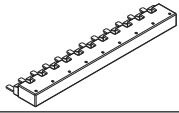
ATENCIÓN: No corte.

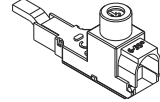

	UL489		EN/IEC 00947-2
U_e	480 V AC	96 V DC	240/415 V AC
f	50/60 Hz	-----	50/60 Hz
U_{imp}	-----		9.5 kV
I_e	80 A @ 40°C		80 A @ 30°C
Cross section	-----		16 mm ²

	UL489		EN/IEC 00947-2
U_e	480 V AC	96 V DC	240/415 V AC
f	50/60 Hz	-----	50/60 Hz
U_{imp}	-----		9.5 kV
	#1-14 AWG	1.5-50 mm ²	
	60/75°C Cu	Cu	
	0.56 in	14 mm	

	UL489		EN/IEC 00947-2
U_e	480 V AC	96 V DC	240/415 V AC
f	50/60 Hz	-----	50/60 Hz
U_{imp}	-----		9.5 kV
I_e	80 A @ 40°C		80 A @ 30°C
	#2-14 AWG	2.5-35 mm ²	
	60/75°C Cu	Cu	
	0.56 in	14 mm	

Mounting example of busbar UL489, Z-SV/UL-16 for FAZ-NA, -RT, -DU

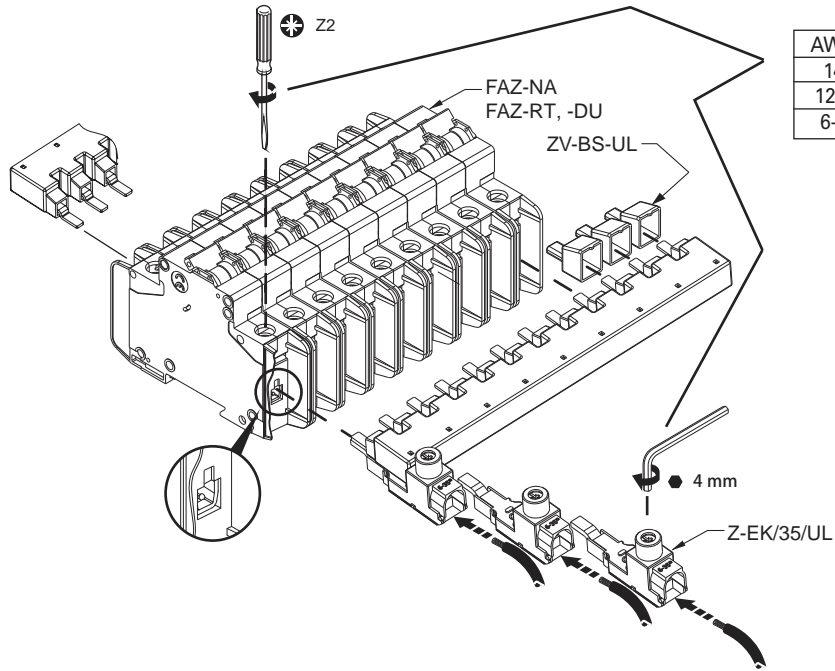

AWG	lb-in	Nm
14	21	2.3
12-8	25	2.8
6-2	36	4.0

IEC/EN 60947-2 Icc

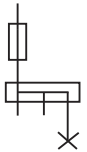
	Ue VAC	Z-SV/UL Icc Amps
	240/ 415	15000

UL SCCR

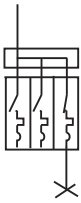
	FAZ-NA FAZ-RT/-DU In Amps	Ue VAC	Z-SV/UL SCCR RMS Sym Amps
	0.5-32	480Y/ 277	10000
	35-40	240	10000

Accessories for RCDs, MCBs, Combined RCD/MCB Devices

SG60811







- Auxiliary Switch
- RCD-Tripping Module
- Shunt Trip Release
- Undervoltage Release
- Remote Control and Automatic Switching Device
- Switching Interlocks
- Terminal Covers

SG60811



Auxiliary Switch Z-HK, Z-AHK, Z-HD; Tripping Signal Switch Z-NHK

Design: for screwing

	For Protective Device / Function	Type Designation	Article No.	Units per package
 <p>SG34812</p>	RCCB / 1NO+1NC	Z-HK	248432	4/120
 <p>SG60911</p>	MCB, RCBO, RCCB / 1NO+1NC	Z-AHK	248433	4/120
 <p>SG61011</p>	MCB, RCBO, RCCB / 2CO	Z-NHK	248434	4/120
 <p>SG34412</p>	RCCB / 1CO+1NC	Z-HD	265620	1

Specifications | Auxiliary Switch Z-HK, Z-AHK; Tripping Signal Switch Z-NHK

Description

- Design according to IEC/EN 60947-5-1, IEC/EN 62019
- Can be mounted subsequently (screws) onto FRCmM, FRCdM
- The specified minimum voltages are per contact.
Take into account particularly in case of series connection!
- **Z-AHK, Z-NHK:** Contact function with relative movement (self-cleaning contacts)
- Contact material and design particularly suitable for extra low voltage
- **Z-NHK:** The function of one of the two change-over contacts can be switched from "auxiliary switch" to "tripping signal switch"
- Tripping signal contact transmits message of electric tripping, not mechanical switch-off
- Test key for contact function "electrical tripping"

Technical Data

	Z-HK	Z-AHK	Z-NHK
Electrical			
Contact function	1NO + 1NC	1NO + 1NC	2CO
Rated voltage	250 V	250 V	250 V
Frequency	50/60 Hz	50/60 Hz	50/60 Hz
Rated current	8 A	4 A	4 A
Rated thermal current	I_{th} 8 A	4 A	4 A
Utilisation category AC13			
Rated operational current	I_e 6A/250V AC 2A/440V AC	3A/250V AC -	3A/250V AC -
Utilisation category AC15			
Rated operational current	I_e -	2A/250V AC	2A/250V AC
Utilisation category DC12			
Rated operational current	I_e -	0.5A/110V DC	0.5A/110V DC
Utilisation category DC13			
Rated operational current	I_e 0.5A/230V DC 2A/110V DC 4A/60V DC	- - -	- - -
Rated insulation voltage	U_i 250 V AC	250 V AC	250 V AC
Minimum operational voltage per contact	U_{min} 24 V AC/DC	5 V DC	5 V DC
Minimum operational current	I_{min} 50 mA AC/DC	10 mA DC	10 mA DC
Rated peak withstand voltage	U_{imp} (1.2/50 μ) 2.5 kV	2.5 kV	2.5 kV
Conditional short circuit current	I_k		
with back-up fuse 6A or FAZ-B4-HS	1 kA	1 kA	1 kA
Max. back-up fuse, overload and short circuit	6 A gL / FAZ-4/..B-HS	4 A gL / FAZ-4/..B-HS	4 A gL / FAZ-4/..B-HS
Mechanical			
Can be mounted from the left onto	RCCB	MCB, RCBO	MCB, RCBO
Can be mounted from the right onto	-	-	RCCB
Tripping indicator "electrical tripping"	-	-	blue/white
Frame size	45 mm	45 mm	45 mm
Device height	80 mm	80 mm	80 mm
Device width	8.8 mm (0.5MU)	8.8 mm (0.5MU)	8.8 mm (0.5MU)
Mounting	onto switching device	onto switching device	onto switching device
Degree of protection, built-in	IP40	IP40	IP40
Terminal protection	finger and hand touch safe according to BGV A3, ÖVE-EN 6		
Terminals	lift terminals	lift terminals	lift terminals
Terminal capacity	0.5-2.5 mm ²	0.5-2.5 mm ²	0.5-2.5 mm ²
Terminal screws	M3 (Pozidrive Z0)	M3 (Pozidrive Z0)	M3 (Pozidrive Z0)
Fastening torque of terminal screws	max. 0.8-1.0 Nm	max.0.8-1.0 Nm	max. 0.8-1.0 Nm

Connection diagram

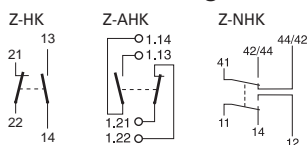

Dimensions (mm)

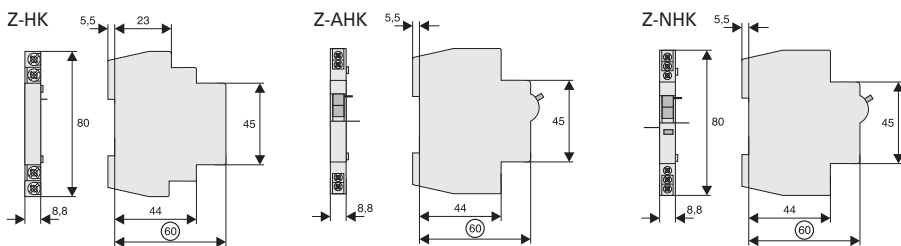

Example: Z-HK+RCCB

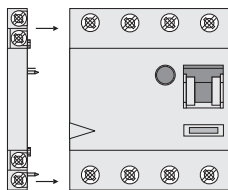

1NO+1NC 24V 50mA min.

Example: Z-AHK+MCB



1NO+1NC 5V 10mA min.

Example: Z-NHK+MCB RCCB+Z-NHK

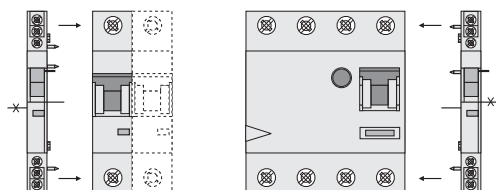

2CO 5V 10mA min.

Specifications | Auxiliary Switch Z-HD

Function Auxiliary Switch Z-HD

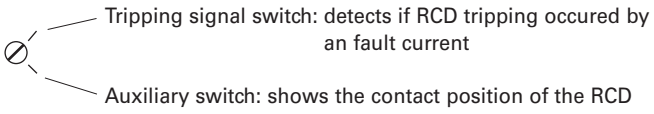

Technical Data

Z-HD	
Electrical	
Subsequent installation to the left onto	FRCmM-125A
Contacts	1CO + 1NC
Load rating	
AC11	6 A / 230 V AC
DC11	1 A / 230 V DC
Mechanical	
Terminal capacity	up to 2.5 mm ²

Connection diagram

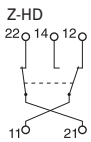

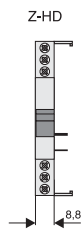

Dimensions (mm)



Auxiliary Switch ZP-AHK, ZP-IHK, ZP-WHK; Tripping Signal Switch ZP-NHK

Design: for snapping

	For Protective Device / Function	Type Designation	Article No.	Units per package
 <p>SG60811</p>	MCB, RCBO / 1NO+1NC	ZP-IHK	286052	4/120
 <p>SG34612</p>	MCB, RCBO / 1CO	ZP-WHK	286053	4/120
 <p>SG34512</p>	MCB, RCBO / 2CO	ZP-NHK	248437	4/120

Specifications | Auxiliary Switch ZP-IHK, ZP-WHK; Tripping Signal Switch ZP-NHK

Description

- Design according to IEC/EN 62019
- No screws required. Can be snapped onto FAZ and FRBmM-1N subsequently
- **ZP-IHK, ZP-WHK:** Can be snapped on additionally 1 time onto itself
- The specified minimum voltages are per contact. Take into account particularly in case of series connection!
- Contact material and design particularly suitable for extra low voltage.
- Contact function with relative movement (self-cleaning contacts)e)
- **ZP-NHK:** The function of one of the two change-over contacts can be switched from "auxiliary switch" to "tripping signal switch"
- Tripping signal contact transmits message of electric tripping, not mechanical switch-off
- **ZP-NHK:** The "Service button" is used to check whether or not the auxiliary switch is correctly wired in the tripping-signal-switch position. Activating the "service button" will mechanically simulate an electrical switch-off, so the mechanism for the electrical switchoff will disengage and can be checked. The main switchgear (MCB or combined MCB/RCD) connected to the ZP-NHK auxiliary switch does not need to trip as well during an inspection through the service button.

Technical Data

	ZP-IHK	ZP-WHK	ZP-NHK
Electrical			
Contact function	1NO + 1NC	1CO	2CO
Rated voltage	250 V	250 V	250 V
Frequency	50/60 Hz	50/60 Hz	50/60 Hz
Rated current	6 A	6 A	4 A
Rated thermal current	I_{th} 6 A	6 A	4 A
Utilisation category AC13			
Rated operational current	I_e 3A/250V AC	3A/250V AC	3A/250V AC
Utilisation category AC15			
Rated operational current	I_e 2A/250V AC	2A/250V AC	2A/250V AC
Utilisation category DC12			
Rated operational current	I_e 0.5A/110V DC	0.5A/110V DC	0.5A/110V DC
Rated insulation voltage	U_I 250 V AC	250 V AC	250 V AC
Minimum operational voltage per contact	U_{min} 5 V DC	5 V DC	5 V DC
Minimum operational current	I_{min} 10 mA DC	10 mA DC	10 mA DC
Rated peak withstand voltage	U_{imp} (1.2/50 μ) 2.5 kV	2.5 kV	2.5 kV
Conditional short circuit current			
with back-up fuse 6A or PLSM-B4-HS	I_k 1 kA	1 kA	1 kA
Max. back-up fuse, overload and short circuit	6 A gL / FAZ-B4-HS	6 A gL / FAZ-B4-HS	6 A gL / FAZ-B4-HS
Mechanical			
Can be mounted from the left onto	MCB, RCBO	MCB, RCBO	MCB, RCBO
Accessories:	ZP-ASA	ZP-ASA	ZP-ASA
Tripping indicator "electrical tripping"	–	–	blue/white
Frame size	45 mm	45 mm	45 mm
Device height	80 mm	80 mm	80 mm
Device width	8.8 mm (0.5MU)	8.8 mm (0.5MU)	8.8 mm (0.5MU)
Degree of protection, built-in	IP40	IP40	IP40
Terminal protection	finger and hand touch safe according to BGV A3, ÖVE-EN 6		
Terminals	lift terminals	lift terminals	lift terminals
Terminal capacity	0.5-2.5 mm ²	0.5-2.5 mm ²	0.5-2.5 mm ²
Terminal screws	M4 (Pozidrive Z2)	M4 (Pozidrive Z2)	M3 (Pozidrive Z0)
Fastening torque of terminal screws	max. 1.2 Nm	max. 1.2 Nm	max. 0.8-1.0 Nm

Connection diagram

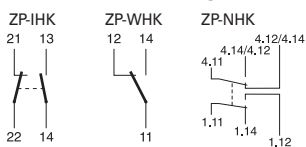

Dimensions (mm)

ZP-IHK, ZP-WHK

ZP-NHK

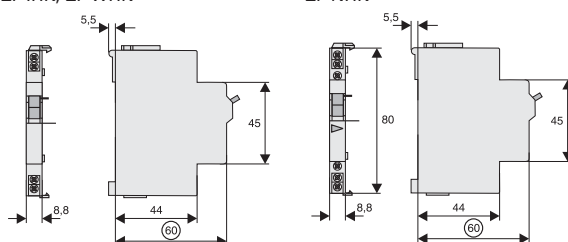

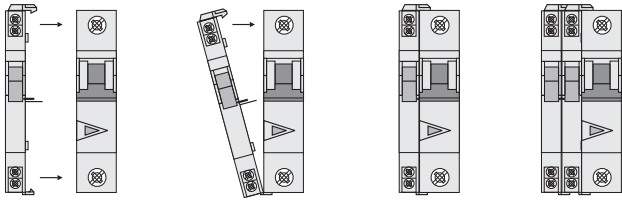

Example: ZP-IHK/(ZP-WHK)+MCB

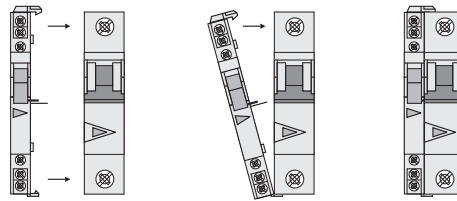

Example: ZP-NHK+MCB



RCCB-Tripping Module Z-.AM

	For Protective Device	Type Designation	Article No.	Units per package
 <p>SG16011</p>	RCCB	Z-FAM	248293	1/60
 <p>SG16211</p>	RCBO	Z-KAM	248294	1/60

Specifications | RCCB Tripping Module Z-FAM, Z-KAM

Description

- For remote switch-off of RCCBs, standard and electronic combined RCD/MCB devices
- Remote switch-off by one or several parallel potential-free contacts, e.g. pushbutton max. rated current 3 A at 250 V, take into account maximum pushbutton voltage
- Remote tripping test by means of remote testing module Z-FW
- Can be mounted subsequently, to be wired according to connection diagram with the respective terminals of the RCCB
- No undesired voltage rise in the consumer system during remote switch-off thanks to integrated breaker contact K1-K2

Technical Data

	Z-FAM	Z-KAM
Electrical		
Rated voltage	230(400) V AC	230(400) V AC
Frequency	50-60 Hz	50-60 Hz
Rated tripping current	$I_{\Delta n}$ 0.01 - 0.3 A	0.01 - 0.3 A
Function	1NO	1NO
Mechanical		
Tripping module for	RCCB	RCBO
Frame size	45 mm	45 mm
Device height	80 mm	80 mm
Device width	8.8 mm (0.5MU)	8.8 mm (0.5MU)
Degree of protection, built-in	IP40	IP40
Terminal capacity	1 - 2x2.5 mm ²	1 - 2x2.5 mm ²
Terminal protection	finger and hand touch safe, according to BGV A3, ÖVE-EN 6	

Connection diagram

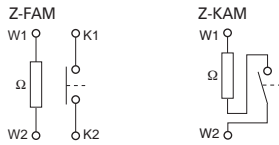

Dimensions (mm)

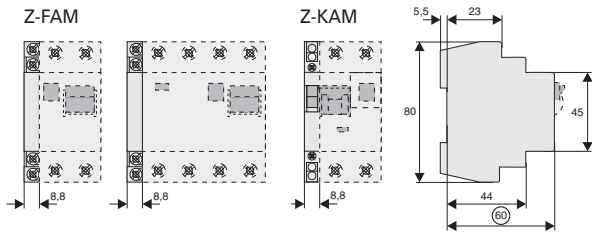

Connection examples Lay lines to the switching devices with double insulation **and** overload protection, e.g. 4A gL or CLS6-4..-HS

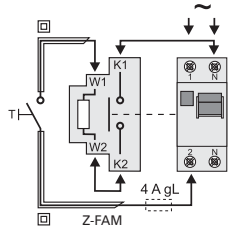

Connection diagram:
RCCB-2p, RCCB feed above

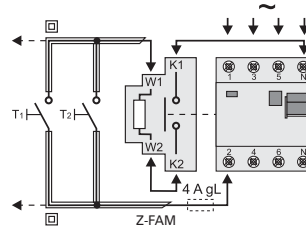

Connection diagram:
RCCB-4p, RCCB feed above

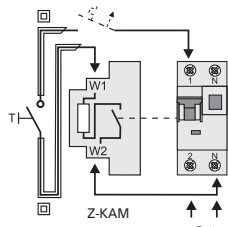

Connection diagram:
RCBO-2p, RCBO feed below

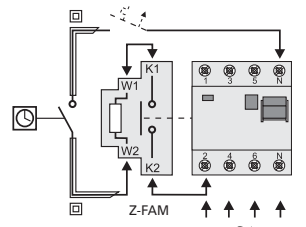

Connection diagram:
RCCB-4p, RCCB feed below

Shunt Trip Release Z-ASA, ZP-ASA

Operational voltage range (V-)	Type Designation	Article No.	Units per package
--------------------------------	------------------	-------------	-------------------

SG00712



To be glued on

12-110	Z-ASA/24	248286	1/60
110-415	Z-ASA/230	248287	1/60

SG00212



To be snapped on

12-110	ZP-ASA/24	248438	1/60
110-415	ZP-ASA/230	248439	1/60

Specifications | Shunt Trip Release Z-ASA, ZP-ASA

Description

- Remote release for subsequent mounting onto FAZ, FRBmM-1N, Z-MS
- Module width 1MU
- Additional installation of standard auxiliary switch is possible
- Position indicator red - green
- Type ZP-ASA for snap-on mounting

Technical Data

	Z-ASA24	Z-ASA230	ZP-ASA24	ZP-ASA230
Electrical				
Minimum pulse duration	15 ms	10 ms	15 ms	10 ms
Internal resistance	2.2 Ω	215 Ω	2.2 Ω	215 Ω
Duty cycle	100%	100%	100%	100%
Tripping time	< 20 ms	< 20 ms	< 20 ms	< 20 ms
Rated peak withstand voltage (1.2/50μs)	2.5 kV	2.5 kV	2.5 kV	2.5 kV
Endurance	> 4000 operating cycles	> 4000 operating cycles	> 4000 operating cycles	> 4000 operating cycles
AC voltage range				
Operating limit	10 V	60 V	10 V	60 V
Operational voltage range	12-110 V	110-415 V	12-110 V	110-415 V
Maximum current consumption during switch-on	15 A		2.1 A	15 A
Current flow time at max. current consumption	10 ms		10 ms	10 ms
DC voltage range				
Operating limit	9 V	72 V	9 V	72 V
Operational voltage range	10-60 V	110-220 V	10-60 V	110-220 V
Maximum current consumption during switch-on	21 A		1 A	21 A
Current flow time at max. current consumption	2 ms		2 ms	2 ms
Mechanical				
Frame size	45 mm	45 mm	45 mm	45 mm
Device height	80 mm	80 mm	80 mm	80 mm
Device width	17.5 mm (1MU)	17.5 mm (1MU)	17.5 mm (1MU)	17.5 mm (1MU)
Mounting	bonding	bonding	to snap on	to snap on
Degree of protection, built-in	IP40	IP40	IP40	IP40
Terminals above/below	open mouthed/lift	open mouthed/lift	open mouthed/lift with guide	open mouthed/lift with guide
Klemmquerschnitt	1-25 mm ²	1-25 mm ²	1-25 mm ²	1-25 mm ²
Fastening torque of terminal screws	max. 2.4 Nm	max. 2.4 Nm	max. 2.4 Nm	max. 2.4 Nm

Connection diagram

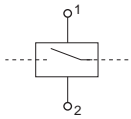

Dimensions (mm)

Z-ASA

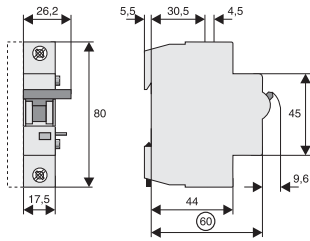

ZP-ASA

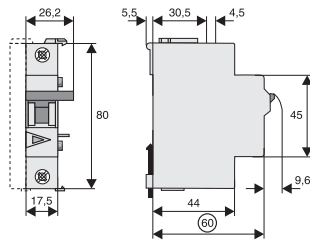

Connection Example 230 V

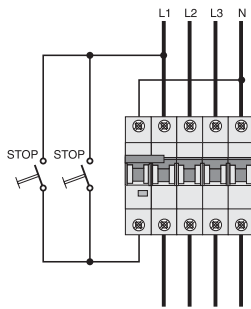

Connection Example 24 V

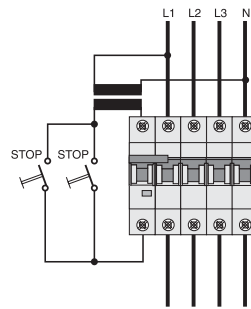

Example: Z-ASA + MCB

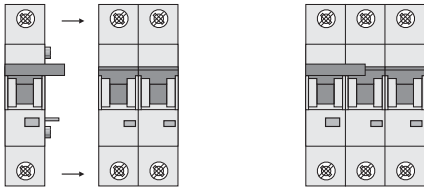

Example: ZP-ASA + MCB

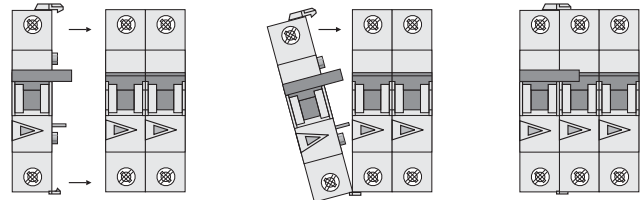

Undervoltage Release Z-USA, Z-USD

SG78811



Operational voltage range (V-) / Function	Type Designation	Article No.	Units per package
To be screwed on			
115 / undelayed	Z-USA/115	248288	1/60
230 / undelayed	Z-USA/230	248289	1/60
400 / undelayed	Z-USA/400	248290	1/60
115 / delayed 0.4s	Z-USD/115	248292	1/60
230 / delayed 0.4s	Z-USD/230	248291	1/60

Specifications | Undervoltage Release Z-USA, Z-USD

Description

- Tripping:
Instantaneous Z-USA
Delayed Z-USD, typ. 0,4 s
- Voltage control indicator blue/white
- Service key for zero voltage switch-on for testing purposes
- Can be used with FAZ

Technical Data

	Z-US./115	Z-US./230	Z-US./400
Electrical			
Rated voltage	U_n 115 V AC	230 V AC	400 V AC
Frequency	50-60 Hz	50-60 Hz	50-60 Hz
Making threshold	80% of U_n	80% of U_n	80% of U_n
Tripping threshold	50% of U_n	50% of U_n	50% of U_n
Mechanical			
Frame size	45 mm	45 mm	45 mm
Device height	80 mm	80 mm	80 mm
Device width	17.5 mm (1MU)	17.5 mm (1MU)	17.5 mm (1MU)
Mounting	quick fastening on DIN rail IEC/EN 60715		
Degree of protection, built-in	IP40	IP40	IP40
Terminals	open mouthed/lift	open mouthed/lift	open mouthed/lift
Terminal capacity	1 - 2x2.5 mm ²	1 - 2x2.5 mm ²	1 - 2x2.5 mm ²
Terminal protection	finger and hand touch safe, according to BGV A3, ÖVE-EN 6		

Connection diagram

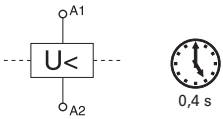

Dimensions (mm)

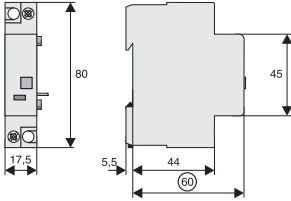

Connection Example Release

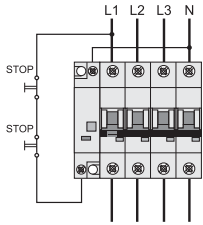

Connection Examples 400V and 230V

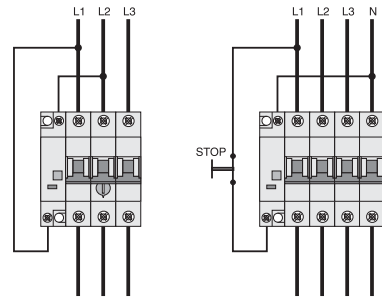

Connection example
Z-USA/400 + Z-MS

Connection example
Z-USA/230 + MCB

Switching interlocks IS/SPE-1TE, Z-IS/SPE-1TE

	Description	Type Designation	Article No.	Units per package
	Switching interlock without lock for Isolators, RCDs, combined RCD/MCBs, ...	IS/SPE-1TE	101911	5/30
	Switching interlock without lock for MCBs and Circuit Breaker ZP-A	Z-IS/SPE-1TE	274418	5/30

Specifications | Switching interlocks IS/SPE-1TE, Z-IS/SPE-1TE

Description

- Without lock

Type IS/SPE-1TE:

- for Isolators, RCDs, combined RCD/MCBs, ...

Type Z-IS/SPE-1TE:

- for MCB



Accessories for Add-on Residual Current Protection Unit FBHmV

Shunt Trip Release Kit Z-BHASA

	Operational voltage range V~	Type Designation	Article No.	Units per package
	110-415	Z-BHASA/230	248445	8
	12-60	Z-BHASA/24	248444	8

Specifications | Shunt Trip Release Kit Z-BHASA

Description

- Can be mounted subsequently
- Contact position indicator red - green
- Wide operational voltage range
- Sufficient power of extra low voltage source must be ensured
FBHmV-ASA/24: min. 90 VA
- Screws for mounting included FBHmV => BHASA => AZ

Accessories for Add-on Residual Current Protection Unit FBHmV

Technical Data

	Z-BHASA/24	Z-BHASA/230
Electrical		
Minimum pulse duration	15 ms	10 ms
Internal resistance	2 W	130 W
Duty	100%	100%
Tripping time	< 20 ms	< 20 ms
Peak withstand voltage (1.2/50µs)	2 kV	2 kV
Endurance	>4,000 operating cycles	>4,000 operating cycles
AC voltage range:		
Responding limit	8 V	70 V
Operational voltage range	12-60 V	110-415 V
Maximum current consumption during switch-on	14 A	3.4 A
Current flow time at max. current consumption	4.0 ms	4.5 ms
DC voltage range:		
Responding limit	11 V	90 V
Operational voltage range	12-60 V	110-230 V
Maximum current consumption during switch-on	23.5 A typ.	1.7 A typ.
Current flow time at max. current consumption	2 ms	4 ms
Mechanical		
Frame size	45 mm	45 mm
Device height	90 mm	90 mm
Device width	27 mm	27 mm
Mounting	quick fastening on DIN rail IEC/EN 60715	
Degree of protection, built-in	IP40	IP40
Upper and lower terminal screws	lift terminals	lift terminals
Terminal capacity	2.5-30 mm ²	2.5-30 mm ²
Fastening torque of terminal screws	4 Nm	4 Nm

Connection diagram

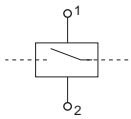

Dimensions (mm)

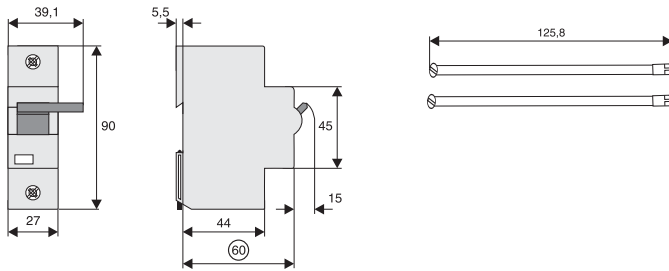

Accessories for Miniature Circuit Breakers AZ

Shunt Trip Release Z-LHASA

	Operational voltage range V~	Type Designation	Article No.	Units per package
	110-415	Z-LHASA/230	248442	8
	12-60	Z-LHASA/24	248441	8

Specifications | Shunt Trip Release Z-LHASA

Description

- Can be mounted subsequently
- Contact position indicator red - green
- Wide operational voltage range
- Sufficient power of extra low voltage source must be ensured
Z-LHASA/24: min. 90 VA

Technical Data

	Z-LHASA/24	Z-LHASA/230
Electrical		
Minimum pulse duration	15 ms	10 ms
Internal resistance	2 W	130 W
Duty	100%	100%
Tripping time	< 20 ms	< 20 ms
Peak withstand voltage (1.2/50µs)	2 kV	2 kV
Endurance	>4,000 operating cycles	>4,000 operating cycles
AC voltage range:		
Responding limit	8 V	70 V
Operational voltage range	12-60 V	110-415 V
Maximum current consumption during switch-on	14 A	3.4 A
Current flow time at max. current consumption	4.0 ms	4.5 ms
DC voltage range:		
Responding limit	11 V	90 V
Operational voltage range	12-60 V	110-230 V
Maximum current consumption during switch-on	23.5 A typ.	1.7 A typ.
Current flow time at max. current consumption	2 ms	4 ms
Mechanical		
Frame size	45 mm	45 mm
Device height	90 mm	90 mm
Device width	27 mm	27 mm
Mounting	quick fastening on DIN rail IEC/EN 60715	
Degree of protection, built-in	IP40	IP40
Upper and lower terminal screws	lift terminals	lift terminals
Terminal capacity	2.5-30 mm ²	2.5-30 mm ²
Fastening torque of terminal screws	4 Nm	4 Nm

Connection diagram

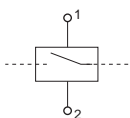

Dimensions (mm)

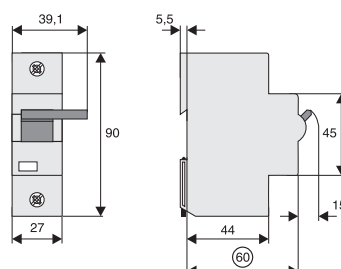

Accessories for Miniature Circuit Breakers AZ

Auxiliary Switch Z-LHK

Function	Type Designation	Article No.	Units per package
1NO+1NC	Z-LHK	248440	10/100

SG16111



Specifications | Auxiliary Switch Z-LHK

Description

- Auxiliary switch according to IEC 947-5-1
- Can be mounted subsequently

Technical Data

		Z-LHK
Electrical		
Contact function		1NO + 1NC
Rated voltage		250 V
Frequency		50/60 Hz
Rated current		8 A
Rated thermal current	I_{th}	8 A
Utilisation category AC13		
Rated operational current	I_e	6A/250V AC 2A/440V AC
Utilisation category AC15		
Rated operational current	I_e	–
Utilisation category DC12		
Rated operational current	I_e	–
Utilisation category DC13		
Rated operational current	I_e	0.5A/230V DC 2A/110V DC 4A/60V DC
Rated insulation voltage	U_I	250 V AC
Minimum operational voltage per contact	U_{min}	24 V AC/DC
Minimum operational current	I_{min}	50 mA AC/DC
Rated peak withstand voltage	$U_{imp} (1.2/50\mu)$	2.5 kV
Conditional short circuit current	I_k	1 kA
with back-up fuse 6A or FAZ-B4-HS		
Max. back-up fuse, overload and short circuit		6 A gL / FAZ-4/..B-HS
Mechanical		
Can be mounted from the left onto		AZ
Can be mounted from the right onto		–
Tripping indicator "electrical tripping"		–
Frame size		45 mm
Device height		80 mm
Device width		8.8 mm (0.5MU)
Mounting		onto switching device
Degree of protection, built-in		IP40
Terminal protection		finger and hand touch safe according to BGV A3, ÖVE-EN 6
Terminals		lift terminals
Terminal capacity		0.5-2.5 mm ²
Terminal screws		M3 (PoziDrive Z0)
Fastening torque of terminal screws		max. 0.8-1.0 Nm

Connection diagram



Dimensions (mm)

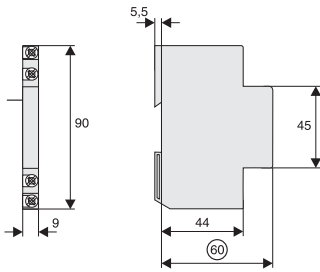

Accessories for Miniature Circuit Breakers AZ

Interlocks LH-SP

Function	Type Designation	Article No.	Units per package
Tripping interlock	LH-SPL	285752	1
Tripping interlock	LH-SPE	215999	1
Switchoff interlock	LH-SPA	216000	1

Specifications | Anti-Tamper Device LH-SPE, LH-SPL

Description

- Prevents undesired switching ON or OFF

Specifications | Switchoff Interlock LH-SPA

Description

- Prevents undesired switch-OFF

Dimensions (mm)

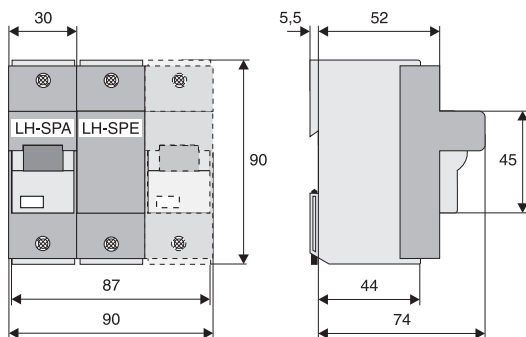

Accessories for Miniature Circuit Breaker FAZ-...-NA, -RT, -DU

Auxiliary Contact Z-IHK-NA

	Operational Voltage Range	Type Designation	Article No.	Units per package
	250 VAC	Z-IHK-NA	113895	1

Specifications | Auxiliary Contact Z-IHK-NA

Description

- Design according to IEC/EN 60947-5-1, IEC/EN 62019
- Field installable
- The specified minimum voltages are per contact—take into account particularly in case of series connection
- Self-cleaning contacts
- Contact material and design particularly suitable for extra low voltage
- Tripping signal contact transmits message of electric tripping, not mechanical switch-off
- Test key for contact function “electrical tripping”
- Will allow for > 480Y/277 VAC rating

Technical Data

		Z-IHK-NA
Electrical		
Contact function		1NO + 1NC
Rated voltage		250V
Rated current		6A
Rated thermal current	I_{th}	6A
Utilization category AC13		
Rated operational current	I_e	3A/250 Vac
Utilization category AC15		
Rated operational current	I_e	2A/250 Vac
Utilization category DC12		
Rated operational current	I_e	0.5A/110 Vdc
Rated insulation voltage	U_i	250 Vac
Minimum operational voltage per contact	U_{min}	5 Vdc
Minimum operational current	I_{min}	10 mA AC/DC
Rated peak withstand voltage	$U_{imp} (1.2/50\mu)$	4 kV
Conditional short circuit current	I_k	
with Back-Up Fuse 6A		1 kA
Max. back-up fuse, overload and short circuit		6 A gL / FAZ-4/..B-HS
Mechanical		
Tripping indicator “electrical tripping”		—
Frame size		45 mm
Device height		80 mm
Device width		8.8 mm (0.5MU)
Mounting		—
Degree of protection, built-in		IP40
Terminal protection		Finger and hand touch safe according to BGV A3, ÖVE-EN 6
Terminals		Lift terminals
Terminal capacity		0.5–2.5 mm ²
Terminal screws		M3 (Pozidrive Z2)
Tightening torque of terminal screws		max. 1.2 Nm

Connection diagram

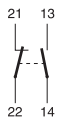

Dimensions (mm)

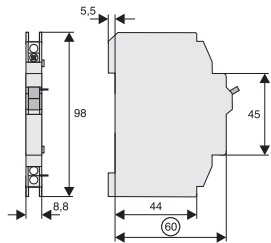

Accessories for Miniature Circuit Breaker FAZ-..-NA, -RT, -DU

Shunt Trip FAZ-XAA-NA

SG13511



Operational Voltage Range	Type Designation	Article No.	Units per package
12–110 VAC 12–60 VDC	FAZ-XAA-NA12-110VAC	102037	1
110–415 VAC 110–230 VDC	FAZ-XAA-NA110-415VAC	102036	1

Specifications | Shunt Trip FAZ-XAA-NA

Description

- Remote release for subsequent mounting onto FAZ-NA
- Additional installation of standard auxiliary switch is possible
- Position indicator red–green

Technical Data

	FAZ-XAA-NA12-110VAC	FAZ-XAA-NA110-415VAC
Electrical		
Can be mounted onto	FAZ-NA / FAZ-NA-DC / FAZ-RT/-DU	FAZ-NA / FAZ-NA-DC / FAZ-RT/-DU
Operational voltage range	12–110 Vac 12–60 Vdc	110–415 Vac 110–230 Vdc
Frequency	50/60 Hz	50/60 Hz
Mechanical		
Frame size	45 mm	45 mm
Device height	105 mm	105 mm
Device width	17.5 mm	17.5 mm
Mounting	Quick fastening with two lock-in positions on EN 50022	
Degree of protection, built-in	IP40	IP40
Terminal protection	Finger and hand touch safe according to BGV A3, ÖVE-EN 6	Finger and hand touch safe according to BGV A3, ÖVE-EN 6
Terminals	Open mouthed/lift	Open mouthed/lift
Terminal capacity, one and two wires	18–10 AWG	18–10 AWG

Connection diagram

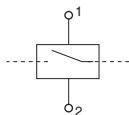

Terminal Covers

Description	Type Designation	Article No.	Units per package
-------------	------------------	-------------	-------------------

Terminal Covers for RCDs

2-pole	Z-RC/AK-2TE	285385	10
4-pole	Z-RC/AK-4TE	101062	10

Terminal Covers for Add-on Device

2-pole	Z-CV/AO-2P	221957600	10
3+4-pole	Z-CV/AO-3-4P	221957500	10



Terminal Covers for MCB, RCBO

2-pole	Z-CV/SD-2P	221954800	10
3-pole	Z-CV/SD-3P	221954900	10
4-pole	Z-CV/SD-4P	221953900	10

Terminal Cover for MCB

1-pole	Z7-AK-1TE	750754200	10
--------	-----------	-----------	----

Remote Control and Automatic Switching Device Z-ZW

Function	Type Designation	Article No.	Units per package	
 SG30811	Automatic restarting 230VAC	Z-FW-LP	248296	1/20
	Automatic restarting 24-48VDC	Z-FW-LPD	265244	1/20
 SG30711	+ Remote control ON/OFF/TEST (only in connection with Z-FW-LP, -LPD from delivery date 2006!)	Z-FW-MO	284730	1

Pre-mounted sets Z-FW

Operational voltage range	Type Designation	Article No.	Units per package	
 SG31311	230 VAC	Z-FW-LP/MO	290171	1/12
	24-48 VDC	Z-FW-LPD/MO	290172	1/12

Remote Testing Module Z-FW (for Z-FW-LP/MO set use only)

Operational voltage range	Type Designation	Article No.	Units per package	
 SG12111	0.01 A	Z-FW/001	248297	4/120
	0.03 A	Z-FW/003	248298	4/120
	0.1 A	Z-FW/010	248299	4/120
	0.3 A	Z-FW/030	248300	4/120
	0.5 A	Z-FW/050	248301	4/120

Specifications | Remote Control and Automatic Switching Z-FW

Description

- Shape compatible switching device suitable for subsequent installation for automatic re-setting and remote control of CLS6, PFIM, PFHM-4p, dRCM, Z-A40, PFR, Z-MS
- Mechanical interlock, can be sealed with leads
- Mechanical switching capability up to max. PFIM-100/4p, CLS6-100/4p
- Operating and alarm display by green and red LED
- Function extension with Switching Modul Z-FW-MO
Operating and trouble display by LED pre-assembled only with Z-FW...

Technical Data

	Z-FW-LP	Z-FW-LPD	Z-FW-MO
Electrical			
Possible operating voltages	220-240 V AC	24-48 V DC	-
Frequency	50/60 Hz	-	-
Testing module (0.5MU) for remote testing of RCDs	Z-FW...	Z-FW...	-
Control voltage for remote control	-	-	24-230 V AC/DC
Relay output for tripping test with Z-FW	-	-	400 V AC max.
Relay output for alarm, potential-free	5A/250V AC	5A/250V AC	-
Functions	automatic restarting	automatic restarting	+ON/OFF/TEST
Function selector	Automatic 5x, OFF/RESET	Automatic 5x, OFF/RESET	ON, OFF/RESET
Remote control function via telephone with Telecommander	-	-	-
Mechanical			
Frame size	45 mm	45 mm	45 mm
Device height	80 mm	80 mm	80 mm
Device width	70 mm	70 mm	35 mm
Mounting	quick fastening with 2 lock-in positions on DIN rail IEC/EN 60715		-
Degree of protection, built-in	IP40	IP40	IP40
Terminal protection	finger and hand touch safe according to BGV A3, ÖVE-EN 6		
Terminals	lift terminals	lift terminals	lift terminals
Terminal capacity	2 x 1.5 mm ² or 1 x 2.5 mm ²	2 x 1.5 mm ² or 1 x 2.5 mm ²	4 x 1.5 mm ² or 2 x 2.5 mm ²
Scope of delivery	-	-	Coupling plug

Connection diagram

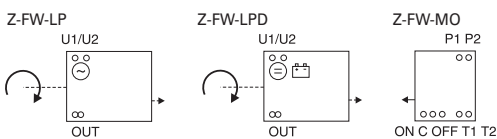

Dimensions (mm)

Z-FW-LP, -LPD

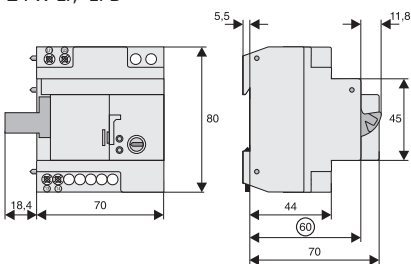

Z-FW-MO

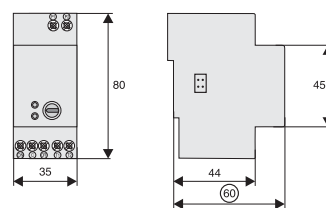

Connection example

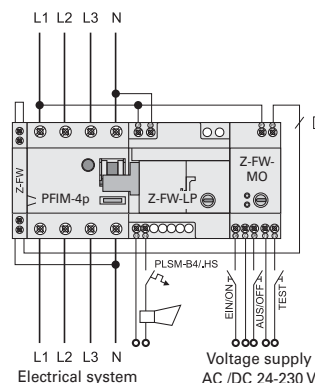
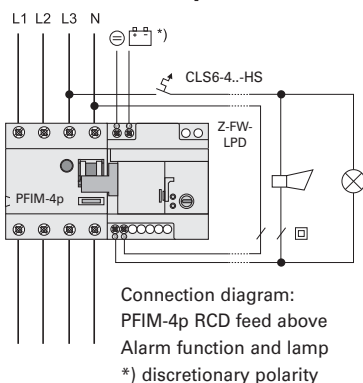

Pre-mounted Sets

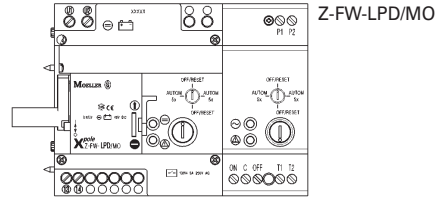
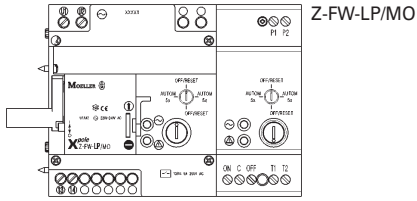

Specifications | Remote Testing Module Z-FW (for Z-FW-LP)

Description

- External testing module with testing resistor for RCDs
- Proper "external" test key function according to the applicable rules thanks to design adapted to the rated tripping current
- For remote testing with remote control and automatic switching device Z-FW-LP
- No undesired voltage rise in the consumer system during remote switch-off thanks to integrated breaker contact K1-K2
- Can also be used as a remote tripping module for PFIM, PFHM

Dimensions (mm)

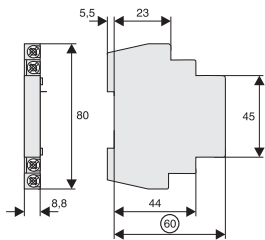

Connection examples

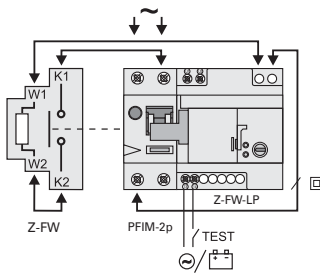

Connection diagram:
PFIM-2p, RCD feed above

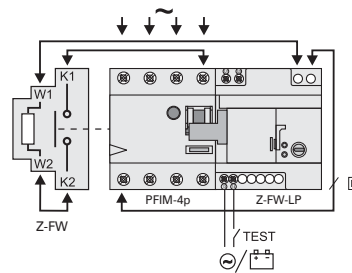

Connection diagram:
PFIM-4p, RCD feed above

Miniature Circuit Breakers FAZ, FAZ-PN, FAZ-HS

SG55812



FAZ

- High-quality miniature circuit breakers for industrial applications and residential applications
- Contact position indicator red - green
- Guide for secure terminal connection
- 3-position DIN rail clip, permits removal from existing busbar system
- Comprehensive range of accessories suitable for subsequent installation
- Rated currents up to 63 A
- Tripping characteristics B, C, D, K, S, Z
- Rated breaking capacity up to 15 kA according to IEC/EN 60947-2

FAZ-PN

- Tripping characteristic B
- Rated breaking capacity up to 6 kA according to IEC/EN 60898-1
- Module width 1MU (1+N-poles)

FAZ-HS

- Tripping characteristic B
- Rated breaking capacity up to 10 kA according to IEC/EN 60898-1
- 1- and 2-poles available

FAZ Miniature Circuit Breakers (MCBs)

Characteristic B

	Rated current I_n (A)	Rated voltage (V)	Breaking capacity acc. to IEC/EN 60947-2 (kA)	Rated voltage UL1077 (V)	Breaking capacity acc. to UL1077 (kA)	Type Designation	Article No.	Units per package
1-pole								
1	240/415	15	277	10		FAZ-B1/1	182114	12
1.5	240/415	15	277	10		FAZ-B1,5/1	182115	12
1.6	240/415	15	277	10		FAZ-B1,6/1	182116	12
2	240/415	15	277	10		FAZ-B2/1	182117	12
3	240/415	15	277	10		FAZ-B3/1	182119	12
3.5	240/415	15	277	10		FAZ-B3,5/1	182120	12
4	240/415	15	277	10		FAZ-B4/1	182121	12
5	240/415	15	277	10		FAZ-B5/1	182122	12
6	240/415	15	277	10		FAZ-B6/1	182123	12
8	240/415	15	277	10		FAZ-B8/1	182124	12
10	240/415	15	277	10		FAZ-B10/1	182125	12
12	240/415	15	277	10		FAZ-B12/1	182126	12
13	240/415	15	277	10		FAZ-B13/1	182127	12
15	240/415	15	277	10		FAZ-B15/1	182128	12
16	240/415	15	277	10		FAZ-B16/1	182129	12
20	240/415	15	277	10		FAZ-B20/1	182130	12
25	240/415	15	277	10		FAZ-B25/1	182131	12
32	240/415	15	277	10		FAZ-B32/1	182132	12
40	240/415	15	277	5		FAZ-B40/1	182133	12
50	240/415	15	277	5		FAZ-B50/1	182134	12
63	240/415	15	277	5		FAZ-B63/1	182135	12

SG53112



SG56612



1+N-pole								
1	240	15	277	10		FAZ-B1/1N	182136	6
1.5	240	15	277	10		FAZ-B1,5/1N	182137	6
1.6	240	15	277	10		FAZ-B1,6/1N	182138	6
2	240	15	277	10		FAZ-B2/1N	182139	6
2.5	240	15	277	10		FAZ-B2,5/1N	182140	6
3	240	15	277	10		FAZ-B3/1N	182141	6
3.5	240	15	277	10		FAZ-B3,5/1N	182142	6
4	240	15	277	10		FAZ-B4/1N	182143	6
5	240	15	277	10		FAZ-B5/1N	182144	6
6	240	15	277	10		FAZ-B6/1N	182145	6
8	240	15	277	10		FAZ-B8/1N	182146	6
10	240	15	277	10		FAZ-B10/1N	182147	6
12	240	15	277	10		FAZ-B12/1N	182148	6
13	240	15	277	10		FAZ-B13/1N	182149	6
15	240	15	277	10		FAZ-B15/1N	182150	6
16	240	15	277	10		FAZ-B16/1N	182151	6
20	240	15	277	10		FAZ-B20/1N	182152	6
25	240	15	277	10		FAZ-B25/1N	182153	6
32	240	15	277	10		FAZ-B32/1N	182154	6
40	240	15	277	5		FAZ-B40/1N	182155	6
50	240	15	277	5		FAZ-B50/1N	182156	6
63	240	15	277	5		FAZ-B63/1N	182157	6

SG55112



Rated current I_n (A)	Rated voltage (V)	Breaking capacity acc. to IEC/EN 60947-2 (kA)	Rated voltage UL1077 (V)	Breaking capacity acc. to UL1077 (kA)	Type Designation	Article No.	Units per package
----------------------------	----------------------	---	--------------------------------	--	---------------------	-------------	-------------------------

2-pole

1	415	15	480Y/277	10	FAZ-B1/2	182158	6
1.5	415	15	480Y/277	10	FAZ-B1,5/2	182159	6
1.6	415	15	480Y/277	10	FAZ-B1,6/2	182160	6
2	415	15	480Y/277	10	FAZ-B2/2	182161	6
2.5	415	15	480Y/277	10	FAZ-B2,5/2	182162	6
3	415	15	480Y/277	10	FAZ-B3/2	182112	6
3.5	415	15	480Y/277	10	FAZ-B3,5/2	182113	6
4	415	15	480Y/277	10	FAZ-B4/2	182175	6
5	415	15	480Y/277	10	FAZ-B5/2	182176	6
6	415	15	480Y/277	10	FAZ-B6/2	182177	6
7	415	15	480Y/277	10	FAZ-B7/2	182178	6
8	415	15	480Y/277	10	FAZ-B8/2	182179	6
10	415	15	480Y/277	10	FAZ-B10/2	182180	6
12	415	15	480Y/277	10	FAZ-B12/2	182181	6
13	415	15	480Y/277	10	FAZ-B13/2	182182	6
15	415	15	480Y/277	10	FAZ-B15/2	182183	6
16	415	15	480Y/277	10	FAZ-B16/2	182184	6
20	415	15	480Y/277	10	FAZ-B20/2	182185	6
25	415	15	480Y/277	10	FAZ-B25/2	182186	6
32	415	15	480Y/277	10	FAZ-B32/2	182188	6
40	415	15	480Y/277	5	FAZ-B40/2	182189	6
50	415	15	480Y/277	5	FAZ-B50/2	182190	6
63	415	15	480Y/277	5	FAZ-B63/2	182191	6

SG53412



3-pole

1	415	15	480Y/277	10	FAZ-B1/3	182192	4
1.5	415	15	480Y/277	10	FAZ-B1,5/3	182193	4
1.6	415	15	480Y/277	10	FAZ-B1,6/3	182194	4
2	415	15	480Y/277	10	FAZ-B2/3	182195	4
2.5	415	15	480Y/277	10	FAZ-B2,5/3	182196	4
3	415	15	480Y/277	10	FAZ-B3/3	182197	4
3.5	415	15	480Y/277	10	FAZ-B3,5/3	182198	4
4	415	15	480Y/277	10	FAZ-B4/3	182199	4
5	415	15	480Y/277	10	FAZ-B5/3	182200	4
6	415	15	480Y/277	10	FAZ-B6/3	182201	4
7	415	15	480Y/277	10	FAZ-B7/3	182202	4
8	415	15	480Y/277	10	FAZ-B8/3	182203	4
10	415	15	480Y/277	10	FAZ-B10/3	182204	4
12	415	15	480Y/277	10	FAZ-B12/3	182205	4
13	415	15	480Y/277	10	FAZ-B13/3	182206	4
15	415	15	480Y/277	10	FAZ-B15/3	182207	4
16	415	15	480Y/277	10	FAZ-B16/3	182208	4
20	415	15	480Y/277	10	FAZ-B20/3	182209	4
25	415	15	480Y/277	10	FAZ-B25/3	182210	4
32	415	15	480Y/277	10	FAZ-B32/3	182212	4
40	415	15	480Y/277	5	FAZ-B40/3	182213	4
50	415	15	480Y/277	5	FAZ-B50/3	182214	4
63	415	15	480Y/277	5	FAZ-B63/3	182215	4

SG55712



Rated current I_n (A)	Rated voltage (V)	Breaking capacity acc. to IEC/EN 60947-2 (kA)	Rated voltage UL1077 (V)	Breaking capacity acc. to UL1077 (kA)	Type Designation	Article No.	Units per package
----------------------------	----------------------	---	--------------------------------	--	---------------------	-------------	-------------------------

3+N-pole

1	415	15	480Y/277	10	FAZ-B1/3N	182216	3
1.5	415	15	480Y/277	10	FAZ-B1,5/3N	182217	3
1.6	415	15	480Y/277	10	FAZ-B1,6/3N	182218	3
2	415	15	480Y/277	10	FAZ-B2/3N	182219	3
2.5	415	15	480Y/277	10	FAZ-B2,5/3N	182220	3
3	415	15	480Y/277	10	FAZ-B3/3N	182221	3
3.5	415	15	480Y/277	10	FAZ-B3,5/3N	182222	3
4	415	15	480Y/277	10	FAZ-B4/3N	182223	3
5	415	15	480Y/277	10	FAZ-B5/3N	182224	3
6	415	15	480Y/277	10	FAZ-B6/3N	182225	3
8	415	15	480Y/277	10	FAZ-B8/3N	182226	3
10	415	15	480Y/277	10	FAZ-B10/3N	182227	3
12	415	15	480Y/277	10	FAZ-B12/3N	182228	3
13	415	15	480Y/277	10	FAZ-B13/3N	182229	3
15	415	15	480Y/277	10	FAZ-B15/3N	182230	3
16	415	15	480Y/277	10	FAZ-B16/3N	182231	3
20	415	15	480Y/277	10	FAZ-B20/3N	182232	3
25	415	15	480Y/277	10	FAZ-B25/3N	182233	3
32	415	15	480Y/277	10	FAZ-B32/3N	182234	3
40	415	15	480Y/277	5	FAZ-B40/3N	182235	3
50	415	15	480Y/277	5	FAZ-B50/3N	182236	3
63	415	15	480Y/277	5	FAZ-B63/3N	182237	3

SG55812



4-pole

1	415	15	480Y/277	10	FAZ-B1/4	182238	3
1.5	415	15	480Y/277	10	FAZ-B1,5/4	182239	3
1.6	415	15	480Y/277	10	FAZ-B1,6/4	182240	3
2	415	15	480Y/277	10	FAZ-B2/4	182241	3
2.5	415	15	480Y/277	10	FAZ-B2,5/4	182242	3
3	415	15	480Y/277	10	FAZ-B3/4	182243	3
3.5	415	15	480Y/277	10	FAZ-B3,5/4	182244	3
4	415	15	480Y/277	10	FAZ-B4/4	182245	3
5	415	15	480Y/277	10	FAZ-B5/4	182246	3
6	415	15	480Y/277	10	FAZ-B6/4	182247	3
7	415	15	480Y/277	10	FAZ-B7/4	182248	3
8	415	15	480Y/277	10	FAZ-B8/4	182249	3
10	415	15	480Y/277	10	FAZ-B10/4	182250	3
12	415	15	480Y/277	10	FAZ-B12/4	182251	3
13	415	15	480Y/277	10	FAZ-B13/4	182252	3
15	415	15	480Y/277	10	FAZ-B15/4	182253	3
16	415	15	480Y/277	10	FAZ-B16/4	182254	3
20	415	15	480Y/277	10	FAZ-B20/4	182255	3
25	415	15	480Y/277	10	FAZ-B25/4	182256	3
32	415	15	480Y/277	10	FAZ-B32/4	182257	3
40	415	15	480Y/277	5	FAZ-B40/4	182258	3
50	415	15	480Y/277	5	FAZ-B50/4	182259	3
63	415	15	480Y/277	5	FAZ-B63/4	182260	3

FAZ Miniature Circuit Breakers (MCBs)

Characteristic C

Rated current I_n (A)	Rated voltage (V)	Breaking capacity acc. to IEC/EN 60947-2 (kA)	Rated voltage UL1077 (V)	Breaking capacity acc. to UL1077 (kA)	Type Designation	Article No.	Units per package
1-pole							
0.16	240/415	15	277	5	FAZ-C0,16/1	182261	12
0.25	240/415	15	277	5	FAZ-C0,25/1	182262	12
0.5	240/415	15	277	10	FAZ-C0,5/1	182263	12
0.75	240/415	15	277	10	FAZ-C0,75/1	182264	12
1	240/415	15	277	10	FAZ-C1/1	182265	12
1.5	240/415	15	277	10	FAZ-C1,5/1	182266	12
1.6	240/415	15	277	10	FAZ-C1,6/1	182267	12
2	240/415	15	277	10	FAZ-C2/1	182268	12
2.5	240/415	15	277	10	FAZ-C2,5/1	182269	12
3	240/415	15	277	10	FAZ-C3/1	182270	12
3.5	240/415	15	277	10	FAZ-C3,5/1	182271	12
4	240/415	15	277	10	FAZ-C4/1	182272	12
5	240/415	15	277	10	FAZ-C5/1	182273	12
6	240/415	15	277	10	FAZ-C6/1	182274	12
8	240/415	15	277	10	FAZ-C8/1	182275	12
10	240/415	15	277	10	FAZ-C10/1	182276	12
12	240/415	15	277	10	FAZ-C12/1	182277	12
13	240/415	15	277	10	FAZ-C13/1	182278	12
15	240/415	15	277	10	FAZ-C15/1	182279	12
16	240/415	15	277	10	FAZ-C16/1	182280	12
20	240/415	15	277	10	FAZ-C20/1	182281	12
25	240/415	15	277	10	FAZ-C25/1	182282	12
32	240/415	15	277	10	FAZ-C32/1	182283	12
40	240/415	15	277	5	FAZ-C40/1	182284	12
50	240/415	15	277	5	FAZ-C50/1	182285	12
63	240/415	15	277	5	FAZ-C63/1	182286	12

SG53112



SG55612



1+N-pole							
0.16	240	15	277	5	FAZ-C0,16/1N	182287	6
0.25	240	15	277	5	FAZ-C0,25/1N	182288	6
0.5	240	15	277	10	FAZ-C0,5/1N	182289	6
0.75	240	15	277	10	FAZ-C0,75/1N	182290	6
1	240	15	277	10	FAZ-C1/1N	182291	6
1.5	240	15	277	10	FAZ-C1,5/1N	182292	6
1.6	240	15	277	10	FAZ-C1,6/1N	182293	6
2	240	15	277	10	FAZ-C2/1N	182294	6
2.5	240	15	277	10	FAZ-C2,5/1N	182295	6
3	240	15	277	10	FAZ-C3/1N	182296	6
3.5	240	15	277	10	FAZ-C3,5/1N	182297	6
4	240	15	277	10	FAZ-C4/1N	182298	6
5	240	15	277	10	FAZ-C5/1N	182299	6
6	240	15	277	10	FAZ-C6/1N	182300	6
8	240	15	277	10	FAZ-C8/1N	182301	6
10	240	15	277	10	FAZ-C10/1N	182302	6
12	240	15	277	10	FAZ-C12/1N	182303	6
13	240	15	277	10	FAZ-C13/1N	182304	6
15	240	15	277	10	FAZ-C15/1N	182305	6
16	240	15	277	10	FAZ-C16/1N	182306	6
20	240	15	277	10	FAZ-C20/1N	182307	6
25	240	15	277	10	FAZ-C25/1N	182308	6
32	240	15	277	10	FAZ-C32/1N	182309	6
40	240	15	277	5	FAZ-C40/1N	182310	6
50	240	15	277	5	FAZ-C50/1N	182311	6
63	240	15	277	5	FAZ-C63/1N	182312	6

SG55112



Rated current I_n (A)	Rated voltage (V)	Breaking capacity acc. to IEC/EN 60947-2 (kA)	Rated voltage UL1077 (V)	Breaking capacity acc. to UL1077 (kA)	Type Designation	Article No.	Units per package
----------------------------	----------------------	---	--------------------------------	--	---------------------	-------------	-------------------------

2-pole

0.16	415	15	480Y/277	5	FAZ-C0,16/2	182313	6
0.25	415	15	480Y/277	5	FAZ-C0,25/2	182314	6
0.5	415	15	480Y/277	10	FAZ-C0,5/2	182315	6
0.75	415	15	480Y/277	10	FAZ-C0,75/2	182316	6
1	415	15	480Y/277	10	FAZ-C1/2	182317	6
1.5	415	15	480Y/277	10	FAZ-C1,5/2	182318	6
1.6	415	15	480Y/277	10	FAZ-C1,6/2	182319	6
2	415	15	480Y/277	10	FAZ-C2/2	182320	6
2.5	415	15	480Y/277	10	FAZ-C2,5/2	182321	6
3	415	15	480Y/277	10	FAZ-C3/2	182322	6
3.5	415	15	480Y/277	10	FAZ-C3,5/2	182323	6
4	415	15	480Y/277	10	FAZ-C4/2	182324	6
5	415	15	480Y/277	10	FAZ-C5/2	182325	6
6	415	15	480Y/277	10	FAZ-C6/2	182326	6
7	415	15	480Y/277	10	FAZ-C7/2	182327	6
8	415	15	480Y/277	10	FAZ-C8/2	182328	6
10	415	15	480Y/277	10	FAZ-C10/2	182329	6
12	415	15	480Y/277	10	FAZ-C12/2	182330	6
13	415	15	480Y/277	10	FAZ-C13/2	182331	6
15	415	15	480Y/277	10	FAZ-C15/2	182332	6
16	415	15	480Y/277	10	FAZ-C16/2	182333	6
20	415	15	480Y/277	10	FAZ-C20/2	182334	6
25	415	15	480Y/277	10	FAZ-C25/2	182335	6
30	415	15	480Y/277	10	FAZ-C30/2	182336	6
32	415	15	480Y/277	10	FAZ-C32/2	182337	6
40	415	15	480Y/277	5	FAZ-C40/2	182338	6
50	415	15	480Y/277	5	FAZ-C50/2	182339	6
63	415	15	480Y/277	5	FAZ-C63/2	182340	6

SG53412



3-pole

0.16	415	15	480Y/277	5	FAZ-C0,16/3	182341	4
0.25	415	15	480Y/277	5	FAZ-C0,25/3	182342	4
0.5	415	15	480Y/277	10	FAZ-C0,5/3	182163	4
0.75	415	15	480Y/277	10	FAZ-C0,75/3	182164	4
1	415	15	480Y/277	10	FAZ-C1/3	182165	4
1.5	415	15	480Y/277	10	FAZ-C1,5/3	182166	4
1.6	415	15	480Y/277	10	FAZ-C1,6/3	182167	4
2	415	15	480Y/277	10	FAZ-C2/3	182168	4
2.5	415	15	480Y/277	10	FAZ-C2,5/3	182169	4
3	415	15	480Y/277	10	FAZ-C3/3	182170	4
3.5	415	15	480Y/277	10	FAZ-C3,5/3	182171	4
4	415	15	480Y/277	10	FAZ-C4/3	182172	4
5	415	15	480Y/277	10	FAZ-C5/3	182173	4
6	415	15	480Y/277	10	FAZ-C6/3	182174	4
7	415	15	480Y/277	10	FAZ-C7/3	181651	4
8	415	15	480Y/277	10	FAZ-C8/3	181652	4
10	415	15	480Y/277	10	FAZ-C10/3	181653	4
12	415	15	480Y/277	10	FAZ-C12/3	181654	4
13	415	15	480Y/277	10	FAZ-C13/3	181655	4
15	415	15	480Y/277	10	FAZ-C15/3	181656	4
16	415	15	480Y/277	10	FAZ-C16/3	181657	4
20	415	15	480Y/277	10	FAZ-C20/3	181658	4
25	415	15	480Y/277	10	FAZ-C25/3	181659	4
30	415	15	480Y/277	10	FAZ-C30/3	181660	4
32	415	15	480Y/277	10	FAZ-C32/3	181661	4
40	415	15	480Y/277	5	FAZ-C40/3	181662	4
50	415	15	480Y/277	5	FAZ-C50/3	181663	4
63	415	15	480Y/277	5	FAZ-C63/3	181664	4

SG55712



Rated current I_n (A)	Rated voltage (V)	Breaking capacity acc. to IEC/EN 60947-2 (kA)	Rated voltage UL1077 (V)	Breaking capacity acc. to UL1077 (kA)	Type Designation	Article No.	Units per package
----------------------------	----------------------	---	--------------------------------	--	---------------------	-------------	-------------------------

3+N-pole

0.16	415	15	480Y/277	5	FAZ-C0,16/3N	181665	3
0.25	415	15	480Y/277	5	FAZ-C0,25/3N	181666	3
0.5	415	15	480Y/277	10	FAZ-C0,5/3N	181667	3
0.75	415	15	480Y/277	10	FAZ-C0,75/3N	181668	3
1	415	15	480Y/277	10	FAZ-C1/3N	181669	3
1.5	415	15	480Y/277	10	FAZ-C1,5/3N	181670	3
1.6	415	15	480Y/277	10	FAZ-C1,6/3N	181671	3
2	415	15	480Y/277	10	FAZ-C2/3N	181672	3
2.5	415	15	480Y/277	10	FAZ-C2,5/3N	181673	3
3	415	15	480Y/277	10	FAZ-C3/3N	181674	3
3.5	415	15	480Y/277	10	FAZ-C3,5/3N	181675	3
4	415	15	480Y/277	10	FAZ-C4/3N	181676	3
5	415	15	480Y/277	10	FAZ-C5/3N	181677	3
6	415	15	480Y/277	10	FAZ-C6/3N	181678	3
8	415	15	480Y/277	10	FAZ-C8/3N	181679	3
10	415	15	480Y/277	10	FAZ-C10/3N	181680	3
12	415	15	480Y/277	10	FAZ-C12/3N	181681	3
13	415	15	480Y/277	10	FAZ-C13/3N	181682	3
15	415	15	480Y/277	10	FAZ-C15/3N	181683	3
16	415	15	480Y/277	10	FAZ-C16/3N	181684	3
20	415	15	480Y/277	10	FAZ-C20/3N	181685	3
25	415	15	480Y/277	10	FAZ-C25/3N	181686	3
32	415	15	480Y/277	10	FAZ-C32/3N	181687	3
40	415	15	480Y/277	5	FAZ-C40/3N	181688	3
50	415	15	480Y/277	5	FAZ-C50/3N	181689	3
63	415	15	480Y/277	5	FAZ-C63/3N	181690	3

SG55812



4-pole

0.16	415	15	480Y/277	5	FAZ-C0,16/4	181691	3
0.25	415	15	480Y/277	5	FAZ-C0,25/4	181692	3
0.5	415	15	480Y/277	10	FAZ-C0,5/4	181693	3
0.75	415	15	480Y/277	10	FAZ-C0,75/4	181694	3
1	415	15	480Y/277	10	FAZ-C1/4	181695	3
1.5	415	15	480Y/277	10	FAZ-C1,5/4	181696	3
1.6	415	15	480Y/277	10	FAZ-C1,6/4	181697	3
2	415	15	480Y/277	10	FAZ-C2/4	181698	3
2.5	415	15	480Y/277	10	FAZ-C2,5/4	181699	3
3	415	15	480Y/277	10	FAZ-C3/4	181700	3
3.5	415	15	480Y/277	10	FAZ-C3,5/4	181701	3
4	415	15	480Y/277	10	FAZ-C4/4	181702	3
5	415	15	480Y/277	10	FAZ-C5/4	181703	3
6	415	15	480Y/277	10	FAZ-C6/4	181704	3
7	415	15	480Y/277	10	FAZ-C7/4	181705	3
8	415	15	480Y/277	10	FAZ-C8/4	181706	3
10	415	15	480Y/277	10	FAZ-C10/4	181707	3
12	415	15	480Y/277	10	FAZ-C12/4	181708	3
13	415	15	480Y/277	10	FAZ-C13/4	181709	3
15	415	15	480Y/277	10	FAZ-C15/4	181710	3
16	415	15	480Y/277	10	FAZ-C16/4	181711	3
20	415	15	480Y/277	10	FAZ-C20/4	181712	3
25	415	15	480Y/277	10	FAZ-C25/4	181713	3
32	415	15	480Y/277	10	FAZ-C32/4	181714	3
40	415	15	480Y/277	5	FAZ-C40/4	181715	3
50	415	15	480Y/277	5	FAZ-C50/4	181716	3
63	415	15	480Y/277	5	FAZ-C63/4	181717	3

FAZ Miniature Circuit Breakers (MCBs)

Characteristic D

	Rated current I_n (A)	Rated voltage (V)	Breaking capacity acc. to IEC/EN 60947-2 (kA)	Rated voltage UL1077 (V)	Breaking capacity acc. to UL1077 (kA)	Type Designation	Article No.	Units per package
1-pole								
0.5	240/415	15	277	5		FAZ-D0,5/1	181718	12
1	240/415	15	277	5		FAZ-D1/1	181719	12
1.5	240/415	15	277	5		FAZ-D1,5/1	181720	12
1.6	240/415	15	277	5		FAZ-D1,6/1	181721	12
2	240/415	15	277	5		FAZ-D2/1	181722	12
2.5	240/415	15	277	5		FAZ-D2,5/1	181723	12
3	240/415	15	277	5		FAZ-D3/1	181724	12
3.5	240/415	15	277	5		FAZ-D3,5/1	181725	12
4	240/415	15	277	5		FAZ-D4/1	181726	12
5	240/415	15	277	5		FAZ-D5/1	181727	12
6	240/415	15	277	5		FAZ-D6/1	181728	12
8	240/415	15	277	5		FAZ-D8/1	181729	12
10	240/415	15	277	5		FAZ-D10/1	181730	12
12	240/415	15	277	5		FAZ-D12/1	181731	12
13	240/415	15	277	5		FAZ-D13/1	181732	12
15	240/415	15	277	5		FAZ-D15/1	181733	12
16	240/415	15	277	5		FAZ-D16/1	181734	12
20	240/415	15	277	5		FAZ-D20/1	181735	12
25	240/415	15	277	5		FAZ-D25/1	181736	12
32	240/415	15	277	5		FAZ-D32/1	181737	12
40	240/415	15	277	5		FAZ-D40/1	181738	12
50	240/415	10	-	-		FAZ-D50/1	181739	12
63	240/415	10	-	-		FAZ-D63/1	181740	12

SG53112



SG55612



1+N-pole								
0.5	240	15	277	5		FAZ-D0,5/1N	181741	6
1	240	15	277	5		FAZ-D1/1N	181742	6
1.5	240	15	277	5		FAZ-D1,5/1N	181743	6
1.6	240	15	277	5		FAZ-D1,6/1N	181744	6
2	240	15	277	5		FAZ-D2/1N	181745	6
2.5	240	15	277	5		FAZ-D2,5/1N	181746	6
3	240	15	277	5		FAZ-D3/1N	181747	6
3.5	240	15	277	5		FAZ-D3,5/1N	181748	6
4	240	15	277	5		FAZ-D4/1N	181749	6
5	240	15	277	5		FAZ-D5/1N	181750	6
6	240	15	277	5		FAZ-D6/1N	181751	6
8	240	15	277	5		FAZ-D8/1N	181752	6
10	240	15	277	5		FAZ-D10/1N	181753	6
12	240	15	277	5		FAZ-D12/1N	181754	6
13	240	15	277	5		FAZ-D13/1N	181755	6
15	240	15	277	5		FAZ-D15/1N	181756	6
16	240	15	277	5		FAZ-D16/1N	181757	6
20	240	15	277	5		FAZ-D20/1N	181758	6
25	240	15	277	5		FAZ-D25/1N	181759	6
32	240	15	277	5		FAZ-D32/1N	181760	6
40	240	15	277	5		FAZ-D40/1N	181761	6
50	240	10	-	-		FAZ-D50/1N	181762	6
63	240	10	-	-		FAZ-D63/1N	181763	6

SG55112



Rated current I_n (A)	Rated voltage (V)	Breaking capacity acc. to IEC/EN 60947-2 (kA)	Rated voltage UL1077 (V)	Breaking capacity acc. to UL1077 (kA)	Type Designation	Article No.	Units per package
----------------------------	----------------------	---	--------------------------------	--	---------------------	-------------	-------------------------

2-pole

0.5	415	15	480Y/277	5	FAZ-D0,5/2	181764	6
1	415	15	480Y/277	5	FAZ-D1/2	181765	6
1.5	415	15	480Y/277	5	FAZ-D1,5/2	181766	6
1.6	415	15	480Y/277	5	FAZ-D1,6/2	181767	6
2	415	15	480Y/277	5	FAZ-D2/2	181768	6
2.5	415	15	480Y/277	5	FAZ-D2,5/2	181769	6
3	415	15	480Y/277	5	FAZ-D3/2	181770	6
3.5	415	15	480Y/277	5	FAZ-D3,5/2	181771	6
4	415	15	480Y/277	5	FAZ-D4/2	181772	6
5	415	15	480Y/277	5	FAZ-D5/2	181773	6
6	415	15	480Y/277	5	FAZ-D6/2	181774	6
7	415	15	480Y/277	5	FAZ-D7/2	181775	6
8	415	15	480Y/277	5	FAZ-D8/2	181776	6
10	415	15	480Y/277	5	FAZ-D10/2	181777	6
12	415	15	480Y/277	5	FAZ-D12/2	181778	6
13	415	15	480Y/277	5	FAZ-D13/2	181779	6
15	415	15	480Y/277	5	FAZ-D15/2	181780	6
16	415	15	480Y/277	5	FAZ-D16/2	181781	6
20	415	15	480Y/277	5	FAZ-D20/2	181782	6
25	415	15	480Y/277	5	FAZ-D25/2	181783	6
32	415	15	480Y/277	5	FAZ-D32/2	181785	6
40	415	15	480Y/277	5	FAZ-D40/2	181786	6
50	415	10	-	-	FAZ-D50/2	181787	6
63	415	10	-	-	FAZ-D63/2	181788	6

SG53412



3-pole

0.5	415	15	480Y/277	5	FAZ-D0,5/3	181789	4
1	415	15	480Y/277	5	FAZ-D1/3	181790	4
1.5	415	15	480Y/277	5	FAZ-D1,5/3	181791	4
1.6	415	15	480Y/277	5	FAZ-D1,6/3	181792	4
2	415	15	480Y/277	5	FAZ-D2/3	181793	4
2.5	415	15	480Y/277	5	FAZ-D2,5/3	181794	4
3	415	15	480Y/277	5	FAZ-D3/3	181795	4
3.5	415	15	480Y/277	5	FAZ-D3,5/3	181796	4
4	415	15	480Y/277	5	FAZ-D4/3	181797	4
5	415	15	480Y/277	5	FAZ-D5/3	181798	4
6	415	15	480Y/277	5	FAZ-D6/3	181799	4
7	415	15	480Y/277	5	FAZ-D7/3	181800	4
8	415	15	480Y/277	5	FAZ-D8/3	181801	4
10	415	15	480Y/277	5	FAZ-D10/3	181802	4
12	415	15	480Y/277	5	FAZ-D12/3	181803	4
13	415	15	480Y/277	5	FAZ-D13/3	181804	4
15	415	15	480Y/277	5	FAZ-D15/3	181805	4
16	415	15	480Y/277	5	FAZ-D16/3	181806	4
20	415	15	480Y/277	5	FAZ-D20/3	181807	4
25	415	15	480Y/277	5	FAZ-D25/3	181808	4
30	415	15	480Y/277	5	FAZ-D30/3	181809	4
32	415	15	480Y/277	5	FAZ-D32/3	181810	4
40	415	10	480Y/277	5	FAZ-D40/3	181811	4
50	415	10	-	-	FAZ-D50/3	181812	4
63	415	10	-	-	FAZ-D63/3	181813	4

SG55712



Rated current I_n (A)	Rated voltage (V)	Breaking capacity acc. to IEC/EN 60947-2 (kA)	Rated voltage UL1077 (V)	Breaking capacity acc. to UL1077 (kA)	Type Designation	Article No.	Units per package
----------------------------	----------------------	---	--------------------------------	--	---------------------	-------------	-------------------------

3+N-pole

0.5	415	15	480Y/277	5	FAZ-D0,5/3N	181814	3
1	415	15	480Y/277	5	FAZ-D1/3N	181815	3
1.5	415	15	480Y/277	5	FAZ-D1,5/3N	181816	3
1.6	415	15	480Y/277	5	FAZ-D1,6/3N	181817	3
2	415	15	480Y/277	5	FAZ-D2/3N	181818	3
2.5	415	15	480Y/277	5	FAZ-D2,5/3N	181819	3
3	415	15	480Y/277	5	FAZ-D3/3N	181820	3
3.5	415	15	480Y/277	5	FAZ-D3,5/3N	181821	3
4	415	15	480Y/277	5	FAZ-D4/3N	181822	3
5	415	15	480Y/277	5	FAZ-D5/3N	181823	3
6	415	15	480Y/277	5	FAZ-D6/3N	181824	3
8	415	15	480Y/277	5	FAZ-D8/3N	181825	3
10	415	15	480Y/277	5	FAZ-D10/3N	181826	3
12	415	15	480Y/277	5	FAZ-D12/3N	181827	3
13	415	15	480Y/277	5	FAZ-D13/3N	181828	3
15	415	15	480Y/277	5	FAZ-D15/3N	181829	3
16	415	15	480Y/277	5	FAZ-D16/3N	181830	3
20	415	15	480Y/277	5	FAZ-D20/3N	181639	3
25	415	15	480Y/277	5	FAZ-D25/3N	181640	3
32	415	15	480Y/277	5	FAZ-D32/3N	181641	3
40	415	15	480Y/277	5	FAZ-D40/3N	181642	3
50	415	10	-	-	FAZ-D50/3N	181643	3
63	415	10	-	-	FAZ-D63/3N	181644	3

SG55812



4-pole

0.5	415	15	480Y/277	5	FAZ-D0,5/4	181645	3
1	415	15	480Y/277	5	FAZ-D1/4	181646	3
1.5	415	15	480Y/277	5	FAZ-D1,5/4	181647	3
1.6	415	15	480Y/277	5	FAZ-D1,6/4	181648	3
2	415	15	480Y/277	5	FAZ-D2/4	181649	3
2.5	415	15	480Y/277	5	FAZ-D2,5/4	181650	3
3	415	15	480Y/277	5	FAZ-D3/4	181843	3
3.5	415	15	480Y/277	5	FAZ-D3,5/4	181844	3
4	415	15	480Y/277	5	FAZ-D4/4	181845	3
5	415	15	480Y/277	5	FAZ-D5/4	181846	3
6	415	15	480Y/277	5	FAZ-D6/4	181847	3
7	415	15	480Y/277	5	FAZ-D7/4	181848	3
8	415	15	480Y/277	5	FAZ-D8/4	181849	3
10	415	15	480Y/277	5	FAZ-D10/4	181850	3
12	415	15	480Y/277	5	FAZ-D12/4	181851	3
13	415	15	480Y/277	5	FAZ-D13/4	181852	3
15	415	15	480Y/277	5	FAZ-D15/4	181853	3
16	415	15	480Y/277	5	FAZ-D16/4	181854	3
20	415	15	480Y/277	5	FAZ-D20/4	181855	3
25	415	15	480Y/277	5	FAZ-D25/4	181856	3
32	415	15	480Y/277	5	FAZ-D32/4	181857	3
40	415	10	480Y/277	5	FAZ-D40/4	181858	3
50	415	10	-	-	FAZ-D50/4	181859	3
63	415	10	-	-	FAZ-D63/4	181860	3

FAZ Miniature Circuit Breakers (MCBs)

Characteristic K

	Rated current I_n (A)	Rated voltage (V)	Breaking capacity acc. to IEC/EN 60947-2 (kA)	Rated voltage UL1077 (V)	Breaking capacity acc. to UL1077 (kA)	Type Designation	Article No.	Units per package
1-pole								
	0.5	240/415	15	277	5	FAZ-K0,5/1	278589	12/120
	1	240/415	15	277	5	FAZ-K1/1	278590	12/120
	1.6	240/415	15	277	5	FAZ-K1,6/1	278591	12/120
	2	240/415	15	277	5	FAZ-K2/1	278592	12/120
	3	240/415	15	277	5	FAZ-K3/1	278593	12/120
	4	240/415	15	277	5	FAZ-K4/1	278594	12/120
	6	240/415	15	277	5	FAZ-K6/1	278595	12/120
	8	240/415	15	277	5	FAZ-K8/1	278596	12/120
	10	240/415	15	277	5	FAZ-K10/1	278597	12/120
	13	240/415	15	277	5	FAZ-K13/1	278598	12/120
	16	240/415	15	277	5	FAZ-K16/1	278599	12/120
	20	240/415	15	277	5	FAZ-K20/1	278600	12/120
	25	240/415	15	277	5	FAZ-K25/1	278601	12/120
	32	240/415	15	277	5	FAZ-K32/1	278602	12/120
	40	240/415	15	277	5	FAZ-K40/1	278603	12/120
	50	240/415	15	277	5	FAZ-K50/1	278604	12/120
	63	240/415	15	277	5	FAZ-K63/1	278605	12/120

SG53112



SG55612



1+N-pole								
	0.5	240	15	277	5	FAZ-K0,5/1N	278702	1/60
	1	240	15	277	5	FAZ-K1/1N	278703	1/60
	1.6	240	15	277	5	FAZ-K1,6/1N	278704	1/60
	2	240	15	277	5	FAZ-K2/1N	278705	1/60
	3	240	15	277	5	FAZ-K3/1N	278706	1/60
	4	240	15	277	5	FAZ-K4/1N	278707	1/60
	6	240	15	277	5	FAZ-K6/1N	278708	1/60
	8	240	15	277	5	FAZ-K8/1N	278709	1/60
	10	240	15	277	5	FAZ-K10/1N	278710	1/60
	13	240	15	277	5	FAZ-K13/1N	278711	1/60
	16	240	15	277	5	FAZ-K16/1N	278712	1/60
	20	240	15	277	5	FAZ-K20/1N	278713	1/60
	25	240	15	277	5	FAZ-K25/1N	278714	1/60
	32	240	15	277	5	FAZ-K32/1N	278715	1/60
	40	240	15	277	5	FAZ-K40/1N	278716	1/60
	50	240	15	277	5	FAZ-K50/1N	278717	1/60
	63	240	15	277	5	FAZ-K63/1N	278718	1/60

SG55112



Rated current I_n (A)	Rated voltage (V)	Breaking capacity acc. to IEC/EN 60947-2 (kA)	Rated voltage UL1077 (V)	Breaking capacity acc. to UL1077 (kA)	Type Designation	Article No.	Units per package
----------------------------	----------------------	---	--------------------------------	--	---------------------	-------------	-------------------------

2-pole

0.5	415	15	480Y/277	5	FAZ-K0,5/2	278788	1/60
1	415	15	480Y/277	5	FAZ-K1/2	278789	1/60
1.6	415	15	480Y/277	5	FAZ-K1,6/2	278790	1/60
2	415	15	480Y/277	5	FAZ-K2/2	278791	1/60
3	415	15	480Y/277	5	FAZ-K3/2	278792	1/60
4	415	15	480Y/277	5	FAZ-K4/2	278793	1/60
6	415	15	480Y/277	5	FAZ-K6/2	278794	1/60
8	415	15	480Y/277	5	FAZ-K8/2	278795	1/60
10	415	15	480Y/277	5	FAZ-K10/2	278796	1/60
13	415	15	480Y/277	5	FAZ-K13/2	278797	1/60
16	415	15	480Y/277	5	FAZ-K16/2	278798	1/60
20	415	15	480Y/277	5	FAZ-K20/2	278799	1/60
25	415	15	480Y/277	5	FAZ-K25/2	278800	1/60
32	415	15	480Y/277	5	FAZ-K32/2	278801	1/60
40	415	15	480Y/277	5	FAZ-K40/2	278802	1/60
50	415	15	480Y/277	5	FAZ-K50/2	278803	1/60
63	415	15	480Y/277	5	FAZ-K63/2	278804	1/60

SG53412



3-pole

0.5	415	15	480Y/277	5	FAZ-K0,5/3	278901	1/40
1	415	15	480Y/277	5	FAZ-K1/3	278902	1/40
1.6	415	15	480Y/277	5	FAZ-K1,6/3	278903	1/40
2	415	15	480Y/277	5	FAZ-K2/3	278904	1/40
3	415	15	480Y/277	5	FAZ-K3/3	278905	1/40
4	415	15	480Y/277	5	FAZ-K4/3	278906	1/40
6	415	15	480Y/277	5	FAZ-K6/3	278907	1/40
8	415	15	480Y/277	5	FAZ-K8/3	278908	1/40
10	415	15	480Y/277	5	FAZ-K10/3	278909	1/40
13	415	15	480Y/277	5	FAZ-K13/3	278910	1/40
16	415	15	480Y/277	5	FAZ-K16/3	278911	1/40
20	415	15	480Y/277	5	FAZ-K20/3	278912	1/40
25	415	15	480Y/277	5	FAZ-K25/3	278913	1/40
32	415	15	480Y/277	5	FAZ-K32/3	278914	1/40
40	415	15	480Y/277	5	FAZ-K40/3	278915	1/40
50	415	15	480Y/277	5	FAZ-K50/3	278916	1/40
63	415	15	480Y/277	5	FAZ-K63/3	278917	1/40

Rated current I_n (A)	Rated voltage (V)	Breaking capacity acc. to IEC/EN 60947-2 (kA)	Rated voltage UL1077 (V)	Breaking capacity acc. to UL1077 (kA)	Type Designation	Article No.	Units per package
----------------------------	----------------------	---	--------------------------------	--	---------------------	-------------	-------------------------

SG55712



3+N-pole

0.5	415	15	480Y/277	5	FAZ-K0,5/3N	279003	1/30
1	415	15	480Y/277	5	FAZ-K1/3N	279004	1/30
1.6	415	15	480Y/277	5	FAZ-K1,6/3N	279005	1/30
2	415	15	480Y/277	5	FAZ-K2/3N	279006	1/30
3	415	15	480Y/277	5	FAZ-K3/3N	279007	1/30
4	415	15	480Y/277	5	FAZ-K4/3N	279008	1/30
6	415	15	480Y/277	5	FAZ-K6/3N	279009	1/30
8	415	15	480Y/277	5	FAZ-K8/3N	279010	1/30
10	415	15	480Y/277	5	FAZ-K10/3N	279011	1/30
13	415	15	480Y/277	5	FAZ-K13/3N	279012	1/30
16	415	15	480Y/277	5	FAZ-K16/3N	279013	1/30
20	415	15	480Y/277	5	FAZ-K20/3N	279014	1/30
25	415	15	480Y/277	5	FAZ-K25/3N	279015	1/30
32	415	15	480Y/277	5	FAZ-K32/3N	279016	1/30
40	415	15	480Y/277	5	FAZ-K40/3N	279017	1/30
50	415	15	480Y/277	5	FAZ-K50/3N	279018	1/30
63	415	15	480Y/277	5	FAZ-K63/3N	279019	1/30

SG55812



4-pole

0.5	415	15	480Y/277	5	FAZ-K0,5/4	279089	1/30
1	415	15	480Y/277	5	FAZ-K1/4	279090	1/30
1.6	415	15	480Y/277	5	FAZ-K1,6/4	279091	1/30
2	415	15	480Y/277	5	FAZ-K2/4	279092	1/30
3	415	15	480Y/277	5	FAZ-K3/4	279093	1/30
4	415	15	480Y/277	5	FAZ-K4/4	279094	1/30
6	415	15	480Y/277	5	FAZ-K6/4	279095	1/30
8	415	15	480Y/277	5	FAZ-K8/4	279096	1/30
10	415	15	480Y/277	5	FAZ-K10/4	279097	1/30
13	415	15	480Y/277	5	FAZ-K13/4	279098	1/30
16	415	15	480Y/277	5	FAZ-K16/4	279099	1/30
20	415	15	480Y/277	5	FAZ-K20/4	279100	1/30
25	415	15	480Y/277	5	FAZ-K25/4	279101	1/30
32	415	15	480Y/277	5	FAZ-K32/4	279102	1/30
40	415	15	480Y/277	5	FAZ-K40/4	279103	1/30
50	415	15	480Y/277	5	FAZ-K50/4	279104	1/30
63	415	15	480Y/277	5	FAZ-K63/4	279105	1/30

FAZ Miniature Circuit Breakers (MCBs)

Characteristic S

	Rated current I_n (A)	Rated voltage (V)	Breaking capacity acc. to IEC/EN 60947-2 (kA)	Rated voltage UL1077 (V)	Breaking capacity acc. to UL1077 (kA)	Type Designation	Article No.	Units per package
1-pole								
1	240/415	10	277	5		FAZ-S1/1	181861	12
2	240/415	10	277	5		FAZ-S2/1	181862	12
3	240/415	10	277	5		FAZ-S3/1	181863	12
4	240/415	10	277	5		FAZ-S4/1	181864	12
6	240/415	10	277	5		FAZ-S6/1	181865	12
10	240/415	10	277	5		FAZ-S10/1	181866	12
16	240/415	10	277	5		FAZ-S16/1	181867	12
20	240/415	10	277	5		FAZ-S20/1	181868	12
25	240/415	10	277	5		FAZ-S25/1	181869	12
32	240/415	10	277	5		FAZ-S32/1	181870	12
40	240/415	10	277	5		FAZ-S40/1	181871	12

SG53112



SG55112



2-pole								
1	415	10	480Y/277	5		FAZ-S1/2	181872	6
2	415	10	480Y/277	5		FAZ-S2/2	181873	6
3	415	10	480Y/277	5		FAZ-S3/2	181874	6
4	415	10	480Y/277	5		FAZ-S4/2	181875	6
6	415	10	480Y/277	5		FAZ-S6/2	181876	6
10	415	10	480Y/277	5		FAZ-S10/2	181877	6
16	415	10	480Y/277	5		FAZ-S16/2	181878	6
20	415	10	480Y/277	5		FAZ-S20/2	181879	6
25	415	10	480Y/277	5		FAZ-S25/2	181880	6
32	415	10	480Y/277	5		FAZ-S32/2	181881	6
40	415	10	480Y/277	5		FAZ-S40/2	181882	6

FAZ Miniature Circuit Breakers (MCBs)

Characteristic Z

Rated current I_n (A)	Rated voltage (V)	Breaking capacity acc. to IEC/EN 60947-2 (kA)	Rated voltage UL1077 (V)	Breaking capacity acc. to UL1077 (kA)	Type Designation	Article No.	Units per package
1-pole							
0,5	240/415	15	277	5	FAZ-Z0,5/1	278617	12/120
1	240/415	15	277	5	FAZ-Z1/1	278618	12/120
1.6	240/415	15	277	5	FAZ-Z1,6/1	278619	12/120
2	240/415	15	277	5	FAZ-Z2/1	278620	12/120
3	240/415	15	277	5	FAZ-Z3/1	278621	12/120
4	240/415	15	277	5	FAZ-Z4/1	278622	12/120
6	240/415	15	277	5	FAZ-Z6/1	278623	12/120
8	240/415	15	277	5	FAZ-Z8/1	278624	12/120
10	240/415	15	277	5	FAZ-Z10/1	278625	12/120
13	240/415	15	277	5	FAZ-Z13/1	106020	12/120
16	240/415	15	277	5	FAZ-Z16/1	278626	12/120
20	240/415	15	277	5	FAZ-Z20/1	278627	12/120
25	240/415	15	277	5	FAZ-Z25/1	278628	12/120
32	240/415	15	277	5	FAZ-Z32/1	278629	12/120
40	240/415	15	277	5	FAZ-Z40/1	278630	12/120
50	240/415	15	277	5	FAZ-Z50/1	278631	12/120
63	240/415	15	277	5	FAZ-Z63/1	278632	12/120

SG53112



SG55112



2-pole							
0,5	415	15	480Y/277	5	FAZ-Z0,5/2	278816	1/60
1	415	15	480Y/277	5	FAZ-Z1/2	278817	1/60
1.6	415	15	480Y/277	5	FAZ-Z1,6/2	278818	1/60
2	415	15	480Y/277	5	FAZ-Z2/2	278819	1/60
3	415	15	480Y/277	5	FAZ-Z3/2	278820	1/60
4	415	15	480Y/277	5	FAZ-Z4/2	278821	1/60
6	415	15	480Y/277	5	FAZ-Z6/2	278822	1/60
8	415	15	480Y/277	5	FAZ-Z8/2	278823	1/60
10	415	15	480Y/277	5	FAZ-Z10/2	278824	1/60
13	415	15	480Y/277	5	FAZ-Z13/2	106021	1/60
16	415	15	480Y/277	5	FAZ-Z16/2	278825	1/60
20	415	15	480Y/277	5	FAZ-Z20/2	278826	1/60
25	415	15	480Y/277	5	FAZ-Z25/2	278827	1/60
32	415	15	480Y/277	5	FAZ-Z32/2	278828	1/60
40	415	15	480Y/277	5	FAZ-Z40/2	278829	1/60
50	415	15	480Y/277	5	FAZ-Z50/2	278830	1/60
63	415	15	480Y/277	5	FAZ-Z63/2	278831	1/60

SG53412



3-pole

Rated current I_n (A)	Rated voltage (V)	Breaking capacity acc. to IEC/EN 60947-2 (kA)	Rated voltage UL1077 (V)	Breaking capacity acc. to UL1077 (kA)	Type Designation	Article No.	Units per package
0.5	415	15	480Y/277	5	FAZ-Z0,5/3	278918	1/40
1	415	15	480Y/277	5	FAZ-Z1/3	278919	1/40
1.6	415	15	480Y/277	5	FAZ-Z1,6/3	278920	1/40
2	415	15	480Y/277	5	FAZ-Z2/3	278921	1/40
3	415	15	480Y/277	5	FAZ-Z3/3	278922	1/40
4	415	15	480Y/277	5	FAZ-Z4/3	278923	1/40
6	415	15	480Y/277	5	FAZ-Z6/3	278924	1/40
8	415	15	480Y/277	5	FAZ-Z8/3	278925	1/40
10	415	15	480Y/277	5	FAZ-Z10/3	278926	1/40
13	415	15	480Y/277	5	FAZ-Z13/3	106022	1/40
16	415	15	480Y/277	5	FAZ-Z16/3	278927	1/40
20	415	15	480Y/277	5	FAZ-Z20/3	278928	1/40
25	415	15	480Y/277	5	FAZ-Z25/3	278929	1/40
32	415	15	480Y/277	5	FAZ-Z32/3	278930	1/40
40	415	15	480Y/277	5	FAZ-Z40/3	278931	1/40
50	415	15	480Y/277	5	FAZ-Z50/3	278932	1/40
63	415	15	480Y/277	5	FAZ-Z63/3	278933	1/40

SG55812



4-pole

Rated current I_n (A)	Rated voltage (V)	Breaking capacity acc. to IEC/EN 60947-2 (kA)	Rated voltage UL1077 (V)	Breaking capacity acc. to UL1077 (kA)	Type Designation	Article No.	Units per package
0.5	415	15	480Y/277	5	FAZ-Z0,5/4	279106	1/60
1	415	15	480Y/277	5	FAZ-Z1/4	279107	1/60
1.6	415	15	480Y/277	5	FAZ-Z1,6/4	279108	1/60
2	415	15	480Y/277	5	FAZ-Z2/4	279109	1/60
3	415	15	480Y/277	5	FAZ-Z3/4	279110	1/60
4	415	15	480Y/277	5	FAZ-Z4/4	279111	1/60
6	415	15	480Y/277	5	FAZ-Z6/4	279112	1/60
8	415	15	480Y/277	5	FAZ-Z8/4	279113	1/60
10	415	15	480Y/277	5	FAZ-Z10/4	279114	1/60
13	415	15	480Y/277	5	FAZ-Z13/4	106023	1/60
16	415	15	480Y/277	5	FAZ-Z16/4	279115	1/60
20	415	15	480Y/277	5	FAZ-Z20/4	279116	1/60
25	415	15	480Y/277	5	FAZ-Z25/4	279117	1/60
32	415	15	480Y/277	5	FAZ-Z32/4	279118	1/60
40	415	15	480Y/277	5	FAZ-Z40/4	279119	1/60
50	415	15	480Y/277	5	FAZ-Z50/4	279120	1/60
63	415	15	480Y/277	5	FAZ-Z63/4	279121	1/60

FAZ-PN Miniature Circuit Breakers (MCBs)

Characteristic B

Rated current I_n (A)	Rated voltage (V)	Breaking capacity acc. to IEC/EN 60898-1 (kA)	Breaking capacity acc. to IEC/EN 60947-2 (kA)	Type Designation	Article No.	Units per package
1+N-pole (1MU)						
6	240	6	10	FAZ-PN-B6/1N	279146	12/120
10	240	6	10	FAZ-PN-B10/1N	279147	12/120
13	240	6	10	FAZ-PN-B13/1N	279148	12/120
16	240	6	10	FAZ-PN-B16/1N	279149	12/120
20	240	6	10	FAZ-PN-B20/1N	279150	12/120
25	240	6	10	FAZ-PN-B25/1N	279151	12/120
32	240	6	10	FAZ-PN-B32/1N	279152	12/120
40	240	6	10	FAZ-PN-B40/1N	279153	12/120

SG54212



FAZ-PN Miniature Circuit Breakers (MCBs)

Characteristic C



Rated current I_n (A)	Rated voltage (V)	Breaking capacity acc. to IEC/EN 60898-1 (kA)	Breaking capacity acc. to IEC/EN 60947-2 (kA)	Type Designation	Article No.	Units per package
1+N-pole (1MU)						
2	240	6	10	FAZ-PN-C2/1N	279154	12/120
4	240	6	10	FAZ-PN-C4/1N	279155	12/120
6	240	6	10	FAZ-PN-C6/1N	279156	12/120
10	240	6	10	FAZ-PN-C10/1N	279157	12/120
13	240	6	10	FAZ-PN-C13/1N	279158	12/120
16	240	6	10	FAZ-PN-C16/1N	279159	12/120
20	240	6	10	FAZ-PN-C20/1N	279160	12/120
25	240	6	10	FAZ-PN-C25/1N	279161	12/120
32	240	6	10	FAZ-PN-C32/1N	279162	12/120
40	240	6	10	FAZ-PN-C40/1N	279163	12/120

SG54212



FAZ-...-HS Miniature Circuit Breakers (MCBs)

Characteristic B

	Rated current I_n (A)	Rated voltage (V)	Breaking capacity acc. to IEC/EN 60898-1 (kA)	Type Designation	Article No.	Units per package
1-pole						
 wa_sg00114	4	240	10	FAZ-B4/1-HS	279274	12/120
2-pole						
 SG55512	4	240	10	FAZ-B4/2-HS	279275	1/60

FAZ Miniature Circuit Breakers

Accessories:

Auxiliary switch for subsequent installation	ZP-IHK	286052
Auxiliary switch for subsequent installation	ZP-WHK	286053
Tripping signal contact for subsequent installation	ZP-NHK	248437
Shunt trip release	ZP-ASA	248438, 248439
Undervoltage release	Z-USA	258288, 248289, 248290
	Z-USD	248292, 248291
Switching interlock	Z-IS/SPE-1TE	274418
Terminal cover		
1-pole	Z7-AK-1TE	750754200
2-pole	Z-CV/SD-2P	221954800
3-pole	Z-CV/SD-3P	221954900
4-pole	Z-CV/SD-4P	221953900

Specifications FAZ

Technical data

	B Curve	C Curve	D Curve
Electrical			
Approvals	UR (UL 1077), CSA (CSA 22.2 No. 235), CE, CB (Not for D50 and D63)		
Standards	IEC/EN 60947-2		
Short-circuit trip response	3–5 I_n	5–10 I_n	10–20 I_n
Supplementary Protectors – UL/CSA			
Current range	1–63A	0.5–63A	0.5–40A
Maximum voltage ratings – UL/CSA			
Single-pole	277 Vac 48 Vdc	277 Vac 48 Vdc	277 Vac 48 Vdc
Two-, three-pole	480Y/277 Vac	480Y/277 Vac	480Y/277 Vac
Two poles in series	96 Vdc	96 Vdc	96 Vdc
Thermal tripping characteristics			
Single-pole	< 1 hour @ 1.35 x I_n @ 40°C	< 1 hour @ 1.35 x I_n @ 40°C	< 1 hour @ 1.35 x I_n @ 40°C
Multi-pole	< 1 hour @ 1.45 x I_n @ 40°C	< 1 hour @ 1.45 x I_n @ 40°C	< 1 hour @ 1.45 x I_n @ 40°C
Short-circuit ratings (at max. voltage)			
Single-pole	10 kA (5 kA for 40–63A device)	10 kA (5 kA for 40–63A device)	5 kA
Two-, three-pole	10 kA (5 kA for 40–63A device)	10 kA (5 kA for 40–63A device)	5 kA
Single-pole	10 kA @ 48 Vdc	10 kA @ 48 Vdc	10 kA @ 48 Vdc
Two poles in series	10 kA @ 96 Vdc	10 kA @ 96 Vdc	10 kA @ 96 Vdc
Miniature Circuit Breaker – IEC			
Current range	1–63A	0.5–63A	0.5–63A
Maximum voltage ratings – IEC 60947-2			
Single-pole	230 Vac 60 Vdc	230 Vac 60 Vdc	230 Vac 60 Vdc
Two-, three-pole	230/400 Vac	230/400 Vac	230/400 Vac
Maximum Voltage Ratings – IEC 60898			
Single-pole	240 Vac	240 Vac	240 Vac
Two-, three-pole	240/415 Vac	240/415 Vac	240/415 Vac
Thermal tripping characteristics			
	> 1 hour @ 1.05 x I_n @ 40°C < 1 hour @ 1.3 x I_n @ 40°C	> 1 hour @ 1.05 x I_n @ 40°C < 1 hour @ 1.3 x I_n @ 40°C	> 1 hour @ 1.05 x I_n @ 40°C < 1 hour @ 1.3 x I_n @ 40°C
Interrupt ratings (at max. voltage)			
IEC 60947-2	15 kA	15 kA	15 kA (type D50 and D63: 10kA)
IEC 60898	10 kA	10 kA	10 kA (type D50 and D63: 6kA)
Operational switching capacity	7.5 kA	7.5 kA	7.5 kA (type D50 and D63: 6kA)
Max. back-up fuse [gL/gG]	125A	125A	125A
Rated impulse withstand – U_{imp}	4000 Vac	4000 Vac	4000 Vac
Rated insulation voltage – U_i	440 Vac	440 Vac	440 Vac
Environmental/General			
Selectivity class	3	3	3
Lifespan (operations)	> 10000 (1 operation = ON/OFF)	> 10000 (1 operation = ON/OFF)	> 10000 (1 operation = ON/OFF)
Shock (IEC 68-2-22)	10g–120 ms	10g–120 ms	10g–120 ms
Operating temperature range	-40 to +75°C	-40 to +75°C	-40 to +75°C
Mechanical			
Standard front dimension			
Device height	80 mm	80 mm	80 mm
Terminal protection	Finger and back-of-hand proof	Finger and back-of-hand proof	Finger and back-of-hand proof
Mounting width per pole	17.5 mm	17.5 mm	17.5 mm
Mounting	IEC/EN 60715 top-hat rail	IEC/EN 60715 top-hat rail	IEC/EN 60715 top-hat rail
Degree of protection	IP20	IP20	IP20
Terminals top and bottom	Twin-purpose terminals	Twin-purpose terminals	Twin-purpose terminals
Supply connection	Line or load side	Line or load side	Line or load side
Terminal capacity [mm ²]	1 x 25 / 2 x 10	1 x 25 / 2 x 10	1 x 25 / 2 x 10
Torque	2.4 Nm	2.4 Nm	2.4 Nm
Thickness of busbar material	0.8–2 mm	0.8–2 mm	0.8–2 mm
Mounting position	As required	As required	As required

Specifications FAZ

Technical Data (continued)

	K Curve	S Curve	Z Curve
Electrical			
Approvals	UR (UL 1077), CE	UR (UL 1077), CSA (CSA 22.2 No. 235) for 1-16 A, CE, CB	UR (UL 1077), CE
Standards	IEC/EN 60947-2		
Short-circuit trip response	8–12 I_n	13–17 I_n	2–3 I_n
Supplementary Protectors—UL/CSA			
Current range	0.5–63A	0.5–40A	1–63A
Maximum voltage ratings—UL/CSA			
Single-pole, single-pole + neutral	277 Vac 48 Vdc	277 Vac 48 Vdc	277 Vac 48 Vdc
Two-, three-, four-pole and three-pole + neutral	480Y/277 Vac	480Y/277 Vac	480Y/277 Vac
Two poles in series	96 Vdc	96 Vdc	96 Vdc
Thermal tripping characteristics			
Single-pole	< 1 hour @ 1.35 x I_n @ 40°C	< 1 hour @ 1.35 x I_n @ 40°C	< 1 hour @ 1.35 x I_n @ 40°C
Multi-pole	< 1 hour @ 1.45 x I_n @ 40°C	< 1 hour @ 1.45 x I_n @ 40°C	< 1 hour @ 1.45 x I_n @ 40°C
Short-circuit ratings (at max. voltage)			
Single-pole	5 kA @ 277 Vac	5 kA @ 277 Vac	5 kA @ 277 Vac
Single-pole + neutral	5 kA @ 277 Vac	5 kA @ 277 Vac	5 kA @ 277 Vac
Two-, three-, four-pole	5 kA @ 480Y/277 Vac	5 kA @ 480Y/277 Vac	5 kA @ 480Y/277 Vac
Miniature Circuit Breaker—IEC			
Current range	0.5–63A	0.5–40A	1–63A
Maximum voltage ratings—IEC 60947-2			
Single-pole, single-pole + neutral	240 Vac	240 Vac	240 Vac
Single-pole	60 Vdc	60 Vdc	60 Vdc
Two-, three-, four-pole, three-pole + neutral	240/415 Vac	240/415 Vac	240/415 Vac
Thermal tripping characteristics			
	> 1 hour @ 1.05 x I_n @ 30°C < 1 hour @ 1.3 x I_n @ 30°C	> 1 hour @ 1.05 x I_n @ 30°C < 1 hour @ 1.3 x I_n @ 30°C	> 1 hour @ 1.05 x I_n @ 30°C < 1 hour @ 1.3 x I_n @ 30°C
Interrupt ratings (at max. voltage)			
IEC 60947-2	15 kA	10 kA	10 kA
Operational switching capacity	7.5 kA	7.5 kA	7.5 kA
Max. back-up fuse [gL/gG]	125A	125A	125A
Rated impulse withstand— U_{imp}	4000 Vac	4000 Vac	4000 Vac
Rated insulation voltage— U_i	440 Vac	440 Vac	440 Vac
Environmental/General			
Selectivity class	3	3	3
Lifespan (operations)	> 10000 (1 operation = ON/OFF)	> 10000 (1 operation = ON/OFF)	> 10000 (1 operation = ON/OFF)
Shock (IEC 68-2-22)	10g–120 ms	10g–120 ms	10g–120 ms
Operating temperature range	-40°C to +75°C	-40°C to +75°C	-40°C to +75°C
Mechanical			
Standard front dimension			
Device height	80 mm	80 mm	80 mm
Terminal protection	Finger and back-of-hand proof	Finger and back-of-hand proof	Finger and back-of-hand proof
Mounting width per pole	17.5 mm	17.5 mm	17.5 mm
Mounting			
Degree of protection	IP20	IP20	IP20
Terminals top and bottom	Twin-purpose terminals	Twin-purpose terminals	Twin-purpose terminals
Supply connection	Line or load side	Line or load side	Line or load side
Terminal capacity [mm ²]	1 x 25 / 2 x 10	1 x 25 / 2 x 10	1 x 25 / 2 x 10
Torque	2.4 Nm	2.4 Nm	2.4 Nm
Thickness of busbar material	0.8–2 mm	0.8–2 mm	0.8–2 mm
Mounting position	As required	As required	As required

Connection diagram

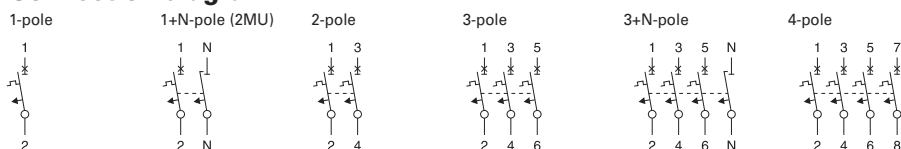

Dimensions (mm) FAZ

1-pole

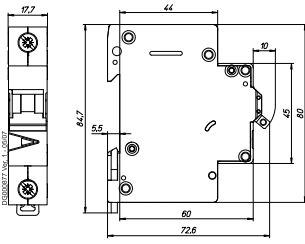

1+N-pole, 2-pole

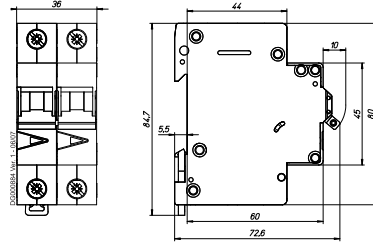

3-pole

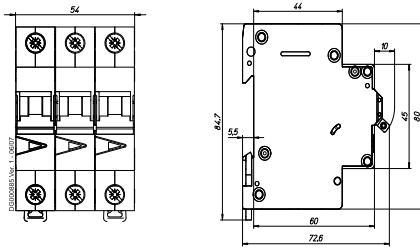

3+N-pole, 4-pole

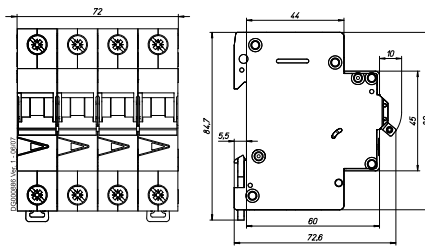

Tripping Characteristic FAZ

Characteristics B, C and D - IEC/EN60898-1

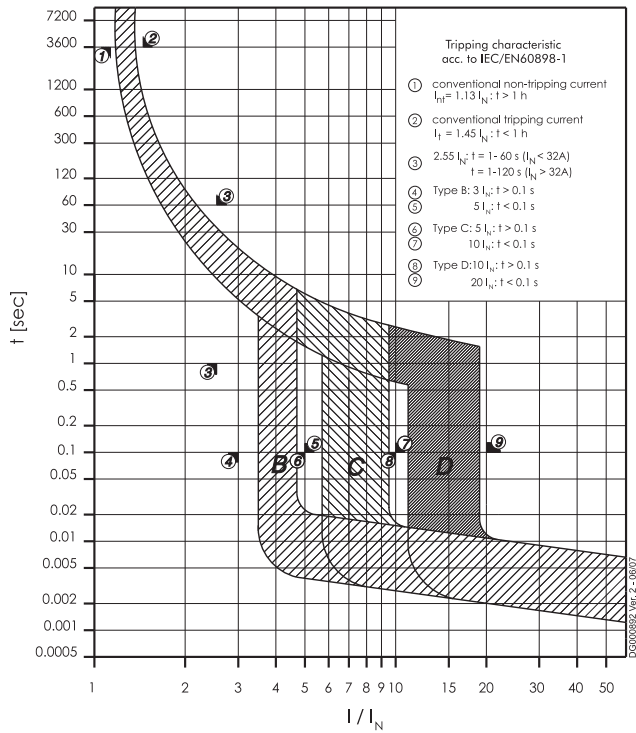

Characteristic K - IEC/EN 60947-2

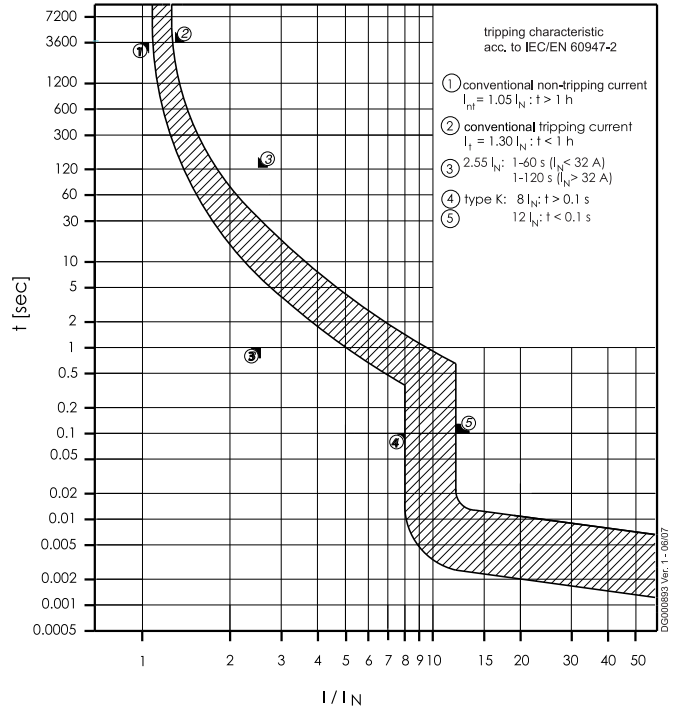

Characteristic S - IEC/EN 60947-2

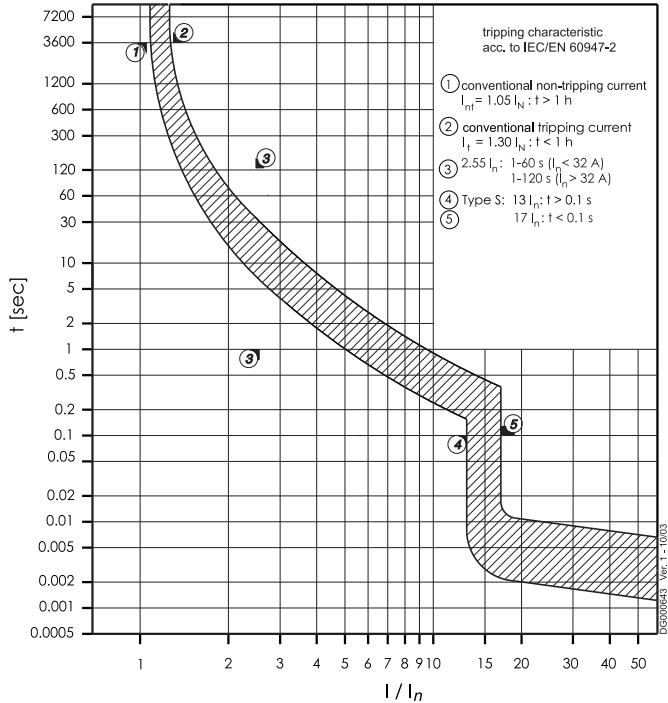

Characteristic S - UL1077

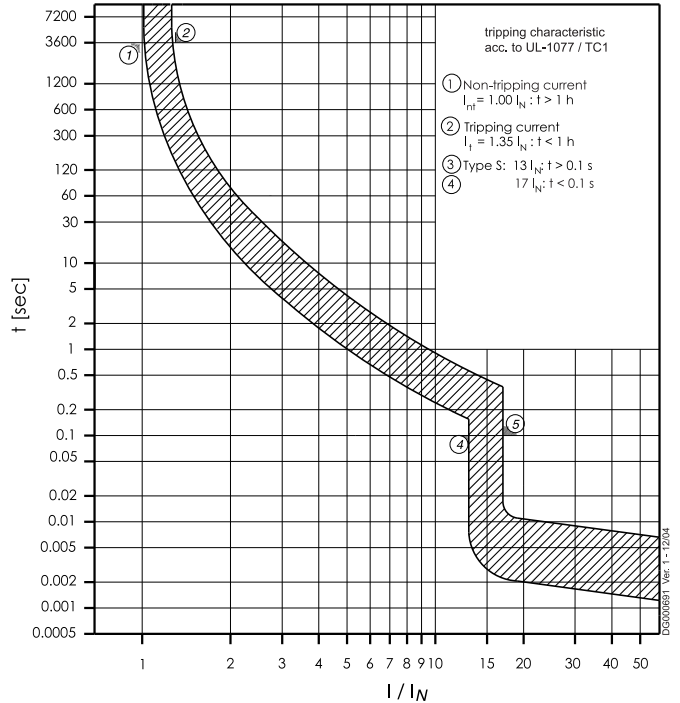

Tripping Characteristic FAZ

Characteristic Z - IEC/EN 60947-2

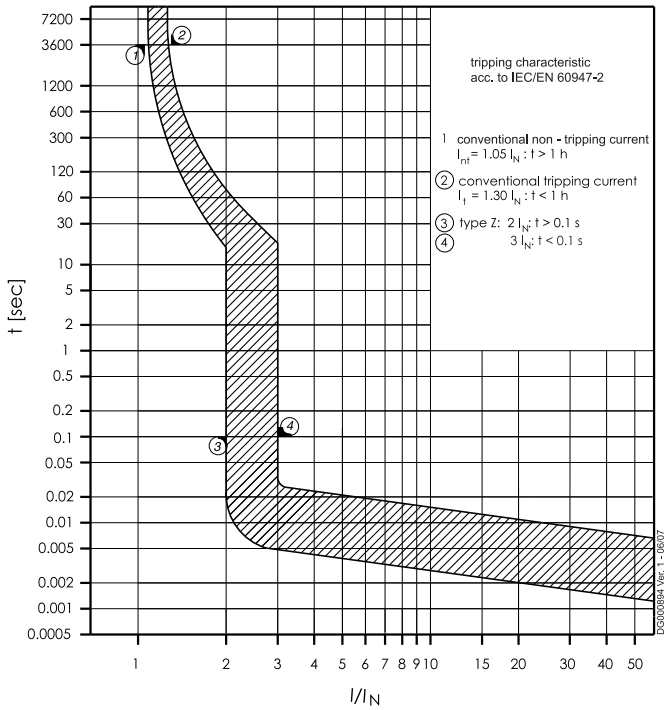

Characteristic Z - UL1077

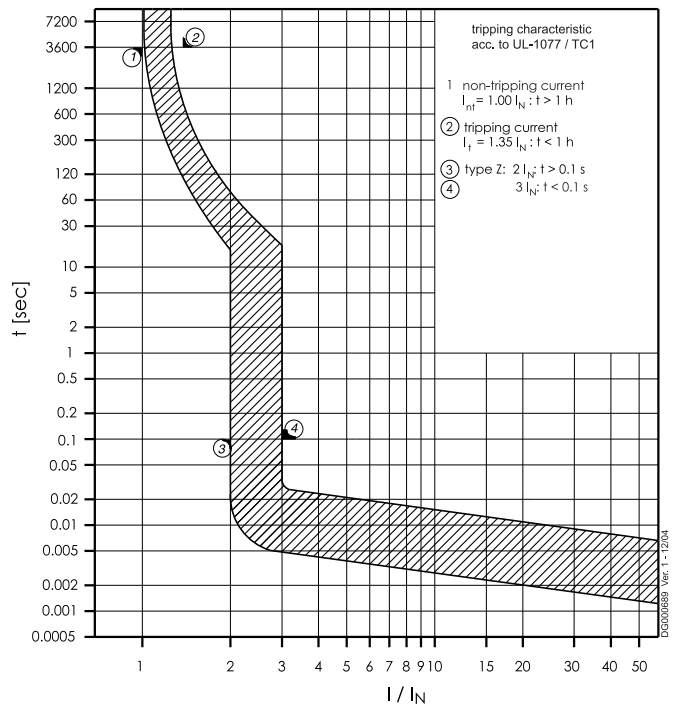

Internal Resistance FAZ

Type B

At room temperature (single pole)

In [A]	Z* [mΩ]	R [mΩ]
1	1120	1102
1.5	922	912
1.6	922	912
2	335	333
2.5	234	230
3	211	208
3.5	184	180
4	87.7	87.2
5	73.5	72.8
6	46.8	46.3
8	30.5	30.4
10	17.5	17.4
12	16.9	16.8
13	13.4	13.3
15	8.0	7.9
16	8.0	7.9
20	7.2	7.1
25	5.0	4.9
32	3.7	3.7
40	2.6	2.5
50	2.1	2.1
63	2.0	2.0

* 50Hz

Type C

At room temperature (single pole)

In [A]	Z* [mΩ]	R [mΩ]
0.16	68500	68300
0.25	27500	27400
0.5	4680	4670
0.75	2280	2250
1	1120	1100
1.5	589	587
1.6	589	587
2	335	333
2.5	234	230
3	131	130
3.5	143	141
4	87.7	87.2
5	73.5	72.8
6	39.3	39.1
8	30.5	30.4
10	14.1	14.0
12	13.5	13.4
13	13.4	13.3
15	8.0	7.9
16	8.0	7.9
20	7.2	7.1
25	5.0	4.9
32	3.7	3.7
40	2.6	2.5
50	2.1	2.1
63	2.0	2.0

* 50Hz

Type D

At room temperature (single pole)

In [A]	Z* [mΩ]	R [mΩ]
0.5	4680	4670
1	772	770
1.5	512	508
1.6	512	508
2	250	249
2.5	153	153
3	131	130
3.5	143	141
4	87.7	87.2
5	65.4	65.1
6	39.3	39.1
8	19.5	19.5
10	14.1	14.0
12	11.3	11.2
13	10.1	10.1
15	8.0	7.9
16	8.0	7.9
20	4.9	4.9
25	3.9	3.8
32	3.5	3.4
40	2.7	2.6

* 50Hz

Fault Loop Impedance FAZ

Max. allowed value for the Fault Loop Impedance Z_s
(acc. to DIN VDE 0100, part 410)

$$U_0 = 230 \text{ V}$$

Tripping time I_n/A	Type B		Type C		Type D	
	0,4s $Z_s (\Omega)$	5s $Z_s (\Omega)$	0,4s $Z_s (\Omega)$	5s $Z_s (\Omega)$	0,4s $Z_s (\Omega)$	5s $Z_s (\Omega)$
1	40,4	40,4	24,3	40,4	12,4	40,4
1.5	26,9	26,9	16,2	26,9	8,3	26,9
2	20,2	20,2	12,2	20,2	6,2	20,2
2.5	16,1	16,1	9,7	16,1	5,0	16,1
3	13,5	13,5	8,1	13,5	4,1	13,5
3.5	11,5	11,5	7,0	11,5	3,6	11,5
4	10,1	10,1	6,1	10,1	3,1	10,1
5	8,1	8,1	4,9	8,1	2,5	8,1
6	6,7	6,7	4,1	6,7	2,1	6,7
8	5,0	5,0	3,0	5,0	1,6	5,0
10	4,0	4,0	2,4	4,0	1,2	4,0
12	3,4	3,4	2,0	3,4	1,0	3,4
13	3,1	3,1	1,9	3,1	1,0	3,1
15	2,7	2,7	1,6	2,7	0,8	2,7
16	2,5	2,5	1,5	2,5	0,8	2,5
20	2,0	2,0	1,2	2,0	0,6	2,0
25	1,6	1,6	1,0	1,6	0,5	1,6
32	1,3	1,3	0,8	1,3	0,4	1,3
40	1,0	1,0	0,6	1,0	0,3	1,0
50	0,8	0,8	0,5	0,8	0,2	0,8
63	0,6	0,6	0,4	0,6	0,2	0,6

$$Z_s = R_{M.C.B.} + R_{Loop}$$

Data/factors taken from the time-current characteristic FAZ

For other rated voltages U_0 :

$$U_0 = 240 \text{ V: } Z_s * 1,04 \text{ applies}$$

$$U_0 = 127 \text{ V: } Z_s * 0,55 \text{ applies}$$

Power Loss at I_n FAZ

Type B

I_n [A]	1p P [W]	1pN P [W]	2p P [W]	3p P [W]	3pN* P [W]
1	1.6	1.7	3.1	4.7	4.8
1.5	2.3	2.5	4.6	6.9	7.2
1.6	2.5	2.7	4.9	7.4	7.6
2	1.4	1.5	2.8	4.1	4.3
2.5	1.5	1.7	3.1	4.6	4.7
3	2.5	2.7	5.0	7.6	7.8
3.5	2.5	2.8	5.1	7.8	8.0
4	1.4	1.6	2.9	4.4	4.5
5	1.9	2.1	3.8	5.8	6.0
6	1.8	2.0	3.6	5.5	5.6
8	2.1	2.3	4.1	6.3	6.5
10	1.9	2.1	3.9	5.9	6.1
12	2.8	3.2	5.9	8.7	9.0
13	2.5	2.9	5.3	7.8	8.1
15	2.1	2.4	4.4	6.5	6.7
16	2.2	2.6	4.7	6.9	7.2
20	3.2	3.6	6.6	9.8	10.1
25	3.0	3.5	6.4	9.4	9.7
32	3.7	4.4	8.1	12.1	12.5
40	3.4	4.1	7.5	11.2	11.5
50	4.5	5.4	9.9	14.9	15.3
63	5.2	6.3	11.5	17.2	17.7

*symmetrical load

Type C

I_n [A]	1p P [W]	1pN P [W]	2p P [W]	3p P [W]	3pN* P [W]
0.16	2.2	2.4	4.4	6.7	6.9
0.25	2.0	2.2	4.0	6.1	6.3
0.5	1.2	1.3	2.4	3.5	3.7
0.75	1.3	1.4	2.6	3.9	4.1
1	1.6	1.7	3.1	4.7	4.8
1.5	1.5	1.6	2.9	4.4	4.6
1.6	1.6	1.7	3.1	4.7	4.9
2	1.4	1.5	2.8	4.1	4.3
2.5	1.5	1.7	3.1	4.6	4.7
3	1.2	1.3	2.4	3.6	3.7
3.5	1.3	1.4	2.6	3.9	4.0
4	1.4	1.6	2.9	4.4	4.5
5	1.9	2.1	3.8	5.8	6.0
6	1.5	1.6	2.9	4.4	4.6
8	2.1	2.3	4.1	6.3	6.5
10	1.5	1.7	3.0	4.6	4.7
12	2.1	2.4	4.4	6.5	6.8
13	2.5	2.9	5.3	7.8	8.1
15	2.1	2.4	4.4	6.5	6.7
16	2.2	2.6	4.7	6.9	7.2
20	3.2	3.6	6.6	9.8	10.1
25	3.0	3.5	6.4	9.4	9.7
32	3.7	4.4	8.1	12.1	12.5
40	3.4	4.1	7.5	11.2	11.5
50	4.5	5.4	9.9	14.9	15.3
63	5.2	6.3	11.5	17.2	17.7

*symmetrical load

Type D

I_n [A]	1p P [W]	1pN P [W]	2p P [W]	3p P [W]	3pN* P [W]
0.5	1.2	1.3	2.4	3.5	3.7
1	0.8	0.9	1.6	2.4	2.5
1.5	1.2	1.3	2.3	3.5	3.6
1.6	1.3	1.4	2.5	3.8	3.9
2	1.0	1.1	2.0	3.0	3.1
2.5	1.0	1.1	1.9	2.9	3.0
3	1.2	1.3	2.4	3.6	3.7
3.5	1.3	1.4	2.6	3.9	4.0
4	1.4	1.6	2.9	4.4	4.5
5	1.7	1.8	3.3	5.1	5.3
6	1.5	1.6	2.9	4.4	4.6
8	1.3	1.5	2.6	4.0	4.2
10	1.5	1.7	3.0	4.6	4.7
12	1.7	2.0	3.6	5.3	5.4
13	1.9	2.2	4.0	5.9	6.1
15	2.1	2.4	4.4	6.5	6.7
16	2.2	2.6	4.7	6.9	7.2
20	2.0	2.2	4.1	6.1	6.2
25	2.5	2.9	5.2	7.7	7.9
32	3.4	4.0	7.4	11.1	11.4
40	3.2	3.8	7.0	10.4	10.7

*symmetrical load

Influence of Ambient Temperature FAZ

On Load Carrying Capacity (temperature derating)

I_N [A]	Ambient temperature T [°C]																
	-40	-30	-20	-10	0	10	20	30	35	40	45	50	55	60	65	70	75
0.16	0.2	0.2	0.19	0.19	0.18	0.17	0.17	0.16	0.16	0.15	0.15	0.15	0.14	0.14	0.14	0.14	0.13
0.25	0.32	0.31	0.3	0.29	0.28	0.27	0.26	0.25	0.25	0.24	0.24	0.23	0.23	0.22	0.22	0.21	0.21
0.5	0.64	0.62	0.6	0.58	0.56	0.54	0.52	0.5	0.49	0.48	0.47	0.46	0.45	0.44	0.43	0.42	0.41
0.75	0.96	0.93	0.9	0.87	0.84	0.81	0.78	0.75	0.74	0.73	0.71	0.69	0.68	0.66	0.65	0.64	0.62
1	1.3	1.2	1.2	1.2	1.1	1.1	1	1	0.99	0.97	0.95	0.93	0.9	0.89	0.87	0.85	0.83
1.5	1.9	1.9	1.8	1.7	1.7	1.6	1.6	1.5	1.5	1.5	1.4	1.4	1.4	1.3	1.3	1.3	1.2
1.6	2	2	1.9	1.9	1.8	1.7	1.7	1.6	1.6	1.5	1.5	1.5	1.4	1.4	1.4	1.4	1.3
2	2.6	2.5	2.4	2.3	2.2	2.2	2.1	2	2	1.9	1.9	1.9	1.8	1.8	1.7	1.7	1.7
2.5	3.2	3.1	3	2.9	2.8	2.7	2.6	2.5	2.5	2.4	2.4	2.3	2.3	2.2	2.2	2.1	2.1
3	3.8	3.7	3.6	3.5	3.4	3.3	3.1	3	3	2.9	2.8	2.8	2.7	2.7	2.6	2.5	2.5
3.5	4.5	4.4	4.2	4.1	3.9	3.8	3.7	3.5	3.4	3.4	3.3	3.2	3.2	3.1	3	3	2.9
4	5.1	5	4.8	4.7	4.5	4.3	4.2	4	3.9	3.9	3.8	3.7	3.6	3.5	3.5	3.4	3.3
5	6.4	6.2	6	5.8	5.6	5.4	5.2	5	4.9	4.8	4.7	4.6	4.5	4.4	4.3	4.2	4.1
6	7.7	7.5	7.2	7	6.7	6.5	6.3	6	5.9	5.8	5.7	5.6	5.4	5.3	5.2	5.1	5
8	10.2	9.9	9.6	9.3	9	8.7	8.4	8	7.9	7.7	7.6	7.4	7.2	7.1	6.9	6.8	6.6
10	13	12	12	12	11	11	10	10	9.9	9.7	9.5	9.3	9	8.9	8.7	8.5	8.3
12	15	15	14	14	13	13	13	12	12	12	11	11	11	11	10	10	10
13	17	16	16	15	15	14	14	13	13	13	12	12	12	12	11	11	11
15	19	19	18	17	17	16	16	15	15	15	14	14	14	13	13	13	12
16	20	20	19	19	18	17	17	16	16	15	15	15	14	14	14	14	13
20	26	25	24	23	22	22	21	20	20	19	19	19	18	18	17	17	17
25	32	31	30	29	28	27	26	25	25	24	24	23	23	22	22	21	21
32	41	40	38	37	36	35	33	32	32	31	30	30	29	28	28	27	26
40	51	50	48	47	45	43	42	40	39	39	38	37	36	35	35	34	33
50	64	62	60	58	56	54	52	50	49	48	47	46	45	44	43	42	41
63	81	78	76	73	71	68	66	63	62	61	60	58	57	56	55	53	52

Maximum Let-Through Energy FAZ

Type B (IEC/EN60947-2)

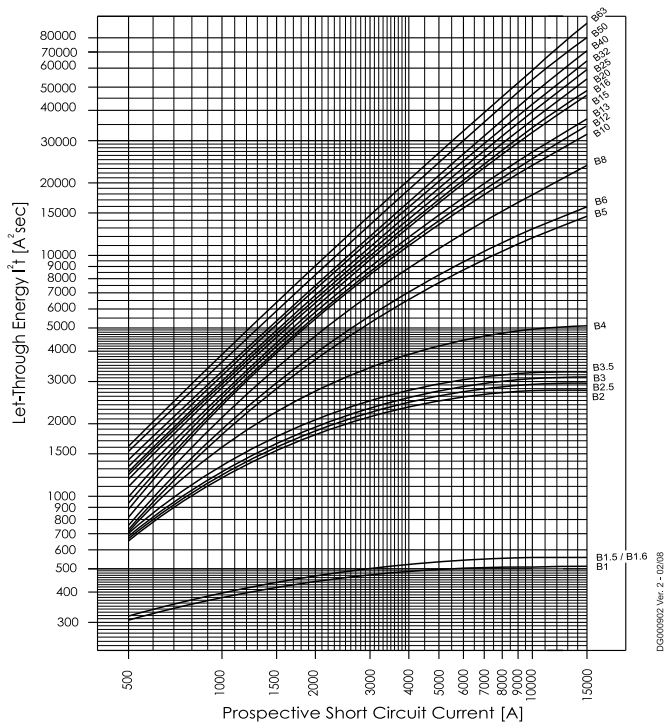

Type C (IEC/EN60947-2)

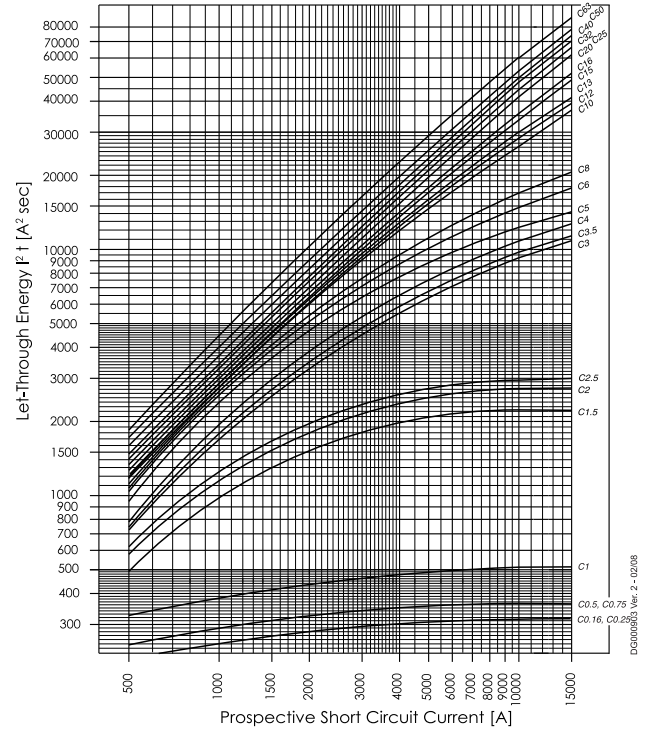

Type D (IEC/EN60947-2)

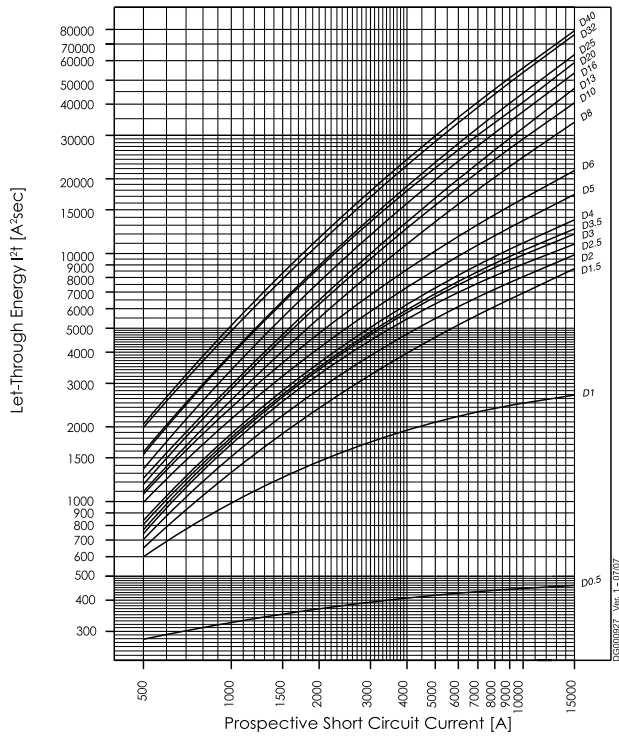

Type K

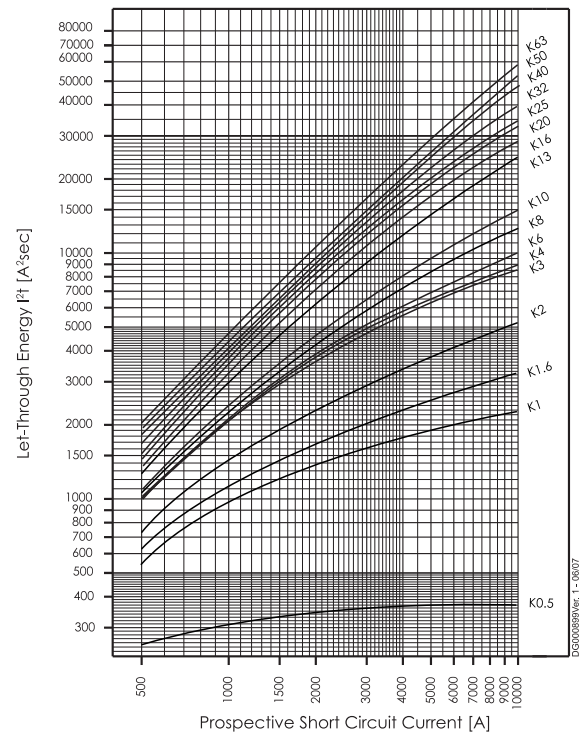

Maximum Let-Through Energy FAZ

Type S

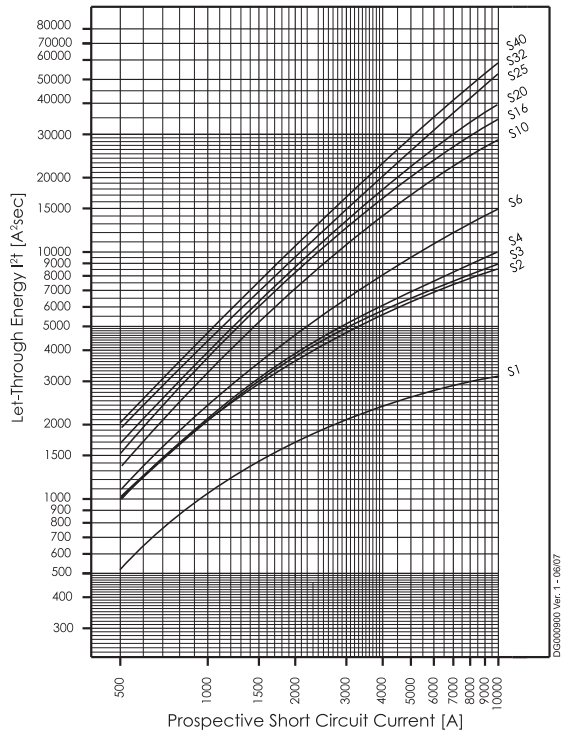

Type Z

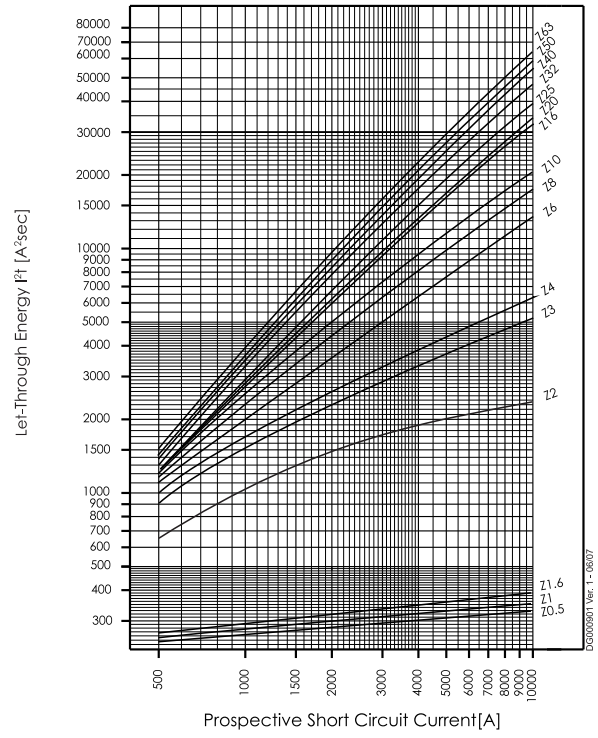

Type FAZ...-HS

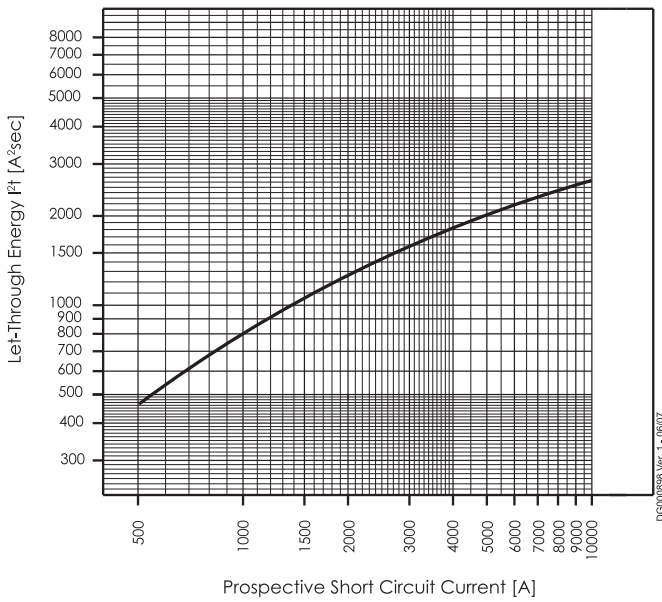

Maximum Let-Through Current FAZ

Type B (IEC/EN60898)

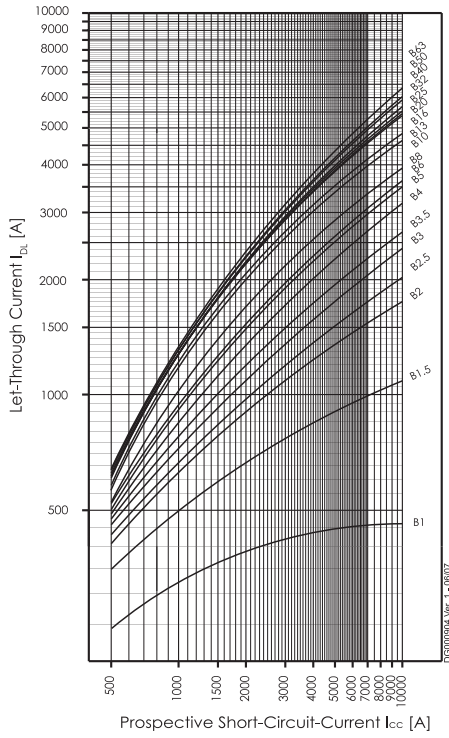

Type C (IEC/EN60898)

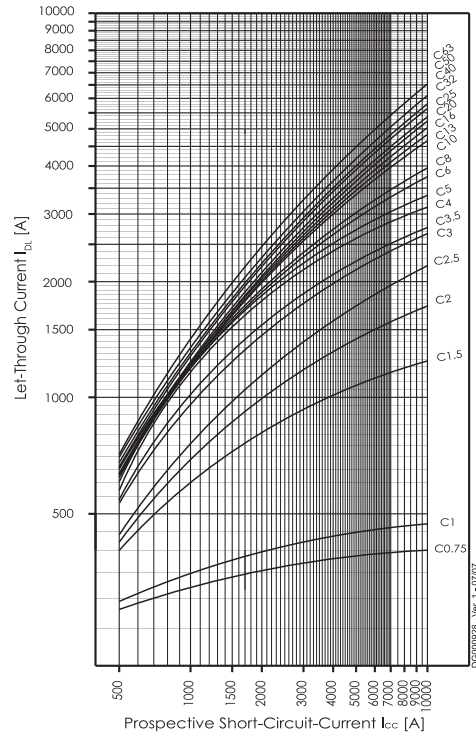

Type D (IEC/EN60898)

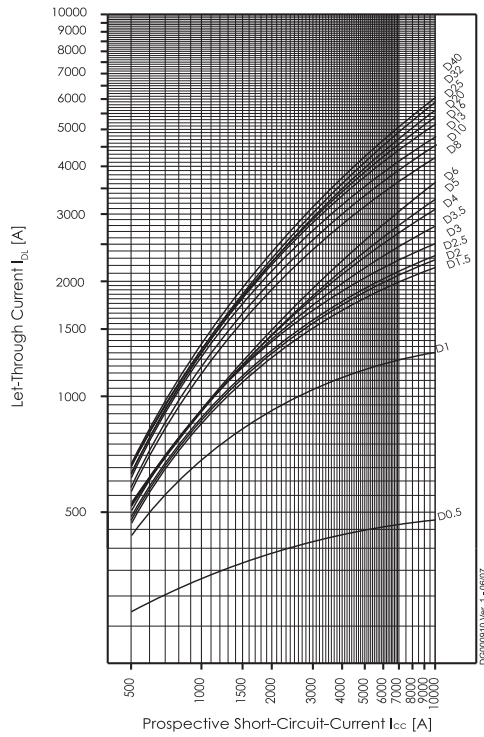

Type K

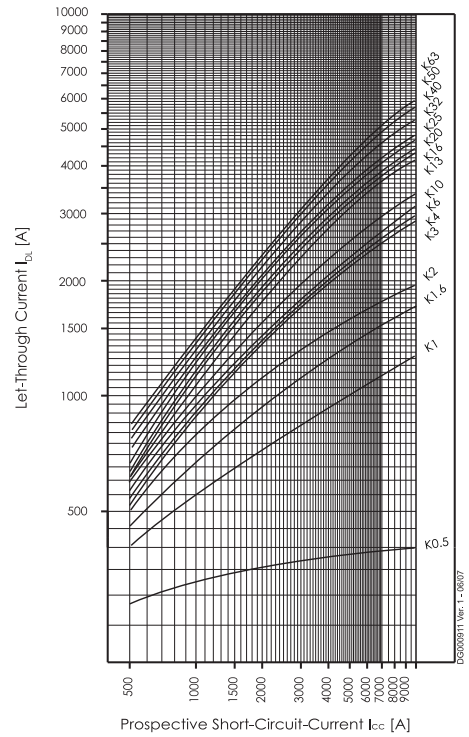

Maximum Let-Through Current FAZ

Type S

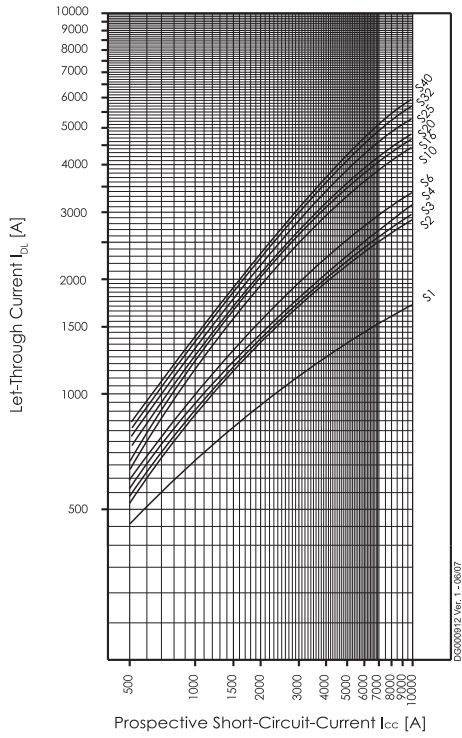

Type B (IEC/EN60947-2)

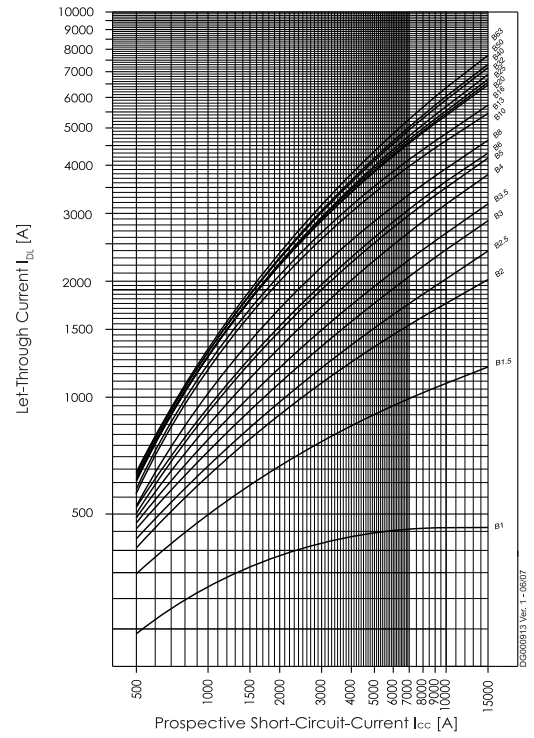

Type C (IEC/EN60947-2)

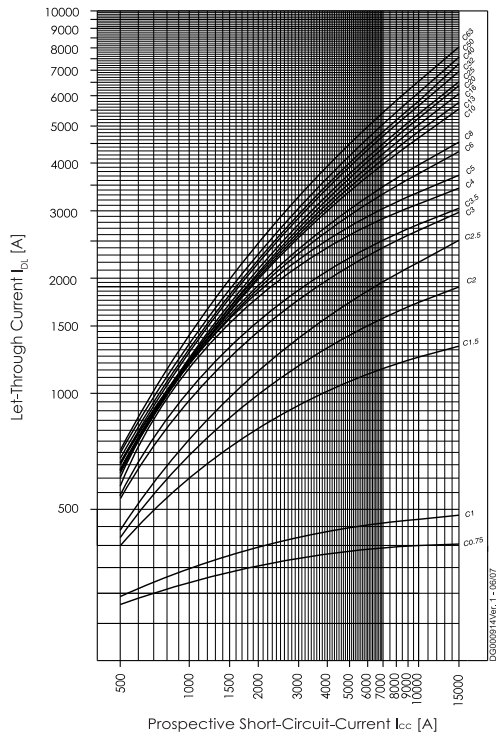

Type D (IEC/EN60947-2)

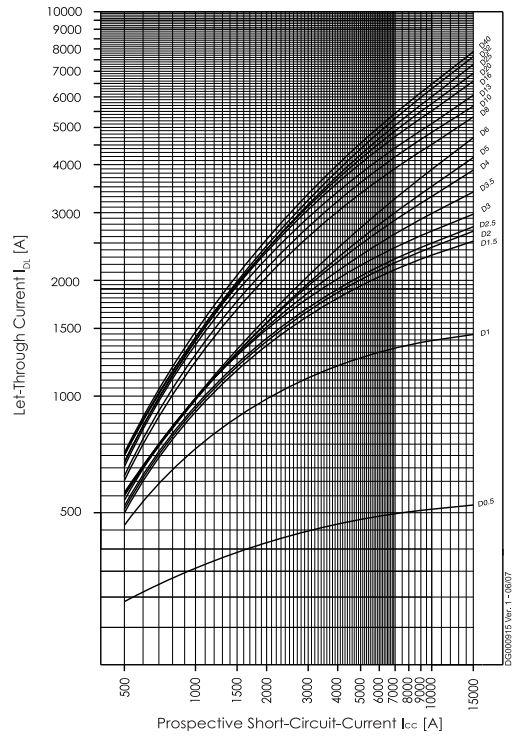

Short Circuit Selectivity FAZ

In case of short circuit, there is selectivity between the miniature circuit breakers FAZ and the upstream protection devices up to the specified values of the selectivity limit current I_s [kA] (i. e. in case of short-circuit currents I_{ks} under I_s , only the MCB will trip, in case of short circuit currents above this value both protective devices will respond).

*) basically in accordance with EN 60898-1 D.5.2.b

FAZ towards NH-00 Fuses

Short circuit selectivity **characteristic B** towards fuse link **NH-00***)

FAZ	NH-00 gL/gG											
I_n [A]	16	20	25	32	35	40	50	63	80	100	125	160
1.0	0.9	10.0 ²⁾	10.0 ²⁾	10.0 ²⁾	10.0 ²⁾	10.0 ²⁾	10.0 ²⁾	10.0 ²⁾	10.0 ²⁾	10.0 ²⁾	10.0 ²⁾	10.0 ²⁾
1.5	0.8	10.0 ²⁾	10.0 ²⁾	10.0 ²⁾	10.0 ²⁾	10.0 ²⁾	10.0 ²⁾	10.0 ²⁾	10.0 ²⁾	10.0 ²⁾	10.0 ²⁾	10.0 ²⁾
2.0	<0.5 ¹⁾	0.5	1.0	2.5	10.0 ²⁾	10.0 ²⁾	10.0 ²⁾	10.0 ²⁾	10.0 ²⁾	10.0 ²⁾	10.0 ²⁾	10.0 ²⁾
2.5	<0.5 ¹⁾	0.5	1.0	2.3	10.0 ²⁾	10.0 ²⁾	10.0 ²⁾	10.0 ²⁾	10.0 ²⁾	10.0 ²⁾	10.0 ²⁾	10.0 ²⁾
3.0	<0.5 ¹⁾	0.5	0.9	2.1	8.0	10.0 ²⁾	10.0 ²⁾	10.0 ²⁾	10.0 ²⁾	10.0 ²⁾	10.0 ²⁾	10.0 ²⁾
3.5	<0.5 ¹⁾	0.5	0.9	1.8	5.5	10.0 ²⁾	10.0 ²⁾	10.0 ²⁾	10.0 ²⁾	10.0 ²⁾	10.0 ²⁾	10.0 ²⁾
4	<0.5 ¹⁾	<0.5 ¹⁾	0.8	1.3	2.3	4.3	10.0 ²⁾	10.0 ²⁾	10.0 ²⁾	10.0 ²⁾	10.0 ²⁾	10.0 ²⁾
5	<0.5 ¹⁾	<0.5 ¹⁾	0.7	1.1	1.6	2.2	3.6	4.8	8.9	10.0 ²⁾	10.0 ²⁾	10.0 ²⁾
6	<0.5 ¹⁾	<0.5 ¹⁾	0.7	1.1	1.5	2.0	3.3	4.3	7.6	10.0 ²⁾	10.0 ²⁾	10.0 ²⁾
8	<0.5 ¹⁾	<0.5 ¹⁾	0.6	1.0	1.3	1.7	2.6	3.3	5.2	10.0 ²⁾	10.0 ²⁾	10.0 ²⁾
10		<0.5 ¹⁾	0.6	0.9	1.2	1.5	2.2	2.7	4.0	9.0	10.0 ²⁾	10.0 ²⁾
13		<0.5 ¹⁾	0.6	0.8	1.1	1.4	2.1	2.6	3.8	7.9	10.0 ²⁾	10.0 ²⁾
16			0.5	0.7	1.0	1.3	1.9	2.4	3.4	6.4	9.3	10.0 ²⁾
20				0.7	1.0	1.3	1.9	2.4	3.3	6.0	8.7	10.0 ²⁾
25				0.7	1.0	1.3	1.8	2.3	3.2	5.7	8.0	10.0 ²⁾
32					0.9	1.2	1.7	2.2	3.1	5.4	7.6	10.0 ²⁾
40								2.1	3.0	5.1	7.2	10.0 ²⁾
50								1.9	2.8	4.7	6.6	9.5
63										4.4	6.3	8.6

Short circuit selectivity **characteristic C** towards fuse link **NH-00***)

FAZ	NH-00 gL/gG											
I_n [A]	16	20	25	32	35	40	50	63	80	100	125	160
0.75	10.0 ²⁾	10.0 ²⁾	10.0 ²⁾	10.0 ²⁾	10.0 ²⁾	10.0 ²⁾	10.0 ²⁾	10.0 ²⁾	10.0 ²⁾	10.0 ²⁾	10.0 ²⁾	10.0 ²⁾
1.0	0.9	10.0 ²⁾	10.0 ²⁾	10.0 ²⁾	10.0 ²⁾	10.0 ²⁾	10.0 ²⁾	10.0 ²⁾	10.0 ²⁾	10.0 ²⁾	10.0 ²⁾	10.0 ²⁾
1.5	<0.5 ¹⁾	0.6	1.3	4.2	10.0 ²⁾	10.0 ²⁾	10.0 ²⁾	10.0 ²⁾	10.0 ²⁾	10.0 ²⁾	10.0 ²⁾	10.0 ²⁾
2.0	<0.5 ¹⁾	0.6	1.0	2.5	10.0 ²⁾	10.0 ²⁾	10.0 ²⁾	10.0 ²⁾	10.0 ²⁾	10.0 ²⁾	10.0 ²⁾	10.0 ²⁾
2.5	<0.5 ¹⁾	0.5	1.0	2.1	10.0 ²⁾	10.0 ²⁾	10.0 ²⁾	10.0 ²⁾	10.0 ²⁾	10.0 ²⁾	10.0 ²⁾	10.0 ²⁾
3.0	<0.5 ¹⁾	<0.5 ¹⁾	0.7	1.2	1.8	2.6	4.7	6.6	10.0 ²⁾	10.0 ²⁾	10.0 ²⁾	10.0 ²⁾
3.5	<0.5 ¹⁾	<0.5 ¹⁾	0.7	1.1	1.7	2.4	4.2	6.0	10.0 ²⁾	10.0 ²⁾	10.0 ²⁾	10.0 ²⁾
4	<0.5 ¹⁾	<0.5 ¹⁾	0.7	1.0	1.5	2.1	3.6	5.0	10.0	10.0 ²⁾	10.0 ²⁾	10.0 ²⁾
5	<0.5 ¹⁾	<0.5 ¹⁾	0.6	0.8	1.2	1.7	2.8	3.8	8.7	10.0 ²⁾	10.0 ²⁾	10.0 ²⁾
6	<0.5 ¹⁾	<0.5 ¹⁾	0.5	0.8	1.2	1.5	2.5	3.3	5.7	10.0 ²⁾	10.0 ²⁾	10.0 ²⁾
8	<0.5 ¹⁾	<0.5 ¹⁾	0.5	0.8	1.1	1.5	2.3	2.9	4.9	10.0 ²⁾	10.0 ²⁾	10.0 ²⁾
10			0.5	0.7	1.0	1.4	2.0	2.5	3.8	8.0	10.0 ²⁾	10.0 ²⁾
13					1.0	1.3	1.9	2.4	3.6	7.0	10.0 ²⁾	10.0 ²⁾
16					1.0	1.3	1.8	2.3	3.3	6.0	8.8	10.0 ²⁾
20					1.0	1.2	1.7	2.2	3.2	5.5	7.7	10.0 ²⁾
25							1.6	2.1	3.0	5.2	7.3	10.0 ²⁾
32								2.1	2.9	5.0	7.0	10.0 ²⁾
40									2.8	4.8	6.7	10.0
50										4.5	6.3	9.5
63											5.9	8.4

Short circuit selectivity **characteristic D** towards fuse link **NH-00***)

FAZ	NH-00 gL/gG											
I_n [A]	16	20	25	32	35	40	50	63	80	100	125	160
0.5	2.1	10.0 ²⁾	10.0 ²⁾	10.0 ²⁾	10.0 ²⁾	10.0 ²⁾	10.0 ²⁾	10.0 ²⁾	10.0 ²⁾	10.0 ²⁾	10.0 ²⁾	10.0 ²⁾
1.0	<0.5 ¹⁾	0.6	1.4	4.3	10.0 ²⁾	10.0 ²⁾	10.0 ²⁾	10.0 ²⁾	10.0 ²⁾	10.0 ²⁾	10.0 ²⁾	10.0 ²⁾
1.5	<0.5 ¹⁾	<0.5 ¹⁾	0.9	1.6	2.7	4.0	8.0	10.0 ²⁾	10.0 ²⁾	10.0 ²⁾	10.0 ²⁾	10.0 ²⁾
2.0	<0.5 ¹⁾	<0.5 ¹⁾	0.8	1.3	2.1	3.1	6.0	8.6	10.0 ²⁾	10.0 ²⁾	10.0 ²⁾	10.0 ²⁾
2.5	<0.5 ¹⁾	<0.5 ¹⁾	0.7	1.2	1.8	2.6	4.8	6.9	10.0 ²⁾	10.0 ²⁾	10.0 ²⁾	10.0 ²⁾
3.0	<0.5 ¹⁾	<0.5 ¹⁾	0.7	1.1	1.7	2.4	4.3	6.0	10.0 ²⁾	10.0 ²⁾	10.0 ²⁾	10.0 ²⁾
3.5	<0.5 ¹⁾	<0.5 ¹⁾	0.7	1.1	1.7	2.4	4.2	5.6	10.0 ²⁾	10.0 ²⁾	10.0 ²⁾	10.0 ²⁾
4	<0.5 ¹⁾	<0.5 ¹⁾	0.7	1.0	1.6	2.2	3.8	5.2	10.0	10.0 ²⁾	10.0 ²⁾	10.0 ²⁾
5		<0.5 ¹⁾	0.6	0.9	1.4	1.9	3.2	4.1	7.1	10.0 ²⁾	10.0 ²⁾	10.0 ²⁾
6		<0.5 ¹⁾	0.5	0.8	1.2	1.6	2.6	3.3	5.5	10.0 ²⁾	10.0 ²⁾	10.0 ²⁾
8			0.5	0.8	1.1	1.5	2.2	2.7	4.1	8.7	10.0 ²⁾	10.0 ²⁾
10			0.5	0.7	1.0	1.3	1.9	2.5	3.6	7.2	10.0 ²⁾	10.0 ²⁾
13				1.0	1.3	1.9	2.3	3.4	6.5	9.5	10.0 ²⁾	
16					1.1	1.6	2.0	3.0	5.5	8.0	10.0 ²⁾	
20						1.4	1.8	2.8	5.0	7.5	10.0 ²⁾	
25							1.8	2.7	4.8	7.0	10.0 ²⁾	
32								2.4	4.1	6.2	9.3	
40									4.0	6.0	9.0	

1) Selectivity limit current I_s under 0.5 kA

2) Selectivity limit current I_s = rated breaking capacity I_{cn} of the MCB

Shaded fields: no selectivity

FAZ towards D01-D03 fuse link

Short circuit selectivity **characteristic B** towards fuse link **D01-D03***)

FAZ	D01-D03 gL/gG									
	I _n [A]	10	16	20	25	35	50	63	80	100
1.0	<0.5 ¹⁾	10.0 ²⁾	10.0 ²⁾	10.0 ²⁾	10.0 ²⁾	10.0 ²⁾	10.0 ²⁾	10.0 ²⁾	10.0 ²⁾	10.0 ²⁾
1.5	<0.5 ¹⁾	4.1	10.0 ²⁾	10.0 ²⁾	10.0 ²⁾	10.0 ²⁾	10.0 ²⁾	10.0 ²⁾	10.0 ²⁾	10.0 ²⁾
2.0	<0.5 ¹⁾	<0.5 ¹⁾	0.6	1.0	10.0 ²⁾	10.0 ²⁾	10.0 ²⁾	10.0 ²⁾	10.0 ²⁾	10.0 ²⁾
2.5	<0.5 ¹⁾	<0.5 ¹⁾	0.6	1.0	10.0 ²⁾	10.0 ²⁾	10.0 ²⁾	10.0 ²⁾	10.0 ²⁾	10.0 ²⁾
3.0	<0.5 ¹⁾	<0.5 ¹⁾	0.5	1.0	10.0 ²⁾	10.0 ²⁾	10.0 ²⁾	10.0 ²⁾	10.0 ²⁾	10.0 ²⁾
3.5	<0.5 ¹⁾	<0.5 ¹⁾	0.5	0.9	7.0	10.0 ²⁾	10.0 ²⁾	10.0 ²⁾	10.0 ²⁾	10.0 ²⁾
4	<0.5 ¹⁾	<0.5 ¹⁾	0.5	0.9	2.5	10.0 ²⁾	10.0 ²⁾	10.0 ²⁾	10.0 ²⁾	10.0 ²⁾
5		<0.5 ¹⁾	0.5	0.8	1.7	4.0	7.0	10.0 ²⁾	10.0 ²⁾	10.0 ²⁾
6		<0.5 ¹⁾	0.5	0.8	1.6	3.6	6.0	10.0 ²⁾	10.0 ²⁾	10.0 ²⁾
8			0.5	0.8	1.4	2.8	4.3	8.2	10.0 ²⁾	10.0 ²⁾
10			0.5	0.7	1.3	2.4	3.4	6.0	10.0 ²⁾	10.0 ²⁾
13			<0.5 ¹⁾	0.7	1.2	2.3	3.2	5.3	10.0 ²⁾	10.0 ²⁾
16				0.6	1.1	2.2	2.9	4.6	10.0	10.0
20					1.1	2.1	2.8	4.4	9.3	9.3
25					1.1	2.0	2.7	4.2	8.7	8.7
32						2.0	2.6	4.0	8.0	8.0
40							2.5	3.8	7.5	7.5
50							2.3	3.4	6.7	6.7
63									6.2	6.2

Short circuit selectivity **characteristic C** towards fuse link **D01-D03***)

FAZ	D01-D03 gL/gG									
	I _n [A]	10	16	20	25	35	50	63	80	100
0.75	<0.5 ¹⁾	10.0 ²⁾	10.0 ²⁾	10.0 ²⁾	10.0 ²⁾	10.0 ²⁾	10.0 ²⁾	10.0 ²⁾	10.0 ²⁾	10.0 ²⁾
1.0	<0.5 ¹⁾	10.0 ²⁾	10.0 ²⁾	10.0 ²⁾	10.0 ²⁾	10.0 ²⁾	10.0 ²⁾	10.0 ²⁾	10.0 ²⁾	10.0 ²⁾
1.5	<0.5 ¹⁾	0.5	0.6	0.9	10.0 ²⁾	10.0 ²⁾	10.0 ²⁾	10.0 ²⁾	10.0 ²⁾	10.0 ²⁾
2.0	<0.5 ¹⁾	<0.5 ¹⁾	0.5	0.7	10.0 ²⁾	10.0 ²⁾	10.0 ²⁾	10.0 ²⁾	10.0 ²⁾	10.0 ²⁾
2.5	<0.5 ¹⁾	<0.5 ¹⁾	0.5	0.7	10.0 ²⁾	10.0 ²⁾	10.0 ²⁾	10.0 ²⁾	10.0 ²⁾	10.0 ²⁾
3.0	<0.5 ¹⁾	<0.5 ¹⁾	<0.5 ¹⁾	0.6	1.9	5.2	10.0 ²⁾	10.0 ²⁾	10.0 ²⁾	10.0 ²⁾
3.5	<0.5 ¹⁾	<0.5 ¹⁾	<0.5 ¹⁾	0.6	1.8	4.7	9.5	10.0 ²⁾	10.0 ²⁾	10.0 ²⁾
4	<0.5 ¹⁾	<0.5 ¹⁾	<0.5 ¹⁾	0.6	1.6	4.0	7.6	10.0 ²⁾	10.0 ²⁾	10.0 ²⁾
5		<0.5 ¹⁾	<0.5 ¹⁾	0.5	1.3	3.1	5.7	10.0 ²⁾	10.0 ²⁾	10.0 ²⁾
6		<0.5 ¹⁾	<0.5 ¹⁾	<0.5 ¹⁾	1.2	2.7	4.5	10.0 ²⁾	10.0 ²⁾	10.0 ²⁾
8		<0.5 ¹⁾	<0.5 ¹⁾	<0.5 ¹⁾	1.2	2.5	4.0	8.6	10.0 ²⁾	10.0 ²⁾
10			<0.5 ¹⁾	<0.5 ¹⁾	1.2	2.3	3.1	5.4	10.0 ²⁾	10.0 ²⁾
13					1.1	2.2	3.0	4.9	10.0 ²⁾	10.0 ²⁾
16					1.1	2.1	2.8	4.4	9.5	9.5
20					1.0	2.0	2.6	4.0	8.3	8.3
25						1.9	2.5	3.8	7.8	7.8
32							2.5	3.7	7.3	7.3
40								3.5	7.0	7.0
50									6.5	6.5
63										6.2

Short circuit selectivity **characteristic D** towards fuse link **D01-D03***)

FAZ	D01-D03 gL/gG									
	I _n [A]	10	16	20	25	35	50	63	80	100
0.5	<0.5 ¹⁾	10.0 ²⁾	10.0 ²⁾	10.0 ²⁾	10.0 ²⁾	10.0 ²⁾	10.0 ²⁾	10.0 ²⁾	10.0 ²⁾	10.0 ²⁾
1.0	<0.5 ¹⁾	<0.5 ¹⁾	0.7	1.3	10.0 ²⁾	10.0 ²⁾	10.0 ²⁾	10.0 ²⁾	10.0 ²⁾	10.0 ²⁾
1.5	<0.5 ¹⁾	<0.5 ¹⁾	0.6	0.9	2.8	9.0	10.0 ²⁾	10.0 ²⁾	10.0 ²⁾	10.0 ²⁾
2.0	<0.5 ¹⁾	<0.5 ¹⁾	0.6	0.8	2.2	6.7	10.0 ²⁾	10.0 ²⁾	10.0 ²⁾	10.0 ²⁾
2.5	<0.5 ¹⁾	<0.5 ¹⁾	0.5	0.7	1.9	5.4	10.0 ²⁾	10.0 ²⁾	10.0 ²⁾	10.0 ²⁾
3.0	<0.5 ¹⁾	<0.5 ¹⁾	0.5	0.7	1.8	4.8	9.3	10.0 ²⁾	10.0 ²⁾	10.0 ²⁾
3.5	<0.5 ¹⁾	<0.5 ¹⁾	0.5	0.7	1.7	4.7	8.6	10.0 ²⁾	10.0 ²⁾	10.0 ²⁾
4		<0.5 ¹⁾	0.5	0.7	1.7	4.6	7.7	10.0 ²⁾	10.0 ²⁾	10.0 ²⁾
5		<0.5 ¹⁾	<0.5 ¹⁾	0.6	1.5	3.5	5.8	10.0 ²⁾	10.0 ²⁾	10.0 ²⁾
6			<0.5 ¹⁾	0.5	1.3	2.9	4.5	9.0	10.0 ²⁾	10.0 ²⁾
8			<0.5 ¹⁾	0.5	1.2	2.4	3.5	6.0	10.0 ²⁾	10.0 ²⁾
10				0.5	1.1	2.2	3.0	5.0	10.0 ²⁾	10.0 ²⁾
13					1.1	2.1	2.9	4.6	10.0 ²⁾	10.0 ²⁾
16						1.9	2.6	3.9	9.0	9.0
20						1.7	2.3	3.5	8.0	8.0
25							2.2	3.4	7.5	7.5
32								2.9	6.0	6.0
40									5.7	5.7

¹⁾ Selectivity limit current I_s under 0.5 kA

²⁾ Selectivity limit current I_s = rated breaking capacity I_{cn} of the MCB

Shaded fields: no selectivity

FAZ towards DII-DIV fuse link

Short circuit selectivity **characteristic B** towards fuse link **DII-DIV***)

FAZ	DII-DIV gL/gG								
I _n [A]	10	16	20	25	35	50	63	80	100
1.0	<0.5 ¹⁾	1.2	10.0 ²⁾	10.0 ²⁾	10.0 ²⁾	10.0 ²⁾	10.0 ²⁾	10.0 ²⁾	10.0 ²⁾
1.5	<0.5 ¹⁾	1.0	10.0 ²⁾	10.0 ²⁾	10.0 ²⁾	10.0 ²⁾	10.0 ²⁾	10.0 ²⁾	10.0 ²⁾
2.0	<0.5 ¹⁾	<0.5 ¹⁾	0.8	1.6	10.0 ²⁾	10.0 ²⁾	10.0 ²⁾	10.0 ²⁾	10.0 ²⁾
2.5	<0.5 ¹⁾	<0.5 ¹⁾	0.8	1.5	10.0 ²⁾	10.0 ²⁾	10.0 ²⁾	10.0 ²⁾	10.0 ²⁾
3.0	<0.5 ¹⁾	<0.5 ¹⁾	0.8	1.4	10.0 ²⁾	10.0 ²⁾	10.0 ²⁾	10.0 ²⁾	10.0 ²⁾
3.5	<0.5 ¹⁾	<0.5 ¹⁾	0.7	1.3	10.0 ²⁾	10.0 ²⁾	10.0 ²⁾	10.0 ²⁾	10.0 ²⁾
4	<0.5 ¹⁾	<0.5 ¹⁾	0.6	1.0	3.6	10.0 ²⁾	10.0 ²⁾	10.0 ²⁾	10.0 ²⁾
5	<0.5 ¹⁾	<0.5 ¹⁾	0.6	0.9	2.0	3.5	8.5	10.0 ²⁾	10.0 ²⁾
6		<0.5 ¹⁾	0.6	0.9	1.8	3.2	7.4	10.0 ²⁾	10.0 ²⁾
8		<0.5 ¹⁾	0.5	0.8	1.6	2.6	5.2	8.3	10.0 ²⁾
10			0.5	0.8	1.4	2.2	3.9	6.0	10.0 ²⁾
13			0.5	0.7	1.3	2.0	3.6	5.4	10.0 ²⁾
16				0.6	1.2	1.9	3.2	4.6	8.4
20					1.2	1.8	3.1	4.4	7.8
25					1.2	1.8	3.0	4.2	7.3
32						1.7	2.8	3.9	6.8
40							2.7	3.8	6.5
50							2.5	3.5	5.7
63									5.3

Short circuit selectivity **characteristic C** towards fuse link **DII-DIV***)

FAZ	DII-DIV gL/gG								
I _n [A]	10	16	20	25	35	50	63	80	100
0.75	1.0	10.0 ²⁾	10.0 ²⁾	10.0 ²⁾	10.0 ²⁾	10.0 ²⁾	10.0 ²⁾	10.0 ²⁾	10.0 ²⁾
1.0	<0.5 ¹⁾	1.2	10.0 ²⁾	10.0 ²⁾	10.0 ²⁾	10.0 ²⁾	10.0 ²⁾	10.0 ²⁾	10.0 ²⁾
1.5	<0.5 ¹⁾	<0.5 ¹⁾	1.0	2.2	10.0 ²⁾	10.0 ²⁾	10.0 ²⁾	10.0 ²⁾	10.0 ²⁾
2.0	<0.5 ¹⁾	<0.5 ¹⁾	0.8	1.6	10.0 ²⁾	10.0 ²⁾	10.0 ²⁾	10.0 ²⁾	10.0 ²⁾
2.5	<0.5 ¹⁾	<0.5 ¹⁾	0.8	1.4	10.0 ²⁾	10.0 ²⁾	10.0 ²⁾	10.0 ²⁾	10.0 ²⁾
3.0	<0.5 ¹⁾	<0.5 ¹⁾	0.8	0.9	10.0 ²⁾	10.0 ²⁾	10.0 ²⁾	10.0 ²⁾	10.0 ²⁾
3.5	<0.5 ¹⁾	<0.5 ¹⁾	0.6	0.9	2.2	4.5	10.0 ²⁾	10.0 ²⁾	10.0 ²⁾
4	<0.5 ¹⁾	<0.5 ¹⁾	0.6	0.8	1.8	3.6	9.7	10.0 ²⁾	10.0 ²⁾
5	<0.5 ¹⁾	<0.5 ¹⁾	0.6	0.7	1.5	2.7	7.3	10.0 ²⁾	10.0 ²⁾
6		<0.5 ¹⁾	0.5	0.6	1.4	2.4	5.5	10.0 ²⁾	10.0 ²⁾
8		<0.5 ¹⁾	<0.5 ¹⁾	0.6	1.3	2.2	4.7	8.7	10.0 ²⁾
10			<0.5 ¹⁾	0.6	1.3	2.0	3.6	5.4	10.0 ²⁾
13					1.3	1.9	3.3	5.0	9.4
16					1.2	1.8	3.2	4.4	8.0
20					1.2	1.8	3.1	4.1	7.0
25						1.7	2.8	3.8	6.5
32							2.7	3.7	6.2
40								3.5	5.9
50									5.5
63									

Short circuit selectivity **characteristic D** towards fuse link **DII-DIV***)

FAZ	DII-DIV gL/gG								
I _n [A]	10	16	20	25	35	50	63	80	100
0.5	0.5	3.0	10.0 ²⁾	10.0 ²⁾	10.0 ²⁾	10.0 ²⁾	10.0 ²⁾	10.0 ²⁾	10.0 ²⁾
1.0	<0.5 ¹⁾	<0.5 ¹⁾	1.0	2.4	10.0 ²⁾	10.0 ²⁾	10.0 ²⁾	10.0 ²⁾	10.0 ²⁾
1.5	<0.5 ¹⁾	<0.5 ¹⁾	0.7	1.2	3.5	7.7	10.0 ²⁾	10.0 ²⁾	10.0 ²⁾
2.0	<0.5 ¹⁾	<0.5 ¹⁾	0.6	1.0	2.8	5.8	10.0 ²⁾	10.0 ²⁾	10.0 ²⁾
2.5	<0.5 ¹⁾	<0.5 ¹⁾	0.6	1.4	2.3	4.6	10.0 ²⁾	10.0 ²⁾	10.0 ²⁾
3.0	<0.5 ¹⁾	<0.5 ¹⁾	0.6	0.9	2.3	4.3	10.0 ²⁾	10.0 ²⁾	10.0 ²⁾
3.5	<0.5 ¹⁾	<0.5 ¹⁾	0.6	0.9	2.1	4.0	10.0 ²⁾	10.0 ²⁾	10.0 ²⁾
4		<0.5 ¹⁾	0.6	0.9	2.0	3.8	9.5	10.0 ²⁾	10.0 ²⁾
5		<0.5 ¹⁾	0.5	0.7	1.7	3.1	7.0	10.0 ²⁾	10.0 ²⁾
6			0.5	0.7	1.5	2.6	5.3	9.1	10.0 ²⁾
8			<0.5 ¹⁾	0.7	1.4	2.2	3.9	6.0	10.0 ²⁾
10				0.7	1.2	1.9	3.4	5.0	9.5
13					1.2	1.8	3.2	4.6	8.6
16						1.6	2.7	4.0	7.4
20						1.5	2.5	3.5	6.7
25							2.4	3.4	6.2
32								2.8	5.0
40									4.8

¹⁾ Selectivity limit current I_s under 0.5 kA

²⁾ Selectivity limit current I_s = rated breaking capacity I_{cn} of the MCB

Shaded fields: no selectivity

FAZ-B and NZM 1/2

Selectivity-limit current I_g [kA] for selectivity between FAZ-B and NZM (overload and short-circuit release unit NZM at max. value).

I_n [A]	NZM...1-A...						NZM...2-A...								
	$I_{cu} = 25 (50) \text{ kA}$						$I_{cu} = 25 (50)(100)(150) \text{ kA}$								
FAZ-B	40	50	63	80	100	125	40	50	63	80	100	125	160	200	250
1	15	15	15	15	15	15	15	15	15	15	15	15	15	15	15
2	2	15	15	15	15	15	3	15	15	15	15	15	15	15	15
3	1.2	2	3	3	10	15	1.5	1.5	3	5	15	15	15	15	15
4	1.2	2	3	3	8	15	1.2	1.5	3	4	15	15	15	15	15
6	1.2	2	2.5	3	5	10	1.2	1.5	2.5	3	15	15	15	15	15
10	1.2	1.5	2	2	4	10	1	1.5	2.5	3	10	10	10	10	10
13	1	1.5	2	2	4	10	1	1.2	2	3	10	10	10	10	10
16	1	1.2	1.5	2	3	8	1	1.2	1.5	2.5	10	10	10	10	10
20	0.8	1.2	1.5	1.5	3	8	1	1.2	1.5	1.5	10	10	10	10	10
25	0.7	1.2	1.5	1.5	3	7	0.8	1	1.5	2	10	10	10	10	10
32	-	1.2	1	1.5	2	6	-	1	1.5	2	8	8	8	8	10
40	-	-	1	1.5	2	5	-	-	1.2	1.5	7	7	7	7	10
50	-	-	-	1.2	1.5	4	-	-	-	1.5	6	6	6	6	10
63	-	-	-	-	1.5	3	-	-	-	-	6	6	6	6	10

FAZ-C and NZM 1/2

Selectivity-limit current I_g [kA] for selectivity between FAZ-C and NZM (overload and short-circuit release unit NZM at max. value).

I_n [A]	NZM...1-A...						NZM...2-A...								
	$I_{cu} = 25 (50) \text{ kA}$						$I_{cu} = 25 (50)(100)(150) \text{ kA}$								
FAZ-C	40	50	63	80	100	125	40	50	63	80	100	125	160	200	250
0.5	15	15	15	15	15	15	15	15	15	15	15	15	15	15	15
1	15	15	15	15	15	15	15	15	15	15	15	15	15	15	15
2	2	15	15	15	15	15	3	15	15	15	15	15	15	15	15
3	1.2	2	3	3	10	15	1.5	1.5	3	5	15	15	15	15	15
4	1.2	2	3	3	8	15	1.2	1.5	3	4	15	15	15	15	15
6	1.2	2	2.5	3	5	10	1.2	1.5	2.5	3	15	15	15	15	15
10	1.2	1.5	2	2	4	10	1	1.5	2.5	3	10	10	10	10	10
13	1	1.5	2	2	4	10	1	1.2	2	3	10	10	10	10	10
16	1	1.2	1.5	2	3	8	1	1.2	1.5	2.5	10	10	10	10	10
20	0.8	1.2	1.5	1.5	3	8	1	1.2	1.5	1.5	10	10	10	10	10
25	0.7	1.2	1.5	1.5	3	7	0.8	1	1.5	2	10	10	10	10	10
32	-	1.2	1	1.5	2	6	-	1	1.5	2	8	8	8	8	10
40	-	-	1	1.5	2	5	-	-	1.2	1.5	7	7	7	7	10
50	-	-	-	1.2	1.5	4	-	-	-	1.5	6	6	6	6	10
63	-	-	-	-	1.5	3	-	-	-	-	6	6	6	6	10

FAZ-D and NZM 1/2

Selectivity-limit current I_s [kA] for selectivity between FAZ-D and NZM (overload and short-circuit release unit NZM at max. value).

I_n [A]	NZM...1-A...						NZM...2-A...								
	$I_{cu} = 25 (50) \text{ kA}$						$I_{cu} = 25 (50)(100)(150) \text{ kA}$								
FAZ-D	40	50	63	80	100	125	40	50	63	80	100	125	160	200	250
0.5	9	15	15	15	15	15	9	15	15	15	15	15	15	15	15
1	0.5	0.7	1.1	1.9	4.2	15	0.5	0.7	1.1	1.9	4.2	15	15	15	15
1.5	0.3	0.6	0.8	1.1	1.6	2.6	0.3	0.6	0.8	1.1	1.6	2.6	5	15	15
2	0.3	0.5	0.75	0.95	1.4	2.4	0.3	0.5	0.75	0.95	1.4	2.4	4.5	10	15
2.5	0.3	0.5	0.75	0.95	1.3	2.3	0.3	0.5	0.75	0.95	1.3	2.3	4.2	9	15
3	0.3	0.5	0.7	0.9	1.3	2.1	0.3	0.5	0.7	0.9	1.3	2.1	3.6	7	15
3.5	0.3	0.5	0.7	0.9	1.3	2	0.3	0.5	0.7	0.9	1.3	2	3.3	5.6	10
4	0.3	0.5	0.7	0.9	1.3	1.9	0.3	0.5	0.7	0.9	1.3	1.9	3	4.7	8
5	0.3	0.5	0.7	0.9	1.3	1.9	0.3	0.5	0.7	0.9	1.3	1.9	3	4.4	7
6	0.3	0.5	0.6	0.9	1.3	1.8	0.3	0.5	0.6	0.9	1.3	1.8	2.8	4	6
8	0.3	0.3	0.6	0.75	1	1.3	0.3	0.3	0.6	0.75	1	1.3	1.8	2.7	4
10	0.3	0.3	0.6	0.75	0.95	1.2	0.3	0.3	0.6	0.75	0.95	1.2	1.7	2.4	3.6
13	0.3	0.3	0.5	0.7	0.9	1.1	0.3	0.3	0.5	0.7	0.9	1.1	1.6	2.2	3.2
16	-	0.3	0.5	0.65	0.8	1.1	-	0.3	0.5	0.65	0.8	1.1	1.5	2.1	3
20	-	-	0.5	0.65	0.8	1.1	-	-	0.5	0.65	0.8	1.1	1.4	2.1	3
25	-	-	0.5	0.65	0.8	1.1	-	-	0.5	0.65	0.8	1.1	1.4	1.9	2.7
32	-	-	-	-	0.8	1.1	-	-	-	-	0.8	1.1	1.4	1.9	2.7
40	-	-	-	-	-	1	-	-	-	-	-	1	1.4	1.8	2.6

Back-up Protection FAZ

The up-stream protective devices will protect the down-stream FAZ up to the short-circuit current specified.

FAZ/C and AZ/C

I_n [A]	AZ/C								
	I_n [A]								
FAZ/C	20	25	32	40	50	63	80	100	125
1	25	25	25	25	25	25	20	20	15 kA
2	25	25	25	25	25	25	20	20	15 kA
4	25	25	25	25	25	25	20	20	15 kA
6	25	25	25	25	25	25	20	20	15 kA
10	25	25	25	25	25	25	20	20	15 kA
13	25	25	25	25	25	25	20	20	15 kA
16	25	25	25	25	25	25	20	20	15 kA
20	1)	25	25	25	25	25	20	20	15 kA
25	1)	1)	25	25	25	25	20	20	15 kA
32	1)	1)	1)	25	25	25	20	20	-
40	1)	1)	1)	1)	25	25	20	20	-
50	1)	1)	1)	1)	1)	25	20	20	-
63	1)	1)	1)	1)	1)	1)	-	-	-

1) I_n (AZ) \leq I_n (FAZ)

FAZ and CL-PKZ0

Back-up tests acc. to EN/IEC 60947-2, App. A: $U = 1.05 U_e$, (O - t - CO)

I_n [A]	FAZ- I_n /1(2,3,4)/B(C) + CL-PKZ0 $U_e = 230/400$ V
0.16	65 kA
0.25	65 kA
0.5	65 kA
0.75	65 kA
1	65 kA
1.5	65 kA
2	65 kA
2.5	65 kA
3	65 kA
3.5	65 kA
4	65 kA
5	45 kA
6	45 kA
8	45 kA
10	45 kA
12	45 kA
13	45 kA
15	45 kA
16	45 kA
20	45 kA
25	45 kA
32	45 kA
40	25 kA
50	25 kA
63	25 kA

FAZ and NZM7

I_n [A]	FAZ- I_n /1(2,3,4)/B(C) + NZM7-40(...100) $U_e = 230/400$ V
0.16	25 kA
0.25	25 kA
0.5	25 kA
0.75	25 kA
1	25 kA
1.5	25 kA
2	25 kA
2.5	25 kA
3	25 kA
3.5	25 kA
4	25 kA
5	20 kA
6	20 kA
8	20 kA
10	20 kA
12	20 kA
13	20 kA
15	20 kA
16	20 kA
20	18 kA
25	18 kA
32	18 kA
40	18 kA
50	15 kA
63	15 kA

FAZ and NZMB1

$U_e = 230/400\text{ V}$: I_{cu} (FAZ) = 15 kA

$U_e = 230/400\text{ V}$: I_{cu} (NZMB1) = 25 kA

Back-up test acc. EN/IEC 60947-2, app. A: $U = 1.05U_e$, (O - t - CO)

(Settings NZMB1: I_r , I_{rm} at max. volumes)

I_n [A]	FAZ-$I_n/1(2,3,4)/B(C)$ + NZMB1 $U_e = 230/400\text{ V}$
0.16	25 kA
0.25	25 kA
0.5	25 kA
0.75	25 kA
1	25 kA
1.5	25 kA
2	25 kA
2.5	25 kA
3	25 kA
3.5	25 kA
4	25 kA
5	25 kA
6	25 kA
8	25 kA
10	25 kA
12	25 kA
13	25 kA
15	25 kA
16	25 kA
20	20 kA
25	20 kA
32	20 kA
40	20 kA
50	15 kA
63	15 kA

FAZ and NZMN1

$U_e = 230/400\text{ V}$: I_{cu} (FAZ) = 15 kA

$U_e = 230/400\text{ V}$: I_{cu} (NZMN1) = 25 kA

Back-up test acc. EN/IEC 60947-2, app. A: $U = 1.05U_e$, (O - t - CO)

(Settings NZM at max. values)

I_n [A]	FAZ-$I_n/1(2,3,4)/B(C)$ + NZMN1 $U_e = 230/400\text{ V}$
0.16	25 kA
0.25	25 kA
0.5	25 kA
0.75	25 kA
1	25 kA
1.5	25 kA
2	25 kA
2.5	25 kA
3	25 kA
3.5	25 kA
4	25 kA
5	25 kA
6	25 kA
8	25 kA
10	25 kA
12	25 kA
13	25 kA
15	25 kA
16	25 kA
20	20 kA
25	20 kA
32	20 kA
40	20 kA
50	15 kA
63	15 kA

FAZ and NZMB2

$U_e = 230/400\text{ V}$: I_{cu} (FAZ) = 15 kA
 $U_e = 230/400\text{ V}$: I_{cu} (NZMB2) = 25 kA
 $U_e = 133/230\text{ V}$: I_{cu} (FAZ) = 20 kA
 $U_e = 133/230\text{ V}$: I_{cu} (NZMB2) = 30 kA
 Back-up test acc. EN/IEC 60947-2, app. A: $U = 1.05U_e$, (O - t - CO)
 (Settings NZM at max. values)

I_n [A]	FAZ-$I_n/1(2,3,4)/B(C)$ + NZMB2	
	$U_e = 230/400\text{ V}$	$U_e = 133/230\text{ V}$
0.16	25 kA	30 kA
0.25	25 kA	30 kA
0.5	25 kA	30 kA
0.75	25 kA	30 kA
1	25 kA	30 kA
1.5	25 kA	30 kA
2	25 kA	30 kA
2.5	25 kA	30 kA
3	25 kA	30 kA
3.5	25 kA	30 kA
4	25 kA	30 kA
5	25 kA	25 kA
6	25 kA	25 kA
8	25 kA	25 kA
10	25 kA	25 kA
12	20 kA	25 kA
13	20 kA	25 kA
15	20 kA	25 kA
16	20 kA	25 kA
20	20 kA	25 kA
25	20 kA	25 kA
32	20 kA	25 kA
40	15 kA	20 kA
50	15 kA	20 kA
63	15 kA	20 kA

FAZ and NZMN2

$U_e = 230/400\text{ V}$: I_{cu} (FAZ) = 15 kA
 $U_e = 230/400\text{ V}$: I_{cu} (NZMN2) = 50 kA
 $U_e = 133/230\text{ V}$: I_{cu} (FAZ) = 20 kA
 $U_e = 133/230\text{ V}$: I_{cu} (NZMN2) = 85 kA
 Back-up test acc. EN/IEC 60947-2, app. A: $U = 1.05U_e$, (O - t - CO)
 (Settings NZM at max. values)

I_n [A]	FAZ-$I_n/1(2,3,4)/B(C)$ + NZMN2	
	$U_e = 230/400\text{ V}$	$U_e = 133/230\text{ V}$
0.16	50 kA	85 kA
0.25	50 kA	85 kA
0.5	50 kA	85 kA
0.75	50 kA	85 kA
1	50 kA	85 kA
1.5	50 kA	85 kA
2	50 kA	85 kA
2.5	50 kA	85 kA
3	50 kA	85 kA
3.5	50 kA	85 kA
4	50 kA	85 kA
5	50 kA	80 kA
6	50 kA	80 kA
8	50 kA	80 kA
10	50 kA	80 kA
12	30 kA	60 kA
13	30 kA	60 kA
15	30 kA	60 kA
16	30 kA	60 kA
20	30 kA	60 kA
25	30 kA	60 kA
32	30 kA	60 kA
40	20 kA	40 kA
50	20 kA	40 kA
63	20 kA	40 kA

FAZ and NZMH2

$U_e = 230/400\text{ V}$: I_{cu} (FAZ) = 15 kA
 $U_e = 230/400\text{ V}$: I_{cu} (NZMH2) = 150 kA
 $U_e = 133/230\text{ V}$: I_{cu} (FAZ) = 20 kA
 $U_e = 133/230\text{ V}$: I_{cu} (NZMH2) = 150 kA
 Back-up test acc. EN/IEC 60947-2, app. A: $U = 1.05U_e$, (O - t - CO)
 (Settings NZM at max. values)

I_n [A]	FAZ-$I_n/1(2,3,4)/B(C)$ + NZMH2	
	$U_e = 230/400\text{ V}$	$U_e = 133/230\text{ V}$
0.16	50 kA	85 kA
0.25	50 kA	85 kA
0.5	50 kA	85 kA
0.75	50 kA	85 kA
1	50 kA	85 kA
1.5	50 kA	85 kA
2	50 kA	85 kA
2.5	50 kA	85 kA
3	50 kA	85 kA
3.5	50 kA	85 kA
4	50 kA	85 kA
5	50 kA	80 kA
6	50 kA	80 kA
8	50 kA	80 kA
10	50 kA	80 kA
12	30 kA	60 kA
13	30 kA	60 kA
15	30 kA	60 kA
16	30 kA	60 kA
20	30 kA	60 kA
25	30 kA	60 kA
32	30 kA	60 kA
40	20 kA	40 kA
50	20 kA	40 kA
63	20 kA	40 kA

FAZ and NZML2

$U_e = 230/400\text{ V}$: I_{cu} (FAZ) = 15 kA
 $U_e = 230/400\text{ V}$: I_{cu} (NZML2) = 150 kA
 $U_e = 133/230\text{ V}$: I_{cu} (FAZ) = 20 kA
 $U_e = 133/230\text{ V}$: I_{cu} (NZML2) = 150 kA
 Back-up test acc. EN/IEC 60947-2, app. A: $U = 1.05U_e$, (O - t - CO)
 (Settings NZM at max. values)

I_n [A]	FAZ-$I_n/1(2,3,4)/B(C)$ + NZML2	
	$U_e = 230/400\text{ V}$	$U_e = 133/230\text{ V}$
0.16	50 kA	85 kA
0.25	50 kA	85 kA
0.5	50 kA	85 kA
0.75	50 kA	85 kA
1	50 kA	85 kA
1.5	50 kA	85 kA
2	50 kA	85 kA
2.5	50 kA	85 kA
3	50 kA	85 kA
3.5	50 kA	85 kA
4	50 kA	85 kA
5	50 kA	80 kA
6	50 kA	80 kA
8	50 kA	80 kA
10	50 kA	80 kA
12	30 kA	60 kA
13	30 kA	60 kA
15	30 kA	60 kA
16	30 kA	60 kA
20	30 kA	60 kA
25	30 kA	60 kA
32	30 kA	60 kA
40	20 kA	40 kA
50	20 kA	40 kA
63	20 kA	40 kA

FAZ and NH

$U_e = 230\text{ V}$: I_{cu} (FAZ) = 15 (10) kA (acc. to IEC/EN 60947)

$U_e = 500\text{ V}$: I_{cu} (NH00 125 A gL / gG) = 120kA

I_n [A]	FAZ-I_n/B,(C),(D)... + NH00 125 A gL/gG IT-system U = 230 V
0.5	50 kA
1	50 kA
2	50 kA
3	50 kA
4	50 kA
6	50 kA
10	50 kA
13	50 kA
16	50 kA
20	50 kA
25	50 kA
32	50 kA
40	50 kA
50	50 kA
63	50 kA

Overload Selectivity FAZ

FAZ-B(C)(D) to FAZ-B

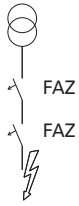

Upstream side FAZ, Characteristic B
Downstream side FAZ, Characteristic B, C, D

x ... Selectivity range (i.e. only the downstream switch drops in case $I < I_g$)

Upstream side	FAZ Characteristic B													
Type B rated current I_n [A]		2	3	4	6	10	13	16	20	25	32	40	50	63
Selectivity limiting current I_g [A]		7	10.5	14	21	35	45.5	56	70	87.5	112	140	175	220.5
Downstream side FAZ Characteristic B	2		x	x	x	x	x	x	x	x	x	x	x	x
	3			x	x	x	x	x	x	x	x	x	x	x
	4				x	x	x	x	x	x	x	x	x	x
	6					x	x	x	x	x	x	x	x	x
	10						x	x	x	x	x	x	x	x
	13							x	x	x	x	x	x	x
	16								x	x	x	x	x	x
	20									x	x	x	x	x
	25										x	x	x	x
	32											x	x	x
	40												x	x
	50													x
	63													

Upstream side	FAZ Characteristic B															
Type B rated current I_n [A]		2	3	4	6	10	13	16	20	25	32	40	50	63		
Selectivity limiting current I_g [A]		7	10.5	14	21	35	45.5	56	70	87.5	112	140	175	220.5		
Downstream side FAZ Characteristic C	0.5	x	x	x	x	x	x	x	x	x	x	x	x	x		
	1	x	x	x	x	x	x	x	x	x	x	x	x	x		
	2			x	x	x	x	x	x	x	x	x	x	x		
	3				x	x	x	x	x	x	x	x	x	x		
	4					x	x	x	x	x	x	x	x	x		
	6						x	x	x	x	x	x	x	x		
	8							x	x	x	x	x	x	x		
	10								x	x	x	x	x	x		
	13									x	x	x	x	x		
	16										x	x	x	x		
	20											x	x	x		
	25												x	x		
	32													x		
	40														x	
	50															x
63																x

Upstream side	FAZ Characteristic B															
Type B rated current I_n [A]		2	3	4	6	10	13	16	20	25	32	40	50	63		
Selectivity limiting current I_g [A]		7	10.5	14	21	35	45.5	56	70	87.5	112	140	175	220.5		
Downstream side FAZ Characteristic D	2					x	x	x	x	x	x	x	x	x		
	4							x	x	x	x	x	x	x		
	6								x	x	x	x	x	x		
	10										x	x	x	x		
	13											x	x	x		
	16												x	x		
	20													x		
	25														x	
	32															x
40																x

Overload Selectivity FAZ

FAZ-B(C)(D) to FAZ-C

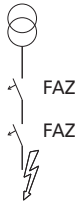

Upstream side FAZ, Characteristic C

Downstream side FAZ, Characteristic B, C, D

x ... Selectivity range (i.e. only the downstream switch drops in case $I < I_g$)

Upstream side →		FAZ Characteristic C																
Type B rated current I_n [A]		0.5	1	2	3	4	6	8	10	13	16	20	25	32	40	50	63	
Selectivity limiting current I_g [A]		2.85	5.7	11.4	17.1	22.8	34.2	45.6	57	74.1	91.2	114	142.5	182.4	228	285	359.1	
Downstream side FAZ Characteristic B	2				x	x	x	x	x	x	x	x	x	x	x	x	x	
	3					x	x	x	x	x	x	x	x	x	x	x	x	
	4						x	x	x	x	x	x	x	x	x	x	x	
	6							x	x	x	x	x	x	x	x	x	x	
	10									x	x	x	x	x	x	x	x	
	13										x	x	x	x	x	x	x	
	16											x	x	x	x	x	x	
	20												x	x	x	x	x	
	25													x	x	x	x	
	32														x	x	x	
	40															x	x	
	50																x	x
	63																	x

Upstream side →		FAZ Characteristic C															
Type B rated current I_n [A]		0.5	1	2	3	4	6	8	10	13	16	20	25	32	40	50	63
Selectivity limiting current I_g [A]		2.85	5.7	11.4	17.1	22.8	34.2	45.6	57	74.1	91.2	114	142.5	182.4	228	285	359.1
Downstream side FAZ Characteristic C	0.5		x	x	x	x	x	x	x	x	x	x	x	x	x	x	x
	1			x	x	x	x	x	x	x	x	x	x	x	x	x	x
	2				x	x	x	x	x	x	x	x	x	x	x	x	x
	3					x	x	x	x	x	x	x	x	x	x	x	x
	4						x	x	x	x	x	x	x	x	x	x	x
	6							x	x	x	x	x	x	x	x	x	x
	8								x	x	x	x	x	x	x	x	x
	10									x	x	x	x	x	x	x	x
	13										x	x	x	x	x	x	x
	16											x	x	x	x	x	x
	20												x	x	x	x	x
	25													x	x	x	x
	32														x	x	x
	40															x	x
	50																x
63																	x

Upstream side →		FAZ Characteristic C															
Type B rated current I_n [A]		0.5	1	2	3	4	6	8	10	13	16	20	25	32	40	50	63
Selectivity limiting current I_g [A]		2.85	5.7	11.4	17.1	22.8	34.2	45.6	57	74.1	91.2	114	142.5	182.4	228	285	359.1
Downstream side FAZ Characteristic D	2						x	x	x	x	x	x	x	x	x	x	x
	4							x	x	x	x	x	x	x	x	x	x
	6								x	x	x	x	x	x	x	x	x
	10										x	x	x	x	x	x	x
	13											x	x	x	x	x	x
	16												x	x	x	x	x
	20													x	x	x	x
	25														x	x	x
	32															x	x
40																x	x

Overload Selectivity FAZ

FAZ-B(C)(D) to FAZ-D

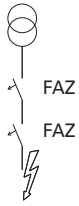

Upstream side FAZ, Characteristic D
 Downstream side FAZ, Characteristic B, C, D

x ... Selectivity range (i.e. only the downstream switch drops in case $I < I_g$)

Upstream side →		FAZ Characteristic D									
Type B rated current I_n [A]		2	4	6	10	13	16	20	25	32	40
Selectivity limiting current I_g [A]		21	42	63	105	136.5	168	210	262.5	336	420
Downstream side FAZ Characteristic B	2	x	x	x	x	x	x	x	x	x	x
	3		x	x	x	x	x	x	x	x	x
	4			x	x	x	x	x	x	x	x
	6				x	x	x	x	x	x	x
	10					x	x	x	x	x	x
	13						x	x	x	x	x
	16							x	x	x	x
	20								x	x	x
	25									x	x
	32										x
	40										
	50										
63											

Upstream side →		FAZ Characteristic D									
Type B rated current I_n [A]		2	4	6	10	13	16	20	25	32	40
Selectivity limiting current I_g [A]		21	42	63	105	136.5	168	210	262.5	336	420
Downstream side FAZ Characteristic C	0.5	x	x	x	x	x	x	x	x	x	x
	1	x	x	x	x	x	x	x	x	x	x
	2		x	x	x	x	x	x	x	x	x
	3			x	x	x	x	x	x	x	x
	4				x	x	x	x	x	x	x
	6					x	x	x	x	x	x
	8						x	x	x	x	x
	10							x	x	x	x
	13								x	x	x
	16									x	x
	20										x
	25										
	32										
	40										
	50										
63											

Upstream side →		FAZ Characteristic D									
Type B rated current I_n [A]		2	4	6	10	13	16	20	25	32	40
Selectivity limiting current I_g [A]		21	42	63	105	136.5	168	210	262.5	336	420
Downstream side FAZ Characteristic D	2	x	x	x	x	x	x	x	x	x	x
	4			x	x	x	x	x	x	x	x
	6				x	x	x	x	x	x	x
	10					x	x	x	x	x	x
	13						x	x	x	x	x
	16							x	x	x	x
	20								x	x	x
	25									x	x
	32										x
40											

Overload Selectivity FAZ

FAZ-B(C)(D) to AZ-C

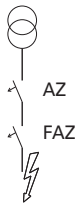

Upstream side AZ, Characteristic C
Downstream side FAZ, Characteristic B, C, D

x ... Selectivity range (i.e. only the downstream switch drops in case $I < I_g$)

Upstream side →		AZ Characteristic C									
Type B rated current I_n [A]		20	25	32	40	50	63	80	100	125	
Selectivity limiting current I_g [A]		130	163	208	260	325	410	520	650	813	
Downstream side FAZ Characteristic B	2	x	x	x	x	x	x	x	x	x	x
	3	x	x	x	x	x	x	x	x	x	x
	4	x	x	x	x	x	x	x	x	x	x
	6	x	x	x	x	x	x	x	x	x	x
	10	x	x	x	x	x	x	x	x	x	x
	13	x	x	x	x	x	x	x	x	x	x
	16	x	x	x	x	x	x	x	x	x	x
	20		x	x	x	x	x	x	x	x	x
	25			x	x	x	x	x	x	x	x
	32				x	x	x	x	x	x	x
	40					x	x	x	x	x	x
	50						x	x	x	x	x
63							x	x	x	x	

Upstream side →		AZ Characteristic C									
Type B rated current I_n [A]		20	25	32	40	50	63	80	100	125	
Selectivity limiting current I_g [A]		130	163	208	260	325	410	520	650	813	
Downstream side FAZ Characteristic C	0.5	x	x	x	x	x	x	x	x	x	x
	1	x	x	x	x	x	x	x	x	x	x
	2	x	x	x	x	x	x	x	x	x	x
	3	x	x	x	x	x	x	x	x	x	x
	4	x	x	x	x	x	x	x	x	x	x
	6	x	x	x	x	x	x	x	x	x	x
	8	x	x	x	x	x	x	x	x	x	x
	10	x	x	x	x	x	x	x	x	x	x
	13	x	x	x	x	x	x	x	x	x	x
	16	x	x	x	x	x	x	x	x	x	x
	20		x	x	x	x	x	x	x	x	x
	25			x	x	x	x	x	x	x	x
	32				x	x	x	x	x	x	x
	40					x	x	x	x	x	x
	50						x	x	x	x	x
63							x	x	x	x	

Upstream side →		AZ Characteristic C									
Type B rated current I_n [A]		20	25	32	40	50	63	80	100	125	
Selectivity limiting current I_g [A]		130	163	208	260	325	410	520	650	813	
Downstream side FAZ Characteristic D	2	x	x	x	x	x	x	x	x	x	x
	4	x	x	x	x	x	x	x	x	x	x
	6	x	x	x	x	x	x	x	x	x	x
	10	x	x	x	x	x	x	x	x	x	x
	13		x	x	x	x	x	x	x	x	x
	16			x	x	x	x	x	x	x	x
	20				x	x	x	x	x	x	x
	25					x	x	x	x	x	x
	32						x	x	x	x	x
	40							x	x	x	x

Overload Selectivity FAZ

FAZ-B(C)(D) to AZ-D

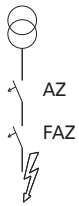

Upstream side AZ, Characteristic D
Downstream side FAZ, Characteristic B, C, D

x ... Selectivity range (i.e. only the downstream switch drops in case $I < I_g$)

Upstream side →		AZ Characteristic D							
Type B rated current I_n [A]		20	25	32	40	50	63	80	100
Selectivity limiting current I_g [A]		230	285	365	450	550	680	850	1020
Downstream side FAZ Characteristic B	2	x	x	x	x	x	x	x	x
	3	x	x	x	x	x	x	x	x
	4	x	x	x	x	x	x	x	x
	6	x	x	x	x	x	x	x	x
	10	x	x	x	x	x	x	x	x
	13	x	x	x	x	x	x	x	x
	16	x	x	x	x	x	x	x	x
	20		x	x	x	x	x	x	x
	25			x	x	x	x	x	x
	32				x	x	x	x	x
	40					x	x	x	x
	50						x	x	x
	63							x	x

Upstream side →		AZ Characteristic D							
Type B rated current I_n [A]		20	25	32	40	50	63	80	100
Selectivity limiting current I_g [A]		230	285	365	450	550	680	850	1020
Downstream side FAZ Characteristic C	0.5	x	x	x	x	x	x	x	x
	1	x	x	x	x	x	x	x	x
	2	x	x	x	x	x	x	x	x
	3	x	x	x	x	x	x	x	x
	4	x	x	x	x	x	x	x	x
	6	x	x	x	x	x	x	x	x
	8	x	x	x	x	x	x	x	x
	10	x	x	x	x	x	x	x	x
	13	x	x	x	x	x	x	x	x
	16	x	x	x	x	x	x	x	x
	20		x	x	x	x	x	x	x
	25			x	x	x	x	x	x
	32				x	x	x	x	x
	40					x	x	x	x
	50						x	x	x
63							x	x	

Upstream side →		AZ Characteristic D							
Type B rated current I_n [A]		20	25	32	40	50	63	80	100
Selectivity limiting current I_g [A]		230	285	365	450	550	680	850	1020
Downstream side FAZ Characteristic D	2	x	x	x	x	x	x	x	x
	4	x	x	x	x	x	x	x	x
	6	x	x	x	x	x	x	x	x
	10	x	x	x	x	x	x	x	x
	13	x	x	x	x	x	x	x	x
	16	x	x	x	x	x	x	x	x
	20		x	x	x	x	x	x	x
	25			x	x	x	x	x	x
	32				x	x	x	x	x
40					x	x	x	x	

Influence of the Line Frequency FAZ

On the Instantaneous Tripping Current I_{MA}

	Line Frequency f [Hz]						
	16 ² / ₃	50	60	100	200	300	400
$I_{MA}(f)/I_{MA}(50\text{Hz})$ [%]	91	100	101	106	115	134	141

Miniature Circuit Breakers FAZ-T

SG56012



FAZ-T

- High-quality miniature circuit breakers for industrial and commercial applications
- Contact position indicator red - green
- Accessories suitable for subsequent installation
- Rated currents up to 40 A
- Tripping characteristics B, C, D
- Rated breaking capacity up to 25 kA according to EN 60947-2

FAZ-T Miniature Circuit Breakers (MCBs)

Characteristic B

Rated current I_n (A)	Rated voltage IEC/EN 60898-1 (V)	Breaking capacity acc. to IEC/EN 60898-1 (kA)	Rated voltage IEC/EN 60947-2 (V)	Breaking capacity acc. to IEC/EN 60947-2 (kA)	Type Designation	Article No.	Units per package
----------------------------	---	---	---	---	---------------------	-------------	-------------------------

SG53212



1-pole

1	240/415	15	240	25	FAZT-B1/1	240770	12/120
2	240/415	15	240	25	FAZT-B2/1	240771	12/120
3	240/415	15	240	25	FAZT-B3/1	240772	12/120
4	240/415	15	240	25	FAZT-B4/1	240777	12/120
6	240/415	15	240	25	FAZT-B6/1	240782	12/120
10	240/415	15	240	25	FAZT-B10/1	240787	12/120
12	240/415	15	240	25	FAZT-B12/1	240792	12/120
13	240/415	15	240	25	FAZT-B13/1	240793	12/120
15	240/415	15	240	25	FAZT-B15/1	240794	12/120
16	240/415	15	240	25	FAZT-B16/1	240795	12/120
20	240/415	15	240	25	FAZT-B20/1	240796	12/120
25	240/415	15	240	25	FAZT-B25/1	240797	12/120
32	240/415	10	240	20	FAZT-B32/1	141907	12/120
40	240/415	10	240	20	FAZT-B40/1	141908	12/120

SG55412



1+N-pole

1	240	15	240	25	FAZT-B1/1N	240994	1/60
2	240	15	240	25	FAZT-B2/1N	240995	1/60
3	240	15	240	25	FAZT-B3/1N	240996	1/60
4	240	15	240	25	FAZT-B4/1N	240997	1/60
6	240	15	240	25	FAZT-B6/1N	240998	1/60
10	240	15	240	25	FAZT-B10/1N	240999	1/60
12	240	15	240	25	FAZT-B12/1N	241000	1/60
13	240	15	240	25	FAZT-B13/1N	241001	1/60
15	240	15	240	25	FAZT-B15/1N	241005	1/60
16	240	15	240	25	FAZT-B16/1N	241009	1/60
20	240	15	240	25	FAZT-B20/1N	241015	1/60
25	240	15	240	25	FAZT-B25/1N	241019	1/60
32	240	10	240	20	FAZT-B32/1N	142509	1/60
40	240	10	240	20	FAZT-B40/1N	142510	1/60

SG55212



2-pole

1	415	15	240/415	25	FAZT-B1/2	240820	1/60
2	415	15	240/415	25	FAZT-B2/2	240821	1/60
3	415	15	240/415	25	FAZT-B3/2	240822	1/60
4	415	15	240/415	25	FAZT-B4/2	240823	1/60
6	415	15	240/415	25	FAZT-B6/2	240824	1/60
10	415	15	240/415	25	FAZT-B10/2	240825	1/60
12	415	15	240/415	25	FAZT-B12/2	240826	1/60
13	415	15	240/415	25	FAZT-B13/2	240827	1/60
15	415	15	240/415	25	FAZT-B15/2	240828	1/60
16	415	15	240/415	25	FAZT-B16/2	240829	1/60
20	415	15	240/415	25	FAZT-B20/2	240830	1/60
25	415	15	240/415	25	FAZT-B25/2	240831	1/60
32	415	10	240/415	20	FAZT-B32/2	142485	1/60
40	415	10	240/415	20	FAZT-B40/2	142486	1/60

Rated current I_n (A)	Rated voltage IEC/EN 60898-1 (V)	Breaking capacity acc. to IEC/EN 60898-1 (kA)	Rated voltage IEC/EN 60947-2 (V)	Breaking capacity acc. to IEC/EN 60947-2 (kA)	Type Designation	Article No.	Units per package
----------------------------	---	---	---	---	---------------------	-------------	-------------------------

SG53512



3-pole

1	415	15	240/415	25	FAZT-B1/3	240874	1/40
2	415	15	240/415	25	FAZT-B2/3	240875	1/40
3	415	15	240/415	25	FAZT-B3/3	240876	1/40
4	415	15	240/415	25	FAZT-B4/3	240877	1/40
6	415	15	240/415	25	FAZT-B6/3	240878	1/40
10	415	15	240/415	25	FAZT-B10/3	240879	1/40
12	415	15	240/415	25	FAZT-B12/3	240880	1/40
13	415	15	240/415	25	FAZT-B13/3	240881	1/40
15	415	15	240/415	25	FAZT-B15/3	240882	1/40
16	415	15	240/415	25	FAZT-B16/3	240883	1/40
20	415	15	240/415	25	FAZT-B20/3	240884	1/40
25	415	15	240/415	25	FAZT-B25/3	240885	1/40
32	415	10	240/415	20	FAZT-B32/3	142493	1/40
40	415	10	240/415	20	FAZT-B40/3	142494	1/40

SG55912



3+N-pole

1	415	15	240/415	25	FAZT-B1/3N	241060	1/30
2	415	15	240/415	25	FAZT-B2/3N	241065	1/30
3	415	15	240/415	25	FAZT-B3/3N	241070	1/30
4	415	15	240/415	25	FAZT-B4/3N	241075	1/30
6	415	15	240/415	25	FAZT-B6/3N	241080	1/30
10	415	15	240/415	25	FAZT-B10/3N	241085	1/30
12	415	15	240/415	25	FAZT-B12/3N	241090	1/30
13	415	15	240/415	25	FAZT-B13/3N	241095	1/30
15	415	15	240/415	25	FAZT-B15/3N	241100	1/30
16	415	15	240/415	25	FAZT-B16/3N	241105	1/30
20	415	15	240/415	25	FAZT-B20/3N	241110	1/30
25	415	15	240/415	25	FAZT-B25/3N	241115	1/30
32	415	10	240/415	20	FAZT-B32/3N	142517	1/30
40	415	10	240/415	20	FAZT-B40/3N	142518	1/30

SG56012



4-pole

1	415	15	240/415	25	FAZT-B1/4	240922	1/30
2	415	15	240/415	25	FAZT-B2/4	240927	1/30
3	415	15	240/415	25	FAZT-B3/4	240930	1/30
4	415	15	240/415	25	FAZT-B4/4	240931	1/30
6	415	15	240/415	25	FAZT-B6/4	240932	1/30
10	415	15	240/415	25	FAZT-B10/4	240933	1/30
12	415	15	240/415	25	FAZT-B12/4	240934	1/30
13	415	15	240/415	25	FAZT-B13/4	240935	1/30
15	415	15	240/415	25	FAZT-B15/4	240936	1/30
16	415	15	240/415	25	FAZT-B16/4	240937	1/30
20	415	15	240/415	25	FAZT-B20/4	240938	1/30
25	415	15	240/415	25	FAZT-B25/4	240939	1/30
32	415	10	240/415	20	FAZT-B32/4	142501	1/30
40	415	10	240/415	20	FAZT-B40/4	142502	1/30

FAZ-T Miniature Circuit Breakers (MCBs)

Characteristic C

Rated current I_n (A)	Rated voltage IEC/EN 60898-1 (V)	Breaking capacity acc. to IEC/EN 60898-1 (kA)	Rated voltage IEC/EN 60947-2 (V)	Breaking capacity acc. to IEC/EN 60947-2 (kA)	Type Designation	Article No.	Units per package
----------------------------	---	---	---	---	---------------------	-------------	-------------------------

SG53212



1-pole

1	240/415	15	240	25	FAZT-C1/1	240798	12/120
2	240/415	15	240	25	FAZT-C2/1	240799	12/120
3	240/415	15	240	25	FAZT-C3/1	240800	12/120
4	240/415	15	240	25	FAZT-C4/1	240801	12/120
6	240/415	15	240	25	FAZT-C6/1	240802	12/120
10	240/415	15	240	25	FAZT-C10/1	240803	12/120
12	240/415	15	240	25	FAZT-C12/1	240804	12/120
13	240/415	15	240	25	FAZT-C13/1	240805	12/120
15	240/415	15	240	25	FAZT-C15/1	240806	12/120
16	240/415	15	240	25	FAZT-C16/1	240807	12/120
20	240/415	15	240	25	FAZT-C20/1	240808	12/120
25	240/415	15	240	25	FAZT-C25/1	240809	12/120
32	240/415	10	240	20	FAZT-C32/1	141909	12/120
40	240/415	10	240	20	FAZT-C40/1	142480	12/120

SG55412



1+N-pole

1	240	15	240	25	FAZT-C1/1N	241022	1/60
2	240	15	240	25	FAZT-C2/1N	241023	1/60
3	240	15	240	25	FAZT-C3/1N	241024	1/60
4	240	15	240	25	FAZT-C4/1N	241025	1/60
6	240	15	240	25	FAZT-C6/1N	241026	1/60
10	240	15	240	25	FAZT-C10/1N	241027	1/60
12	240	15	240	25	FAZT-C12/1N	241028	1/60
13	240	15	240	25	FAZT-C13/1N	241029	1/60
15	240	15	240	25	FAZT-C15/1N	241030	1/60
16	240	15	240	25	FAZT-C16/1N	241034	1/60
20	240	15	240	25	FAZT-C20/1N	241038	1/60
25	240	15	240	25	FAZT-C25/1N	241044	1/60
32	240	10	240	20	FAZT-C32/1N	142511	1/60
40	240	10	240	20	FAZT-C40/1N	142512	1/60

SG55212



2-pole

1	415	15	240/415	25	FAZT-C1/2	240832	1/60
2	415	15	240/415	25	FAZT-C2/2	240833	1/60
3	415	15	240/415	25	FAZT-C3/2	240838	1/60
4	415	15	240/415	25	FAZT-C4/2	240843	1/60
6	415	15	240/415	25	FAZT-C6/2	240850	1/60
10	415	15	240/415	25	FAZT-C10/2	240855	1/60
12	415	15	240/415	25	FAZT-C12/2	240858	1/60
13	415	15	240/415	25	FAZT-C13/2	240859	1/60
15	415	15	240/415	25	FAZT-C15/2	240860	1/60
16	415	15	240/415	25	FAZT-C16/2	240861	1/60
20	415	15	240/415	25	FAZT-C20/2	240862	1/60
25	415	15	240/415	25	FAZT-C25/2	240863	1/60
32	415	10	240/415	20	FAZT-C32/2	142487	1/60
40	415	10	240/415	20	FAZT-C40/2	142488	1/60

SG53512



3-pole

	Rated current I_n (A)	Rated voltage IEC/EN 60898-1 (V)	Breaking capacity acc. to IEC/EN 60898-1 (kA)	Rated voltage IEC/EN 60947-2 (V)	Breaking capacity acc. to IEC/EN 60947-2 (kA)	Type Designation	Article No.	Units per package
1	415	15	240/415	25	FAZT-C1/3	240886	1/40	
2	415	15	240/415	25	FAZT-C2/3	240887	1/40	
3	415	15	240/415	25	FAZT-C3/3	240888	1/40	
4	415	15	240/415	25	FAZT-C4/3	240889	1/40	
6	415	15	240/415	25	FAZT-C6/3	240890	1/40	
10	415	15	240/415	25	FAZT-C10/3	240891	1/40	
12	415	15	240/415	25	FAZT-C12/3	240892	1/40	
13	415	15	240/415	25	FAZT-C13/3	240893	1/40	
15	415	15	240/415	25	FAZT-C15/3	240894	1/40	
16	415	15	240/415	25	FAZT-C16/3	240895	1/40	
20	415	15	240/415	25	FAZT-C20/3	240896	1/40	
25	415	15	240/415	25	FAZT-C25/3	240897	1/40	
32	415	10	240/415	20	FAZT-C32/3	142495	1/40	
40	415	10	240/415	20	FAZT-C40/3	142496	1/40	

SG55912



3+N-pole

1	415	15	240/415	25	FAZT-C1/3N	241120	1/30
2	415	15	240/415	25	FAZT-C2/3N	241125	1/30
3	415	15	240/415	25	FAZT-C3/3N	241130	1/30
4	415	15	240/415	25	FAZT-C4/3N	241135	1/30
6	415	15	240/415	25	FAZT-C6/3N	241140	1/30
10	415	15	240/415	25	FAZT-C10/3N	241145	1/30
12	415	15	240/415	25	FAZT-C12/3N	241150	1/30
13	415	15	240/415	25	FAZT-C13/3N	241155	1/30
15	415	15	240/415	25	FAZT-C15/3N	241160	1/30
16	415	15	240/415	25	FAZT-C16/3N	241165	1/30
20	415	15	240/415	25	FAZT-C20/3N	241170	1/30
25	415	15	240/415	25	FAZT-C25/3N	241175	1/30
32	415	10	240/415	20	FAZT-C32/3N	142519	1/30
40	415	10	240/415	20	FAZT-C40/3N	142520	1/30

SG56012



4-pole

1	415	15	240/415	25	FAZT-C1/4	240940	1/30
2	415	15	240/415	25	FAZT-C2/4	240941	1/30
3	415	15	240/415	25	FAZT-C3/4	240945	1/30
4	415	15	240/415	25	FAZT-C4/4	240949	1/30
6	415	15	240/415	25	FAZT-C6/4	240955	1/30
10	415	15	240/415	25	FAZT-C10/4	240959	1/30
12	415	15	240/415	25	FAZT-C12/4	240962	1/30
13	415	15	240/415	25	FAZT-C13/4	240963	1/30
15	415	15	240/415	25	FAZT-C15/4	240964	1/30
16	415	15	240/415	25	FAZT-C16/4	240965	1/30
20	415	15	240/415	25	FAZT-C20/4	240966	1/30
25	415	15	240/415	25	FAZT-C25/4	240967	1/30
32	415	10	240/415	20	FAZT-C32/4	142503	1/30
40	415	10	240/415	20	FAZT-C40/4	142504	1/30

FAZ-T Miniature Circuit Breakers (MCBs)

Characteristic D

	Rated current I_n (A)	Rated voltage IEC/EN 60898-1 (V)	Breaking capacity acc. to IEC/EN 60898-1 (kA)	Rated voltage IEC/EN 60947-2 (V)	Breaking capacity acc. to IEC/EN 60947-2 (kA)	Type Designation	Article No.	Units per package
1-pole								
1	240/415	15	240	25	FAZT-D1/1	240810	12/120	
2	240/415	15	240	25	FAZT-D2/1	240811	12/120	
3	240/415	15	240	25	FAZT-D3/1	240812	12/120	
4	240/415	15	240	25	FAZT-D4/1	240813	12/120	
6	240/415	15	240	25	FAZT-D6/1	240814	12/120	
10	240/415	15	240	25	FAZT-D10/1	240815	12/120	
12	240/415	15	240	25	FAZT-D12/1	240816	12/120	
13	240/415	15	240	25	FAZT-D13/1	240817	12/120	
15	240/415	15	240	20	FAZT-D15/1	240818	12/120	
16	240/415	15	240	20	FAZT-D16/1	240819	12/120	
20	240/415	10	240	20	FAZT-D20/1	142481	12/120	
25	240/415	10	240	15	FAZT-D25/1	142482	12/120	
32	240/415	10	240	15	FAZT-D32/1	142483	12/120	
40	240/415	10	240	15	FAZT-D40/1	142484	12/120	
1+N-pole								
1	240	15	240	25	FAZT-D1/1N	241048	1/60	
2	240	15	240	25	FAZT-D2/1N	241051	1/60	
3	240	15	240	25	FAZT-D3/1N	241052	1/60	
4	240	15	240	25	FAZT-D4/1N	241053	1/60	
6	240	15	240	25	FAZT-D6/1N	241054	1/60	
10	240	15	240	25	FAZT-D10/1N	241055	1/60	
12	240	15	240	25	FAZT-D12/1N	241056	1/60	
13	240	15	240	25	FAZT-D13/1N	241057	1/60	
15	240	15	240	20	FAZT-D15/1N	241058	1/60	
16	240	15	240	20	FAZT-D16/1N	241059	1/60	
20	240	10	240	20	FAZT-D20/1N	142513	1/60	
25	240	10	240	15	FAZT-D25/1N	142514	1/60	
32	240	10	240	15	FAZT-D32/1N	142515	1/60	
40	240	10	240	15	FAZT-D40/1N	142516	1/60	
2-pole								
1	415	15	240/415	25	FAZT-D1/2	240864	1/60	
2	415	15	240/415	25	FAZT-D2/2	240865	1/60	
3	415	15	240/415	25	FAZT-D3/2	240866	1/60	
4	415	15	240/415	25	FAZT-D4/2	240867	1/60	
6	415	15	240/415	25	FAZT-D6/2	240868	1/60	
10	415	15	240/415	25	FAZT-D10/2	240869	1/60	
12	415	15	240/415	25	FAZT-D12/2	240870	1/60	
13	415	15	240/415	25	FAZT-D13/2	240871	1/60	
15	415	15	240/415	20	FAZT-D15/2	240872	1/60	
16	415	15	240/415	20	FAZT-D16/2	240873	1/60	
20	415	10	240/415	20	FAZT-D20/2	142489	1/60	
25	415	10	240/415	15	FAZT-D25/2	142490	1/60	
32	415	10	240/415	15	FAZT-D32/2	142491	1/60	
40	415	10	240/415	15	FAZT-D40/2	142492	1/60	

SG53212



SG55412



SG55212



SG53512



3-pole

	Rated current I_n (A)	Rated voltage IEC/EN 60898-1 (V)	Breaking capacity acc. to IEC/EN 60898-1 (kA)	Rated voltage IEC/EN 60947-2 (V)	Breaking capacity acc. to IEC/EN 60947-2 (kA)	Type Designation	Article No.	Units per package
1	415	15	240/415	25		FAZT-D1/3	240898	1/40
2	415	15	240/415	25		FAZT-D2/3	240899	1/40
3	415	15	240/415	25		FAZT-D3/3	240900	1/40
4	415	15	240/415	25		FAZT-D4/3	240901	1/40
6	415	15	240/415	25		FAZT-D6/3	240902	1/40
10	415	15	240/415	25		FAZT-D10/3	240903	1/40
12	415	15	240/415	25		FAZT-D12/3	240904	1/40
13	415	15	240/415	25		FAZT-D13/3	240905	1/40
15	415	15	240/415	25		FAZT-D15/3	240910	1/40
16	415	15	240/415	25		FAZT-D16/3	240915	1/40
20	415	10	240/415	20		FAZT-D20/3	142497	1/40
25	415	10	240/415	15		FAZT-D25/3	142498	1/40
32	415	10	240/415	15		FAZT-D32/3	142499	1/40
40	415	10	240/415	15		FAZT-D40/3	142500	1/40

SG55912



3+N-pole

	Rated current I_n (A)	Rated voltage IEC/EN 60898-1 (V)	Breaking capacity acc. to IEC/EN 60898-1 (kA)	Rated voltage IEC/EN 60947-2 (V)	Breaking capacity acc. to IEC/EN 60947-2 (kA)	Type Designation	Article No.	Units per package
1	415	15	240/415	25		FAZT-D1/3N	241180	1/30
2	415	15	240/415	25		FAZT-D2/3N	241181	1/30
3	415	15	240/415	25		FAZT-D3/3N	241182	1/30
4	415	15	240/415	25		FAZT-D4/3N	241183	1/30
6	415	15	240/415	25		FAZT-D6/3N	241184	1/30
10	415	15	240/415	25		FAZT-D10/3N	241185	1/30
12	415	15	240/415	25		FAZT-D12/3N	241186	1/30
13	415	15	240/415	25		FAZT-D13/3N	241187	1/30
15	415	15	240/415	25		FAZT-D15/3N	241188	1/30
16	415	15	240/415	25		FAZT-D16/3N	241189	1/30
20	415	10	240/415	20		FAZT-D20/3N	142521	1/30
25	415	10	240/415	15		FAZT-D25/3N	142522	1/30
32	415	10	240/415	15		FAZT-D32/3N	142523	1/30
40	415	10	240/415	15		FAZT-D40/3N	142524	1/30

SG56012



4-pole

	Rated current I_n (A)	Rated voltage IEC/EN 60898-1 (V)	Breaking capacity acc. to IEC/EN 60898-1 (kA)	Rated voltage IEC/EN 60947-2 (V)	Breaking capacity acc. to IEC/EN 60947-2 (kA)	Type Designation	Article No.	Units per package
1	415	15	240/415	25		FAZT-D1/4	240968	1/30
2	415	15	240/415	25		FAZT-D2/4	240969	1/30
3	415	15	240/415	25		FAZT-D3/4	240970	1/30
4	415	15	240/415	25		FAZT-D4/4	240971	1/30
6	415	15	240/415	25		FAZT-D6/4	240975	1/30
10	415	15	240/415	25		FAZT-D10/4	240979	1/30
12	415	15	240/415	25		FAZT-D12/4	240985	1/30
13	415	15	240/415	25		FAZT-D13/4	240989	1/30
15	415	15	240/415	25		FAZT-D15/4	240992	1/30
16	415	15	240/415	25		FAZT-D16/4	240993	1/30
20	415	10	240/415	20		FAZT-D20/4	142505	1/30
25	415	10	240/415	15		FAZT-D25/4	142506	1/30
32	415	10	240/415	15		FAZT-D32/4	142507	1/30
40	415	10	240/415	15		FAZT-D40/4	142508	1/30

Specifications FAZ-T

Technical data

	FAZ-T
Productstandard	IEC/EN 60947-2 IEC/EN 60898-1
Number of poles	1, 1p+N, 2, 3, 3p+N, 4

Mechanical specifications

Device width	17.7 mm (1p), 27 mm (1p+N), 36 mm (2p), 54 mm (3p), 72mm (3p+N), 72 mm (4p)
Frame size	45 mm
Socket size	80 mm
Device depth	60 mm
Terminals	lift terminal
Terminal capacity rigid solid/stranded wire	1-25 mm ²
Terminal screw	M5 (with slotted screw acc. to EN ISO 4757-Z2, PZ2)
Terminal torque	max. 2.4 Nm
Snap on fixing	tristable (on DIN rail acc. to EN 50022)
Finger proof	acc. to VBG4, ÖVE EN-6
Degree of Protection (DIN VDE 0470)	
Surface mounted	IP 20
Built-in behind panel	IP 40
Contact position indicator	red / green

Electrical specifications

Rated voltage	U_n	240/415Vac 60Vdc per pole
Rated current	I_n	Type B, C, D: 1, 2, 3, 4, 6, 10, 12, 13, 15, 16, 20, 25, 32, 40 A
Rated insulation voltage	U_i	440 V
Rated impulse withstand voltage	U_{imp}	4 kV (1.2/50) μ sec

Tripping characteristic

Conventional non-tripping current	I_{nt}	$1.13 I_n$
Conventional tripping current	I_t	$1.45 I_n$
Reference temperature		30 °C
Temperature factor		0.4% /K
Instantaneous tripping current	I_{mt}	type B: $3 I_n < I_{mt} = 5 I_n \cdot t (I_{mt}) < 0.1 \text{ sec}$ type C: $5 I_n < I_{mt} = 10 I_n \cdot t (I_{mt}) < 0.1 \text{ sec}$ type D: $10 I_n < I_{mt} = 20 I_n \cdot t (I_{mt}) < 0.1 \text{ sec}$

Rated ultimate short-circuit braking capacity I_{cu} (IEC/EN 60947-2)		type B 1-25 A: 25 kA, 32-40 A: 20 kA type C 1-25 A: 25 kA, 32-40 A: 20 kA type D 1p/1p+N/2p - 1-13 A: 25 kA, 15-20 A: 20 kA, 25-40 A: 15 kA 3p/3p+N/4p - 1-16 A: 25 kA, 20 A: 20 kA, 25-40 A: 15 kA
---	--	--

Rated service short-circuit braking capacity I_{cs} (IEC/EN 60947-2)		for $I_{cu} = 25 \text{ kA} \rightarrow I_{cs} = 12.5 \text{ kA}$ for $I_{cu} = 20 \text{ kA} \rightarrow I_{cs} = 10 \text{ kA}$ for $I_{cu} = 15 \text{ kA} \rightarrow I_{cs} = 7.5 \text{ kA}$
--	--	--

Rated short-circuit braking capacity I_{cn} (IEC/EN 60898-1)		type B 1-25 A: 15 kA, 32-40 A: 10 kA type C 1-25 A: 15 kA, 32-40 A: 10 kA type D 1-16 A: 15 kA, 20-40 A: 10 kA
--	--	--

Selectivity class		3 (acc. to EN 60898)
Number of electrical operations		> 4000 (IEC/EN 60898)
Number of mechanical operations		> 10000 (IEC/EN 60947)
Climatic conditions		acc. to IEC 68-2 (25..55°C / 90..95% RH)
Operating temperature range		-40°C to +75°C

Connection diagram

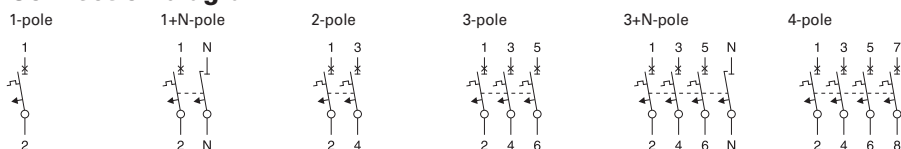

Dimensions (mm) FAZ-T

1-pole

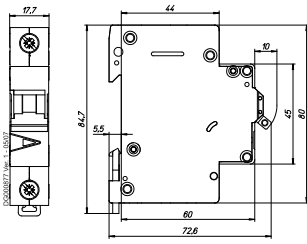

1+N-pole

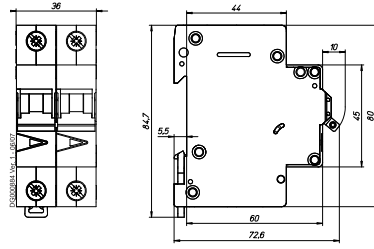

2-pole

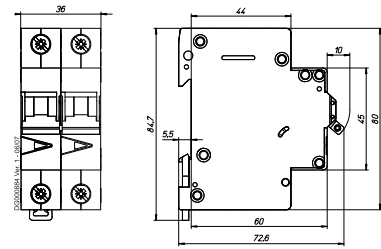

3-pole

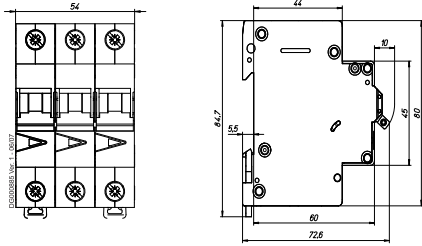

3+N-pole, 4-pole

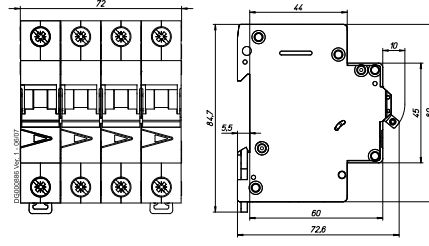

Tripping Characteristic FAZ-T

Characteristics B, C and D - EN60898

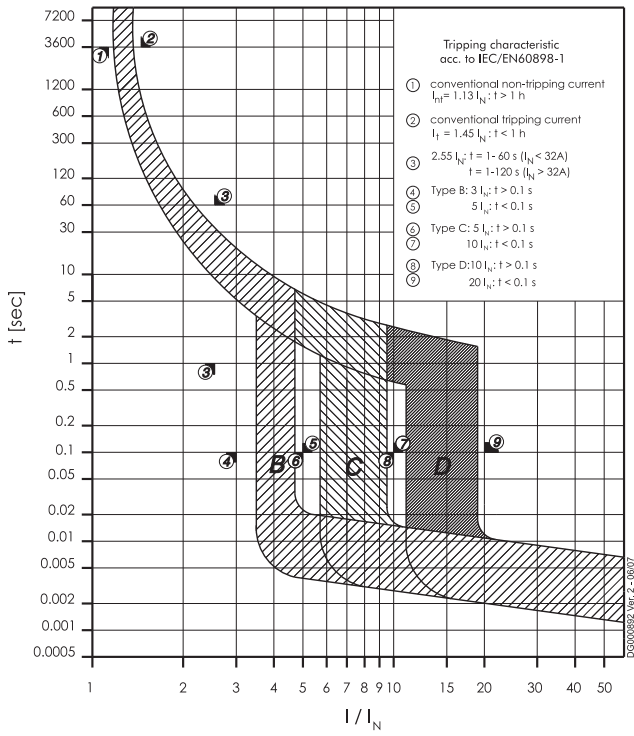

Power Loss at I_n FAZ-T

Type B

	1p	1pN	2p	3p	3pN*	4p
I_n [A]	P [W]	P [W]	P [W]	P [W]	P [W]	P [W]
1	1.6	1.7	3.1	4.7	4.8	6.3
2	1.4	1.5	2.8	4.1	4.3	5.5
3	2.5	2.7	5.0	7.6	7.8	10.1
4	1.4	1.6	2.9	4.4	4.5	5.8
6	1.8	2.0	3.6	5.5	5.6	7.3
10	1.9	2.1	3.9	5.9	6.1	7.8
12	2.8	3.2	5.9	8.7	9.0	11.5
13	2.5	2.9	5.3	7.8	8.1	10.3
15	2.1	2.4	4.4	6.5	6.7	8.6
16	2.2	2.6	4.7	6.9	7.2	9.1
20	3.2	3.6	6.6	9.8	10.1	13.0
25	3.0	3.5	6.4	9.4	9.7	12.4
32	3.7	4.4	8.1	12.1	12.5	15.8
40	3.4	4.1	7.5	11.2	11.5	14.6

*symmetrical load

Type C

	1p	1pN	2p	3p	3pN*	4p
I_n [A]	P [W]	P [W]	P [W]	P [W]	P [W]	P [W]
1	1.6	1.7	3.1	4.7	4.8	6.3
2	1.4	1.5	2.8	4.1	4.3	5.5
3	1.2	1.3	2.4	3.6	3.7	4.8
4	1.4	1.6	2.9	4.4	4.5	5.8
6	1.5	1.6	2.9	4.4	4.6	5.9
10	1.5	1.7	3.0	4.6	4.7	6.1
12	2.1	2.4	4.4	6.5	6.8	8.6
13	2.5	2.9	5.3	7.8	8.1	10.3
15	2.1	2.4	4.4	6.5	6.7	8.6
16	2.2	2.6	4.7	6.9	7.2	9.1
20	3.2	3.6	6.6	9.8	10.1	13.0
25	3.0	3.5	6.4	9.4	9.7	12.4
32	3.7	4.4	8.1	12.1	12.5	15.8
40	3.4	4.1	7.5	11.2	11.5	14.6

*symmetrical load

Type D

	1p	1pN	2p	3p	3pN*	4p
I_n [A]	P [W]	P [W]	P [W]	P [W]	P [W]	P [W]
1	0.8	0.9	1.6	2.4	2.5	3.2
2	1.0	1.1	2.0	3.0	3.1	4.0
3	1.2	1.3	2.4	3.6	3.7	4.8
4	1.4	1.6	2.9	4.4	4.5	5.8
6	1.5	1.6	2.9	4.4	4.6	5.9
10	1.5	1.7	3.0	4.6	4.7	6.1
12	1.7	2.0	3.6	5.3	5.4	7.0
13	1.9	2.2	4.0	5.9	6.1	7.8
15	2.1	2.4	4.4	6.5	6.7	8.6
16	2.2	2.6	4.7	6.9	7.2	9.1
20	2.0	2.2	4.1	6.1	6.2	8.1
25	2.5	2.9	5.2	7.7	7.9	10.2
32	3.4	4.0	7.4	11.1	11.4	14.5
40	3.2	3.8	7.0	10.4	10.7	13.6

*symmetrical load

Influence of Ambient Temperature FAZ-T

On Load Carrying Capacity (temperature derating)

I_N [A]	Ambient temperature T [°C]																
	-40	-30	-20	-10	0	10	20	30	35	40	45	50	55	60	65	70	75
1	1.3	1.2	1.2	1.2	1.1	1.1	1	1	0.99	0.97	0.95	0.93	0.9	0.89	0.87	0.85	0.83
2	2.6	2.5	2.4	2.3	2.2	2.2	2.1	2	2	1.9	1.9	1.9	1.8	1.8	1.7	1.7	1.7
3	3.8	3.7	3.6	3.5	3.4	3.3	3.1	3	3	2.9	2.8	2.8	2.7	2.7	2.6	2.5	2.5
4	5.1	5	4.8	4.7	4.5	4.3	4.2	4	3.9	3.9	3.8	3.7	3.6	3.5	3.5	3.4	3.3
6	7.7	7.5	7.2	7	6.7	6.5	6.3	6	5.9	5.8	5.7	5.6	5.4	5.3	5.2	5.1	5
10	13	12	12	12	11	11	10	10	9.9	9.7	9.5	9.3	9	8.9	8.7	8.5	8.3
12	15	15	14	14	13	13	13	12	12	12	11	11	11	11	10	10	10
13	17	16	16	15	15	14	14	13	13	13	12	12	12	12	11	11	11
15	19	19	18	17	17	16	16	15	15	15	14	14	14	13	13	13	12
16	20	20	19	19	18	17	17	16	16	15	15	15	14	14	14	14	13
20	26	25	24	23	22	22	21	20	20	19	19	19	18	18	17	17	17
25	32	31	30	29	28	27	26	25	25	24	24	23	23	22	22	21	21
32	41	40	38	37	36	35	33	32	32	31	30	30	29	28	28	27	26
40	51	50	48	47	45	43	42	40	39	39	38	37	36	35	35	34	33

Maximum Let-Through Energy FAZ-T

Type B

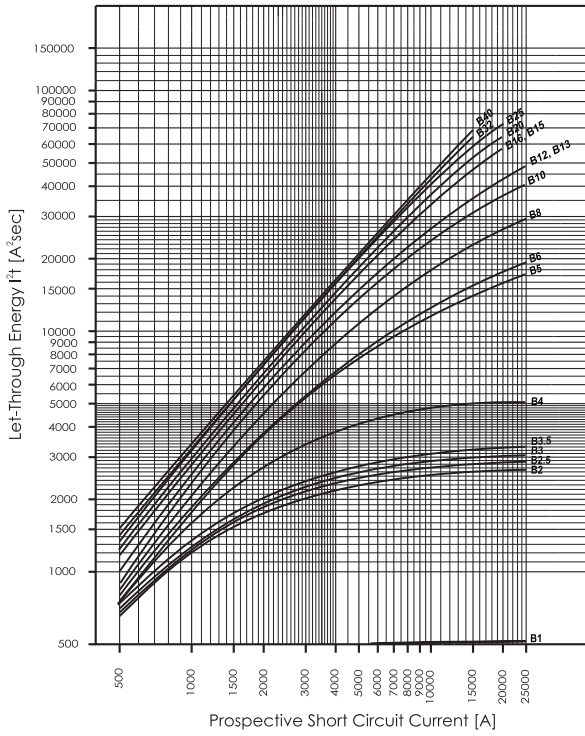

Type C

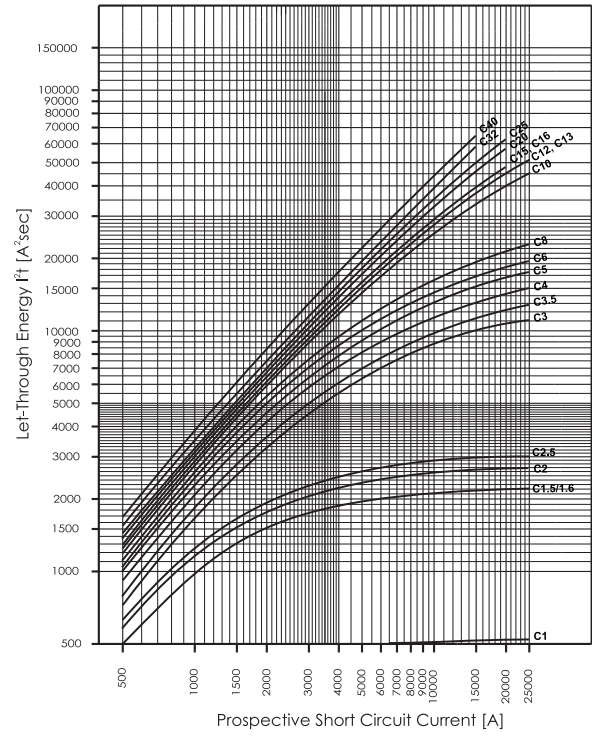

Type D

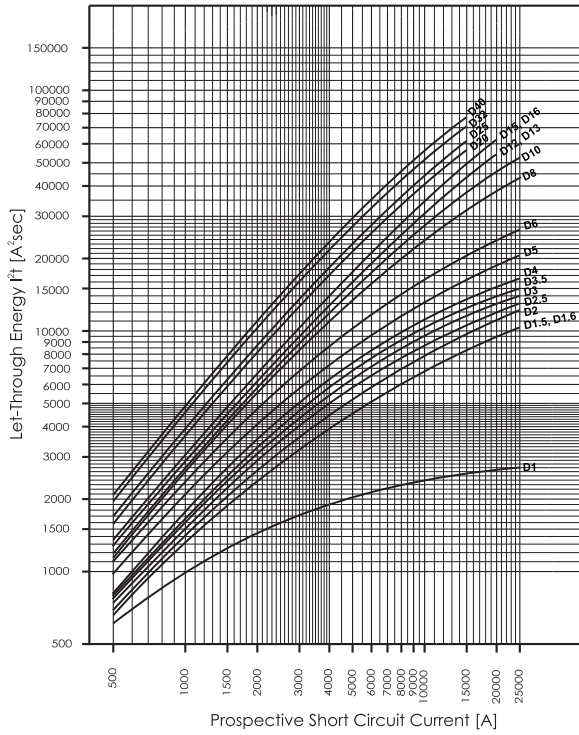

Maximum Let-Through Current FAZ-T

Type B

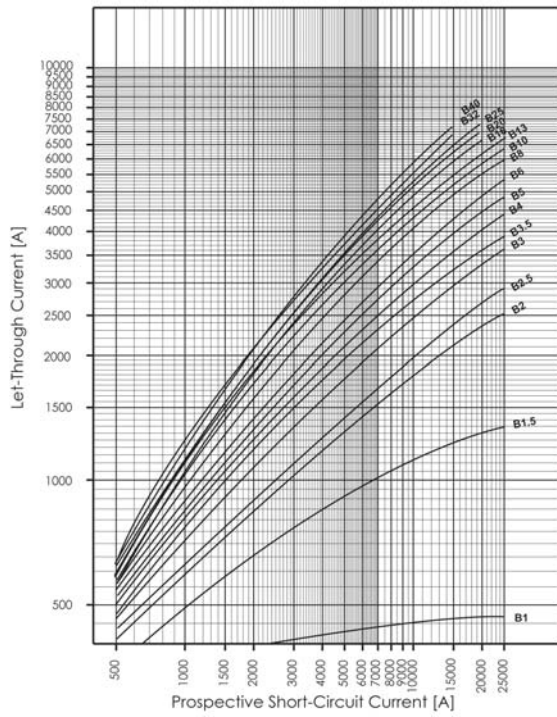

Type C

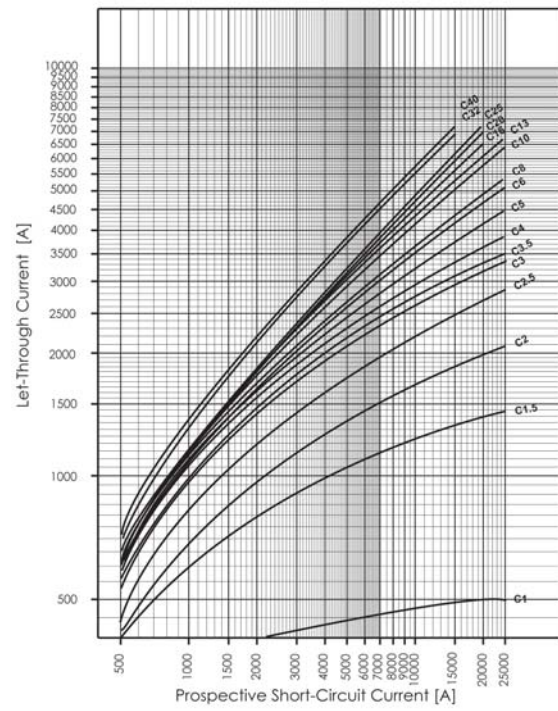

Type D

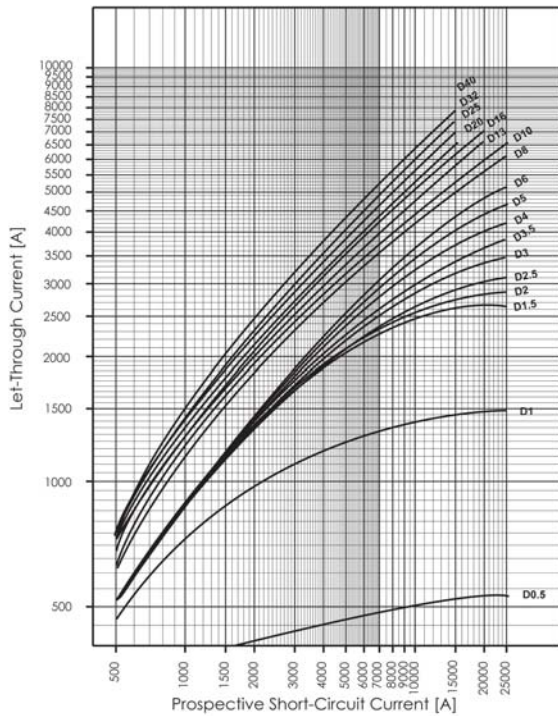

Influence of the Line Frequency FAZ-T

On the Instantaneous Tripping Current I_{MA}

	Line Frequency f [Hz]						
	$16\frac{2}{3}$	50	60	100	200	300	400
$I_{MA}(f)/I_{MA}(50\text{Hz})$ [%]	91	100	101	106	115	134	141

Load rating in case of circuit breakers arranged one next to the other FAZ-T

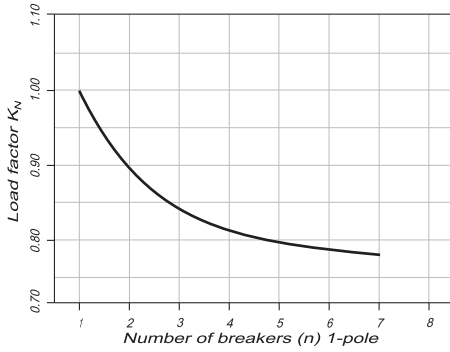

Miniature Circuit Breakers FAZ-DC

SG53312





FAZ-DC

- High-quality miniature circuit breakers for DC-applications
- Contact position indicator red - green
- Guide for secure terminal connection (not for FAZ-NA)
- 3-position DIN rail clip, permits removal from existing busbar system
- Comprehensive range of accessories suitable for subsequent installation
- Rated currents up to 50 A
- Tripping characteristic C
- Rated breaking capacity 10 kA according to IEC/EN 60947-2
- Up to 250 V DC pro pole

FAZ-...-DC Miniature Circuit Breakers (MCBs)

Characteristic C

	Rated current I_n (A)	Rated voltage IEC/EN 60947-2 (V DC)	Breaking capacity acc. to IEC/EN 60947-2 (kA)	Type Designation	Article No.	Units per package
1-pole						
	2	220	10	FAZ-C2/1-DC	279122	12/120
	3	250	10	FAZ-C3/1-DC	279123	12/120
	4	250	10	FAZ-C4/1-DC	279124	12/120
	6	250	10	FAZ-C6/1-DC	279125	12/120
	10	250	10	FAZ-C10/1-DC	279126	12/120
	13	250	10	FAZ-C13/1-DC	279127	12/120
	16	250	10	FAZ-C16/1-DC	279128	12/120
	20	250	10	FAZ-C20/1-DC	279129	12/120
	25	250	10	FAZ-C25/1-DC	279130	12/120
	32	250	10	FAZ-C32/1-DC	279131	12/120
	40	250	10	FAZ-C40/1-DC	279132	12/120
	50	250	10	FAZ-C50/1-DC	279133	12/120
2-pole						
	2	440	10	FAZ-C2/2-DC	279134	1/60
	3	500	10	FAZ-C3/2-DC	279135	1/60
	4	500	10	FAZ-C4/2-DC	279136	1/60
	6	500	10	FAZ-C6/2-DC	279137	1/60
	10	500	10	FAZ-C10/2-DC	279138	1/60
	13	500	10	FAZ-C13/2-DC	279139	1/60
	16	500	10	FAZ-C16/2-DC	279140	1/60
	20	500	10	FAZ-C20/2-DC	279141	1/60
	25	500	10	FAZ-C25/2-DC	279142	1/60
	32	500	10	FAZ-C32/2-DC	279143	1/60
	40	500	10	FAZ-C40/2-DC	279144	1/60
	50	500	10	FAZ-C50/2-DC	279145	1/60

Specifications FAZ-DC

Technical data

	FAZ-DC *)
Productstandard	IEC/EN 60947-2
Number of poles	1, 2

Mechanical specifications

Device width	17.7 mm (1p), 36 mm (2p)
Frame size	45 mm
Socket size	80 mm
Device depth	60 mm
Terminals	lift terminal
Terminal capacity rigid solid/stranded wire	1-25 mm ²
Terminal screw	M5 (with slotted screw acc. to EN ISO 4757-Z2, PZ2)
Terminal torque	max. 2.4 Nm
Snap on fixing	tristable (on DIN rail acc. to EN 50022)
Finger proof	acc. to VBG4, ÖVE EN-6
Degree of Protection (DIN VDE 0470)	
Surface mounted	IP 20
Built-in behind panel	IP 40
Contact position indicator	red / green

Electrical specifications

Rated voltage DC	U_n	2 A type: 220V (per pole) 3-50 A types: 250V (per pole)
Rated current	I_n	Type C: 2, 3, 4, 6, 10, 13, 16, 20, 25, 32, 40, 50 A
Rated insulation voltage	U_i	440 V
Rated impulse withstand voltage	U_{imp}	4 kV (1.2/50)µsec

Tripping characteristic

Conventional non-tripping current		$I_{nt}=1.13 I_n$
Conventional tripping current		$I_t=1.45 I_n$
Reference temperature		30 °C
Temperature factor		0.4% /K
Instantaneous tripping current	I_{mt}	type C: $7 I_n < I_{mt} = 15 I_n$; $t(I_{mt}) < 0.1$ sec
Rated short-circuit braking capacity	I_{cu}	10 kA
Selectivity class		3
Number of electrical operations		> 4000
Number of mechanical operations		> 20000
Climatic conditions		acc. to IEC 68-2 (25..55°C / 90..95% RH)
Operating temperature range		-40°C to +75°C

*) not for PV string protection!

Connection diagram

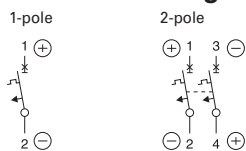

Dimensions (mm) FAZ-...-DC

1-pole

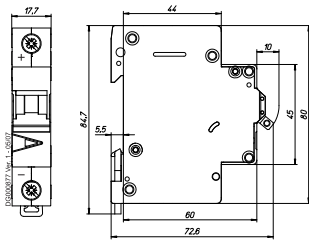

2-pole

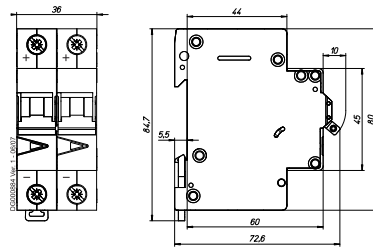

Connection examples FAZ-...-DC

Connection example at 250V=, 1-pole

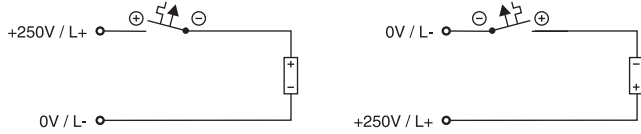

Connection example at 500V=, 2-pole

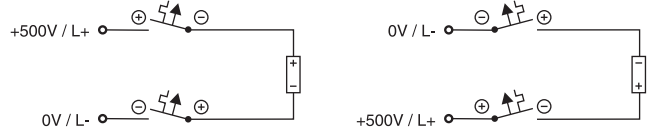

Tripping Characteristic FAZ-...-DC

Characteristics C - IEC/EN 60947-2

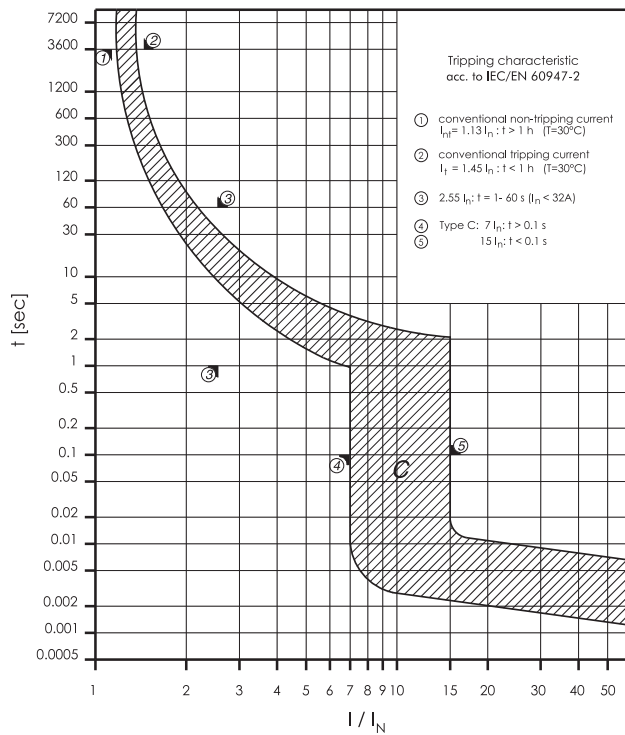

Maximum Let-Through Energy FAZ-...-DC

Type C

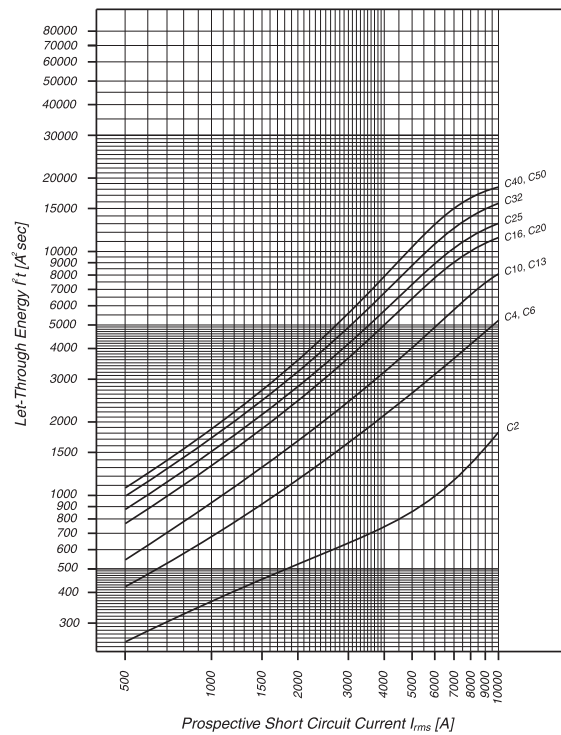

Miniature Circuit Breakers FAZ-NA, FAZ-RT, FAZ-DU

SG56912



FAZ-NA/-RT/-DU

- According to UL 489, CSA C22.2 No. 5 and also IEC 60947-2 standard
- For Applications, which are permitted for UL 1077 or CSA C22.2 No. 235
- Auxiliary switch and voltage trips suitable for subsequent installation
- Series with removable terminal screws (Type FAZ-...-RT/-DU), for use with ring cable lug
- Contact position indicator red - green
- Easy mounting at DIN-rail

FAZ-...-NA Miniature Circuit Breakers (MCBs)

Characteristic B

	Rated current I_n (A)	Rated voltage IEC/EN 60947-2 (V)	Breaking capacity acc. to IEC/EN 60947-2 (kA)	Rated voltage UL489 (V)	Breaking capacity acc. to UL489 (kA)	SWD	NFPA 79	Type Designation	Article No.	Units per package
1-pole										
1	240/415	15	277	10	SWD	AWG 18	FAZ-B1/1-NA	132414	12/120	
1.5	240/415	15	277	10	SWD	AWG 18	FAZ-B1,5/1-NA	132415	12/120	
2	240/415	15	277	10	SWD	AWG 18	FAZ-B2/1-NA	132416	12/120	
3	240/415	15	277	10	SWD	AWG 18	FAZ-B3/1-NA	132417	12/120	
4	240/415	15	277	10	SWD	AWG 18	FAZ-B4/1-NA	132418	12/120	
5	240/415	15	277	10	SWD	AWG 18	FAZ-B5/1-NA	132419	12/120	
6	240/415	15	277	10	SWD	AWG 18	FAZ-B6/1-NA	132680	12/120	
7	240/415	15	277	10	SWD	AWG 18	FAZ-B7/1-NA	132681	12/120	
8	240/415	15	277	10	SWD	AWG 16	FAZ-B8/1-NA	132682	12/120	
10	240/415	15	277	10	SWD	AWG 16	FAZ-B10/1-NA	132683	12/120	
13	240/415	15	277	10	SWD		FAZ-B13/1-NA	132684	12/120	
15	240/415	15	277	14	SWD		FAZ-B15/1-NA	132685	12/120	
16	240/415	15	277	14	SWD		FAZ-B16/1-NA	132686	12/120	
20	240/415	15	277	14	SWD		FAZ-B20/1-NA	132687	12/120	
25	240/415	15	277	14			FAZ-B25/1-NA	132688	12/120	
30	240/415	15	277	10			FAZ-B30/1-NA	132689	12/120	
32	240/415	15	277	10			FAZ-B32/1-NA	132690	12/120	
35	240/415	15	240	10			FAZ-B35/1-NA	132691	12/120	
40	240/415	15	240	10			FAZ-B40/1-NA	132692	12/120	
2-pole										
1	415	15	480Y/277	10	SWD	AWG 18	FAZ-B1/2-NA	132693	1/60	
1.5	415	15	480Y/277	10	SWD	AWG 18	FAZ-B1,5/2-NA	132694	1/60	
2	415	15	480Y/277	10	SWD	AWG 18	FAZ-B2/2-NA	132695	1/60	
3	415	15	480Y/277	10	SWD	AWG 18	FAZ-B3/2-NA	132696	1/60	
4	415	15	480Y/277	10	SWD	AWG 18	FAZ-B4/2-NA	132697	1/60	
5	415	15	480Y/277	10	SWD	AWG 18	FAZ-B5/2-NA	132698	1/60	
6	415	15	480Y/277	10	SWD	AWG 18	FAZ-B6/2-NA	132699	1/60	
7	415	15	480Y/277	10	SWD	AWG 18	FAZ-B7/2-NA	132700	1/60	
8	415	15	480Y/277	10	SWD	AWG 16	FAZ-B8/2-NA	132701	1/60	
10	415	15	480Y/277	10	SWD	AWG 16	FAZ-B10/2-NA	132702	1/60	
13	415	15	480Y/277	10	SWD		FAZ-B13/2-NA	132703	1/60	
15	415	15	480Y/277	14	SWD		FAZ-B15/2-NA	132704	1/60	
16	415	15	480Y/277	14	SWD		FAZ-B16/2-NA	132705	1/60	
20	415	15	480Y/277	14	SWD		FAZ-B20/2-NA	132706	1/60	
25	415	15	480Y/277	14			FAZ-B25/2-NA	132707	1/60	
30	415	15	480Y/277	10			FAZ-B30/2-NA	132708	1/60	
32	415	15	480Y/277	10			FAZ-B32/2-NA	132709	1/60	
35	415	15	240	10			FAZ-B35/2-NA	132710	1/60	
40	415	15	240	10			FAZ-B40/2-NA	132711	1/60	
3-pole										
1	415	15	480Y/277	10	SWD	AWG 18	FAZ-B1/3-NA	132712	1/40	
1.5	415	15	480Y/277	10	SWD	AWG 18	FAZ-B1,5/3-NA	132713	1/40	
2	415	15	480Y/277	10	SWD	AWG 18	FAZ-B2/3-NA	132714	1/40	
3	415	15	480Y/277	10	SWD	AWG 18	FAZ-B3/3-NA	132715	1/40	
4	415	15	480Y/277	10	SWD	AWG 18	FAZ-B4/3-NA	132716	1/40	
5	415	15	480Y/277	10	SWD	AWG 18	FAZ-B5/3-NA	132717	1/40	
6	415	15	480Y/277	10	SWD	AWG 18	FAZ-B6/3-NA	132718	1/40	
7	415	15	480Y/277	10	SWD	AWG 18	FAZ-B7/3-NA	132719	1/40	
8	415	15	480Y/277	10	SWD	AWG 16	FAZ-B8/3-NA	132720	1/40	
10	415	15	480Y/277	10	SWD	AWG 16	FAZ-B10/3-NA	132721	1/40	
13	415	15	480Y/277	10	SWD		FAZ-B13/3-NA	132722	1/40	
15	415	15	480Y/277	14	SWD		FAZ-B15/3-NA	132723	1/40	
16	415	15	480Y/277	14	SWD		FAZ-B16/3-NA	132724	1/40	
20	415	15	480Y/277	14	SWD		FAZ-B20/3-NA	132725	1/40	
25	415	15	480Y/277	14			FAZ-B25/3-NA	132726	1/40	
30	415	15	480Y/277	10			FAZ-B30/3-NA	132727	1/40	
32	415	15	480Y/277	10			FAZ-B32/3-NA	132728	1/40	
35	415	15	240	10			FAZ-B35/3-NA	132729	1/40	
40	415	15	240	10			FAZ-B40/3-NA	132730	1/40	

SG53012



SG56812



SG56912



FAZ...-NA Miniature Circuit Breakers (MCBs)

Characteristic C

	Rated current I_n (A)	Rated voltage IEC/EN 60947-2 (V)	Breaking capacity acc. to IEC/EN 60947-2 (kA)	Rated voltage UL489 (V)	Breaking capacity acc. to UL489 (kA)	SWD	NFPA 79	Type Designation	Article No.	Units per package
1-pole										
	0.5	240/415	15	277	10	SWD	AWG 18	FAZ-C0,5/1-NA	181883	12/120
	1	240/415	15	277	10	SWD	AWG 18	FAZ-C1/1-NA	181885	12/120
	1.5	240/415	15	277	10	SWD	AWG 18	FAZ-C1,5/1-NA	181887	12/120
	2	240/415	15	277	10	SWD	AWG 18	FAZ-C2/1-NA	181889	12/120
	3	240/415	15	277	10	SWD	AWG 18	FAZ-C3/1-NA	181891	12/120
	4	240/415	15	277	10	SWD	AWG 18	FAZ-C4/1-NA	181893	12/120
	5	240/415	15	277	10	SWD	AWG 18	FAZ-C5/1-NA	181895	12/120
	6	240/415	15	277	10	SWD	AWG 18	FAZ-C6/1-NA	181897	12/120
	7	240/415	15	277	10	SWD	AWG 18	FAZ-C7/1-NA	181899	12/120
	8	240/415	15	277	10	SWD	AWG 16	FAZ-C8/1-NA	181901	12/120
	10	240/415	15	277	10	SWD	AWG 16	FAZ-C10/1-NA	181903	12/120
	13	240/415	15	277	10	SWD		FAZ-C13/1-NA	181905	12/120
	15	240/415	15	277	14	SWD		FAZ-C15/1-NA	181907	12/120
	16	240/415	15	277	14	SWD		FAZ-C16/1-NA	181909	12/120
	20	240/415	15	277	14	SWD		FAZ-C20/1-NA	181911	12/120
	25	240/415	15	277	14			FAZ-C25/1-NA	181913	12/120
	30	240/415	15	277	10			FAZ-C30/1-NA	181915	12/120
	32	240/415	15	277	10			FAZ-C32/1-NA	181917	12/120
	35	240/415	15	240	10			FAZ-C35/1-NA	181919	12/120
	40	240/415	15	240	10			FAZ-C40/1-NA	181921	12/120
2-pole										
	0.5	415	15	480Y/277	10	SWD	AWG 18	FAZ-C0,5/2-NA	181923	1/60
	1	415	15	480Y/277	10	SWD	AWG 18	FAZ-C1/2-NA	181925	1/60
	1.5	415	15	480Y/277	10	SWD	AWG 18	FAZ-C1,5/2-NA	181927	1/60
	2	415	15	480Y/277	10	SWD	AWG 18	FAZ-C2/2-NA	181929	1/60
	3	415	15	480Y/277	10	SWD	AWG 18	FAZ-C3/2-NA	181931	1/60
	4	415	15	480Y/277	10	SWD	AWG 18	FAZ-C4/2-NA	181933	1/60
	5	415	15	480Y/277	10	SWD	AWG 18	FAZ-C5/2-NA	181935	1/60
	6	415	15	480Y/277	10	SWD	AWG 18	FAZ-C6/2-NA	181937	1/60
	7	415	15	480Y/277	10	SWD	AWG 18	FAZ-C7/2-NA	181939	1/60
	8	415	15	480Y/277	10	SWD	AWG 16	FAZ-C8/2-NA	181941	1/60
	10	415	15	480Y/277	10	SWD	AWG 16	FAZ-C10/2-NA	181943	1/60
	13	415	15	480Y/277	10	SWD		FAZ-C13/2-NA	181945	1/60
	15	415	15	480Y/277	14	SWD		FAZ-C15/2-NA	181947	1/60
	16	415	15	480Y/277	14	SWD		FAZ-C16/2-NA	181949	1/60
	20	415	15	480Y/277	14	SWD		FAZ-C20/2-NA	181951	1/60
	25	415	15	480Y/277	14			FAZ-C25/2-NA	181953	1/60
	30	415	15	480Y/277	10			FAZ-C30/2-NA	181955	1/60
	32	415	15	480Y/277	10			FAZ-C32/2-NA	181957	1/60
	35	415	15	240	10			FAZ-C35/2-NA	181959	1/60
	40	415	15	240	10			FAZ-C40/2-NA	181961	1/60
3-pole										
	0.5	415	15	480Y/277	10	SWD	AWG 18	FAZ-C0,5/3-NA	181963	1/40
	1	415	15	480Y/277	10	SWD	AWG 18	FAZ-C1/3-NA	181965	1/40
	1.5	415	15	480Y/277	10	SWD	AWG 18	FAZ-C1,5/3-NA	181967	1/40
	2	415	15	480Y/277	10	SWD	AWG 18	FAZ-C2/3-NA	181969	1/40
	3	415	15	480Y/277	10	SWD	AWG 18	FAZ-C3/3-NA	181971	1/40
	4	415	15	480Y/277	10	SWD	AWG 18	FAZ-C4/3-NA	181973	1/40
	5	415	15	480Y/277	10	SWD	AWG 18	FAZ-C5/3-NA	181975	1/40
	6	415	15	480Y/277	10	SWD	AWG 18	FAZ-C6/3-NA	181977	1/40
	7	415	15	480Y/277	10	SWD	AWG 18	FAZ-C7/3-NA	181979	1/40
	8	415	15	480Y/277	10	SWD	AWG 16	FAZ-C8/3-NA	181981	1/40
	10	415	15	480Y/277	10	SWD	AWG 16	FAZ-C10/3-NA	181983	1/40
	13	415	15	480Y/277	10	SWD		FAZ-C13/3-NA	181985	1/40
	15	415	15	480Y/277	14	SWD		FAZ-C15/3-NA	181987	1/40
	16	415	15	480Y/277	14	SWD		FAZ-C16/3-NA	181989	1/40
	20	415	15	480Y/277	14	SWD		FAZ-C20/3-NA	181991	1/40
	25	415	15	480Y/277	14			FAZ-C25/3-NA	181993	1/40
	30	415	15	480Y/277	10			FAZ-C30/3-NA	181995	1/40
	32	415	15	480Y/277	10			FAZ-C32/3-NA	181997	1/40
	35	415	15	240	10			FAZ-C35/3-NA	181999	1/40
	40	415	15	240	10			FAZ-C40/3-NA	182001	1/40

SG53012



SG56812



SG56912



FAZ-...-NA Miniature Circuit Breakers (MCBs)

Characteristic D

	Rated current I_n (A)	Rated voltage IEC/EN 60947-2 (V)	Breaking capacity acc. to IEC/EN 60947-2 (kA)	Rated voltage UL489 (V)	Breaking capacity acc. to UL489 (kA)	SWD	NFPA 79	Type Designation	Article No.	Units per package
1-pole										
	0.5	240/415	15	277	10	SWD	AWG 18	FAZ-D0,5/1-NA	182003	12/120
	1	240/415	15	277	10	SWD	AWG 18	FAZ-D1/1-NA	182005	12/120
	1.5	240/415	15	277	10	SWD	AWG 18	FAZ-D1,5/1-NA	182007	12/120
	2	240/415	15	277	10	SWD	AWG 18	FAZ-D2/1-NA	182009	12/120
	3	240/415	15	277	10	SWD	AWG 18	FAZ-D3/1-NA	182011	12/120
	4	240/415	15	277	10	SWD	AWG 18	FAZ-D4/1-NA	182013	12/120
	5	240/415	15	277	10	SWD	AWG 18	FAZ-D5/1-NA	182015	12/120
	6	240/415	15	277	10	SWD	AWG 18	FAZ-D6/1-NA	182017	12/120
	7	240/415	15	277	10	SWD	AWG 18	FAZ-D7/1-NA	182019	12/120
	8	240/415	15	277	10	SWD	AWG 16	FAZ-D8/1-NA	182021	12/120
	10	240/415	15	277	10	SWD	AWG 16	FAZ-D10/1-NA	181831	12/120
	13	240/415	15	277	14	SWD		FAZ-D13/1-NA	181833	12/120
	15	240/415	15	277	14	SWD		FAZ-D15/1-NA	181835	12/120
	16	240/415	15	277	14	SWD		FAZ-D16/1-NA	181837	12/120
	20	240/415	15	277	14	SWD		FAZ-D20/1-NA	181839	12/120
	25	240/415	15	277	10			FAZ-D25/1-NA	181841	12/120
	30	240/415	15	277	10			FAZ-D30/1-NA	182023	12/120
	32	240/415	15	277	10			FAZ-D32/1-NA	182025	12/120
	35	240/415	15	240	10			FAZ-D35/1-NA	182027	12/120
	40	240/415	15	240	10			FAZ-D40/1-NA	182029	12/120
2-pole										
	0.5	415	15	480Y/277	10	SWD	AWG 18	FAZ-D0,5/2-NA	182031	1/60
	1	415	15	480Y/277	10	SWD	AWG 18	FAZ-D1/2-NA	182033	1/60
	1.5	415	15	480Y/277	10	SWD	AWG 18	FAZ-D1,5/2-NA	182035	1/60
	2	415	15	480Y/277	10	SWD	AWG 18	FAZ-D2/2-NA	182037	1/60
	3	415	15	480Y/277	10	SWD	AWG 18	FAZ-D3/2-NA	182039	1/60
	4	415	15	480Y/277	10	SWD	AWG 18	FAZ-D4/2-NA	182041	1/60
	5	415	15	480Y/277	10	SWD	AWG 18	FAZ-D5/2-NA	182043	1/60
	6	415	15	480Y/277	10	SWD	AWG 18	FAZ-D6/2-NA	182045	1/60
	7	415	15	480Y/277	10	SWD	AWG 18	FAZ-D7/2-NA	182047	1/60
	8	415	15	480Y/277	10	SWD	AWG 16	FAZ-D8/2-NA	182049	1/60
	10	415	15	480Y/277	10	SWD	AWG 16	FAZ-D10/2-NA	182051	1/60
	13	415	15	480Y/277	14	SWD		FAZ-D13/2-NA	182053	1/60
	15	415	15	480Y/277	14	SWD		FAZ-D15/2-NA	182055	1/60
	16	415	15	480Y/277	14	SWD		FAZ-D16/2-NA	182057	1/60
	20	415	15	480Y/277	14	SWD		FAZ-D20/2-NA	182059	1/60
	25	415	15	480Y/277	10			FAZ-D25/2-NA	182061	1/60
	30	415	15	480Y/277	10			FAZ-D30/2-NA	182063	1/60
	32	415	15	480Y/277	10			FAZ-D32/2-NA	182065	1/60
	35	415	15	240	10			FAZ-D35/2-NA	182067	1/60
	40	415	15	240	10			FAZ-D40/2-NA	182069	1/60
3-pole										
	0.5	415	15	480Y/277	10	SWD	AWG 18	FAZ-D0,5/3-NA	182071	1/40
	1	415	15	480Y/277	10	SWD	AWG 18	FAZ-D1/3-NA	182073	1/40
	1.5	415	15	480Y/277	10	SWD	AWG 18	FAZ-D1,5/3-NA	182075	1/40
	2	415	15	480Y/277	10	SWD	AWG 18	FAZ-D2/3-NA	182077	1/40
	3	415	15	480Y/277	10	SWD	AWG 18	FAZ-D3/3-NA	182079	1/40
	4	415	15	480Y/277	10	SWD	AWG 18	FAZ-D4/3-NA	182081	1/40
	5	415	15	480Y/277	10	SWD	AWG 18	FAZ-D5/3-NA	182083	1/40
	6	415	15	480Y/277	10	SWD	AWG 18	FAZ-D6/3-NA	182085	1/40
	7	415	15	480Y/277	10	SWD	AWG 18	FAZ-D7/3-NA	182087	1/40
	8	415	15	480Y/277	10	SWD	AWG 16	FAZ-D8/3-NA	182089	1/40
	10	415	15	480Y/277	10	SWD	AWG 16	FAZ-D10/3-NA	182091	1/40
	13	415	15	480Y/277	14	SWD		FAZ-D13/3-NA	182093	1/40
	15	415	15	480Y/277	14	SWD		FAZ-D15/3-NA	182095	1/40
	16	415	15	480Y/277	14	SWD		FAZ-D16/3-NA	182097	1/40
	20	415	15	480Y/277	14	SWD		FAZ-D20/3-NA	182099	1/40
	25	415	15	480Y/277	10			FAZ-D25/3-NA	182101	1/40
	30	415	15	480Y/277	10			FAZ-D30/3-NA	182103	1/40
	32	415	15	480Y/277	10			FAZ-D32/3-NA	182105	1/40
	35	415	15	240	10			FAZ-D35/3-NA	182107	1/40
	40	415	15	240	10			FAZ-D40/3-NA	182109	1/40

SG53012



SG56812



SG56912



FAZ...-RT/-DU Miniature Circuit Breakers (MCBs)

Characteristic B

	Rated current I_n (A)	Rated voltage IEC/EN 60947-2 (V)	Breaking capacity acc. to IEC/EN 60947-2 (kA)	Rated voltage UL489 (V)	Breaking capacity acc. to UL489 (kA)	SWD	NFPA 79	Type Designation	Article No.	Units per package
1-pole										
1	240/415	15	277	10	SWD	AWG 18	FAZ-B1/1-RT	132731	12/120	
1.5	240/415	15	277	10	SWD	AWG 18	FAZ-B1,5/1-RT	132732	12/120	
2	240/415	15	277	10	SWD	AWG 18	FAZ-B2/1-RT	132733	12/120	
3	240/415	15	277	10	SWD	AWG 18	FAZ-B3/1-RT	132734	12/120	
4	240/415	15	277	10	SWD	AWG 18	FAZ-B4/1-RT	132735	12/120	
5	240/415	15	277	10	SWD	AWG 18	FAZ-B5/1-RT	132736	12/120	
6	240/415	15	277	10	SWD	AWG 18	FAZ-B6/1-RT	132737	12/120	
7	240/415	15	277	10	SWD	AWG 18	FAZ-B7/1-RT	132738	12/120	
8	240/415	15	277	10	SWD	AWG 16	FAZ-B8/1-RT	132739	12/120	
10	240/415	15	277	10	SWD	AWG 16	FAZ-B10/1-RT	132740	12/120	
13	240/415	15	277	10	SWD		FAZ-B13/1-RT	132741	12/120	
15	240/415	15	277	14	SWD		FAZ-B15/1-RT	132742	12/120	
16	240/415	15	277	14	SWD		FAZ-B16/1-RT	132743	12/120	
20	240/415	15	277	14	SWD		FAZ-B20/1-RT	132744	12/120	
25	240/415	15	277	14			FAZ-B25/1-RT	132745	12/120	
30	240/415	15	277	10			FAZ-B30/1-RT	132746	12/120	
32	240/415	15	277	10			FAZ-B32/1-RT	132747	12/120	
35	240/415	15	240	10			FAZ-B35/1-RT	132748	12/120	
40	240/415	15	240	10			FAZ-B40/1-RT	132749	12/120	
2-pole										
1	415	15	480Y/277	10	SWD	AWG 18	FAZ-B1/2-RT	132750	1/60	
1.5	415	15	480Y/277	10	SWD	AWG 18	FAZ-B1,5/2-RT	132751	1/60	
2	415	15	480Y/277	10	SWD	AWG 18	FAZ-B2/2-RT	132752	1/60	
3	415	15	480Y/277	10	SWD	AWG 18	FAZ-B3/2-RT	132753	1/60	
4	415	15	480Y/277	10	SWD	AWG 18	FAZ-B4/2-RT	132754	1/60	
5	415	15	480Y/277	10	SWD	AWG 18	FAZ-B5/2-RT	132755	1/60	
6	415	15	480Y/277	10	SWD	AWG 18	FAZ-B6/2-RT	132756	1/60	
7	415	15	480Y/277	10	SWD	AWG 18	FAZ-B7/2-RT	132757	1/60	
8	415	15	480Y/277	10	SWD	AWG 16	FAZ-B8/2-RT	132758	1/60	
10	415	15	480Y/277	10	SWD	AWG 16	FAZ-B10/2-RT	132759	1/60	
13	415	15	480Y/277	10	SWD		FAZ-B13/2-RT	132760	1/60	
15	415	15	480Y/277	14	SWD		FAZ-B15/2-RT	132761	1/60	
16	415	15	480Y/277	14	SWD		FAZ-B16/2-RT	132762	1/60	
20	415	15	480Y/277	14	SWD		FAZ-B20/2-RT	132763	1/60	
25	415	15	480Y/277	14			FAZ-B25/2-RT	132764	1/60	
30	415	15	480Y/277	10			FAZ-B30/2-RT	132765	1/60	
32	415	15	480Y/277	10			FAZ-B32/2-RT	132766	1/60	
35	415	15	240	10			FAZ-B35/2-RT	132767	1/60	
40	415	15	240	10			FAZ-B40/2-RT	132768	1/60	
3-pole										
1	415	15	480Y/277	10	SWD	AWG 18	FAZ-B1/3-RT	132769	1/40	
1.5	415	15	480Y/277	10	SWD	AWG 18	FAZ-B1,5/3-RT	132770	1/40	
2	415	15	480Y/277	10	SWD	AWG 18	FAZ-B2/3-RT	132771	1/40	
3	415	15	480Y/277	10	SWD	AWG 18	FAZ-B3/3-RT	132772	1/40	
4	415	15	480Y/277	10	SWD	AWG 18	FAZ-B4/3-RT	132773	1/40	
5	415	15	480Y/277	10	SWD	AWG 18	FAZ-B5/3-RT	132774	1/40	
6	415	15	480Y/277	10	SWD	AWG 18	FAZ-B6/3-RT	132775	1/40	
7	415	15	480Y/277	10	SWD	AWG 18	FAZ-B7/3-RT	132776	1/40	
8	415	15	480Y/277	10	SWD	AWG 16	FAZ-B8/3-RT	132777	1/40	
10	415	15	480Y/277	10	SWD	AWG 16	FAZ-B10/3-RT	132778	1/40	
13	415	15	480Y/277	10	SWD		FAZ-B13/3-RT	132779	1/40	
15	415	15	480Y/277	14	SWD		FAZ-B15/3-RT	132780	1/40	
16	415	15	480Y/277	14	SWD		FAZ-B16/3-RT	132781	1/40	
20	415	15	480Y/277	14	SWD		FAZ-B20/3-RT	132782	1/40	
25	415	15	480Y/277	14			FAZ-B25/3-RT	132783	1/40	
30	415	15	480Y/277	10			FAZ-B30/3-RT	132784	1/40	
32	415	15	480Y/277	10			FAZ-B32/3-RT	132785	1/40	
35	415	15	240	10			FAZ-B35/3-RT	132786	1/40	
40	415	15	240	10			FAZ-B40/3-RT	132787	1/40	

SG56412



SG56712



SG57012



FAZ...-RT/-DU Miniature Circuit Breakers (MCBs)

Characteristic C



FAZ-RT has the plastic limiter at both terminals, as showed in red circle; While FAZ-DU doesn't have

SG56412



Rated current I_n (A)	Rated voltage IEC/EN 60947-2 (V)	Breaking capacity acc. to IEC/EN 60947-2 (kA)	Rated voltage UL489 (V)	Breaking capacity acc. to UL489 (kA)	SWD	NFPA 79	RT Type Designation	RT Article No.	DU Type Designation	DU Article No.	Units per package
----------------------------	---	---	-------------------------------	---	-----	---------	------------------------	-------------------	------------------------	-------------------	-------------------------

1-pole

0.5	240/415	15	277	10	SWD	AWG 18	FAZ-C0,5/1-RT	181884	FAZ-C0,5/1-DU	185095	12/120
1	240/415	15	277	10	SWD	AWG 18	FAZ-C1/1-RT	181886	FAZ-C1/1-DU	185096	12/120
1.5	240/415	15	277	10	SWD	AWG 18	FAZ-C1,5/1-RT	181888	FAZ-C1,5/1-DU	185097	12/120
2	240/415	15	277	10	SWD	AWG 18	FAZ-C2/1-RT	181890	FAZ-C2/1-DU	185098	12/120
3	240/415	15	277	10	SWD	AWG 18	FAZ-C3/1-RT	181892	FAZ-C3/1-DU	185099	12/120
4	240/415	15	277	10	SWD	AWG 18	FAZ-C4/1-RT	181894	FAZ-C4/1-DU	185100	12/120
5	240/415	15	277	10	SWD	AWG 18	FAZ-C5/1-RT	181896	FAZ-C5/1-DU	185101	12/120
6	240/415	15	277	10	SWD	AWG 18	FAZ-C6/1-RT	181898	FAZ-C6/1-DU	185102	12/120
7	240/415	15	277	10	SWD	AWG 18	FAZ-C7/1-RT	181900	FAZ-C7/1-DU	185103	12/120
8	240/415	15	277	10	SWD	AWG 16	FAZ-C8/1-RT	181902	FAZ-C8/1-DU	184990	12/120
10	240/415	15	277	10	SWD	AWG 16	FAZ-C10/1-RT	181904	FAZ-C10/1-DU	184991	12/120
13	240/415	15	277	10	SWD		FAZ-C13/1-RT	181906	FAZ-C13/1-DU	184992	12/120
15	240/415	15	277	14	SWD		FAZ-C15/1-RT	181908	FAZ-C15/1-DU	184993	12/120
16	240/415	15	277	14	SWD		FAZ-C16/1-RT	181910	FAZ-C16/1-DU	184994	12/120
20	240/415	15	277	14	SWD		FAZ-C20/1-RT	181912	FAZ-C20/1-DU	184995	12/120
25	240/415	15	277	14			FAZ-C25/1-RT	181914	FAZ-C25/1-DU	184996	12/120
30	240/415	15	277	10			FAZ-C30/1-RT	181916	FAZ-C30/1-DU	184997	12/120
32	240/415	15	277	10			FAZ-C32/1-RT	181918	FAZ-C32/1-DU	184998	12/120
35	240/415	15	240	10			FAZ-C35/1-RT	181920	FAZ-C35/1-DU	184999	12/120
40	240/415	15	240	10			FAZ-C40/1-RT	181922	FAZ-C40/1-DU	185000	12/120

SG56712



2-pole

0.5	415	15	480Y/277	10	SWD	AWG 18	FAZ-C0,5/2-RT	181924	FAZ-C0,5/2-DU	185021	1/60
1	415	15	480Y/277	10	SWD	AWG 18	FAZ-C1/2-RT	181926	FAZ-C1/2-DU	185022	1/60
1.5	415	15	480Y/277	10	SWD	AWG 18	FAZ-C1,5/2-RT	181928	FAZ-C1,5/2-DU	185023	1/60
2	415	15	480Y/277	10	SWD	AWG 18	FAZ-C2/2-RT	181930	FAZ-C2/2-DU	185024	1/60
3	415	15	480Y/277	10	SWD	AWG 18	FAZ-C3/2-RT	181932	FAZ-C3/2-DU	185025	1/60
4	415	15	480Y/277	10	SWD	AWG 18	FAZ-C4/2-RT	181934	FAZ-C4/2-DU	185026	1/60
5	415	15	480Y/277	10	SWD	AWG 18	FAZ-C5/2-RT	181936	FAZ-C5/2-DU	185027	1/60
6	415	15	480Y/277	10	SWD	AWG 18	FAZ-C6/2-RT	181938	FAZ-C6/2-DU	185028	1/60
7	415	15	480Y/277	10	SWD	AWG 18	FAZ-C7/2-RT	181940	FAZ-C7/2-DU	185029	1/60
8	415	15	480Y/277	10	SWD	AWG 16	FAZ-C8/2-RT	181942	FAZ-C8/2-DU	185030	1/60
10	415	15	480Y/277	10	SWD	AWG 16	FAZ-C10/2-RT	181944	FAZ-C10/2-DU	185031	1/60
13	415	15	480Y/277	10	SWD		FAZ-C13/2-RT	181946	FAZ-C13/2-DU	185032	1/60
15	415	15	480Y/277	14	SWD		FAZ-C15/2-RT	181948	FAZ-C15/2-DU	185033	1/60
16	415	15	480Y/277	14	SWD		FAZ-C16/2-RT	181950	FAZ-C16/2-DU	185034	1/60
20	415	15	480Y/277	14	SWD		FAZ-C20/2-RT	181952	FAZ-C20/2-DU	185035	1/60
25	415	15	480Y/277	14			FAZ-C25/2-RT	181954	FAZ-C25/2-DU	185036	1/60
30	415	15	480Y/277	10			FAZ-C30/2-RT	181956	FAZ-C30/2-DU	185037	1/60
32	415	15	480Y/277	10			FAZ-C32/2-RT	181958	FAZ-C32/2-DU	185038	1/60
35	415	15	240	10			FAZ-C35/2-RT	181960	FAZ-C35/2-DU	185039	1/60
40	415	15	240	10			FAZ-C40/2-RT	181962	FAZ-C40/2-DU	185040	1/60

SG57012



3-pole

0.5	415	15	480Y/277	10	SWD	AWG 18	FAZ-C0,5/3-RT	181964	FAZ-C0,5/3-DU	185061	1/40
1	415	15	480Y/277	10	SWD	AWG 18	FAZ-C1/3-RT	181966	FAZ-C1/3-DU	185062	1/40
1.5	415	15	480Y/277	10	SWD	AWG 18	FAZ-C1,5/3-RT	181968	FAZ-C1,5/3-DU	185063	1/40
2	415	15	480Y/277	10	SWD	AWG 18	FAZ-C2/3-RT	181970	FAZ-C2/3-DU	185064	1/40
3	415	15	480Y/277	10	SWD	AWG 18	FAZ-C3/3-RT	181972	FAZ-C3/3-DU	185065	1/40
4	415	15	480Y/277	10	SWD	AWG 18	FAZ-C4/3-RT	181974	FAZ-C4/3-DU	185066	1/40
5	415	15	480Y/277	10	SWD	AWG 18	FAZ-C5/3-RT	181976	FAZ-C5/3-DU	185067	1/40
6	415	15	480Y/277	10	SWD	AWG 18	FAZ-C6/3-RT	181978	FAZ-C6/3-DU	185068	1/40
7	415	15	480Y/277	10	SWD	AWG 18	FAZ-C7/3-RT	181980	FAZ-C7/3-DU	185069	1/40
8	415	15	480Y/277	10	SWD	AWG 16	FAZ-C8/3-RT	181982	FAZ-C8/3-DU	185070	1/40
10	415	15	480Y/277	10	SWD	AWG 16	FAZ-C10/3-RT	181984	FAZ-C10/3-DU	185071	1/40
13	415	15	480Y/277	10	SWD		FAZ-C13/3-RT	181986	FAZ-C13/3-DU	185072	1/40
15	415	15	480Y/277	14	SWD		FAZ-C15/3-RT	181988	FAZ-C15/3-DU	185073	1/40
16	415	15	480Y/277	14	SWD		FAZ-C16/3-RT	181990	FAZ-C16/3-DU	185074	1/40
20	415	15	480Y/277	14	SWD		FAZ-C20/3-RT	181992	FAZ-C20/3-DU	185075	1/40
25	415	15	480Y/277	14			FAZ-C25/3-RT	181994	FAZ-C25/3-DU	185076	1/40
30	415	15	480Y/277	10			FAZ-C30/3-RT	181996	FAZ-C30/3-DU	185077	1/40
32	415	15	480Y/277	10			FAZ-C32/3-RT	181998	FAZ-C32/3-DU	185078	1/40
35	415	15	240	10			FAZ-C35/3-RT	182000	FAZ-C35/3-DU	185079	1/40
40	415	15	240	10			FAZ-C40/3-RT	182002	FAZ-C40/3-DU	185080	1/40

FAZ-...-RT/-DU Miniature Circuit Breakers (MCBs)

Characteristic D

	Rated current I_n (A)	Rated voltage IEC/EN 60947-2 (V)	Breaking capacity acc. to IEC/EN 60947-2 (kA)	Rated voltage UL489 (V)	Breaking capacity acc. to UL489 (kA)	SWD	NFPA 79 AWG	RT Type Designation	RT Article No.	DU Type Designation	DU Article No.	Units per package
1-pole												
0.5	240/415	15	277	10	SWD	AWG 18	FAZ-D0,5/1-RT	182004	FAZ-D0,5/1-DU	185001	12/120	
1	240/415	15	277	10	SWD	AWG 18	FAZ-D1/1-RT	182006	FAZ-D1/1-DU	185002	12/120	
1.5	240/415	15	277	10	SWD	AWG 18	FAZ-D1,5/1-RT	182008	FAZ-D1,5/1-DU	185003	12/120	
2	240/415	15	277	10	SWD	AWG 18	FAZ-D2/1-RT	182010	FAZ-D2/1-DU	185004	12/120	
3	240/415	15	277	10	SWD	AWG 18	FAZ-D3/1-RT	182012	FAZ-D3/1-DU	185005	12/120	
4	240/415	15	277	10	SWD	AWG 18	FAZ-D4/1-RT	182014	FAZ-D4/1-DU	185006	12/120	
5	240/415	15	277	10	SWD	AWG 18	FAZ-D5/1-RT	182016	FAZ-D5/1-DU	185007	12/120	
6	240/415	15	277	10	SWD	AWG 18	FAZ-D6/1-RT	182018	FAZ-D6/1-DU	185008	12/120	
7	240/415	15	277	10	SWD	AWG 18	FAZ-D7/1-RT	182020	FAZ-D7/1-DU	185009	12/120	
8	240/415	15	277	10	SWD	AWG 16	FAZ-D8/1-RT	182022	FAZ-D8/1-DU	185010	12/120	
10	240/415	15	277	10	SWD	AWG 16	FAZ-D10/1-RT	181832	FAZ-D10/1-DU	185011	12/120	
13	240/415	15	277	14	SWD		FAZ-D13/1-RT	181834	FAZ-D13/1-DU	185012	12/120	
15	240/415	15	277	14	SWD		FAZ-D15/1-RT	181836	FAZ-D15/1-DU	185013	12/120	
16	240/415	15	277	14	SWD		FAZ-D16/1-RT	181838	FAZ-D16/1-DU	185014	12/120	
20	240/415	15	277	14	SWD		FAZ-D20/1-RT	181840	FAZ-D20/1-DU	185015	12/120	
25	240/415	15	277	10			FAZ-D25/1-RT	181842	FAZ-D25/1-DU	185016	12/120	
30	240/415	15	277	10			FAZ-D30/1-RT	182024	FAZ-D30/1-DU	185017	12/120	
32	240/415	15	277	10			FAZ-D32/1-RT	182026	FAZ-D32/1-DU	185018	12/120	
35	240/415	15	240	10			FAZ-D35/1-RT	182028	FAZ-D35/1-DU	185019	12/120	
40	240/415	15	240	10			FAZ-D40/1-RT	182030	FAZ-D40/1-DU	185020	12/120	
2-pole												
0.5	415	15	480Y/277	10	SWD	AWG 18	FAZ-D0,5/2-RT	182032	FAZ-D0,5/2-DU	185041	1/60	
1	415	15	480Y/277	10	SWD	AWG 18	FAZ-D1/2-RT	182034	FAZ-D1/2-DU	185042	1/60	
1.5	415	15	480Y/277	10	SWD	AWG 18	FAZ-D1,5/2-RT	182036	FAZ-D1,5/2-DU	185043	1/60	
2	415	15	480Y/277	10	SWD	AWG 18	FAZ-D2/2-RT	182038	FAZ-D2/2-DU	185044	1/60	
3	415	15	480Y/277	10	SWD	AWG 18	FAZ-D3/2-RT	182040	FAZ-D3/2-DU	185045	1/60	
4	415	15	480Y/277	10	SWD	AWG 18	FAZ-D4/2-RT	182042	FAZ-D4/2-DU	185046	1/60	
5	415	15	480Y/277	10	SWD	AWG 18	FAZ-D5/2-RT	182044	FAZ-D5/2-DU	185047	1/60	
6	415	15	480Y/277	10	SWD	AWG 18	FAZ-D6/2-RT	182046	FAZ-D6/2-DU	185048	1/60	
7	415	15	480Y/277	10	SWD	AWG 18	FAZ-D7/2-RT	182048	FAZ-D7/2-DU	185049	1/60	
8	415	15	480Y/277	10	SWD	AWG 16	FAZ-D8/2-RT	182050	FAZ-D8/2-DU	185050	1/60	
10	415	15	480Y/277	10	SWD	AWG 16	FAZ-D10/2-RT	182052	FAZ-D10/2-DU	185051	1/60	
13	415	15	480Y/277	14	SWD		FAZ-D13/2-RT	182054	FAZ-D13/2-DU	185052	1/60	
15	415	15	480Y/277	14	SWD		FAZ-D15/2-RT	182056	FAZ-D15/2-DU	185053	1/60	
16	415	15	480Y/277	14	SWD		FAZ-D16/2-RT	182058	FAZ-D16/2-DU	185054	1/60	
20	415	15	480Y/277	14	SWD		FAZ-D20/2-RT	182060	FAZ-D20/2-DU	185055	1/60	
25	415	15	480Y/277	10			FAZ-D25/2-RT	182062	FAZ-D25/2-DU	185056	1/60	
30	415	15	480Y/277	10			FAZ-D30/2-RT	182064	FAZ-D30/2-DU	185057	1/60	
32	415	15	480Y/277	10			FAZ-D32/2-RT	182066	FAZ-D32/2-DU	185058	1/60	
35	415	15	240	10			FAZ-D35/2-RT	182068	FAZ-D35/2-DU	185059	1/60	
40	415	15	240	10			FAZ-D40/2-RT	182070	FAZ-D40/2-DU	185060	1/60	
3-pole												
0.5	415	15	480Y/277	10	SWD	AWG 18	FAZ-D0,5/3-RT	182072	FAZ-D0,5/3-DU	185081	1/40	
1	415	15	480Y/277	10	SWD	AWG 18	FAZ-D1/3-RT	182074	FAZ-D1/3-DU	185082	1/40	
1.5	415	15	480Y/277	10	SWD	AWG 18	FAZ-D1,5/3-RT	182076	FAZ-D1,5/3-DU	185083	1/40	
2	415	15	480Y/277	10	SWD	AWG 18	FAZ-D2/3-RT	182078	FAZ-D2/3-DU	185084	1/40	
3	415	15	480Y/277	10	SWD	AWG 18	FAZ-D3/3-RT	182080	FAZ-D3/3-DU	185085	1/40	
4	415	15	480Y/277	10	SWD	AWG 18	FAZ-D4/3-RT	182082	FAZ-D4/3-DU	185086	1/40	
5	415	15	480Y/277	10	SWD	AWG 18	FAZ-D5/3-RT	182084	FAZ-D5/3-DU	185087	1/40	
6	415	15	480Y/277	10	SWD	AWG 18	FAZ-D6/3-RT	182086	FAZ-D6/3-DU	185088	1/40	
7	415	15	480Y/277	10	SWD	AWG 18	FAZ-D7/3-RT	182088	FAZ-D7/3-DU	185089	1/40	
8	415	15	480Y/277	10	SWD	AWG 16	FAZ-D8/3-RT	182090	FAZ-D8/3-DU	185090	1/40	
10	415	15	480Y/277	10	SWD	AWG 16	FAZ-D10/3-RT	182092	FAZ-D10/3-DU	185091	1/40	
13	415	15	480Y/277	14	SWD		FAZ-D13/3-RT	182094	FAZ-D13/3-DU	185092	1/40	
15	415	15	480Y/277	14	SWD		FAZ-D15/3-RT	182096	FAZ-D15/3-DU	185093	1/40	
16	415	15	480Y/277	14	SWD		FAZ-D16/3-RT	182098	FAZ-D16/3-DU	185094	1/40	
20	415	15	480Y/277	14	SWD		FAZ-D20/3-RT	182100	FAZ-D20/3-DU	184984	1/40	
25	415	15	480Y/277	10			FAZ-D25/3-RT	182102	FAZ-D25/3-DU	184985	1/40	
30	415	15	480Y/277	10			FAZ-D30/3-RT	182104	FAZ-D30/3-DU	184986	1/40	
32	415	15	480Y/277	10			FAZ-D32/3-RT	182106	FAZ-D32/3-DU	184987	1/40	
35	415	15	240	10			FAZ-D35/3-RT	182108	FAZ-D35/3-DU	184988	1/40	
40	415	15	240	10			FAZ-D40/3-RT	182110	FAZ-D40/3-DU	184989	1/40	

FAZ-NA, -RT, -DU Miniature Circuit Breakers

Accessories:

Auxiliary switch for subsequent installation	Z-IHK-NA	113895
Tripping signal contact for subsequent installation	Z-NHK	248434
Shunt trip release	FAZ-XAA-NA12-110VAC	102037
	FAZ-XAA-NA110-415VAC	102036
Switching interlock	IS/SPE-1TE	101911
	Z-IS/SPE-1TE	274418

Specifications FAZ-NA, -RT, -DU

Technical data IEC/EN

	FAZ-...-NA, -RT, -DU	
Productstandard	IEC/EN 60947-2	
Number of poles	1, 2, 3	
Mechanical specifications		
Device width	17.7mm (1-pole), 35.4 mm (2-poles), 53.1 mm (3-poles)	
Frame size	45 mm	
Socket size	105 mm	
Device depth	60 mm	
Terminals	lift terminal / ring-tongue	
Terminal capacity rigid solid/stranded wire	1-25 mm ²	
Terminal screw	M5 (with slotted screw Pozidriv PZ2)	
Terminal torque	max. 2.4 Nm	
Snap on fixing	tristable (on DIN Rail acc. to IEC/EN 60715)	
Degree of Protection (DIN VDE 0470)		
Surface mounted	IP 20	
Built-in behind panel	IP 40	
Contact position indicator	red / green	
Electrical specifications		
Rated voltage	U_n	240/415 V AC
Rated current	I_n	0.5, 1, 1.5, 2, 3, 4, 5, 6, 7, 8, 10, 13, 15, 16, 20, 25, 30, 32, 35, 40 A
Rated insulation voltage	U_i	440 V AC
Rated impulse withstand voltage	U_{imp}	4 kV (1.2/50)µsec
Tripping characteristic		
Conventional non-tripping current	I_{nt}	$I_{nt} = 1.05 I_n$
Conventional tripping current	I_t	$I_t = 1.30 I_n$
Reference temperature	30 °C	
Temperature factor	0.5% /K	
Instantaneous tripping current	I_{mt}	type B: $3 I_n < I_{mt} = 5 I_n$; $t(I_{mt}) < 0.1$ sec (IEC/EN 60898-1) type C: $5 I_n < I_{mt} = 10 I_n$; $t(I_{mt}) < 0.1$ sec (IEC/EN 60898-1) type D: $10 I_n < I_{mt} = 20 I_n$; $t(I_{mt}) < 0.1$ sec (IEC/EN 60898-1)
Rated short-circuit braking capacity	I_{cu}	15 kA
Service short circuit capacity	I_{cs}	7.5 kA
Selectivity class	3 (acc. to EN 60898)	
Number of electrical operations	> 1500	
Number of mechanical operations	> 10000	
Climatic conditions	acc. to IEC 68-2 (25..55°C / 90..95% RH)	
Operating temperature range	-40°C to +75°C	

Connection diagram

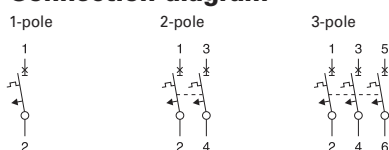

Specifications FAZ-NA, -RT, -DU

Technical data UL

		FAZ-...-NA, -RT, -DU
Productstandard		UL 489 CSA C22.2 No. 5-02
Number of poles		1, 2, 3
Mechanical specifications		
Device width		0.697 in. (1-pole), 1.394 in. (2-poles), 2.090 in. (3-poles)
Frame size		1.772 in.
Socket size		4.134 in.
Device depth		2.362 in.
Terminals		lift terminal / ring-tongue
Terminal capacity		1 Wire: #18-6 AWG (Cu only) 2 Wires: #18-10 AWG (Cu only)
Terminal screw		M5 (with slotted screw Pozidriv PZ2)
Terminal torque		#18-12 AWG: 21 lb-in #10-8 AWG: 25 lb-in #6 AWG: 36 lb-in
Snap on fixing		tristable (on DIN Rail acc. to IEC/EN 60715)
Contact position indicator		red / green
Electrical specifications		
Rated voltage	U_n	0.5-32 A: 480Y/277 V AC, 35-40 A: 240 V AC
Rated current	I_n	0.5, 1, 1.5, 2, 3, 4, 5, 6, 7, 8, 10, 13, 15, 16, 20, 25, 30, 32, 35, 40 A
Tripping characteristic		
Conventional non-tripping current		$I_{nt}=1.00 I_n$
Conventional tripping current		$I_t=1.35 I_n$
Reference temperature		40 °C
Temperature factor		0.5% /K
Instantaneous tripping current	I_{mt}	type C: $5 I_n < I_{mt} = 10 I_n$; $t(I_{mt}) < 0.1$ sec type D: $10 I_n < I_{mt} = 20 I_n$; $t(I_{mt}) < 0.1$ sec
Current interrupting rating		10 kA, 14 kA (types D13, B/C/D15, 16, 20, B/C25 A)
Current-Limiting at 240 V / 10 kA		1p, 2p, 3p to $I^2t = 43 \text{ kA}^2\text{s}$ and $I_{peak} = 6.2 \text{ kA}$
Current-Limiting at 480Y/277 V / 10 kA		1p, 2p, 3p to $I^2t = 60 \text{ kA}^2\text{s}$ and $I_{peak} = 6.2 \text{ kA}$
Current-Limiting at 480Y/277 V / 14 kA		1p, 2p, 3p to $I^2t = 65 \text{ kA}^2\text{s}$ and $I_{peak} = 7.5 \text{ kA}$
Selectivity class		3 (acc. to EN 60898)
Number of electrical operations		6000
Number of mechanical operations		10000
Climatic conditions		acc. to IEC 68-2 (25..55°C / 90..95% RH)
Operating temperature range		-5°C to +40°C

Connection diagram

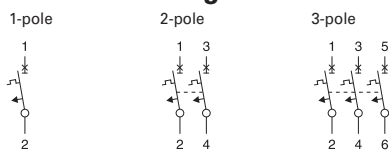

Dimensions (mm) FAZ-...-NA, -RT, -DU

1-pole

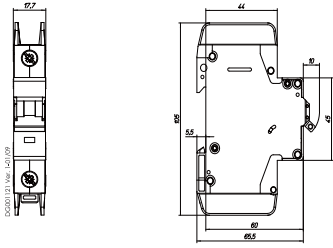

2-pole

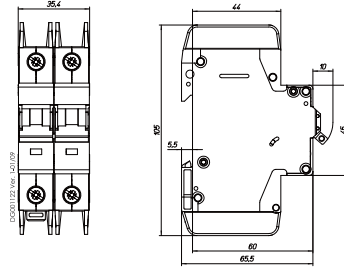

3-pole

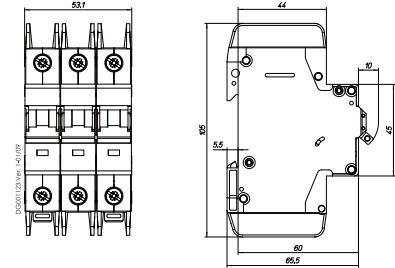

Tripping Characteristic FAZ-...-NA, -RT, -DU

Characteristics C and D - EN/IEC 60947-2

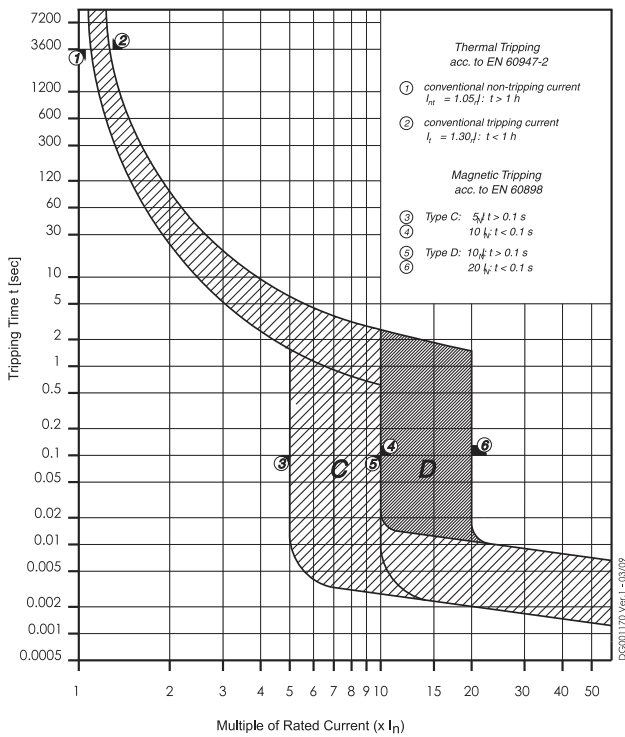

Characteristics C and D - UL 489

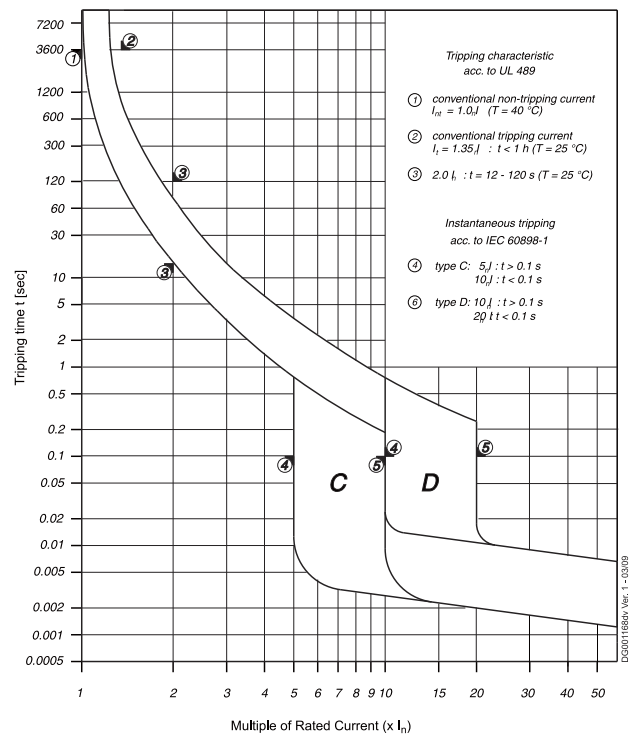

Internal Resistance FAZ-...-NA, -RT, -DU

Type C

At room temperature (single pole)

In [A]	Z* [mΩ]	R [mΩ]
0.5	6400	6300
1	1100	1080
1.5	560	550
2	340	330
3	132	130
4	86	85
5	70	69
6	31	30
7	28	27
8	20	19.6
10	15.8	15.5
13	12.3	12.1
15	7.1	7.0
16	7.1	7.0
20	6.0	5.9
25	4.1	4.0
30	2.8	2.7
32	2.8	2.7
35	2.5	2.5
40	2.1	2.1

* 50Hz

Type D

At room temperature (single pole)

In [A]	Z* [mΩ]	R [mΩ]
0.5	6400	6300
1	770	755
1.5	460	450
2	250	245
3	132	130
4	86	85
5	57	56
6	31	30
7	28	27
8	18	17.6
10	13.5	13.2
13	10.5	10.3
15	5.9	5.8
16	5.9	5.8
20	4.0	3.9
25	3.4	3.3
30	2.5	2.5
32	2.5	2.5
35	2.5	2.5
40	2.0	2.0

* 50Hz

Power Loss at I_n FAZ-...-NA, -RT, -DU

Type C

In [A]	1p	2p	3p
	P* [W]	P* [W]	P* [W]
0.5	1.6	3.2	4.7
1	1.1	2.2	3.4
1.5	1.3	2.6	3.9
2	1.4	2.8	4.3
3	1.2	2.4	3.6
4	1.4	2.9	4.3
5	1.9	3.7	5.6
6	1.2	2.3	3.5
7	1.4	2.8	4.3
8	1.4	2.8	4.2
10	1.8	3.6	5.3
13	2.4	4.7	7.1
15	1.9	3.8	5.6
16	2.1	4.3	6.4
20	2.9	5.8	8.7
25	3.1	6.2	9.3
30	3.0	6.0	9.0
32	3.4	6.8	10.2
35	3.7	7.4	11.0
40	4.0	8.1	12.1

*50Hz

Type D

In [A]	1p	2p	3p
	P* [W]	P* [W]	P* [W]
0.5	1.6	3.2	4.8
1	0.8	1.5	2.3
1.5	1.0	2.1	3.1
2	1.0	2.1	3.1
3	1.2	2.4	3.6
4	1.4	2.9	4.3
5	1.5	2.9	4.4
6	1.2	2.3	3.5
7	1.4	2.8	4.3
8	1.2	2.4	3.7
10	1.5	3.0	4.5
13	2.0	4.1	6.1
15	1.5	3.1	4.6
16	1.7	3.5	5.2
20	1.8	3.7	5.5
25	2.6	5.1	7.7
30	2.7	5.4	8.1
32	3.1	6.2	9.3
35	3.8	7.6	11.3
40	3.9	7.8	11.6

*50Hz

Maximum Let-Through Energy FAZ-...-NA, -RT, -DU

Type C (0.5 - 32 A), 277 V

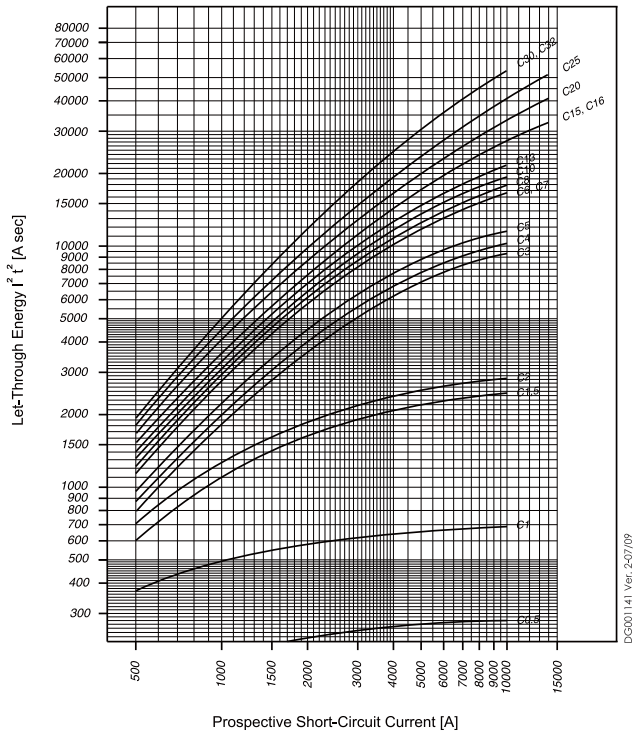

Type C (35 - 40 A), 240 V

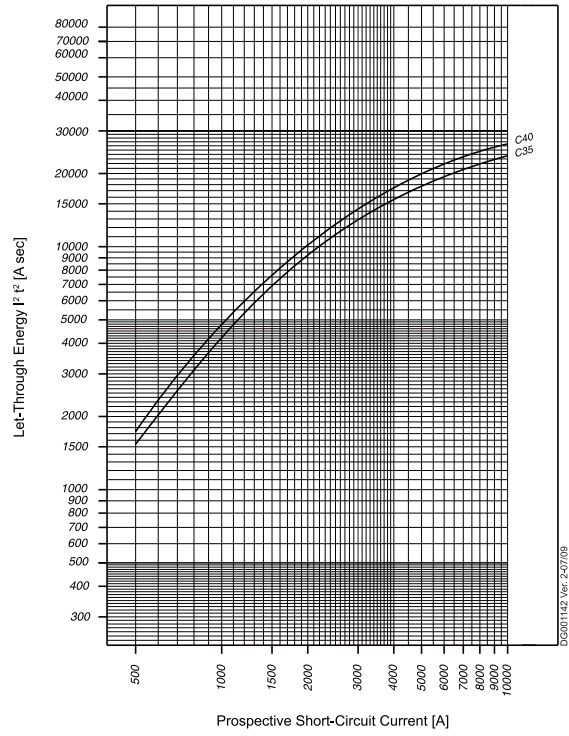

Type D (0.5 - 32 A), 277 V

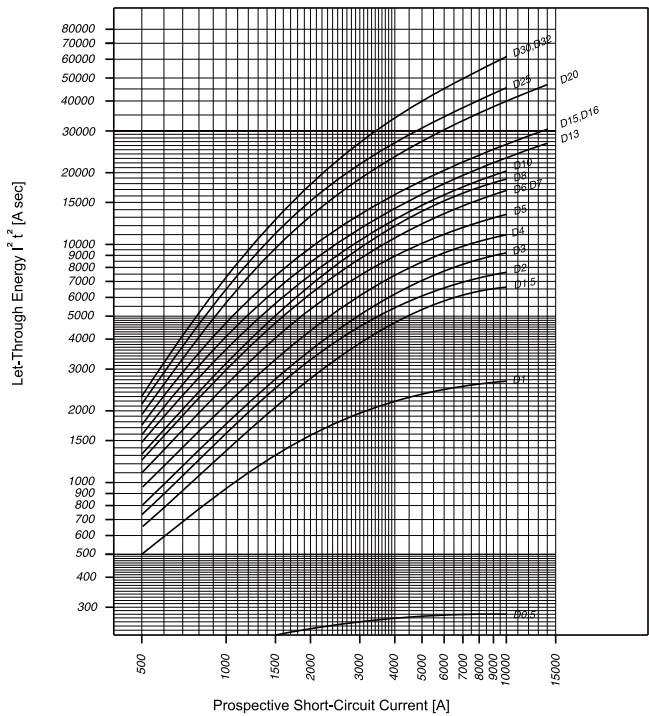

Type D (35 - 40 A), 240 V

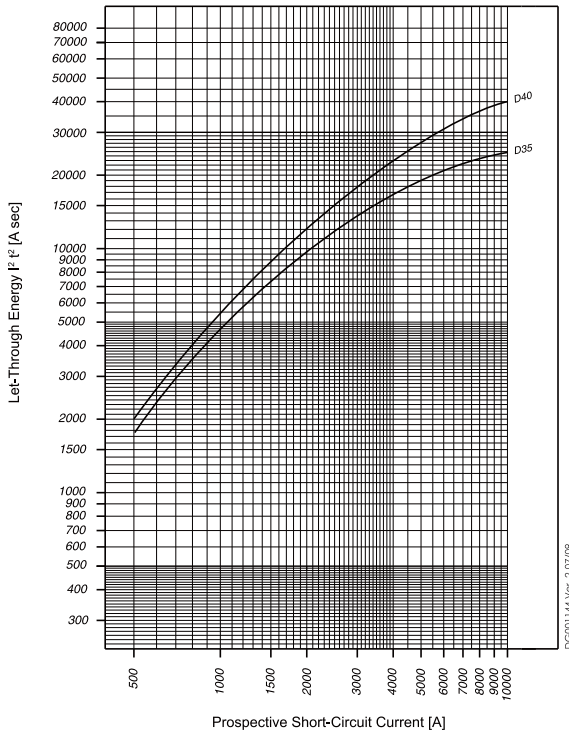

Maximum Let-Through Current FAZ-...-NA, -RT, -DU

Type C (0.5 - 32 A), 277 V

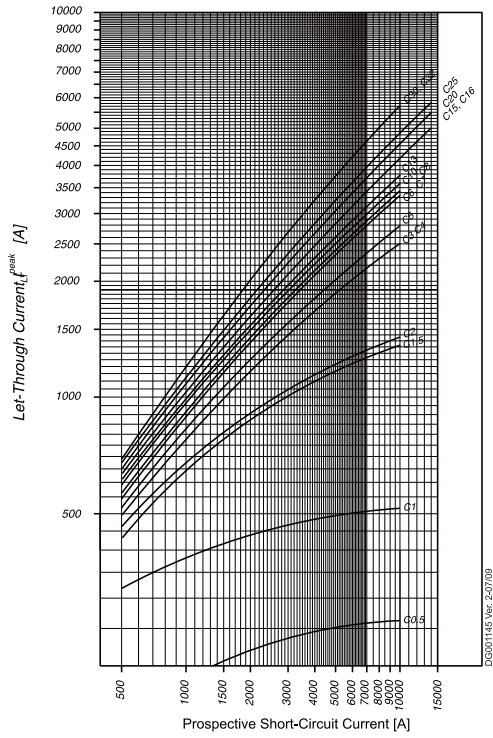

Type C (35 - 40 A), 240 V

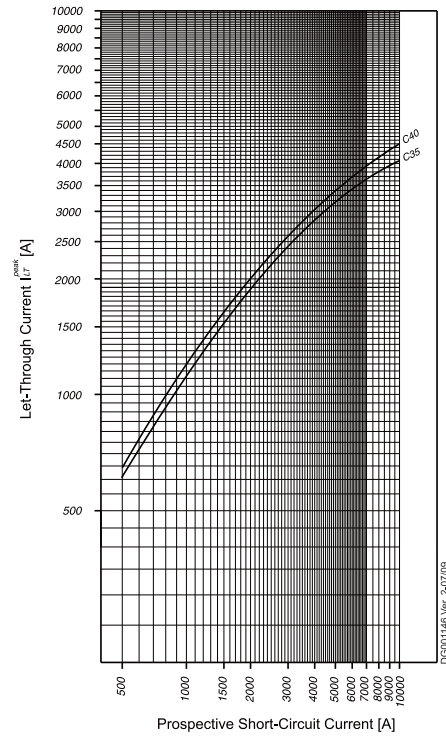

Type D (0.5 - 32 A), 277 V

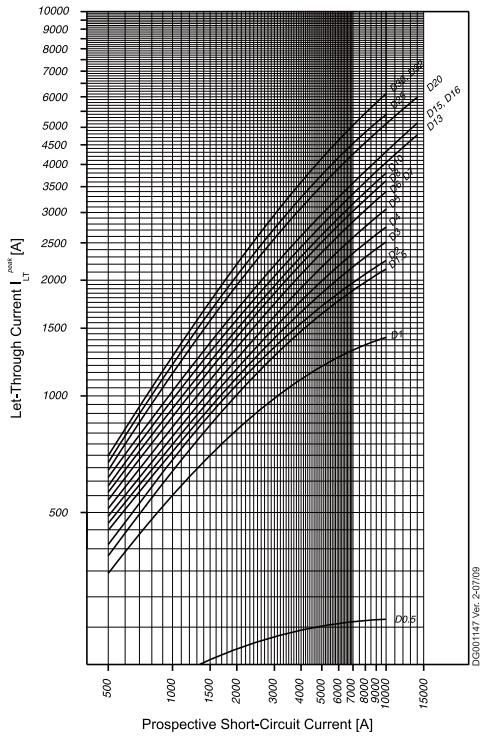

Type D (35 - 40 A), 240 V

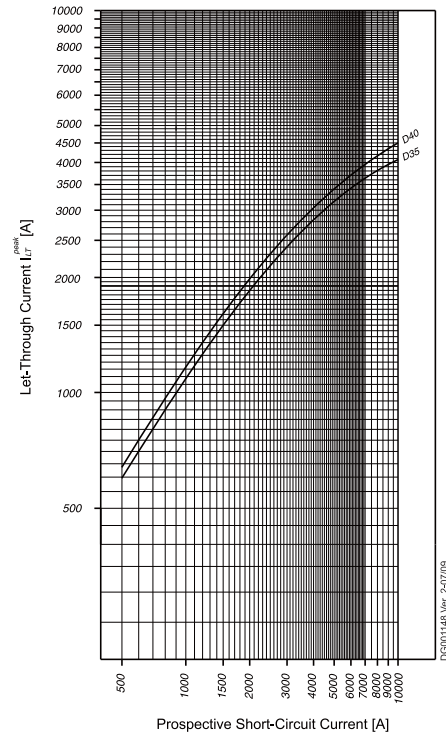

Miniature Circuit Breakers FAZ-NA-DC

SG56612



FAZ-NA-DC

- High-quality miniature circuit breakers for DC-applications
- Contact position indicator red - green
- Guide for secure terminal connection (not for FAZ-NA)
- 3-position DIN rail clip, permits removal from existing busbar system
- Comprehensive range of accessories suitable for subsequent installation
- Rated currents up to 40 A
- Tripping characteristic C
- Rated breaking capacity 10 kA according to IEC/EN 60947-2
- Up to 125 V DC per pole

FAZ...-NA-DC Miniature Circuit Breakers (MCBs)

Characteristic C

Rated current I_n (A)	Rated voltage IEC/EN 60947-2 (V DC)	Breaking capacity acc. to IEC/EN 60947-2 (kA)	Rated voltage UL489 (V)	Breaking capacity acc. to UL489 (kA)	SWD	NFPA 79	Type Designation	Article No.	Units per package
1-pole									
2	220	10	125	10			FAZ-C2/1-NA-DC	113752	12/120
3	250	10	125	10			FAZ-C3/1-NA-DC	113753	12/120
4	250	10	125	10			FAZ-C4/1-NA-DC	113754	12/120
5	250	10	125	10			FAZ-C5/1-NA-DC	113755	12/120
6	250	10	125	10			FAZ-C6/1-NA-DC	113756	12/120
7	250	10	125	10			FAZ-C7/1-NA-DC	113757	12/120
8	250	10	125	10			FAZ-C8/1-NA-DC	113758	12/120
10	250	10	125	10			FAZ-C10/1-NA-DC	113759	12/120
13	250	10	125	10			FAZ-C13/1-NA-DC	113760	12/120
15	250	10	125	10			FAZ-C15/1-NA-DC	113761	12/120
16	250	10	125	10			FAZ-C16/1-NA-DC	113762	12/120
20	250	10	125	10			FAZ-C20/1-NA-DC	113763	12/120
25	250	10	125	10			FAZ-C25/1-NA-DC	113764	12/120
30	250	10	125	10			FAZ-C30/1-NA-DC	113765	12/120
32	250	10	125	10			FAZ-C32/1-NA-DC	113766	12/120
35	250	10	125	10			FAZ-C35/1-NA-DC	113767	12/120
40	250	10	125	10			FAZ-C40/1-NA-DC	113768	12/120

SG56512



SG56612



2-pole									
2	440	10	250	10			FAZ-C2/2-NA-DC	137239	1/60
3	500	10	250	10			FAZ-C3/2-NA-DC	137250	1/60
4	500	10	250	10			FAZ-C4/2-NA-DC	137251	1/60
5	500	10	250	10			FAZ-C5/2-NA-DC	137252	1/60
6	500	10	250	10			FAZ-C6/2-NA-DC	120638	1/60
7	500	10	250	10			FAZ-C7/2-NA-DC	120639	1/60
8	500	10	250	10			FAZ-C8/2-NA-DC	120640	1/60
10	500	10	250	10			FAZ-C10/2-NA-DC	120641	1/60
13	500	10	250	10			FAZ-C13/2-NA-DC	120642	1/60
15	500	10	250	10			FAZ-C15/2-NA-DC	120643	1/60
16	500	10	250	10			FAZ-C16/2-NA-DC	120644	1/60
20	500	10	250	10			FAZ-C20/2-NA-DC	120645	1/60
25	500	10	250	10			FAZ-C25/2-NA-DC	120646	1/60
30	500	10	250	10			FAZ-C30/2-NA-DC	120647	1/60
32	500	10	250	10			FAZ-C32/2-NA-DC	120648	1/60
35	500	10	250	10			FAZ-C35/2-NA-DC	120649	1/60
40	500	10	250	10			FAZ-C40/2-NA-DC	120650	1/60

Specifications FAZ-NA-DC

Technical data

		FAZ-NA-DC
Productstandard		UL 489, CSA C22.2 No 5-02
Number of poles		1, 2
Mechanical specifications		
Device width		1 pole = 0.697 inch, 2 poles = 1.394 inch
Frame size		1.772 inch
Socket size		4.134 inch
Device depth		2.362 inch
Terminals		lift terminal / ring-tongue
Terminal capacity rigid solid/stranded wire		1 Wire: AWG 18-6 (Cu only) 2 Wires: AWG 18-10 (Cu only)
Terminal screw		M5 (with slotted screw Pozidriv PZ2)
Terminal torque		#18-12 AWG: 21 lb-in #10-8 AWG: 25 lb-in #6 AWG: 36 lb-in
Snap on fixing		tristable (on DIN Rail acc. to IEC/EN 60715)
Finger proof		acc.to VBG4, ÖVE EN-6
Contact position indicator		red / green
Electrical specifications		
Rated voltage DC	U_n	125 V d.c. (1p) 250 V d.c. (2p)
Rated current	I_n	2, 3, 4, 5, 6, 7, 8, 10, 13, 15, 16, 20, 25, 30, 32, 35, 40 A
Rated impulse withstand voltage	U_{imp}	4 kV (1.2/50) μ sec
Tripping characteristic		
Conventional non-tripping current		$I_{nt}=1.0 I_n$
Conventional tripping current		$I_t=1.35 I_n$
Reference temperature		40 °C
Temperature factor		0.5% /K
Instantaneous tripping current	I_{mt}	$7 I_n < I_{mt} = 15 I_n \cdot t (I_{mt}) < 0.1 \text{ sec}$
Current interrupting rating		10 kA
Number of electrical operating cycles		6000
Number of mechanical operating cycles		10000
Climatic conditions		acc. to IEC 68-2 (25..55°C / 90..95% RH)
Operating temperature range		-25°C to +55°C

Connection diagram

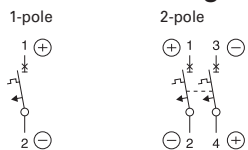

Dimensions (mm) FAZ-NA-DC

1-pole

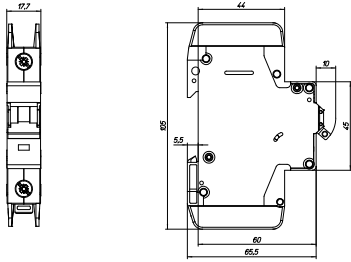

2-pole

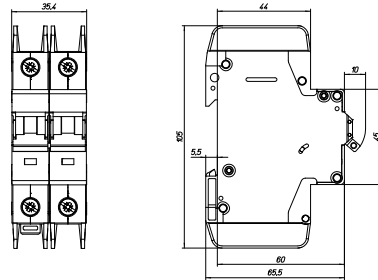

Tripping Characteristic FAZ-NA-DC

Characteristics C - UL 489

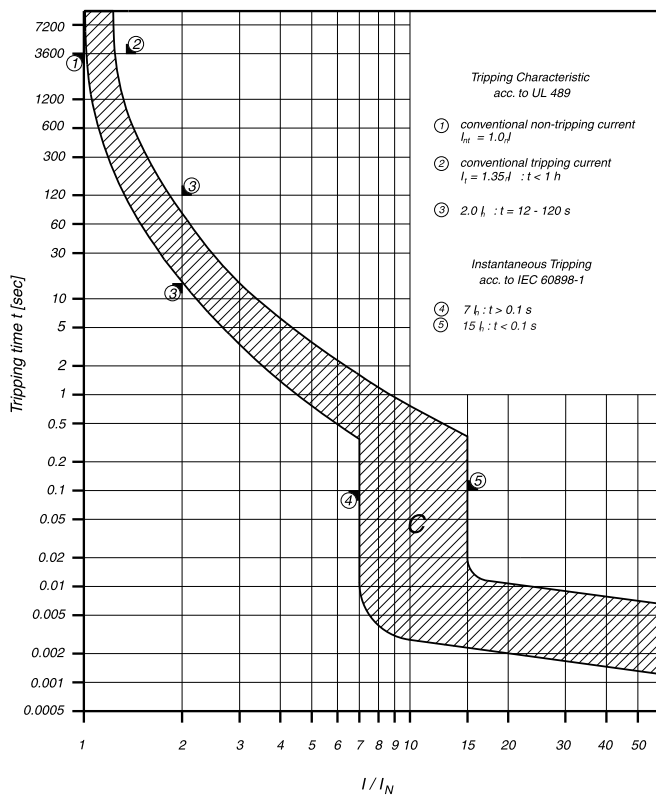





Miniature Circuit Breakers AZ

SG51412







- High-quality miniature circuit breakers for commercial and industrial applications
- Contact position indicator red - green
- Accessories suitable for subsequent installation
- Rated currents up to 125 A
- Tripping characteristics C, D
- Rated breaking capacity up to 25 kA according to EN 60947-2

AZ Miniature Circuit Breakers (MCBs) Characteristic C

	Rated current I_n (A)	Type Designation	Article No.	Units per package
SG51212 	1-pole			
	20	AZ-C20	211769	12
	25	AZ-C25	211774	12
	32	AZ-C32	211779	12
	40	AZ-C40	211784	12
	50	AZ-C50	211789	12
	63	AZ-C63	211794	12
	80	AZ-C80	211799	12
	100	AZ-C100	211804	12
125	AZ-C125	211809	12	
SG51312 	2-pole			
	20	AZ-2-C20	211770	2
	25	AZ-2-C25	211775	2
	32	AZ-2-C32	211780	2
	40	AZ-2-C40	211785	2
	50	AZ-2-C50	211790	2
	63	AZ-2-C63	211795	2
	80	AZ-2-C80	211800	2
	100	AZ-2-C100	211805	2
125	AZ-2-C125	211810	2	
wa_sg00314 	3-pole			
	20	AZ-3-C20	211771	1
	25	AZ-3-C25	211776	1
	32	AZ-3-C32	211781	1
	40	AZ-3-C40	211786	1
	50	AZ-3-C50	211791	1
	63	AZ-3-C63	211796	1
	80	AZ-3-C80	211801	1
	100	AZ-3-C100	211806	1
125	AZ-3-C125	211811	1	
wa_sg00214 	3+N-pole			
	20	AZ-3N-C20	211773	1
	25	AZ-3N-C25	211778	1
	32	AZ-3N-C32	211783	1
	40	AZ-3N-C40	211788	1
	50	AZ-3N-C50	211793	1
	63	AZ-3N-C63	211798	1
	80	AZ-3N-C80	211803	1
	100	AZ-3N-C100	211808	1
125	AZ-3N-C125	211813	1	
SG51412 	4-pole			
	20	AZ-4-C20	211772	1
	25	AZ-4-C25	211777	1
	32	AZ-4-C32	211782	1
	40	AZ-4-C40	211787	1
	50	AZ-4-C50	211792	1
	63	AZ-4-C63	211797	1
	80	AZ-4-C80	211802	1
	100	AZ-4-C100	211807	1
125	AZ-4-C125	211812	1	

AZ Miniature Circuit Breakers (MCBs)

Characteristic D

	Rated current I_n (A)	Type Designation	Article No.	Units per package
SG51212 	1-pole			
	50	AZ-D50	211814	12
	63	AZ-D63	211818	12
	80	AZ-D80	211822	12
	100	AZ-D100	211826	12
SG51312 	2-pole			
	50	AZ-2-D50	211815	2
	63	AZ-2-D63	211819	2
	80	AZ-2-D80	211823	2
	100	AZ-2-D100	211827	2
wa_sg00314 	3-pole			
	50	AZ-3-D50	211816	1
	63	AZ-3-D63	211820	1
	80	AZ-3-D80	211824	1
	100	AZ-3-D100	211828	1
wa_sg00214 	3+N-pole			
	50	AZ-3N-D50	211817	1
	63	AZ-3N-D63	211821	1
	80	AZ-3N-D80	211825	1
	100	AZ-3N-D100	211829	1

Maximum Let-Through Current AZ

Type C

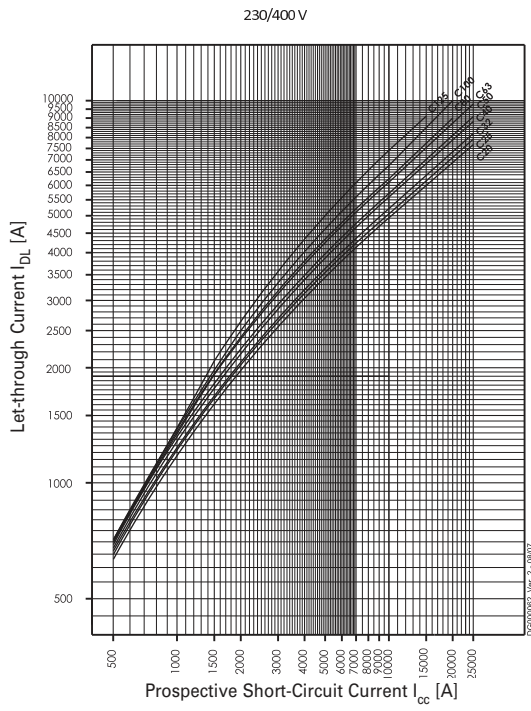

Type D

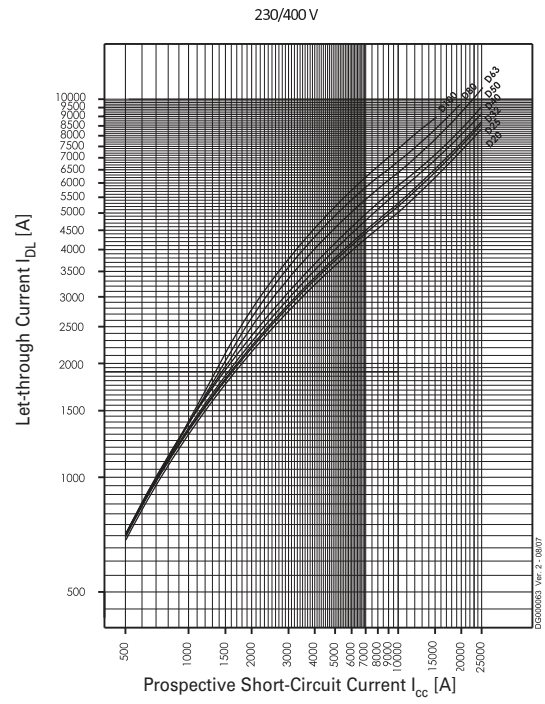

Dimensions (mm)

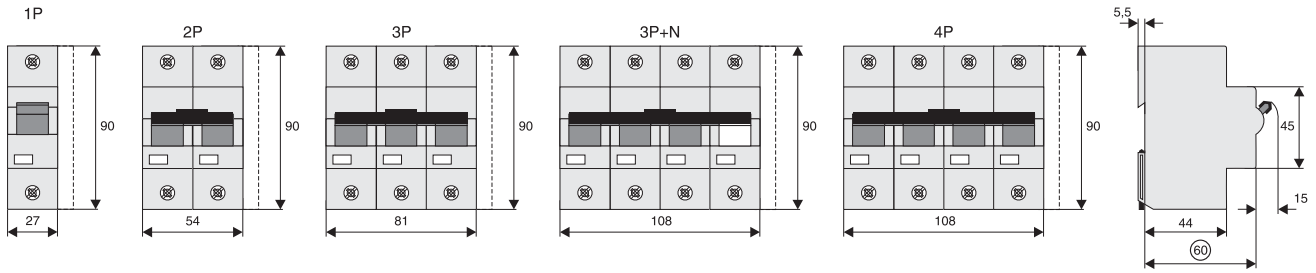

Effect of ambient temperature AZ

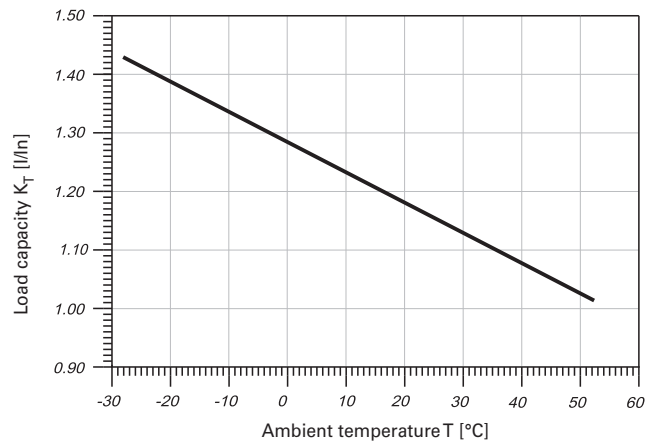

Permitted permanent load at ambient temperature T [°C] with n devices: $I_{DL} = I_n K_T(T) K_N(N)$.

Maximum Let-Through Current AZ

Type C

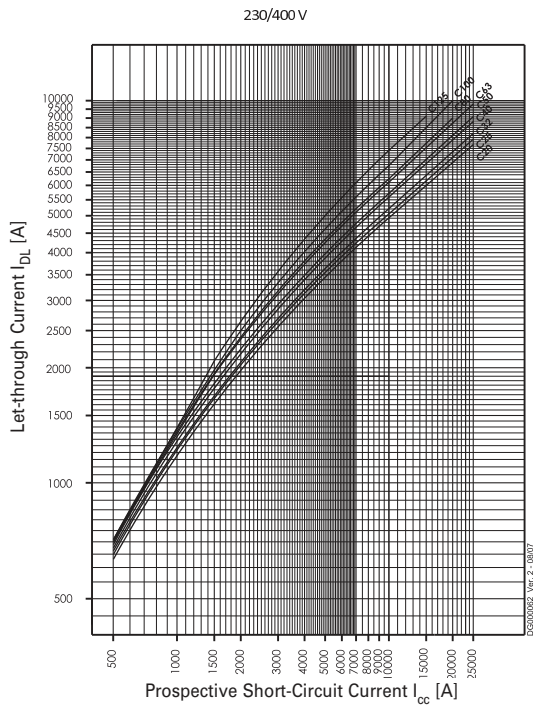

Type D

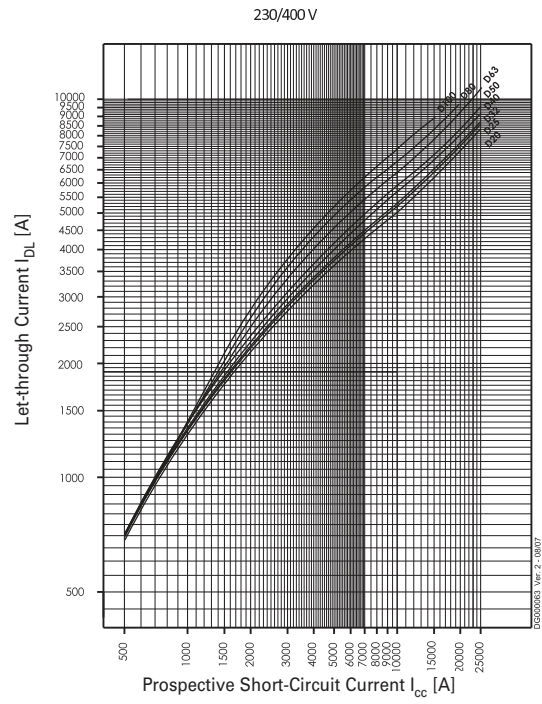

Short Circuit Selectivity AZ

In case of short circuit, there is selectivity between the miniature circuit breakers AZ and the upstream protection devices up to the specified values of the selectivity limit current I_s [kA] (i. e. in case of short-circuit currents I_{ks} under I_s , only the MCB will trip, in case of short circuit currents above this value both protective devices will respond).

AZ towards back-up fuses D01, D02, D03

Rated current I_n AZ in A	Rated current of the back-up fuse in A						
	25	35	50	63	80	100	
C - Characteristic	20	0,5	1,0	2,0	2,9	3,9	7,6
	25		1,0	1,9	2,8	3,8	7,3
	32		1,0	1,8	2,7	3,6	7,0
	40			1,6	2,2	3,0	5,6
	50				2,1	2,8	5,2
	63					2,7	4,8
	80						4,3
	100						
	125						
D -Characteristic	20	0,5	0,9	1,7	2,5	3,4	6,7
	25		0,9	1,6	2,3	3,2	6,2
	32		0,9	1,5	2,3	3,0	6,0
	40			1,4	2,0	2,6	4,7
	50				1,8	2,3	4,3
	63					2,1	3,7
	80						3,1
	100						
	125						

AZ towards back-up fuses NH Gr. 00

Rated current I_n AZ in A	Rated current of the back-up fuse in A										
	25	35	40	50	63	80	100	125	160	200	
C - Characteristic	20	0,5	1,0	1,3	1,9	2,7	3,7	6,7	17,0	25,0	25,0
	25		0,9	1,3	1,8	2,6	3,5	6,5	17,0	25,0	25,0
	32		0,9	1,2	1,7	2,4	3,3	6,0	15,0	23,0	25,0
	40				1,4	2,1	2,9	4,8	12,0	18,0	25,0
	50					1,9	2,7	4,5	11,0	17,0	25,0
	63							4,2	10,0	15,0	25,0
	80							3,8	8,5	12,0	25,0
	100								7,0	10,0	25,0
	125									7,5	25,0
D - Characteristic	20	<0,5	0,8	1,1	1,5	2,3	3,1	5,6	16,0	25,0	25,0
	25		0,7	1,0	1,4	2,1	3,0	5,3	14,0	23,0	25,0
	32		0,7	1,0	1,3	2,1	2,9	5,0	13,0	22,0	25,0
	40				1,1	1,8	2,5	4,2	10,0	15,0	25,0
	50					1,6	2,3	3,8	8,5	13,0	22,0
	63						2,1	3,2	7,0	10,5	18,0
	80							2,8	5,5	8,4	15,0
	100								4,8	7,5	12,5
	125										

AZ towards NZM 1

Short circuit selectivity **characteristic C** towards **NZM***)

AZ	NZM...1-A gL/gG					
I _n [A]	40	50	63	80	100	125
20	0.3	0.4	0.5	0.75	0.9	1.25
25	0.3	0.4	0.5	0.7	0.9	1.2
32		0.4	0.5	0.7	0.85	1.2
40			0.5	0.6	0.85	1.1
50				0.6	0.85	1.1
63					0.8	1
80						1
100						
125						

Short circuit selectivity **characteristic D** towards **NZM***)

AZ	NZM...1-A gL/gG					
I _n [A]	40	50	63	80	100	125
50						
63						
80						
100						

 no selectivity

AZ towards NZM 2

Short circuit selectivity **characteristic C** towards **NZM***)

AZ	NZM...2-A gL/gG								
I _n [A]	40	50	63	80	100	125	160	200	250
20	0.3	0.4	0.5	0.75	0.9	1.25	1.8	2.5	3.5
25	0.3	0.4	0.5	0.7	0.9	1.2	1.7	2.4	3.3
32		0.4	0.5	0.7	0.85	1.2	1.65	2.3	3.2
40			0.5	0.6	0.85	1.1	1.5	2.1	2.9
50				0.6	0.85	1.1	1.5	2	2.8
63					0.8	1	1.4	1.8	2.5
80						1	1.4	1.8	2.4
100							1.3	1.7	2.3
125								1.6	2.1

Short circuit selectivity **characteristic D** towards **NZM***)

AZ	NZM...2-A gL/gG								
I _n [A]	40	50	63	80	100	125	160	200	250
50							1	1.4	2.6
63							1	1.3	2.3
80									2.1
100									

 no selectivity

Back-up Protection AZ

The up-stream protective devices will protect the down-stream AZ up to the short-circuit current specified.

AZ and NZM(B)(C)(N)(H)1

I_n [A]	AZ-$I_n/1(2,3,4)$ / C(D) + NZMB1 $U_e = 230/400$ V
20	25 kA
25	25 kA
32	25 kA
40	25 kA
50	25 kA
63	25 kA
80	25 kA
100	25 kA
125	25 kA

I_n [A]	AZ-$I_n/1(2,3,4)$ / C(D) + NZMC1 $U_e = 230/400$ V
20	36 kA
25	36 kA
32	36 kA
40	36 kA
50	36 kA
63	36 kA
80	36 kA
100	36 kA
125	36 kA

I_n [A]	AZ-$I_n/1(2,3,4)$ / C(D) + NZMN1 $U_e = 230/400$ V
20	50 kA
25	50 kA
32	50 kA
40	50 kA
50	50 kA
63	50 kA
80	50 kA
100	50 kA
125	50 kA

I_n [A]	AZ-$I_n/1(2,3,4)$ / C(D) + NZMH1 $U_e = 230/400$ V
20	80 kA
25	80 kA
32	80 kA
40	80 kA
50	80 kA
63	80 kA
80	80 kA
100	80 kA
125	80 kA

AZ and NZM(B)(C)(N)(H)2

I_n [A]	AZ-$I_n/1(2,3,4)$ / C(D) + NZMB2 $U_e = 230/400$ V
20	25 kA
25	25 kA
32	25 kA
40	25 kA
50	25 kA
63	25 kA
80	25 kA
100	25 kA
125	25 kA

I_n [A]	AZ-$I_n/1(2,3,4)$ / C(D) + NZMC2 $U_e = 230/400$ V
20	36 kA
25	36 kA
32	36 kA
40	36 kA
50	36 kA
63	36 kA
80	36 kA
100	36 kA
125	36 kA

I_n [A]	AZ-$I_n/1(2,3,4)$ / C(D) + NZMN2 $U_e = 230/400$ V
20	50 kA
25	50 kA
32	50 kA
40	50 kA
50	50 kA
63	50 kA
80	50 kA
100	50 kA
125	50 kA

I_n [A]	AZ-$I_n/1(2,3,4)$ / C(D) + NZMH2 $U_e = 230/400$ V
20	65 kA
25	65 kA
32	65 kA
40	65 kA
50	65 kA
63	65 kA
80	65 kA
100	65 kA
125	65 kA

Load capacity in case of block installation AZ

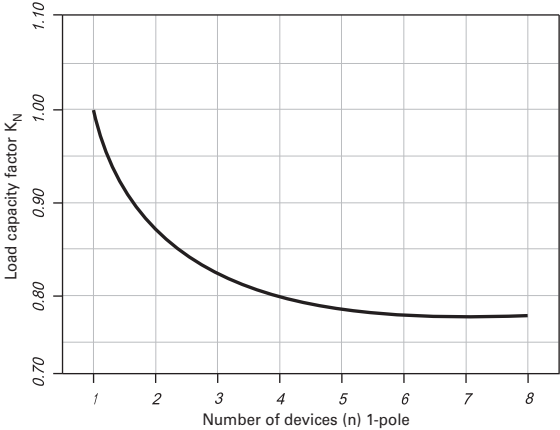





Main Load Disconnecter Switch (Isolator) IS

SG10911



- Load circuit breaker with isolating function
- Highly wear resistant contacts
- Quick make
- Terminal capacity 50 mm²
- Compatible busbars
- 1-, 2-, 3-, 4-pole

Main Load Disconnecter Switch (Isolator) IS

	Rated Current (A)	Poles	Type Designation	Article No.	Units per package	
 SG10611	16	1	IS-16/1	276254	12/120	
	16	2	IS-16/2	276255	1/60	
	16	3	IS-16/3	276256	1/40	
	16	4	IS-16/4	276257	1/30	
	20	1	IS-20/1	276258	12/120	
	20	2	IS-20/2	276259	1/60	
	20	3	IS-20/3	276260	1/40	
	20	4	IS-20/4	276261	1/30	
	 SG10711	25	1	IS-25/1	276262	12/120
		25	2	IS-25/2	276263	1/60
		25	3	IS-25/3	276264	1/40
		25	4	IS-25/4	276265	1/30
32		1	IS-32/1	276266	12/120	
32		2	IS-32/2	276267	1/60	
32		3	IS-32/3	276268	1/40	
32		4	IS-32/4	276269	1/30	
40		1	IS-40/1	276270	12/120	
40		2	IS-40/2	276271	1/60	
 SG10811		40	3	IS-40/3	276272	1/40
		40	4	IS-40/4	276273	1/30
	63	1	IS-63/1	276274	12/120	
	63	2	IS-63/2	276275	1/60	
	63	3	IS-63/3	276276	1/40	
	63	4	IS-63/4	276277	1/30	
	80	1	IS-80/1	276278	12/120	
	80	2	IS-80/2	276279	1/60	
	80	3	IS-80/3	276280	1/40	
	80	4	IS-80/4	276281	1/30	
	 SG10911	100	1	IS-100/1	276282	12/120
		100	2	IS-100/2	276283	1/60
100		3	IS-100/3	276284	1/40	
100		4	IS-100/4	276285	1/30	
125		1	IS-125/1	276286	12/120	
125		2	IS-125/2	276287	1/60	
125		3	IS-125/3	276288	1/40	
125		4	IS-125/4	276289	1/30	

Accessories

	Description	Type Designation	Article No.	Units per package
 SG47812	Switching interlock without lock for Isolators, RCDs, combined RCD/MCBs, ...	IS/SPE-1TE	101911	5/30
	Terminal cover	Z-IS/AK-1TE	276290	10/600

Switching interlock IS/SPE-1TE

- Without lock
- Also suitable for PFIM, CF16, PKNM, CKN6

Terminal Cover Caps Z-IS/AK-1TE

- Can be sealed with leads
- Modular design, width 1 MU

Specifications | Main Load Disconnecter Switch (Isolator) IS

Description

- Load circuit breaker with isolating function
- Design according to IEC/EN 60947-3
- Highly wear resistant contacts
- Quick make, black toggle
- Terminal capacity 50 mm²
- Compatible busbars with switchgear series Xpole by use of the mouth terminal in combination with standard fork busbar

Technical Data

	IS-16	IS-20	IS-25	IS-32	IS-40	IS-63	IS-80	IS-100	IS-125
Electrical									
Design	according to IEC/EN 60947-3								
Rated voltage	240/415 V								
Frequency	50/60 Hz								
Rated insulation voltage	U_i	690 V~							
Rated peak withstand voltage	U_{imp}	6 kV							
Pollution degree	3								
Rated short-time withstand current	I_{cw}	2 kA							
Rated short-circuit making capacity	I_{cm}	2.8 kA							
Rated current									
240/415V, AC23A	16 A	20 A	25 A	32 A	40 A	63 A	80 A	100 A	125 A
Number of poles	1-, 2-, 3-, 4-pole								
Maximum back-up fuse	125 A gG								
Short circuit strength - with back-up fuse acc. to the applicable rules									
IEC/EN 60947-3	12.5 kA	12.5 kA	12.5 kA	12.5 kA	12.5 kA	12.5 kA	12.5 kA	10 kA	10 kA
Endurance									
electrical components operation cycles	≥3.000	≥3.000	≥3.000	≥3.000	≥3.000	≥3.000	≥3.000	≥3.000	≥2.000
mechanical components operation cycles	≥16.000	≥16.000	≥16.000	≥16.000	≥16.000	≥16.000	≥16.000	≥16.000	≥14.000
Mechanical									
Frame size	45 mm								
Device height	80 mm								
Device width	17.5mm/pole								
Mounting	quick fastening with 2 lock-in positions on DIN rail IEC/EN 60715								
Degree of protection, built-in	IP40								
Terminal protection	finger and hand touch safe according to BGV A3								
Terminals	open mouthed/lift terminals								
Terminal capacity	2.5 - 50 mm ²								
Busbar thickness	0.8 - 2 mm								
Fastening torque of terminal screws	2.5 - 5 Nm								
Function	irrespective of the position of installation								

Connection diagram

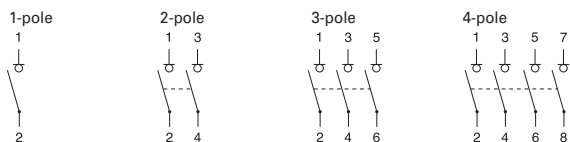

Dimensions (mm)

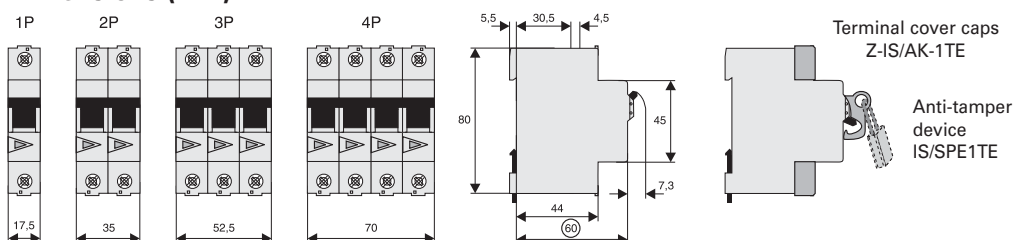

Busbar System xEffect BB-EV

SG13113

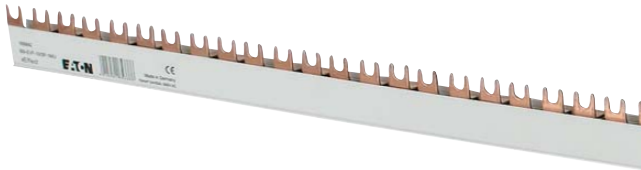

Busbar System xEffect is the modular design system for busbars. xEffect busbars are available as yard goods with 1, 2 or 3 poles. Now, there is a special feature: each bar can easily be extended by one-pole bar as you like. The additional pole can be added completely without tools by easy clamping technique. The lugs or forks in the xEffect bars - available in 10 and 16 mm² and all common distances - can be broken out at a predetermined breaking point. There is actually no more flexibility available.

Busbar System xEffect saves time and material

The yard good can be cut with a saw of course. However, there is no need neither for deburring nor for cutting the conductor. Just cut to the required dimension and close with the fitting end cap -ready! The end caps have also breakable edges, which enable further connecting of the Busbar System xEffect. By overlapping assembly, doubling the cross section can be achieved.

Busbar System xEffect in use

Busbar System xEffect is especially well suited for solving flexible busbar applications rack-mounted models in series. Fork-pin combinations for 1+N applications can be realized by individual combinations - for this also the one-pole version with blue isolation is available besides the one with grey isolation. Even different cross sections can be combined in this case.

Accessories, such as feeder terminals and self adhesive phase marking labels will complete the comfortable total package. Existing contact prevention caps can be used.

Busbar System xEffect at a glance:

- Yard goods can be cut
- No cutting back of copper required
- No deburring required
- Almost no waste during cutting
- End caps available with 1- to 4-poles, end caps can be broken out for further extensions
- 4-pole end cap molded in pairs (left and right)
- Overlapping rail extension possible
- Rails can be extended on demand by 1-pole rails (plug-in technology)
- All step distances
- 10 and 16 mm²
- Fork and stud
- Lugs can be broken out at any predetermined breaking point
- Self adhesive phase indication labels available
- Contact preventing caps (ZV-BS-G) can be used
- Simple, flexible handling
- All assembly requirements can be covered by the Busbar System xEffect
- Low storage space requirements due to modular system
- Less time consuming (no deburring, no cutting back)
- Individual and self configurable
- Fork-pin combination for 1+N application possible, feeding through rail (terminal clamp) not possible.
- Protected technology

Description	Step Distance (mm)	Cu-factor	Type Designation	Article No.	Units per package
-------------	--------------------	-----------	------------------	-------------	-------------------

xEffect busbar 1m 10mm², 16mm² (Fork) BB-EVF

for MCBs, RCCBs, RCBOs, SPDs

- Delivered without end caps

SG13113



SG13413

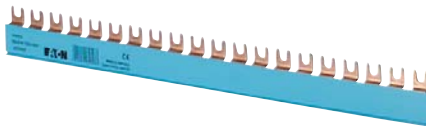

10 mm², Rated Current 63 A

1-phase	17.8	0.22	BB-EVF-10/1P-1MU	168826	10
	27	0.24	BB-EVF-10/1P-2MU	168830	10
	36	0.24	BB-EVF-10/1P-3MU	168834	10
2-phase	17.8	0.31	BB-EVF-10/2P-1MU	168838	10
	27	0.36	BB-EVF-10/2P-2MU	168840	10
3-phase	17.8	0.46	BB-EVF-10/3P-1MU	168842	10
	27	0.58	BB-EVF-10/3P-2MU	168844	10
	36	0.56	BB-EVF-10/3P-3MU	168850	10
3-phase + AUX	3x17.5+1x9	0.58	BB-EVF-10/3P-1MU/AUX	168846	10
	3x17.5+2x9	0.57	BB-EVF-10/3P-1MU2AUX	168848	10
Neutral	17.8	0.22	BB-EVF-10/N-1MU	168828	10
	27	0.24	BB-EVF-10/N-2MU	168832	10
	36	0.24	BB-EVF-10/N-3MU	168836	10

SG13213



SG13613

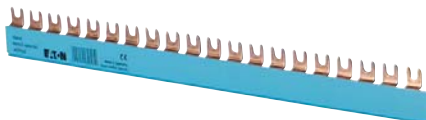

16 mm², Rated Current 80 A

1-phase	17.8	0.33	BB-EVF-16/1P-1MU	168827	10
	27	0.36	BB-EVF-16/1P-2MU	168831	10
	36	0.32	BB-EVF-16/1P-3MU	168835	10
2-phase	17.8	0.46	BB-EVF-16/2P-1MU	168839	10
	27	0.54	BB-EVF-16/2P-2MU	168841	10
3-phase	17.8	0.69	BB-EVF-16/3P-1MU	168843	10
	27	0.87	BB-EVF-16/3P-2MU	168845	10
	36	0.84	BB-EVF-16/3P-3MU	168851	10
3-phase + AUX	3x17.5+1x9	0.87	BB-EVF-16/3P-1MU/AUX	168847	10
	3x17.5+2x9	0.86	BB-EVF-16/3P-1MU2AUX	168849	10
Neutral	17.8	0.33	BB-EVF-16/N-1MU	168829	10
	27	0.36	BB-EVF-16/N-2MU	168833	10
	36	0.32	BB-EVF-16/N-3MU	168837	10

Description	Step Distance (mm)	Cu-factor	Type Designation	Article No.	Units per package
-------------	--------------------	-----------	------------------	-------------	-------------------

xEffect busbar 1m 10mm², 16mm² (Pin) BB-EVP

for MCBs, RCCBs, RCBOs, SPDs

- Delivered without end caps

SG13013



10 mm², Rated Current 63 A

1-phase	17.8	0.22	BB-EVP-10/1P-1MU	168852	10
	27	0.24	BB-EVP-10/1P-2MU	168856	10
	36	0.24	BB-EVP-10/1P-3MU	168860	10
2-phase	17.8	0.31	BB-EVP-10/2P-1MU	168864	10
	27	0.36	BB-EVP-10/2P-2MU	168866	10
3-phase	17.8	0.46	BB-EVP-10/3P-1MU	168868	10
	27	0.58	BB-EVP-10/3P-2MU	168870	10
3-phase + AUX	3x17.5+1x9	0.58	BB-EVP-10/3P-1MU/AUX	168872	10
	3x17.5+2x9	0.57	BB-EVP-10/3P-1MU2AUX	168874	10
Neutral	17.8	0.22	BB-EVP-10/N-1MU	168854	10
	27	0.24	BB-EVP-10/N-2MU	168858	10
	36	0.24	BB-EVP-10/N-3MU	168862	10

SG13513

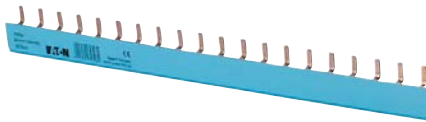

SG12913



16 mm², Rated Current 80 A

1-phase	17.8	0.33	BB-EVP-16/1P-1MU	168853	10
	27	0.36	BB-EVP-16/1P-2MU	168857	10
	36	0.32	BB-EVP-16/1P-3MU	168861	10
2-phase	17.8	0.46	BB-EVP-16/2P-1MU	168865	10
	27	0.54	BB-EVP-16/2P-2MU	168867	10
3-phase	17.8	0.69	BB-EVP-16/3P-1MU	168869	10
	27	0.87	BB-EVP-16/3P-2MU	168871	10
	36	0.84	BB-EVP-16/3P-3MU	168877	10
3-phase + AUX	3x17.5+1x9	0.87	BB-EVP-16/3P-1MU/AUX	168873	10
	3x17.5+2x9	0.86	BB-EVP-16/3P-1MU2AUX	168875	10
Neutral	17.8	0.33	BB-EVP-16/N-1MU	168855	10
	27	0.36	BB-EVP-16/N-2MU	168859	10
	36	0.32	BB-EVP-16/N-3MU	168863	10

SG13313

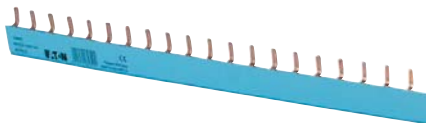

Description	Cu-factor	Type Designation	Article No.	Units per package
-------------	-----------	------------------	-------------	-------------------

Accessories

End caps BB-EV-EC

wa_sg05612



1-phase	-	BB-EV-EC/1P	168878	40
2+3-phase	-	BB-EV-EC/2-3P	168823	40
4-phase	-	BB-EV-EC/4P	168824	20
Neutral	-	BB-EV-EC/N	168879	20

Terminal BB-EV-TE/35

wa_sg05312



	0.04	BB-EV-TE/35	168825	3
--	------	-------------	--------	---

Sticker phase sequence

SG08713



	-	BB-S-PS	169831	5
--	---	---------	--------	---

Busbar Tag Shrouds ZV-BS-G

SG05705



	-	ZV-BS-G	104903	10/600
--	---	---------	--------	--------

Technical Data

BB-EV.	
General	
Heat deflection temperature	≥80°C UL94 V0
Standards	EN 60947-1:2007 / IEC 60947-1:2007 / IEC 60999:2000
Climate stability	according to DIN EN 60068
Insulation coordination	Overvoltage category III / Degree of pollution 2
Electrical	
Impulse voltage strenght	≥4.5 kV
Min. air distance	>5.5 mm
Min. creeping distance	>5 mm
Max. operating voltage	690 V AC/DC 1,000 V DC 1-pole only
Max. current I _g /Phase	
10 mm ²	63 A
16 mm ²	80 A
Protection class	IP20
Short circuit rating I _{CC}	25kA - NH3 355A gC500V JM
Dielectric strenght	PC - ABS >32 kV / mm

Assembly instruction:

Cutting

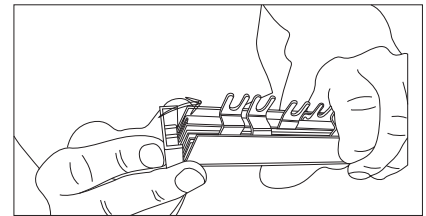
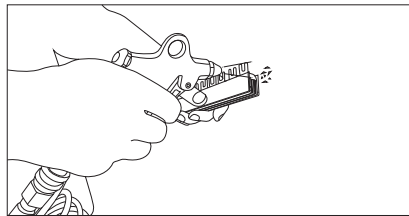
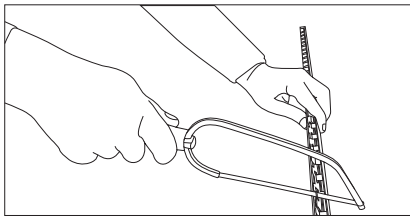

Mounting of an extension busbar

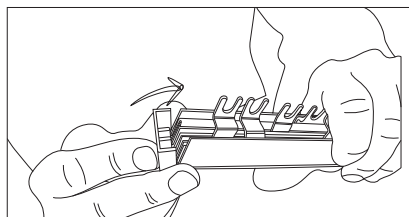
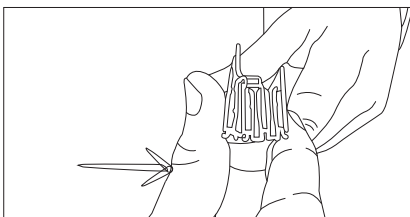
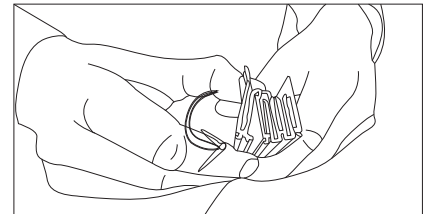
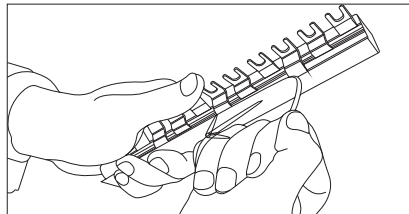
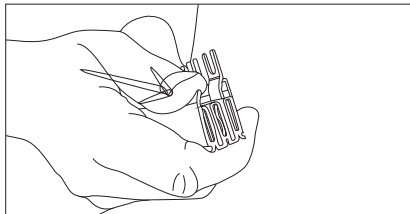

Overlapping mounting or further connection, resp.

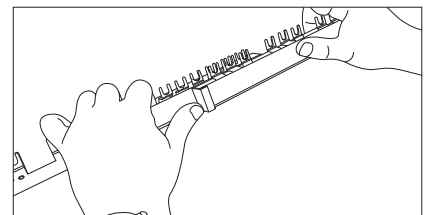
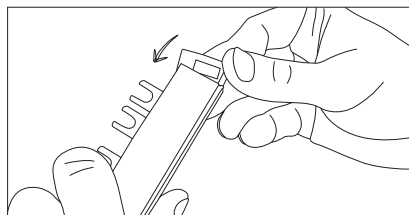
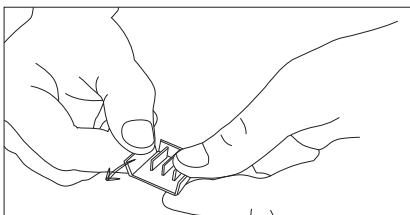

Bracking out of connection lugs

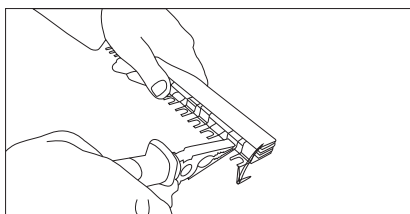

Sticking on phase marking

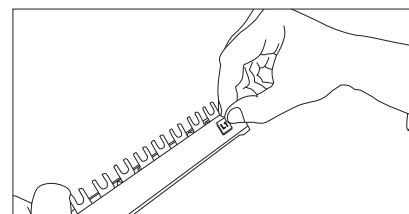

Busbar UL489 Z-BB/UL

SG13713



- For MCB FAZ-NA/RT/DU
- Sliceable
- 18 and 25 mm²
- Pin busbar
- Accessories available:
 - End cap
 - Terminal
 - Busbar tag shrouds
- Length 1 m

Description	Step Distance (mm)	Cu-factor	Type Designation	Article No.	Units per package
-------------	--------------------	-----------	------------------	-------------	-------------------

Busbar UL489 sliceable 1m 18mm², 25mm² (Pin), Z-BB/UL

for FAZ-NA/RT/DU

- Delivered without end caps

SG13713



18 mm², Rated Current 80 A

1-phase	17.6	0.39	Z-BB/UL18/1P1MU/57	171128	10
1-phase + AUX	26.4	0.378	Z-BB/UL18/1P1MU+AUX/37	171134	10
2x 1-phase + AUX	26.4	0.56	Z-BB/UL18/2X1P1MU+AUX/38	171142	10
3x 1-phase + AUX	26.4	0.945	Z-BB/UL18/3X1P1MU+AUX/39	171140	10
2-phase	17.6	0.625	Z-BB/UL18/2P1MU/56	171129	10
2-phase + AUX	17.6 + 26.4	0.625	Z-BB/UL18/2P1MU+AUX/46	171135	10
3-phase	17.6	0.95	Z-BB/UL18/3P1MU/57	171130	10
3-phase + AUX	2x 17.6 + 26.4	0.93	Z-BB/UL18/3P1MU+AUX/48	171136	10

SG14213



25 mm², Rated Current 100 A

1-phase	17.6	0.535	Z-BB/UL25/1P1MU/57	171131	10
1-phase + AUX	26.4	0.745	Z-BB/UL25/1P1MU+AUX/37	171137	10
2x 1-phase + AUX	26.4	0.78	Z-BB/UL25/2X1P1MU+AUX/38	171143	10
3x 1-phase + AUX	26.4	1.315	Z-BB/UL25/3X1P1MU+AUX/39	171141	10
2-phase	17.6	0.888	Z-BB/UL25/2P1MU/56	171132	10
2-phase + AUX	17.6 + 26.4	0.87	Z-BB/UL25/2P1MU+AUX/46	171138	10
3-phase	17.6	1.31	Z-BB/UL25/3P1MU/57	171133	10
3-phase + AUX	2x 17.6 + 26.4	1.28	Z-BB/UL25/3P1MU+AUX/48	171139	10

Description	Cu-factor	Type Designation	Article No.	Units per package
-------------	-----------	------------------	-------------	-------------------

Accessories

End cap Z-ECUL

-	Z-ECUL	171145	10
---	--------	--------	----

Terminal Z-TEUL35

0,038	Z-TEUL35	171144	10
-------	----------	--------	----









Busbar Tag Shrouds Z-FPUL

SG08613



-	Z-FPUL	171146	10
---	--------	--------	----

Description of the Busbar UL489, Z-BB/UL for FAZ-NA, -RT, -DU

									
Z-BB/UL18/1P1MU/57	171128	57	-	-	-	-	-	-	-
Z-BB/UL18/2P1MU/56	171129	-	56	-	-	-	-	-	-
Z-BB/UL18/3P1MU/57	171130	-	-	57	-	-	-	-	-
Z-BB/UL25/1P1MU/57	171131	57	-	-	-	-	-	-	-
Z-BB/UL25/2P1MU/56	171132	-	56	-	-	-	-	-	-
Z-BB/UL25/3P1MU/57	171133	-	-	57	-	-	-	-	-
Z-BB/UL18/1P1MU+AUX/37	171134	-	-	-	37	-	-	-	-
Z-BB/UL18/2P1MU+AUX/46	171135	-	-	-	-	-	-	46	-
Z-BB/UL18/3P1MU+AUX/48	171136	-	-	-	-	-	-	-	48
Z-BB/UL25/1P1MU+AUX/37	171137	-	-	-	37	-	-	-	-
Z-BB/UL25/2P1MU+AUX/46	171138	-	-	-	-	-	-	46	-
Z-BB/UL25/3P1MU+AUX/48	171139	-	-	-	-	-	-	-	48
Z-BB/UL18/3X1MU+AUX/39	171140	-	-	-	-	-	39	-	-
Z-BB/UL25/3X1MU+AUX/39	171141	-	-	-	-	-	39	-	-
Z-BB/UL18/2X1MU+AUX/38	171142	-	-	-	-	38	-	-	-
Z-BB/UL25/2X1MU+AUX/38	171143	-	-	-	-	38	-	-	-
Z-TEUL35	171144	-	-	-	-	-	-	-	-
Z-ECUL	171145	-	-	-	-	-	-	-	-
Z-FPUL	171146	-	-	-	-	-	-	-	-

Technical Data

Z-BB/UL	
General	
Heat deflection temperature	>100°C - UL94 V0
Standards	UL489, EN 60947-1, IEC 60947-1:2004
Climate stability	according to DIN EN 60068
Insulation coordination	Overvoltage category III / Degree of pollution 2
Electrical	
Impulse voltage strenght	≥10 kV
Min. air distance	≥1" ext.
Min. creeping distance	≥2" ext.
Max. operating voltage	
1-pole	1,000 V AC/DC
2-, 3-pole	600 V AC/DC
Max. current I _s /Phase	
18 mm ²	80 A
25 mm ²	100 A
Protection class	IP20
Short circuit rating I _{CC}	10 kA
Dielectric strenght	PA66-V0, >35 kV

Mounting example of busbar UL489, Z-BB/UL for FAZ-NA, -RT, -DU

Z-BB/UL18/XX
Z-BB/UL25/XX

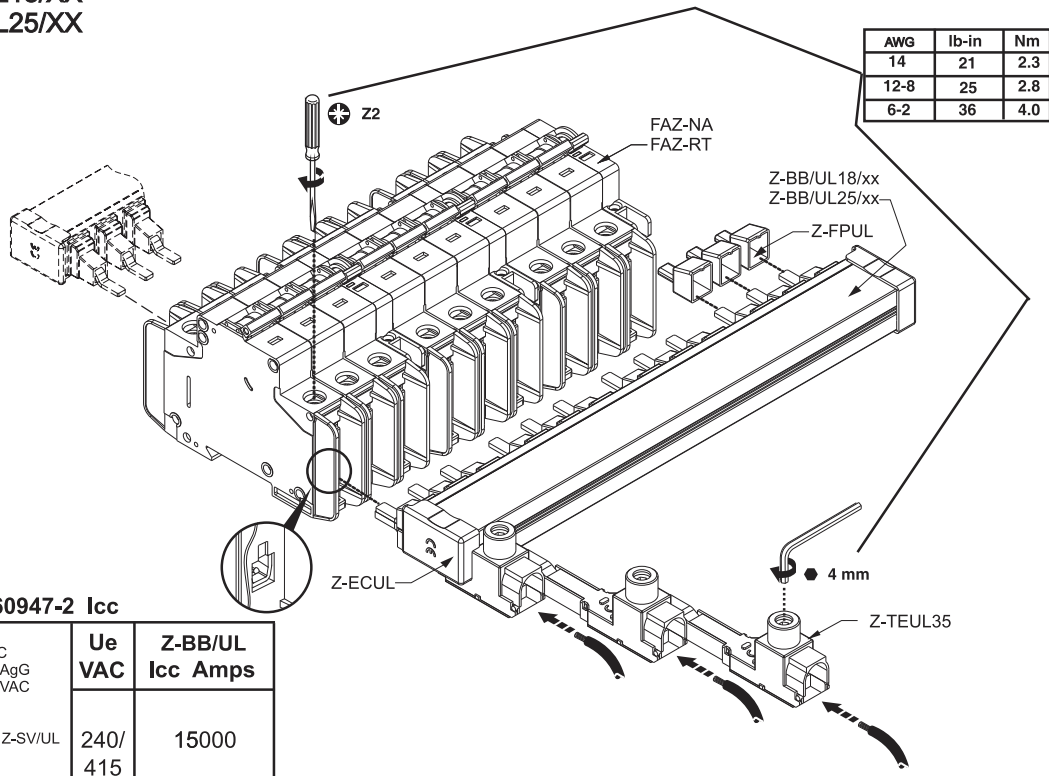

IEC/EN 60947-2 Icc

Ue HRC 315AgG 500VAC	Ue VAC	Z-BB/UL Icc Amps
Z-SV/UL	240/ 415	15000

UL SCCR

Ue Z-SV/UL	FAZ-NA FAZ-RT In Amps	Ue VAC	Z-BB/UL SCCR RMS Sym Amps
FAZ-NA FAZ-RT	0.5-32	480Y/ 277	10000
	35-40	240	10000

Busbar UL508 BB/UL

- For MCB FAZ
- Sliceable
- 18 and 25 mm²
- Pin busbar
- Accessories available:
 - End caps
 - Terminals
 - Busbar tag shrouds
- Length 1 m

Description	Step Distance (mm)	Cu-factor	Type Designation	Article No.	Units per package
-------------	--------------------	-----------	------------------	-------------	-------------------

Busbar UL508 sliceable 1m 18mm², 25mm² (Pin), BB/UL

for FAZ

- Delivered without end caps

18 mm², Rated Current 80 A

1-phase	17.8	0.33	BB-UL-18/1P-1M/57	121981	10
2-phase	17.8	0.508	BB-UL-18/2P-2M/56	121982	10
3-phase	17.8	0.8	BB-UL-18/3P-3M/57	121983	10
1-phase + AUX	27	0.33	BB-UL-18/1P-1,5M/37	121984	10
2-phase + AUX	17.8 + 26.7	0.52	BB-UL-18/2P+AS-2,5M/46	121987	10
3-phase + AUX	2x 17.8 + 26.7	0.8	BB-UL-18/3P+AS-3,5M/48	121988	10

25 mm², Rated Current 100 A

1-phase	17.8	0.45	BB-UL-25/1P-1M/57	121989	10
2-phase	17.8	0.68	BB-UL-25/2P-2M/56	121990	10
3-phase	17.8	1.07	BB-UL-25/3P-3M/57	121991	10
1-phase + AUX	27	0.45	BB-UL-25/1P-1,5M/37	121992	10
2-phase + AUX	17.8 + 26.7	0.69	BB-UL-25/2P+AS-2,5M/46	121995	10
3-phase + AUX	2x 17.8 + 26.7	1.03	BB-UL-25/3P+AS-3,5M/48	121996	10

Description	Cu-factor	Type Designation	Article No.	Units per package
-------------	-----------	------------------	-------------	-------------------

Accessories

End caps BB-UL-EC

1-phasig	-	BB-UL-EC/1	122000	10
3-phasig	-	BB-UL-EC/3	122001	10



Terminals BB-UL-TE

6 - 35mm ² (single and multi wire)	0,035	BB-UL-TEP/35	121997	10
6 - 50mm ²	0,038	BB-UL-TEPA/35	169823	10
6 - 50mm ² (single and multi wire)	0,038	BB-UL-TE/50	121998	10

Busbar Tag Shrouds BB-IP/5

for 5 pins	-	BB-IP/5	121999	10
------------	---	---------	--------	----

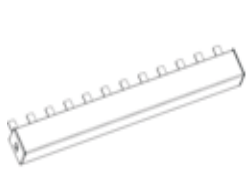
Description of the Busbar UL508, BB/UL for FAZ

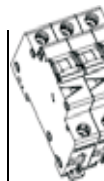
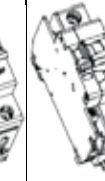
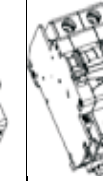
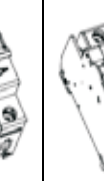
Article No.							
121981	BB-UL-18/1P-1M/57	57	-	-	-	-	-
121982	BB-UL-18/2P-2M/56	-	28	-	-	-	-
121983	BB-UL-18/3P-3M/57	-	-	19	-	-	-
121984	BB-UL-18/1P-1,5M/37	-	-	-	37	-	-
121987	BB-UL-18/2P+AS-2,5M/46	-	-	-	-	23	-
121988	BB-UL-18/3P+AS-3,5M/48	-	-	-	-	-	16
121989	BB-UL-25/1P-1M/57	57	-	-	-	-	-
121990	BB-UL-25/2P-2M/56	-	28	-	-	-	-
121991	BB-UL-25/3P-3M/57	-	-	19	-	-	-
121992	BB-UL-25/1P-1,5M/37	-	-	-	37	-	-
121995	BB-UL-25/2P+AS-2,5M/46	-	-	-	-	23	-
121996	BB-UL-25/3P+AS-3,5M/48	-	-	-	-	-	16
121997	BB-UL-TEP/35	-	-	-	-	-	-
169823	BB-UL-TEPA/35	-	-	-	-	-	-
121998	BB-UL-TE/50	-	-	-	-	-	-
121999	BB-IP/5	-	-	-	-	-	-
122000	BB-UL-EC/1	-	-	-	-	-	-
122001	BB-UL-EC/3	-	-	-	-	-	-

Technical Data

Z-BB/UL	
General	
Heat deflection temperature	125°C - UL94 V0
Standards	DIN EN 60947-2, VDE 0660 - 101 = IEC 60947-2, IEC 60999:2000, UL508, UL486A, CSA C22.2
Climate stability	according to DIN EN 60068
Insulation coordination	Overvoltage category III / Degree of pollution 2
Electrical	
Impulse voltage strenght	≥9.5 kV
Min. air distance	>9.5 mm
Min. creeping distance	>12.7 mm
Max. operating voltage	
1-pole	1,000 V AC/DC
2-, 3-pole	IEC/EN 690 V AC/DC 600 V AC/DC UL Fuse 480 V AC/DC UL-SP
Terminals	1, 000 V AC/DC
Max. current I _g /Phase	
18 mm ²	80 A (feed in the center: 160 A)
25 mm ²	100 A (feed in the center: 200 A)
Protection class	IP20
Short circuit rating	10kA 3 cycles@480V / 100 kA Fuse Class J 175A@18mm ² - 200A@25mm ²
Dielectric strenght	>32 kV/mm

Mounting example of busbar UL508, BB/UL for FAZ

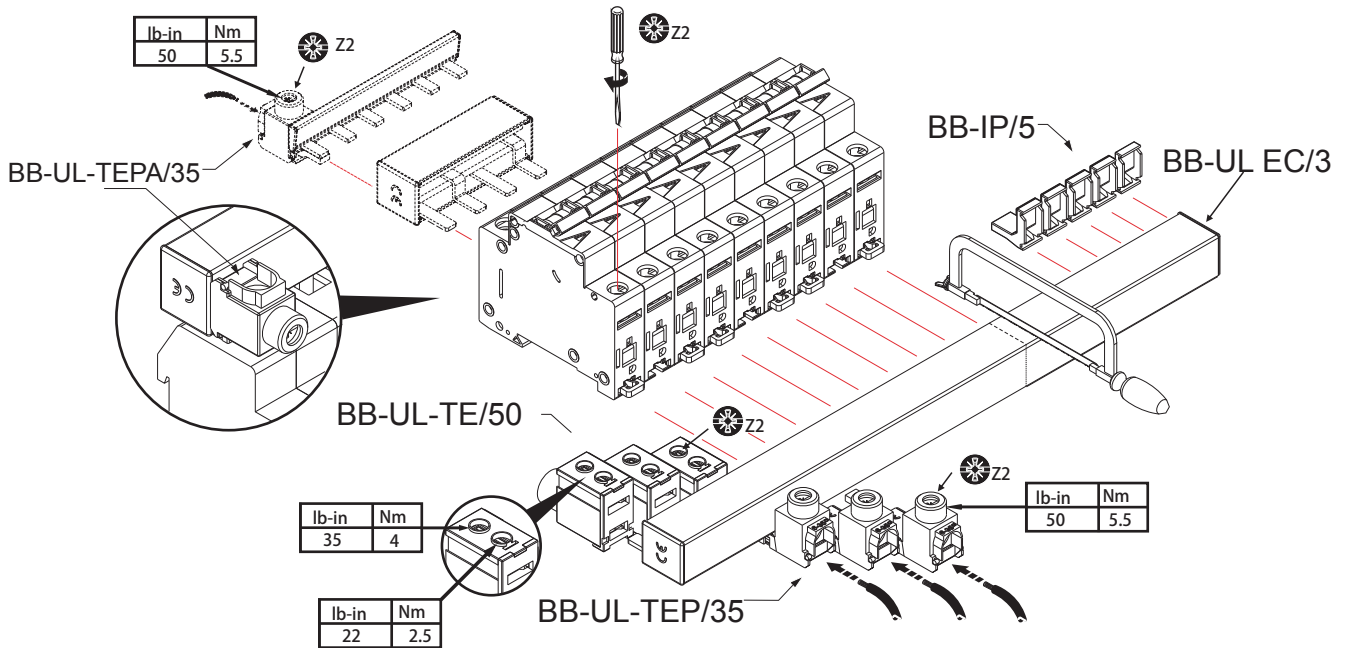

BB-UL-TE/50		
	UL508	EN/IEC 60947-2
U_e	480 V AC	240/690V AC
f	50/60 Hz	50/60 Hz
I_e	115 A @ 40° C	160 A @ 30° C
	#1-14 AWG 60/75° C Cu	1.5 – 50 mm ² Cu
	0.56 in	14 mm

BB-UL		
	UL508	EN/IEC 60947-2
U_e	480 V AC	690V AC
f	50/60 Hz	
I_{pk}	10kA	15kA
I_e	18mm \boxtimes	25mm \boxtimes
Infeed at the start of the busbar	80A@40° C	100A@30° C
Infeed at the center of the busbar	160A@40° C	200A@30° C

BB-UL-TEP/35 / BB-UL-TEPA/35		
	UL508	EN/IEC 60947-2
U_e	480 V AC	240/690V AC
f	50/60 Hz	50/60 Hz
I_e	115 A@40° C	80 A@30° C
	#2-14 AWG 60/75° C Cu	2.5 – 35 mm ² Cu
	0.56 in	14 mm

*-UL508 SHORT CIRCUIT RATINGS

-SUITABLE FOR USE ON A CIRCUIT CAPABLE OF DELIVERING NOT MORE THAN 10,000 RMS SYMETRICAL AMPERES, 600 VOLTS MAXIMUM.

-SUITABLE FOR USE ON A CIRCUIT CAPABLE OF DELIVERING NOT MORE THAN 100,000 RMS SYMETRICAL AMPERES, 600 VOLTS MAXIMUM WHEN PROTECTED BY A CLASS J FUSE RATED 175A.

Busbar UL489 Z-SV/UL16

wa_sg03511



- For MCB FAZ-NA/RT/DU
- 16 mm²
- Pin busbar
- Accessories available:
 - Terminals
 - Busbar tag shrouds
- Several length

Description	Step Distance (mm)	Cu-factor	Type Designation	Article No.	Units per package
-------------	--------------------	-----------	------------------	-------------	-------------------

Busbar UL489 16mm² (Pin), Z-SV/UL16

for FAZ-NA/RT/DU, not sliceable!!

- Delivered with end caps

wa_sg03511



16 mm², Rated Current 80 A

1-phase, 6MU	17.6	0.035	Z-SV/UL-16/1P-1MU/6	104892	10
1-phase, 12MU	17.6	0.07	Z-SV/UL-16/1P-1MU/12	104893	10
1-phase, 18MU	17.6	0.105	Z-SV/UL-16/1P-1MU/18	104894	10
2-phase, 6MU	17.6	0.07	Z-SV/UL-16/2P-2MU/6	104895	10
2-phase, 12MU	17.6	0.14	Z-SV/UL-16/2P-2MU/12	104896	10
2-phase, 18MU	17.6	0.21	Z-SV/UL-16/2P-2MU/18	104897	10
3-phase, 6MU	17.6	0.14	Z-SV/UL-16/3P-3MU/6	104898	10
3-phase, 12MU	17.6	0.221	Z-SV/UL-16/3P-3MU/12	104899	10
3-phase, 18MU	17.6	0.332	Z-SV/UL-16/3P-3MU/18	104900	10

Description	Cu-factor	Type Designation	Article No.	Units per package
-------------	-----------	------------------	-------------	-------------------

Accessories

Terminals Z-TEUL35

SG07506



2.5 - 35mm ²	0.035	Z-EK/35/UL	104901	3
1.5 - 50mm ²	0.038	Z-EB/50/UL	104902	3

Busbar Tag Shrouds Z-FPUL

SG07706



for 3 pins	-	ZV-BS-UL	104904	10
------------	---	----------	--------	----

Description of the Busbar UL489, Z-SV/UL-16 for FAZ-NA/RT/DU

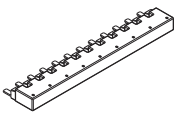
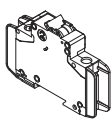
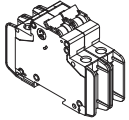
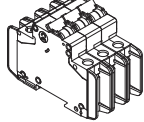
Article No.				
104892	Z-SV/UL-16/1P-1TE/6	6	-	-
104893	Z-SV/UL-16/1P-1TE/12	12	-	-
104894	Z-SV/UL-16/1P-1TE/18	18	-	-
104895	Z-SV/UL-16/2P-2TE/6	-	3	-
104896	Z-SV/UL-16/2P-2TE/12	-	6	-
104897	Z-SV/UL-16/2P-2TE/18	-	9	-
104898	Z-SV/UL-16/3P-3TE/6	-	-	2
104899	Z-SV/UL-16/3P-3TE/12	-	-	4
104900	Z-SV/UL-16/3P-3TE/18	-	-	6
104901	Z-EK/35/UL	-	-	-
104902	Z-EB/50/UL	-	-	-
104904	ZV-BS-UL	-	-	-

Technical Data

Z-SV/UL16	
General	
Heat deflection temperature	125°C - UL94 V0
Standards	
Busbar	UL489, DIN EN 60947-1, VDE 0660 part 100 = IEC 60947-1:2004, IEC 60947-2:2003
Terminal	IEC 60999:2000, UL489, UL486A, CSA C22.2
Climate stability	according to DIN EN 60068
Insulation coordination	Overvoltage category III / Degree of pollution 2
Electrical	
Impulse voltage strenght	≥9.5 kV (1kV / mmLS)
Min. air distance	>9.5mm/25.4mm (intern/external)
Min. creeping distance	>12.7mm/50.8mm (intern/external)
Max. operating voltage	
1-, 3-phase	690 V IEC 480Y/277V & 240V AC
Terminals	1,000 V AC/DC
Max. current I _g /Phase	80 A
Protection class	IP20
Short circuit rating	15kA with NH3 355 A gL 500V JM / 7.5kA 3 cycles @ 600V
Dielectric strenght	>30 kV/mm

Mounting example of busbar UL489, Z-SV/UL-16 for FAZ-NA, -RT, -DU



ATTENTION: Maximum of 3 commoning links allowed. Any combination of same pole configuration.

ATTENTION: 3 liaisons communes autorisées au maximum. Toute combinaison de configurations de polarité identiques.

ACHTUNG: Maximal 3 Schienenblöcke. Beliebige Kombination gleichpoliger Konfigurationen.

ATTENZIONE: Sono consentiti al massimo 3 pettini di collegamento in qualsiasi combinazione della stessa configurazione di poli.

ATENCIÓN: Se permite un máximo de 3 enlaces comunes.

Cualquier combinación del mismo tipo de configuración de polo



ATTENTION: Do not cut.

ATTENTION: Ne pas couper.



ACHTUNG: Nicht durchschneiden.

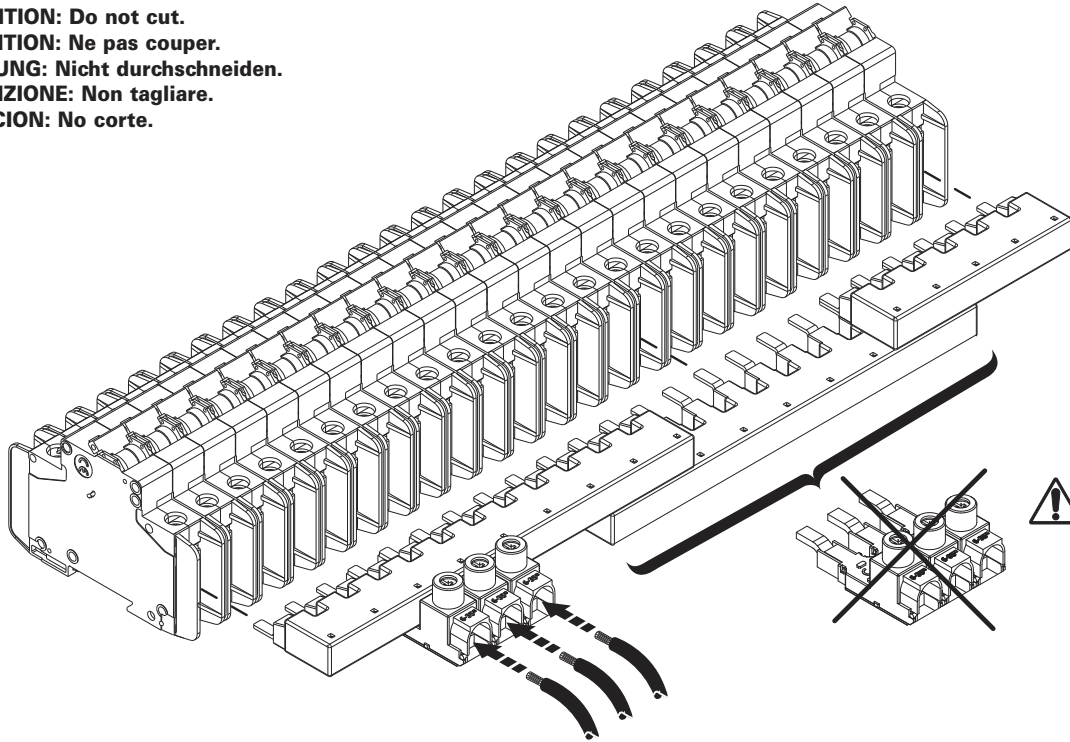

ATTENZIONE: Non tagliare.

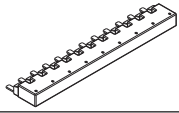
ATENCIÓN: No corte.

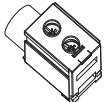

	UL489		EN/IEC 00947-2
U_e	480 V AC	96 V DC	240/415 V AC
f	50/60 Hz	-----	50/60 Hz
U_{imp}	-----		9.5 kV
I_e	80 A @ 40°C		80 A @ 30°C
Cross section	-----		16 mm ²

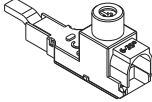
	UL489		EN/IEC 00947-2
U_e	480 V AC	96 V DC	240/415 V AC
f	50/60 Hz	-----	50/60 Hz
U_{imp}	-----		9.5 kV
	#1-14 AWG 60/75°C Cu	1.5-50 mm ² Cu	
	0.56 in		14 mm

	UL489		EN/IEC 00947-2
U_e	480 V AC	96 V DC	240/415 V AC
f	50/60 Hz	-----	50/60 Hz
U_{imp}	-----		9.5 kV
I_e	80 A @ 40°C		80 A @ 30°C
	#2-14 AWG 60/75°C Cu	2.5-35 mm ² Cu	
	0.56 in		14 mm

Mounting example of busbar UL489, Z-SV/UL-16 for FAZ-NA, -RT, -DU

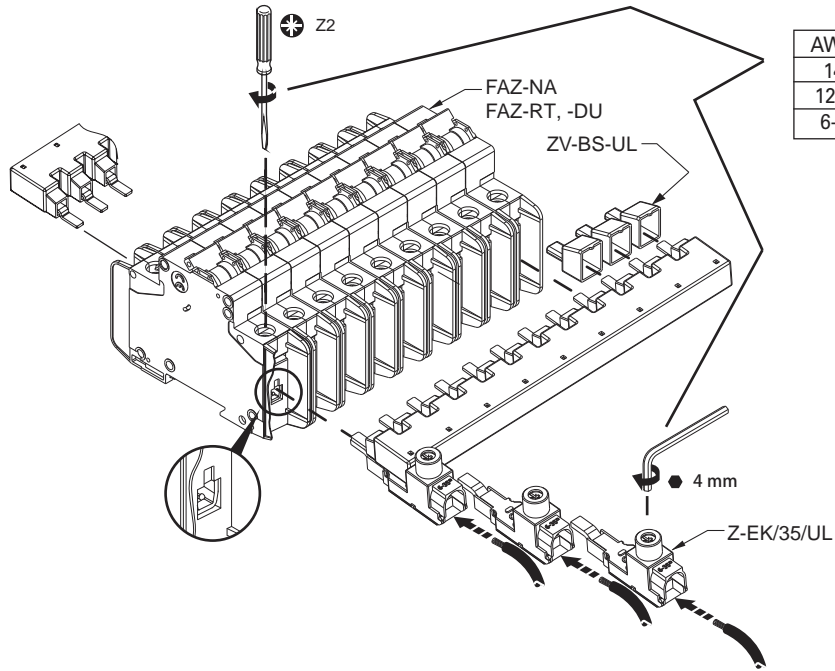

AWG	lb-in	Nm
14	21	2.3
12-8	25	2.8
6-2	36	4.0

IEC/EN 60947-2 Icc

	Ue	Z-SV/UL
	VAC	Icc Amps
	240/ 415	15000

UL SCCR

	FAZ-NA FAZ-RT/-DU In Amps	Ue	Z-SV/UL SCCR RMS Sym Amps
		VAC	
	0.5-32	480Y/ 277	10000
	35-40	240	10000

Accessories for RCDs, MCBs, Combined RCD/MCB Devices

SG60811







- Auxiliary Switch
- RCD-Tripping Module
- Shunt Trip Release
- Undervoltage Release
- Remote Control and Automatic Switching Device
- Switching Interlocks
- Terminal Covers

SG60811



Auxiliary Switch Z-HK, Z-AHK, Z-HD; Tripping Signal Switch Z-NHK

Design: for screwing

	For Protective Device / Function	Type Designation	Article No.	Units per package
 <p>SG34812</p>	RCCB / 1NO+1NC	Z-HK	248432	4/120
 <p>SG60911</p>	MCB, RCBO, RCCB / 1NO+1NC	Z-AHK	248433	4/120
 <p>SG61011</p>	MCB, RCBO, RCCB / 2CO	Z-NHK	248434	4/120
 <p>SG34412</p>	RCCB / 1CO+1NC	Z-HD	265620	1

Specifications | Auxiliary Switch Z-HK, Z-AHK; Tripping Signal Switch Z-NHK

Description

- Design according to IEC/EN 60947-5-1, IEC/EN 62019
- Can be mounted subsequently (screws) onto FRCmM, FRCdM
- The specified minimum voltages are per contact.
Take into account particularly in case of series connection!
- **Z-AHK, Z-NHK:** Contact function with relative movement (self-cleaning contacts)
- Contact material and design particularly suitable for extra low voltage
- **Z-NHK:** The function of one of the two change-over contacts can be switched from "auxiliary switch" to "tripping signal switch"
- Tripping signal contact transmits message of electric tripping, not mechanical switch-off
- Test key for contact function "electrical tripping"

Technical Data

	Z-HK	Z-AHK	Z-NHK
Electrical			
Contact function	1NO + 1NC	1NO + 1NC	2CO
Rated voltage	250 V	250 V	250 V
Frequency	50/60 Hz	50/60 Hz	50/60 Hz
Rated current	8 A	4 A	4 A
Rated thermal current	I_{th} 8 A	4 A	4 A
Utilisation category AC13			
Rated operational current	I_e 6A/250V AC 2A/440V AC	3A/250V AC -	3A/250V AC -
Utilisation category AC15			
Rated operational current	I_e -	2A/250V AC	2A/250V AC
Utilisation category DC12			
Rated operational current	I_e -	0.5A/110V DC	0.5A/110V DC
Utilisation category DC13			
Rated operational current	I_e 0.5A/230V DC 2A/110V DC 4A/60V DC	- - -	- - -
Rated insulation voltage	U_i 250 V AC	250 V AC	250 V AC
Minimum operational voltage per contact	U_{min} 24 V AC/DC	5 V DC	5 V DC
Minimum operational current	I_{min} 50 mA AC/DC	10 mA DC	10 mA DC
Rated peak withstand voltage	$U_{imp} (1.2/50\mu)$ 2.5 kV	2.5 kV	2.5 kV
Conditional short circuit current	I_k		
with back-up fuse 6A or FAZ-B4-HS	1 kA	1 kA	1 kA
Max. back-up fuse, overload and short circuit	6 A gL / FAZ-4/..B-HS	4 A gL / FAZ-4/..B-HS	4 A gL / FAZ-4/..B-HS
Mechanical			
Can be mounted from the left onto	RCCB	MCB, RCBO	MCB, RCBO
Can be mounted from the right onto	-	-	RCCB
Tripping indicator "electrical tripping"	-	-	blue/white
Frame size	45 mm	45 mm	45 mm
Device height	80 mm	80 mm	80 mm
Device width	8.8 mm (0.5MU)	8.8 mm (0.5MU)	8.8 mm (0.5MU)
Mounting	onto switching device	onto switching device	onto switching device
Degree of protection, built-in	IP40	IP40	IP40
Terminal protection	finger and hand touch safe according to BGV A3, ÖVE-EN 6		
Terminals	lift terminals	lift terminals	lift terminals
Terminal capacity	0.5-2.5 mm ²	0.5-2.5 mm ²	0.5-2.5 mm ²
Terminal screws	M3 (Pozidrive Z0)	M3 (Pozidrive Z0)	M3 (Pozidrive Z0)
Fastening torque of terminal screws	max. 0.8-1.0 Nm	max.0.8-1.0 Nm	max. 0.8-1.0 Nm

Connection diagram

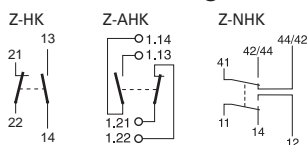

Dimensions (mm)

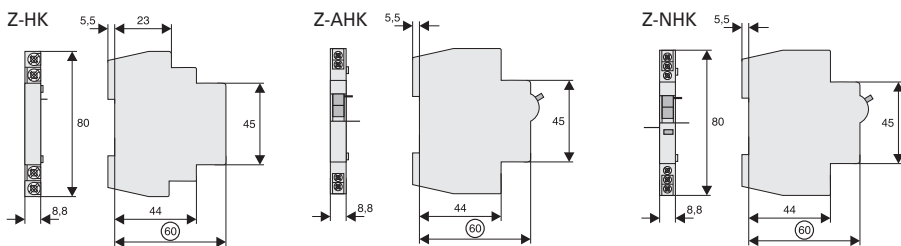

Example: Z-HK+RCCB

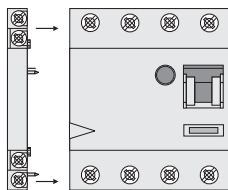

1NO+1NC 24V 50mA min.

Example: Z-AHK+MCB

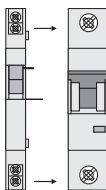

1NO+1NC 5V 10mA min.

Example: Z-NHK+MCB RCCB+Z-NHK

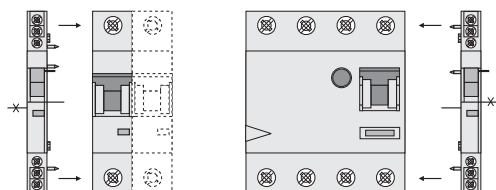

2CO 5V 10mA min.

Specifications | Auxiliary Switch Z-HD

Function Auxiliary Switch Z-HD

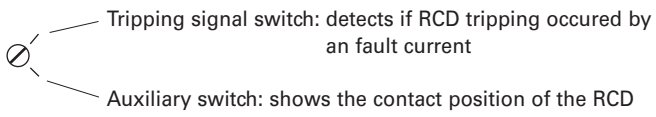

Technical Data

Z-HD	
Electrical	
Subsequent installation to the left onto	FRCmM-125A
Contacts	1CO + 1NC
Load rating	
AC11	6 A / 230 V AC
DC11	1 A / 230 V DC
Mechanical	
Terminal capacity	up to 2.5 mm ²

Connection diagram

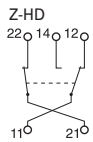

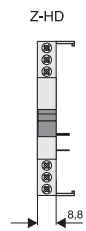

Dimensions (mm)



Auxiliary Switch ZP-AHK, ZP-IHK, ZP-WHK; Tripping Signal Switch ZP-NHK

Design: for snapping

	For Protective Device / Function	Type Designation	Article No.	Units per package
 <p>SG60811</p>	MCB, RCBO / 1NO+1NC	ZP-IHK	286052	4/120
 <p>SG34612</p>	MCB, RCBO / 1CO	ZP-WHK	286053	4/120
 <p>SG34512</p>	MCB, RCBO / 2CO	ZP-NHK	248437	4/120

Specifications | Auxiliary Switch ZP-IHK, ZP-WHK; Tripping Signal Switch ZP-NHK

Description

- Design according to IEC/EN 62019
- No screws required. Can be snapped onto FAZ and FRBmM-1N subsequently
- **ZP-IHK, ZP-WHK:** Can be snapped on additionally 1 time onto itself
- The specified minimum voltages are per contact. Take into account particularly in case of series connection!
- Contact material and design particularly suitable for extra low voltage.
- Contact function with relative movement (self-cleaning contacts)e)
- **ZP-NHK:** The function of one of the two change-over contacts can be switched from "auxiliary switch" to "tripping signal switch"
- Tripping signal contact transmits message of electric tripping, not mechanical switch-off
- **ZP-NHK:** The "Service button" is used to check whether or not the auxiliary switch is correctly wired in the tripping-signal-switch position. Activating the "service button" will mechanically simulate an electrical switch-off, so the mechanism for the electrical switchoff will disengage and can be checked. The main switchgear (MCB or combined MCB/RCD) connected to the ZP-NHK auxiliary switch does not need to trip as well during an inspection through the service button.

Technical Data

	ZP-IHK	ZP-WHK	ZP-NHK
Electrical			
Contact function	1NO + 1NC	1CO	2CO
Rated voltage	250 V	250 V	250 V
Frequency	50/60 Hz	50/60 Hz	50/60 Hz
Rated current	6 A	6 A	4 A
Rated thermal current	I_{th} 6 A	6 A	4 A
Utilisation category AC13			
Rated operational current	I_e 3A/250V AC	3A/250V AC	3A/250V AC
Utilisation category AC15			
Rated operational current	I_e 2A/250V AC	2A/250V AC	2A/250V AC
Utilisation category DC12			
Rated operational current	I_e 0.5A/110V DC	0.5A/110V DC	0.5A/110V DC
Rated insulation voltage	U_I 250 V AC	250 V AC	250 V AC
Minimum operational voltage per contact	U_{min} 5 V DC	5 V DC	5 V DC
Minimum operational current	I_{min} 10 mA DC	10 mA DC	10 mA DC
Rated peak withstand voltage	U_{imp} (1.2/50 μ) 2.5 kV	2.5 kV	2.5 kV
Conditional short circuit current			
with back-up fuse 6A or PLSM-B4-HS	I_k 1 kA	1 kA	1 kA
Max. back-up fuse, overload and short circuit	6 A gL / FAZ-B4-HS	6 A gL / FAZ-B4-HS	6 A gL / FAZ-B4-HS
Mechanical			
Can be mounted from the left onto	MCB, RCBO	MCB, RCBO	MCB, RCBO
Accessories:	ZP-ASA	ZP-ASA	ZP-ASA
Tripping indicator "electrical tripping"	–	–	blue/white
Frame size	45 mm	45 mm	45 mm
Device height	80 mm	80 mm	80 mm
Device width	8.8 mm (0.5MU)	8.8 mm (0.5MU)	8.8 mm (0.5MU)
Degree of protection, built-in	IP40	IP40	IP40
Terminal protection	finger and hand touch safe according to BGV A3, ÖVE-EN 6		
Terminals	lift terminals	lift terminals	lift terminals
Terminal capacity	0.5-2.5 mm ²	0.5-2.5 mm ²	0.5-2.5 mm ²
Terminal screws	M4 (Pozidrive Z2)	M4 (Pozidrive Z2)	M3 (Pozidrive Z0)
Fastening torque of terminal screws	max. 1.2 Nm	max. 1.2 Nm	max. 0.8-1.0 Nm

Connection diagram

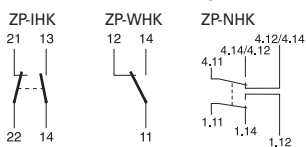

Dimensions (mm)

ZP-IHK, ZP-WHK

ZP-NHK

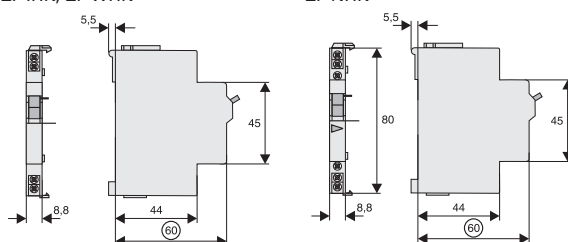

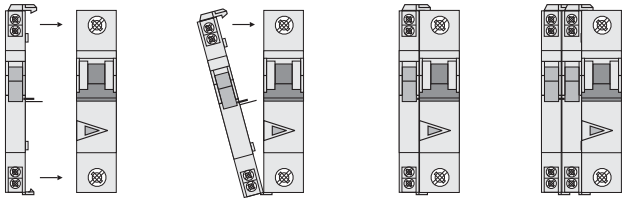

Example: ZP-IHK/(ZP-WHK)+MCB

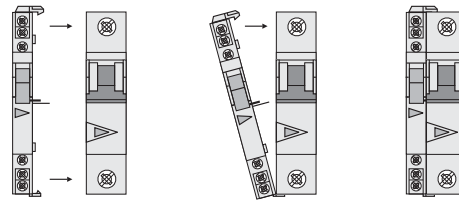

Example: ZP-NHK+MCB



RCCB-Tripping Module Z-.AM

	For Protective Device	Type Designation	Article No.	Units per package
 <p>SG16011</p>	RCCB	Z-FAM	248293	1/60
 <p>SG16211</p>	RCBO	Z-KAM	248294	1/60

Specifications | RCCB Tripping Module Z-FAM, Z-KAM

Description

- For remote switch-off of RCCBs, standard and electronic combined RCD/MCB devices
- Remote switch-off by one or several parallel potential-free contacts, e.g. pushbutton max. rated current 3 A at 250 V, take into account maximum pushbutton voltage
- Remote tripping test by means of remote testing module Z-FW
- Can be mounted subsequently, to be wired according to connection diagram with the respective terminals of the RCCB
- No undesired voltage rise in the consumer system during remote switch-off thanks to integrated breaker contact K1-K2

Technical Data

	Z-FAM	Z-KAM
Electrical		
Rated voltage	230(400) V AC	230(400) V AC
Frequency	50-60 Hz	50-60 Hz
Rated tripping current	$I_{\Delta n}$ 0.01 - 0.3 A	0.01 - 0.3 A
Function	1NO	1NO
Mechanical		
Tripping module for	RCCB	RCBO
Frame size	45 mm	45 mm
Device height	80 mm	80 mm
Device width	8.8 mm (0.5MU)	8.8 mm (0.5MU)
Degree of protection, built-in	IP40	IP40
Terminal capacity	1 - 2x2.5 mm ²	1 - 2x2.5 mm ²
Terminal protection	finger and hand touch safe, according to BGV A3, ÖVE-EN 6	

Connection diagram

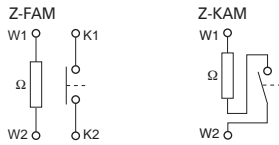

Dimensions (mm)

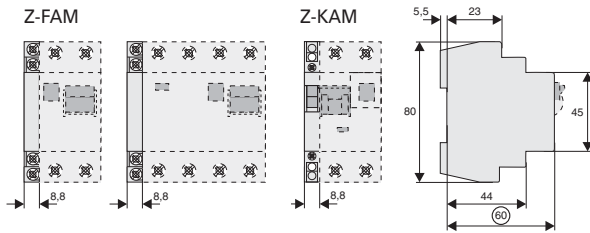

Connection examples

Lay lines to the switching devices with double insulation **and** overload protection, e.g. 4A gL or CLS6-4..-HS

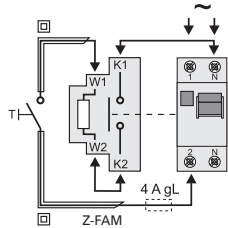

Connection diagram:
RCCB-2p, RCCB feed above

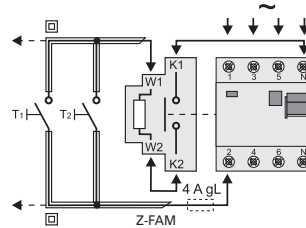

Connection diagram:
RCCB-4p, RCCB feed above

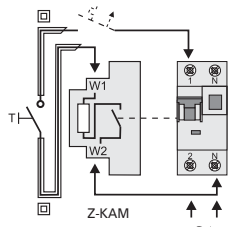

Connection diagram:
RCBO-2p, RCBO feed below

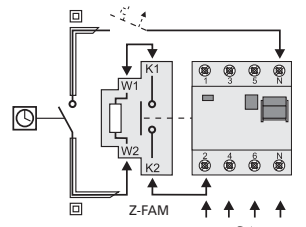

Connection diagram:
RCCB-4p, RCCB feed below

Shunt Trip Release Z-ASA, ZP-ASA

Operational voltage range (V-)	Type Designation	Article No.	Units per package
--------------------------------	------------------	-------------	-------------------

SG00712



To be glued on

12-110	Z-ASA/24	248286	1/60
110-415	Z-ASA/230	248287	1/60

SG00212



To be snapped on

12-110	ZP-ASA/24	248438	1/60
110-415	ZP-ASA/230	248439	1/60

Specifications | Shunt Trip Release Z-ASA, ZP-ASA

Description

- Remote release for subsequent mounting onto FAZ, FRBmM-1N, Z-MS
- Module width 1MU
- Additional installation of standard auxiliary switch is possible
- Position indicator red - green
- Type ZP-ASA for snap-on mounting

Technical Data

	Z-ASA24	Z-ASA230	ZP-ASA24	ZP-ASA230
Electrical				
Minimum pulse duration	15 ms	10 ms	15 ms	10 ms
Internal resistance	2.2 Ω	215 Ω	2.2 Ω	215 Ω
Duty cycle	100%	100%	100%	100%
Tripping time	< 20 ms	< 20 ms	< 20 ms	< 20 ms
Rated peak withstand voltage (1.2/50μs)	2.5 kV	2.5 kV	2.5 kV	2.5 kV
Endurance	> 4000 operating cycles	> 4000 operating cycles	> 4000 operating cycles	> 4000 operating cycles
AC voltage range				
Operating limit	10 V	60 V	10 V	60 V
Operational voltage range	12-110 V	110-415 V	12-110 V	110-415 V
Maximum current consumption during switch-on	15 A		2.1 A	15 A
Current flow time at max. current consumption	10 ms		10 ms	10 ms
DC voltage range				
Operating limit	9 V	72 V	9 V	72 V
Operational voltage range	10-60 V	110-220 V	10-60 V	110-220 V
Maximum current consumption during switch-on	21 A		1 A	21 A
Current flow time at max. current consumption	2 ms		2 ms	2 ms
Mechanical				
Frame size	45 mm	45 mm	45 mm	45 mm
Device height	80 mm	80 mm	80 mm	80 mm
Device width	17.5 mm (1MU)	17.5 mm (1MU)	17.5 mm (1MU)	17.5 mm (1MU)
Mounting	bonding	bonding	to snap on	to snap on
Degree of protection, built-in	IP40	IP40	IP40	IP40
Terminals above/below	open mouthed/lift	open mouthed/lift	open mouthed/lift with guide	open mouthed/lift with guide
Klemmquerschnitt	1-25 mm ²	1-25 mm ²	1-25 mm ²	1-25 mm ²
Fastening torque of terminal screws	max. 2.4 Nm	max. 2.4 Nm	max. 2.4 Nm	max. 2.4 Nm

Connection diagram

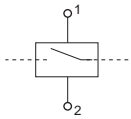

Dimensions (mm)

Z-ASA

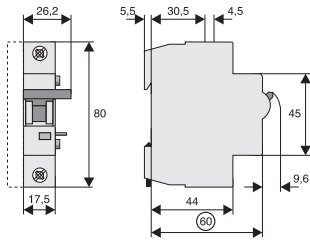

ZP-ASA

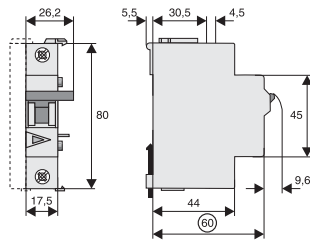

Connection Example 230 V

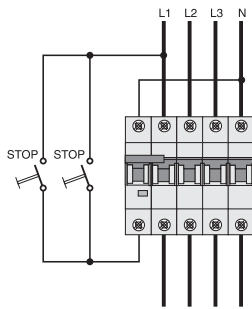

Connection Example 24 V

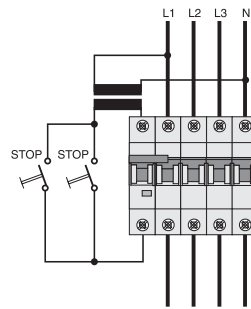

Example: Z-ASA + MCB

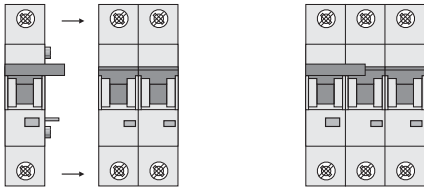

Example: ZP-ASA + MCB

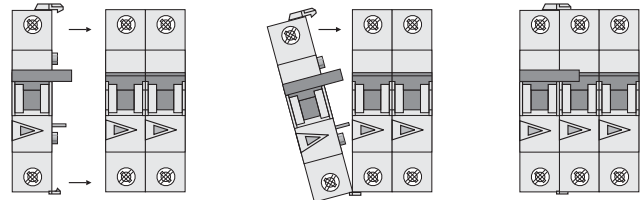

Undervoltage Release Z-USA, Z-USD

SG78811



Operational voltage range (V-) / Function	Type Designation	Article No.	Units per package
To be screwed on			
115 / undelayed	Z-USA/115	248288	1/60
230 / undelayed	Z-USA/230	248289	1/60
400 / undelayed	Z-USA/400	248290	1/60
115 / delayed 0.4s	Z-USD/115	248292	1/60
230 / delayed 0.4s	Z-USD/230	248291	1/60

Specifications | Undervoltage Release Z-USA, Z-USD

Description

- Tripping:
Instantaneous Z-USA
Delayed Z-USD, typ. 0,4 s
- Voltage control indicator blue/white
- Service key for zero voltage switch-on for testing purposes
- Can be used with FAZ

Technical Data

	Z-US./115	Z-US./230	Z-US./400
Electrical			
Rated voltage	U_n 115 V AC	230 V AC	400 V AC
Frequency	50-60 Hz	50-60 Hz	50-60 Hz
Making threshold	80% of U_n	80% of U_n	80% of U_n
Tripping threshold	50% of U_n	50% of U_n	50% of U_n
Mechanical			
Frame size	45 mm	45 mm	45 mm
Device height	80 mm	80 mm	80 mm
Device width	17.5 mm (1MU)	17.5 mm (1MU)	17.5 mm (1MU)
Mounting	quick fastening on DIN rail IEC/EN 60715		
Degree of protection, built-in	IP40	IP40	IP40
Terminals	open mouthed/lift	open mouthed/lift	open mouthed/lift
Terminal capacity	1 - 2x2.5 mm ²	1 - 2x2.5 mm ²	1 - 2x2.5 mm ²
Terminal protection	finger and hand touch safe, according to BGV A3, ÖVE-EN 6		

Connection diagram

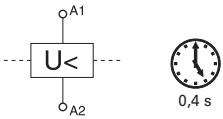

Dimensions (mm)

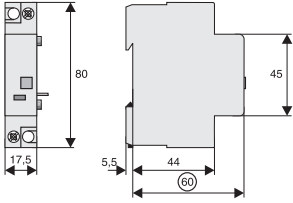

Connection Example Release

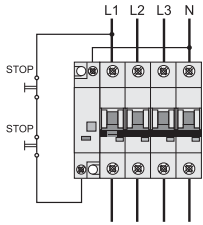

Connection Examples 400V and 230V

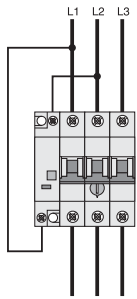

Connection example
Z-USA/400 + Z-MS

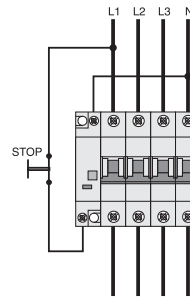

Connection example
Z-USA/230 + MCB

Switching interlocks IS/SPE-1TE, Z-IS/SPE-1TE

	Description	Type Designation	Article No.	Units per package
	Switching interlock without lock for Isolators, RCDs, combined RCD/MCBs, ...	IS/SPE-1TE	101911	5/30
	Switching interlock without lock for MCBs and Circuit Breaker ZP-A	Z-IS/SPE-1TE	274418	5/30

Specifications | Switching interlocks IS/SPE-1TE, Z-IS/SPE-1TE

Description

- Without lock

Type IS/SPE-1TE:

- for Isolators, RCDs, combined RCD/MCBs, ...

Type Z-IS/SPE-1TE:

- for MCB



Accessories for Add-on Residual Current Protection Unit FBHmV

Shunt Trip Release Kit Z-BHASA

	Operational voltage range V~	Type Designation	Article No.	Units per package
	110-415	Z-BHASA/230	248445	8
	12-60	Z-BHASA/24	248444	8

Specifications | Shunt Trip Release Kit Z-BHASA

Description

- Can be mounted subsequently
- Contact position indicator red - green
- Wide operational voltage range
- Sufficient power of extra low voltage source must be ensured
FBHmV-ASA/24: min. 90 VA
- Screws for mounting included FBHmV => BHASA => AZ

Accessories for Add-on Residual Current Protection Unit FBHmV

Technical Data

	Z-BHASA/24	Z-BHASA/230
Electrical		
Minimum pulse duration	15 ms	10 ms
Internal resistance	2 W	130 W
Duty	100%	100%
Tripping time	< 20 ms	< 20 ms
Peak withstand voltage (1.2/50µs)	2 kV	2 kV
Endurance	>4,000 operating cycles	>4,000 operating cycles
AC voltage range:		
Responding limit	8 V	70 V
Operational voltage range	12-60 V	110-415 V
Maximum current consumption during switch-on	14 A	3.4 A
Current flow time at max. current consumption	4.0 ms	4.5 ms
DC voltage range:		
Responding limit	11 V	90 V
Operational voltage range	12-60 V	110-230 V
Maximum current consumption during switch-on	23.5 A typ.	1.7 A typ.
Current flow time at max. current consumption	2 ms	4 ms
Mechanical		
Frame size	45 mm	45 mm
Device height	90 mm	90 mm
Device width	27 mm	27 mm
Mounting	quick fastening on DIN rail IEC/EN 60715	
Degree of protection, built-in	IP40	IP40
Upper and lower terminal screws	lift terminals	lift terminals
Terminal capacity	2.5-30 mm ²	2.5-30 mm ²
Fastening torque of terminal screws	4 Nm	4 Nm

Connection diagram

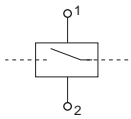

Dimensions (mm)

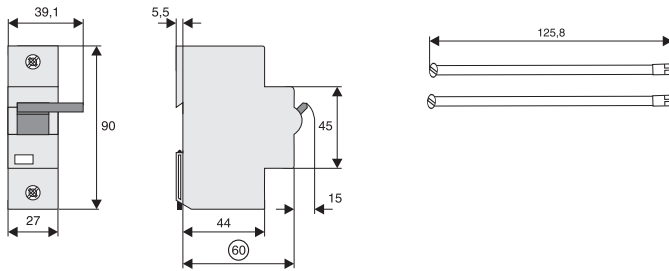

Accessories for Miniature Circuit Breakers AZ

Shunt Trip Release Z-LHASA

	Operational voltage range V~	Type Designation	Article No.	Units per package
	110-415	Z-LHASA/230	248442	8
	12-60	Z-LHASA/24	248441	8

Specifications | Shunt Trip Release Z-LHASA

Description

- Can be mounted subsequently
- Contact position indicator red - green
- Wide operational voltage range
- Sufficient power of extra low voltage source must be ensured
Z-LHASA/24: min. 90 VA

Technical Data

	Z-LHASA/24	Z-LHASA/230
Electrical		
Minimum pulse duration	15 ms	10 ms
Internal resistance	2 W	130 W
Duty	100%	100%
Tripping time	< 20 ms	< 20 ms
Peak withstand voltage (1.2/50µs)	2 kV	2 kV
Endurance	>4,000 operating cycles	>4,000 operating cycles
AC voltage range:		
Responding limit	8 V	70 V
Operational voltage range	12-60 V	110-415 V
Maximum current consumption during switch-on	14 A	3.4 A
Current flow time at max. current consumption	4.0 ms	4.5 ms
DC voltage range:		
Responding limit	11 V	90 V
Operational voltage range	12-60 V	110-230 V
Maximum current consumption during switch-on	23.5 A typ.	1.7 A typ.
Current flow time at max. current consumption	2 ms	4 ms
Mechanical		
Frame size	45 mm	45 mm
Device height	90 mm	90 mm
Device width	27 mm	27 mm
Mounting	quick fastening on DIN rail IEC/EN 60715	
Degree of protection, built-in	IP40	IP40
Upper and lower terminal screws	lift terminals	lift terminals
Terminal capacity	2.5-30 mm ²	2.5-30 mm ²
Fastening torque of terminal screws	4 Nm	4 Nm

Connection diagram

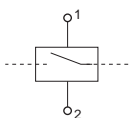

Dimensions (mm)

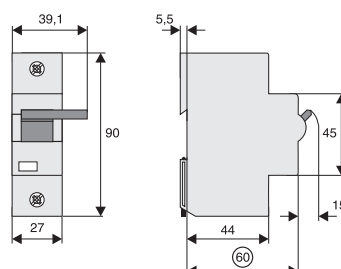

Accessories for Miniature Circuit Breakers AZ

Auxiliary Switch Z-LHK

Function	Type Designation	Article No.	Units per package
1NO+1NC	Z-LHK	248440	10/100

SG16111



Specifications | Auxiliary Switch Z-LHK

Description

- Auxiliary switch according to IEC 947-5-1
- Can be mounted subsequently

Technical Data

		Z-LHK
Electrical		
Contact function		1NO + 1NC
Rated voltage		250 V
Frequency		50/60 Hz
Rated current		8 A
Rated thermal current	I_{th}	8 A
Utilisation category AC13		
Rated operational current	I_e	6A/250V AC 2A/440V AC
Utilisation category AC15		
Rated operational current	I_e	–
Utilisation category DC12		
Rated operational current	I_e	–
Utilisation category DC13		
Rated operational current	I_e	0.5A/230V DC 2A/110V DC 4A/60V DC
Rated insulation voltage	U_I	250 V AC
Minimum operational voltage per contact	U_{min}	24 V AC/DC
Minimum operational current	I_{min}	50 mA AC/DC
Rated peak withstand voltage	$U_{imp} (1.2/50\mu)$	2.5 kV
Conditional short circuit current	I_k	1 kA
with back-up fuse 6A or FAZ-B4-HS		
Max. back-up fuse, overload and short circuit		6 A gL / FAZ-4/..B-HS
Mechanical		
Can be mounted from the left onto		AZ
Can be mounted from the right onto		–
Tripping indicator "electrical tripping"		–
Frame size		45 mm
Device height		80 mm
Device width		8.8 mm (0.5MU)
Mounting		onto switching device
Degree of protection, built-in		IP40
Terminal protection		finger and hand touch safe according to BGV A3, ÖVE-EN 6
Terminals		lift terminals
Terminal capacity		0.5-2.5 mm ²
Terminal screws		M3 (PoziDrive Z0)
Fastening torque of terminal screws		max. 0.8-1.0 Nm

Connection diagram



Dimensions (mm)

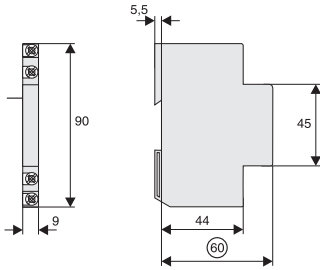

Accessories for Miniature Circuit Breakers AZ

Interlocks LH-SP

Function	Type Designation	Article No.	Units per package
Tripping interlock	LH-SPL	285752	1
Tripping interlock	LH-SPE	215999	1
Switchoff interlock	LH-SPA	216000	1

Specifications | Anti-Tamper Device LH-SPE, LH-SPL

Description

- Prevents undesired switching ON or OFF

Specifications | Switchoff Interlock LH-SPA

Description

- Prevents undesired switch-OFF

Dimensions (mm)

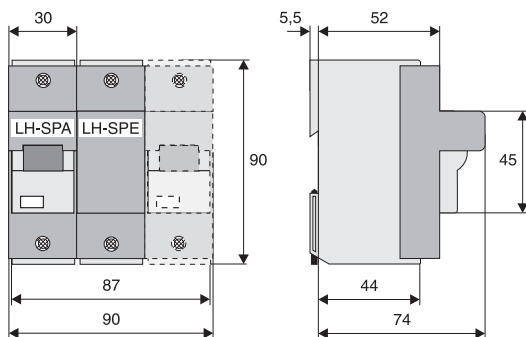

Accessories for Miniature Circuit Breaker FAZ-...-NA, -RT, -DU

Auxiliary Contact Z-IHK-NA

	Operational Voltage Range	Type Designation	Article No.	Units per package
	250 VAC	Z-IHK-NA	113895	1

Specifications | Auxiliary Contact Z-IHK-NA

Description

- Design according to IEC/EN 60947-5-1, IEC/EN 62019
- Field installable
- The specified minimum voltages are per contact—take into account particularly in case of series connection
- Self-cleaning contacts
- Contact material and design particularly suitable for extra low voltage
- Tripping signal contact transmits message of electric tripping, not mechanical switch-off
- Test key for contact function “electrical tripping”
- Will allow for > 480Y/277 VAC rating

Technical Data

		Z-IHK-NA
Electrical		
Contact function		1NO + 1NC
Rated voltage		250V
Rated current		6A
Rated thermal current	I_{th}	6A
Utilization category AC13		
Rated operational current	I_e	3A/250 Vac
Utilization category AC15		
Rated operational current	I_e	2A/250 Vac
Utilization category DC12		
Rated operational current	I_e	0.5A/110 Vdc
Rated insulation voltage	U_i	250 Vac
Minimum operational voltage per contact	U_{min}	5 Vdc
Minimum operational current	I_{min}	10 mA AC/DC
Rated peak withstand voltage	$U_{imp} (1.2/50\mu)$	4 kV
Conditional short circuit current	I_k	
with Back-Up Fuse 6A		1 kA
Max. back-up fuse, overload and short circuit		6 A gL / FAZ-4/..B-HS
Mechanical		
Tripping indicator “electrical tripping”		—
Frame size		45 mm
Device height		80 mm
Device width		8.8 mm (0.5MU)
Mounting		—
Degree of protection, built-in		IP40
Terminal protection		Finger and hand touch safe according to BGV A3, ÖVE-EN 6
Terminals		Lift terminals
Terminal capacity		0.5–2.5 mm ²
Terminal screws		M3 (Pozidrive Z2)
Tightening torque of terminal screws		max. 1.2 Nm

Connection diagram

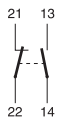

Dimensions (mm)

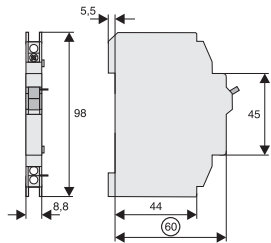

Accessories for Miniature Circuit Breaker FAZ-..-NA, -RT, -DU

Shunt Trip FAZ-XAA-NA

SG13511



Operational Voltage Range	Type Designation	Article No.	Units per package
12–110 VAC 12–60 VDC	FAZ-XAA-NA12-110VAC	102037	1
110–415 VAC 110–230 VDC	FAZ-XAA-NA110-415VAC	102036	1

Specifications | Shunt Trip FAZ-XAA-NA

Description

- Remote release for subsequent mounting onto FAZ-NA
- Additional installation of standard auxiliary switch is possible
- Position indicator red–green

Technical Data

	FAZ-XAA-NA12-110VAC	FAZ-XAA-NA110-415VAC
Electrical		
Can be mounted onto	FAZ-NA / FAZ-NA-DC / FAZ-RT/-DU	FAZ-NA / FAZ-NA-DC / FAZ-RT/-DU
Operational voltage range	12–110 Vac 12–60 Vdc	110–415 Vac 110–230 Vdc
Frequency	50/60 Hz	50/60 Hz
Mechanical		
Frame size	45 mm	45 mm
Device height	105 mm	105 mm
Device width	17.5 mm	17.5 mm
Mounting	Quick fastening with two lock-in positions on EN 50022	
Degree of protection, built-in	IP40	IP40
Terminal protection	Finger and hand touch safe according to BGV A3, ÖVE-EN 6	Finger and hand touch safe according to BGV A3, ÖVE-EN 6
Terminals	Open mouthed/lift	Open mouthed/lift
Terminal capacity, one and two wires	18–10 AWG	18–10 AWG

Connection diagram

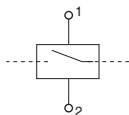

Terminal Covers

Description	Type Designation	Article No.	Units per package
-------------	------------------	-------------	-------------------

Terminal Covers for RCDs

2-pole	Z-RC/AK-2TE	285385	10
4-pole	Z-RC/AK-4TE	101062	10

Terminal Covers for Add-on Device

2-pole	Z-CV/AO-2P	221957600	10
3+4-pole	Z-CV/AO-3-4P	221957500	10



Terminal Covers for MCB, RCBO

2-pole	Z-CV/SD-2P	221954800	10
3-pole	Z-CV/SD-3P	221954900	10
4-pole	Z-CV/SD-4P	221953900	10

Terminal Cover for MCB

1-pole	Z7-AK-1TE	750754200	10
--------	-----------	-----------	----

Remote Control and Automatic Switching Device Z-ZW

Function	Type Designation	Article No.	Units per package	
 SG30811	Automatic restarting 230VAC	Z-FW-LP	248296	1/20
	Automatic restarting 24-48VDC	Z-FW-LPD	265244	1/20
 SG30711	+ Remote control ON/OFF/TEST (only in connection with Z-FW-LP, -LPD from delivery date 2006!)	Z-FW-MO	284730	1

Pre-mounted sets Z-FW

Operational voltage range	Type Designation	Article No.	Units per package	
 SG31311	230 VAC	Z-FW-LP/MO	290171	1/12
	24-48 VDC	Z-FW-LPD/MO	290172	1/12

Remote Testing Module Z-FW (for Z-FW-LP/MO set use only)

Operational voltage range	Type Designation	Article No.	Units per package	
 SG12111	0.01 A	Z-FW/001	248297	4/120
	0.03 A	Z-FW/003	248298	4/120
	0.1 A	Z-FW/010	248299	4/120
	0.3 A	Z-FW/030	248300	4/120
	0.5 A	Z-FW/050	248301	4/120

Specifications | Remote Control and Automatic Switching Z-FW

Description

- Shape compatible switching device suitable for subsequent installation for automatic re-setting and remote control of CLS6, PFIM, PFHM-4p, dRCM, Z-A40, PFR, Z-MS
- Mechanical interlock, can be sealed with leads
- Mechanical switching capability up to max. PFIM-100/4p, CLS6-100/4p
- Operating and alarm display by green and red LED
- Function extension with Switching Modul Z-FW-MO
Operating and trouble display by LED pre-assembled only with Z-FW...

Technical Data

	Z-FW-LP	Z-FW-LPD	Z-FW-MO
Electrical			
Possible operating voltages	220-240 V AC	24-48 V DC	-
Frequency	50/60 Hz	-	-
Testing module (0.5MU) for remote testing of RCDs	Z-FW...	Z-FW...	-
Control voltage for remote control	-	-	24-230 V AC/DC
Relay output for tripping test with Z-FW	-	-	400 V AC max.
Relay output for alarm, potential-free	5A/250V AC	5A/250V AC	-
Functions	automatic restarting	automatic restarting	+ON/OFF/TEST
Function selector	Automatic 5x, OFF/RESET	Automatic 5x, OFF/RESET	ON, OFF/RESET
Remote control function via telephone with Telecommander	-	-	-
Mechanical			
Frame size	45 mm	45 mm	45 mm
Device height	80 mm	80 mm	80 mm
Device width	70 mm	70 mm	35 mm
Mounting	quick fastening with 2 lock-in positions on DIN rail IEC/EN 60715		-
Degree of protection, built-in	IP40	IP40	IP40
Terminal protection	finger and hand touch safe according to BGV A3, ÖVE-EN 6		
Terminals	lift terminals	lift terminals	lift terminals
Terminal capacity	2 x 1.5 mm ² or 1 x 2.5 mm ²	2 x 1.5 mm ² or 1 x 2.5 mm ²	4 x 1.5 mm ² or 2 x 2.5 mm ²
Scope of delivery	-	-	Coupling plug

Connection diagram

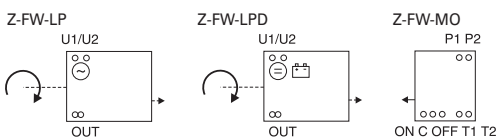

Dimensions (mm)

Z-FW-LP, -LPD

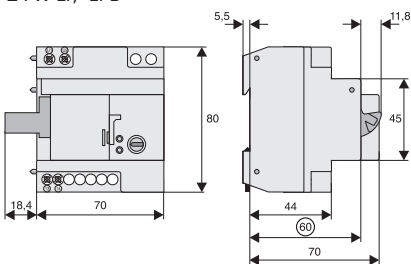

Z-FW-MO

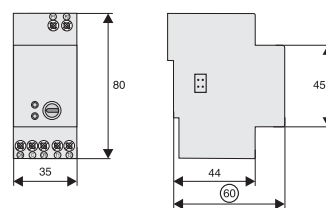

Connection example

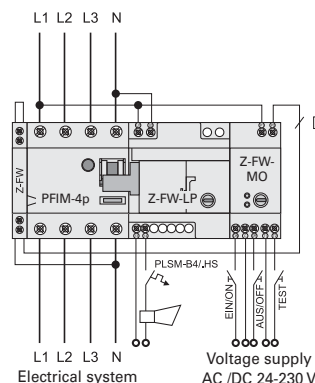
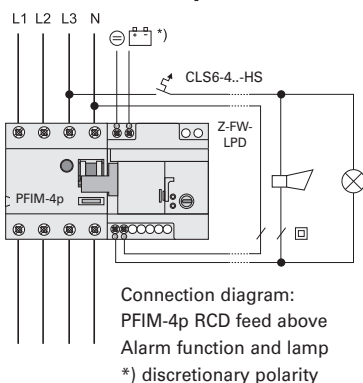

Pre-mounted Sets

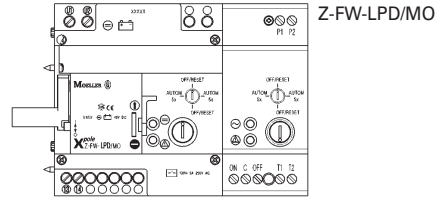
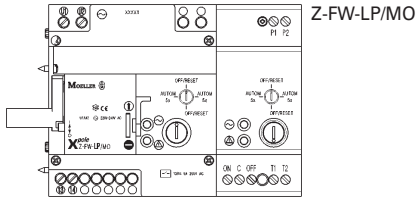

Specifications | Remote Testing Module Z-FW (for Z-FW-LP)

Description

- External testing module with testing resistor for RCDs
- Proper "external" test key function according to the applicable rules thanks to design adapted to the rated tripping current
- For remote testing with remote control and automatic switching device Z-FW-LP
- No undesired voltage rise in the consumer system during remote switch-off thanks to integrated breaker contact K1-K2
- Can also be used as a remote tripping module for PFIM, PFHM

Dimensions (mm)

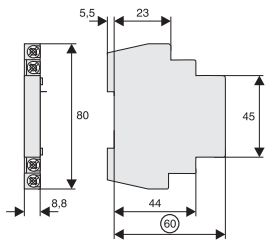

Connection examples

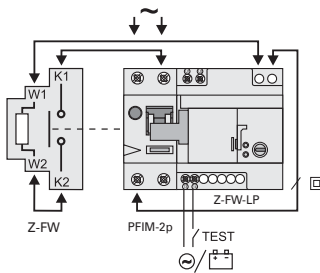

Connection diagram:
PFIM-2p, RCD feed above

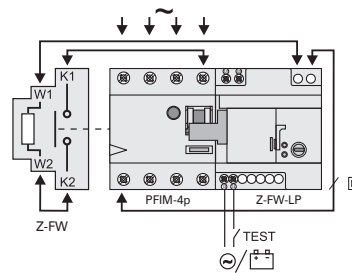

Connection diagram:
PFIM-4p, RCD feed above