

Catalog Number
Notes
Type

FEATURES & SPECIFICATIONS

INTENDED USE — The EPANL Series LED Edge-Lit Flat Panel provides a fully luminous appearance across the face of the lens. This provides a soft, glare-free solution that is visually comfortable within the space. Suitable for many lighting applications including schools, offices and other commercial spaces, retail, convenience stores, hospitals and healthcare facilities. **Certain airborne contaminants can diminish the integrity of acrylic and/or polycarbonate.** [Click here for Acrylic-Polycarbonate Compatibility table for suitable uses.](#)

CONSTRUCTION — Built to last with an aluminum frame for strength and durability, the seamless frame prevents light leak in the corners. The satin white lens provides excellent shielding and fully luminous appearance. EPANL's low-profile design provides increased installation flexibility especially in restricted plenum spaces. The back plate includes integral T-bar clips for installation into 15/16" T-grid ceilings. Clips for 9/16" T grid installation are available. See Accessories section on bottom of page. This must be ordered as a separate item. Fixture may be mounted and wired in continuous rows.

CONTROLS — Optional integrated nLight® controls make each luminaire addressable - allowing it to digitally communicate with other nLight enabled controls such as dimmers, switches, occupancy sensors and photocontrols. Connection to nLight is simple. It can be accomplished with integrated nLight AIR wireless or through standard Cat-5 cabling. nLight offers unique plug-and-play convenience as devices and luminaires automatically discover each other and self-commission, while nLight AIR is commissioned easily through an intuitive mobile app.

ELECTRICAL — Long-life LEDs, coupled with a high-efficiency driver, provide superior illumination for extended service life. 70% LED lumen maintenance at 60,000 hours (L70/60,000). 0-10V dimming driver, dims to 1% or 10%.

LISTINGS — CSA certified to meet US and Canadian standards. DesignLights Consortium® (DLC) Premium qualified product and DLC qualified product. Not all versions of this product may be DLC Premium qualified or DLC qualified. Please check the DLC Qualified Products List at www.designlights.org/QPL to confirm which versions are qualified. Intended for indoor use only. Damp location listed. IC rated. IP5X rated.

WARRANTY — 5-year limited warranty. Complete warranty terms located at: www.acuitybrands.com/CustomerResources/Terms_and_conditions.aspx

Note: Actual performance may differ as a result of end-user environment and application. All values are design or typical values, measured under laboratory conditions at 25 °C. Specifications subject to change without notice.

EPANL LED

1'x4', 2'x2', and 2'x4'



Configurable fixture dimension

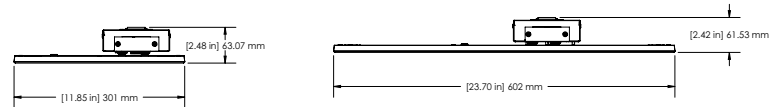

Stock fixture dimension

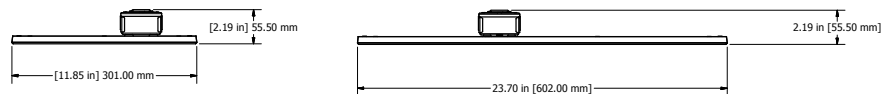

ORDERING INFORMATION

Lead times will vary depending on options selected.

Example: EPANL 2X4 4000LM 80CRI 35K MIN1 MVOLT E10WCP NLTAIR2 RIO

Series	Width and Length	Lumens	CRI	Color Temperature	Minimum Dimming Level ¹
EPANL LED Flat Panel	1x4 1'x4'	Standard Lumens:	80CRI 80 CRI	35K 3500K 40K 4000K 50K 5000K	MIN10 Dims to 10% ² MIN1 Dims to 1%
		1500LM 1500 Lumens			
		3000LM 3000 Lumens			
	2x2 2'x2'	High Efficiency Lumens:			
		4000LM 4000 Lumens			
		4800LM 4800 Lumens			
	2x4 2'x4'	2000LM 2000 Lumens			
		3400LM 3400 Lumens			
		4000LM 4000 Lumens			
4800LM 4800 Lumens					
3000LM 3000 Lumens					
4000LM 4000 Lumens					
4800LM 4800 Lumens					
5400LM 5400 Lumens					
6000LM 6000 Lumens					
6800LM 6800 Lumens					

Ordering continued on next page.

EPANL LED Flat Panel

ORDERING (continued)

Control Input ³		Voltage	Step Level Dimming	Emergency Option	nLight Interface	Control
ZT	Generic 0-10V Dimming	MVOLT 120-277V 120 120V	(Blank) None SLD Step Level Dimming ^{5,6}	E10WCP EM Self-Diagnostic battery pack, 10W Constant Power, Certified in CA Title 20 MAEDBS ^{7,8,9}	nLight Wired: ¹² (blank) No constant lumen management CL80 Constant lumen output 80%	nLight Wired: ¹² (blank) no control
EZT	eldoLED 0-10V Dimming	277 277V		BGTD Bodine Generator Transfer Device ¹⁰		
NLIGHT	nLight enabled (Wired)	347 347V ⁴		EMG for use with nLight on generator supply EM power ¹¹	nLight Wireless: NLTAIR2 nLight AIR Generation 2 enabled ¹³	nLight Wireless: RIO nLight AIR Radio module

Options	
GLR	Fast-blowing fuse ¹⁴
GMF	Slow-blowing fuse ¹⁴
PWS1836	6' pre-wire, 3/8" diameter, 18 gauge, 1 circuit
PWS1846	6' pre-wire, 3/8" diameter, 18 gauge, 2 circuit
PWS1846 PWSLV	Two cables: one 6' pre-wire, 3/8" diameter, 18 gauge, 2 circuits; one 6' pre-wire, 3/8" diameter, 18 gauge, purple and gray ¹⁵
PWS1856LV	6' pre-wire, 3/8" diameter, 18 gauge, 1 circuit w/low voltage purple and grey wires ¹⁴
CP	Chicago plenum ¹⁶
RRL_	RELOC [®] -ready luminaire
NPLT	Narrow Pallet

Notes:

- If Step Level Dimming (SLD) is needed please leave this section blank.
- Not available with EZT or NLIGHT.
- If Step Level Dimming (SLD) or NLTAIR2 is needed please leave this section blank.
- Not available with EZT, NLIGHT, SLD, Emergency options or Controls.
- Not available with BGTD.
- When using prewire option use PWS1846.
- When using prewire option use PWS1846 or PWS1846 PWSLV.
- Please refer to Emergency Battery Estimated Lumen section for lumen estimation. [PS1055CP](#) installed with lumen packages > 6000. [PS1055LCP](#) installed with lumen packages < 5400.
- Not available with NLTAIR2 RIO in the 2X2 4800LM and 1X4 or 2X4 6000LM and 6800LM.
- Requires BSE labeling, voltage must be specified (120, 277). Consult factory for options. Example: BGTD BSE10.
- nLight EMG option requires a connection to existing nLight network. Power is provided from a separate nLight enabled fixture. Requires NLIGHT.
- Requires NLIGHT control input.
- Only available with MIN1 Minimum Dimming Level option.
- Voltage must be specified (120, 277, 347).
- Not available with nLight Wired / nLight Wireless
- Not available with NLIGHT or NLTAIR2 RIO.

Stock Configurations available for shorter lead times:

ORDERING INFORMATION										
Catalog Number	UPC	Description	Lumens	Color Temperature	CRI	Voltage	Wattage	Efficacy	Pallet Qty.	Standard Carton Qty.
EPANL 14 40L 35K	190887602739	1x4 Flat Panel	3905	3500K	>80	120-277V	38.6W	101	26	1
EPANL 14 40LHE 35K	190887602746	1x4 Flat Panel	3922	3500K	>80	120-277V	30.6W	128	26	1
EPANL 14 40L 40K	190887602753	1x4 Flat Panel	4397	4000K	>80	120-277V	38.5W	114	26	1
EPANL 14 40LHE 40K	190887602760	1x4 Flat Panel	3857	4000K	>80	120-277V	30.2W	128	26	1
EPANL 14 40L 50K	191723811605	1X4 Flat Panel	4225	5000K	>80	120-277V	38.6W	113	26	1
EPANL 22 34L 35K	190887602647	2x2 Flat Panel	3285	3500K	>80	120-277V	31.3W	105	52	1
EPANL 22 34LHE 35K	190887602661	2x2 Flat Panel	3357	3500K	>80	120-277V	26.0W	129	52	1
EPANL 22 34L 40K	190887602678	2x2 Flat Panel	3479	4000K	>80	120-277V	30.8W	113	52	1
EPANL 22 34LHE 40K	190887602685	2x2 Flat Panel	3361	4000K	>80	120-277V	25.9W	130	52	1
EPANL 22 34L 50K	191723811650	2x2 Flat Panel	3385	5000K	>80	120-277V	32.9W	102	52	1
EPANL 24 40L 35K	190887602692	2x4 Flat Panel	4039	3500K	>80	120-277V	38.8W	104	26	1
EPANL 24 40LHE 35K	190887602708	2x4 Flat Panel	3953	3500K	>80	120-277V	30.3W	130	26	1
EPANL 24 40L 40K	190887602715	2x4 Flat Panel	4351	4000K	>80	120-277V	38.9W	112	26	1
EPANL 24 40LHE 40K	190887602722	2x4 Flat Panel	4013	4000K	>80	120-277V	30.7W	131	26	1
EPANL 24 40L 50K	191723812312	2X4 Flat Panel	4108	5000K	>80	120-277V	39W	105	26	1

EPANL LED Flat Panel

Performance Data				
Configuration	CCT	Lumens	Wattage	LPW
EPANL 1X4 1500LM 80CRI 35K [MIN1, MIN10] [BLANK, ZT, EZT, NLIGHT] [MVOLT, 120, 277] [ALL OPTIONS]	3500	1455	13.3	109.8
EPANL 1X4 1500LM 80CRI 35K [MVOLT, 120V, 277V] SLD [ALL OPTIONS]	3500	1455	12.2	118.9
EPANL 1X4 1500LM 80CRI 40K [MIN1, MIN10] [BLANK, ZT, EZT, NLIGHT] [MVOLT, 120, 277] [ALL OPTIONS]	4000	1518	13.3	114.5
EPANL 1X4 1500LM 80CRI 40K [MVOLT, 120V, 277V] SLD [ALL OPTIONS]	4000	1518	12.2	124.0
EPANL 1X4 1500LM 80CRI 50K [MIN1, MIN10] [BLANK, ZT, EZT, NLIGHT] [MVOLT, 120, 277] [ALL OPTIONS]	5000	1527	13.3	115.3
EPANL 1X4 1500LM 80CRI 50K [MVOLT, 120V, 277V] SLD [ALL OPTIONS]	5000	1527	12.2	124.8
EPANL 1X4 3000LM 80CRI 35K [MIN1, MIN10] [BLANK, ZT, EZT, NLIGHT] [MVOLT, 120, 277, 347] [ALL OPTIONS]	3500	2885	27.2	105.9
EPANL 1X4 3000LM 80CRI 35K [MVOLT, 120V, 277V] SLD [ALL OPTIONS]	3500	2885	25.8	111.6
EPANL 1X4 3000LM 80CRI 40K [MIN1, MIN10] [BLANK, ZT, EZT, NLIGHT] [MVOLT, 120, 277, 347] [ALL OPTIONS]	4000	3009	27.2	110.5
EPANL 1X4 3000LM 80CRI 40K [MVOLT, 120V, 277V] SLD [ALL OPTIONS]	4000	3009	25.8	116.5
EPANL 1X4 3000LM 80CRI 50K [MIN1, MIN10] [BLANK, ZT, EZT, NLIGHT] [MVOLT, 120, 277, 347] [ALL OPTIONS]	5000	3028	27.2	111.2
EPANL 1X4 3000LM 80CRI 50K [MVOLT, 120V, 277V] SLD [ALL OPTIONS]	5000	3028	25.8	117.2
EPANL 1X4 4000LM 80CRI 35K [MIN1, MIN10] [BLANK, ZT, EZT, NLIGHT] [MVOLT, 120, 277, 347] [ALL OPTIONS]	3500	4025	38.6	104.2
EPANL 1X4 4000LM 80CRI 35K [MVOLT, 120V, 277V] SLD [ALL OPTIONS]	3500	4025	38.0	105.9
EPANL 1X4 4000LM 80CRI 40K [MIN1, MIN10] [BLANK, ZT, EZT, NLIGHT] [MVOLT, 120, 277, 347] [ALL OPTIONS]	4000	4198	38.6	108.8
EPANL 1X4 4000LM 80CRI 40K [MVOLT, 120V, 277V] SLD [ALL OPTIONS]	4000	4198	38.0	110.5
EPANL 1X4 4000LM 80CRI 50K [MIN1, MIN10] [BLANK, ZT, EZT, NLIGHT] [MVOLT, 120, 277, 347] [ALL OPTIONS]	5000	4225	38.6	109.5
EPANL 1X4 4000LM 80CRI 50K [MVOLT, 120V, 277V] SLD [ALL OPTIONS]	5000	4225	38.0	111.2
EPANL 1X4 4800LM 80CRI 35K [MIN1, MIN10] [BLANK, ZT, EZT, NLIGHT] [MVOLT, 120, 277, 347] [ALL OPTIONS]	3500	4765	47.0	101.5
EPANL 1X4 4800LM 80CRI 35K [MVOLT, 120V, 277V] SLD [ALL OPTIONS]	3500	4765	46.3	103.0
EPANL 1X4 4800LM 80CRI 40K [MIN1, MIN10] [BLANK, ZT, EZT, NLIGHT] [MVOLT, 120, 277, 347] [ALL OPTIONS]	4000	4970	47.0	105.8
EPANL 1X4 4800LM 80CRI 40K [MVOLT, 120V, 277V] SLD [ALL OPTIONS]	4000	4970	46.3	107.4
EPANL 1X4 4800LM 80CRI 50K [MIN1, MIN10] [BLANK, ZT, EZT, NLIGHT] [MVOLT, 120, 277, 347] [ALL OPTIONS]	5000	5002	47.0	106.5
EPANL 1X4 4800LM 80CRI 50K [MVOLT, 120V, 277V] SLD [ALL OPTIONS]	5000	5002	46.3	108.1
EPANL 1X4 6000LM 80CRI 35K [MIN1, MIN10] 2T [MVOLT, 120, 277, 347] [ALL OPTIONS]	3500	5804	49.9	116.4
EPANL 1X4 6000LM 80CRI 40K [MIN1, MIN10] 2T [MVOLT, 120, 277, 347] [ALL OPTIONS]	4000	5976	49.9	119.9
EPANL 1X4 6000LM 80CRI 50K [MIN1, MIN10] 2T [MVOLT, 120, 277, 347] [ALL OPTIONS]	5000	6028	49.9	120.9
EPANL 2X2 2000LM 80CRI 35K [MIN1, MIN10] [BLANK, ZT, EZT, NLIGHT] [MVOLT, 120, 277, 347] [ALL OPTIONS]	3500	1946	18.9	103.0
EPANL 2X2 2000LM 80CRI 35K [MVOLT, 120V, 277V] SLD [ALL OPTIONS]	3500	1946	17.3	112.2
EPANL 2X2 2000LM 80CRI 40K [MIN1, MIN10] [BLANK, ZT, EZT, NLIGHT] [MVOLT, 120, 277, 347] [ALL OPTIONS]	4000	2030	19.6	103.7
EPANL 2X2 2000LM 80CRI 40K [MVOLT, 120V, 277V] SLD [ALL OPTIONS]	4000	2030	17.3	117.1
EPANL 2X2 2000LM 80CRI 50K [MIN1, MIN10] [BLANK, ZT, EZT, NLIGHT] [MVOLT, 120, 277, 347] [ALL OPTIONS]	5000	2043	19.6	104.4
EPANL 2X2 2000LM 80CRI 50K [MVOLT, 120V, 277V] SLD [ALL OPTIONS]	5000	2043	17.3	117.8
EPANL 2X2 3400LM 80CRI 35K [MIN1, MIN10] [BLANK, ZT, EZT, NLIGHT] [MVOLT, 120, 277, 347] [ALL OPTIONS]	3500	3225	32.1	100.4
EPANL 2X2 3400LM 80CRI 35K [MVOLT, 120V, 277V] SLD [ALL OPTIONS]	3500	3225	31.2	103.4
EPANL 2X2 3400LM 80CRI 40K [MIN1, MIN10] [BLANK, ZT, EZT, NLIGHT] [MVOLT, 120, 277, 347] [ALL OPTIONS]	4000	3364	32.9	102.3
EPANL 2X2 3400LM 80CRI 40K [MVOLT, 120V, 277V] SLD [ALL OPTIONS]	4000	3364	31.2	107.9
EPANL 2X2 3400LM 80CRI 50K [MIN1, MIN10] [BLANK, ZT, EZT, NLIGHT] [MVOLT, 120, 277, 347] [ALL OPTIONS]	5000	3385	32.9	103.0
EPANL 2X2 3400LM 80CRI 50K [MVOLT, 120V, 277V] SLD [ALL OPTIONS]	5000	3385	31.2	108.6
EPANL 2X2 4000LM 80CRI 35K [MIN1, MIN10] [BLANK, ZT, EZT, NLIGHT] [MVOLT, 120, 277, 347] [ALL OPTIONS]	3500	4025	32.2	125.2
EPANL 2X2 4000LM 80CRI 35K [MVOLT, 120V, 277V] SLD [ALL OPTIONS]	3500	4025	31.7	127.1
EPANL 2X2 4000LM 80CRI 40K [MIN1, MIN10] [BLANK, ZT, EZT, NLIGHT] [MVOLT, 120, 277, 347] [ALL OPTIONS]	4000	4144	32.2	128.9
EPANL 2X2 4000LM 80CRI 40K [MVOLT, 120V, 277V] SLD [ALL OPTIONS]	4000	4144	31.7	130.8
EPANL 2X2 4000LM 80CRI 50K [MIN1, MIN10] [BLANK, ZT, EZT, NLIGHT] [MVOLT, 120, 277, 347] [ALL OPTIONS]	5000	4180	32.2	130.0
EPANL 2X2 4000LM 80CRI 50K [MVOLT, 120V, 277V] SLD [ALL OPTIONS]	5000	4180	31.7	132.0
EPANL 2X2 4800LM 80CRI 35K [MIN1, MIN10] [BLANK, ZT, EZT, NLIGHT] [MVOLT, 120, 277, 347] [ALL OPTIONS]	3500	4446	36.2	122.7
EPANL 2X2 4800LM 80CRI 35K [MVOLT, 120V, 277V] SLD [ALL OPTIONS]	3500	4446	35.7	124.6
EPANL 2X2 4800LM 80CRI 40K [MIN1, MIN10] [BLANK, ZT, EZT, NLIGHT] [MVOLT, 120, 277, 347] [ALL OPTIONS]	4000	4578	36.2	126.4
EPANL 2X2 4800LM 80CRI 40K [MVOLT, 120V, 277V] SLD [ALL OPTIONS]	4000	4578	35.7	128.3
EPANL 2X2 4800LM 80CRI 50K [MIN1, MIN10] [BLANK, ZT, EZT, NLIGHT] [MVOLT, 120, 277, 347] [ALL OPTIONS]	5000	4618	36.2	127.5
EPANL 2X2 4800LM 80CRI 50K [MVOLT, 120V, 277V] SLD [ALL OPTIONS]	5000	4618	35.7	129.4
EPANL 2X4 3000LM 80CRI 35K [MIN1, MIN10] [BLANK, ZT, EZT, NLIGHT] [MVOLT, 120, 277, 347] [ALL OPTIONS]	3500	2993	27.4	109.4
EPANL 2X4 3000LM 80CRI 35K [MVOLT, 120V, 277V] SLD [ALL OPTIONS]	3500	2993	26.0	115.3
EPANL 2X4 3000LM 80CRI 40K [MIN1, MIN10] [BLANK, ZT, EZT, NLIGHT] [MVOLT, 120, 277, 347] [ALL OPTIONS]	4000	3122	27.4	114.1
EPANL 2X4 3000LM 80CRI 40K [MVOLT, 120V, 277V] SLD [ALL OPTIONS]	4000	3122	26.0	120.3
EPANL 2X4 3000LM 80CRI 50K [MIN1, MIN10] [BLANK, ZT, EZT, NLIGHT] [MVOLT, 120, 277, 347] [ALL OPTIONS]	5000	3142	27.4	114.8
EPANL 2X4 3000LM 80CRI 50K [MVOLT, 120V, 277V] SLD [ALL OPTIONS]	5000	3142	26.0	121.1
EPANL 2X4 4000LM 80CRI 35K [MIN1, MIN10] [BLANK, ZT, EZT, NLIGHT] [MVOLT, 120, 277, 347] [ALL OPTIONS]	3500	3914	39.0	100.4
EPANL 2X4 4000LM 80CRI 35K [MVOLT, 120V, 277V] SLD [ALL OPTIONS]	3500	3914	38.4	101.9
EPANL 2X4 4000LM 80CRI 40K [MIN1, MIN10] [BLANK, ZT, EZT, NLIGHT] [MVOLT, 120, 277, 347] [ALL OPTIONS]	4000	4082	39.0	104.7
EPANL 2X4 4000LM 80CRI 40K [MVOLT, 120V, 277V] SLD [ALL OPTIONS]	4000	4082	38.4	106.3
EPANL 2X4 4000LM 80CRI 50K [MIN1, MIN10] [BLANK, ZT, EZT, NLIGHT] [MVOLT, 120, 277, 347] [ALL OPTIONS]	5000	4108	39.0	105.4
EPANL 2X4 4000LM 80CRI 50K [MVOLT, 120V, 277V] SLD [ALL OPTIONS]	5000	4108	38.4	106.9
EPANL 2X4 4800LM 80CRI 35K [MIN1, MIN10] [BLANK, ZT, EZT, NLIGHT] [MVOLT, 120, 277, 347] [ALL OPTIONS]	3500	4771	47.1	101.2
EPANL 2X4 4800LM 80CRI 35K [MVOLT, 120V, 277V] SLD [ALL OPTIONS]	3500	4771	46.4	102.7
EPANL 2X4 4800LM 80CRI 40K [MIN1, MIN10] [BLANK, ZT, EZT, NLIGHT] [MVOLT, 120, 277, 347] [ALL OPTIONS]	4000	4976	47.1	105.6
EPANL 2X4 4800LM 80CRI 40K [MVOLT, 120V, 277V] SLD [ALL OPTIONS]	4000	4976	46.4	107.2
EPANL 2X4 4800LM 80CRI 50K [MIN1, MIN10] [BLANK, ZT, EZT, NLIGHT] [MVOLT, 120, 277, 347] [ALL OPTIONS]	5000	5008	47.1	106.2
EPANL 2X4 4800LM 80CRI 50K [MVOLT, 120V, 277V] SLD [ALL OPTIONS]	5000	5008	46.4	107.8
EPANL 2X4 5400LM 80CRI 35K [MIN1, MIN10] [BLANK, ZT, EZT, NLIGHT] [MVOLT, 120, 277, 347] [ALL OPTIONS]	3500	5143	51.4	100.1
EPANL 2X4 5400LM 80CRI 35K [MVOLT, 120V, 277V] SLD [ALL OPTIONS]	3500	5143	51.4	100.1
EPANL 2X4 5400LM 80CRI 40K [MIN1, MIN10] [BLANK, ZT, EZT, NLIGHT] [MVOLT, 120, 277, 347] [ALL OPTIONS]	4000	5296	52.1	101.6
EPANL 2X4 5400LM 80CRI 40K [MVOLT, 120V, 277V] SLD [ALL OPTIONS]	4000	5296	51.4	103.1
EPANL 2X4 5400LM 80CRI 50K [MIN1, MIN10] [BLANK, ZT, EZT, NLIGHT] [MVOLT, 120, 277, 347] [ALL OPTIONS]	5000	5341	52.1	102.4
EPANL 2X4 5400LM 80CRI 50K [MVOLT, 120V, 277V] SLD [ALL OPTIONS]	5000	5341	51.4	104.0
EPANL 2X4 6000LM 80CRI 35K [MIN1, MIN10] 2T [MVOLT, 120, 277, 347] [ALL OPTIONS]	3500	6369	54.0	118.0
EPANL 2X4 6000LM 80CRI 40K [MIN1, MIN10] 2T [MVOLT, 120, 277, 347] [ALL OPTIONS]	4000	6558	54.0	121.5
EPANL 2X4 6000LM 80CRI 50K [MIN1, MIN10] 2T [MVOLT, 120, 277, 347] [ALL OPTIONS]	5000	6615	54.0	122.6
EPANL 2X4 6800LM 80CRI 35K [MIN1, MIN10] 2T [MVOLT, 120, 277, 347] [ALL OPTIONS]	3500	6645	59.9	110.9
EPANL 2X4 6800LM 80CRI 40K [MIN1, MIN10] 2T [MVOLT, 120, 277, 347] [ALL OPTIONS]	4000	6842	59.9	114.2
EPANL 2X4 6800LM 80CRI 50K [MIN1, MIN10] 2T [MVOLT, 120, 277, 347] [ALL OPTIONS]	5000	6901	59.9	115.2



EPANL Configurable

ACCESSORIES

Accessories: Order as separate catalog number.

DGA14	Drywall grid adapter for 1x4 recessed fixture.
DGA22	Drywall grid adapter for 2x2 recessed fixture.
DGA24	Drywall grid adapter for 2x4 recessed fixture.
PS1055CP FMC BRKT	Power Sentry emergency constant power battery pack field installation kit for Certified in CA Title 20 MAEDBS. ¹
2X2SMKSH	2'x2' Surface Mount Troffer Kit ¹
2X4SMKSH	2'x4' Surface Mount Troffer Kit ¹
1X4SMKSH	1'x4' Surface Mount Troffer Kit ¹
EPANL TGRID CLIP J4	Pack of 4 grid clips for 9/16" T grid compatibility.
EPANL TGRID CLIP J50	Pack of 50 grid clips for 9/16" T grid compatibility.
1X4PANLACG 36	Adjustable aircraft cable gripper suspension kit with 36" length cables for 1X4 fixture. Includes: suspension cables, mounting hardware, and 5 wire power feed cable (Ground, Hot, Neutral, and Low Voltage Leads). ²
1X4PANLACG 72	Adjustable aircraft cable gripper suspension kit with 72" length cables for 1X4 fixture. Includes: suspension cables, mounting hardware, and 5 wire power feed cable (Ground, Hot, Neutral, and Low Voltage Leads). ²
2X2PANLACG 36	Adjustable aircraft cable gripper suspension kit with 36" length cables for 2X2 fixture. Includes: suspension cables, mounting hardware, and 5 wire power feed cable (Ground, Hot, Neutral, and Low Voltage Leads). ²
2X2PANLACG 72	Adjustable aircraft cable gripper suspension kit with 72" length cables for 2X2 fixture. Includes: suspension cables, mounting hardware, and 5 wire power feed cable (Ground, Hot, Neutral, and Low Voltage Leads). ²
2X4PANLACG 36	Adjustable aircraft cable gripper suspension kit with 36" length cables for 2X4 fixture. Includes: suspension cables, mounting hardware, and 5 wire power feed cable (Ground, Hot, Neutral, and Low Voltage Leads). ²
2X4PANLACG 72	Adjustable aircraft cable gripper suspension kit with 72" length cables for 2X4 fixture. Includes: suspension cables, mounting hardware, and 5 wire power feed cable (Ground, Hot, Neutral, and Low Voltage Leads). ²

Emergency Battery Estimated Lumens

Use the formula below to estimate the delivered lumens in emergency mode

Estimated Lumens = 1.25 x P x LPW

P = Output power of emergency driver (10W for PS1055CP)

LPW = Lumen per watt rating of the luminaire.

SMKSH Accessory



Notes:

- Cannot be installed with fixture with integrated NLTAIR2 RIO.
- See Suspension Kits section on bottom of page 6 for additional detail.

nLight® Wired Control Accessories:
Order as separate catalog number. Visit www.acuitybrands.com/products/controls/nlight.

WallPod stations	Model number	Occupancy sensors	Model number
On/Off	nPODM [color]	Small motion 360°, ceiling (PIR / dual tech)	nCM 9 RJB / nCM PDT 9 RJB
On/Off & raise/lower	nPODM DX [color]	Large motion 360°, ceiling (PIR / dual tech)	nCM10 RJB / nCM PDT 10 RJB
Graphic touchscreen	nPOD GFX [color]	Wall switch with raise/lower	nWSX PDT LV DX [color]
Photocell controls	Model number	Cat-5 cable (plenum rated)	Model number
Full range dimming	nCM ADCX RJB	10' cable	CAT5 10FT J1
		30' cable	CAT5 30FT J1

nLight® AIR Control Accessories:
Order as separate catalog number. Visit www.acuitybrands.com/products/controls/nlightair.

Wall switches	Model number
On/Off single pole	rPODB [color] G2
On/Off two pole	rPODB 2P [color] G2
On/Off & raise/lower single pole	rPODB DX [color] G2
On/Off & raise/lower two pole	rPODB 2P DX [color] G2
On/Off & raise/lower single pole	rPODBZ DX WH G2

rCMS ¹		Example: RCMS PDT 10 AR G2							
Series / Detection	Power Supply ¹	Occupancy Detection		Lens (Required)		Operating Mode		Generation	
RCMS nLight AIR occupancy and daylight sensor	[blank] Power Supply ordered separately	[blank] PIR Detection	PDT Dual Tech PIR/Microphonics	10	Large Motion/ Extended Range 360°	[BLANK] None	AR Auxiliary Relay	G2	Generation 2 compatibility
	PS 150 Standard 150 mA Power Supply			9	Small Motion/ Extended Range 360°				
				6	High Bay 360° Lens				

Notes

- RCMS requires low voltage power from either RPP20 DS 24V G2 or PS150.

nLight AIR Wireless

nLight AIR is the ideal solution for retrofit or new construction spaces where adding additional wiring can be labor intensive and costly. The integrated RIO module is part of each luminaire in the nLight AIR network, which can be grouped to control multiple luminaires.



Simple as 1, 2, 3

- Install the nLight® AIR fixtures with integrated RIO module.
- Install the wireless battery-powered wall switch.
- With CLAIRITY PRO app, pair the fixtures with the wall switch and if desired, add and customize the ceiling mount sensor settings.



EPANL LED Flat Panel

EPANL compatible with Sensor Switch™
WSX-D and SPOD wall switches.



WSX-D



SPOD

PHOTOMETRICS

EPANL 2x2 4000LM 80CRI 40K, 4144.5 delivered lumens.

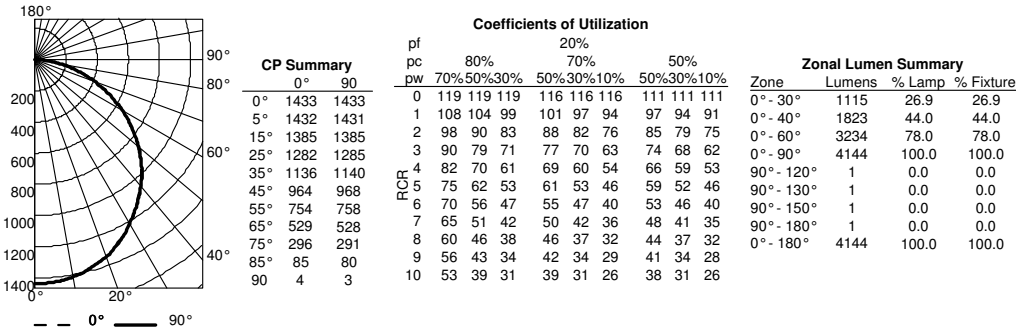

EPANL 2x4 4800LM 80CRI 40K, 4976.3 delivered lumens.

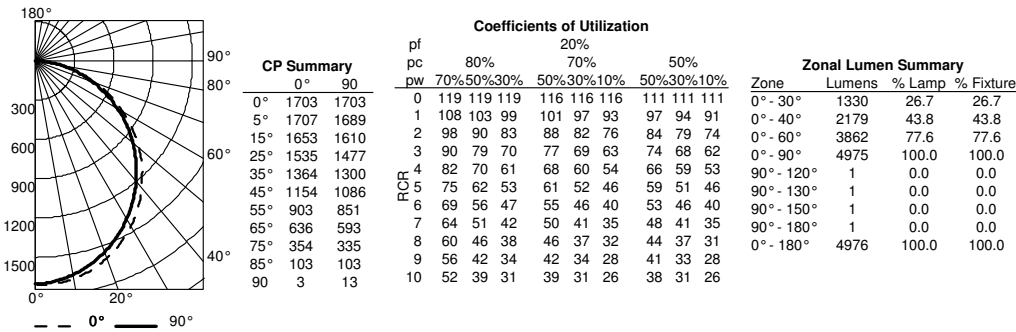

EPANL 2x4 6800LM 80CRI 40K, 6842.1 delivered lumens.

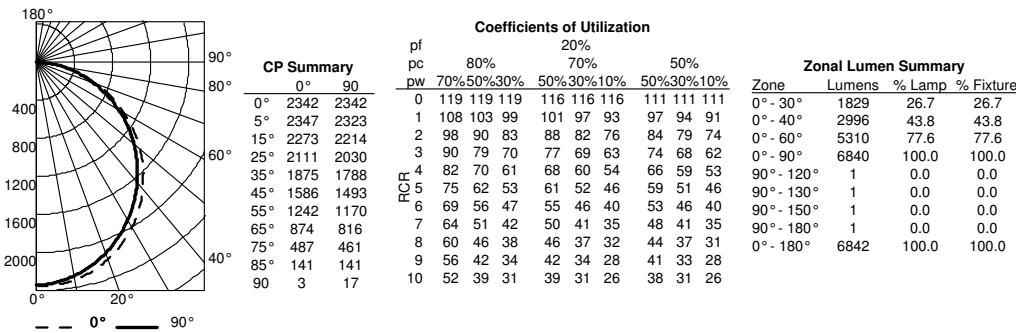

DIMENSIONS

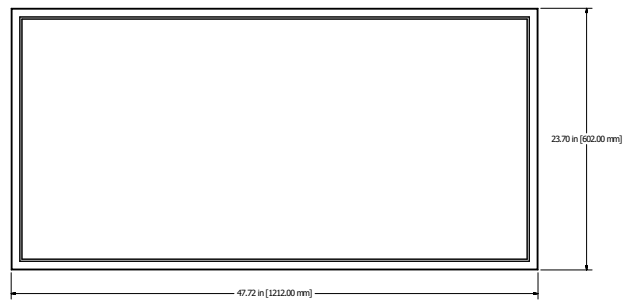
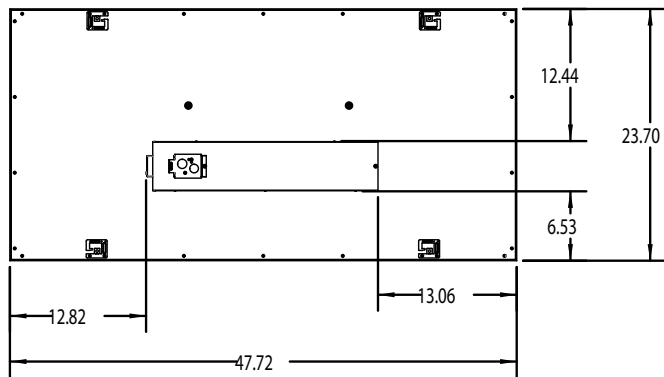
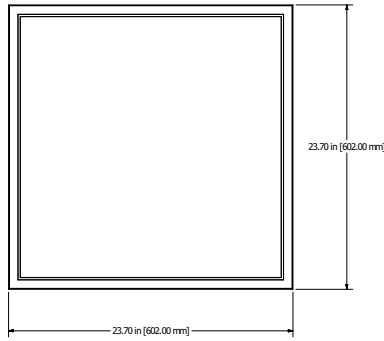
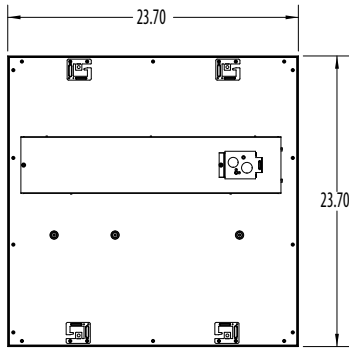
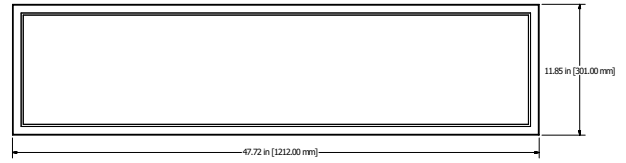
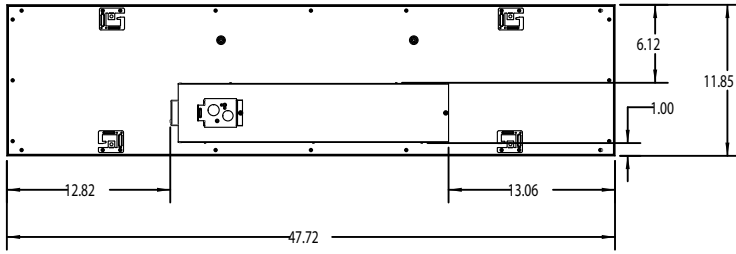

Suspension Kits

1X4PANLACG



2X2PANLACG

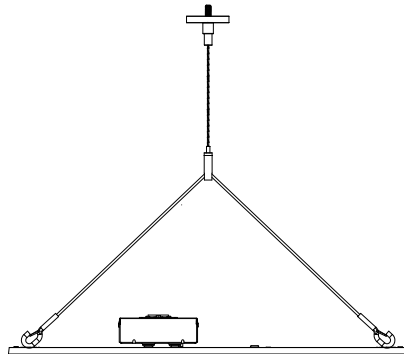

2X4PANLACG

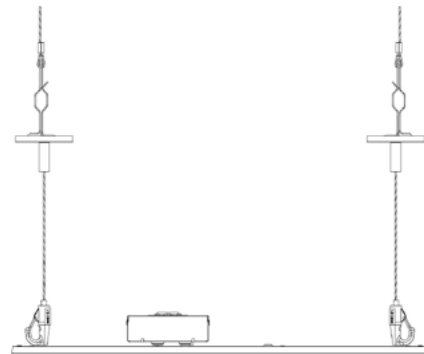

1X4SMKSH, 2X2SMKSH, 2X4SMKSH
SURFACE MOUNT KIT - MOUNTING DATA

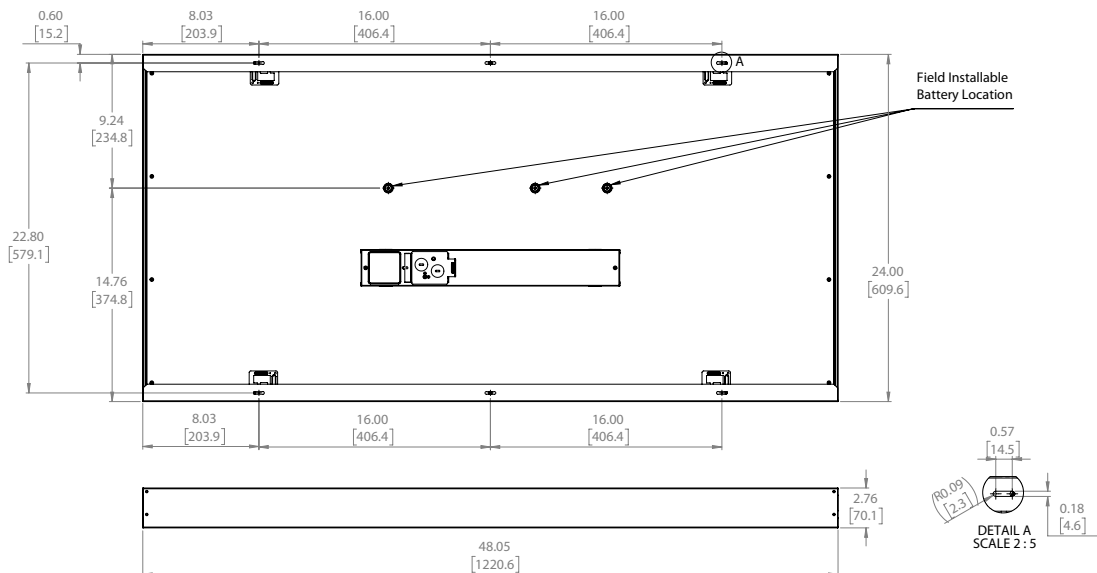
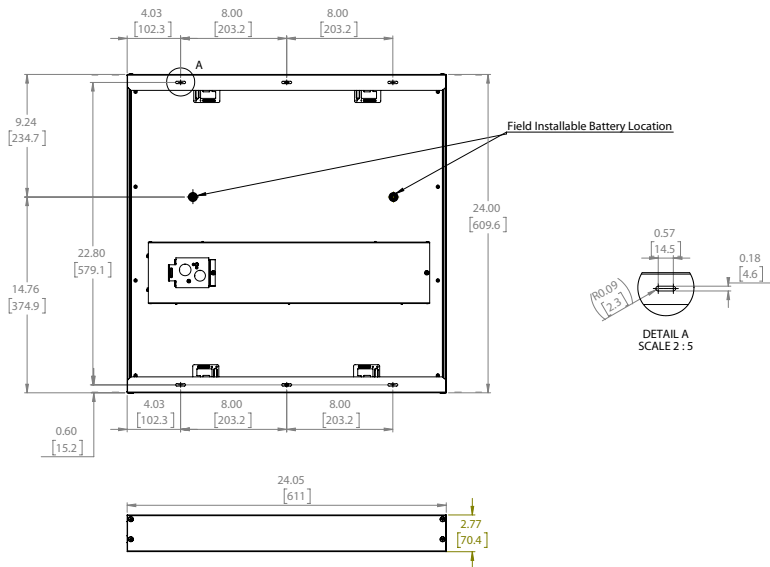
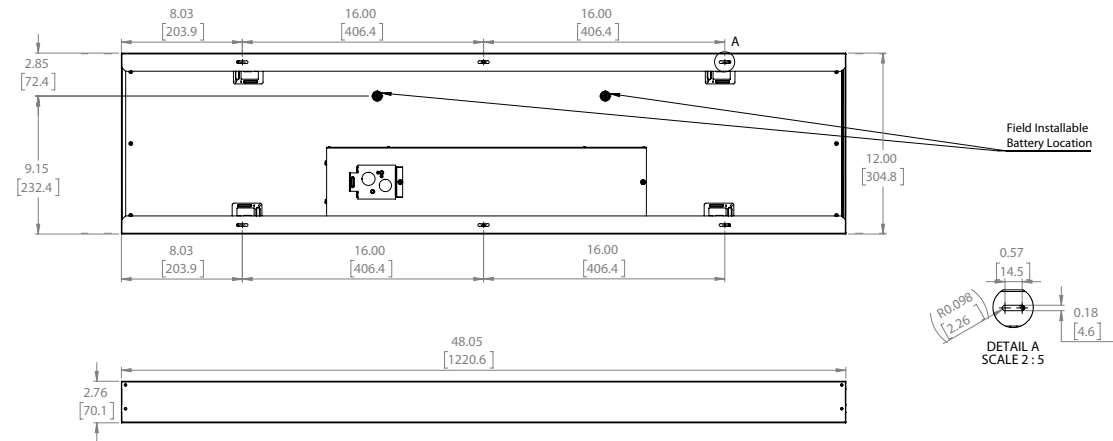

Catalog Number
Notes
Type

FEATURES & SPECIFICATIONS

INTENDED USE — The EPANL Series LED Edge-Lit Flat Panel provides a fully luminous appearance across the face of the lens. This provides a soft, glare-free solution that is visually comfortable within the space. Suitable for many lighting applications including schools, offices and other commercial spaces, retail, convenience stores, hospitals and healthcare facilities. **Certain airborne contaminants can diminish the integrity of acrylic and/or polycarbonate.** [Click here for Acrylic-Polycarbonate Compatibility table for suitable uses.](#)

CONSTRUCTION — Built to last with an aluminum frame for strength and durability, the seamless frame prevents light leak in the corners. The satin white lens provides excellent shielding and fully luminous appearance. EPANL's low-profile design provides increased installation flexibility especially in restricted plenum spaces. The back plate includes integral T-bar clips for installation into 15/16" T-grid ceilings. Clips for 9/16" T grid installation are available. See Accessories section on bottom of page. This must be ordered as a separate item. Fixture may be mounted and wired in continuous rows.

CONTROLS — Optional integrated nLight® controls make each luminaire addressable - allowing it to digitally communicate with other nLight enabled controls such as dimmers, switches, occupancy sensors and photocontrols. Connection to nLight is simple. It can be accomplished with integrated nLight AIR wireless or through standard Cat-5 cabling. nLight offers unique plug-and-play convenience as devices and luminaires automatically discover each other and self-commission, while nLight AIR is commissioned easily through an intuitive mobile app.

ELECTRICAL — Long-life LEDs, coupled with a high-efficiency driver, provide superior illumination for extended service life. 70% LED lumen maintenance at 60,000 hours (L70/60,000). 0-10V dimming driver, dims to 1% or 10%.

LISTINGS — CSA certified to meet US and Canadian standards. DesignLights Consortium® (DLC) Premium qualified product and DLC qualified product. Not all versions of this product may be DLC Premium qualified or DLC qualified. Please check the DLC Qualified Products List at www.designlights.org/QPL to confirm which versions are qualified. Intended for indoor use only. Damp location listed. IC rated. IP5X rated.

WARRANTY — 5-year limited warranty. Complete warranty terms located at: www.acuitybrands.com/CustomerResources/Terms_and_conditions.aspx

Note: Actual performance may differ as a result of end-user environment and application. All values are design or typical values, measured under laboratory conditions at 25 °C. Specifications subject to change without notice.

EPANL LED

1'x4', 2'x2', and 2'x4'



Configurable fixture dimension

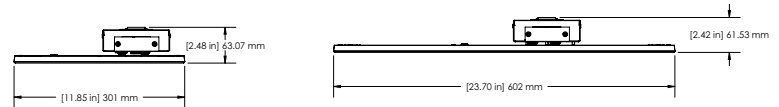

Stock fixture dimension

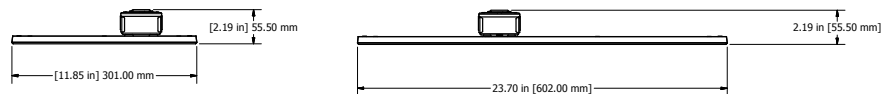

ORDERING INFORMATION

Lead times will vary depending on options selected.

Example: EPANL 2X4 4000LM 80CRI 35K MIN1 MVOLT E10WCP NLTAIR2 RIO

Series	Width and Length	Lumens	CRI	Color Temperature	Minimum Dimming Level ¹
EPANL LED Flat Panel	1x4 1'x4'	Standard Lumens:	80CRI 80 CRI	35K 3500K 40K 4000K 50K 5000K	MIN10 Dims to 10% ² MIN1 Dims to 1%
		1500LM 1500 Lumens			
		3000LM 3000 Lumens			
	2x2 2'x2'	High Efficiency Lumens:			
		4000LM 4000 Lumens			
		4800LM 4800 Lumens			
	2x4 2'x4'	2000LM 2000 Lumens			
		3400LM 3400 Lumens			
		4000LM 4000 Lumens			
4800LM 4800 Lumens					
3000LM 3000 Lumens					
4000LM 4000 Lumens					
4800LM 4800 Lumens					
5400LM 5400 Lumens					
6000LM 6000 Lumens					
6800LM 6800 Lumens					

Ordering continued on next page.

EPANL LED Flat Panel

ORDERING (continued)

Control Input ³		Voltage	Step Level Dimming	Emergency Option	nLight Interface	Control
ZT	Generic 0-10V Dimming	MVOLT 120-277V	(Blank) None	E10WCP	nLight Wired: ¹² (blank) No constant lumen management	nLight Wired: ¹² (blank) no control
EZT	eldoLED 0-10V Dimming	120 120V 277 277V	SLD Step Level Dimming ^{5,6}	BGTD	CL80 Constant lumen output 80%	
NLIGHT	nLight enabled (Wired)	347 347V ⁴		EMG	nLight Wireless: NLTAIR2 nLight AIR Generation 2 enabled ¹³	nLight Wireless: RIO nLight AIR Radio module

Options	
GLR	Fast-blowing fuse ¹⁴
GMF	Slow-blowing fuse ¹⁴
PWS1836	6' pre-wire, 3/8" diameter, 18 gauge, 1 circuit
PWS1846	6' pre-wire, 3/8" diameter, 18 gauge, 2 circuit
PWS1846 PWSLV	Two cables: one 6' pre-wire, 3/8" diameter, 18 gauge, 2 circuits; one 6' pre-wire, 3/8" diameter, 18 gauge, purple and gray ¹⁵
PWS1856LV	6' pre-wire, 3/8" diameter, 18 gauge, 1 circuit w/low voltage purple and grey wires ¹⁴
CP	Chicago plenum ¹⁶
RRL_	RELOC [®] -ready luminaire
NPLT	Narrow Pallet

Notes:

- If Step Level Dimming (SLD) is needed please leave this section blank.
- Not available with EZT or NLIGHT.
- If Step Level Dimming (SLD) or NLTAIR2 is needed please leave this section blank.
- Not available with EZT, NLIGHT, SLD, Emergency options or Controls.
- Not available with BGTD.
- When using prewire option use PWS1846.
- When using prewire option use PWS1846 or PWS1846 PWSLV.
- Please refer to Emergency Battery Estimated Lumen section for lumen estimation. [PS1055CP](#) installed with lumen packages > 6000. [PS1055LCP](#) installed with lumen packages < 5400.
- Not available with NLTAIR2 RIO in the 2X2 4800LM and 1X4 or 2X4 6000LM and 6800LM.
- Requires BSE labeling, voltage must be specified (120, 277). Consult factory for options. Example: BGTD BSE10.
- nLight EMG option requires a connection to existing nLight network. Power is provided from a separate nLight enabled fixture. Requires NLIGHT.
- Requires NLIGHT control input.
- Only available with MIN1 Minimum Dimming Level option.
- Voltage must be specified (120, 277, 347).
- Not available with nLight Wired / nLight Wireless
- Not available with NLIGHT or NLTAIR2 RIO.

Stock Configurations available for shorter lead times:

ORDERING INFORMATION										
Catalog Number	UPC	Description	Lumens	Color Temperature	CRI	Voltage	Wattage	Efficacy	Pallet Qty.	Standard Carton Qty.
EPANL 14 40L 35K	190887602739	1x4 Flat Panel	3905	3500K	>80	120-277V	38.6W	101	26	1
EPANL 14 40LHE 35K	190887602746	1x4 Flat Panel	3922	3500K	>80	120-277V	30.6W	128	26	1
EPANL 14 40L 40K	190887602753	1x4 Flat Panel	4397	4000K	>80	120-277V	38.5W	114	26	1
EPANL 14 40LHE 40K	190887602760	1x4 Flat Panel	3857	4000K	>80	120-277V	30.2W	128	26	1
EPANL 14 40L 50K	191723811605	1X4 Flat Panel	4225	5000K	>80	120-277V	38.6W	113	26	1
EPANL 22 34L 35K	190887602647	2x2 Flat Panel	3285	3500K	>80	120-277V	31.3W	105	52	1
EPANL 22 34LHE 35K	190887602661	2x2 Flat Panel	3357	3500K	>80	120-277V	26.0W	129	52	1
EPANL 22 34L 40K	190887602678	2x2 Flat Panel	3479	4000K	>80	120-277V	30.8W	113	52	1
EPANL 22 34LHE 40K	190887602685	2x2 Flat Panel	3361	4000K	>80	120-277V	25.9W	130	52	1
EPANL 22 34L 50K	191723811650	2x2 Flat Panel	3385	5000K	>80	120-277V	32.9W	102	52	1
EPANL 24 40L 35K	190887602692	2x4 Flat Panel	4039	3500K	>80	120-277V	38.8W	104	26	1
EPANL 24 40LHE 35K	190887602708	2x4 Flat Panel	3953	3500K	>80	120-277V	30.3W	130	26	1
EPANL 24 40L 40K	190887602715	2x4 Flat Panel	4351	4000K	>80	120-277V	38.9W	112	26	1
EPANL 24 40LHE 40K	190887602722	2x4 Flat Panel	4013	4000K	>80	120-277V	30.7W	131	26	1
EPANL 24 40L 50K	191723812312	2X4 Flat Panel	4108	5000K	>80	120-277V	39W	105	26	1

EPANL LED Flat Panel

Performance Data				
Configuration	CCT	Lumens	Wattage	LPW
EPANL 1X4 1500LM 80CRI 35K [MIN1, MIN10] [BLANK, ZT, EZT, NLIGHT] [MVOLT, 120, 277] [ALL OPTIONS]	3500	1455	13.3	109.8
EPANL 1X4 1500LM 80CRI 35K [MVOLT, 120V, 277V] SLD [ALL OPTIONS]	3500	1455	12.2	118.9
EPANL 1X4 1500LM 80CRI 40K [MIN1, MIN10] [BLANK, ZT, EZT, NLIGHT] [MVOLT, 120, 277] [ALL OPTIONS]	4000	1518	13.3	114.5
EPANL 1X4 1500LM 80CRI 40K [MVOLT, 120V, 277V] SLD [ALL OPTIONS]	4000	1518	12.2	124.0
EPANL 1X4 1500LM 80CRI 50K [MIN1, MIN10] [BLANK, ZT, EZT, NLIGHT] [MVOLT, 120, 277] [ALL OPTIONS]	5000	1527	13.3	115.3
EPANL 1X4 1500LM 80CRI 50K [MVOLT, 120V, 277V] SLD [ALL OPTIONS]	5000	1527	12.2	124.8
EPANL 1X4 3000LM 80CRI 35K [MIN1, MIN10] [BLANK, ZT, EZT, NLIGHT] [MVOLT, 120, 277, 347] [ALL OPTIONS]	3500	2885	27.2	105.9
EPANL 1X4 3000LM 80CRI 35K [MVOLT, 120V, 277V] SLD [ALL OPTIONS]	3500	2885	25.8	111.6
EPANL 1X4 3000LM 80CRI 40K [MIN1, MIN10] [BLANK, ZT, EZT, NLIGHT] [MVOLT, 120, 277, 347] [ALL OPTIONS]	4000	3009	27.2	110.5
EPANL 1X4 3000LM 80CRI 40K [MVOLT, 120V, 277V] SLD [ALL OPTIONS]	4000	3009	25.8	116.5
EPANL 1X4 3000LM 80CRI 50K [MIN1, MIN10] [BLANK, ZT, EZT, NLIGHT] [MVOLT, 120, 277, 347] [ALL OPTIONS]	5000	3028	27.2	111.2
EPANL 1X4 3000LM 80CRI 50K [MVOLT, 120V, 277V] SLD [ALL OPTIONS]	5000	3028	25.8	117.2
EPANL 1X4 4000LM 80CRI 35K [MIN1, MIN10] [BLANK, ZT, EZT, NLIGHT] [MVOLT, 120, 277, 347] [ALL OPTIONS]	3500	4025	38.6	104.2
EPANL 1X4 4000LM 80CRI 35K [MVOLT, 120V, 277V] SLD [ALL OPTIONS]	3500	4025	38.0	105.9
EPANL 1X4 4000LM 80CRI 40K [MIN1, MIN10] [BLANK, ZT, EZT, NLIGHT] [MVOLT, 120, 277, 347] [ALL OPTIONS]	4000	4198	38.6	108.8
EPANL 1X4 4000LM 80CRI 40K [MVOLT, 120V, 277V] SLD [ALL OPTIONS]	4000	4198	38.0	110.5
EPANL 1X4 4000LM 80CRI 50K [MIN1, MIN10] [BLANK, ZT, EZT, NLIGHT] [MVOLT, 120, 277, 347] [ALL OPTIONS]	5000	4225	38.6	109.5
EPANL 1X4 4000LM 80CRI 50K [MVOLT, 120V, 277V] SLD [ALL OPTIONS]	5000	4225	38.0	111.2
EPANL 1X4 4800LM 80CRI 35K [MIN1, MIN10] [BLANK, ZT, EZT, NLIGHT] [MVOLT, 120, 277, 347] [ALL OPTIONS]	3500	4765	47.0	101.5
EPANL 1X4 4800LM 80CRI 35K [MVOLT, 120V, 277V] SLD [ALL OPTIONS]	3500	4765	46.3	103.0
EPANL 1X4 4800LM 80CRI 40K [MIN1, MIN10] [BLANK, ZT, EZT, NLIGHT] [MVOLT, 120, 277, 347] [ALL OPTIONS]	4000	4970	47.0	105.8
EPANL 1X4 4800LM 80CRI 40K [MVOLT, 120V, 277V] SLD [ALL OPTIONS]	4000	4970	46.3	107.4
EPANL 1X4 4800LM 80CRI 50K [MIN1, MIN10] [BLANK, ZT, EZT, NLIGHT] [MVOLT, 120, 277, 347] [ALL OPTIONS]	5000	5002	47.0	106.5
EPANL 1X4 4800LM 80CRI 50K [MVOLT, 120V, 277V] SLD [ALL OPTIONS]	5000	5002	46.3	108.1
EPANL 1X4 6000LM 80CRI 35K [MIN1, MIN10] 2T [MVOLT, 120, 277, 347] [ALL OPTIONS]	3500	5804	49.9	116.4
EPANL 1X4 6000LM 80CRI 40K [MIN1, MIN10] 2T [MVOLT, 120, 277, 347] [ALL OPTIONS]	4000	5976	49.9	119.9
EPANL 1X4 6000LM 80CRI 50K [MIN1, MIN10] 2T [MVOLT, 120, 277, 347] [ALL OPTIONS]	5000	6028	49.9	120.9
EPANL 2X2 2000LM 80CRI 35K [MIN1, MIN10] [BLANK, ZT, EZT, NLIGHT] [MVOLT, 120, 277, 347] [ALL OPTIONS]	3500	1946	18.9	103.0
EPANL 2X2 2000LM 80CRI 35K [MVOLT, 120V, 277V] SLD [ALL OPTIONS]	3500	1946	17.3	112.2
EPANL 2X2 2000LM 80CRI 40K [MIN1, MIN10] [BLANK, ZT, EZT, NLIGHT] [MVOLT, 120, 277, 347] [ALL OPTIONS]	4000	2030	19.6	103.7
EPANL 2X2 2000LM 80CRI 40K [MVOLT, 120V, 277V] SLD [ALL OPTIONS]	4000	2030	17.3	117.1
EPANL 2X2 2000LM 80CRI 50K [MIN1, MIN10] [BLANK, ZT, EZT, NLIGHT] [MVOLT, 120, 277, 347] [ALL OPTIONS]	5000	2043	19.6	104.4
EPANL 2X2 2000LM 80CRI 50K [MVOLT, 120V, 277V] SLD [ALL OPTIONS]	5000	2043	17.3	117.8
EPANL 2X2 3400LM 80CRI 35K [MIN1, MIN10] [BLANK, ZT, EZT, NLIGHT] [MVOLT, 120, 277, 347] [ALL OPTIONS]	3500	3225	32.1	100.4
EPANL 2X2 3400LM 80CRI 35K [MVOLT, 120V, 277V] SLD [ALL OPTIONS]	3500	3225	31.2	103.4
EPANL 2X2 3400LM 80CRI 40K [MIN1, MIN10] [BLANK, ZT, EZT, NLIGHT] [MVOLT, 120, 277, 347] [ALL OPTIONS]	4000	3364	32.9	102.3
EPANL 2X2 3400LM 80CRI 40K [MVOLT, 120V, 277V] SLD [ALL OPTIONS]	4000	3364	31.2	107.9
EPANL 2X2 3400LM 80CRI 50K [MIN1, MIN10] [BLANK, ZT, EZT, NLIGHT] [MVOLT, 120, 277, 347] [ALL OPTIONS]	5000	3385	32.9	103.0
EPANL 2X2 3400LM 80CRI 50K [MVOLT, 120V, 277V] SLD [ALL OPTIONS]	5000	3385	31.2	108.6
EPANL 2X2 4000LM 80CRI 35K [MIN1, MIN10] [BLANK, ZT, EZT, NLIGHT] [MVOLT, 120, 277, 347] [ALL OPTIONS]	3500	4025	32.2	125.2
EPANL 2X2 4000LM 80CRI 35K [MVOLT, 120V, 277V] SLD [ALL OPTIONS]	3500	4025	31.7	127.1
EPANL 2X2 4000LM 80CRI 40K [MIN1, MIN10] [BLANK, ZT, EZT, NLIGHT] [MVOLT, 120, 277, 347] [ALL OPTIONS]	4000	4144	32.2	128.9
EPANL 2X2 4000LM 80CRI 40K [MVOLT, 120V, 277V] SLD [ALL OPTIONS]	4000	4144	31.7	130.8
EPANL 2X2 4000LM 80CRI 50K [MIN1, MIN10] [BLANK, ZT, EZT, NLIGHT] [MVOLT, 120, 277, 347] [ALL OPTIONS]	5000	4180	32.2	130.0
EPANL 2X2 4000LM 80CRI 50K [MVOLT, 120V, 277V] SLD [ALL OPTIONS]	5000	4180	31.7	132.0
EPANL 2X2 4800LM 80CRI 35K [MIN1, MIN10] [BLANK, ZT, EZT, NLIGHT] [MVOLT, 120, 277, 347] [ALL OPTIONS]	3500	4446	36.2	122.7
EPANL 2X2 4800LM 80CRI 35K [MVOLT, 120V, 277V] SLD [ALL OPTIONS]	3500	4446	35.7	124.6
EPANL 2X2 4800LM 80CRI 40K [MIN1, MIN10] [BLANK, ZT, EZT, NLIGHT] [MVOLT, 120, 277, 347] [ALL OPTIONS]	4000	4578	36.2	126.4
EPANL 2X2 4800LM 80CRI 40K [MVOLT, 120V, 277V] SLD [ALL OPTIONS]	4000	4578	35.7	128.3
EPANL 2X2 4800LM 80CRI 50K [MIN1, MIN10] [BLANK, ZT, EZT, NLIGHT] [MVOLT, 120, 277, 347] [ALL OPTIONS]	5000	4618	36.2	127.5
EPANL 2X2 4800LM 80CRI 50K [MVOLT, 120V, 277V] SLD [ALL OPTIONS]	5000	4618	35.7	129.4
EPANL 2X4 3000LM 80CRI 35K [MIN1, MIN10] [BLANK, ZT, EZT, NLIGHT] [MVOLT, 120, 277, 347] [ALL OPTIONS]	3500	2993	27.4	109.4
EPANL 2X4 3000LM 80CRI 35K [MVOLT, 120V, 277V] SLD [ALL OPTIONS]	3500	2993	26.0	115.3
EPANL 2X4 3000LM 80CRI 40K [MIN1, MIN10] [BLANK, ZT, EZT, NLIGHT] [MVOLT, 120, 277, 347] [ALL OPTIONS]	4000	3122	27.4	114.1
EPANL 2X4 3000LM 80CRI 40K [MVOLT, 120V, 277V] SLD [ALL OPTIONS]	4000	3122	26.0	120.3
EPANL 2X4 3000LM 80CRI 50K [MIN1, MIN10] [BLANK, ZT, EZT, NLIGHT] [MVOLT, 120, 277, 347] [ALL OPTIONS]	5000	3142	27.4	114.8
EPANL 2X4 3000LM 80CRI 50K [MVOLT, 120V, 277V] SLD [ALL OPTIONS]	5000	3142	26.0	121.1
EPANL 2X4 4000LM 80CRI 35K [MIN1, MIN10] [BLANK, ZT, EZT, NLIGHT] [MVOLT, 120, 277, 347] [ALL OPTIONS]	3500	3914	39.0	100.4
EPANL 2X4 4000LM 80CRI 35K [MVOLT, 120V, 277V] SLD [ALL OPTIONS]	3500	3914	38.4	101.9
EPANL 2X4 4000LM 80CRI 40K [MIN1, MIN10] [BLANK, ZT, EZT, NLIGHT] [MVOLT, 120, 277, 347] [ALL OPTIONS]	4000	4082	39.0	104.7
EPANL 2X4 4000LM 80CRI 40K [MVOLT, 120V, 277V] SLD [ALL OPTIONS]	4000	4082	38.4	106.3
EPANL 2X4 4000LM 80CRI 50K [MIN1, MIN10] [BLANK, ZT, EZT, NLIGHT] [MVOLT, 120, 277, 347] [ALL OPTIONS]	5000	4108	39.0	105.4
EPANL 2X4 4000LM 80CRI 50K [MVOLT, 120V, 277V] SLD [ALL OPTIONS]	5000	4108	38.4	106.9
EPANL 2X4 4800LM 80CRI 35K [MIN1, MIN10] [BLANK, ZT, EZT, NLIGHT] [MVOLT, 120, 277, 347] [ALL OPTIONS]	3500	4771	47.1	101.2
EPANL 2X4 4800LM 80CRI 35K [MVOLT, 120V, 277V] SLD [ALL OPTIONS]	3500	4771	46.4	102.7
EPANL 2X4 4800LM 80CRI 40K [MIN1, MIN10] [BLANK, ZT, EZT, NLIGHT] [MVOLT, 120, 277, 347] [ALL OPTIONS]	4000	4976	47.1	105.6
EPANL 2X4 4800LM 80CRI 40K [MVOLT, 120V, 277V] SLD [ALL OPTIONS]	4000	4976	46.4	107.2
EPANL 2X4 4800LM 80CRI 50K [MIN1, MIN10] [BLANK, ZT, EZT, NLIGHT] [MVOLT, 120, 277, 347] [ALL OPTIONS]	5000	5008	47.1	106.2
EPANL 2X4 4800LM 80CRI 50K [MVOLT, 120V, 277V] SLD [ALL OPTIONS]	5000	5008	46.4	107.8
EPANL 2X4 5400LM 80CRI 35K [MIN1, MIN10] [BLANK, ZT, EZT, NLIGHT] [MVOLT, 120, 277, 347] [ALL OPTIONS]	3500	5143	51.4	100.1
EPANL 2X4 5400LM 80CRI 35K [MVOLT, 120V, 277V] SLD [ALL OPTIONS]	3500	5143	51.4	100.1
EPANL 2X4 5400LM 80CRI 40K [MIN1, MIN10] [BLANK, ZT, EZT, NLIGHT] [MVOLT, 120, 277, 347] [ALL OPTIONS]	4000	5296	52.1	101.6
EPANL 2X4 5400LM 80CRI 40K [MVOLT, 120V, 277V] SLD [ALL OPTIONS]	4000	5296	51.4	103.1
EPANL 2X4 5400LM 80CRI 50K [MIN1, MIN10] [BLANK, ZT, EZT, NLIGHT] [MVOLT, 120, 277, 347] [ALL OPTIONS]	5000	5341	52.1	102.4
EPANL 2X4 5400LM 80CRI 50K [MVOLT, 120V, 277V] SLD [ALL OPTIONS]	5000	5341	51.4	104.0
EPANL 2X4 6000LM 80CRI 35K [MIN1, MIN10] 2T [MVOLT, 120, 277, 347] [ALL OPTIONS]	3500	6369	54.0	118.0
EPANL 2X4 6000LM 80CRI 40K [MIN1, MIN10] 2T [MVOLT, 120, 277, 347] [ALL OPTIONS]	4000	6558	54.0	121.5
EPANL 2X4 6000LM 80CRI 50K [MIN1, MIN10] 2T [MVOLT, 120, 277, 347] [ALL OPTIONS]	5000	6615	54.0	122.6
EPANL 2X4 6800LM 80CRI 35K [MIN1, MIN10] 2T [MVOLT, 120, 277, 347] [ALL OPTIONS]	3500	6645	59.9	110.9
EPANL 2X4 6800LM 80CRI 40K [MIN1, MIN10] 2T [MVOLT, 120, 277, 347] [ALL OPTIONS]	4000	6842	59.9	114.2
EPANL 2X4 6800LM 80CRI 50K [MIN1, MIN10] 2T [MVOLT, 120, 277, 347] [ALL OPTIONS]	5000	6901	59.9	115.2



EPANL Configurable

ACCESSORIES

Accessories: Order as separate catalog number.

DGA14	Drywall grid adapter for 1x4 recessed fixture.
DGA22	Drywall grid adapter for 2x2 recessed fixture.
DGA24	Drywall grid adapter for 2x4 recessed fixture.
PS1055CP FMC BRKT	Power Sentry emergency constant power battery pack field installation kit for Certified in CA Title 20 MAEDBS. ¹
2X2SMKSH	2'x2' Surface Mount Troffer Kit ¹
2X4SMKSH	2'x4' Surface Mount Troffer Kit ¹
1X4SMKSH	1'x4' Surface Mount Troffer Kit ¹
EPANL TGRID CLIP J4	Pack of 4 grid clips for 9/16" T grid compatibility.
EPANL TGRID CLIP J50	Pack of 50 grid clips for 9/16" T grid compatibility.
1X4PANLACG 36	Adjustable aircraft cable gripper suspension kit with 36" length cables for 1X4 fixture. Includes: suspension cables, mounting hardware, and 5 wire power feed cable (Ground, Hot, Neutral, and Low Voltage Leads). ²
1X4PANLACG 72	Adjustable aircraft cable gripper suspension kit with 72" length cables for 1X4 fixture. Includes: suspension cables, mounting hardware, and 5 wire power feed cable (Ground, Hot, Neutral, and Low Voltage Leads). ²
2X2PANLACG 36	Adjustable aircraft cable gripper suspension kit with 36" length cables for 2X2 fixture. Includes: suspension cables, mounting hardware, and 5 wire power feed cable (Ground, Hot, Neutral, and Low Voltage Leads). ²
2X2PANLACG 72	Adjustable aircraft cable gripper suspension kit with 72" length cables for 2X2 fixture. Includes: suspension cables, mounting hardware, and 5 wire power feed cable (Ground, Hot, Neutral, and Low Voltage Leads). ²
2X4PANLACG 36	Adjustable aircraft cable gripper suspension kit with 36" length cables for 2X4 fixture. Includes: suspension cables, mounting hardware, and 5 wire power feed cable (Ground, Hot, Neutral, and Low Voltage Leads). ²
2X4PANLACG 72	Adjustable aircraft cable gripper suspension kit with 72" length cables for 2X4 fixture. Includes: suspension cables, mounting hardware, and 5 wire power feed cable (Ground, Hot, Neutral, and Low Voltage Leads). ²

Emergency Battery Estimated Lumens

Use the formula below to estimate the delivered lumens in emergency mode

Estimated Lumens = 1.25 x P x LPW

P = Output power of emergency driver (10W for PS1055CP)

LPW = Lumen per watt rating of the luminaire.

SMKSH Accessory



Notes:

- Cannot be installed with fixture with integrated NLTAIR2 RIO.
- See Suspension Kits section on bottom of page 6 for additional detail.

nLight® Wired Control Accessories:
Order as separate catalog number. Visit www.acuitybrands.com/products/controls/nlight.

WallPod stations	Model number	Occupancy sensors	Model number
On/Off	nPDDM [color]	Small motion 360°, ceiling (PIR / dual tech)	nCM 9 RJB / nCM PDT 9 RJB
On/Off & raise/lower	nPDDM DX [color]	Large motion 360°, ceiling (PIR / dual tech)	nCM10 RJB / nCM PDT 10 RJB
Graphic touchscreen	nPOD GFX [color]	Wall switch with raise/lower	nWSX PDT LV DX [color]
Photocell controls	Model number	Cat-5 cable (plenum rated)	Model number
Full range dimming	nCM ADCX RJB	10' cable	CAT5 10FT J1
		30' cable	CAT5 30FT J1

nLight® AIR Control Accessories:
Order as separate catalog number. Visit www.acuitybrands.com/products/controls/nlightair.

Wall switches	Model number
On/Off single pole	rPODB [color] G2
On/Off two pole	rPODB 2P [color] G2
On/Off & raise/lower single pole	rPODB DX [color] G2
On/Off & raise/lower two pole	rPODB 2P DX [color] G2
On/Off & raise/lower single pole	rPODBZ DX WH G2

rCMS ¹		Example: RCMS PDT 10 AR G2							
Series / Detection	Power Supply ¹	Occupancy Detection		Lens (Required)		Operating Mode		Generation	
RCMS nLight AIR occupancy and daylight sensor	[blank] Power Supply ordered separately	[blank] PIR Detection	PDT Dual Tech PIR/Microphonics	10	Large Motion/ Extended Range 360°	[BLANK] None	AR Auxiliary Relay	G2	Generation 2 compatibility
	PS 150 Standard 150 mA Power Supply			9	Small Motion/ Extended Range 360°				
				6	High Bay 360° Lens				

Notes

- RCMS requires low voltage power from either RPP20 DS 24V G2 or PS150.

nLight AIR Wireless

nLight AIR is the ideal solution for retrofit or new construction spaces where adding additional wiring can be labor intensive and costly. The integrated RIO module is part of each luminaire in the nLight AIR network, which can be grouped to control multiple luminaires.



Simple as 1, 2, 3

- Install the nLight® AIR fixtures with integrated RIO module.
- Install the wireless battery-powered wall switch.
- With CLAIRITY PRO app, pair the fixtures with the wall switch and if desired, add and customize the ceiling mount sensor settings.



EPANL LED Flat Panel

EPANL compatible with Sensor Switch™
WSX-D and SPOD wall switches.



WSX-D



SPOD

PHOTOMETRICS

EPANL 2x2 4000LM 80CRI 40K, 4144.5 delivered lumens.

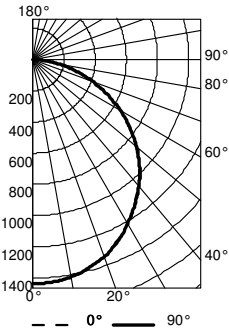

CP Summary		Coefficients of Utilization										Zonal Lumen Summary			
0° 90°		80%		70%		50%		20%		50%		Zone	Lumens	% Lamp	% Fixture
0°	90°	pw	70%	50%	30%	50%	30%	10%	50%	30%	10%				
0°	1433	1433	119	119	119	116	116	116	111	111	111	0° - 30°	1115	26.9	26.9
5°	1432	1431	108	104	99	101	97	94	97	94	91	0° - 40°	1823	44.0	44.0
15°	1385	1385	98	90	83	88	82	76	85	79	75	0° - 60°	3234	78.0	78.0
25°	1282	1285	90	79	71	77	70	63	74	68	62	0° - 90°	4144	100.0	100.0
35°	1136	1140	82	70	61	69	60	54	66	59	53	90° - 120°	1	0.0	0.0
45°	964	968	75	62	53	61	53	46	59	52	46	90° - 130°	1	0.0	0.0
55°	754	758	70	56	47	55	47	40	53	46	40	90° - 150°	1	0.0	0.0
65°	529	528	65	51	42	50	42	36	48	41	35	90° - 180°	1	0.0	0.0
75°	296	291	60	46	38	46	37	32	44	37	32				
85°	85	80	56	43	34	42	34	29	41	34	28				
90°	4	3	53	39	31	39	31	26	38	31	26				

EPANL 2x4 4800LM 80CRI 40K, 4976.3 delivered lumens.

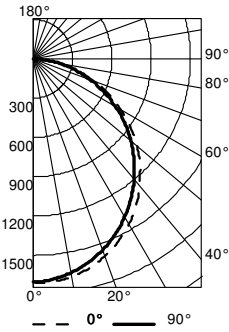

CP Summary		Coefficients of Utilization										Zonal Lumen Summary			
0° 90°		80%		70%		50%		20%		50%		Zone	Lumens	% Lamp	% Fixture
0°	90°	pw	70%	50%	30%	50%	30%	10%	50%	30%	10%				
0°	1703	1703	119	119	119	116	116	116	111	111	111	0° - 30°	1330	26.7	26.7
5°	1707	1689	108	103	99	101	97	93	97	94	91	0° - 40°	2179	43.8	43.8
15°	1653	1610	98	90	83	88	82	76	84	79	74	0° - 60°	3862	77.6	77.6
25°	1535	1477	90	79	70	77	69	63	74	68	62	0° - 90°	4975	100.0	100.0
35°	1364	1300	82	70	61	68	60	54	66	59	53	90° - 120°	1	0.0	0.0
45°	1154	1086	75	62	53	61	52	46	59	51	46	90° - 130°	1	0.0	0.0
55°	903	851	69	56	47	55	46	40	53	46	40	90° - 150°	1	0.0	0.0
65°	636	593	64	51	42	50	41	35	48	41	35	90° - 180°	1	0.0	0.0
75°	354	335	60	46	38	46	37	32	44	37	31				
85°	103	103	56	42	34	42	34	28	41	33	28				
90°	3	13	52	39	31	39	31	26	38	31	26				

EPANL 2x4 6800LM 80CRI 40K, 6842.1 delivered lumens.

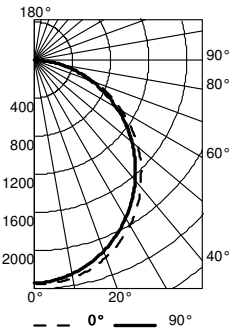

CP Summary		Coefficients of Utilization										Zonal Lumen Summary			
0° 90°		80%		70%		50%		20%		50%		Zone	Lumens	% Lamp	% Fixture
0°	90°	pw	70%	50%	30%	50%	30%	10%	50%	30%	10%				
0°	2342	2342	119	119	119	116	116	116	111	111	111	0° - 30°	1829	26.7	26.7
5°	2347	2323	108	103	99	101	97	93	97	94	91	0° - 40°	2996	43.8	43.8
15°	2273	2214	98	90	83	88	82	76	84	79	74	0° - 60°	5310	77.6	77.6
25°	2111	2030	90	79	70	77	69	63	74	68	62	0° - 90°	6840	100.0	100.0
35°	1875	1788	82	70	61	68	60	54	66	59	53	90° - 120°	1	0.0	0.0
45°	1586	1493	75	62	53	61	52	46	59	51	46	90° - 130°	1	0.0	0.0
55°	1242	1170	69	56	47	55	46	40	53	46	40	90° - 150°	1	0.0	0.0
65°	874	816	64	51	42	50	41	35	48	41	35	90° - 180°	1	0.0	0.0
75°	487	461	60	46	38	46	37	32	44	37	31				
85°	141	141	56	42	34	42	34	28	41	33	28				
90°	3	17	52	39	31	39	31	26	38	31	26				

DIMENSIONS

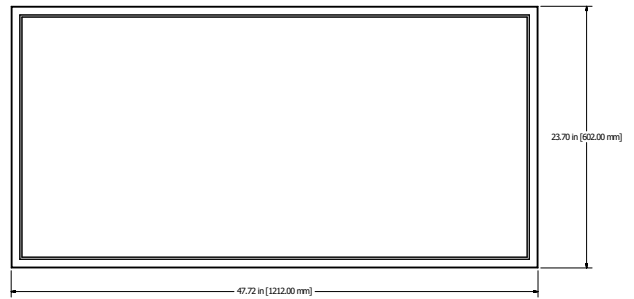
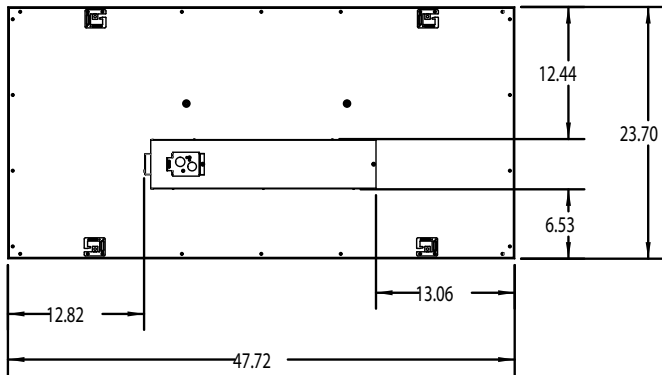
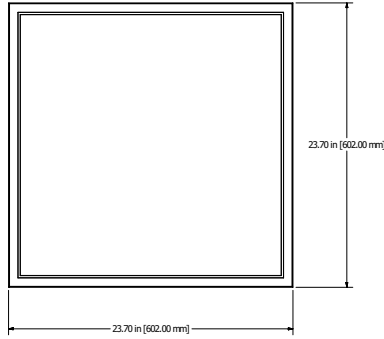
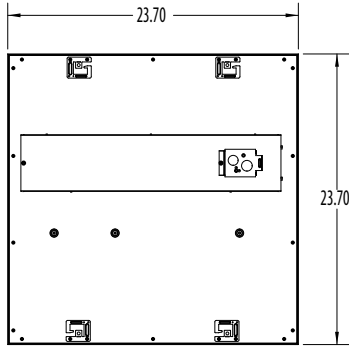
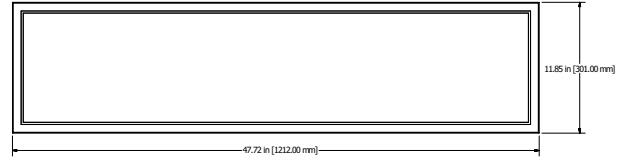
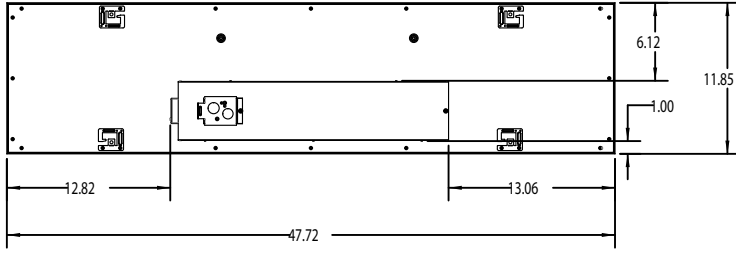

Suspension Kits

1X4PANLACG



2X2PANLACG

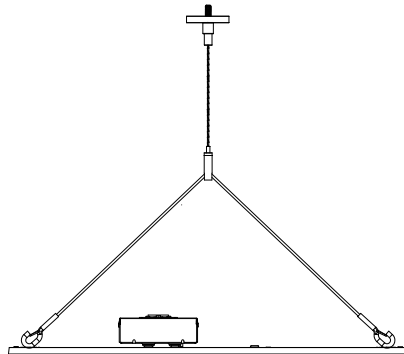

2X4PANLACG

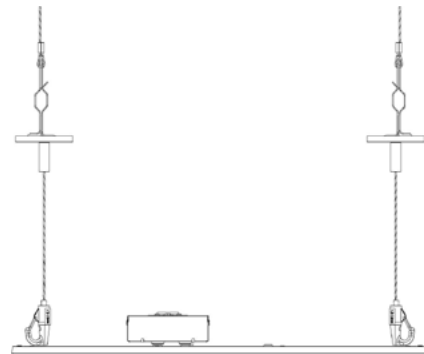

1X4SMKSH, 2X2SMKSH, 2X4SMKSH
SURFACE MOUNT KIT - MOUNTING DATA

