

Type 4 Mild Steel Wallmount Enclosure *Eclipse Series*

Hinge Door with Quarter Turn/Handle



Panel
Sold
Separately



Application

- Designed to enclose electrical and/or electronic equipment and protect against harsh, industrial environments for wallmount applications.
- Impressive styling features like hidden hinges, attractive latching systems make the Eclipse a suitable addition to any high-tech equipment installation.
- A wide range of sizes and practical accessories make this product line a complete package.

Standards

- UL 508 Type 3R, 4, and 12
- CSA Type 3R, 4, and 12
- Complies with
 - NEMA Type 3R, 4, and 12
 - IEC 60529, IP66

Construction

- Formed 14 or 16 gauge steel.
- Smooth, continuously welded seams ground smooth.
- Door stiffeners are provided where required for increased strength and rigidity - designed to also permit additional mounting options.
- Formed lip on enclosure to exclude flowing liquids and contaminants.
- Door latches feature the added safety of quarter turn slot requiring use of tool for opening.
- Doors may be easily removed for modifications and are interchangeable.
- Seamless poured-in place gasket.
- Collar studs provided for mounting inner panel.
- Includes hardware kit with panel mounting nuts and sealing washers for wall mounting holes.
- Bonding stud provided on door and grounding stud installed in enclosure.
- Hinges are constructed from 304 stainless steel.
- Hinge pins are stainless steel.
- Quarter turn latch and multi-point handle (key lockable) are zinc diecast with black epoxy finish.
- Door alignment guide provided on 36" wide enclosures.

Finish

- Cover and enclosure are phosphatized and finished with a recoatable powder inside and out with choice of ANSI 61 smooth Gray (GY) or RAL7035 textured light gray (LG).

Accessories

- Cooling Products
- Ventilation
- DIN Rail Mounting Kit
- Door Stop Kit
- Gland Plates
- Inner Panels
- Quarter Turn Inserts and Keys
- Mounting Foot Kit
- Swing Frame
- Rear Hole Plugs
- Quarter Turn Assemblies
- Touch-Up Spray Paint
- Padlock Adaptor
- Blowers and Fans
- DIN Rails
- Drip Shield Kit
- Filtered Fans
- Heaters
- Handles
- Literature Pocket
- Swing Panel
- Eclipse Rack Panel
- Replacement Hinge Pins
- Temperature Controls
- Type 4 Hardware Kits
- Ground Wire Kits

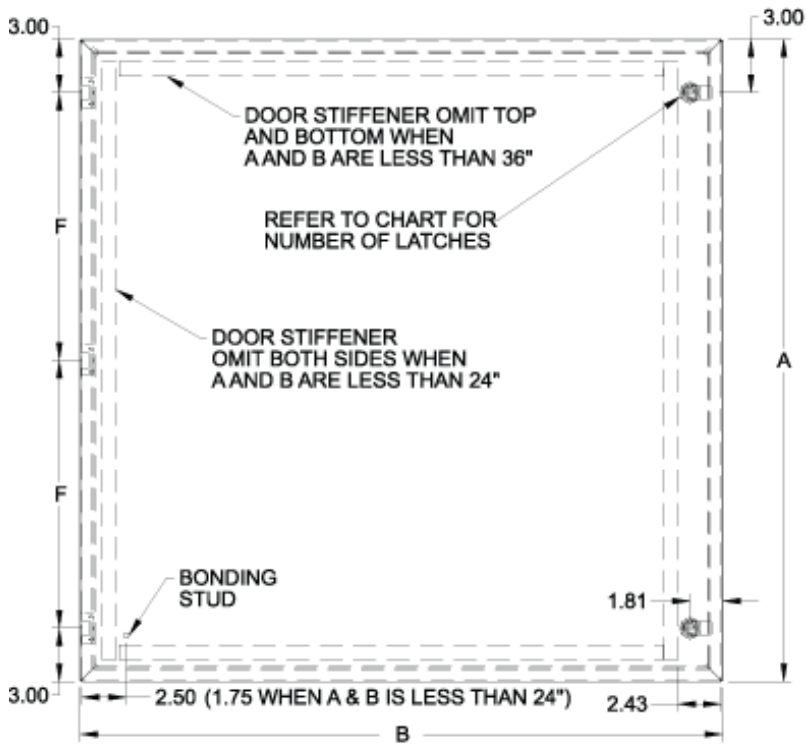

Front View

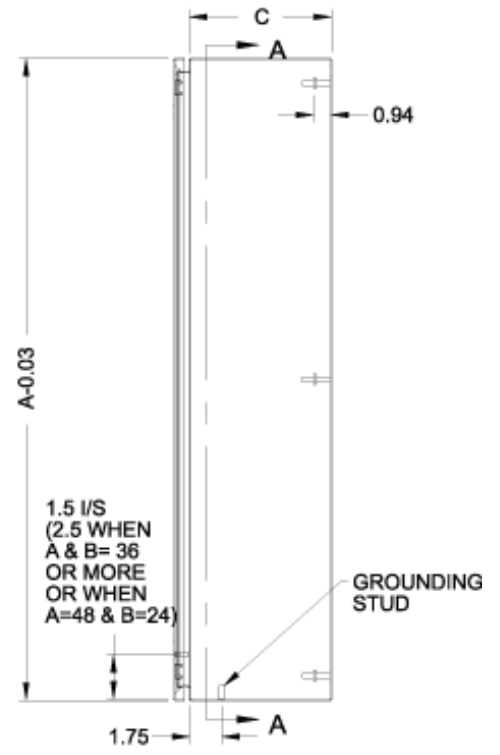

Side View

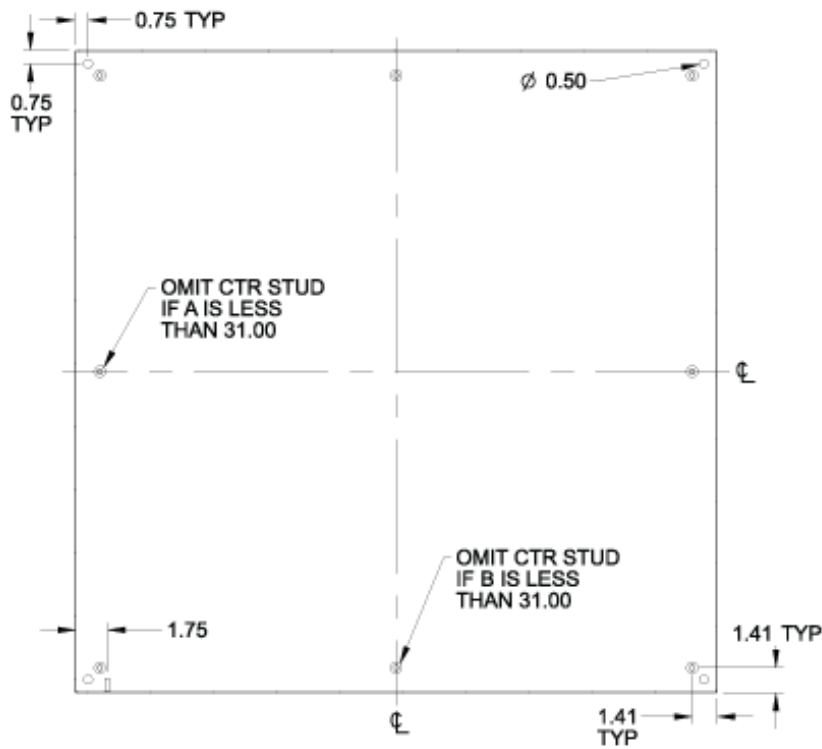

SECTION A-A

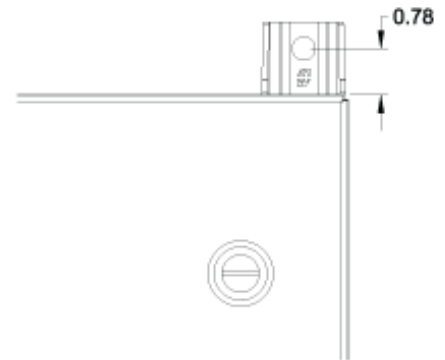

Mounting Foot Detail

Part No. (ANSI 61 Gray)	Part No. (RAL 7035 Light Gray)	Overall Dimensions			Door/Body Gauge	Latches Qty	Latches Type	Opt. Panel Part No.	Panel Size			# Hinges	Ship Wt. (lbs)
		A	B	C					D	E	F		
EN4SD12106GY	EN4SD12106LG	12.00	10.00	6.00	16	1	Qtr Turn	EP1210	10.20	8.20	2	6.00	11
EN4SD12126GY	EN4SD12126LG	12.00	12.00	6.00	16	1	Qtr Turn	EP1212	10.20	10.20	2	6.00	12
EN4SD12246GY	EN4SD12246LG	12.00	24.00	6.00	16	1	Qtr Turn	EP1224	10.20	22.20	2	18.00	24
EN4SD16126GY	EN4SD16126LG	16.00	12.00	6.00	16	1	Qtr Turn	EP1612	14.20	10.20	2	10.00	16
EN4SD16166GY	EN4SD16166LG	16.00	16.00	6.00	16	1	Qtr Turn	EP1616	14.20	14.20	2	10.00	19
EN4SD16206GY	EN4SD16206LG	16.00	20.00	6.00	16	1	Qtr Turn	EP1620	14.20	18.20	2	10.00	22

Part No. (ANSI 61 Gray)	Part No. (RAL 7035 Light Gray)	Overall Dimensions			Door/Body Gauge	Latches Qty	Latches Type	Opt. Panel Part No.	Panel Size		# Hinges	F	Ship Wt. (lbs)
		A	B	C					D	E			
EN4SD20126GY	EN4SD20126LG	20.00	12.00	6.00	16	1	Qtr Turn	EP2012	18.20	10.20	2	14.00	20
EN4SD20166GY	EN4SD20166LG	20.00	16.00	6.00	16	1	Qtr Turn	EP2016	18.20	14.20	2	14.00	22
EN4SD20206GY	EN4SD20206LG	20.00	20.00	6.00	16	1	Qtr Turn	EP2020	18.20	18.20	2	14.00	26
EN4SD20246GY	EN4SD20246LG	20.00	24.00	6.00	16	1	Qtr Turn	EP2024	22.20	10.20	2	14.00	32
EN4SD24126GY	EN4SD24126LG	24.00	12.00	6.00	16	1	Qtr Turn	EP2412	22.20	10.20	2	18.00	24
EN4SD24166GY	EN4SD24166LG	24.00	16.00	6.00	16	1	Qtr Turn	EP2416	22.20	14.20	2	18.00	26
EN4SD24206GY	EN4SD24206LG	24.00	20.00	6.00	16	1	Qtr Turn	EP2420	22.20	18.20	2	18.00	30
EN4SD24246GY	EN4SD24246LG	24.00	24.00	6.00	14	2	Qtr Turn	EP2424	22.20	22.20	2	18.00	37
EN4SD30166GY	EN4SD30166LG	30.00	16.00	6.00	14	2	Qtr Turn	EP3016	28.20	14.20	3	12.00	35
EN4SD30206GY	EN4SD30206LG	30.00	20.00	6.00	14	2	Qtr Turn	EP3020	28.20	18.20	3	12.00	38
EN4SD30246GY	EN4SD30246LG	30.00	24.00	6.00	14	2	Qtr Turn	EP3024	28.20	22.20	3	12.00	40
EN4SD36246GY	EN4SD36246LG	36.00	24.00	6.00	14	2	Qtr Turn	EP3624	34.20	22.20	3	15.00	52
EN4SD36306GY	EN4SD36306LG	36.00	30.00	6.00	14	2	Qtr Turn	EP3630	34.20	28.20	3	15.00	60
EN4SD12248GY	EN4SD12248LG	12.00	24.00	8.00	16	1	Qtr Turn	EP1224	10.20	22.20	2	6.00	25
EN4SD16128GY	EN4SD16128LG	16.00	12.00	8.00	16	1	Qtr Turn	EP1612	14.20	10.20	2	10.00	16
EN4SD16168GY	EN4SD16168LG	16.00	16.00	8.00	16	1	Qtr Turn	EP1616	14.20	14.20	2	10.00	21
EN4SD16208GY	EN4SD16208LG	16.00	20.00	8.00	16	1	Qtr Turn	EP1620	14.20	18.20	2	10.00	25
EN4SD20128GY	EN4SD20128LG	20.00	12.00	8.00	16	1	Qtr Turn	EP2012	18.20	10.20	2	14.00	22
EN4SD20168GY	EN4SD20168LG	20.00	16.00	8.00	16	1	Qtr Turn	EP2016	18.20	14.20	2	14.00	25
EN4SD20208GY	EN4SD20208LG	20.00	20.00	8.00	16	1	Qtr Turn	EP2020	18.20	18.20	2	14.00	28
EN4SD20248GY	EN4SD20248LG	20.00	24.00	8.00	16	1	Qtr Turn	EP2024	18.20	22.20	2	14.00	32
EN4SD24128GY	EN4SD24128LG	24.00	12.00	8.00	16	1	Qtr Turn	EP2412	22.20	10.20	2	18.00	25
EN4SD24168GY	EN4SD24168LG	24.00	16.00	8.00	16	1	Qtr Turn	EP2416	22.20	14.20	2	18.00	26
EN4SD24208GY	EN4SD24208LG	24.00	20.00	8.00	16	1	Qtr Turn	EP2420	22.20	18.20	2	18.00	32
EN4SD24248GY	EN4SD24248LG	24.00	24.00	8.00	14	2	Qtr Turn	EP2424	22.20	22.20	2	18.00	40
EN4SD24308GY	EN4SD24308LG	24.00	30.00	8.00	14	2	Qtr Turn	EP2430	22.20	28.20	2	18.00	48
EN4SD30128GY	EN4SD30128LG	30.00	12.00	8.00	14	2	Qtr Turn	EP3012	28.20	10.20	3	12.00	34
EN4SD30168GY	EN4SD30168LG	30.00	16.00	8.00	14	2	Qtr Turn	EP3016	28.20	14.20	3	12.00	40
EN4SD30208GY	EN4SD30208LG	30.00	20.00	8.00	14	2	Qtr Turn	EP3020	28.20	18.20	3	12.00	42
EN4SD30248GY	EN4SD30248LG	30.00	24.00	8.00	14	2	Qtr Turn	EP3024	28.20	22.20	3	12.00	46
EN4SD30308GY	EN4SD30308LG	30.00	30.00	8.00	14	2	Qtr Turn	EP3030	28.20	28.20	3	12.00	67
EN4SD30368GY	EN4SD30368LG	30.00	36.00	8.00	14	2	Qtr Turn	EP3036	28.20	34.20	3	12.00	77
EN4SD36248GY	EN4SD36248LG	36.00	24.00	8.00	14	2	Qtr Turn	EP3624	34.20	22.20	3	15.00	55
EN4SD36308GY	EN4SD36308LG	36.00	30.00	8.00	14	2	Qtr Turn	EP3630	34.20	28.20	3	15.00	77
EN4SD36368GY	EN4SD36368LG	36.00	36.00	8.00	14	2	Qtr Turn	EP3636	34.20	34.20	3	15.00	94
EN4SD42248GY	EN4SD42248LG	42.00	24.00	8.00	14	1	3-point	EP4224	40.20	22.20	4	12.00	80
EN4SD42308GY	EN4SD42308LG	42.00	30.00	8.00	14	1	3-point	EP4230	40.20	28.20	4	12.00	95
EN4SD42368GY	EN4SD42368LG	42.00	36.00	8.00	14	1	3-point	EP4236	40.20	34.20	4	12.00	105
EN4SD48248GY	EN4SD48248LG	48.00	24.00	8.00	14	1	3-point	EP4824	46.20	22.20	4	14.00	110
EN4SD48308GY	EN4SD48308LG	48.00	30.00	8.00	14	1	3-point	EP4830	46.20	28.20	4	14.00	115
EN4SD48368GY	EN4SD48368LG	48.00	36.00	8.00	14	1	3-point	EP4836	46.20	34.20	4	14.00	120
EN4SD60368GY	EN4SD60368LG	60.00	36.00	8.00	14	1	3-point	EP6036	58.20	34.20	4	18.00	150
EN4SD161210GY	EN4SD161210LG	16.00	12.00	10.00	16	1	Qtr. Turn	EP1612	14.20	10.20	2	10.00	18
EN4SD161610GY	EN4SD161610LG	16.00	16.00	10.00	16	1	Qtr. Turn	EP1616	14.20	14.20	2	10.00	23
EN4SD162010GY	EN4SD162010LG	16.00	20.00	10.00	16	1	Qtr. Turn	EP1620	14.20	18.20	2	10.00	28
EN4SD201610GY	EN4SD201610LG	20.00	16.00	10.00	16	1	Qtr. Turn	EP2016	18.20	14.20	2	14.00	28
EN4SD202010GY	EN4SD202010LG	20.00	20.00	10.00	16	1	Qtr. Turn	EP2020	18.20	18.20	2	14.00	31

Part No. (ANSI 61 Gray)	Part No. (RAL 7035 Light Gray)	Overall Dimensions			Door/Body Gauge	Latches Qty	Latches Type	Opt. Panel Part No.	Panel Size			# Hinges	F	Ship Wt. (lbs)
		A	B	C					D	E				
EN4SD202410GY	EN4SD202410LG	20.00	24.00	10.00	16	1	Qtr. Turn	EP2024	18.20	22.20	2	14.00	36	
EN4SD241210GY	EN4SD241210LG	24.00	12.00	10.00	16	1	Qtr Turn	EP2412	22.20	10.20	2	18.00	26	
EN4SD241610GY	EN4SD241610LG	24.00	16.00	10.00	16	1	Qtr. Turn	EP2416	22.20	14.20	2	18.00	30	
EN4SD242010GY	EN4SD242010LG	24.00	20.00	10.00	16	1	Qtr. Turn	EP2420	22.20	18.20	2	18.00	36	
EN4SD242410GY	EN4SD242410LG	24.00	24.00	10.00	14	2	Qtr. Turn	EP2424	22.20	22.20	2	18.00	45	
EN4SD243010GY	EN4SD243010LG	24.00	30.00	10.00	14	2	Qtr. Turn	EP2430	22.20	28.20	2	18.00	53	
EN4SD302010GY	EN4SD302010LG	30.00	20.00	10.00	14	2	Qtr. Turn	EP3020	28.20	18.20	3	12.00	47	
EN4SD302410GY	EN4SD302410LG	30.00	24.00	10.00	14	2	Qtr. Turn	EP3024	28.20	22.20	3	12.00	53	
EN4SD303010GY	EN4SD303010LG	30.00	30.00	10.00	14	2	Qtr. Turn	EP3030	28.20	28.20	3	12.00	75	
EN4SD362410GY	EN4SD362410LG	36.00	24.00	10.00	14	2	Qtr. Turn	EP3624	34.20	22.20	3	15.00	70	
EN4SD363010GY	EN4SD363010LG	36.00	30.00	10.00	14	2	Qtr. Turn	EP3630	34.20	28.20	3	15.00	84	
EN4SD363610GY	EN4SD363610LG	36.00	36.00	10.00	14	2	Qtr. Turn	EP3636	34.20	34.20	3	15.00	100	
EN4SD422410GY	EN4SD422410LG	42.00	24.00	10.00	14	1	3-point	EP4224	40.20	22.20	4	12.00	86	
EN4SD423010GY	EN4SD423010LG	42.00	30.00	10.00	14	1	3-point	EP4230	40.20	28.20	4	12.00	107	
EN4SD423610GY	EN4SD423610LG	42.00	36.00	10.00	14	1	3-point	EP4236	40.20	34.20	4	12.00	117	
EN4SD482410GY	EN4SD482410LG	48.00	24.00	10.00	14	1	3-point	EP4824	46.20	22.20	4	14.00	95	
EN4SD483010GY	EN4SD483010LG	48.00	30.00	10.00	14	1	3-point	EP4830	46.20	28.20	4	14.00	120	
EN4SD483610GY	EN4SD483610LG	48.00	36.00	10.00	14	1	3-point	EP4836	46.20	34.20	4	14.00	125	
EN4SD603610GY	EN4SD603610LG	60.00	36.00	10.00	14	1	3-point	EP6036	58.20	34.20	4	18.00	150	
EN4SD201612GY	EN4SD201612LG	20.00	16.00	12.00	16	1	Qtr Turn	EP2016	18.20	14.20	2	14.00	32	
EN4SD202012GY	EN4SD202012LG	20.00	20.00	12.00	16	1	Qtr Turn	EP2020	18.20	18.20	2	14.00	34	
EN4SD242012GY	EN4SD242012LG	24.00	20.00	12.00	16	1	Qtr Turn	EP2420	22.20	18.20	2	18.00	38	
EN4SD242412GY	EN4SD242412LG	24.00	24.00	12.00	14	2	Qtr Turn	EP2424	22.20	22.20	2	18.00	47	
EN4SD243012GY	EN4SD243012LG	24.00	30.00	12.00	14	2	Qtr Turn	EP2430	22.20	28.20	2	18.00	64	
EN4SD302412GY	EN4SD302412LG	30.00	24.00	12.00	14	2	Qtr Turn	EP3024	28.20	22.20	3	12.00	57	
EN4SD303012GY	EN4SD303012LG	30.00	30.00	12.00	14	2	Qtr Turn	EP3030	28.20	28.20	3	12.00	80	
EN4SD362412GY	EN4SD362412LG	36.00	24.00	12.00	14	2	Qtr Turn	EP3624	34.20	22.20	3	15.00	62	
EN4SD363012GY	EN4SD363012LG	36.00	30.00	12.00	14	2	Qtr Turn	EP3630	34.20	28.20	3	15.00	91	
EN4SD363612GY	EN4SD363612LG	36.00	36.00	12.00	14	2	Qtr Turn	EP3636	34.20	34.20	3	15.00	104	
EN4SD423012GY	EN4SD423012LG	42.00	30.00	12.00	14	1	3-point	EP4230	40.20	28.20	4	12.00	111	
EN4SD423612GY	EN4SD423612LG	42.00	36.00	12.00	14	1	3-point	EP4236	40.20	34.20	4	12.00	121	
EN4SD482412GY	EN4SD482412LG	48.00	24.00	12.00	14	1	3-point	EP4824	46.20	22.20	4	14.00	98	
EN4SD483612GY	EN4SD483612LG	48.00	36.00	12.00	14	1	3-point	EP4836	46.20	34.20	4	14.00	148	
EN4SD603612GY	EN4SD603612LG	60.00	36.00	12.00	14	1	3-point	EP6036	58.20	34.20	4	18.00	165	
EN4SD723012GY	EN4SD723012LG	72.00	30.00	12.00	14	2	Qtr Turn, 5-point	EP7230	70.20	28.20	5	16.50	190	
EN4SD723612GY	EN4SD723612LG	72.00	36.00	12.00	14	2	Qtr Turn, 5-point	EP7236	70.20	34.20	5	16.50	195	
EN4SD242016GY	EN4SD242016LG	24.00	20.00	16.00	16	1	Qtr Turn	EP2420	22.20	18.20	2	18.00	52	
EN4SD242416GY	EN4SD242416LG	24.00	24.00	16.00	14	2	Qtr Turn	EP2424	22.20	22.20	2	18.00	66	
EN4SD302416GY	EN4SD302416LG	30.00	24.00	16.00	14	2	Qtr Turn	EP3024	28.20	22.20	3	12.00	85	

Part No. (ANSI 61 Gray)	Part No. (RAL 7035 Light Gray)	Overall Dimensions			Door/Body Gauge	Latches		Opt. Panel Part No.	Panel Size		# Hinges	F	Ship Wt. (lbs)
		A	B	C		Qty	Type		D	E			
EN4SD362416GY	EN4SD362416LG	36.00	24.00	16.00	14	2	Qtr Turn	EP3624	34.20	22.20	3	15.00	84
EN4SD363016GY	EN4SD363016LG	36.00	30.00	16.00	14	2	Qtr Turn	EP3630	34.20	28.20	3	15.00	102
EN4SD363616GY	EN4SD363616LG	36.00	36.00	16.00	14	2	Qtr Turn	EP3636	34.20	34.20	3	15.00	113
EN4SD423016GY	EN4SD423016LG	42.00	30.00	16.00	14	1	3-point	EP4230	40.20	28.20	4	12.00	117
EN4SD423616GY	EN4SD423616LG	42.00	36.00	16.00	14	1	3-point	EP4236	40.20	34.20	4	12.00	140
EN4SD483016GY	EN4SD483016LG	48.00	30.00	16.00	14	1	3-point	EP4830	46.20	28.20	4	14.00	130
EN4SD483616GY	EN4SD483616LG	48.00	36.00	16.00	14	1	3-point	EP4836	46.20	34.20	4	14.00	148
EN4SD603616GY	EN4SD603616LG	60.00	36.00	16.00	14	1	3-point	EP6036	58.20	34.20	4	18.00	200
EN4SD723016GY	EN4SD723016LG	72.00	30.00	16.00	14	2	Qtr Turn, 5-point	EP7230	70.20	28.20	5	16.50	215
EN4SD723616GY	EN4SD723616LG	72.00	36.00	16.00	14	2	Qtr Turn, 5-point	EP7236	70.20	34.20	5	16.50	217
EN4SD242420GY	EN4SD242420LG	24.00	24.00	20.00	14	2	Qtr Turn	EP2424	22.20	22.20	2	18.00	70
EN4SD302420GY	EN4SD302420LG	30.00	24.00	20.00	14	2	Qtr Turn	EP3024	28.20	22.20	3	12.00	82
EN4SD363020GY	EN4SD363020LG	36.00	30.00	20.00	14	2	Qtr Turn	EP3630	34.20	28.20	3	15.00	117
EN4SD483620GY	EN4SD483620LG	48.00	36.00	20.00	14	1	3-point	EP4836	46.20	34.20	4	14.00	165
EN4SD603620GY	EN4SD603620LG	60.00	36.00	20.00	14	1	3-point	EP6036	58.20	34.20	4	18.00	210
EN4SD723020GY	EN4SD723020LG	72.00	30.00	20.00	14	2	Qtr Turn, 5-point	EP7230	70.20	28.20	5	16.50	217
EN4SD302424GY	EN4SD302424LG	30.00	24.00	24.00	14	2	Qtr Turn	EP3024	28.20	22.20	3	12.00	115
EN4SD723024GY	EN4SD723024LG	72.00	30.00	24.00	14	2	Qtr Turn, 5-point	EP7230	70.20	28.20	5	16.50	220

Data subject to change without notice

Type 4 Mild Steel Wallmount Enclosure *Eclipse Series*

Hinge Door with Quarter Turn/Handle



Application

- Designed to enclose electrical and/or electronic equipment and protect against harsh, industrial environments for wallmount applications.
- Impressive styling features like hidden hinges, attractive latching systems make the Eclipse a suitable addition to any high-tech equipment installation.
- A wide range of sizes and practical accessories make this product line a complete package.

Standards

- UL 508 Type 3R, 4, and 12
- CSA Type 3R, 4, and 12
- Complies with
 - NEMA Type 3R, 4, and 12
 - IEC 60529, IP66

Construction

- Formed 14 or 16 gauge steel.
- Smooth, continuously welded seams ground smooth.
- Door stiffeners are provided where required for increased strength and rigidity - designed to also permit additional mounting options.
- Formed lip on enclosure to exclude flowing liquids and contaminants.
- Door latches feature the added safety of quarter turn slot requiring use of tool for opening.
- Doors may be easily removed for modifications and are interchangeable.
- Seamless poured-in place gasket.
- Collar studs provided for mounting inner panel.
- Includes hardware kit with panel mounting nuts and sealing washers for wall mounting holes.
- Bonding stud provided on door and grounding stud installed in enclosure.
- Hinges are constructed from 304 stainless steel.
- Hinge pins are stainless steel.
- Quarter turn latch and multi-point handle (key lockable) are zinc diecast with black epoxy finish.
- Door alignment guide provided on 36" wide enclosures.

Finish

- Cover and enclosure are phosphatized and finished with a recoatable powder inside and out with choice of ANSI 61 smooth Gray (GY) or RAL7035 textured light gray (LG).

Accessories

- Cooling Products
- Ventilation
- DIN Rail Mounting Kit
- Door Stop Kit
- Gland Plates
- Inner Panels
- Quarter Turn Inserts and Keys
- Mounting Foot Kit
- Swing Frame
- Rear Hole Plugs
- Quarter Turn Assemblies
- Touch-Up Spray Paint
- Padlock Adaptor
- Blowers and Fans
- DIN Rails
- Drip Shield Kit
- Filtered Fans
- Heaters
- Handles
- Literature Pocket
- Swing Panel
- Eclipse Rack Panel
- Replacement Hinge Pins
- Temperature Controls
- Type 4 Hardware Kits
- Ground Wire Kits

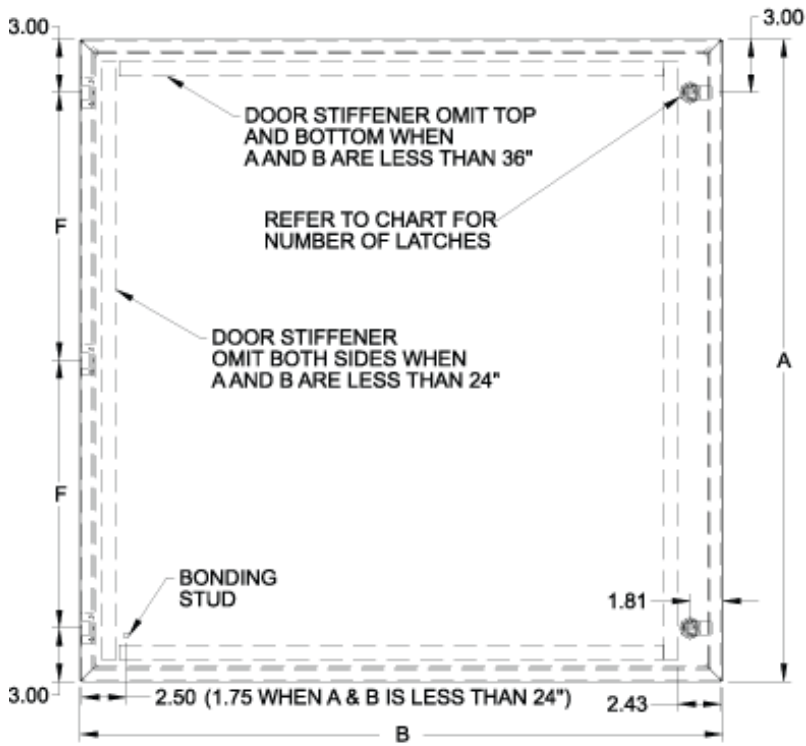

Front View

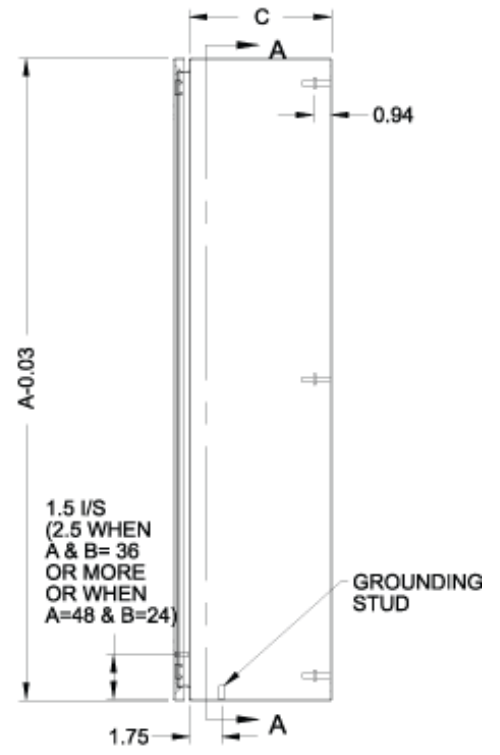

Side View

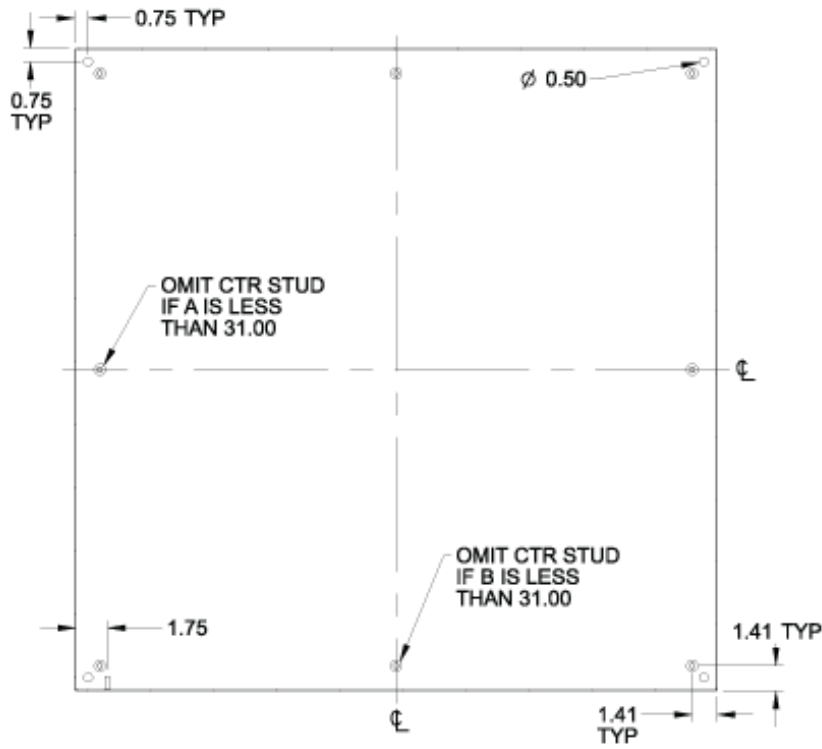

SECTION A-A

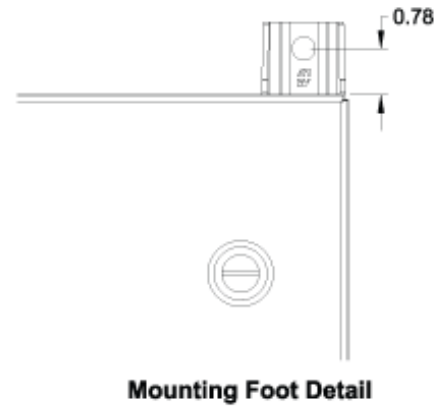

Part No. (ANSI 61 Gray)	Part No. (RAL 7035 Light Gray)	Overall Dimensions			Door/Body Gauge	Latches Qty	Latches Type	Opt. Panel Part No.	Panel Size			# Hinges	Ship Wt. (lbs)
		A	B	C					D	E	F		
EN4SD12106GY	EN4SD12106LG	12.00	10.00	6.00	16	1	Qtr Turn	EP1210	10.20	8.20	2	6.00	11
EN4SD12126GY	EN4SD12126LG	12.00	12.00	6.00	16	1	Qtr Turn	EP1212	10.20	10.20	2	6.00	12
EN4SD12246GY	EN4SD12246LG	12.00	24.00	6.00	16	1	Qtr Turn	EP1224	10.20	22.20	2	18.00	24
EN4SD16126GY	EN4SD16126LG	16.00	12.00	6.00	16	1	Qtr Turn	EP1612	14.20	10.20	2	10.00	16
EN4SD16166GY	EN4SD16166LG	16.00	16.00	6.00	16	1	Qtr Turn	EP1616	14.20	14.20	2	10.00	19
EN4SD16206GY	EN4SD16206LG	16.00	20.00	6.00	16	1	Qtr Turn	EP1620	14.20	18.20	2	10.00	22

Part No. (ANSI 61 Gray)	Part No. (RAL 7035 Light Gray)	Overall Dimensions			Door/Body Gauge	Latches Qty	Latches Type	Opt. Panel Part No.	Panel Size		# Hinges	F	Ship Wt. (lbs)
		A	B	C					D	E			
EN4SD20126GY	EN4SD20126LG	20.00	12.00	6.00	16	1	Qtr Turn	EP2012	18.20	10.20	2	14.00	20
EN4SD20166GY	EN4SD20166LG	20.00	16.00	6.00	16	1	Qtr Turn	EP2016	18.20	14.20	2	14.00	22
EN4SD20206GY	EN4SD20206LG	20.00	20.00	6.00	16	1	Qtr Turn	EP2020	18.20	18.20	2	14.00	26
EN4SD20246GY	EN4SD20246LG	20.00	24.00	6.00	16	1	Qtr Turn	EP2024	22.20	10.20	2	14.00	32
EN4SD24126GY	EN4SD24126LG	24.00	12.00	6.00	16	1	Qtr Turn	EP2412	22.20	10.20	2	18.00	24
EN4SD24166GY	EN4SD24166LG	24.00	16.00	6.00	16	1	Qtr Turn	EP2416	22.20	14.20	2	18.00	26
EN4SD24206GY	EN4SD24206LG	24.00	20.00	6.00	16	1	Qtr Turn	EP2420	22.20	18.20	2	18.00	30
EN4SD24246GY	EN4SD24246LG	24.00	24.00	6.00	14	2	Qtr Turn	EP2424	22.20	22.20	2	18.00	37
EN4SD30166GY	EN4SD30166LG	30.00	16.00	6.00	14	2	Qtr Turn	EP3016	28.20	14.20	3	12.00	35
EN4SD30206GY	EN4SD30206LG	30.00	20.00	6.00	14	2	Qtr Turn	EP3020	28.20	18.20	3	12.00	38
EN4SD30246GY	EN4SD30246LG	30.00	24.00	6.00	14	2	Qtr Turn	EP3024	28.20	22.20	3	12.00	40
EN4SD36246GY	EN4SD36246LG	36.00	24.00	6.00	14	2	Qtr Turn	EP3624	34.20	22.20	3	15.00	52
EN4SD36306GY	EN4SD36306LG	36.00	30.00	6.00	14	2	Qtr Turn	EP3630	34.20	28.20	3	15.00	60
EN4SD12248GY	EN4SD12248LG	12.00	24.00	8.00	16	1	Qtr Turn	EP1224	10.20	22.20	2	6.00	25
EN4SD16128GY	EN4SD16128LG	16.00	12.00	8.00	16	1	Qtr Turn	EP1612	14.20	10.20	2	10.00	16
EN4SD16168GY	EN4SD16168LG	16.00	16.00	8.00	16	1	Qtr Turn	EP1616	14.20	14.20	2	10.00	21
EN4SD16208GY	EN4SD16208LG	16.00	20.00	8.00	16	1	Qtr Turn	EP1620	14.20	18.20	2	10.00	25
EN4SD20128GY	EN4SD20128LG	20.00	12.00	8.00	16	1	Qtr Turn	EP2012	18.20	10.20	2	14.00	22
EN4SD20168GY	EN4SD20168LG	20.00	16.00	8.00	16	1	Qtr Turn	EP2016	18.20	14.20	2	14.00	25
EN4SD20208GY	EN4SD20208LG	20.00	20.00	8.00	16	1	Qtr Turn	EP2020	18.20	18.20	2	14.00	28
EN4SD20248GY	EN4SD20248LG	20.00	24.00	8.00	16	1	Qtr Turn	EP2024	18.20	22.20	2	14.00	32
EN4SD24128GY	EN4SD24128LG	24.00	12.00	8.00	16	1	Qtr Turn	EP2412	22.20	10.20	2	18.00	25
EN4SD24168GY	EN4SD24168LG	24.00	16.00	8.00	16	1	Qtr Turn	EP2416	22.20	14.20	2	18.00	26
EN4SD24208GY	EN4SD24208LG	24.00	20.00	8.00	16	1	Qtr Turn	EP2420	22.20	18.20	2	18.00	32
EN4SD24248GY	EN4SD24248LG	24.00	24.00	8.00	14	2	Qtr Turn	EP2424	22.20	22.20	2	18.00	40
EN4SD24308GY	EN4SD24308LG	24.00	30.00	8.00	14	2	Qtr Turn	EP2430	22.20	28.20	2	18.00	48
EN4SD30128GY	EN4SD30128LG	30.00	12.00	8.00	14	2	Qtr Turn	EP3012	28.20	10.20	3	12.00	34
EN4SD30168GY	EN4SD30168LG	30.00	16.00	8.00	14	2	Qtr Turn	EP3016	28.20	14.20	3	12.00	40
EN4SD30208GY	EN4SD30208LG	30.00	20.00	8.00	14	2	Qtr Turn	EP3020	28.20	18.20	3	12.00	42
EN4SD30248GY	EN4SD30248LG	30.00	24.00	8.00	14	2	Qtr Turn	EP3024	28.20	22.20	3	12.00	46
EN4SD30308GY	EN4SD30308LG	30.00	30.00	8.00	14	2	Qtr Turn	EP3030	28.20	28.20	3	12.00	67
EN4SD30368GY	EN4SD30368LG	30.00	36.00	8.00	14	2	Qtr Turn	EP3036	28.20	34.20	3	12.00	77
EN4SD36248GY	EN4SD36248LG	36.00	24.00	8.00	14	2	Qtr Turn	EP3624	34.20	22.20	3	15.00	55
EN4SD36308GY	EN4SD36308LG	36.00	30.00	8.00	14	2	Qtr Turn	EP3630	34.20	28.20	3	15.00	77
EN4SD36368GY	EN4SD36368LG	36.00	36.00	8.00	14	2	Qtr Turn	EP3636	34.20	34.20	3	15.00	94
EN4SD42248GY	EN4SD42248LG	42.00	24.00	8.00	14	1	3-point	EP4224	40.20	22.20	4	12.00	80
EN4SD42308GY	EN4SD42308LG	42.00	30.00	8.00	14	1	3-point	EP4230	40.20	28.20	4	12.00	95
EN4SD42368GY	EN4SD42368LG	42.00	36.00	8.00	14	1	3-point	EP4236	40.20	34.20	4	12.00	105
EN4SD48248GY	EN4SD48248LG	48.00	24.00	8.00	14	1	3-point	EP4824	46.20	22.20	4	14.00	110
EN4SD48308GY	EN4SD48308LG	48.00	30.00	8.00	14	1	3-point	EP4830	46.20	28.20	4	14.00	115
EN4SD48368GY	EN4SD48368LG	48.00	36.00	8.00	14	1	3-point	EP4836	46.20	34.20	4	14.00	120
EN4SD60368GY	EN4SD60368LG	60.00	36.00	8.00	14	1	3-point	EP6036	58.20	34.20	4	18.00	150
EN4SD161210GY	EN4SD161210LG	16.00	12.00	10.00	16	1	Qtr. Turn	EP1612	14.20	10.20	2	10.00	18
EN4SD161610GY	EN4SD161610LG	16.00	16.00	10.00	16	1	Qtr. Turn	EP1616	14.20	14.20	2	10.00	23
EN4SD162010GY	EN4SD162010LG	16.00	20.00	10.00	16	1	Qtr. Turn	EP1620	14.20	18.20	2	10.00	28
EN4SD201610GY	EN4SD201610LG	20.00	16.00	10.00	16	1	Qtr. Turn	EP2016	18.20	14.20	2	14.00	28
EN4SD202010GY	EN4SD202010LG	20.00	20.00	10.00	16	1	Qtr. Turn	EP2020	18.20	18.20	2	14.00	31

Part No. (ANSI 61 Gray)	Part No. (RAL 7035 Light Gray)	Overall Dimensions			Door/Body Gauge	Latches Qty	Latches Type	Opt. Panel Part No.	Panel Size			# Hinges	F	Ship Wt. (lbs)
		A	B	C					D	E	F			
EN4SD202410GY	EN4SD202410LG	20.00	24.00	10.00	16	1	Qtr. Turn	EP2024	18.20	22.20	2	14.00	36	
EN4SD241210GY	EN4SD241210LG	24.00	12.00	10.00	16	1	Qtr Turn	EP2412	22.20	10.20	2	18.00	26	
EN4SD241610GY	EN4SD241610LG	24.00	16.00	10.00	16	1	Qtr. Turn	EP2416	22.20	14.20	2	18.00	30	
EN4SD242010GY	EN4SD242010LG	24.00	20.00	10.00	16	1	Qtr. Turn	EP2420	22.20	18.20	2	18.00	36	
EN4SD242410GY	EN4SD242410LG	24.00	24.00	10.00	14	2	Qtr. Turn	EP2424	22.20	22.20	2	18.00	45	
EN4SD243010GY	EN4SD243010LG	24.00	30.00	10.00	14	2	Qtr. Turn	EP2430	22.20	28.20	2	18.00	53	
EN4SD302010GY	EN4SD302010LG	30.00	20.00	10.00	14	2	Qtr. Turn	EP3020	28.20	18.20	3	12.00	47	
EN4SD302410GY	EN4SD302410LG	30.00	24.00	10.00	14	2	Qtr. Turn	EP3024	28.20	22.20	3	12.00	53	
EN4SD303010GY	EN4SD303010LG	30.00	30.00	10.00	14	2	Qtr. Turn	EP3030	28.20	28.20	3	12.00	75	
EN4SD362410GY	EN4SD362410LG	36.00	24.00	10.00	14	2	Qtr. Turn	EP3624	34.20	22.20	3	15.00	70	
EN4SD363010GY	EN4SD363010LG	36.00	30.00	10.00	14	2	Qtr. Turn	EP3630	34.20	28.20	3	15.00	84	
EN4SD363610GY	EN4SD363610LG	36.00	36.00	10.00	14	2	Qtr. Turn	EP3636	34.20	34.20	3	15.00	100	
EN4SD422410GY	EN4SD422410LG	42.00	24.00	10.00	14	1	3-point	EP4224	40.20	22.20	4	12.00	86	
EN4SD423010GY	EN4SD423010LG	42.00	30.00	10.00	14	1	3-point	EP4230	40.20	28.20	4	12.00	107	
EN4SD423610GY	EN4SD423610LG	42.00	36.00	10.00	14	1	3-point	EP4236	40.20	34.20	4	12.00	117	
EN4SD482410GY	EN4SD482410LG	48.00	24.00	10.00	14	1	3-point	EP4824	46.20	22.20	4	14.00	95	
EN4SD483010GY	EN4SD483010LG	48.00	30.00	10.00	14	1	3-point	EP4830	46.20	28.20	4	14.00	120	
EN4SD483610GY	EN4SD483610LG	48.00	36.00	10.00	14	1	3-point	EP4836	46.20	34.20	4	14.00	125	
EN4SD603610GY	EN4SD603610LG	60.00	36.00	10.00	14	1	3-point	EP6036	58.20	34.20	4	18.00	150	
EN4SD201612GY	EN4SD201612LG	20.00	16.00	12.00	16	1	Qtr Turn	EP2016	18.20	14.20	2	14.00	32	
EN4SD202012GY	EN4SD202012LG	20.00	20.00	12.00	16	1	Qtr Turn	EP2020	18.20	18.20	2	14.00	34	
EN4SD242012GY	EN4SD242012LG	24.00	20.00	12.00	16	1	Qtr Turn	EP2420	22.20	18.20	2	18.00	38	
EN4SD242412GY	EN4SD242412LG	24.00	24.00	12.00	14	2	Qtr Turn	EP2424	22.20	22.20	2	18.00	47	
EN4SD243012GY	EN4SD243012LG	24.00	30.00	12.00	14	2	Qtr Turn	EP2430	22.20	28.20	2	18.00	64	
EN4SD302412GY	EN4SD302412LG	30.00	24.00	12.00	14	2	Qtr Turn	EP3024	28.20	22.20	3	12.00	57	
EN4SD303012GY	EN4SD303012LG	30.00	30.00	12.00	14	2	Qtr Turn	EP3030	28.20	28.20	3	12.00	80	
EN4SD362412GY	EN4SD362412LG	36.00	24.00	12.00	14	2	Qtr Turn	EP3624	34.20	22.20	3	15.00	62	
EN4SD363012GY	EN4SD363012LG	36.00	30.00	12.00	14	2	Qtr Turn	EP3630	34.20	28.20	3	15.00	91	
EN4SD363612GY	EN4SD363612LG	36.00	36.00	12.00	14	2	Qtr Turn	EP3636	34.20	34.20	3	15.00	104	
EN4SD423012GY	EN4SD423012LG	42.00	30.00	12.00	14	1	3-point	EP4230	40.20	28.20	4	12.00	111	
EN4SD423612GY	EN4SD423612LG	42.00	36.00	12.00	14	1	3-point	EP4236	40.20	34.20	4	12.00	121	
EN4SD482412GY	EN4SD482412LG	48.00	24.00	12.00	14	1	3-point	EP4824	46.20	22.20	4	14.00	98	
EN4SD483612GY	EN4SD483612LG	48.00	36.00	12.00	14	1	3-point	EP4836	46.20	34.20	4	14.00	148	
EN4SD603612GY	EN4SD603612LG	60.00	36.00	12.00	14	1	3-point	EP6036	58.20	34.20	4	18.00	165	
EN4SD723012GY	EN4SD723012LG	72.00	30.00	12.00	14	2	Qtr Turn, 5-point	EP7230	70.20	28.20	5	16.50	190	
EN4SD723612GY	EN4SD723612LG	72.00	36.00	12.00	14	2	Qtr Turn, 5-point	EP7236	70.20	34.20	5	16.50	195	
EN4SD242016GY	EN4SD242016LG	24.00	20.00	16.00	16	1	Qtr Turn	EP2420	22.20	18.20	2	18.00	52	
EN4SD242416GY	EN4SD242416LG	24.00	24.00	16.00	14	2	Qtr Turn	EP2424	22.20	22.20	2	18.00	66	
EN4SD302416GY	EN4SD302416LG	30.00	24.00	16.00	14	2	Qtr Turn	EP3024	28.20	22.20	3	12.00	85	

Part No. (ANSI 61 Gray)	Part No. (RAL 7035 Light Gray)	Overall Dimensions			Door/Body Gauge	Latches		Opt. Panel Part No.	Panel Size		# Hinges	F	Ship Wt. (lbs)
		A	B	C		Qty	Type		D	E			
EN4SD362416GY	EN4SD362416LG	36.00	24.00	16.00	14	2	Qtr Turn	EP3624	34.20	22.20	3	15.00	84
EN4SD363016GY	EN4SD363016LG	36.00	30.00	16.00	14	2	Qtr Turn	EP3630	34.20	28.20	3	15.00	102
EN4SD363616GY	EN4SD363616LG	36.00	36.00	16.00	14	2	Qtr Turn	EP3636	34.20	34.20	3	15.00	113
EN4SD423016GY	EN4SD423016LG	42.00	30.00	16.00	14	1	3-point	EP4230	40.20	28.20	4	12.00	117
EN4SD423616GY	EN4SD423616LG	42.00	36.00	16.00	14	1	3-point	EP4236	40.20	34.20	4	12.00	140
EN4SD483016GY	EN4SD483016LG	48.00	30.00	16.00	14	1	3-point	EP4830	46.20	28.20	4	14.00	130
EN4SD483616GY	EN4SD483616LG	48.00	36.00	16.00	14	1	3-point	EP4836	46.20	34.20	4	14.00	148
EN4SD603616GY	EN4SD603616LG	60.00	36.00	16.00	14	1	3-point	EP6036	58.20	34.20	4	18.00	200
EN4SD723016GY	EN4SD723016LG	72.00	30.00	16.00	14	2	Qtr Turn, 5-point	EP7230	70.20	28.20	5	16.50	215
EN4SD723616GY	EN4SD723616LG	72.00	36.00	16.00	14	2	Qtr Turn, 5-point	EP7236	70.20	34.20	5	16.50	217
EN4SD242420GY	EN4SD242420LG	24.00	24.00	20.00	14	2	Qtr Turn	EP2424	22.20	22.20	2	18.00	70
EN4SD302420GY	EN4SD302420LG	30.00	24.00	20.00	14	2	Qtr Turn	EP3024	28.20	22.20	3	12.00	82
EN4SD363020GY	EN4SD363020LG	36.00	30.00	20.00	14	2	Qtr Turn	EP3630	34.20	28.20	3	15.00	117
EN4SD483620GY	EN4SD483620LG	48.00	36.00	20.00	14	1	3-point	EP4836	46.20	34.20	4	14.00	165
EN4SD603620GY	EN4SD603620LG	60.00	36.00	20.00	14	1	3-point	EP6036	58.20	34.20	4	18.00	210
EN4SD723020GY	EN4SD723020LG	72.00	30.00	20.00	14	2	Qtr Turn, 5-point	EP7230	70.20	28.20	5	16.50	217
EN4SD302424GY	EN4SD302424LG	30.00	24.00	24.00	14	2	Qtr Turn	EP3024	28.20	22.20	3	12.00	115
EN4SD723024GY	EN4SD723024LG	72.00	30.00	24.00	14	2	Qtr Turn, 5-point	EP7230	70.20	28.20	5	16.50	220

Data subject to change without notice