

IN BOX One-piece Box for Stucco

More on reverse!

Low Profile, Recessed Electrical Box with Weatherproof-in-use Cover



DBVM1W

IN BOX
One-piece
Recessed
Electrical Box
for Stucco.

Patents pending

Competitively priced!

DBVM1W

**Arlington's
One-Piece IN BOX™
Saves Time and Money –
Looks Great Too!**

Now, instead of installing an electrical box and a bubble cover assembly, you get it all in the one-piece IN BOX!

The job looks great because the extra-deep IN BOX installs in the wall – so less of it shows outside.

Designed for new stucco over masonry or wood construction, the recessed IN BOX is a one piece box with a weatherproof-in-use cover.

It accepts most single gang wiring devices, and uses a standard indoor wall plate.

- Non-metallic
- Standard duplex and GFCI wall plates, NM cable connector, and mud cover included
- Clear or white cover is removable for added convenience
- No gaskets required



Installation is fast and easy.
It's that simple!



**for Stucco over Masonry
or Wood Construction**

Catalog #	UPC/DCI/NAED Mfg. #01 8997	Cover Color	Unit/Std Pkg
DBVM1C	14315	Clear	4
DBVM1W	14316	White	4

Non-metallic, one-piece, recessed **IN BOX™**, with mud cover, for stucco construction – includes a plastic block bushing that encases and protects cable as it exits masonry block.

Catalog #	UPC/DCI/NAED Mfg. #01 8997	Unit Pkg	Std Pkg
FXC3	40190	25	25

Plastic Block Bushing
Encases and protects cable in masonry block construction. Not required for wood.

A  
Arlington

1 Stauffer Industrial Park
Scranton, PA 18517
800/233.4717
Fax 570/562.0646
www.aifittings.com

IN BOX One-piece Box for Stucco

NEW!

Low Profile, Recessed Electrical Box with Weatherproof-in-use Cover

Includes block bushing and mud cover (not shown)

Cover is removable for added convenience

Holes in flange allow for positive bonding of stucco to substrate

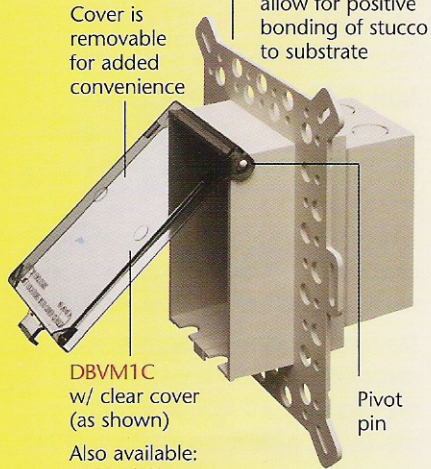

DBVM1C w/ clear cover (as shown)

Also available: DBVM1W w/ white textured, paintable cover

Meets 2005 NEC, Section 406-8
For the protection of exterior outlets which require the use of a weatherproof-in-use cover for all outdoor 15 or 20 amp receptacles.

FXC3 Block Bushing

The FXC3 plastic block bushing mounts to masonry block and protects cable as it passes through the block.

It comes with the IN BOX recessed electrical box for stucco. It's also sold separately. (Not required for wood construction).

Check out the IN BOX styles for existing construction and siding. Look for other models coming soon!

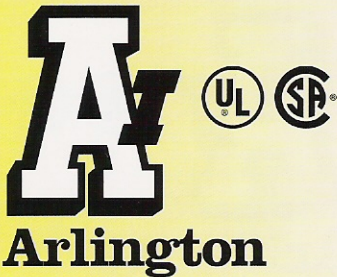

Arlington
1 Stauffer Industrial Park
Scranton, PA 18517
800/233.4717
Fax 570/562.0646
www.aifittings.com

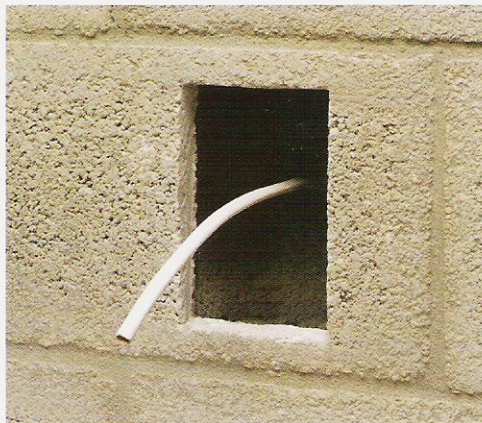

For masonry construction...
Make hole in block. Pull wiring through plastic block bushing and opening in block.

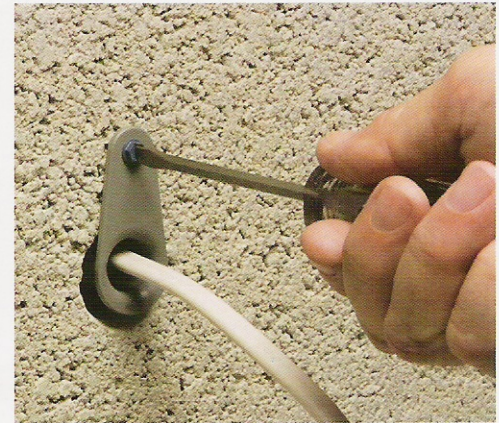

Block bushing mounts to block.

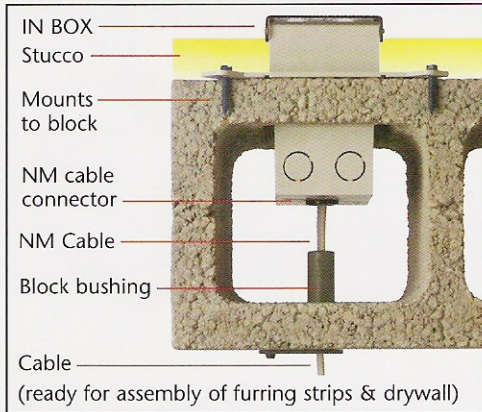

Cutaway showing IN BOX and plastic block bushing mounted in masonry block.

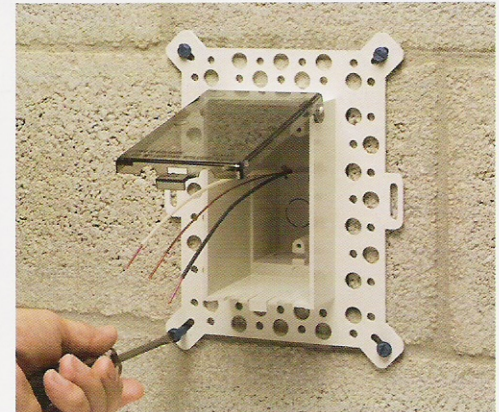

Attach Recessed IN BOX to masonry block. The holes in the flange are designed to allow stucco to bond to the substrate.



Install wiring device. IN BOX accepts most devices, and a standard indoor wall plate.



Mud Cover
Weatherproof-in-use Cover
Ships with (disposable) mud cover in place.



DBVM1C
Completed installation

Distributed by

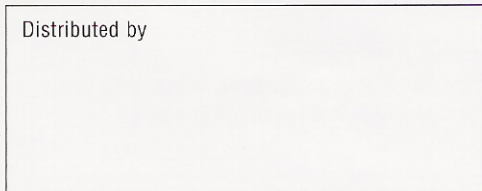

IN BOX One-piece Box for Stucco

More on reverse!

Low Profile, Recessed Electrical Box with Weatherproof-in-use Cover



DBVM1W

IN BOX
One-piece
Recessed
Electrical Box
for Stucco.

Patents pending

Competitively priced!

DBVM1W

Arlington's One-Piece IN BOX™ Saves Time and Money – Looks Great Too!

Now, instead of installing an electrical box and a bubble cover assembly, you get it all in the one-piece IN BOX!

The job looks great because the extra-deep IN BOX installs in the wall – so less of it shows outside.

Designed for new stucco over masonry or wood construction, the recessed IN BOX is a one piece box with a weatherproof-in-use cover.

It accepts most single gang wiring devices, and uses a standard indoor wall plate.

- Non-metallic
- Standard duplex and GFCI wall plates, NM cable connector, and mud cover included
- Clear or white cover is removable for added convenience
- No gaskets required



Installation is fast and easy. It's that simple!

for Stucco over Masonry or Wood Construction

Catalog #	UPC/DCI/NAED Mfg. #01 8997	Cover Color	Unit/Std Pkg
DBVM1C	14315	Clear	4
DBVM1W	14316	White	4

Non-metallic, one-piece, recessed **IN BOX™**, with mud cover, for stucco construction – includes a plastic block bushing that encases and protects cable as it exits masonry block.

Catalog #	UPC/DCI/NAED Mfg. #01 8997	Unit Pkg	Std Pkg
FXC3	40190	25	25

Plastic Block Bushing
Encases and protects cable in masonry block construction. Not required for wood.

Arlington 

1 Stauffer Industrial Park
Scranton, PA 18517
800/233.4717
Fax 570/562.0646
www.aifittings.com

IN BOX One-piece Box for Stucco

NEW!

Low Profile, Recessed Electrical Box with Weatherproof-in-use Cover

Includes block bushing and mud cover (not shown)

Cover is removable for added convenience

Holes in flange allow for positive bonding of stucco to substrate

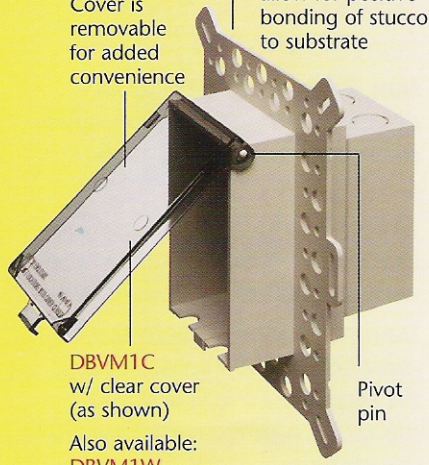

DBVM1C w/ clear cover (as shown)

Also available: DBVM1W w/ white textured, paintable cover

Meets 2005 NEC, Section 406-8
For the protection of exterior outlets which require the use of a weatherproof-in-use cover for all outdoor 15 or 20 amp receptacles.

FXC3 Block Bushing

The FXC3 plastic block bushing mounts to masonry block and protects cable as it passes through the block.

It comes with the IN BOX recessed electrical box for stucco. It's also sold separately. (Not required for wood construction).

Check out the IN BOX styles for existing construction and siding. Look for other models coming soon!

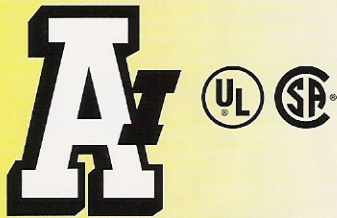

Arlington

1 Stauffer Industrial Park
Scranton, PA 18517

800/233.4717
Fax 570/562.0646
www.aifittings.com

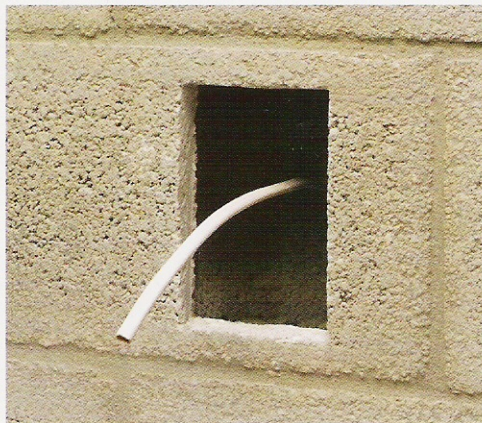

For masonry construction...
Make hole in block. Pull wiring through plastic block bushing and opening in block.

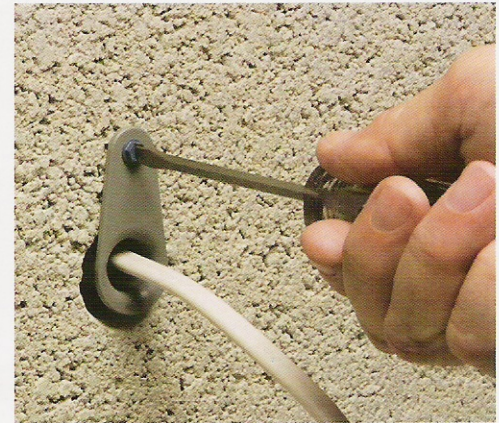

Block bushing mounts to block.

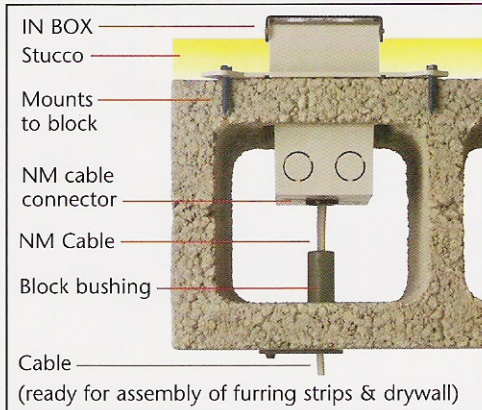

Cutaway showing IN BOX and plastic block bushing mounted in masonry block.

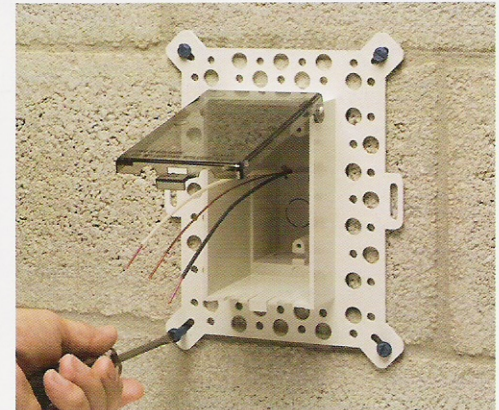

Attach Recessed IN BOX to masonry block. The holes in the flange are designed to allow stucco to bond to the substrate.

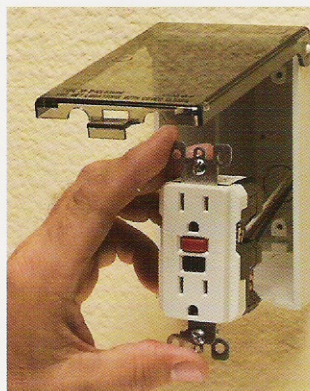

Install wiring device. IN BOX accepts most devices, and a standard indoor wall plate.



Mud Cover
Weatherproof-in-use Cover
Ships with (disposable) mud cover in place.



DBVM1C
Completed installation

Distributed by