

Twist-Lock® Devices  
 50A, 3 Phase 250V AC, 3 Pole, 4 Wire  
 Grounding  
 Insulgrip® Plug

# HUBBELL

## Features

- Super tough nylon housing offers better impact qualities
- Stainless steel shroud protects contacts and prevents mismatching
- Heavy duty two-piece external cord clamp provides maximum strain relief
- Box terminal with hex socket threaded slug, permits high clamping pressure on conductors without damaging strands
- Thermoplastic polyester interior provides heat resistance and impact strength

## Ordering Information

Description	Cord Diameter	UPC	Catalog Number
Nylon cover, thermoplastic polyester interior	.830"-1.250" (21.08-31.75)	783585829128	CS8365C

## Listings

Listed to UL 498  
 Certified to CSA C22.2 No.42

## Specifications

Housing	Nylon
Blade Holder	Polyester
Blades	Brass
Shell	Stainless Steel
Terminal Screws	Stainless steel
Cord Grip	Polyester

## Performance

Electrical	
Current Interrupting	Certified for current interrupting at full rated current
Dielectric Voltage	Withstands 2,000V minimum

Mechanical	
Terminal Accommodation	#10 AWG - #6 AWG stranded copper wire only

Environmental	
Flammability	HB or better
Operating Temperatures	Maximum continuous 75°C; minimum -40°C (w/o impact)

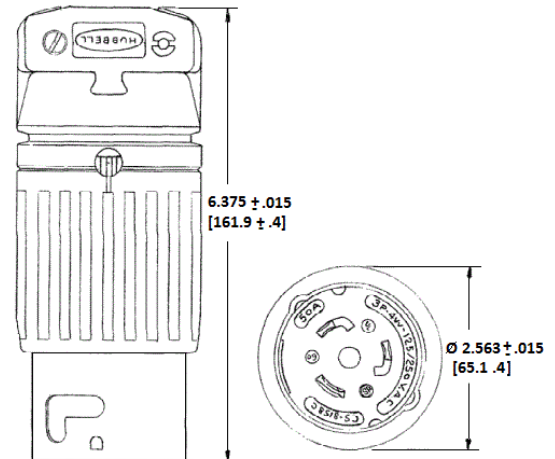

## Accessories

Connector	CS8364C
Single Receptacle	CS8369
Weatherproof Boot	HBL7716C

## Resources

Customer Use Drawing  
 eCatalog

Dimensions in Inches (mm)

Hubbell Wiring Device-Kellems • Hubbell Incorporated (Delaware) • 40 Waterview Drive • Shelton, CT 06484

Phone (800) 288-6000 • Fax (800) 255-1031 • Specifications subject to change without notice.

