

SCALE 1.000

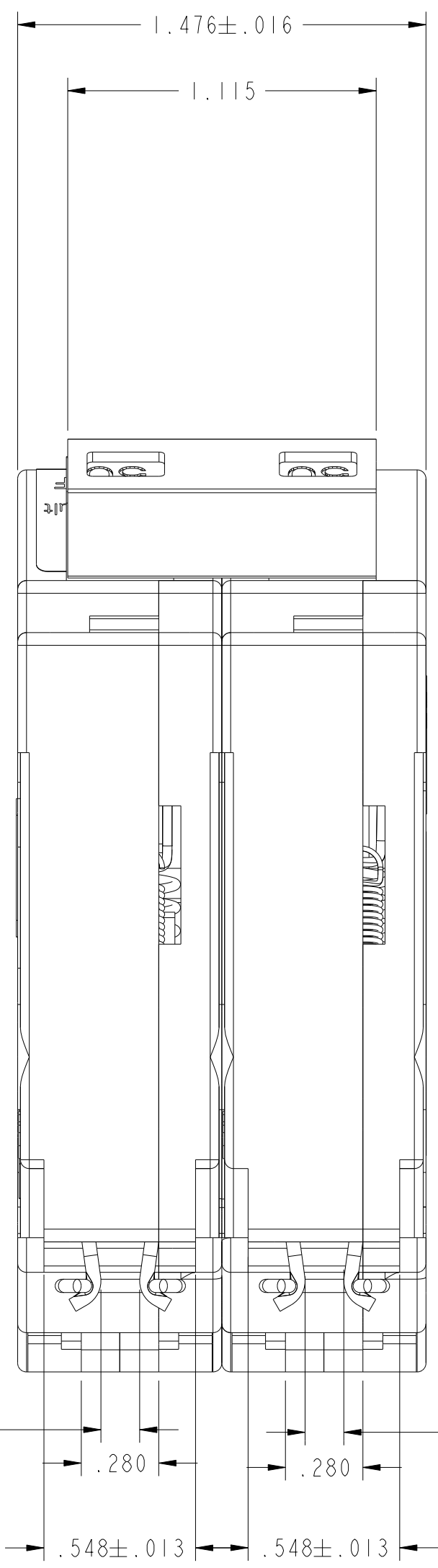

OPENING WILL ACCEPT A 3/16 DIA PIN

OPENING WILL ACCEPT A 3/16 DIA PIN

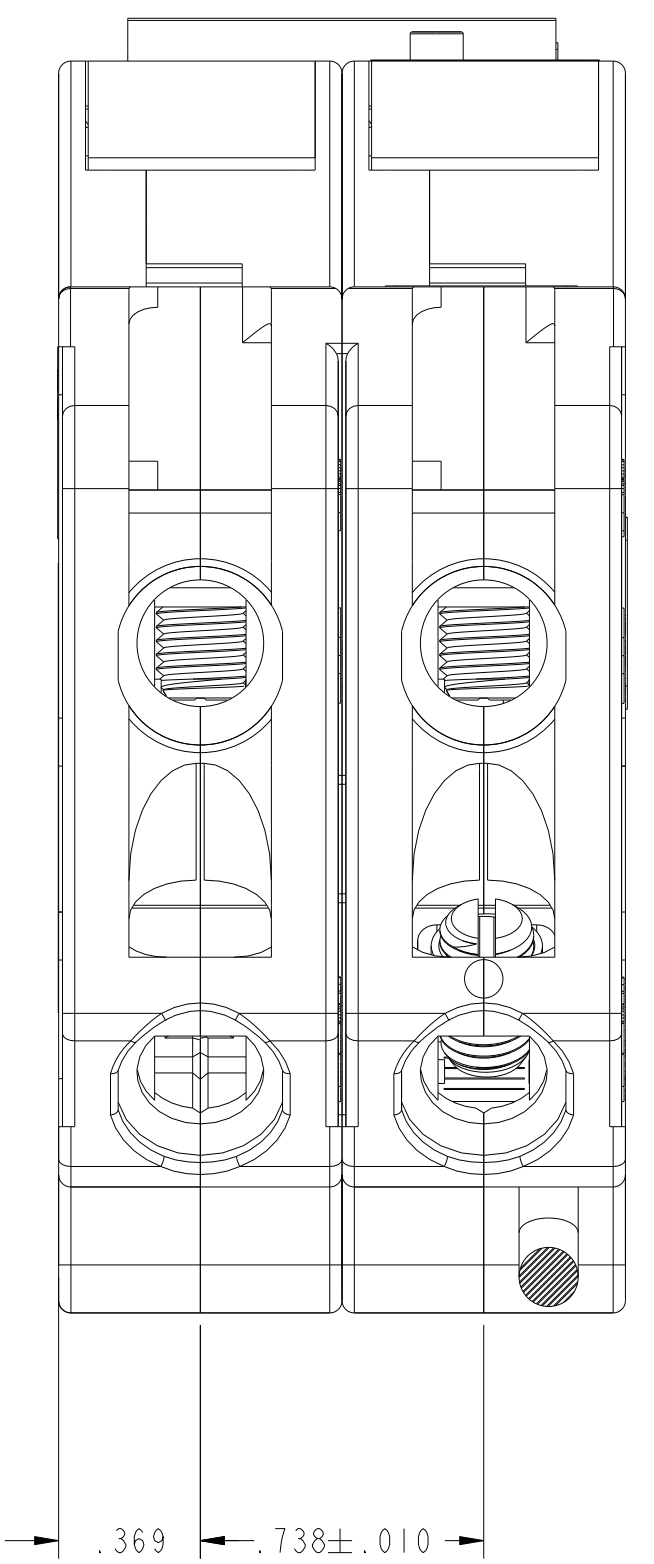
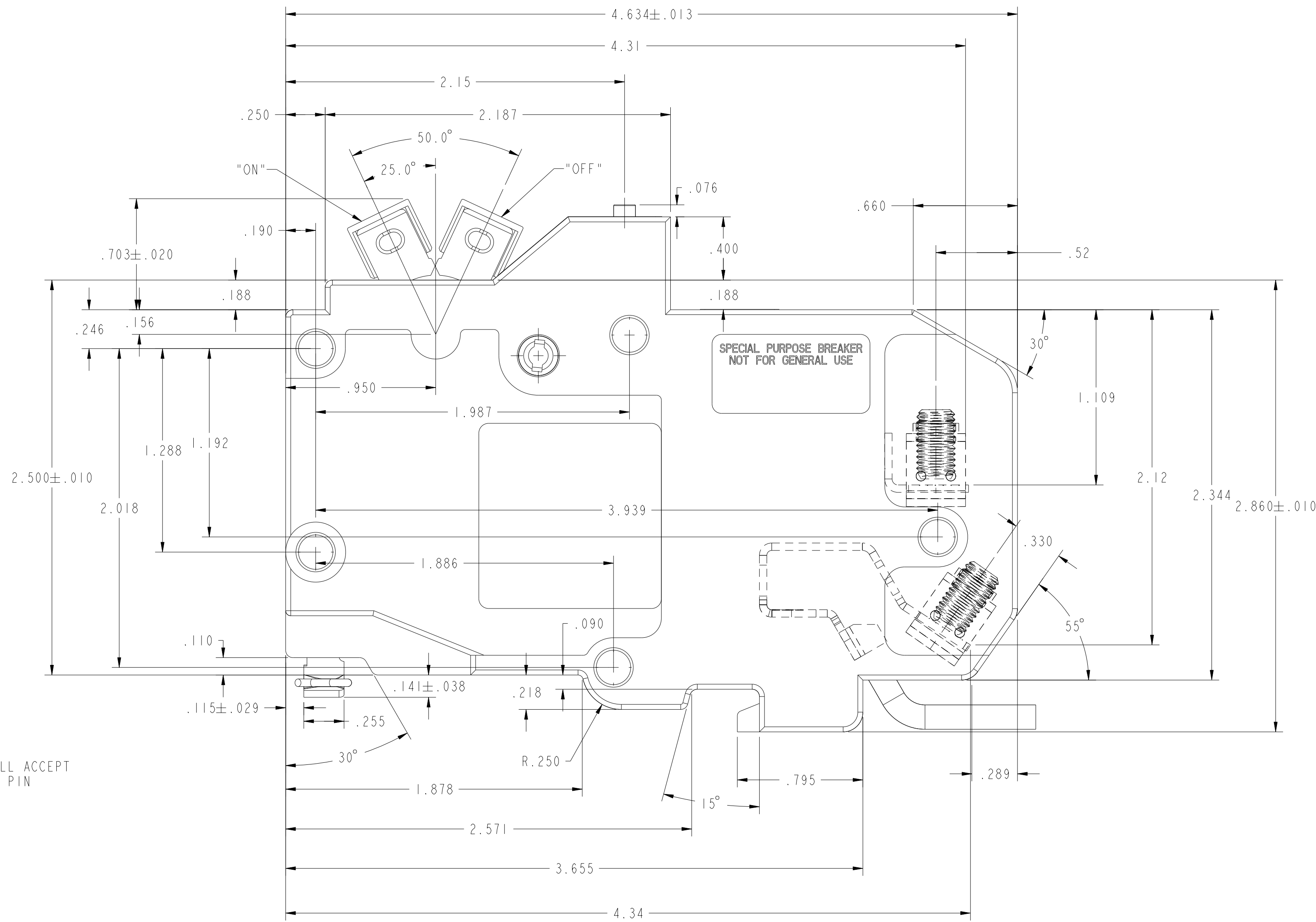

UNLESS OTHERWISE SPECIFIED DIMENSIONS IN INCHES X.X ±0.1 X.XX ±0.01 X.XXX ±0.001 X" ±0 X.X" ±0.5	DRAWER/DRAWING	DATE (YYYYMMDD)	EATON CORPORATION - CONFIDENTIAL AND PROPRIETARY NOTICE TO PERSONS RECEIVING THIS DOCUMENT AND/OR TECHNICAL INFORMATION	
	L. PORTUONDO	2015/07/02	THIS DOCUMENT, INCLUDING THE DRAWING AND INFORMATION CONTAINED THEREON, IS CONFIDENTIAL AND IS THE EXCLUSIVE PROPERTY OF EATON CORPORATION, AND IS LOANED TO YOU AND SUBJECT TO RECEIPT BY EATON AT ANY TIME. BY TAKING POSSESSION OF THIS DOCUMENT, THE RECIPIENT ACKNOWLEDGES AND AGREES THAT THIS DOCUMENT WILL BE COPIED OR OTHERWISE DISCLOSED WITHOUT THE PRIOR WRITTEN CONSENT OF EATON. IN THE CASE OF CONFLICTING CONTRACTUAL PROVISIONS, THIS NOTICE SHALL GOVERN THE STATUS OF THIS DOCUMENT. © 2015 Eaton Corporation. All Rights Reserved.	
DRAWING IN ACCORDANCE WITH ASME Y14.5M-1994	ENGINEERING APPROVED	MANUFACTURING	TITLE	
	G. DE JESUS	M. GONZALEZ	GROUND FAULT CIRCUIT INTERRUPTER	
	REVISION DESCRIPTION	ECO#	3/4" 2-POLE GFT	
		ECC-082761	15A - 60A OUTLINE DRAWING	
			SIZE	REVISION
			D	001
			CHANGE RESPONSIBILITY	
			RWDD_MCB_ENGINEERING	
			EATON	
			CLASS CODE	SCALE
			NA	2.000
				SHEET
				1 OF 1

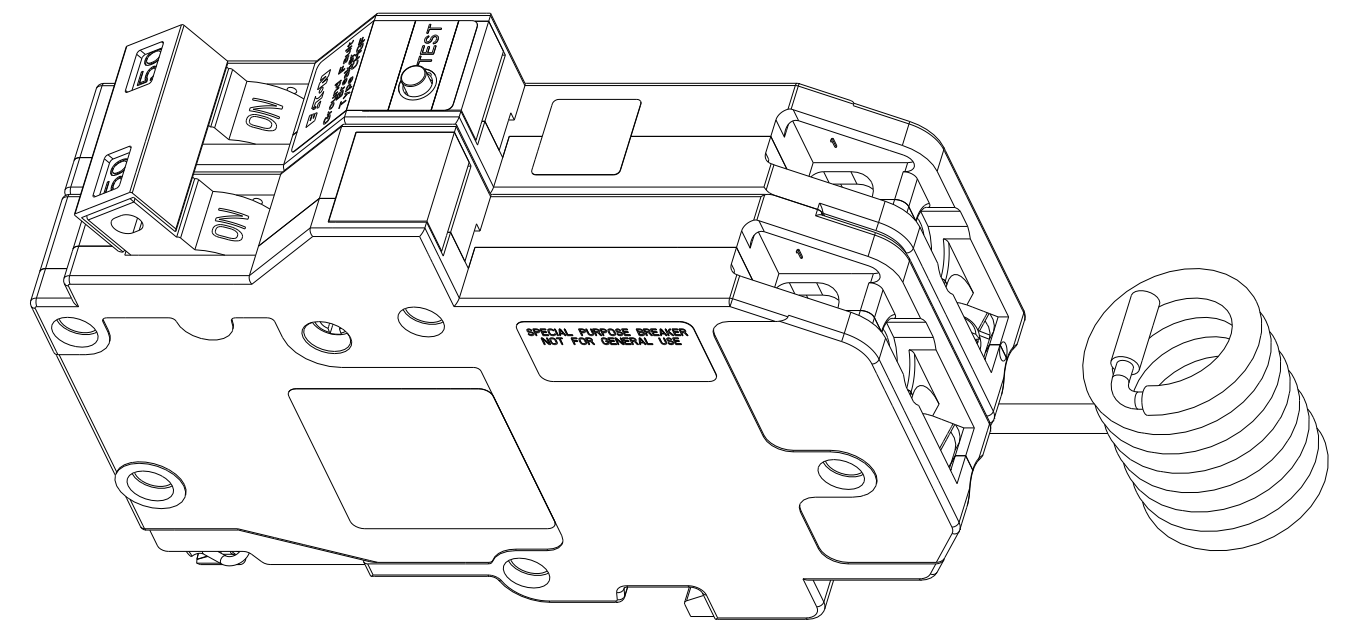
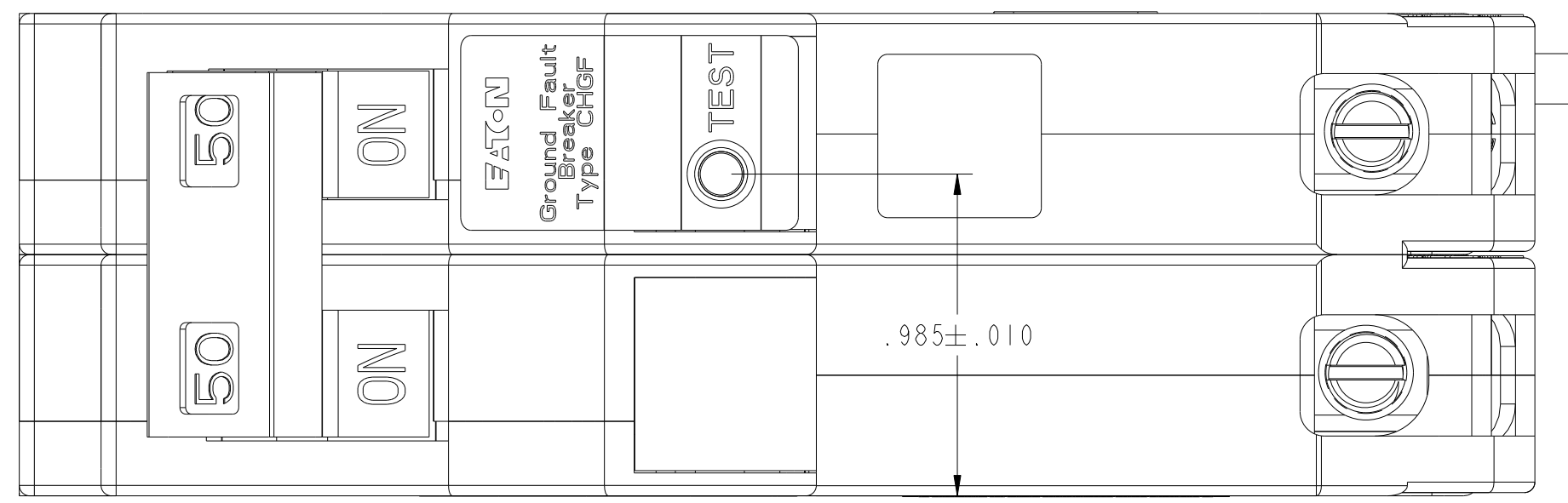

SCALE 1.000

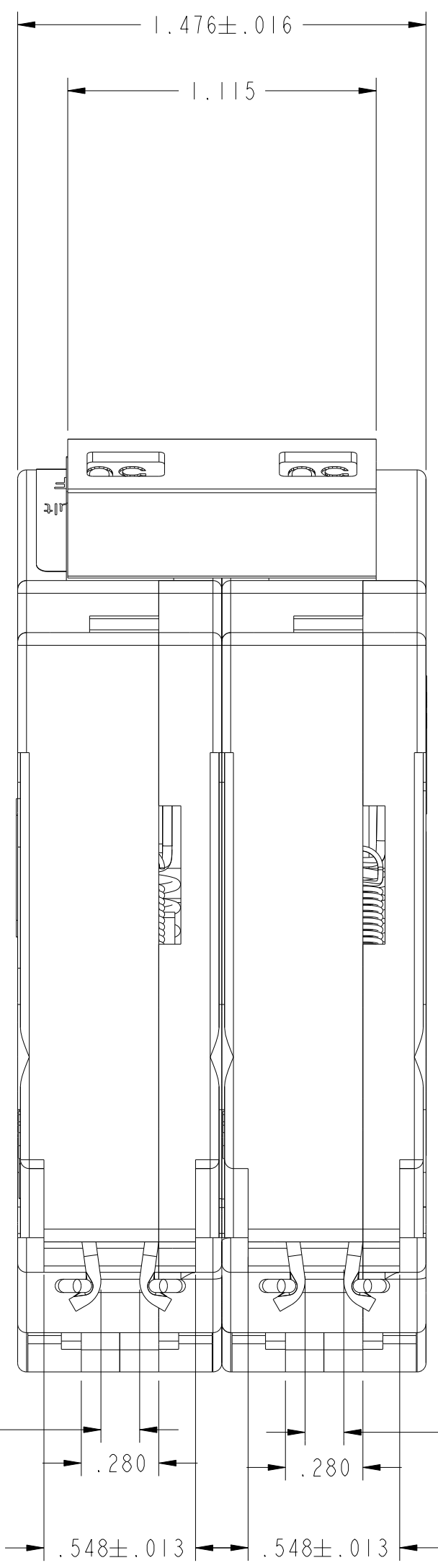

OPENING WILL ACCEPT A 3/16 DIA PIN

OPENING WILL ACCEPT A 3/16 DIA PIN

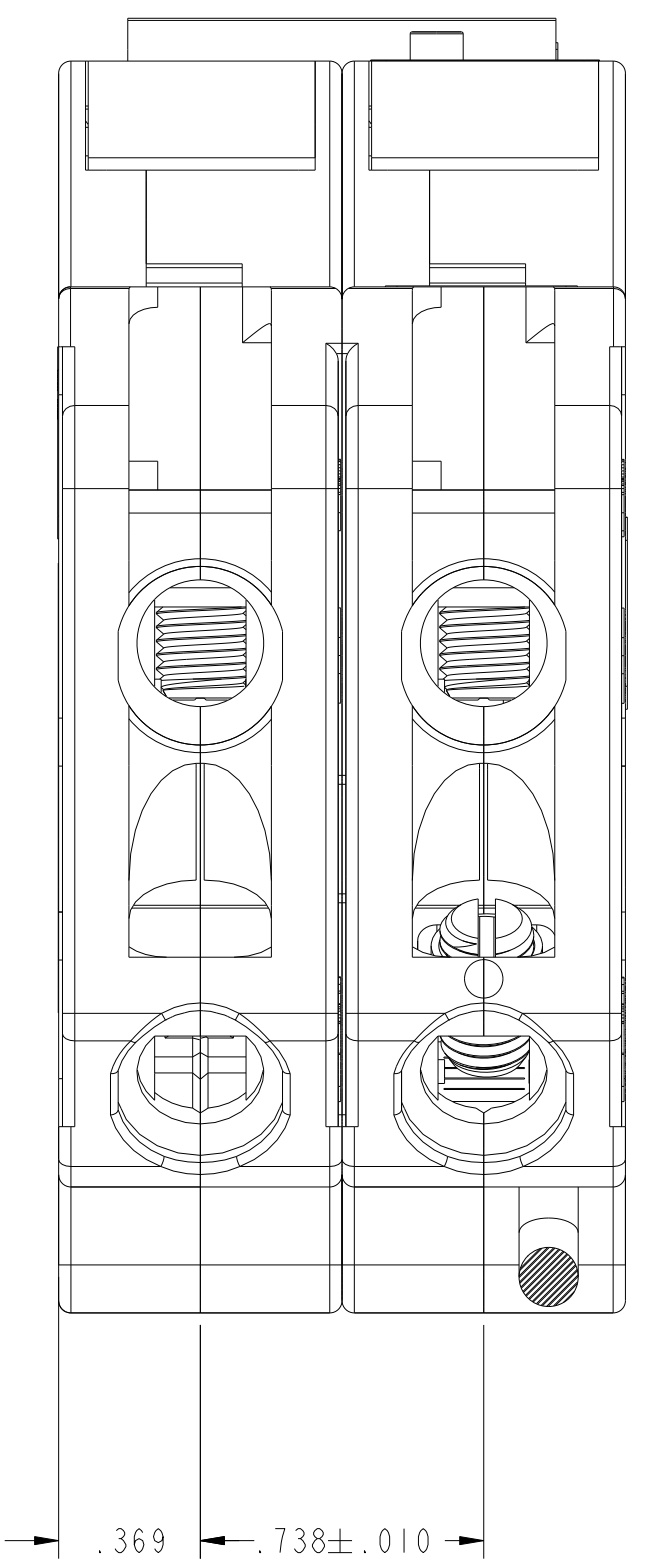
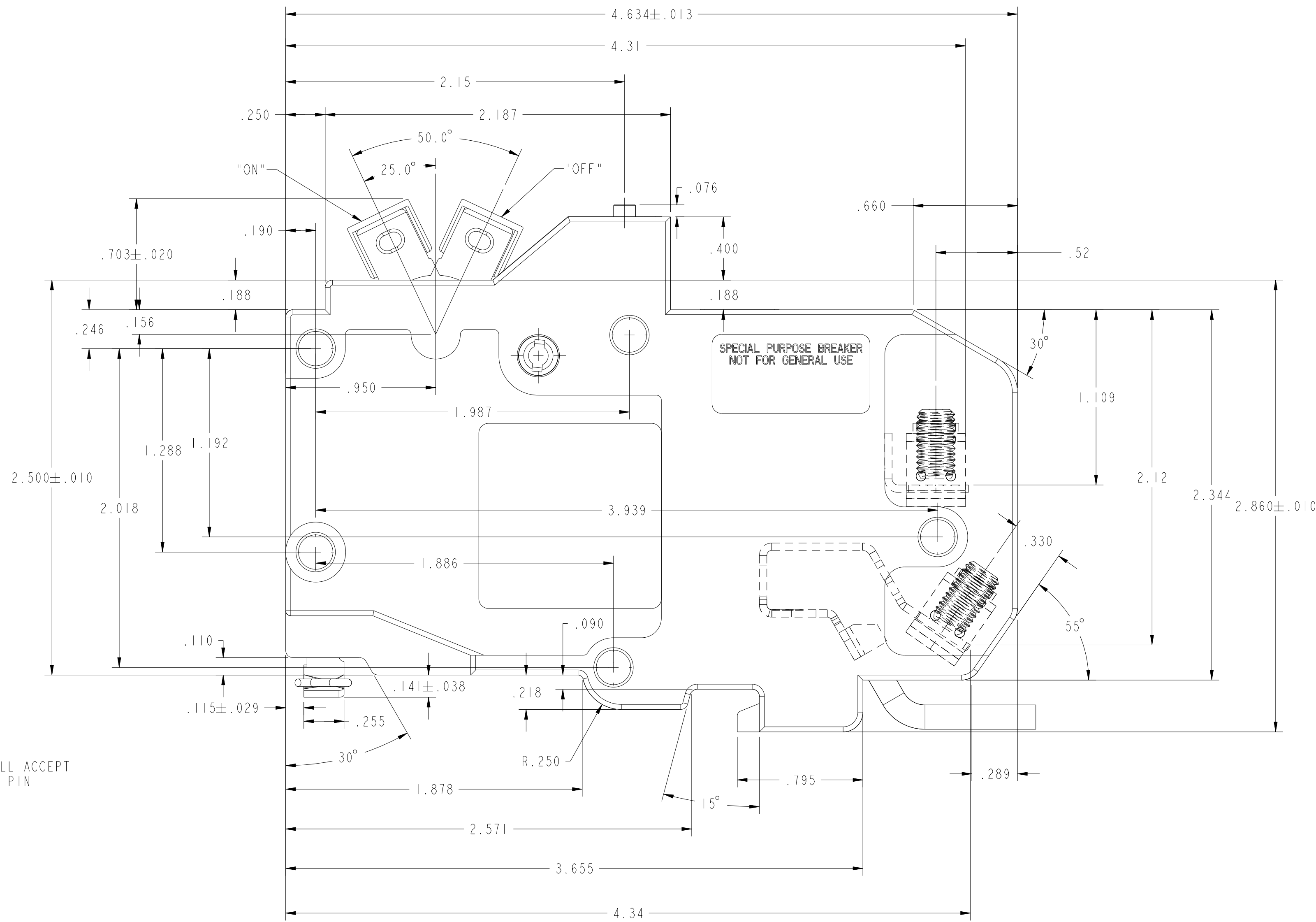

UNLESS OTHERWISE SPECIFIED DIMENSIONS IN INCHES X.X ±0.1 X.XX ±0.01 X.XXX ±0.001 " ±0 X.X" ±0.5	DRAWING IN ACCORDANCE WITH ASME Y14.5M-1994	ENGINEERING APPROVED G. DE JESUS	MANUFACTURING M. GONZALEZ	DATE (YYYYMMDD) 2015/07/02	EATON CORPORATION - CONFIDENTIAL AND PROPRIETARY NOTICE TO PERSONS RECEIVING THIS DOCUMENT AND/OR TECHNICAL INFORMATION THIS DOCUMENT, INCLUDING THE DRAWING AND INFORMATION CONTAINED THEREON, IS CONFIDENTIAL AND IS THE EXCLUSIVE PROPERTY OF EATON CORPORATION, AND IS LOANED TO YOU AND SUBJECT TO RECEIPT BY EATON AT ANY TIME. BY TAKING POSSESSION OF THIS DOCUMENT, THE RECIPIENT ACKNOWLEDGES AND AGREES THAT THIS DOCUMENT MAY BE COPIED OR OTHERWISE DISCLOSED WITHOUT THE PRIOR WRITTEN CONSENT OF EATON. IN THE CASE OF CONFLICTING CONTRACTUAL PROVISIONS, THIS NOTICE SHALL GOVERN THE STATUS OF THIS DOCUMENT. © 2015 Eaton Corporation. All Rights Reserved.
	REVISION DESCRIPTION NEW DRAWING	ECO # ECO-082761	TITLE GROUND FAULT CIRCUIT INTERRUPTER 3/4" 2-POLE GFT 15A - 60A OUTLINE DRAWING	REVISION 001	
CHANGE RESPONSIBILITY RWDD_MCB_ENGINERING	CLASS CODE NA	SCALE 2.000	SHEET 1 OF 1	DSD-DPK-FMT REV	