

Project:

Type:

Prepared By:

Date:



UPC: 019813750064



Features and Benefits

Produces rich and vibrant colors >90CRI

Energy efficient replacement for incandescent and halogen Reflector lamps

Constructed from durable plastic which lowers risk of breakage

Rated for use in enclosed and open fixtures in dry or damp locations

Frosted lens produces smooth diffuse light

Longer lifespan compared to legacy equivalents minimizes replacement and maintenance costs

ENERGY STAR Compliant, Title 20 Compliant

Dimmable with common dimmer types (check compatibility list)

Technical Specifications

Performance

Product Type:

Reflector

Input Wattage:

10W

Lumens (Nominal):

700

Efficacy:

70 lm/W

Color Accuracy:

90 CRI

Color Temperature:

2700K

Dimmable:

Yes, down to 10%

L70 Lifespan:

25,000-Hour LED lifespan based on IES LM-70 results

Construction

Bulb Shape:

BR30

Enclosure Material:

Plastic

Housing Finish:

White

Lens Finish:

Frosted

Base Type:

E26

Beam Angle:

120°

Electrical

Power Factor:

>0.9

Input Voltage:

120V

Operating Frequency:

60 Hz

Technical Specifications (continued)

Electrical

Operating Temperature:

-20°C - 40°C

Other

Equivalency:

65W

Technology EQ:

Incandescent

Warranty (Years):

RAB warrants that our LED products will be free from defects in materials and workmanship for a period of four (4) years from the date of delivery to the end user, including coverage of light output, color stability, driver performance and fixture finish. RAB's warranty is subject to all terms and conditions found at rablighting.com/warranty.

Compliance

UL Listed:

Yes

Environment/Fixture Rating:

Damp / Enclosed

Energy Star ID:

2328152

T20 Compliant:

Yes, Title 20 Tier 2

T24 JA8 Compliant:

Complies with Title 24 Appendix JA8

RoHS:

Mercury and UV free. RoHS-compliant components.

FCC:

Complies with Part 15 of the FCC Rules

Model Number:

BR30-10-927-DIM

Case and Pallet Dimensions

	QTY	LENGTH (in)	WIDTH (in)	HEIGHT (in)
CASE	6	12	8	6.5
PALLET	840	47.9	40	39

Dimension

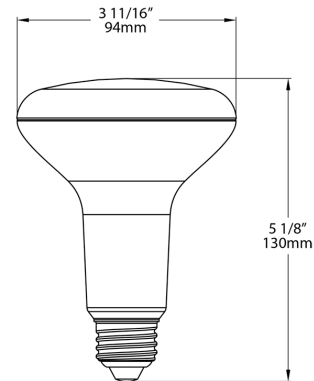

Light Distribution

