

B6RIC

6" Universal IC Remodel Housing

LAMP WATTAGE: (1) MAXIMUM 75W R/PAR30, 60W A19, 65W BR30

Catalog Number:

Project Name:

Type:

Note:



DESIGNED FOR 2" X 8" JOIST CONSTRUCTION

DESCRIPTION

Thermally protected, IC rated specification grade remodel recessed housing. For remodeling installations where housing will be in direct contact with insulation. For fast and easy installation in existing plaster or mechanical ceilings from 1/2" to 1-3/8" thick. Four remodel clips are easily retractable for fixture removal if necessary. Junction box is provided with eight 1/2" KOs and four Romex knockouts with strain relief. Accommodates up to 75W PAR30, BR30, and A19 lamps.

SPECIFICATION

A. HOUSING - Die-formed, all aluminum construction for maximum heat dissipation and rust protection.

B. SOCKET - Medium base screw shell porcelain socket preinstalled on adjustable mounting bracket is designed to allow usage of different lamp types, as well as proper and consistent lamp positioning.

C. INSTALLATION - Four preinstalled spring clips which secure the housing firmly into ceiling to accommodate different ceiling thicknesses from 1/2" to 1-3/8".

D. JUNCTION BOX - UL listed for through-branch circuit wiring, provided with eight 1/2" KOs and four Romex knockouts with strain relief.

E. THERMAL PROTECTION - Standard thermal protection device guards against improper installation, overlamping and misuse of insulation material.

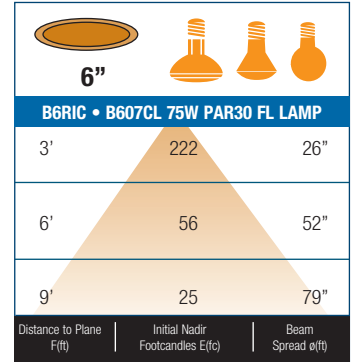

FEATURES

- Thermally Protected remodel IC housing.
- Dependable, favorable design and effortless installation.
- Unit slips through 6-1/2" ceiling opening.
- Four preinstalled spring clips which secure the housing firmly into ceiling to accommodate different ceiling thickness from 1/2" to 1-3/8".
- Can be installed from below the ceiling.
- 7-1/4" height allows use in 2" x 8" joist construction.
- Wire through junction box.
- Adjustable socket bracket.
- Preinstalled socket cap provides electrical contact protection against dust, paint and over spray.

OPTIONS

AIR-SHUT

- Gasket to prevent air flow from heated or air conditioned spaces.
- Meets all national air flow requirements.

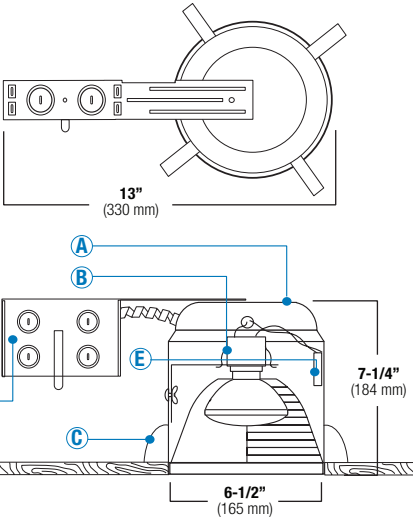

ITEM SELECTOR: (Please check the boxes below for the option desired)

TYPE	AIR-SHUT	OPTION	TRIM TYPE	BAFFLE	REFLECTOR	TRIM/RING	GLASS
B6RIC	<input type="checkbox"/> AT	<input type="checkbox"/> (W) With quick connects	<input type="checkbox"/> B630 <input type="checkbox"/> B609 <input type="checkbox"/> B606L <input type="checkbox"/> B676 <input type="checkbox"/> B651 <input type="checkbox"/> B688	<input type="checkbox"/> W	<input type="checkbox"/> CL	<input type="checkbox"/> WH	<input type="checkbox"/> Green
			<input type="checkbox"/> B620 <input type="checkbox"/> B619 <input type="checkbox"/> B635 <input type="checkbox"/> B612 <input type="checkbox"/> B611 <input type="checkbox"/> B685	<input type="checkbox"/> P	<input type="checkbox"/> RG	<input type="checkbox"/> BK	<input type="checkbox"/> Yellow
			<input type="checkbox"/> B631 <input type="checkbox"/> B646 <input type="checkbox"/> B636 <input type="checkbox"/> B645 <input type="checkbox"/> B647 <input type="checkbox"/> B696	<input type="checkbox"/> SN	<input type="checkbox"/> W	<input type="checkbox"/> SN	<input type="checkbox"/> Pink
			<input type="checkbox"/> AF637 <input type="checkbox"/> B616 <input type="checkbox"/> B642 <input type="checkbox"/> B648 <input type="checkbox"/> B644 <input type="checkbox"/> B689	<input type="checkbox"/> CP	<input type="checkbox"/> MB	<input type="checkbox"/> CP	<input type="checkbox"/> Brown
			<input type="checkbox"/> AF631 <input type="checkbox"/> B663 <input type="checkbox"/> B641 <input type="checkbox"/> B652 <input type="checkbox"/> B650 <input type="checkbox"/> B680	<input type="checkbox"/> BZ	<input type="checkbox"/> BZ	<input type="checkbox"/> CH	<input type="checkbox"/> Navy Blue
			<input type="checkbox"/> AF639 <input type="checkbox"/> B673 <input type="checkbox"/> B656 <input type="checkbox"/> B603 <input type="checkbox"/> B622		<input type="checkbox"/> CP	<input type="checkbox"/> PB	<input type="checkbox"/> Orange
			<input type="checkbox"/> AF640 <input type="checkbox"/> B683 <input type="checkbox"/> B657 <input type="checkbox"/> B615 <input type="checkbox"/> B625		<input type="checkbox"/> SN	<input type="checkbox"/> BZ	<input type="checkbox"/> Blue
			<input type="checkbox"/> AF632 <input type="checkbox"/> B601 <input type="checkbox"/> B637 <input type="checkbox"/> B633 <input type="checkbox"/> B624		<input type="checkbox"/> SHZ		<input type="checkbox"/> White
			<input type="checkbox"/> B610 <input type="checkbox"/> B601L <input type="checkbox"/> B643 <input type="checkbox"/> B649 <input type="checkbox"/> B681				<input type="checkbox"/> Red
			<input type="checkbox"/> B607 <input type="checkbox"/> B605 <input type="checkbox"/> B658 <input type="checkbox"/> AF633 <input type="checkbox"/> B687				
			<input type="checkbox"/> B608 <input type="checkbox"/> B605L <input type="checkbox"/> B659 <input type="checkbox"/> B225 <input type="checkbox"/> B682				
			<input type="checkbox"/> B602 <input type="checkbox"/> B606 <input type="checkbox"/> B675 <input type="checkbox"/> B653 <input type="checkbox"/> B693				

Specifications:

B6RIC

AIR-SHUT OPTION TRIM TYPE BAFFLE REFLECTOR TRIM/RING GLASS

BAFFLE	REFLECTOR	TRIM/RING
W White	CL Chrome	WH White
P Black	RG Gold	BK Black
SN Satin Nickel	W White	SN Satin Nickel
CP Copper	MB Black	CP Copper
BZ Bronze	BZ Bronze	CH Chrome
	CP Copper	PB Polish Brass
	SN Satin Nickel	BZ Bronze
	SHZ Satin Haze	

Sample of Catalog Number: B6RIC-AT-W-B630-W-WH

*For custom baffle, reflector, trim ring, glass color and lens options, please consult factory.



Submission form is available @ www.iuseelite.com
Tel: 323-888-1973 • Fax: 323-888-1977

Specifications and Dimensions subject to change without notice.

REV: ELITE LIGHTING-SPEC-06-29-2011

6" Incandescent Trims

(LAMP WATTAGE: (1) MAXIMUM 75W R/PAR30, 60W A19, 65W BR30)

Catalog Number:

Project Name:

Type:

Note:



<p>B630CP-CP METAL STEPPED BAFFLE R30/PAR30</p>  <p>BAFFLE FINISH: W, P, SN, CP, BZ</p> <p>TRIM/RING FINISH: WH, BK, SN, CP, CH, PB, BZ</p>  <p>7-1/4"</p>	<p>B620-ORANGE GLASS TRIM</p>  <p>GLASS FINISH: GREEN, YELLOW, PINK, BROWN, NAVY BLUE, ORANGE, WHITE, RED</p>  <p>7-1/4"</p>	<p>B631P-WH R30 PREMIUM PHENOLIC BAFFLE / METAL RING</p>  <p>BAFFLE FINISH: W, P</p> <p>TRIM/RING FINISH: WH, BK, SN, CP, CH, PB, BZ</p>  <p>7-1/4"</p>	<p>AF637W-WH SELF FLANGE AIR-SHUT BAFFLE</p>  <p>AVAILABLE COLOR COMBINATIONS: W-WH, P-WH, P-BK, SN-SN, CP-CP, BZ-BZ</p>  <p>7-1/4"</p>
<p>AF631W-WH SELF FLANGE AIR-SHUT BAFFLE</p>  <p>AVAILABLE COLOR COMBINATIONS: W-WH, P-WH, P-BK, SN-SN, CP-CP, BZ-BZ</p>  <p>7-1/4"</p>	<p>AF639W-WH SELF FLANGE AIR-SHUT BAFFLE</p>  <p>AVAILABLE COLOR COMBINATIONS: W-WH</p> <p>MATT WHITE FINISH</p>  <p>7-1/4"</p>	<p>AF640W-WH DEEP SELF FLANGE AIR-SHUT BAFFLE</p>  <p>AVAILABLE COLOR COMBINATIONS: W-WH, P-WH, SN-SN, CP-CP, BZ-BZ</p>  <p>7-1/4"</p>	<p>AF632RG-WH AIR-SHUT REFLECTOR</p>  <p>AVAILABLE COLOR COMBINATIONS: CL-WH, CL-CH, RG-WH, W-WH, MB-WH, CP-CP, SN-SN</p>  <p>7-1/4"</p>
<p>B610P-RG-WH CONE REFLECTOR/BAFFLE TRIM</p>  <p>BAFFLE FINISH: W, P</p> <p>REFLECTOR FINISH: CL, RG</p> <p>TRIM/RING FINISH: WH, BK, SN, CP, CH, PB, BZ</p>  <p>7-1/4"</p>	<p>B607CP-WH REFLECTOR R/PAR30</p>  <p>REFLECTOR FINISH: CL, RG, W, MB, CP, SN, BZ, SHZ</p> <p>TRIM/RING FINISH: WH, BK, SN, CP, CH, PB, BZ</p>  <p>7-1/4"</p>	<p>B608CL-WH CONE REFLECTOR A19</p>  <p>REFLECTOR FINISH: CL, RG, W, MB, CP, SN, BZ, SHZ</p> <p>TRIM/RING FINISH: WH, BK, SN, CP, CH, PB, BZ</p>  <p>7-1/4"</p>	<p>B602SN EYEBALL</p>  <p>TRIM/RING FINISH: WH, BK, SN, CP, CH, PB, BZ</p>  <p>8" 30° TILT 359° ROTATION</p>
<p>B609W-WH REGRESSED EYEBALL WITH BAFFLE</p>  <p>BAFFLE FINISH: W, P, SN, CP, BZ</p> <p>TRIM/RING FINISH: WH, BK, SN, CP, CH, PB, BZ</p> <p>EYEBALL FINISH: WH, BK, SN, CP, CH, PB, BZ</p>  <p>7-1/4" 30° TILT 359° ROTATION</p>	<p>B619RG-PB REGRESSED EYEBALL WITH REFLECTOR</p>  <p>REFLECTOR FINISH: CL, RG, W, MB, CP, SN</p> <p>TRIM/RING FINISH: WH, BK, SN, CP, CH, PB, BZ</p> <p>EYEBALL FINISH: WH, BK, SN, CP, CH, PB, BZ</p>  <p>7-1/4" 30° TILT 359° ROTATION</p>	<p>B646P-WH EYEBALL WITH BAFFLE</p>  <p>BAFFLE FINISH: W, P</p> <p>TRIM/RING FINISH: WH</p>  <p>8" 30° TILT 359° ROTATION</p>	<p>B616W-WH PAR20 REGRESSED EYEBALL W/ BAFFLE</p>  <p>BAFFLE FINISH: W, P, SN, CP, BZ</p> <p>TRIM/RING FINISH: WH, BK, SN, CP, CH, PB, BZ</p> <p>EYEBALL FINISH: WH, BK, SN, CP, CH, PB, BZ</p>  <p>7-1/4" 30° TILT 359° ROTATION</p>

6" Incandescent Trims

(LAMP WATTAGE: (1) MAXIMUM 75W R/PAR30, 60W A19, 65W BR30)

Catalog Number:

Project Name:

Type:

Note:



<p>B663PB PAR30 GIMBAL RING</p>  <p>TRIM/RING FINISH: WH, BK, SN, CP, CH, PB, BZ</p> 	<p>B673P-WH PAR30 BAFFLE W/ GIMBAL RING</p>  <p>BAFFLE FINISH: W, P, SN, CP, BZ</p> <p>TRIM/RING FINISH: WH, BK, SN, CP, CH, PB, BZ</p> 	<p>B683CL-WH PAR30 REFLECTOR W/ GIMBAL RING</p>  <p>REFLECTOR FINISH: CL, RG, W, MB, CP, SN</p> <p>TRIM/RING FINISH: WH, BK, SN, CP, CH, PB, BZ</p> 	<p>B601CP METAL ALBALITE LENS</p>  <p>LENS: ALBALITE</p> <p>TRIM/RING FINISH: WH, BK, SN, CP, CH, PB, BZ</p> 
<p>B601L PLASTIC ALBALITE LENS</p>  <p>LENS: ALBALITE</p> <p>TRIM/RING FINISH: WHITE PLASTIC</p> 	<p>B605PB METAL FRESNEL LENS</p>  <p>LENS: FRESNEL</p> <p>TRIM/RING FINISH: WH, BK, SN, CP, CH, PB, BZ</p> 	<p>B605L PLASTIC FRESNEL LENS</p>  <p>LENS: FRESNEL</p> <p>TRIM/RING FINISH: WHITE PLASTIC</p> 	<p>B606CP METAL DROP OPAL LENS</p>  <p>LENS: DROP OPAL</p> <p>TRIM/RING FINISH: WH, BK, SN, CP, CH, PB, BZ</p> 
<p>B606L PLASTIC DROP OPAL LENS</p>  <p>LENS: DROP OPAL</p> <p>TRIM/RING FINISH: WHITE PLASTIC</p> 	<p>B635P-WH BAFFLE W/ ALBALITE LENS</p>  <p>BAFFLE FINISH: W, P, SN, CP, BZ</p> <p>TRIM/RING FINISH: WH, BK, SN, CP, CH, PB, BZ</p> 	<p>B636W-WH BAFFLE W/ FRESNEL LENS</p>  <p>BAFFLE FINISH: W, P, SN, CP, BZ</p> <p>TRIM/RING FINISH: WH, BK, SN, CP, CH, PB, BZ</p> 	<p>B642CL-WH REFLECTOR W/ FRESNEL LENS</p>  <p>REFLECTOR FINISH: CL, RG, W, MB, CP, SN, SHZ</p> <p>TRIM/RING FINISH: WH, BK, SN, CP, CH, PB, BZ</p> 
<p>B641RG-WH REFLECTOR W/ ALBALITE LENS</p>  <p>REFLECTOR FINISH: CL, RG, W, MB, CP, SN, SHZ</p> <p>TRIM/RING FINISH: WH, BK, SN, CP, CH, PB, BZ</p> 	<p>B656W-WH BAFFLE W/ FROSTED DOME SHOWER LENS</p>  <p>BAFFLE FINISH: W, P, SN, CP, BZ</p> <p>TRIM/RING FINISH: WH, BK, SN, CP, CH, PB, BZ</p> 	<p>B657CL-WH REFLECTOR W/ FROSTED DOME SHOWER LENS</p>  <p>REFLECTOR FINISH: CL, RG, W, MB, CP, SN, SHZ</p> <p>TRIM/RING FINISH: WH, BK, SN, CP, CH, PB, BZ</p> 	<p>B637W-WH BAFFLE W/ DROP OPAL LENS</p>  <p>BAFFLE FINISH: W, P, SN, CP, BZ</p> <p>TRIM/RING FINISH: WH, BK, SN, CP, CH, PB, BZ</p> 

6" Incandescent Trims

(LAMP WATTAGE: (1) MAXIMUM 75W R/PAR30, 60W A19, 65W BR30)

Catalog Number:

Project Name:

Type:

Note:



B643RG-WH
REFLECTOR W/ DROP OPAL LENS



REFLECTOR FINISH:
CL, RG, W, MB, CP,
SN, SHZ

TRIM/RING FINISH:
WH, BK, SN, CP, CH,
PB, BZ

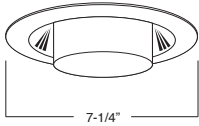

B658CL-WH
REFLECTOR W/ PRISMATIC LENS



REFLECTOR FINISH:
CL, RG, W, MB, CP,
SN, SHZ

TRIM/RING FINISH:
WH, BK, SN, CP, CH,
PB, BZ

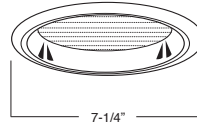

B659CL-WH
REFLECTOR W/ FROSTED LENS



REFLECTOR FINISH:
CL, RG, W, MB, CP,
SN, SHZ

TRIM/RING FINISH:
WH, BK, SN, CP, CH,
PB, BZ

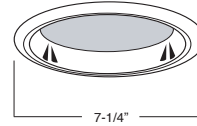

B675W-WH
BAFFLE W/ PRISMATIC LENS



BAFFLE FINISH:
W, P, SN, CP, BZ

TRIM/RING FINISH:
WH, BK, SN, CP, CH,
PB, BZ

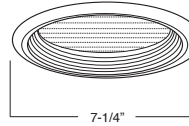

B676W-WH
BAFFLE W/ FROSTED LENS



BAFFLE FINISH:
W, P, SN, CP, BZ

TRIM/RING FINISH:
WH, BK, SN, CP, CH,
PB, BZ

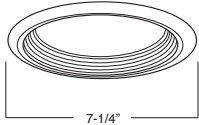

B612WH
SMOOTH FROST DOME SHOWER LENS



LENS:
FROSTED

TRIM/RING FINISH:
WH, BK, SN, CP, CH,
PB, BZ

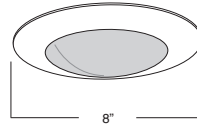

B645WH
DESIGNER POINT SHOWER LENS



LENS:
FROSTED/CLEAR

TRIM/RING FINISH:
WH, BK, SN, CP, CH,
PB, BZ

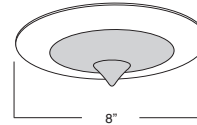

B648WH
DESIGNER CONE SHOWER LENS



LENS:
FROSTED

TRIM/RING FINISH:
WH, BK, SN, CP, CH,
PB, BZ

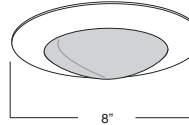

B652WH
SMOOTH FROST SHOWER LENS



LENS:
FROSTED

TRIM/RING FINISH:
WH, BK, SN, CP, CH,
PB, BZ

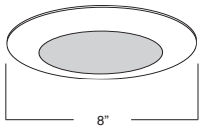

B603CP
R/PAR30 OPEN TRIM

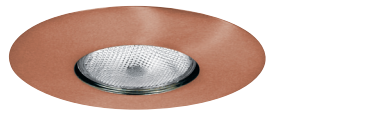

TRIM/RING FINISH:
WH, BK, SN, CP, CH,
PB, BZ

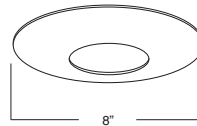

B615WH
DESIGNER PINHOLE



TRIM/RING FINISH:
WH, BK

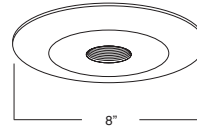

B633WH
R/PAR30 SPLAY TRIM



TRIM/RING FINISH:
WH, BK

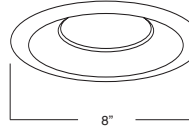

B649RG-WH
PAR20 REFLECTOR



REFLECTOR FINISH:
CL, RG, W, MB,
CP, SN

TRIM/RING FINISH:
WH, BK

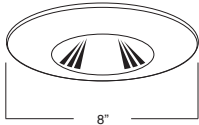

AF633CH
R/PAR30 OPEN TRIM



TRIM/RING FINISH:
WH, BK, SN, CP, CH,
PB, BZ

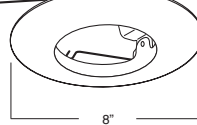

B225WH
OPEN TRIM STEPPED BAFFLE



BAFFLE FINISH:
W, P

TRIM/RING FINISH:
WH

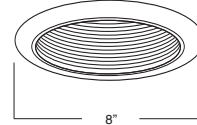

B653W-WH
BAFFLE WITH BAFFLE

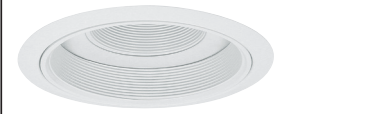

BAFFLE FINISH:
W, P

TRIM/RING FINISH:
WH, BK, SN, CP,
CH, PB

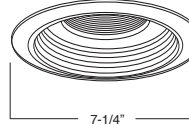

6" Incandescent Trims

(LAMP WATTAGE: (1) MAXIMUM 75W R/PAR30, 60W A19, 65W BR30)

Catalog Number:

Project Name:

Type:

Note:



<p>B651P-WH PAR20 STEPPED BAFFLE</p>   <p>BAFFLE FINISH: W, P, SN, CP, BZ</p> <p>TRIM/RING FINISH: WH, BK</p> <p>8"</p>	<p>B611W-WH PAR30 BAFFLE WALL WASH</p>   <p>AVAILABLE COLOR COMBINATIONS: W-WH, P-WH, SN-SN, CP-CP, BZ-BZ</p> <p>COVER FINISH: WH, BK</p> <p>7-1/4"</p>	<p>B647P-WH DESIGNER BAFFLE WALL WASH PAR20</p>   <p>BAFFLE FINISH: W, P, SN, CP, BZ</p> <p>TRIM/RING FINISH: WH</p> <p>8"</p>	<p>B644RG-WH DESIGNER REFLECTOR WALL WASH PAR20</p>   <p>REFLECTOR FINISH: CL, RG, W, MB, CP, SN</p> <p>TRIM/RING FINISH: WH</p> <p>8"</p>
<p>B650WH DESIGNER WALL WASH</p>   <p>TRIM/RING FINISH: WH</p> <p>8"</p>	<p>B622RG-WH R/PAR30 WALL WASH REFLECTOR</p>   <p>REFLECTOR FINISH: CL, RG, W, MB, CP, SN, SHZ</p> <p>COVER FINISH: WH</p> <p>TRIM/RING FINISH: WH, BK, SN, CP, CH, PB, BZ</p> <p>7-1/4"</p>	<p>B625CL-WH A-19 CONE REFLECTOR WALL WASH</p>   <p>REFLECTOR FINISH: CL, RG, W, MB, CP, SN, SHZ</p> <p>COVER FINISH: WH</p> <p>TRIM/RING FINISH: WH, BK, SN, CP, CH, PB, BZ</p> <p>7-1/4"</p>	<p>B624W-CL CONE REFLECTOR BAFFLE WALL WASH</p>   <p>BAFFLE FINISH: W, P</p> <p>REFLECTOR FINISH: CL, RG</p> <p>COVER FINISH: WH</p> <p>TRIM/RING FINISH: WH, BK, SN, CP, CH, PB, BZ</p> <p>7-1/4"</p>
<p>B681CP-WH SQUARE BAFFLE TRIM</p>   <p>BAFFLE FINISH: W, P, SN, CP, BZ</p> <p>TRIM/RING FINISH: WH, BK, SN, CP</p> <p>7-1/2"</p>	<p>B687CP-WH SQUARE REFLECTOR TRIM</p>   <p>REFLECTOR FINISH: CL, RG, W, MB, SN, CP</p> <p>TRIM/RING FINISH: WH, BK, SN, CP</p> <p>7-1/2"</p>	<p>B682WH SQUARE EYEBALL TRIM</p>   <p>TRIM/RING FINISH: WH</p> <p>7-1/2"</p>	<p>B693WH SQUARE PAR30 GIMBAL TRIM</p>   <p>TRIM/RING FINISH: WH</p> <p>7-1/2"</p>
<p>B688WH SQUARE ALBALITE SHOWER TRIM</p>   <p>LENS: WHITE</p> <p>TRIM/RING FINISH: WH</p> <p>7-1/2"</p> <p>FOR WET LOCATION</p>	<p>B685WH SQUARE FRESNEL SHOWER TRIM</p>   <p>LENS: CLEAR</p> <p>TRIM/RING FINISH: WH</p> <p>7-1/2"</p> <p>FOR WET LOCATION</p>	<p>B696WH SQUARE DROP OIPAL SHOWER TRIM</p>   <p>LENS: WHITE</p> <p>TRIM/RING FINISH: WH</p> <p>7-1/2"</p> <p>FOR WET LOCATION</p>	<p>B689WH SQUARE DESIGNER CONE SHOWER LENS</p>   <p>LENS: FROSTED</p> <p>TRIM/RING FINISH: WH</p> <p>7-1/2"</p> <p>FOR WET LOCATION</p>

6" Incandescent Trims

(LAMP WATTAGE: (1) MAXIMUM 75W R/PAR30, 60W A19, 65W BR30)

Catalog Number:

Project Name:

Type:

Note:



B680WH
SQUARE DESIGNER POINT LENS



FOR **WET**
LOCATION

LENS:
FROSTED/CLEAR

TRIM/RING FINISH:
WH

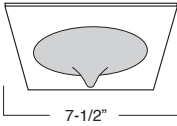

BAFFLE		REFLECTOR		TRIM RING	
W	White	CL	Chrome	WH	White
P	Black	RG	Gold	BK	Black
SN	Satin Nickel	W	White	SN	Satin Nickel
CP	Copper	MB	Black	CP	Copper
BZ	Bronze	CP	Copper	CH	Chrome
		SN	Satin Nickel	PB	Polish Brass
				BZ	Bronze

**For custom baffle, reflector, trim ring, glass color and lens options, please consult factory.*

B6RIC

6" Universal IC Remodel Housing

LAMP WATTAGE: (1) MAXIMUM 75W R/PAR30, 60W A19, 65W BR30



DESIGNED FOR 2" X 8" JOIST CONSTRUCTION

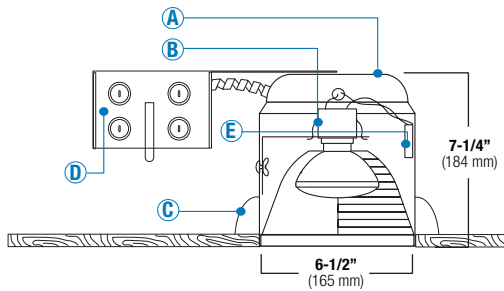
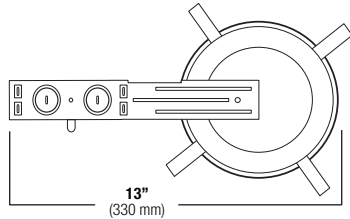

ITEM SELECTOR: (Please check the boxes below for the option desired)

TYPE	AIR-SHUT	OPTION	TRIM TYPE	BAFFLE	REFLECTOR	TRIM/RING	GLASS
B6RIC	<input type="checkbox"/> AT	<input type="checkbox"/> (W) With quick connects	<input type="checkbox"/> B630 <input type="checkbox"/> B609 <input type="checkbox"/> B606L <input type="checkbox"/> B676 <input type="checkbox"/> B651 <input type="checkbox"/> B688	<input type="checkbox"/> W	<input type="checkbox"/> CL	<input type="checkbox"/> WH	<input type="checkbox"/> Green
			<input type="checkbox"/> B620 <input type="checkbox"/> B619 <input type="checkbox"/> B635 <input type="checkbox"/> B612 <input type="checkbox"/> B611 <input type="checkbox"/> B685	<input type="checkbox"/> P	<input type="checkbox"/> RG	<input type="checkbox"/> BK	<input type="checkbox"/> Yellow
			<input type="checkbox"/> B631 <input type="checkbox"/> B646 <input type="checkbox"/> B636 <input type="checkbox"/> B645 <input type="checkbox"/> B647 <input type="checkbox"/> B696	<input type="checkbox"/> SN	<input type="checkbox"/> W	<input type="checkbox"/> SN	<input type="checkbox"/> Pink
			<input type="checkbox"/> AF637 <input type="checkbox"/> B616 <input type="checkbox"/> B642 <input type="checkbox"/> B648 <input type="checkbox"/> B644 <input type="checkbox"/> B689	<input type="checkbox"/> CP	<input type="checkbox"/> MB	<input type="checkbox"/> CP	<input type="checkbox"/> Brown
			<input type="checkbox"/> AF631 <input type="checkbox"/> B663 <input type="checkbox"/> B641 <input type="checkbox"/> B652 <input type="checkbox"/> B650 <input type="checkbox"/> B680	<input type="checkbox"/> BZ	<input type="checkbox"/> BZ	<input type="checkbox"/> CH	<input type="checkbox"/> Navy Blue
			<input type="checkbox"/> AF639 <input type="checkbox"/> B673 <input type="checkbox"/> B656 <input type="checkbox"/> B603 <input type="checkbox"/> B622		<input type="checkbox"/> CP	<input type="checkbox"/> PB	<input type="checkbox"/> Orange
			<input type="checkbox"/> AF640 <input type="checkbox"/> B683 <input type="checkbox"/> B657 <input type="checkbox"/> B615 <input type="checkbox"/> B625		<input type="checkbox"/> SN	<input type="checkbox"/> BZ	<input type="checkbox"/> Blue
			<input type="checkbox"/> AF632 <input type="checkbox"/> B601 <input type="checkbox"/> B637 <input type="checkbox"/> B633 <input type="checkbox"/> B624		<input type="checkbox"/> SHZ		<input type="checkbox"/> White
			<input type="checkbox"/> B610 <input type="checkbox"/> B601L <input type="checkbox"/> B643 <input type="checkbox"/> B649 <input type="checkbox"/> B681				<input type="checkbox"/> Red
			<input type="checkbox"/> B607 <input type="checkbox"/> B605 <input type="checkbox"/> B658 <input type="checkbox"/> AF633 <input type="checkbox"/> B687				
			<input type="checkbox"/> B608 <input type="checkbox"/> B605L <input type="checkbox"/> B659 <input type="checkbox"/> B225 <input type="checkbox"/> B682				
			<input type="checkbox"/> B602 <input type="checkbox"/> B606 <input type="checkbox"/> B675 <input type="checkbox"/> B653 <input type="checkbox"/> B693				

Specifications:

B6RIC

AIR-SHUT OPTION TRIM TYPE BAFFLE REFLECTOR TRIM/RING GLASS

BAFFLE	REFLECTOR	TRIM/RING
W White	CL Chrome	WH White
P Black	RG Gold	BK Black
SN Satin Nickel	W White	SN Satin Nickel
CP Copper	MB Black	CP Copper
BZ Bronze	BZ Bronze	CH Chrome
	CP Copper	PB Polish Brass
	SN Satin Nickel	BZ Bronze
	SHZ Satin Haze	

Sample of Catalog Number: B6RIC-AT-W-B630-W-WH

*For custom baffle, reflector, trim ring, glass color and lens options, please consult factory.



Submission form is available @ www.iuseelite.com
Tel: 323-888-1973 • Fax: 323-888-1977

Specifications and Dimensions subject to change without notice.

REV: ELITE LIGHTING-SPEC-06-29-2011

Catalog Number:

Project Name:

Type:

Note:



DESCRIPTION

Thermally protected, IC rated specification grade remodel recessed housing. For remodeling installations where housing will be in direct contact with insulation. For fast and easy installation in existing plaster or mechanical ceilings from 1/2" to 1-3/8" thick. Four remodel clips are easily retractable for fixture removal if necessary. Junction box is provided with eight 1/2" KOs and four Romex knockouts with strain relief. Accommodates up to 75W PAR30, BR30, and A19 lamps.

SPECIFICATION

A. HOUSING - Die-formed, all aluminum construction for maximum heat dissipation and rust protection.

B. SOCKET - Medium base screw shell porcelain socket preinstalled on adjustable mounting bracket is designed to allow usage of different lamp types, as well as proper and consistent lamp positioning.

C. INSTALLATION - Four preinstalled spring clips which secure the housing firmly into ceiling to accommodate different ceiling thicknesses from 1/2" to 1-3/8".

D. JUNCTION BOX - UL listed for through-branch circuit wiring, provided with eight 1/2" KOs and four Romex knockouts with strain relief.

E. THERMAL PROTECTION - Standard thermal protection device guards against improper installation, overlamping and misuse of insulation material.

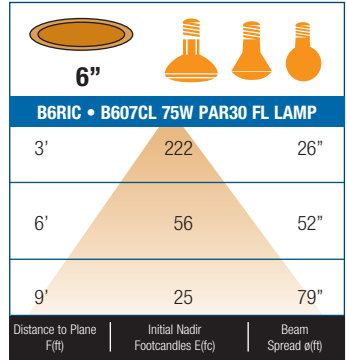

BEAM DIA. MEASURED AT 50% OF NADIR F.C.

FEATURES

- Thermally Protected remodel IC housing.
- Dependable, favorable design and effortless installation.
- Unit slips through 6-1/2" ceiling opening.
- Four preinstalled spring clips which secure the housing firmly into ceiling to accommodate different ceiling thickness from 1/2" to 1-3/8".
- Can be installed from below the ceiling.
- 7-1/4" height allows use in 2" x 8" joist construction.
- Wire through junction box.
- Adjustable socket bracket.
- Preinstalled socket cap provides electrical contact protection against dust, paint and over spray.

OPTIONS

AIR-SHUT

- Gasket to prevent air flow from heated or air conditioned spaces.
- Meets all national air flow requirements.

6" Incandescent Trims

(LAMP WATTAGE: (1) MAXIMUM 75W R/PAR30, 60W A19, 65W BR30)

Catalog Number:

Project Name:

Type:

Note:

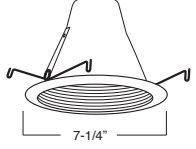

<p>B630CP-CP METAL STEPPED BAFFLE R30/PAR30</p>  <p>BAFFLE FINISH: W, P, SN, CP, BZ</p> <p>TRIM/RING FINISH: WH, BK, SN, CP, CH, PB, BZ</p>  <p>7-1/4"</p>	<p>B620-ORANGE GLASS TRIM</p>  <p>GLASS FINISH: GREEN, YELLOW, PINK, BROWN, NAVY BLUE, ORANGE, WHITE, RED</p>  <p>7-1/4"</p>	<p>B631P-WH R30 PREMIUM PHENOLIC BAFFLE / METAL RING</p>  <p>BAFFLE FINISH: W, P</p> <p>TRIM/RING FINISH: WH, BK, SN, CP, CH, PB, BZ</p>  <p>7-1/4"</p>	<p>AF637W-WH SELF FLANGE AIR-SHUT BAFFLE</p>  <p>NEW CLIP DESIGN</p> <p>AVAILABLE COLOR COMBINATIONS: W-WH, P-WH, P-BK, SN-SN, CP-CP, BZ-BZ</p>  <p>7-1/4"</p>
<p>AF631W-WH SELF FLANGE AIR-SHUT BAFFLE</p>  <p>NEW CLIP DESIGN</p> <p>AVAILABLE COLOR COMBINATIONS: W-WH, P-WH, P-BK, SN-SN, CP-CP, BZ-BZ</p>  <p>7-1/4"</p>	<p>AF639W-WH SELF FLANGE AIR-SHUT BAFFLE</p>  <p>NEW CLIP DESIGN</p> <p>AVAILABLE COLOR COMBINATIONS: W-WH</p> <p>MATT WHITE FINISH</p>  <p>7-1/4"</p>	<p>AF640W-WH DEEP SELF FLANGE AIR-SHUT BAFFLE</p>  <p>NEW CLIP DESIGN</p> <p>AVAILABLE COLOR COMBINATIONS: W-WH, P-WH, SN-SN, CP-CP, BZ-BZ</p>  <p>7-1/4"</p>	<p>AF632RG-WH AIR-SHUT REFLECTOR</p>  <p>NEW CLIP DESIGN</p> <p>AVAILABLE COLOR COMBINATIONS: CL-WH, CL-CH, RG-WH, W-WH, MB-WH, CP-CP, SN-SN</p>  <p>7-1/4"</p>
<p>B610P-RG-WH CONE REFLECTOR/BAFFLE TRIM</p>  <p>BAFFLE FINISH: W, P</p> <p>REFLECTOR FINISH: CL, RG</p> <p>TRIM/RING FINISH: WH, BK, SN, CP, CH, PB, BZ</p>  <p>7-1/4"</p>	<p>B607CP-WH REFLECTOR R/PAR30</p>  <p>REFLECTOR FINISH: CL, RG, W, MB, CP, SN, BZ, SHZ</p> <p>TRIM/RING FINISH: WH, BK, SN, CP, CH, PB, BZ</p>  <p>7-1/4"</p>	<p>B608CL-WH CONE REFLECTOR A19</p>  <p>REFLECTOR FINISH: CL, RG, W, MB, CP, SN, BZ, SHZ</p> <p>TRIM/RING FINISH: WH, BK, SN, CP, CH, PB, BZ</p>  <p>7-1/4"</p>	<p>B602SN EYEBALL</p>  <p>TRIM/RING FINISH: WH, BK, SN, CP, CH, PB, BZ</p>  <p>8" 30° TILT 359° ROTATION</p>
<p>B609W-WH REGRESSED EYEBALL WITH BAFFLE</p>  <p>BAFFLE FINISH: W, P, SN, CP, BZ</p> <p>TRIM/RING FINISH: WH, BK, SN, CP, CH, PB, BZ</p> <p>EYEBALL FINISH: WH, BK, SN, CP, CH, PB, BZ</p>  <p>7-1/4" 30° TILT 359° ROTATION</p>	<p>B619RG-PB REGRESSED EYEBALL WITH REFLECTOR</p>  <p>REFLECTOR FINISH: CL, RG, W, MB, CP, SN</p> <p>TRIM/RING FINISH: WH, BK, SN, CP, CH, PB, BZ</p> <p>EYEBALL FINISH: WH, BK, SN, CP, CH, PB, BZ</p>  <p>7-1/4" 30° TILT 359° ROTATION</p>	<p>B646P-WH EYEBALL WITH BAFFLE</p>  <p>BAFFLE FINISH: W, P</p> <p>TRIM/RING FINISH: WH</p>  <p>8" 30° TILT 359° ROTATION</p>	<p>B616W-WH PAR20 REGRESSED EYEBALL W/ BAFFLE</p>  <p>BAFFLE FINISH: W, P, SN, CP, BZ</p> <p>TRIM/RING FINISH: WH, BK, SN, CP, CH, PB, BZ</p> <p>EYEBALL FINISH: WH, BK, SN, CP, CH, PB, BZ</p>  <p>7-1/4" 30° TILT 359° ROTATION</p>

6" Incandescent Trims

(LAMP WATTAGE: (1) MAXIMUM 75W R/PAR30, 60W A19, 65W BR30)

Catalog Number:

Project Name:

Type:

Note:



<p>B663PB PAR30 GIMBAL RING</p>  <p>TRIM/RING FINISH: WH, BK, SN, CP, CH, PB, BZ</p> 	<p>B673P-WH PAR30 BAFFLE W/ GIMBAL RING</p>  <p>BAFFLE FINISH: W, P, SN, CP, BZ</p> <p>TRIM/RING FINISH: WH, BK, SN, CP, CH, PB, BZ</p> 	<p>B683CL-WH PAR30 REFLECTOR W/ GIMBAL RING</p>  <p>REFLECTOR FINISH: CL, RG, W, MB, CP, SN</p> <p>TRIM/RING FINISH: WH, BK, SN, CP, CH, PB, BZ</p> 	<p>B601CP METAL ALBALITE LENS</p>  <p>LENS: ALBALITE</p> <p>TRIM/RING FINISH: WH, BK, SN, CP, CH, PB, BZ</p> 
<p>B601L PLASTIC ALBALITE LENS</p>  <p>LENS: ALBALITE</p> <p>TRIM/RING FINISH: WHITE PLASTIC</p> 	<p>B605PB METAL FRESNEL LENS</p>  <p>LENS: FRESNEL</p> <p>TRIM/RING FINISH: WH, BK, SN, CP, CH, PB, BZ</p> 	<p>B605L PLASTIC FRESNEL LENS</p>  <p>LENS: FRESNEL</p> <p>TRIM/RING FINISH: WHITE PLASTIC</p> 	<p>B606CP METAL DROP OPAL LENS</p>  <p>LENS: DROP OPAL</p> <p>TRIM/RING FINISH: WH, BK, SN, CP, CH, PB, BZ</p> 
<p>B606L PLASTIC DROP OPAL LENS</p>  <p>LENS: DROP OPAL</p> <p>TRIM/RING FINISH: WHITE PLASTIC</p> 	<p>B635P-WH BAFFLE W/ ALBALITE LENS</p>  <p>BAFFLE FINISH: W, P, SN, CP, BZ</p> <p>TRIM/RING FINISH: WH, BK, SN, CP, CH, PB, BZ</p> 	<p>B636W-WH BAFFLE W/ FRESNEL LENS</p>  <p>BAFFLE FINISH: W, P, SN, CP, BZ</p> <p>TRIM/RING FINISH: WH, BK, SN, CP, CH, PB, BZ</p> 	<p>B642CL-WH REFLECTOR W/ FRESNEL LENS</p>  <p>REFLECTOR FINISH: CL, RG, W, MB, CP, SN, SHZ</p> <p>TRIM/RING FINISH: WH, BK, SN, CP, CH, PB, BZ</p> 
<p>B641RG-WH REFLECTOR W/ ALBALITE LENS</p>  <p>REFLECTOR FINISH: CL, RG, W, MB, CP, SN, SHZ</p> <p>TRIM/RING FINISH: WH, BK, SN, CP, CH, PB, BZ</p> 	<p>B656W-WH BAFFLE W/ FROSTED DOME SHOWER LENS</p>  <p>BAFFLE FINISH: W, P, SN, CP, BZ</p> <p>TRIM/RING FINISH: WH, BK, SN, CP, CH, PB, BZ</p> 	<p>B657CL-WH REFLECTOR W/ FROSTED DOME SHOWER LENS</p>  <p>REFLECTOR FINISH: CL, RG, W, MB, CP, SN, SHZ</p> <p>TRIM/RING FINISH: WH, BK, SN, CP, CH, PB, BZ</p> 	<p>B637W-WH BAFFLE W/ DROP OPAL LENS</p>  <p>BAFFLE FINISH: W, P, SN, CP, BZ</p> <p>TRIM/RING FINISH: WH, BK, SN, CP, CH, PB, BZ</p> 

6" Incandescent Trims

(LAMP WATTAGE: (1) MAXIMUM 75W R/PAR30, 60W A19, 65W BR30)

Catalog Number:

Project Name:

Type:

Note:



B643RG-WH
REFLECTOR W/ DROP OPAL LENS



REFLECTOR FINISH:
CL, RG, W, MB, CP,
SN, SHZ

TRIM/RING FINISH:
WH, BK, SN, CP, CH,
PB, BZ

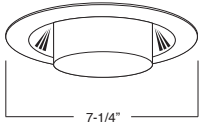

B658CL-WH
REFLECTOR W/ PRISMATIC LENS



REFLECTOR FINISH:
CL, RG, W, MB, CP,
SN, SHZ

TRIM/RING FINISH:
WH, BK, SN, CP, CH,
PB, BZ

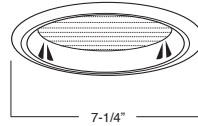

B659CL-WH
REFLECTOR W/ FROSTED LENS



REFLECTOR FINISH:
CL, RG, W, MB, CP,
SN, SHZ

TRIM/RING FINISH:
WH, BK, SN, CP, CH,
PB, BZ

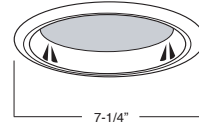

B675W-WH
BAFFLE W/ PRISMATIC LENS



BAFFLE FINISH:
W, P, SN, CP, BZ

TRIM/RING FINISH:
WH, BK, SN, CP, CH,
PB, BZ

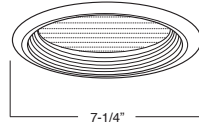

B676W-WH
BAFFLE W/ FROSTED LENS



BAFFLE FINISH:
W, P, SN, CP, BZ

TRIM/RING FINISH:
WH, BK, SN, CP, CH,
PB, BZ

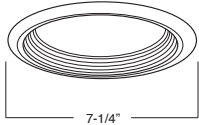

B612WH
SMOOTH FROST DOME SHOWER LENS



LENS:
FROSTED

TRIM/RING FINISH:
WH, BK, SN, CP, CH,
PB, BZ

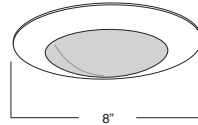

B645WH
DESIGNER POINT SHOWER LENS



LENS:
FROSTED/CLEAR

TRIM/RING FINISH:
WH, BK, SN, CP, CH,
PB, BZ

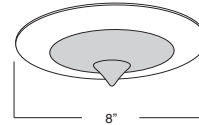

B648WH
DESIGNER CONE SHOWER LENS



LENS:
FROSTED

TRIM/RING FINISH:
WH, BK, SN, CP, CH,
PB, BZ

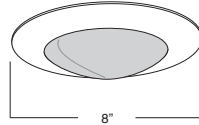

B652WH
SMOOTH FROST SHOWER LENS



LENS:
FROSTED

TRIM/RING FINISH:
WH, BK, SN, CP, CH,
PB, BZ

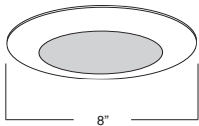

B603CP
R/PAR30 OPEN TRIM

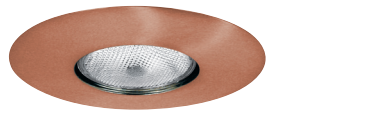

TRIM/RING FINISH:
WH, BK, SN, CP, CH,
PB, BZ

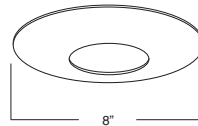

B615WH
DESIGNER PINHOLE



TRIM/RING FINISH:
WH, BK

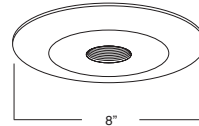

B633WH
R/PAR30 SPLAY TRIM



TRIM/RING FINISH:
WH, BK

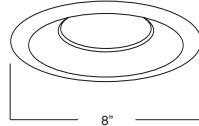

B649RG-WH
PAR20 REFLECTOR



REFLECTOR FINISH:
CL, RG, W, MB,
CP, SN

TRIM/RING FINISH:
WH, BK

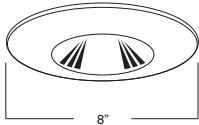

AF633CH
R/PAR30 OPEN TRIM



TRIM/RING FINISH:
WH, BK, SN, CP, CH,
PB, BZ

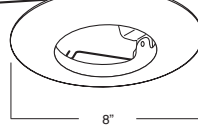

B225WH
OPEN TRIM STEPPED BAFFLE



BAFFLE FINISH:
W, P

TRIM/RING FINISH:
WH

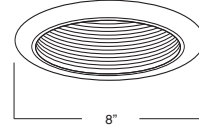

B653W-WH
BAFFLE WITH BAFFLE

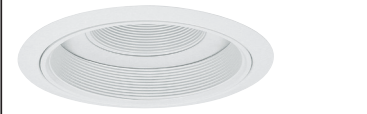

BAFFLE FINISH:
W, P

TRIM/RING FINISH:
WH, BK, SN, CP,
CH, PB

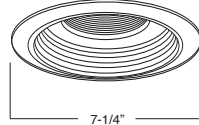

6" Incandescent Trims

(LAMP WATTAGE: (1) MAXIMUM 75W R/PAR30, 60W A19, 65W BR30)

Catalog Number:

Project Name:

Type:

Note:



B651P-WH
PAR20 STEPPED BAFFLE

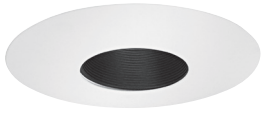

BAFFLE FINISH:
W, P, SN, CP, BZ
TRIM/RING FINISH:
WH, BK

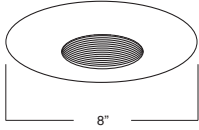

B611W-WH
PAR30 BAFFLE WALL WASH

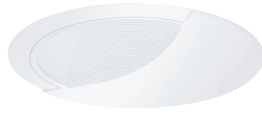

AVAILABLE COLOR COMBINATIONS:
W-WH, P-WH, SN-SN, CP-CP, BZ-BZ
COVER FINISH:
WH, BK

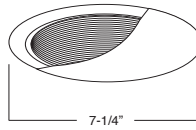

B647P-WH
DESIGNER BAFFLE WALL WASH PAR20



BAFFLE FINISH:
W, P, SN, CP, BZ
TRIM/RING FINISH:
WH

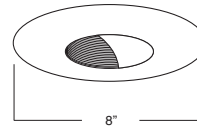

B644RG-WH
DESIGNER REFLECTOR WALL WASH PAR20



REFLECTOR FINISH:
CL, RG, W, MB, CP, SN
TRIM/RING FINISH:
WH

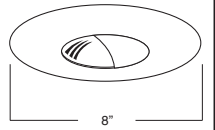

B650WH
DESIGNER WALL WASH



TRIM/RING FINISH:
WH

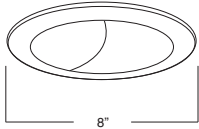

B622RG-WH
R/PAR30 WALL WASH REFLECTOR



REFLECTOR FINISH:
CL, RG, W, MB, CP, SN, SHZ
COVER FINISH:
WH
TRIM/RING FINISH:
WH, BK, SN, CP, CH, PB, BZ

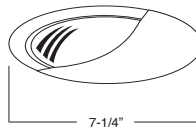

B625CL-WH
A-19 CONE REFLECTOR WALL WASH



REFLECTOR FINISH:
CL, RG, W, MB, CP, SN, SHZ
COVER FINISH:
WH
TRIM/RING FINISH:
WH, BK, SN, CP, CH, PB, BZ

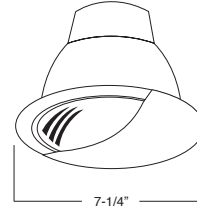

B624W-CL
CONE REFLECTOR BAFFLE WALL WASH



BAFFLE FINISH:
W, P
REFLECTOR FINISH:
CL, RG
COVER FINISH:
WH
TRIM/RING FINISH:
WH, BK, SN, CP, CH, PB, BZ

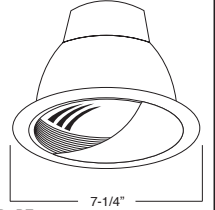

B681CP-WH
SQUARE BAFFLE TRIM

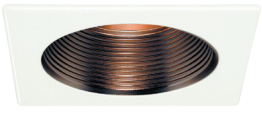

BAFFLE FINISH:
W, P, SN, CP, BZ
TRIM/RING FINISH:
WH, BK, SN, CP

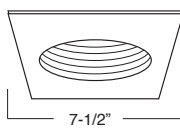

B687CP-WH
SQUARE REFLECTOR TRIM



REFLECTOR FINISH:
CL, RG, W, MB, SN, CP
TRIM/RING FINISH:
WH, BK, SN, CP

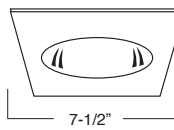

B682WH
SQUARE EYEBALL TRIM



TRIM/RING FINISH:
WH

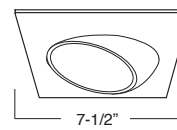

B693WH
SQUARE PAR30 GIMBAL TRIM



TRIM/RING FINISH:
WH

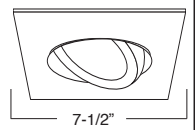

B688WH
SQUARE ALBALITE SHOWER TRIM



LENS:
WHITE
TRIM/RING FINISH:
WH

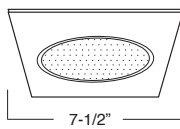

B685WH
SQUARE FRESNEL SHOWER TRIM



LENS:
CLEAR
TRIM/RING FINISH:
WH

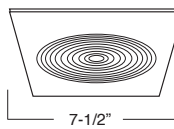

B696WH
SQUARE DROP OIPAL SHOWER TRIM



LENS:
WHITE
TRIM/RING FINISH:
WH

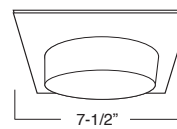

B689WH
SQUARE DESIGNER CONE SHOWER LENS



LENS:
FROSTED
TRIM/RING FINISH:
WH

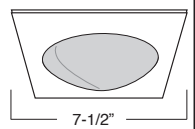

6" Incandescent Trims

(LAMP WATTAGE: (1) MAXIMUM 75W R/PAR30, 60W A19, 65W BR30)

Catalog Number:

Project Name:

Type:

Note:



B680WH
SQUARE DESIGNER POINT LENS



LENS:
FROSTED/CLEAR

TRIM/RING FINISH:
WH

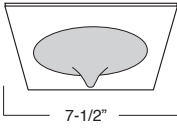

BAFFLE		REFLECTOR		TRIM RING	
W	White	CL	Chrome	WH	White
P	Black	RG	Gold	BK	Black
SN	Satin Nickel	W	White	SN	Satin Nickel
CP	Copper	MB	Black	CP	Copper
BZ	Bronze	CP	Copper	CH	Chrome
		SN	Satin Nickel	PB	Polish Brass
				BZ	Bronze

**For custom baffle, reflector, trim ring, glass color and lens options, please consult factory.*