

B6IC-100

6" Universal 100W IC Housing Double Wall

LAMP WATTAGE: (1) MAX. 75W R/PAR40/PAR38, 75W R/PAR30, 60W A19, 65W BR30



DESIGNED FOR 2" X 8" JOIST CONSTRUCTION

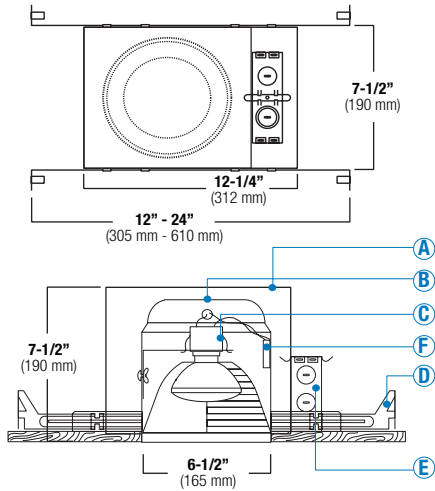

Catalog Number:	
Project Name:	Type:
Note:	



DESCRIPTION

For new construction. Thermally protected, IC rated specification grade recessed housing. Accommodates up to 100W R40, par38, 75W PAR30, R30 lamps, 60W A19 lamps and 65W BR30 lamps. Furnished with pre-installed adjustable bar hangers. Junction box is provided with four 1/2" KOs, one 3/4" KO and four Romex knockouts with strain relief.

SPECIFICATION

A. OUTER HOUSING - Die formed aluminum construction for maximum heat dissipating air chamber on top of the housing. Junction box could be accessed from inside and outside housing.

B. INNER HOUSING - Die-formed all aluminum construction for maximum heat dissipation and rust protection. Adjusts vertically in plaster frame to accommodate 1/2" to 1-3/8" ceiling.

C. SOCKET - Medium base screw shell porcelain socket preinstalled on adjustable mounting bracket is designed to allow usage of different lamp types, as well as proper and consistent lamp positioning.

D. BAR HANGERS - Preinstalled bar hangers allow housing to be positioned and locked at any point within a 24" joist span. They can be positioned on either the long or short axis of the housing and can be shortened for 12" joists. They contain a double-headed real nail for 20° downward angle for better contact, and the 90° pivoting mounting plate makes installation fast and accurate. Bar hangers can fit onto T-Bar spline with additional slots and holes for special mounting methods if necessary.

E. JUNCTION BOX - through-branch circuit wiring and has four 1/2" KOs, one 3/4" KO and four Romex knockouts with true pry-out slots and strain clamps.

F. THERMAL PROTECTION - Standard thermal protection device guards against improper installation, overlamping and misuse of insulation material.

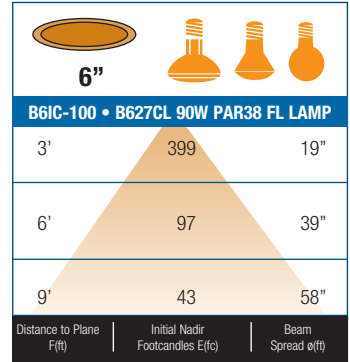

FEATURES

- Thermally Protected IC housing.
- Adjustable socket bracket.
- Wire through junction box.
- Preinstalled adjustable bar hanger.
- Dependable, favorable design and effortless installation.
- 7-1/2" height allows use in 2" x 8" joist construction.
- Special screw on the frame locks bar hangers in place which prevents the housing from any movement once installed.
- Preinstalled socket cap provides electrical contact protection against dust, paint and over spray.

OPTIONS

AIR-SHUT

- Gasket to prevent air flow from heated or air conditioned spaces.
- Meets all national air flow requirements.

ITEM SELECTOR: (Please check the boxes below for the option desired)

TYPE	AIR-SHUT	OPTION	TRIM TYPE	BAFFLE	REFLECTOR	TRIM/RING	GLASS
B6IC-100	<input type="checkbox"/> AT	<input type="checkbox"/> (W) With quick connects	<input type="checkbox"/> B630 <input type="checkbox"/> B608 <input type="checkbox"/> B601 <input type="checkbox"/> B637 <input type="checkbox"/> B615 <input type="checkbox"/> B622 <input type="checkbox"/> B689	<input type="checkbox"/> W <input type="checkbox"/> CL	<input type="checkbox"/> WH	<input type="checkbox"/> Green	
			<input type="checkbox"/> B640 <input type="checkbox"/> B602 <input type="checkbox"/> B601L <input type="checkbox"/> B643 <input type="checkbox"/> B633 <input type="checkbox"/> B623 <input type="checkbox"/> B680	<input type="checkbox"/> P <input type="checkbox"/> RG	<input type="checkbox"/> BK	<input type="checkbox"/> Yellow	
			<input type="checkbox"/> B620 <input type="checkbox"/> B609 <input type="checkbox"/> B605 <input type="checkbox"/> B658 <input type="checkbox"/> B634 <input type="checkbox"/> B625	<input type="checkbox"/> SN <input type="checkbox"/> W	<input type="checkbox"/> SN	<input type="checkbox"/> Pink	
			<input type="checkbox"/> B631 <input type="checkbox"/> B619 <input type="checkbox"/> B605L <input type="checkbox"/> B659 <input type="checkbox"/> B649 <input type="checkbox"/> B624	<input type="checkbox"/> CP <input type="checkbox"/> MB	<input type="checkbox"/> CP	<input type="checkbox"/> Brown	
			<input type="checkbox"/> B632 <input type="checkbox"/> B646 <input type="checkbox"/> B606 <input type="checkbox"/> B675 <input type="checkbox"/> AF633 <input type="checkbox"/> B681	<input type="checkbox"/> BZ <input type="checkbox"/> BZ	<input type="checkbox"/> CH	<input type="checkbox"/> Navy Blue	
			<input type="checkbox"/> AF637 <input type="checkbox"/> B616 <input type="checkbox"/> B606L <input type="checkbox"/> B676 <input type="checkbox"/> B225 <input type="checkbox"/> B687	<input type="checkbox"/> CP <input type="checkbox"/> CP	<input type="checkbox"/> PB	<input type="checkbox"/> Orange	
			<input type="checkbox"/> AF631 <input type="checkbox"/> B663 <input type="checkbox"/> B635 <input type="checkbox"/> B612 <input type="checkbox"/> B653 <input type="checkbox"/> B682	<input type="checkbox"/> SN <input type="checkbox"/> SN	<input type="checkbox"/> BZ	<input type="checkbox"/> Blue	
			<input type="checkbox"/> AF639 <input type="checkbox"/> B664 <input type="checkbox"/> B636 <input type="checkbox"/> B645 <input type="checkbox"/> B651 <input type="checkbox"/> B693	<input type="checkbox"/> SHZ <input type="checkbox"/> SHZ		<input type="checkbox"/> White	
			<input type="checkbox"/> AF640 <input type="checkbox"/> B673 <input type="checkbox"/> B641 <input type="checkbox"/> B648 <input type="checkbox"/> B611 <input type="checkbox"/> B694			<input type="checkbox"/> Red	
			<input type="checkbox"/> B610 <input type="checkbox"/> B674 <input type="checkbox"/> B642 <input type="checkbox"/> B652 <input type="checkbox"/> B647 <input type="checkbox"/> B688				
			<input type="checkbox"/> B607 <input type="checkbox"/> B683 <input type="checkbox"/> B656 <input type="checkbox"/> B603 <input type="checkbox"/> B644 <input type="checkbox"/> B685				
			<input type="checkbox"/> B627 <input type="checkbox"/> B684 <input type="checkbox"/> B657 <input type="checkbox"/> B604 <input type="checkbox"/> B650 <input type="checkbox"/> B696				

Specifications:

B6IC-100

AIR-SHUT OPTION TRIM TYPE BAFFLE REFLECTOR TRIM/RING GLASS

BAFFLE	REFLECTOR	TRIM/RING
W White	CL Chrome	WH White
P Black	RG Gold	BK Black
SN Satin Nickel	W White	SN Satin Nickel
CP Copper	MB Black	CP Copper
BZ Bronze	BZ Bronze	CH Chrome
	CP Copper	PB Polish Brass
	SN Satin Nickel	BZ Bronze
	SHZ Satin Haze	

Sample of Catalog Number: **B6IC-100-AT-W-B630-W-WH**

*For custom baffle, reflector, trim ring, glass color and lens options, please consult factory.



Submittal form is available @ www.iuseelite.com
Tel: 323-888-1973 • Fax: 323-888-1977

Specifications and Dimensions subject to change without notice.

REV: ELITE LIGHTING-SPEC-06-29-2011

6" Incandescent Trims

(LAMP WATTAGE: (1) MAX. 75W R/PAR40/PAR38, 75W R/PAR30, 60W A19, 65W BR30)

Catalog Number:

Project Name:

Type:

Note:



<p>B630CP-CP METAL STEPPED BAFFLE R30/PAR30</p>   <p>BAFFLE FINISH: W, P, SN, CP, BZ</p> <p>TRIM/RING FINISH: WH, BK, SN, CP, CH, PB, BZ</p> <p>7-1/4"</p>	<p>B640SN-SN METAL STEPPED BAFFLE R40/PAR38</p>   <p>BAFFLE FINISH: W, P, SN, CP, BZ</p> <p>TRIM/RING FINISH: WH, BK, SN, CP, CH, PB, BZ</p> <p>7-1/4"</p>	<p>B620-ORANGE GLASS TRIM</p>   <p>GLASS FINISH: GREEN, YELLOW, PINK, BROWN, NAVY BLUE, ORANGE, WHITE, RED</p> <p>7-1/4"</p>	<p>B631P-WH R30 PREMIUM PHENOLIC BAFFLE / METAL RING</p>   <p>BAFFLE FINISH: W, P</p> <p>TRIM/RING FINISH: WH, BK, SN, CP, CH, PB, BZ</p> <p>7-1/4"</p>
<p>B632W-WH R40 PREMIUM PHENOLIC BAFFLE / METAL RING</p>   <p>BAFFLE FINISH: W, P</p> <p>TRIM/RING FINISH: WH, BK, SN, CP, CH, PB, BZ</p> <p>7-1/4"</p>	<p>AF637W-WH SELF FLANGE AIR-SHUT BAFFLE</p>   <p>AVAILABLE COLOR COMBINATIONS: W-WH, P-WH, P-BK, SN-SN, CP-CP, BZ-BZ</p> <p>7-1/4"</p>	<p>AF631W-WH SELF FLANGE AIR-SHUT BAFFLE</p>   <p>AVAILABLE COLOR COMBINATIONS: W-WH, P-WH, P-BK, SN-SN, CP-CP, BZ-BZ</p> <p>7-1/4"</p>	<p>AF639W-WH SELF FLANGE AIR-SHUT BAFFLE</p>   <p>AVAILABLE COLOR COMBINATIONS: W-WH</p> <p>MATT WHITE FINISH</p> <p>7-1/4"</p>
<p>AF640W-WH DEEP SELF FLANGE AIR-SHUT BAFFLE</p>   <p>AVAILABLE COLOR COMBINATIONS: W-WH, P-WH, SN-SN, CP-CP, BZ-BZ</p> <p>7-1/4"</p>	<p>B610P-RG-WH CONE REFLECTOR/BAFFLE TRIM</p>   <p>BAFFLE FINISH: W, P</p> <p>REFLECTOR FINISH: CL, RG</p> <p>TRIM/RING FINISH: WH, BK, SN, CP, CH, PB, BZ</p> <p>7-1/4"</p>	<p>B607CP-WH REFLECTOR R/PAR30</p>   <p>REFLECTOR FINISH: CL, RG, W, MB, CP, SN, BZ, SHZ</p> <p>TRIM/RING FINISH: WH, BK, SN, CP, CH, PB, BZ</p> <p>7-1/4"</p>	<p>B627RG-WH REFLECTOR R40/PAR38</p>   <p>REFLECTOR FINISH: CL, RG, W, MB, CP, SN, BZ, SHZ</p> <p>TRIM/RING FINISH: WH, BK, SN, CP, CH, PB, BZ</p> <p>7-1/4"</p>
<p>B608CL-WH CONE REFLECTOR A19</p>   <p>REFLECTOR FINISH: CL, RG, W, MB, CP, SN, BZ, SHZ</p> <p>TRIM/RING FINISH: WH, BK, SN, CP, CH, PB, BZ</p> <p>7-1/4"</p>	<p>B602SN EYEBALL</p>   <p>TRIM/RING FINISH: WH, BK, SN, CP, CH, PB, BZ</p> <p>8" 30° TILT 359° ROTATION</p>	<p>B609W-WH REGRESSED EYEBALL WITH BAFFLE</p>   <p>BAFFLE FINISH: W, P, SN, CP, BZ</p> <p>TRIM/RING FINISH: WH, BK, SN, CP, CH, PB, BZ</p> <p>EYEBALL FINISH: WH, BK, SN, CP, CH, PB, BZ</p> <p>7-1/4" 30° TILT 359° ROTATION</p>	<p>B619RG-PB REGRESSED EYEBALL WITH REFLECTOR</p>   <p>REFLECTOR FINISH: CL, RG, W, MB, CP, SN</p> <p>TRIM/RING FINISH: WH, BK, SN, CP, CH, PB, BZ</p> <p>EYEBALL FINISH: WH, BK, SN, CP, CH, PB, BZ</p> <p>7-1/4" 30° TILT 359° ROTATION</p>

6" Incandescent Trims

(LAMP WATTAGE: (1) MAX. 75W R/PAR40/PAR38, 75W R/PAR30, 60W A19, 65W BR30)











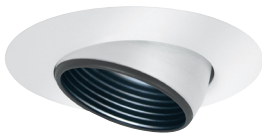
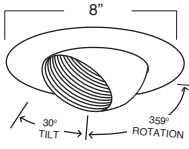
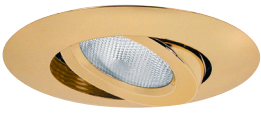
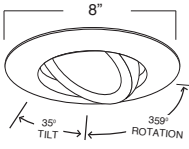
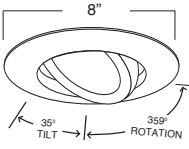
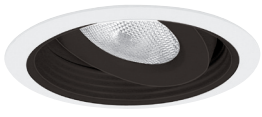

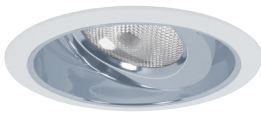
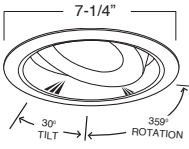

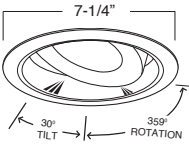

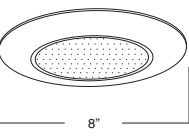

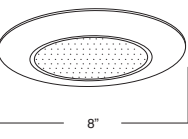
Catalog Number:

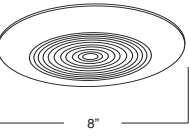
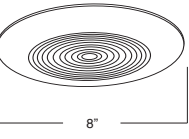
Project Name:

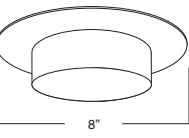
Type:

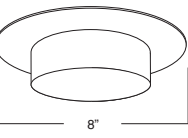
Note:

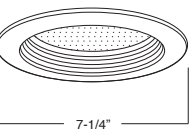

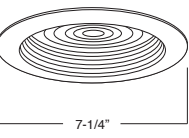
<p>B646P-WH EYEBALL WITH BAFFLE</p>  <p>BAFFLE FINISH: W, P</p> <p>TRIM/RING FINISH: WH</p> 	<p>B616W-WH PAR20 REGRESSED EYEBALL W/ BAFFLE</p>  <p>BAFFLE FINISH: W, P, SN, CP, BZ</p> <p>TRIM/RING FINISH: WH, BK, SN, CP, CH, PB, BZ</p> <p>EYEBALL FINISH: WH, BK, SN, CP, CH, PB, BZ</p> 	<p>B663PB PAR30 GIMBAL RING</p>  <p>TRIM/RING FINISH: WH, BK, SN, CP, CH, PB, BZ</p> 	<p>B664CP PAR38 GIMBAL RING</p>  <p>TRIM/RING FINISH: WH, BK, SN, CP, CH, PB, BZ</p> 
<p>B673P-WH PAR30 BAFFLE W/ GIMBAL RING</p>  <p>BAFFLE FINISH: W, P, SN, CP, BZ</p> <p>TRIM/RING FINISH: WH, BK, SN, CP, CH, PB, BZ</p> 	<p>B674W-WH PAR38 BAFFLE W/ GIMBAL RING</p>  <p>BAFFLE FINISH: W, P, SN, CP, BZ</p> <p>TRIM/RING FINISH: WH, BK, SN, CP, CH, PB, BZ</p> 	<p>B683CL-WH PAR30 REFLECTOR W/ GIMBAL RING</p>  <p>REFLECTOR FINISH: CL, RG, W, MB, CP, SN</p> <p>TRIM/RING FINISH: WH, BK, SN, CP, CH, PB, BZ</p> 	<p>B684RG-WH PAR38 REFLECTOR W/ GIMBAL RING</p>  <p>REFLECTOR FINISH: CL, RG, W, MB, CP, SN</p> <p>TRIM/RING FINISH: WH, BK, SN, CP, CH, PB, BZ</p> 
<p>B601CP METAL ALBALITE LENS</p>  <p>LENS: ALBALITE</p> <p>TRIM/RING FINISH: WH, BK, SN, CP, CH, PB, BZ</p> 	<p>B601L PLASTIC ALBALITE LENS</p>  <p>LENS: ALBALITE</p> <p>TRIM/RING FINISH: WHITE PLASTIC</p> 	<p>B605PB METAL FRESNEL LENS</p>  <p>LENS: FRESNEL</p> <p>TRIM/RING FINISH: WH, BK, SN, CP, CH, PB, BZ</p> 	<p>B605L PLASTIC FRESNEL LENS</p>  <p>LENS: FRESNEL</p> <p>TRIM/RING FINISH: WHITE PLASTIC</p> 
<p>B606CP METAL DROP OPAL LENS</p>  <p>LENS: DROP OPAL</p> <p>TRIM/RING FINISH: WH, BK, SN, CP, CH, PB, BZ</p> 	<p>B606L PLASTIC DROP OPAL LENS</p>  <p>LENS: DROP OPAL</p> <p>TRIM/RING FINISH: WHITE PLASTIC</p> 	<p>B635P-WH BAFFLE W/ ALBALITE LENS</p>  <p>BAFFLE FINISH: W, P, SN, CP, BZ</p> <p>TRIM/RING FINISH: WH, BK, SN, CP, CH, PB, BZ</p> 	<p>B636W-WH BAFFLE W/ FRESNEL LENS</p>  <p>BAFFLE FINISH: W, P, SN, CP, BZ</p> <p>TRIM/RING FINISH: WH, BK, SN, CP, CH, PB, BZ</p> 

6" Incandescent Trims

(LAMP WATTAGE: (1) MAX. 75W R/PAR40/PAR38, 75W R/PAR30, 60W A19, 65W BR30)

Catalog Number:

Project Name:

Type:

Note:



<p>B641RG-WH REFLECTOR W/ ALBALITE LENS</p>    <p>REFLECTOR FINISH: CL, RG, W, MB, CP, SN, SHZ</p> <p>TRIM/RING FINISH: WH, BK, SN, CP, CH, PB, BZ</p>	<p>B642CL-WH REFLECTOR W/ FRESNEL LENS</p>    <p>REFLECTOR FINISH: CL, RG, W, MB, CP, SN, SHZ</p> <p>TRIM/RING FINISH: WH, BK, SN, CP, CH, PB, BZ</p>	<p>B656W-WH BAFFLE W/ FROSTED DOME SHOWER LENS</p>    <p>BAFFLE FINISH: W, P, SN, CP, BZ</p> <p>TRIM/RING FINISH: WH, BK, SN, CP, CH, PB, BZ</p>	<p>B657CL-WH REFLECTOR W/ FROSTED DOME SHOWER LENS</p>    <p>REFLECTOR FINISH: CL, RG, W, MB, CP, SN, SHZ</p> <p>TRIM/RING FINISH: WH, BK, SN, CP, CH, PB, BZ</p>
<p>B637W-WH BAFFLE W/ DROP OPAL LENS</p>    <p>BAFFLE FINISH: W, P, SN, CP, BZ</p> <p>TRIM/RING FINISH: WH, BK, SN, CP, CH, PB, BZ</p>	<p>B643RG-WH REFLECTOR W/ DROP OPAL LENS</p>    <p>REFLECTOR FINISH: CL, RG, W, MB, CP, SN, SHZ</p> <p>TRIM/RING FINISH: WH, BK, SN, CP, CH, PB, BZ</p>	<p>B658CL-WH REFLECTOR W/ PRISMATIC LENS</p>    <p>REFLECTOR FINISH: CL, RG, W, MB, CP, SN, SHZ</p> <p>TRIM/RING FINISH: WH, BK, SN, CP, CH, PB, BZ</p>	<p>B659CL-WH REFLECTOR W/ FROSTED LENS</p>    <p>REFLECTOR FINISH: CL, RG, W, MB, CP, SN, SHZ</p> <p>TRIM/RING FINISH: WH, BK, SN, CP, CH, PB, BZ</p>
<p>B675W-WH BAFFLE W/ PRISMATIC LENS</p>    <p>BAFFLE FINISH: W, P, SN, CP, BZ</p> <p>TRIM/RING FINISH: WH, BK, SN, CP, CH, PB, BZ</p>	<p>B676W-WH BAFFLE W/ FROSTED LENS</p>    <p>BAFFLE FINISH: W, P, SN, CP, BZ</p> <p>TRIM/RING FINISH: WH, BK, SN, CP, CH, PB, BZ</p>	<p>B612WH SMOOTH FROST DOME SHOWER LENS</p>    <p>LENS: FROSTED</p> <p>TRIM/RING FINISH: WH, BK, SN, CP, CH, PB, BZ</p>	<p>B645WH DESIGNER POINT SHOWER LENS</p>    <p>LENS: FROSTED/CLEAR</p> <p>TRIM/RING FINISH: WH, BK, SN, CP, CH, PB, BZ</p>
<p>B648WH DESIGNER CONE SHOWER LENS</p>    <p>LENS: FROSTED</p> <p>TRIM/RING FINISH: WH, BK, SN, CP, CH, PB, BZ</p>	<p>B652WH SMOOTH FROST SHOWER LENS</p>    <p>LENS: FROSTED</p> <p>TRIM/RING FINISH: WH, BK, SN, CP, CH, PB, BZ</p>	<p>B603CP R/PAR30 OPEN TRIM</p>    <p>TRIM/RING FINISH: WH, BK, SN, CP, CH, PB, BZ</p>	<p>B604PB R40/PAR38 OPEN TRIM</p>    <p>TRIM/RING FINISH: WH, BK, SN, CP, CH, PB, BZ</p>

6" Incandescent Trims

(LAMP WATTAGE: (1) MAX. 75W R/PAR40/PAR38, 75W R/PAR30, 60W A19, 65W BR30)

Catalog Number:

Project Name:

Type:

Note:



<p>B615WH DESIGNER PINHOLE</p> <p>TRIM/RING FINISH: WH, BK</p>	<p>B633WH R/PAR30 SPLAY TRIM</p> <p>TRIM/RING FINISH: WH, BK</p>	<p>B634WH R40/PAR38 SPLAY TRIM</p> <p>TRIM/RING FINISH: WH, BK</p>	<p>B649RG-WH PAR20 REFLECTOR</p> <p>REFLECTOR FINISH: CL, RG, W, MB, CP, SN</p> <p>TRIM/RING FINISH: WH, BK</p>
<p>AF633CH R/PAR30 OPEN TRIM</p> <p>TRIM/RING FINISH: WH, BK, SN, CP, CH, PB, BZ</p>	<p>B225WH OPEN TRIM STEPPED BAFFLE</p> <p>BAFFLE FINISH: W, P</p> <p>TRIM/RING FINISH: WH</p>	<p>B653W-WH BAFFLE WITH BAFFLE</p> <p>BAFFLE FINISH: W, P</p> <p>TRIM/RING FINISH: WH, BK, SN, CP, CH, PB</p>	<p>B651P-WH PAR20 STEPPED BAFFLE</p> <p>BAFFLE FINISH: W, P, SN, CP, BZ</p> <p>TRIM/RING FINISH: WH, BK</p>
<p>B611W-WH PAR30 BAFFLE WALL WASH</p> <p>AVAILABLE COLOR COMBINATIONS: W-WH, P-WH, SN-SN, CP-CP, BZ-BZ</p> <p>COVER FINISH: WH, BK</p>	<p>B647P-WH DESIGNER BAFFLE WALL WASH PAR20</p> <p>BAFFLE FINISH: W, P, SN, CP, BZ</p> <p>TRIM/RING FINISH: WH</p>	<p>B644RG-WH DESIGNER REFLECTOR WALL WASH PAR20</p> <p>REFLECTOR FINISH: CL, RG, W, MB, CP, SN</p> <p>TRIM/RING FINISH: WH</p>	<p>B650WH DESIGNER WALL WASH</p> <p>TRIM/RING FINISH: WH</p>
<p>B622RG-WH R/PAR30 WALL WASH REFLECTOR</p> <p>REFLECTOR FINISH: CL, RG, W, MB, CP, SN, SHZ</p> <p>COVER FINISH: WH</p> <p>TRIM/RING FINISH: WH, BK, SN, CP, CH, PB, BZ</p>	<p>B623MB-WH R40/PAR38 WALL WASH REFLECTOR</p> <p>REFLECTOR FINISH: CL, RG, W, MB, CP, SN, SHZ</p> <p>COVER FINISH: WH</p> <p>TRIM/RING FINISH: WH, BK, SN, CP, CH, PB, BZ</p>	<p>B625CL-WH A-19 CONE REFLECTOR WALL WASH</p> <p>REFLECTOR FINISH: CL, RG, W, MB, CP, SN, SHZ</p> <p>COVER FINISH: WH</p> <p>TRIM/RING FINISH: WH, BK, SN, CP, CH, PB, BZ</p>	<p>B624W-CL CONE REFLECTOR BAFFLE WALL WASH</p> <p>BAFFLE FINISH: W, P</p> <p>REFLECTOR FINISH: CL, RG</p> <p>COVER FINISH: WH</p> <p>TRIM/RING FINISH: WH, BK, SN, CP, CH, PB, BZ</p>

6" Incandescent Trims

(LAMP WATTAGE: (1) MAX. 75W R/PAR40/PAR38, 75W R/PAR30, 60W A19, 65W BR30)

Catalog Number:

Project Name:

Type:

Note:



B681CP-WH
SQUARE BAFFLE TRIM

BAFFLE FINISH:
W, P, SN, CP, BZ

TRIM/RING FINISH:
WH, BK, SN, CP

B687CP-WH
SQUARE REFLECTOR TRIM

REFLECTOR FINISH:
CL, RG, W, MB, SN, CP

TRIM/RING FINISH:
WH, BK, SN, CP

B682WH
SQUARE EYEBALL TRIM

TRIM/RING FINISH:
WH

B693WH
SQUARE PAR30 GIMBAL TRIM

TRIM/RING FINISH:
WH

B694WH
SQUARE PAR38 GIMBAL TRIM

TRIM/RING FINISH:
WH

B688WH
SQUARE ALBALITE SHOWER TRIM

LENS:
WHITE

TRIM/RING FINISH:
WH

B685WH
SQUARE FRESNEL SHOWER TRIM

LENS:
CLEAR

TRIM/RING FINISH:
WH

B696WH
SQUARE DROP OIPAL SHOWER TRIM

LENS:
WHITE

TRIM/RING FINISH:
WH

B689WH
SQUARE DESIGNER CONE SHOWER LENS

LENS:
FROSTED

TRIM/RING FINISH:
WH

B680WH
SQUARE DESIGNER POINT LENS

LENS:
FROSTED/CLEAR

TRIM/RING FINISH:
WH

BAFFLE	REFLECTOR	TRIM RING
W White	CL Chrome	WH White
P Black	RG Gold	BK Black
SN Satin Nickel	W White	SN Satin Nickel
CP Copper	MB Black	CP Copper
BZ Bronze	CP Copper	CH Chrome
	SN Satin Nickel	PB Polish Brass
		BZ Bronze

*For custom baffle, reflector, trim ring, glass color and lens options, please consult factory.

B6IC-100

6" Universal 100W IC Housing Double Wall

LAMP WATTAGE: (1) MAX. 75W R/PAR40/PAR38, 75W R/PAR30, 60W A19, 65W BR30



DESIGNED FOR 2" X 8" JOIST CONSTRUCTION

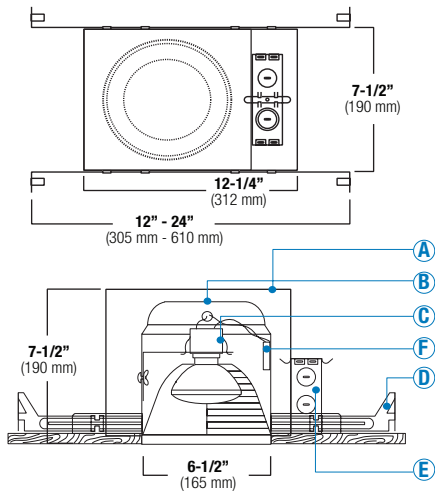

Catalog Number:

Project Name:

Type:

Note:



DESCRIPTION

For new construction. Thermally protected, IC rated specification grade recessed housing. Accommodates up to 100W R40, par38, 75W PAR30, R30 lamps, 60W A19 lamps and 65W BR30 lamps. Furnished with pre-installed adjustable bar hangers. Junction box is provided with four 1/2" KOs, one 3/4" KO and four Romex knockouts with strain relief.

SPECIFICATION

A. OUTER HOUSING - Die formed aluminum construction for maximum heat dissipating air chamber on top of the housing. Junction box could be accessed from inside and outside housing.

B. INNER HOUSING - Die-formed all aluminum construction for maximum heat dissipation and rust protection. Adjusts vertically in plaster frame to accommodate 1/2" to 1-3/8" ceiling.

C. SOCKET - Medium base screw shell porcelain socket preinstalled on adjustable mounting bracket is designed to allow usage of different lamp types, as well as proper and consistent lamp positioning.

D. BAR HANGERS - Preinstalled bar hangers allow housing to be positioned and locked at any point within a 24" joist span. They can be positioned on either the long or short axis of the housing and can be shortened for 12" joists. They contain a double-headed real nail for 20° downward angle for better contact, and the 90° pivoting mounting plate makes installation fast and accurate. Bar hangers can fit onto T-Bar spline with additional slots and holes for special mounting methods if necessary.

E. JUNCTION BOX - through-branch circuit wiring and has four 1/2" KOs, one 3/4" KO and four Romex knockouts with true pry-out slots and strain clamps.

F. THERMAL PROTECTION - Standard thermal protection device guards against improper installation, overlamping and misuse of insulation material.

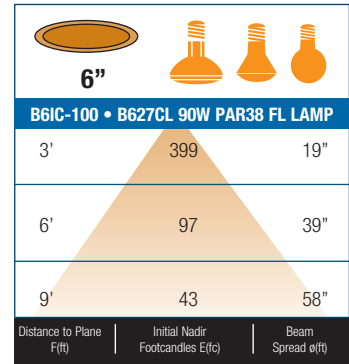

BEAM DIA. MEASURED AT 50% OF NADIR F.C.

FEATURES

- Thermally Protected IC housing.
- Adjustable socket bracket.
- Wire through junction box.
- Preinstalled adjustable bar hanger.
- Dependable, favorable design and effortless installation.
- 7-1/2" height allows use in 2" x 8" joist construction.
- Special screw on the frame locks bar hangers in place which prevents the housing from any movement once installed.
- Preinstalled socket cap provides electrical contact protection against dust, paint and over spray.

OPTIONS

AIR-SHUT

- Gasket to prevent air flow from heated or air conditioned spaces.
- Meets all national air flow requirements.

ITEM SELECTOR: (Please check the boxes below for the option desired)

TYPE	AIR-SHUT	OPTION	TRIM TYPE	BAFFLE	REFLECTOR	TRIM/RING	GLASS						
B6IC-100	<input type="checkbox"/> AT	<input type="checkbox"/> (W) With quick connects	<input type="checkbox"/> B630	<input type="checkbox"/> B608	<input type="checkbox"/> B601	<input type="checkbox"/> B637	<input type="checkbox"/> B615	<input type="checkbox"/> B622	<input type="checkbox"/> B689	<input type="checkbox"/> W	<input type="checkbox"/> CL	<input type="checkbox"/> WH	<input type="checkbox"/> Green
			<input type="checkbox"/> B640	<input type="checkbox"/> B602	<input type="checkbox"/> B601L	<input type="checkbox"/> B643	<input type="checkbox"/> B633	<input type="checkbox"/> B623	<input type="checkbox"/> B680	<input type="checkbox"/> P	<input type="checkbox"/> RG	<input type="checkbox"/> BK	<input type="checkbox"/> Yellow
			<input type="checkbox"/> B620	<input type="checkbox"/> B609	<input type="checkbox"/> B605	<input type="checkbox"/> B658	<input type="checkbox"/> B634	<input type="checkbox"/> B625		<input type="checkbox"/> SN	<input type="checkbox"/> W	<input type="checkbox"/> SN	<input type="checkbox"/> Pink
			<input type="checkbox"/> B631	<input type="checkbox"/> B619	<input type="checkbox"/> B605L	<input type="checkbox"/> B659	<input type="checkbox"/> B649	<input type="checkbox"/> B624		<input type="checkbox"/> CP	<input type="checkbox"/> MB	<input type="checkbox"/> CP	<input type="checkbox"/> Brown
			<input type="checkbox"/> B632	<input type="checkbox"/> B646	<input type="checkbox"/> B606	<input type="checkbox"/> B675	<input type="checkbox"/> AF633	<input type="checkbox"/> B681		<input type="checkbox"/> BZ	<input type="checkbox"/> BZ	<input type="checkbox"/> CH	<input type="checkbox"/> Navy Blue
			<input type="checkbox"/> AF637	<input type="checkbox"/> B616	<input type="checkbox"/> B606L	<input type="checkbox"/> B676	<input type="checkbox"/> B225	<input type="checkbox"/> B687			<input type="checkbox"/> CP	<input type="checkbox"/> PB	<input type="checkbox"/> Orange
			<input type="checkbox"/> AF631	<input type="checkbox"/> B663	<input type="checkbox"/> B635	<input type="checkbox"/> B612	<input type="checkbox"/> B653	<input type="checkbox"/> B682			<input type="checkbox"/> SN	<input type="checkbox"/> BZ	<input type="checkbox"/> Blue
			<input type="checkbox"/> AF639	<input type="checkbox"/> B664	<input type="checkbox"/> B636	<input type="checkbox"/> B645	<input type="checkbox"/> B651	<input type="checkbox"/> B693			<input type="checkbox"/> SHZ		<input type="checkbox"/> White
			<input type="checkbox"/> AF640	<input type="checkbox"/> B673	<input type="checkbox"/> B641	<input type="checkbox"/> B648	<input type="checkbox"/> B611	<input type="checkbox"/> B694					<input type="checkbox"/> Red
			<input type="checkbox"/> B610	<input type="checkbox"/> B674	<input type="checkbox"/> B642	<input type="checkbox"/> B652	<input type="checkbox"/> B647	<input type="checkbox"/> B688					
			<input type="checkbox"/> B607	<input type="checkbox"/> B683	<input type="checkbox"/> B656	<input type="checkbox"/> B603	<input type="checkbox"/> B644	<input type="checkbox"/> B685					
			<input type="checkbox"/> B627	<input type="checkbox"/> B684	<input type="checkbox"/> B657	<input type="checkbox"/> B604	<input type="checkbox"/> B650	<input type="checkbox"/> B696					

Specifications:

B6IC-100

AIR-SHUT OPTION TRIM TYPE BAFFLE REFLECTOR TRIM/RING GLASS

BAFFLE	REFLECTOR	TRIM/RING
W White	CL Chrome	WH White
P Black	RG Gold	BK Black
SN Satin Nickel	W White	SN Satin Nickel
CP Copper	MB Black	CP Copper
BZ Bronze	BZ Bronze	CH Chrome
	CP Copper	PB Polish Brass
	SN Satin Nickel	BZ Bronze
	SHZ Satin Haze	

Sample of Catalog Number: B6IC-100-AT-W-B630-W-WH

*For custom baffle, reflector, trim ring, glass color and lens options, please consult factory.



Submittal form is available @ www.iuseelite.com
Tel: 323-888-1973 • Fax: 323-888-1977

Specifications and Dimensions subject to change without notice.

REV: ELITE LIGHTING-SPEC-06-29-2011

6" Incandescent Trims

(LAMP WATTAGE: (1) MAX. 75W R/PAR40/PAR38, 75W R/PAR30, 60W A19, 65W BR30)

Catalog Number:

Project Name:

Type:

Note:



<p>B630CP-CP METAL STEPPED BAFFLE R30/PAR30</p>   <p>BAFFLE FINISH: W, P, SN, CP, BZ</p> <p>TRIM/RING FINISH: WH, BK, SN, CP, CH, PB, BZ</p> <p>7-1/4"</p>	<p>B640SN-SN METAL STEPPED BAFFLE R40/PAR38</p>   <p>BAFFLE FINISH: W, P, SN, CP, BZ</p> <p>TRIM/RING FINISH: WH, BK, SN, CP, CH, PB, BZ</p> <p>7-1/4"</p>	<p>B620-ORANGE GLASS TRIM</p>   <p>GLASS FINISH: GREEN, YELLOW, PINK, BROWN, NAVY BLUE, ORANGE, WHITE, RED</p> <p>7-1/4"</p>	<p>B631P-WH R30 PREMIUM PHENOLIC BAFFLE / METAL RING</p>   <p>BAFFLE FINISH: W, P</p> <p>TRIM/RING FINISH: WH, BK, SN, CP, CH, PB, BZ</p> <p>7-1/4"</p>
<p>B632W-WH R40 PREMIUM PHENOLIC BAFFLE / METAL RING</p>   <p>BAFFLE FINISH: W, P</p> <p>TRIM/RING FINISH: WH, BK, SN, CP, CH, PB, BZ</p> <p>7-1/4"</p>	<p>AF637W-WH SELF FLANGE AIR-SHUT BAFFLE</p>   <p>AVAILABLE COLOR COMBINATIONS: W-WH, P-WH, P-BK, SN-SN, CP-CP, BZ-BZ</p> <p>7-1/4"</p>	<p>AF631W-WH SELF FLANGE AIR-SHUT BAFFLE</p>   <p>AVAILABLE COLOR COMBINATIONS: W-WH, P-WH, P-BK, SN-SN, CP-CP, BZ-BZ</p> <p>7-1/4"</p>	<p>AF639W-WH SELF FLANGE AIR-SHUT BAFFLE</p>   <p>AVAILABLE COLOR COMBINATIONS: W-WH</p> <p>MATT WHITE FINISH</p> <p>7-1/4"</p>
<p>AF640W-WH DEEP SELF FLANGE AIR-SHUT BAFFLE</p>   <p>AVAILABLE COLOR COMBINATIONS: W-WH, P-WH, SN-SN, CP-CP, BZ-BZ</p> <p>7-1/4"</p>	<p>B610P-RG-WH CONE REFLECTOR/BAFFLE TRIM</p>   <p>BAFFLE FINISH: W, P</p> <p>REFLECTOR FINISH: CL, RG</p> <p>TRIM/RING FINISH: WH, BK, SN, CP, CH, PB, BZ</p> <p>7-1/4"</p>	<p>B607CP-WH REFLECTOR R/PAR30</p>   <p>REFLECTOR FINISH: CL, RG, W, MB, CP, SN, BZ, SHZ</p> <p>TRIM/RING FINISH: WH, BK, SN, CP, CH, PB, BZ</p> <p>7-1/4"</p>	<p>B627RG-WH REFLECTOR R40/PAR38</p>   <p>REFLECTOR FINISH: CL, RG, W, MB, CP, SN, BZ, SHZ</p> <p>TRIM/RING FINISH: WH, BK, SN, CP, CH, PB, BZ</p> <p>7-1/4"</p>
<p>B608CL-WH CONE REFLECTOR A19</p>   <p>REFLECTOR FINISH: CL, RG, W, MB, CP, SN, BZ, SHZ</p> <p>TRIM/RING FINISH: WH, BK, SN, CP, CH, PB, BZ</p> <p>7-1/4"</p>	<p>B602SN EYEBALL</p>   <p>TRIM/RING FINISH: WH, BK, SN, CP, CH, PB, BZ</p> <p>8" 30° TILT 359° ROTATION</p>	<p>B609W-WH REGRESSED EYEBALL WITH BAFFLE</p>   <p>BAFFLE FINISH: W, P, SN, CP, BZ</p> <p>TRIM/RING FINISH: WH, BK, SN, CP, CH, PB, BZ</p> <p>EYEBALL FINISH: WH, BK, SN, CP, CH, PB, BZ</p> <p>7-1/4" 30° TILT 359° ROTATION</p>	<p>B619RG-PB REGRESSED EYEBALL WITH REFLECTOR</p>   <p>REFLECTOR FINISH: CL, RG, W, MB, CP, SN</p> <p>TRIM/RING FINISH: WH, BK, SN, CP, CH, PB, BZ</p> <p>EYEBALL FINISH: WH, BK, SN, CP, CH, PB, BZ</p> <p>7-1/4" 30° TILT 359° ROTATION</p>

6" Incandescent Trims

(LAMP WATTAGE: (1) MAX. 75W R/PAR40/PAR38, 75W R/PAR30, 60W A19, 65W BR30)











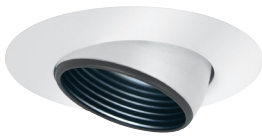
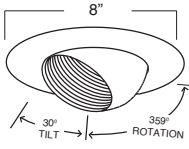

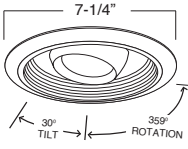
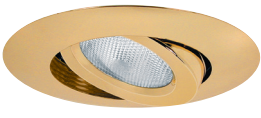
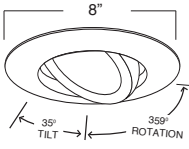
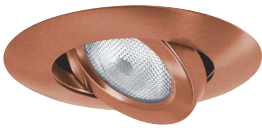
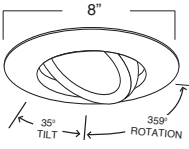
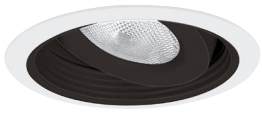
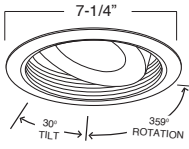

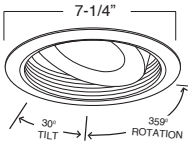
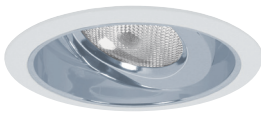
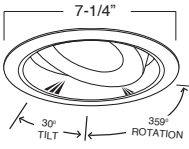

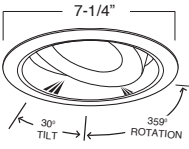

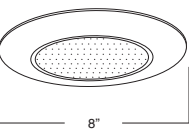

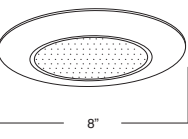

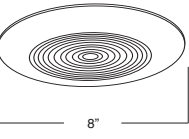
Catalog Number:

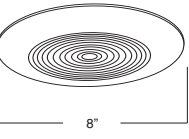
Project Name:

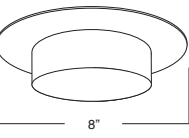
Type:

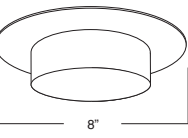
Note:

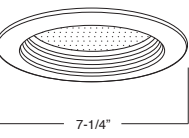

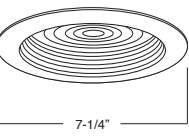
<p>B646P-WH EYEBALL WITH BAFFLE</p>  <p>BAFFLE FINISH: W, P</p> <p>TRIM/RING FINISH: WH</p> 	<p>B616W-WH PAR20 REGRESSED EYEBALL W/ BAFFLE</p>  <p>BAFFLE FINISH: W, P, SN, CP, BZ</p> <p>TRIM/RING FINISH: WH, BK, SN, CP, CH, PB, BZ</p> <p>EYEBALL FINISH: WH, BK, SN, CP, CH, PB, BZ</p> 	<p>B663PB PAR30 GIMBAL RING</p>  <p>TRIM/RING FINISH: WH, BK, SN, CP, CH, PB, BZ</p> 	<p>B664CP PAR38 GIMBAL RING</p>  <p>TRIM/RING FINISH: WH, BK, SN, CP, CH, PB, BZ</p> 
<p>B673P-WH PAR30 BAFFLE W/ GIMBAL RING</p>  <p>BAFFLE FINISH: W, P, SN, CP, BZ</p> <p>TRIM/RING FINISH: WH, BK, SN, CP, CH, PB, BZ</p> 	<p>B674W-WH PAR38 BAFFLE W/ GIMBAL RING</p>  <p>BAFFLE FINISH: W, P, SN, CP, BZ</p> <p>TRIM/RING FINISH: WH, BK, SN, CP, CH, PB, BZ</p> 	<p>B683CL-WH PAR30 REFLECTOR W/ GIMBAL RING</p>  <p>REFLECTOR FINISH: CL, RG, W, MB, CP, SN</p> <p>TRIM/RING FINISH: WH, BK, SN, CP, CH, PB, BZ</p> 	<p>B684RG-WH PAR38 REFLECTOR W/ GIMBAL RING</p>  <p>REFLECTOR FINISH: CL, RG, W, MB, CP, SN</p> <p>TRIM/RING FINISH: WH, BK, SN, CP, CH, PB, BZ</p> 
<p>B601CP METAL ALBALITE LENS</p>  <p>LENS: ALBALITE</p> <p>TRIM/RING FINISH: WH, BK, SN, CP, CH, PB, BZ</p> 	<p>B601L PLASTIC ALBALITE LENS</p>  <p>LENS: ALBALITE</p> <p>TRIM/RING FINISH: WHITE PLASTIC</p> 	<p>B605PB METAL FRESNEL LENS</p>  <p>LENS: FRESNEL</p> <p>TRIM/RING FINISH: WH, BK, SN, CP, CH, PB, BZ</p> 	<p>B605L PLASTIC FRESNEL LENS</p>  <p>LENS: FRESNEL</p> <p>TRIM/RING FINISH: WHITE PLASTIC</p> 
<p>B606CP METAL DROP OPAL LENS</p>  <p>LENS: DROP OPAL</p> <p>TRIM/RING FINISH: WH, BK, SN, CP, CH, PB, BZ</p> 	<p>B606L PLASTIC DROP OPAL LENS</p>  <p>LENS: DROP OPAL</p> <p>TRIM/RING FINISH: WHITE PLASTIC</p> 	<p>B635P-WH BAFFLE W/ ALBALITE LENS</p>  <p>BAFFLE FINISH: W, P, SN, CP, BZ</p> <p>TRIM/RING FINISH: WH, BK, SN, CP, CH, PB, BZ</p> 	<p>B636W-WH BAFFLE W/ FRESNEL LENS</p>  <p>BAFFLE FINISH: W, P, SN, CP, BZ</p> <p>TRIM/RING FINISH: WH, BK, SN, CP, CH, PB, BZ</p> 

6" Incandescent Trims

(LAMP WATTAGE: (1) MAX. 75W R/PAR40/PAR38, 75W R/PAR30, 60W A19, 65W BR30)

Catalog Number:

Project Name:

Type:

Note:

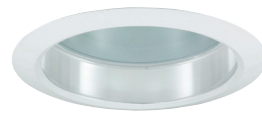
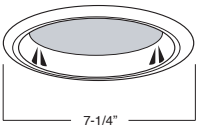

<p>B641RG-WH REFLECTOR W/ ALBALITE LENS</p>    <p>REFLECTOR FINISH: CL, RG, W, MB, CP, SN, SHZ</p> <p>TRIM/RING FINISH: WH, BK, SN, CP, CH, PB, BZ</p>	<p>B642CL-WH REFLECTOR W/ FRESNEL LENS</p>    <p>REFLECTOR FINISH: CL, RG, W, MB, CP, SN, SHZ</p> <p>TRIM/RING FINISH: WH, BK, SN, CP, CH, PB, BZ</p>	<p>B656W-WH BAFFLE W/ FROSTED DOME SHOWER LENS</p>    <p>BAFFLE FINISH: W, P, SN, CP, BZ</p> <p>TRIM/RING FINISH: WH, BK, SN, CP, CH, PB, BZ</p>	<p>B657CL-WH REFLECTOR W/ FROSTED DOME SHOWER LENS</p>    <p>REFLECTOR FINISH: CL, RG, W, MB, CP, SN, SHZ</p> <p>TRIM/RING FINISH: WH, BK, SN, CP, CH, PB, BZ</p>
<p>B637W-WH BAFFLE W/ DROP OPAL LENS</p>    <p>BAFFLE FINISH: W, P, SN, CP, BZ</p> <p>TRIM/RING FINISH: WH, BK, SN, CP, CH, PB, BZ</p>	<p>B643RG-WH REFLECTOR W/ DROP OPAL LENS</p>    <p>REFLECTOR FINISH: CL, RG, W, MB, CP, SN, SHZ</p> <p>TRIM/RING FINISH: WH, BK, SN, CP, CH, PB, BZ</p>	<p>B658CL-WH REFLECTOR W/ PRISMATIC LENS</p>    <p>REFLECTOR FINISH: CL, RG, W, MB, CP, SN, SHZ</p> <p>TRIM/RING FINISH: WH, BK, SN, CP, CH, PB, BZ</p>	<p>B659CL-WH REFLECTOR W/ FROSTED LENS</p>    <p>REFLECTOR FINISH: CL, RG, W, MB, CP, SN, SHZ</p> <p>TRIM/RING FINISH: WH, BK, SN, CP, CH, PB, BZ</p>
<p>B675W-WH BAFFLE W/ PRISMATIC LENS</p>    <p>BAFFLE FINISH: W, P, SN, CP, BZ</p> <p>TRIM/RING FINISH: WH, BK, SN, CP, CH, PB, BZ</p>	<p>B676W-WH BAFFLE W/ FROSTED LENS</p>    <p>BAFFLE FINISH: W, P, SN, CP, BZ</p> <p>TRIM/RING FINISH: WH, BK, SN, CP, CH, PB, BZ</p>	<p>B612WH SMOOTH FROST DOME SHOWER LENS</p>    <p>LENS: FROSTED</p> <p>TRIM/RING FINISH: WH, BK, SN, CP, CH, PB, BZ</p>	<p>B645WH DESIGNER POINT SHOWER LENS</p>    <p>LENS: FROSTED/CLEAR</p> <p>TRIM/RING FINISH: WH, BK, SN, CP, CH, PB, BZ</p>
<p>B648WH DESIGNER CONE SHOWER LENS</p>    <p>LENS: FROSTED</p> <p>TRIM/RING FINISH: WH, BK, SN, CP, CH, PB, BZ</p>	<p>B652WH SMOOTH FROST SHOWER LENS</p>    <p>LENS: FROSTED</p> <p>TRIM/RING FINISH: WH, BK, SN, CP, CH, PB, BZ</p>	<p>B603CP R/PAR30 OPEN TRIM</p>    <p>TRIM/RING FINISH: WH, BK, SN, CP, CH, PB, BZ</p>	<p>B604PB R40/PAR38 OPEN TRIM</p>    <p>TRIM/RING FINISH: WH, BK, SN, CP, CH, PB, BZ</p>

6" Incandescent Trims

(LAMP WATTAGE: (1) MAX. 75W R/PAR40/PAR38, 75W R/PAR30, 60W A19, 65W BR30)

Catalog Number:

Project Name:

Type:

Note:



<p>B615WH DESIGNER PINHOLE</p> <p>TRIM/RING FINISH: WH, BK</p>	<p>B633WH R/PAR30 SPLAY TRIM</p> <p>TRIM/RING FINISH: WH, BK</p>	<p>B634WH R40/PAR38 SPLAY TRIM</p> <p>TRIM/RING FINISH: WH, BK</p>	<p>B649RG-WH PAR20 REFLECTOR</p> <p>REFLECTOR FINISH: CL, RG, W, MB, CP, SN</p> <p>TRIM/RING FINISH: WH, BK</p>
<p>AF633CH R/PAR30 OPEN TRIM</p> <p>TRIM/RING FINISH: WH, BK, SN, CP, CH, PB, BZ</p>	<p>B225WH OPEN TRIM STEPPED BAFFLE</p> <p>BAFFLE FINISH: W, P</p> <p>TRIM/RING FINISH: WH</p>	<p>B653W-WH BAFFLE WITH BAFFLE</p> <p>BAFFLE FINISH: W, P</p> <p>TRIM/RING FINISH: WH, BK, SN, CP, CH, PB</p>	<p>B651P-WH PAR20 STEPPED BAFFLE</p> <p>BAFFLE FINISH: W, P, SN, CP, BZ</p> <p>TRIM/RING FINISH: WH, BK</p>
<p>B611W-WH PAR30 BAFFLE WALL WASH</p> <p>AVAILABLE COLOR COMBINATIONS: W-WH, P-WH, SN-SN, CP-CP, BZ-BZ</p> <p>COVER FINISH: WH, BK</p>	<p>B647P-WH DESIGNER BAFFLE WALL WASH PAR20</p> <p>BAFFLE FINISH: W, P, SN, CP, BZ</p> <p>TRIM/RING FINISH: WH</p>	<p>B644RG-WH DESIGNER REFLECTOR WALL WASH PAR20</p> <p>REFLECTOR FINISH: CL, RG, W, MB, CP, SN</p> <p>TRIM/RING FINISH: WH</p>	<p>B650WH DESIGNER WALL WASH</p> <p>TRIM/RING FINISH: WH</p>
<p>B622RG-WH R/PAR30 WALL WASH REFLECTOR</p> <p>REFLECTOR FINISH: CL, RG, W, MB, CP, SN, SHZ</p> <p>COVER FINISH: WH</p> <p>TRIM/RING FINISH: WH, BK, SN, CP, CH, PB, BZ</p>	<p>B623MB-WH R40/PAR38 WALL WASH REFLECTOR</p> <p>REFLECTOR FINISH: CL, RG, W, MB, CP, SN, SHZ</p> <p>COVER FINISH: WH</p> <p>TRIM/RING FINISH: WH, BK, SN, CP, CH, PB, BZ</p>	<p>B625CL-WH A-19 CONE REFLECTOR WALL WASH</p> <p>REFLECTOR FINISH: CL, RG, W, MB, CP, SN, SHZ</p> <p>COVER FINISH: WH</p> <p>TRIM/RING FINISH: WH, BK, SN, CP, CH, PB, BZ</p>	<p>B624W-CL CONE REFLECTOR BAFFLE WALL WASH</p> <p>BAFFLE FINISH: W, P</p> <p>REFLECTOR FINISH: CL, RG</p> <p>COVER FINISH: WH</p> <p>TRIM/RING FINISH: WH, BK, SN, CP, CH, PB, BZ</p>

6" Incandescent Trims

(LAMP WATTAGE: (1) MAX. 75W R/PAR40/PAR38, 75W R/PAR30, 60W A19, 65W BR30)

Catalog Number:

Project Name:

Type:

Note:



B681CP-WH
SQUARE BAFFLE TRIM

BAFFLE FINISH:
W, P, SN, CP, BZ

TRIM/RING FINISH:
WH, BK, SN, CP

B687CP-WH
SQUARE REFLECTOR TRIM

REFLECTOR FINISH:
CL, RG, W, MB, SN, CP

TRIM/RING FINISH:
WH, BK, SN, CP

B682WH
SQUARE EYEBALL TRIM

TRIM/RING FINISH:
WH

B693WH
SQUARE PAR30 GIMBAL TRIM

TRIM/RING FINISH:
WH

B694WH
SQUARE PAR38 GIMBAL TRIM

TRIM/RING FINISH:
WH

B688WH
SQUARE ALBALITE SHOWER TRIM

LENS:
WHITE

TRIM/RING FINISH:
WH

B685WH
SQUARE FRESNEL SHOWER TRIM

LENS:
CLEAR

TRIM/RING FINISH:
WH

B696WH
SQUARE DROP OIPAL SHOWER TRIM

LENS:
WHITE

TRIM/RING FINISH:
WH

B689WH
SQUARE DESIGNER CONE SHOWER LENS

LENS:
FROSTED

TRIM/RING FINISH:
WH

B680WH
SQUARE DESIGNER POINT LENS

LENS:
FROSTED/CLEAR

TRIM/RING FINISH:
WH

BAFFLE	REFLECTOR	TRIM RING
W White	CL Chrome	WH White
P Black	RG Gold	BK Black
SN Satin Nickel	W White	SN Satin Nickel
CP Copper	MB Black	CP Copper
BZ Bronze	CP Copper	CH Chrome
	SN Satin Nickel	PB Polish Brass
		BZ Bronze

*For custom baffle, reflector, trim ring, glass color and lens options, please consult factory.