

NEW!
See
reverse

Steel Stand-Off Bracket

Complies with 2008 NEC • Overcomes code violations

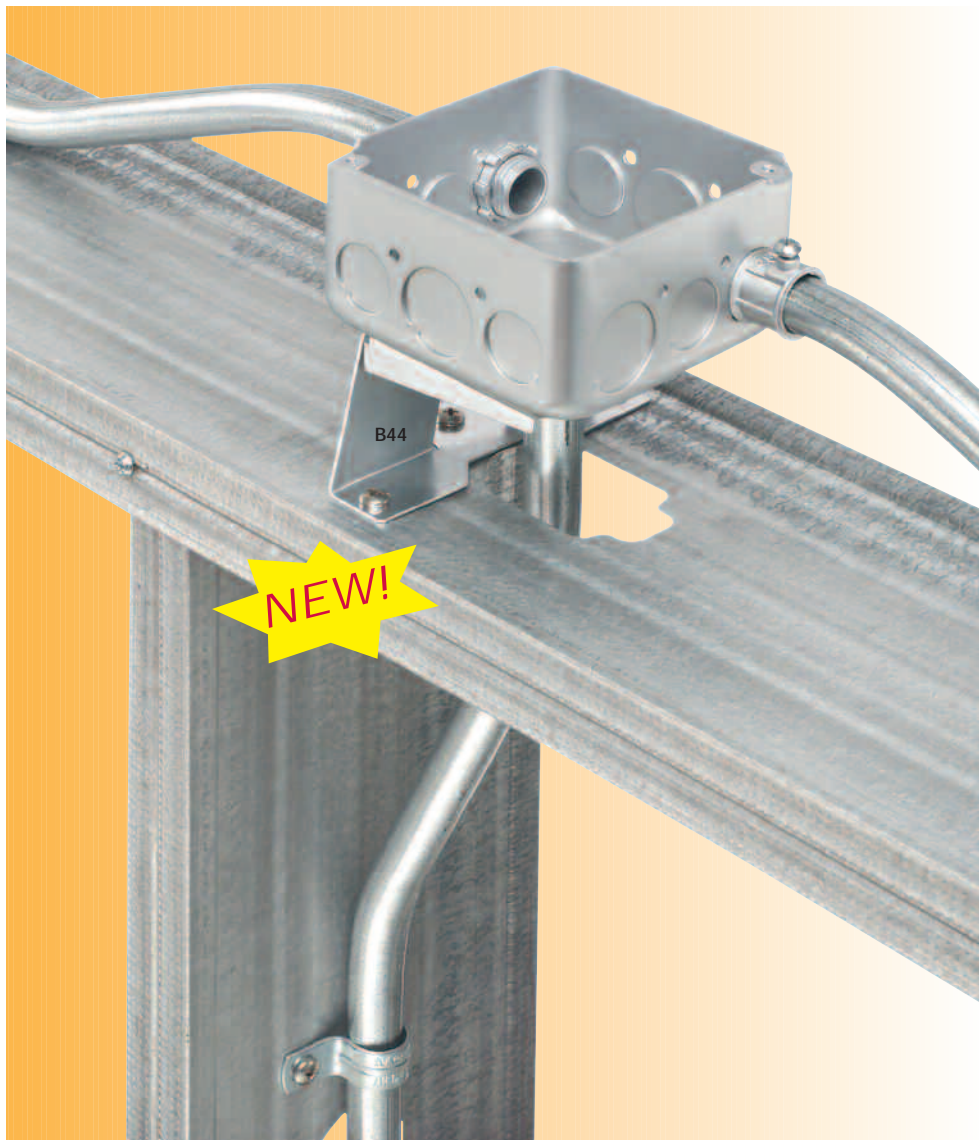

Arlington's easy-to-install **B44** stand-off bracket provides rigid support and spacing for a 4x4 metal box installed with *all types* of raceway systems.

Our bracket has clearance holes that assure proper bonding between the fitting and the box. It complies with the 2008 NEC by providing secure fastening and rigid box support – *independent of the conduit.*

- Delivers compliance with NEC articles 300.11 (A) and 314.23 (A, B): *Raceways, cable assemblies, boxes, cabinets and fittings shall be securely fastened in place. Support wires that do not provide secure support shall not be permitted as the sole support of the raceway, box and fittings*
- 20 gauge steel
- Mounts to metal, wood, block or brick with a variety of fasteners



The B44 Stand-off Bracket overcomes CODE VIOLATIONS of 300.11 (A) like these...

where the raceway (EMT in this case) is functioning as the sole support of the raceway, box and fittings.

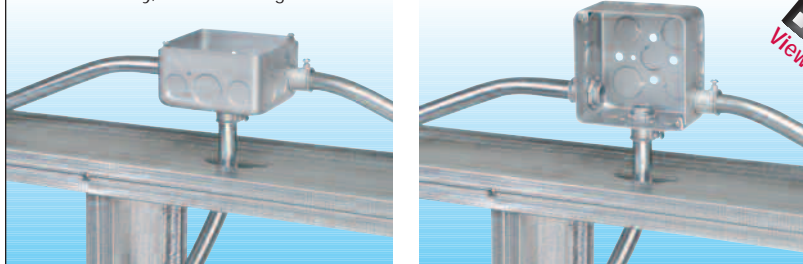

Catalog Number	UPC/DEI/NAED Mfg. #018997	Description Stand-off Bracket	Unit Pkg	Std Pkg
B44	00101	20 gauge steel. Supports 4x4 metal box installed with raceway of any kind	25	25

Patent pending

Arlington

1 Stauffer Industrial Park
Scranton, PA 18517
800/233.4717
Fax 570/562.0646
www.aifittings.com
www.arlnew.com/b44

Steel Stand-Off Bracket

Provides box support independent of conduit

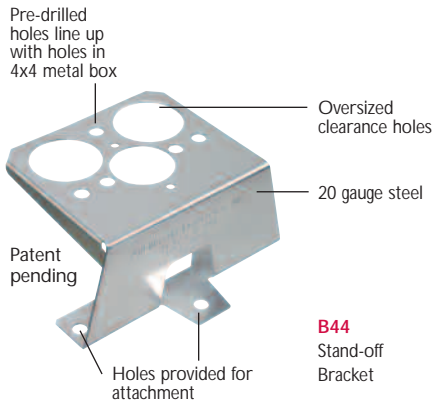

Typical installation with EMT

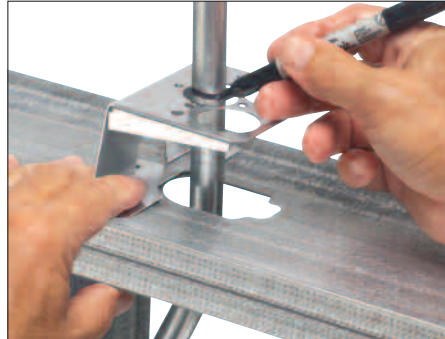

1 Place B44 on metal stud and mark EMT.



2 EMT marked and ready to cut.



3 Attach B44 stand-off bracket to metal stud through holes in base.

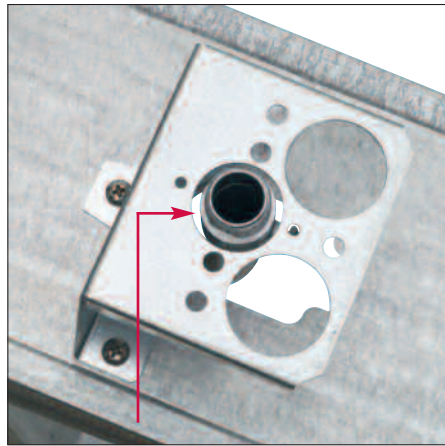

4 EMT "floats" in clearance hole to assure proper bonding between box and fitting.



5 Install locknut on EMT fitting.

B44 overcomes violations of NEC 300.11 (A) and 300.23 (A and B).



6 Attach 4x4 metal box to the stand-off bracket with screws (not provided) through pre-drilled holes in bracket.

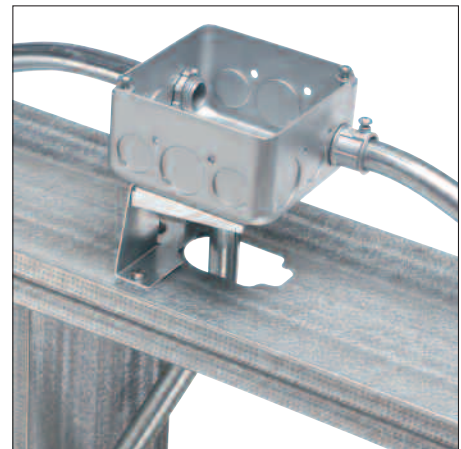

7 Completed installation. The box is supported by the B44 stand-off bracket, not the conduit.

Arlington

1 Stauffer Industrial Park
Scranton, PA 18517
800/233.4717
Fax 570/562.0646
www.aifittings.com
www.arlnew.com/b44

B44 0609/25M

Distributed by

NEW!
See
reverse

Steel Stand-Off Bracket

Complies with 2008 NEC • Overcomes code violations

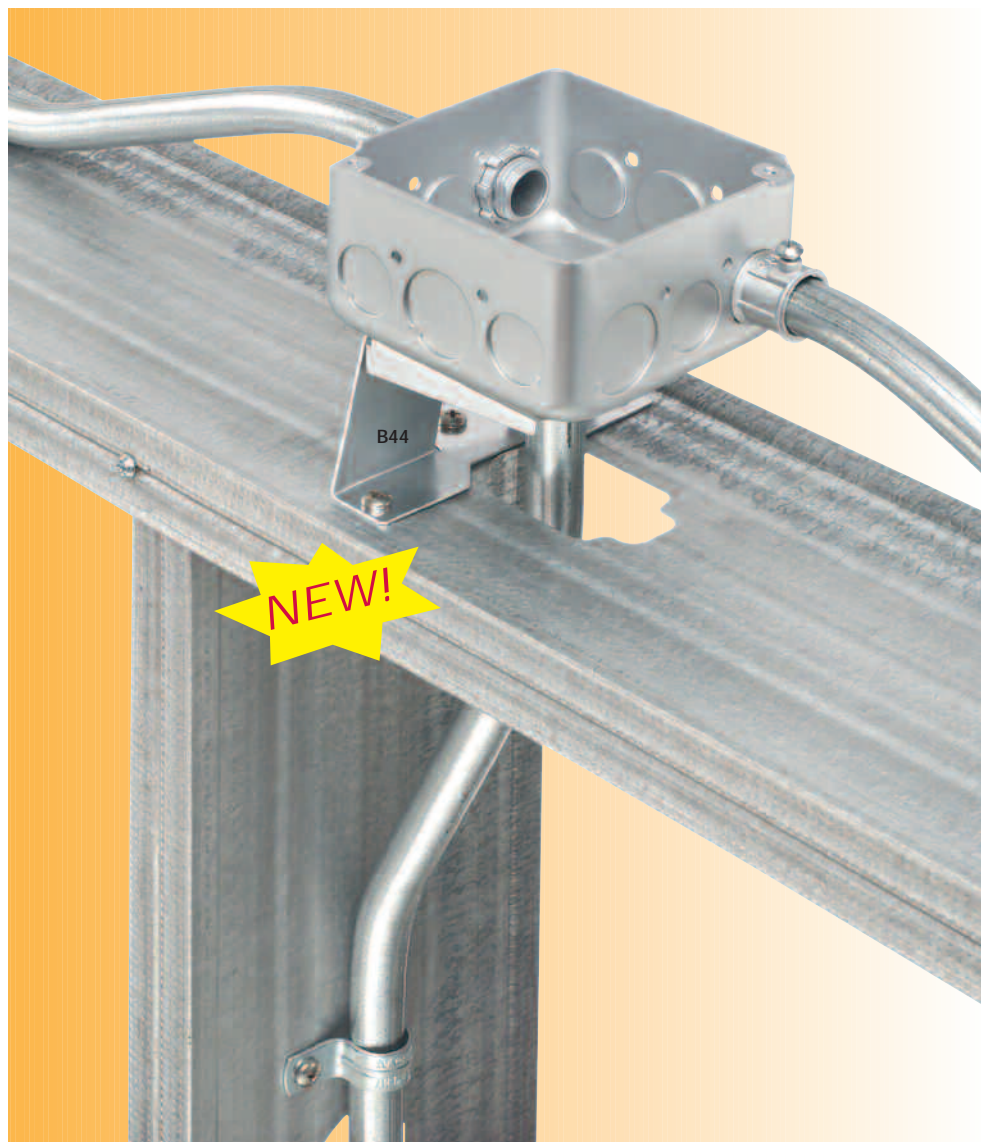

Arlington's easy-to-install **B44** stand-off bracket provides rigid support and spacing for a 4x4 metal box installed with *all types* of raceway systems.

Our bracket has clearance holes that assure proper bonding between the fitting and the box. It complies with the 2008 NEC by providing secure fastening and rigid box support – *independent of the conduit.*

- Delivers compliance with NEC articles 300.11 (A) and 314.23 (A, B): *Raceways, cable assemblies, boxes, cabinets and fittings shall be securely fastened in place. Support wires that do not provide secure support shall not be permitted as the sole support of the raceway, box and fittings*
- 20 gauge steel
- Mounts to metal, wood, block or brick with a variety of fasteners



The B44 Stand-off Bracket overcomes CODE VIOLATIONS of 300.11 (A) like these...

where the raceway (EMT in this case) is functioning as the sole support of the raceway, box and fittings.

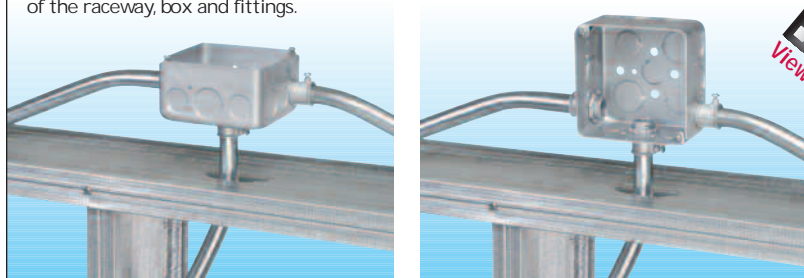

Catalog Number	UPC/DEI/NAED Mfg. #018997	Description Stand-off Bracket	Unit Pkg	Std Pkg
B44	00101	20 gauge steel. Supports 4x4 metal box installed with raceway of any kind	25	25

Patent pending

Arlington

1 Stauffer Industrial Park
Scranton, PA 18517
800/233.4717
Fax 570/562.0646
www.aifittings.com
www.arlnew.com/b44

Steel Stand-Off Bracket

Provides box support independent of conduit

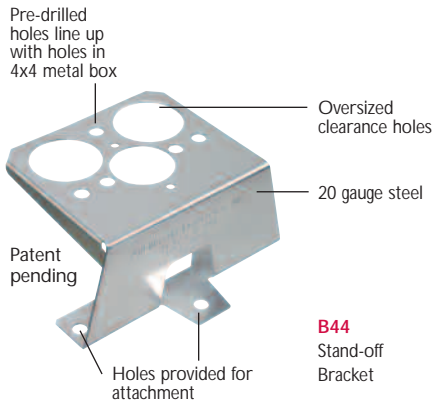

Typical installation with EMT

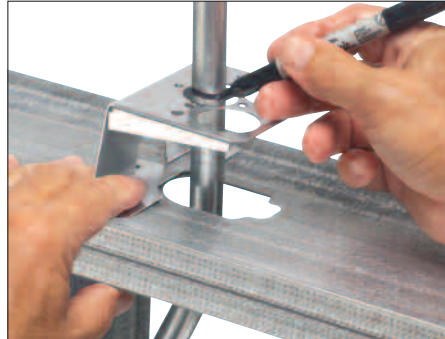

1 Place B44 on metal stud and mark EMT.



2 EMT marked and ready to cut.



3 Attach B44 stand-off bracket to metal stud through holes in base.

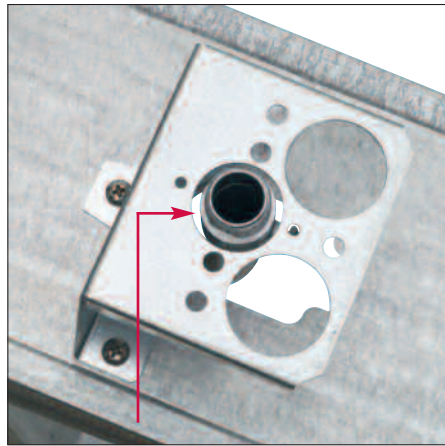

4 EMT "floats" in clearance hole to assure proper bonding between box and fitting.



5 Install locknut on EMT fitting.

B44 overcomes violations of NEC 300.11 (A) and 300.23 (A and B).



6 Attach 4x4 metal box to the stand-off bracket with screws (not provided) through pre-drilled holes in bracket.

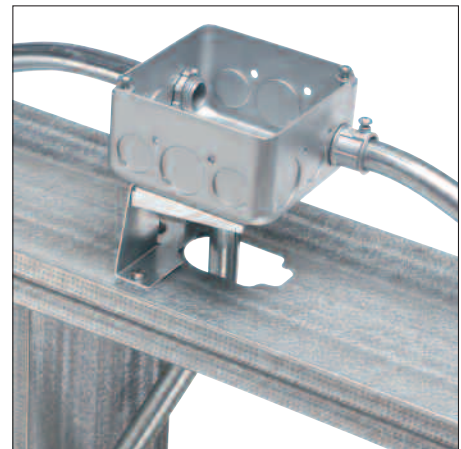

7 Completed installation. The box is supported by the B44 stand-off bracket, not the conduit.

Distributed by

Arlington

1 Stauffer Industrial Park
Scranton, PA 18517
800/233.4717
Fax 570/562.0646
www.aifittings.com
www.arlnew.com/b44

B44 0609/25M