



LED UFO High Bay

Standard and Premium Series

Our UFO style round high bay is the latest in LED technology. More efficient and longer lasting, our IP65 – WET location rated, LED UFO high bay fixture achieves desired light levels while using less power per fixture than most other LED High bay fixtures. Light can be dimmed to ideal brightness levels to save energy and achieve the exact light level needed for your application.

This one-piece aluminum heat sink provides excellent thermal management and gives the fixture it's water-tight IP65 rating. This fixture features Integrated dimming and can be used with 1-10v, PWM and VR dimmers to save energy and achieve specific light levels. Optional accessories include 16" and 21" aluminum reflectors, 16" and 19" polycarbonate reflectors and diffusers, and twist lock connectors.

This fixture is the perfect commercial or industrial solution for warehouses, supermarkets, retail stores, gyms, garages, general task areas and many other applications.

Catalog number	
Notes	
Type	



FEATURES AND BENEFITS:

- ▶ Integrated sensor models are available
- ▶ Dimmable (1-10v, PWM and VR dimmers)
- ▶ PF/THD: > 0.9 / < 15%
- ▶ Operating temperature -22 to 122°F (-30 to 50°C)
- ▶ L-70 Life > 54,000 hrs
- ▶ cULus listed
- ▶ Design Lights Consortium (DLC) listed (Classification: Standard and Premium Series)
- ▶ 5 Year warranty

PRODUCT LEGEND:

Family	Modification	Voltage	Watts	Dimmable	CCT	Option	Series
ASD-UHB	XX	XX	XX	D	XX	MS	XXX
LED UFO High Bay	2	Blank = Regular	100 = 100 W; 150 = 150 W	Dimmable	35 = 3,500 K	Motion sensor	STD = Standard
	22	HV = High Voltage	200 = 200 W; 240 = 240 W		50 = 5,000 K		PRM = Premium
	7		300 = 300 W; 400 = 400 W				
			500 = 500 W				

LED UFO HIGH BAY FIXTURE:

Model	Watts	Voltage	Dimming	Motion Sensor	CCT	Lumens	Dimensions (LxWxH)	Cord
ASD-UHB2-100D35-STD	100 W	120-277V	yes	-	3,500 K	12,799 lm	10 1/4" x 10 1/4" x 5 1/16"	4 ft
ASD-UHB2-150D35-STD	150 W	120-277V	yes	-	3,500 K	18,069 lm	10 1/4" x 10 1/4" x 5 1/16"	4 ft
ASD-UHB2-200D35-STD	200 W	120-277V	yes	-	3,500 K	24,706 lm	10 1/4" x 10 1/4" x 5 15/16"	4 ft
ASD-UHB2-100D50-PRM	100 W	120-277V	yes	-	5,000 K	15,288 lm	10 1/4" x 10 1/4" x 5 5/16"	4 ft
ASD-UHB2-150D50-PRM	150 W	120-277V	yes	-	5,000 K	22,703 lm	10 1/4" x 10 1/4" x 5 5/16"	4 ft
ASD-UHB2-200D50-PRM	200 W	120-277V	yes	-	5,000 K	29,776 lm	10 1/4" x 10 1/4" x 5 15/16"	4 ft
ASD-UHB2-240D50-PRM	240 W	120-277V	yes	-	5,000 K	35,623 lm	12 5/8" x 12 5/8" x 5 5/8"	4 ft
ASD-UHB2-300D50-PRM	300 W	120-277V	yes	-	5,000 K	41,350 lm	12 5/8" x 12 5/8" x 6 3/16"	4 ft
ASD-UHB2HV-100D50-PRM	100 W	200-480V	yes	-	5,000 K	13,905 lm	10 1/4" x 10 1/4" x 5 5/16"	4 ft
ASD-UHB2HV-150D50-PRM	150 W	200-480V	yes	-	5,000 K	20,510 lm	10 1/4" x 10 1/4" x 5 5/16"	4 ft
ASD-UHB2HV-200D50-PRM	200 W	200-480V	yes	-	5,000 K	26,921 lm	10 1/4" x 10 1/4" x 6 5/16"	4 ft
ASD-UHB2HV-240D50-PRM	240 W	200-480V	yes	-	5,000 K	33,286 lm	12 5/8" x 12 5/8" x 5 3/4"	4 ft
ASD-UHB22-100D50-MS-PRM	100 W	120-277V	yes	yes	5,000 K	15,144 lm	12 5/8" x 12 5/8" x 7 1/2"	4 ft
ASD-UHB22-150D50-MS-PRM	150 W	120-277V	yes	yes	5,000 K	22,622 lm	12 5/8" x 12 5/8" x 7 1/2"	4 ft
ASD-UHB22-200D50-MS-PRM	200 W	120-277V	yes	yes	5,000 K	29,789 lm	12 5/8" x 12 5/8" x 8 1/8"	4 ft
ASD-UHB22-240D50-MS-PRM	240 W	120-277V	yes	yes	5,000 K	35,623 lm	12 5/8" x 12 5/8" x 8 1/8"	4 ft
ASD-UHB22-300D50-MS-PRM	300 W	120-277V	yes	yes	5,000 K	41,832 lm	12 5/8" x 12 5/8" x 8 5/8"	4 ft
ASD-UHB7-240D50-PRM	240 W	120-277V	yes	-	5,000 K	36,272 lm	11 3/8" x 11 3/8" x 8 3/8"	4 ft
ASD-UHB7-300D50-PRM	300 W	120-277V	yes	-	5,000 K	45,760 lm	12 5/8" x 12 5/8" x 10 1/2"	4 ft
ASD-UHB7-400D50-PRM	400 W	120-277V	yes	-	5,000 K	60,967 lm	14 1/8" x 14 1/8" x 14 1/4"	4 ft
ASD-UHB7-500D50-PRM	500 W	120-277V	yes	-	5,000 K	75,234 lm	14 1/8" x 14 1/8" x 14 1/4"	4 ft
ASD-UHB7HV-300D50-PRM	300 W	200-480V	yes	-	5,000 K	44,816 lm	12 5/8" x 12 5/8" x 10 1/2"	4 ft
ASD-UHB7HV-400D50-PRM	400 W	200-480V	yes	-	5,000 K	60,143 lm	14 1/8" x 14 1/8" x 14 1/4"	4 ft
ASD-UHB7HV-500D50-PRM	500 W	200-480V	yes	-	5,000 K	74,896 lm	14 1/8" x 14 1/8" x 14 1/4"	4 ft

For most up-to-date spec sheets please refer to asd-lighting.com



LED UFO High Bay

Standard and Premium Series

PRODUCT SPECIFICATIONS:

Construction & Materials						
Housing	Die cast Aluminum					
Finish	Black					
Weight	ASD-UHB2-100D35-STD	6 lb (2.7 kg)	ASD-UHB2HV-100D50-PRM	6 lb (2.7 kg)	ASD-UHB7-240D50-PRM	11.5 lb (5.2 kg)
	ASD-UHB2-150D35-STD	6 lb (2.7 kg)	ASD-UHB2HV-150D50-PRM	6.6 lb (3 kg)	ASD-UHB7-300D50-PRM	16.3 lb (7.4 kg)
	ASD-UHB2-200D35-STD	7.1 lb (3.2 kg)	ASD-UHB2HV-200D50-PRM	8.4 lb (3.8 kg)	ASD-UHB7-400D50-PRM	20.7 lb (9.4 kg)
	ASD-UHB2-100D50-PRM	6 lb (2.7 kg)	ASD-UHB2HV-240D50-PRM	8.4 lb (3.8 kg)	ASD-UHB7-500D50-PRM	21.2 lb (9.6 kg)
	ASD-UHB2-150D50-PRM	6 lb (2.7 kg)	ASD-UHB22-100D50-MS-PRM	6.5 lb (3 kg)	ASD-UHB7HV-300D50-PRM	16.8 lb (7.6 kg)
	ASD-UHB2-200D50-PRM	7.1 lb (3.2 kg)	ASD-UHB22-150D50-MS-PRM	6.7 lb (3 kg)	ASD-UHB7HV-400D50-PRM	21.6 lb (9.8 kg)
	ASD-UHB2-240D50-PRM	8.4 lb (3.8 kg)	ASD-UHB22-200D50-MS-PRM	6.7 lb (3 kg)	ASD-UHB7HV-500D50-PRM	21.6 lb (9.8 kg)
	ASD-UHB2-300D50-PRM	15 lb (6.8 kg)	ASD-UHB22-240D50-MS-PRM	7.1 lb (3.2 kg)		
			ASD-UHB22-300D50-MS-PRM	11.5 lb (5.2 kg)		
Environmental System						
Work Environment	Suitable for Wet Locations, IP65					
Operating Temperature	-22°F to 122°F (-30°C to 50°C)					
L-70 Life	UHB2 / UHB2HV	> 54,000 hrs	UHB22 / UHB7 / UHB7HV	> 50,000 hrs		
Optical System						
Luminous Flux	ASD-UHB2-100D35-STD	12,799 lm	ASD-UHB2HV-100D50-PRM	13,905 lm	ASD-UHB7-240D50-PRM	36,272 lm
	ASD-UHB2-150D35-STD	18,069 lm	ASD-UHB2HV-150D50-PRM	20,510 lm	ASD-UHB7-300D50-PRM	45,760 lm
	ASD-UHB2-200D35-STD	24,706 lm	ASD-UHB2HV-200D50-PRM	26,921 lm	ASD-UHB7-400D50-PRM	60,967 lm
	ASD-UHB2-100D50-PRM	15,288 lm	ASD-UHB2HV-240D50-PRM	33,286 lm	ASD-UHB7-500D50-PRM	75,234 lm
	ASD-UHB2-150D50-PRM	22,703 lm	ASD-UHB22-100D50-MS-PRM	15,144 lm	ASD-UHB7HV-300D50-PRM	44,816 lm
	ASD-UHB2-200D50-PRM	29,776 lm	ASD-UHB22-150D50-MS-PRM	22,622 lm	ASD-UHB7HV-400D50-PRM	60,143 lm
	ASD-UHB2-240D50-PRM	35,623 lm	ASD-UHB22-200D50-MS-PRM	29,789 lm	ASD-UHB7HV-500D50-PRM	74,896 lm
	ASD-UHB2-300D50-PRM	41,350 lm	ASD-UHB22-240D50-MS-PRM	35,623 lm		
			ASD-UHB22-300D50-MS-PRM	41,832 lm		
Color Temperature	3,500 K, 5,000 K					
CRI	ASD-UHB2-100D35-STD	>70	ASD-UHB2HV-100D50-PRM	>80	ASD-UHB7-240D50-PRM	>70
	ASD-UHB2-150D35-STD		ASD-UHB2HV-150D50-PRM		ASD-UHB7-300D50-PRM	
	ASD-UHB2-200D35-STD		ASD-UHB2HV-200D50-PRM		ASD-UHB7-400D50-PRM	
	ASD-UHB2-100D50-PRM	>70	ASD-UHB2HV-240D50-PRM	>70	ASD-UHB7-500D50-PRM	>70
	ASD-UHB2-150D50-PRM		ASD-UHB22-100D50-MS-PRM	ASD-UHB7HV-300D50-PRM		
	ASD-UHB2-200D50-PRM		ASD-UHB22-150D50-MS-PRM	ASD-UHB7HV-400D50-PRM		
	ASD-UHB2-240D50-PRM	>80	ASD-UHB22-200D50-MS-PRM	>80	ASD-UHB7HV-500D50-PRM	
	ASD-UHB2-300D50-PRM		ASD-UHB22-240D50-MS-PRM			
		ASD-UHB22-300D50-MS-PRM				
Electrical System						
Input Voltage	ASD-UHB2-100D35-STD	120-277VAC 50/60Hz	ASD-UHB2HV-100D50-PRM	200-480VAC 50/60Hz	ASD-UHB7-240D50-PRM	120-277VAC 50/60Hz
	ASD-UHB2-150D35-STD		ASD-UHB2HV-150D50-PRM		ASD-UHB7-300D50-PRM	
	ASD-UHB2-200D35-STD		ASD-UHB2HV-200D50-PRM		ASD-UHB7-400D50-PRM	
	ASD-UHB2-100D50-PRM		ASD-UHB2HV-240D50-PRM		ASD-UHB7-500D50-PRM	
	ASD-UHB2-150D50-PRM		ASD-UHB22-100D50-MS-PRM	ASD-UHB7HV-300D50-PRM	200-480VAC 50/60Hz	
	ASD-UHB2-200D50-PRM		ASD-UHB22-150D50-MS-PRM	ASD-UHB7HV-400D50-PRM		
	ASD-UHB2-240D50-PRM		ASD-UHB22-200D50-MS-PRM	ASD-UHB7HV-500D50-PRM		
	ASD-UHB2-300D50-PRM		ASD-UHB22-240D50-MS-PRM			
		ASD-UHB22-300D50-MS-PRM				
Max input current	ASD-UHB2-100D35-STD	1.44 A	ASD-UHB2HV-100D50-PRM	0.6 A	ASD-UHB7-240D50-PRM	0.6 A
	ASD-UHB2-150D35-STD	1.8 A	ASD-UHB2HV-150D50-PRM	0.9 A	ASD-UHB7-300D50-PRM	
	ASD-UHB2-200D35-STD	2.4 A	ASD-UHB2HV-200D50-PRM	1.2 A	ASD-UHB7-400D50-PRM	
	ASD-UHB2-100D50-PRM	1.44 A	ASD-UHB2HV-240D50-PRM	1.2 A	ASD-UHB7-500D50-PRM	
	ASD-UHB2-150D50-PRM	1.8 A	ASD-UHB22-100D50-MS-PRM	0.6 A	ASD-UHB7HV-300D50-PRM	0.6 A
	ASD-UHB2-200D50-PRM	2.4 A	ASD-UHB22-150D50-MS-PRM		ASD-UHB7HV-400D50-PRM	
	ASD-UHB2-240D50-PRM	2.88 A	ASD-UHB22-200D50-MS-PRM		ASD-UHB7HV-500D50-PRM	
	ASD-UHB2-300D50-PRM	3.6 A	ASD-UHB22-240D50-MS-PRM			
		ASD-UHB22-300D50-MS-PRM				
Inrush current (Action time)	ASD-UHB2-100D35-STD	100 A (0.15 S)	ASD-UHB2HV-100D50-PRM	60 A (0.5 S)	ASD-UHB7-240D50-PRM	35 A (<1 S)
	ASD-UHB2-150D35-STD	130 A (0.15 S)	ASD-UHB2HV-150D50-PRM		ASD-UHB7-300D50-PRM	35 A (0.5 S)
	ASD-UHB2-200D35-STD	100 A (0.15 S)	ASD-UHB2HV-200D50-PRM		ASD-UHB7-400D50-PRM	
	ASD-UHB2-100D50-PRM	100 A (0.15 S)	ASD-UHB2HV-240D50-PRM		ASD-UHB7-500D50-PRM	
	ASD-UHB2-150D50-PRM	130 A (0.15 S)	ASD-UHB22-100D50-MS-PRM	1.44 A (0.15 S)	ASD-UHB7HV-300D50-PRM	
	ASD-UHB2-200D50-PRM		ASD-UHB22-150D50-MS-PRM	1.8 A (0.15 S)	ASD-UHB7HV-400D50-PRM	
	ASD-UHB2-240D50-PRM		ASD-UHB22-200D50-MS-PRM	2.4 A (0.15 S)	ASD-UHB7HV-500D50-PRM	
	ASD-UHB2-300D50-PRM		ASD-UHB22-240D50-MS-PRM	2.88 A (0.15 S)		
	120 A (0.8 S)	ASD-UHB22-300D50-MS-PRM	3.6 A (0.8 S)			

For most up-to-date spec sheets please refer to asd-lighting.com



LED UFO High Bay

Standard and Premium Series

Electrical System							
AC input range	ASD-UHB2-100D35-STD	min 90 V max 305 V	ASD-UHB2HV-100D50-PRM	min 180 V max 528 V	ASD-UHB7-240D50-PRM		
	ASD-UHB2-150D35-STD		ASD-UHB2HV-150D50-PRM		ASD-UHB7-300D50-PRM		
	ASD-UHB2-200D35-STD		ASD-UHB2HV-200D50-PRM		ASD-UHB7-400D50-PRM		
	ASD-UHB2-100D50-PRM	min 90 V max 305 V	ASD-UHB2HV-240D50-PRM	min 90 V max 305 V	ASD-UHB7-500D50-PRM		
	ASD-UHB2-150D50-PRM		ASD-UHB22-100D50-MS-PRM		ASD-UHB7HV-300D50-PRM		
	ASD-UHB2-200D50-PRM		ASD-UHB22-150D50-MS-PRM		ASD-UHB7HV-400D50-PRM		
ASD-UHB2-240D50-PRM	ASD-UHB22-200D50-MS-PRM		ASD-UHB7HV-500D50-PRM				
ASD-UHB2-300D50-PRM		ASD-UHB22-240D50-MS-PRM					
ASD-UHB22-300D50-MS-PRM		ASD-UHB22-300D50-MS-PRM					
Off State Power	0 W						
Power Consumption	ASD-UHB2-100D35-STD	100 W	ASD-UHB2HV-100D50-PRM	100 W	ASD-UHB7-240D50-PRM	240 W	
	ASD-UHB2-150D35-STD	150 W	ASD-UHB2HV-150D50-PRM	150 W	ASD-UHB7-300D50-PRM	300 W	
	ASD-UHB2-200D35-STD	200 W	ASD-UHB2HV-200D50-PRM	200 W	ASD-UHB7-400D50-PRM	400 W	
	ASD-UHB2-100D50-PRM	100 W	ASD-UHB2HV-240D50-PRM	240 W	ASD-UHB7-500D50-PRM	500 W	
	ASD-UHB2-150D50-PRM	150 W	ASD-UHB22-100D50-MS-PRM	100 W	ASD-UHB7HV-300D50-PRM	300 W	
	ASD-UHB2-200D50-PRM	200 W	ASD-UHB22-150D50-MS-PRM	150 W	ASD-UHB7HV-400D50-PRM	400 W	
	ASD-UHB2-240D50-PRM	240 W	ASD-UHB22-200D50-MS-PRM	200 W	ASD-UHB7HV-500D50-PRM	500 W	
	ASD-UHB2-300D50-PRM	300 W	ASD-UHB22-240D50-MS-PRM	240 W			
		ASD-UHB22-300D50-MS-PRM	300 W				
Power Factor	ASD-UHB2-100D35-STD	0.96	ASD-UHB2HV-100D50-PRM	0.95	ASD-UHB7-240D50-PRM		
	ASD-UHB2-150D35-STD	0.97	ASD-UHB2HV-150D50-PRM		ASD-UHB7-300D50-PRM		
	ASD-UHB2-200D35-STD	0.97	ASD-UHB2HV-200D50-PRM		ASD-UHB7-400D50-PRM		
	ASD-UHB2-100D50-PRM	0.96	ASD-UHB2HV-240D50-PRM		ASD-UHB7-500D50-PRM		
	ASD-UHB2-150D50-PRM	0.97	ASD-UHB22-100D50-MS-PRM	> 0.9	ASD-UHB7HV-300D50-PRM		
	ASD-UHB2-200D50-PRM	0.97	ASD-UHB22-150D50-MS-PRM		ASD-UHB7HV-400D50-PRM		
	ASD-UHB2-240D50-PRM	0.97	ASD-UHB22-200D50-MS-PRM		ASD-UHB7HV-500D50-PRM		
	ASD-UHB2-300D50-PRM	0.98	ASD-UHB22-240D50-MS-PRM				
		ASD-UHB22-300D50-MS-PRM					
Output voltage	ASD-UHB2-100D35-STD	130 V	ASD-UHB2HV-100D50-PRM	58 V	ASD-UHB7-240D50-PRM		
	ASD-UHB2-150D35-STD	260 V	ASD-UHB2HV-150D50-PRM		ASD-UHB7-300D50-PRM		
	ASD-UHB2-200D35-STD		ASD-UHB2HV-200D50-PRM		ASD-UHB7-400D50-PRM		
	ASD-UHB2-100D50-PRM	130 V	ASD-UHB2HV-240D50-PRM	130 V	ASD-UHB7-500D50-PRM		
	ASD-UHB2-150D50-PRM		ASD-UHB22-100D50-MS-PRM		ASD-UHB7HV-300D50-PRM		
	ASD-UHB2-200D50-PRM	260 V	ASD-UHB22-150D50-MS-PRM		ASD-UHB7HV-400D50-PRM		
	ASD-UHB2-240D50-PRM		ASD-UHB22-200D50-MS-PRM		ASD-UHB7HV-500D50-PRM		
	ASD-UHB2-300D50-PRM	56 V	ASD-UHB22-240D50-MS-PRM	260 V			
		ASD-UHB22-300D50-MS-PRM	56 V				
Max output current	ASD-UHB2-100D35-STD	920 mA	ASD-UHB2HV-100D50-PRM	1.65 A	ASD-UHB7-240D50-PRM	1.85 A	
	ASD-UHB2-150D35-STD	570 mA	ASD-UHB2HV-150D50-PRM	2.6 A	ASD-UHB7-300D50-PRM	5.6 A	
	ASD-UHB2-200D35-STD	770 mA	ASD-UHB2HV-200D50-PRM	4.1 A	ASD-UHB7-400D50-PRM	7.6 A	
	ASD-UHB2-100D50-PRM	920 mA	ASD-UHB2HV-240D50-PRM	4.1 A	ASD-UHB7-500D50-PRM	9.5 A	
	ASD-UHB2-150D50-PRM	570 mA	ASD-UHB22-100D50-MS-PRM	920 mA	ASD-UHB7HV-300D50-PRM	5.6 A	
	ASD-UHB2-200D50-PRM	770 mA	ASD-UHB22-150D50-MS-PRM	570 mA	ASD-UHB7HV-400D50-PRM	7.6 A	
	ASD-UHB2-240D50-PRM	920 mA	ASD-UHB22-200D50-MS-PRM	770 mA	ASD-UHB7HV-500D50-PRM	9.5 A	
	ASD-UHB2-300D50-PRM	5.4 A	ASD-UHB22-240D50-MS-PRM	920 mA			
		ASD-UHB22-300D50-MS-PRM	5.4 A				
LED driver class	ASD-UHB2-100D35-STD	Non-isolated	ASD-UHB2HV-100D50-PRM	Class 2	ASD-UHB7-240D50-PRM		
	ASD-UHB2-150D35-STD		ASD-UHB2HV-150D50-PRM	Isolated	ASD-UHB7-300D50-PRM		
	ASD-UHB2-200D35-STD		ASD-UHB2HV-200D50-PRM		ASD-UHB7-400D50-PRM		
	ASD-UHB2-100D50-PRM	Non-isolated	ASD-UHB2HV-240D50-PRM	-	ASD-UHB7-500D50-PRM		
	ASD-UHB2-150D50-PRM		ASD-UHB22-100D50-MS-PRM		ASD-UHB7HV-300D50-PRM		
	ASD-UHB2-200D50-PRM		ASD-UHB22-150D50-MS-PRM		ASD-UHB7HV-400D50-PRM		
	ASD-UHB2-240D50-PRM		ASD-UHB22-200D50-MS-PRM		ASD-UHB7HV-500D50-PRM		
	ASD-UHB2-300D50-PRM	HL	ASD-UHB22-240D50-MS-PRM				
		ASD-UHB22-300D50-MS-PRM					
Dimming compatible controls			Regular and Voluntary Certifications				
Brand	Leviton	Lutron	5-year limited warranty				
Models	ZS057-DOZ	DVTV	UHB22 series not compatible with dimmers	cULus listed			E473804
	IP710	DVSTV		DesignLights Consortium (DLC) listed (Classification: Standard and Premium series)			
	DS710	NTSTV	· Main: Indoor Luminaires; · General Application: High-Bay;				
	DD710	MS-Z101	· Primary Use: High-Bay Luminaires for Commercial and Industrial Buildings				

This fixture features Integrated dimming and can be 1-10V, PWM signal or resistance dimming to save energy and achieve specific light levels. The LED UFO High Bay is designed to install as a surface mounted luminaire.

For most up-to-date spec sheets please refer to asd-lighting.com

ASD LIGHTING CORP

E-mail: orders@asd-lighting.com | Web site: www.asd-lighting.com





LED UFO High Bay

Standard and Premium Series

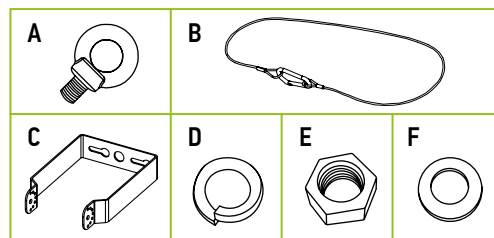

PACKAGE CONTENTS:

Description	Q-ty
LED High Bay Fixture	1
Mounting ring (A)	1
Safety cable (B)	1
Surface mount bracket (C)**	1
M12 Spring washer (D)*	1
M18 Nut (E)**	1
M18 Flat Washer (F)**	2
Box	1
Installation Instructions	3

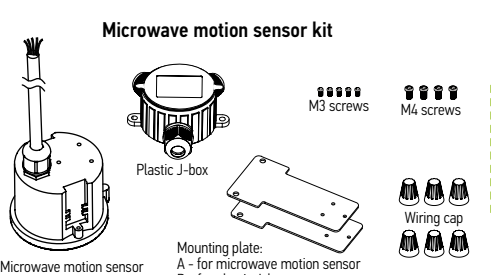
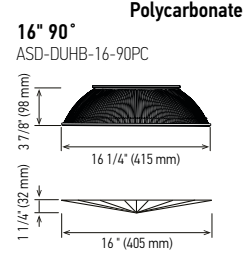
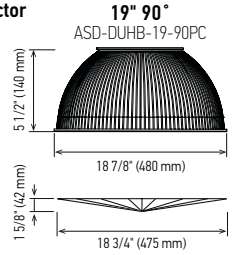
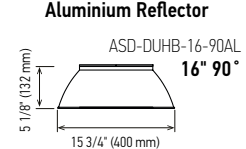
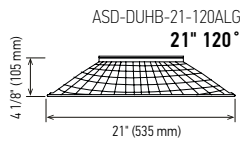
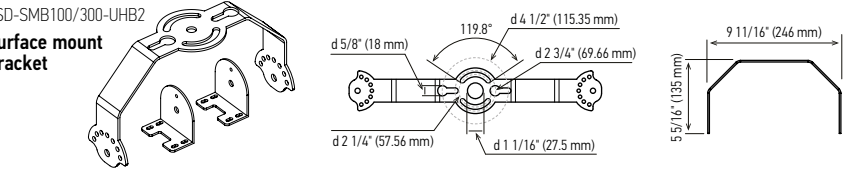

*Only for UHB7 modification
 **Only for UHB7 modification (300W, 400W, 500W models)

ACCESSORIES (sold separately):

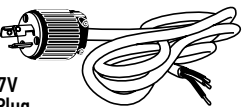
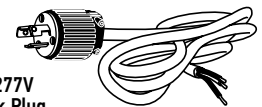
Accessories models	Fixture models
<p>Microwave motion sensor kit</p>  <p>Microwave motion sensor Plastic J-box Mounting plate: A - for microwave motion sensor B - for plastic J-box</p> <p>M3 screws M4 screws Wiring cap</p> <p>for regular voltage UHB-MSK1</p> <p>for high voltage UHBHV-MSK2</p>	<p>Remote Control for UHB-MSK1 UHB-RC-MSK1</p> <p>Remote Control for UHBHV-MSK2 ASD-CELP02H-MS</p> <p>ASD-UHB2-100D35-STD ASD-UHB2-150D35-STD ASD-UHB2-200D35-STD ASD-UHB2-240D50-PRM ASD-UHB2-300D50-PRM</p> <p>ASD-UHB2-100D50-PRM ASD-UHB2-150D50-PRM ASD-UHB2-200D50-PRM ASD-UHB2-240D50-PRM ASD-UHB2-300D50-PRM</p>
<p>Polycarbonate Reflector</p> <p>16" 90° ASD-DUHB-16-90PC</p>  <p>for 16" ASD-BLUHB-16PC</p> <p>19" 90° ASD-DUHB-19-90PC</p>  <p>for 19" ASD-BLUHB-19PC</p> <p>Aluminium Reflector</p> <p>16" 90° ASD-DUHB-16-90AL</p>  <p>21" 120° ASD-DUHB-21-120ALG</p> 	<p>ASD-UHB2-100D35-STD ASD-UHB2-150D35-STD ASD-UHB2-200D35-STD</p> <p>ASD-UHB2-100D50-PRM ASD-UHB2-150D50-PRM ASD-UHB2-200D50-PRM ASD-UHB2-240D50-PRM ASD-UHB2-300D50-PRM</p> <p>ASD-UHB22-100D50-MS-PRM ASD-UHB22-150D50-MS-PRM ASD-UHB22-200D50-MS-PRM ASD-UHB22-240D50-MS-PRM ASD-UHB22-300D50-MS-PRM</p> <p>ASD-UHB7-240D50-PRM ASD-UHB7-300D50-PRM ASD-UHB7HV-300D50-PRM</p>
<p>Surface mount Bracket</p> <p>ASD-SMB100/300-UHB2</p>  <p>ASD-SMB100/300-UHB2</p> <p>ASD-SMB100/300-UHB2</p> <p>d 5/8" (18 mm) 119.8° d 4 1/2" (115.35 mm) d 2 3/4" (69.66 mm) d 2 1/4" (57.56 mm) d 1 1/16" (27.5 mm)</p>	<p>ASD-UHB2-100D35-STD ASD-UHB2-150D35-STD ASD-UHB2-200D35-STD</p> <p>ASD-UHB2-100D50-PRM ASD-UHB2-150D50-PRM ASD-UHB2-200D50-PRM ASD-UHB2-240D50-PRM ASD-UHB2-300D50-PRM</p> <p>ASD-UHB22-100D50-MS-PRM ASD-UHB22-150D50-MS-PRM ASD-UHB22-200D50-MS-PRM ASD-UHB22-240D50-MS-PRM ASD-UHB22-300D50-MS-PRM</p> <p>ASD-UHB7-240D50-PRM ASD-UHB7-300D50-PRM ASD-UHB7-400D50-PRM ASD-UHB7-500D50-PRM</p>
<p>6-foot Cord 120V-277V Straight Blade Plug ASD-CRD6-SBP-277V</p>  <p>6-foot Cord 120V-277V 3-Blade Twist-Lock Plug ASD-CRD6-TLP-277V</p> 	
<p>Inline Wire Connector LLT-M19CS03 for all fixture models</p> <p>• M19 screw fixing wire 3 pin male and female waterproof connector • IP67 protection level • Contact Brass with Gold Plated • Current rating: 20A per contact • Voltage rating: 250V • Accepted Max. Cable OD: 10mm • Field installable. Screw fixing with cable</p> <p>female 2 1/4" (57.5 mm) 7/8" (22.1 mm)</p> <p>male 2 1/4" (57 mm) 7/8" (22.2 mm) 7/8" (22.2 mm)</p> <p>Note: For power wiring ONLY. Do not use for dimmer wires</p>	<p>Hook ASD-H02-UHB2</p>  <p>ASD-UHB2-100D35-STD ASD-UHB2-150D35-STD ASD-UHB2-200D35-STD</p> <p>ASD-UHB2-100D50-PRM ASD-UHB2-150D50-PRM ASD-UHB2-200D50-PRM</p> <p>ASD-UHB2HV-100D50-PRM ASD-UHB2HV-150D50-PRM ASD-UHB2HV-200D50-PRM</p> <p>ASD-UHB22-100D50-MS-PRM ASD-UHB22-150D50-MS-PRM ASD-UHB22-200D50-MS-PRM</p>

For most up-to-date spec sheets please refer to asd-lighting.com



LED UFO High Bay

Standard and Premium Series

INSTALLATION GUIDE

IMPORTANT SAFETY INFORMATION:

Please read all the instructions below before installation.

- ▶ Make sure that the supply voltage corresponds to the rated product voltage.
- ▶ The product must be installed by a qualified electrician in accordance with the National Electrical Code and corresponding local codes.
- ▶ If the product is damaged, do not use it.

⚠ WARNING

RISK OF PERSONAL INJURY – READ and follow all WARNINGS and installation instructions.

Keep or give to the owner for future reference.

Risk of cuts: Wear gloves to prevent cuts or abrasions when removing from carton, handling, installing, and maintaining this product.

Risk of electric shock: This product must be installed in accordance with the applicable installation code by a person familiar with the construction and operation of the product and the hazards involved.

Risk of Fire: Minimum 194°F supply conductors. Consult a qualified electrician to ensure correct branch circuit conductor.

ASD® assumes no responsibility for claims arising out of improper or careless installation or handling of this product.

ELECTRICAL SCHEMATIC DIAGRAM:

for UHB2/UHB7 Regular voltage

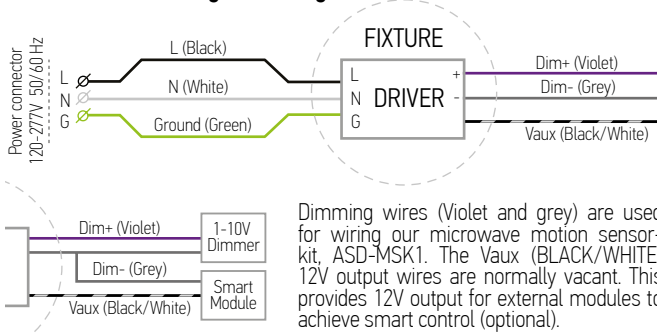

for UHB2HV/UHB7HV High voltage

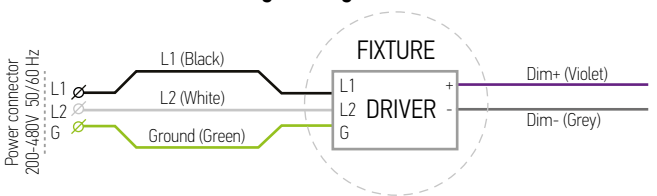

for UHB22

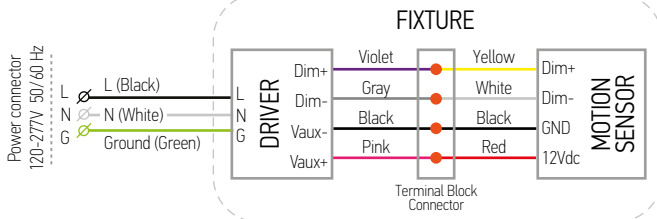

INSTALLATION STEPS:

1. Screw the included Hanging Ring clockwise into the hole at the top of the fixture and tighten.
2. Using the Hanging Ring, hang the fixture on the hook in the ceiling. Attach one end of the included safety cable through the hole between the fins on the luminaire. Ensure the safety cable is secured on the fixture. Secure the other end of the safety cable to the mounting structure.
3. Connect the black wire (Line wire), white wire (Neutral) and yellow green (ground) to the appropriate wires inside the junction box. Alternatively, you may use our connector LLT-M19CS03 (not included). To make the lamp dimmable, please connect a 1-10 V dimmer(not included) with the dimming signal line of the lamp, connect the Dim + port and Dim – port with the corresponding line on the dimmer.

Note:

- ▶ The dimmer can also be replaced by an active 1-10V voltage source signal or passive components like resistors and zener diodes.
- ▶ Do NOT connect Dim- to be output V- or V+, otherwise the driver will not work properly.
- ▶ If 1-10V dimming is not used, Dim+ should be open.
- ▶ When 1-10V negative logic dimming mode and Dim+ is open, the driver will output minimum current

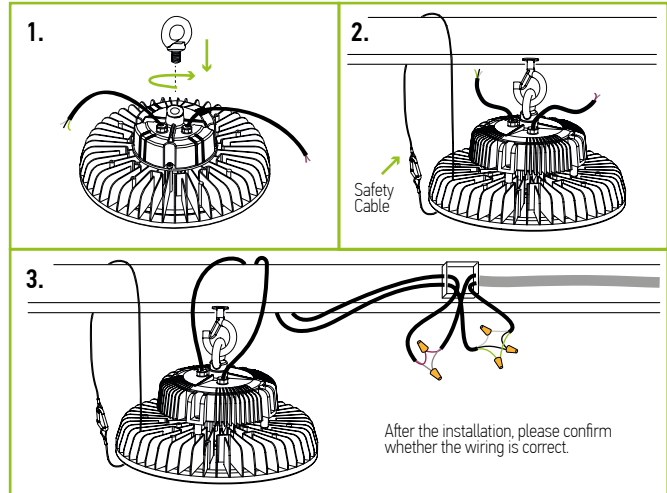

DIFFUSER AND LENS INSTALLATION (sold separately):

1. Install the diffuser, tighten the screws
2. Attach the conical lens with included clamp

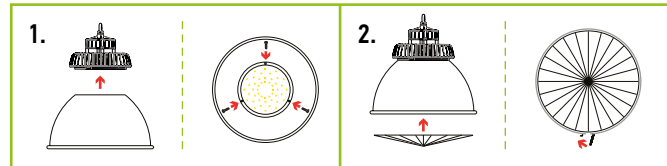

For most up-to-date spec sheets please refer to asd-lighting.com

ASD LIGHTING CORP

E-mail: orders@asd-lighting.com | Web site: www.asd-lighting.com





LED UFO High Bay

Standard and Premium Series

BRACKET INSTALLATION (sold separately):

1. Use four PM5x16 mm screws (included) to install bracket swivel on the top of the lamp body.
2. Use two PM5x12 mm screws (include) to fix bracket on the swivels.
3. Adjust the lighting direction and fix it by two M8x20 mm screws (include).

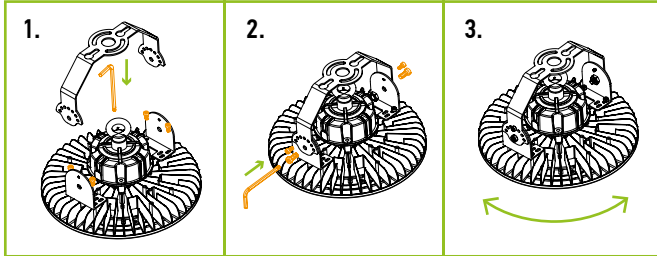

POLE INSTALLATION:

1. Make sure your conduit can support the weight of the fixture. Attach bracket to pipe.
2. Connect power and dimming wires according to wiring diagram.
3. Put the wires inside the pole and finish installation.

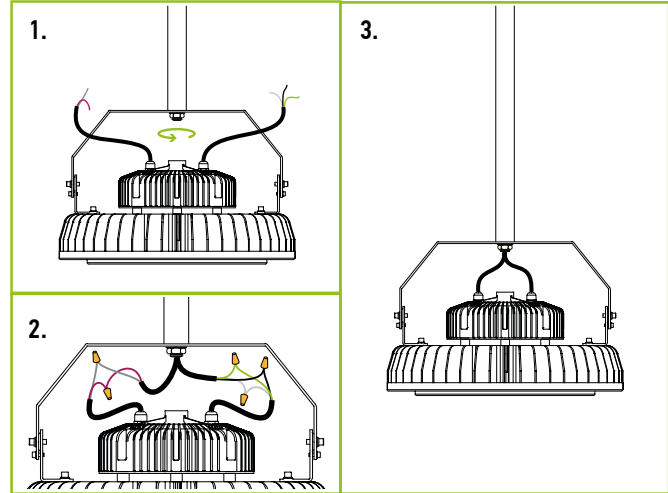

WALL INSTALLATION:

1. Drill holes in the ceiling and install the expansion screws.
2. Surface mount bracket and hook directly to wall or beam.
3. Adjust bracket to desired angle. Clip safety cable to outside of UFO housing. Wire in accordance to wiring diagram. Finish installation and test.

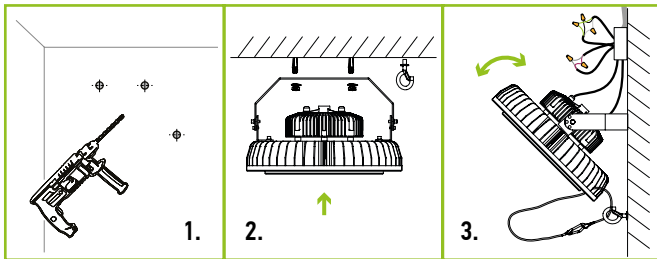

INTEGRATED MICROWAVE MOTION SENSOR INFORMATION

Specifications	Model HD06VCRH	
For fixtures models	ASD-UHB22-100D50-MS-PRM ASD-UHB22-150D50-MS-PRM ASD-UHB22-200D50-MS-PRM	ASD-UHB22-240D50-MS-PRM ASD-UHB22-300D50-MS-PRM
Operating voltage	10-15VDC	
Operating current	30mA±5%	
Output	DIM 1-10V	
Stand-by power	<0.5W	
Detection area	25%/50%/75%/100%	
Hold time	5s/30s/1min/3min/5min/10min/20min/30min	
Daylight threshold	2Lux/10Lux/30Lux/50Lux/80Lux/120Lux/Disable	
Stand-by period	0s/10s/30s/1min/5min/10min/30min/+∞	
Stand-by dimming level	10%/20%/30%/50%	
Microwave frequency	5.8GHz±75MHz	
Microwave power	<0.3mW	
Mounting height	Max.15m/49.2ft	
Detection range	Max.14m/45.92ft	

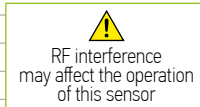

- ▶ Sensor parameters can be conveniently set by a remote control
- ▶ Mounting height up to 45ft max., suitable for warehouse use
- ▶ Built-in adjustable daylight sensor
- ▶ Sensor default setting - 100% detection range, hold time 5S, no stand-by time and daylight threshold disabled

Adopted dual PD technology, is able to differentiate artificial light brightness from natural light after installed inside the fixture, and automatically turn off light when ambient brightness exceeds preset lux level.

Preconditions to use the Lux-off function:

1. Standby period is +∞
2. Standby dimming level is on 10% or 30%;
3. Daylight threshold is on 30Lux, 50Lux, 80Lux or 120Lux.

UF022 series use integrated motion sensors, which are controlled by remote (ASD-CELP02H-MS sold separate). For more information please check page 8.

For most up-to-date spec sheets please refer to asd-lighting.com

ASD LIGHTING CORP

E-mail: orders@asd-lighting.com | Web site: www.asd-lighting.com





LED UFO High Bay

Standard and Premium Series

MICROWAVE MOTION SENSOR KITS INFORMATION

- ▶ Sensor parameters can be conveniently set by a remote control
- ▶ Mounting height up to 15m max., suitable for warehouse use
- ▶ Water proof sensor with IP65 rating
- ▶ Automatic dimming when used in combination with 1-10V dimmable control gears
- ▶ Built-in adjustable daylight sensor
- ▶ 1-10V interface can match up with Merrytek stand-alone daylight sensor MS01 to achieve daylight harvesting
- ▶ Optional mounting brackets for different applications

Specifications	model UHB-MSK1 (sold separately)			model UHBHV-MSK2 (sold separately)		
For fixtures models	ASD-UHB2-100D35-STD ASD-UHB2-150D35-STD ASD-UHB2-200D35-STD ASD-UHB2-100D50-PRM	ASD-UHB2-150D50-PRM ASD-UHB2-200D50-PRM ASD-UHB2-240D50-PRM ASD-UHB2-300D50-PRM	ASD-UHB7-240D50-PRM ASD-UHB7-300D50-PRM ASD-UHB7-400D50-PRM ASD-UHB7-500D50-PRM	ASD-UHB2HV-100D50-PRM ASD-UHB2HV-150D50-PRM ASD-UHB2HV-200D50-PRM ASD-UHB2HV-240D50-PRM	ASD-UHB7HV-300D50-PRM ASD-UHB7HV-400D50-PRM ASD-UHB7HV-500D50-PRM	
Rated load	120 Vac - 400 W max; 277 Vac - 800 W max			347 Vac - 800 W max; 480 Vac - 1200 W max		
Detection area	25% / 50% / 75% / 100%					
Hold time	5 s/30 s/1 min/3 min/5 min/10 min/20 min/30 min					
Daylight sensor	5 lux/15 lux/30 lux/50 lux/100 lux/150 lux/Disable			2 lux/10 lux/30 lux/50 lux/80 lux/120 lux/Disable		
Stand-by period	0 s/10 s/1 min/3 min/5 min/10 min/30 min/+∞					
Stand-by dimming level	10% / 20% / 30% / 50%					
Sensor principle	Microwave motion detector					
Microwave frequency	5.8 GHz ± 75 MHz, ISM wave band					
Transmitting power	<0.5 mW (1% of transmitting power for cell phone)			<1 mW (1% of transmitting power for cell phone)		
Mounting height	3-15 m (10-50 ft)					
Detection angle	150° (Wall installation); 360° (Ceiling installation)					
Motion detection	0.5-3 m/s					
Operating temperature	-31 to 158°F (-35°C to 70°C)					
IP rating	IP65					

⚠
RF interference
may affect the operation
of this sensor

INSTALLATION STEPS ON FIXTURE WITHOUT REFLECTOR

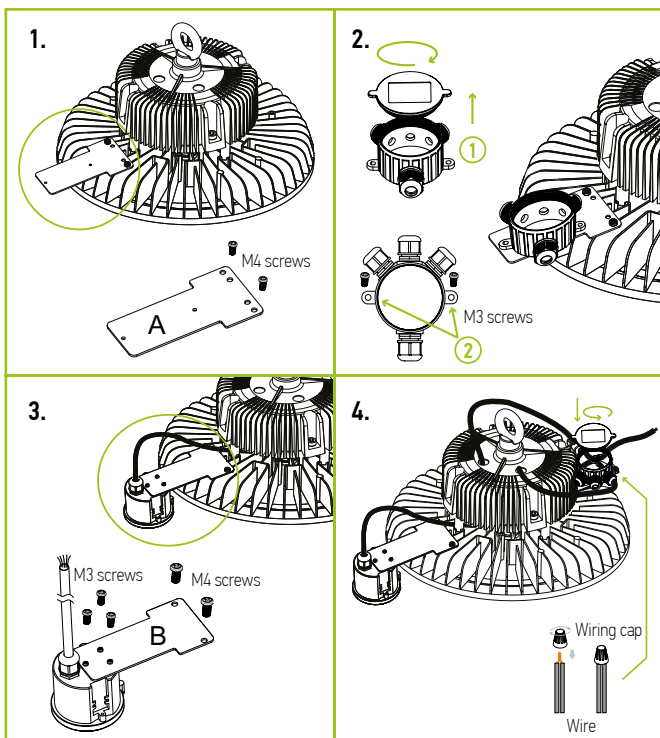

ON FIXTURE WITH AL REFLECTOR

Note: while using PC reflector or PC reflector + conical lens sensor can be installed on fixture body. Installation on reflector needed while using Aluminum reflectors only
Install j-box mounting plate as shown adjacent left (Step 1 and Step 2) for installation on fixture without reflector.

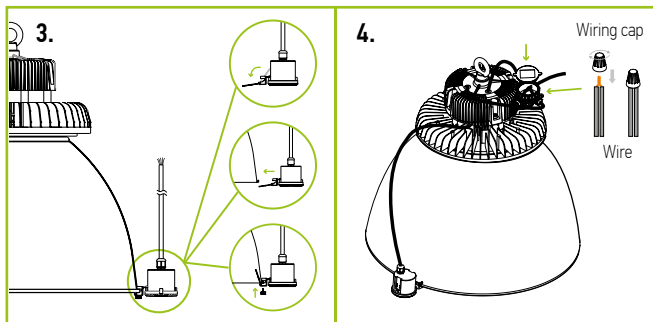

ELECTRICAL SCHEMATIC DIAGRAM:

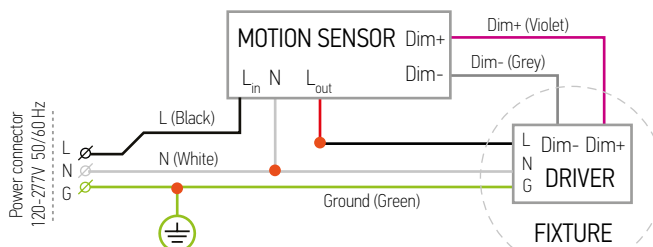

For most up-to-date spec sheets please refer to asd-lighting.com



LED UFO High Bay

Standard and Premium Series

MOTION SENSOR UHB-MSK1 SETTINGS

Please follow the additional motion sensor manual to setup your motion sensor.

USING DIP SWITCHES

Detection area, hold time, stand-by period, stand-by DIM level and daylight sensor can be set by using DIP switches on the sensor. Note that reducing the detection area will also reduce the sensitivity.

ON ↑	1	
I	ON	100%
II	-	50%

Detection area

ON ↑	2	3	4	
I	ON	ON	ON	5s
II	-	ON	ON	30s
III	ON	-	ON	1min
IV	-	-	ON	3min
V	ON	ON	-	20min
VI	-	-	-	30min

Hold time
Refers to the time period the lamp remains at 100% illumination after no motion detected.

ON ↑	1	2	3	
I	ON	ON	ON	0s
II	-	ON	ON	1min
III	ON	-	ON	3min
IV	-	-	ON	10min
V	ON	ON	-	30min
VI	-	-	-	+∞

Stand-by period

Refers to the time period the lamp remains at a pre-set dimming level before it completely switches off in the long absence of people. *When set to 0s, the lamp will work in an on/off function. *When daylight sensor is set to "Disable" and stand-by period to "+", the lamp will work using 2-step dimming control.

ON ↑	4	5	
I	ON	ON	10%
II	ON	-	20%
III	-	ON	30%
IV	-	-	50%

Stand-by dimming level

This is the pre-set dimming level you would like to have after the hold time in the long absence of people.

ON ↑	6	7	8	9	
I	ON	ON	ON	ON	5lux
II	-	ON	ON	ON	15lux
III	ON	-	ON	ON	30Lux
IV	-	-	ON	ON	50Lux
V	ON	ON	-	ON	100Lux
VI	ON	ON	ON	-	150Lux
VII	-	-	-	-	Disable

Daylight sensor





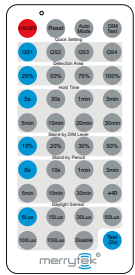

The sensor can be set to only allow the lamp to illuminate below a defined ambient brightness threshold. The settings are as follows: *When set to Disable Mode, the sensor will switch on the lamp when motion is detected regardless of ambient light levels.

USING REMOTE CONTROL UHB-PC-MSK1 (sold separately)



As the control angle of the Infrared Remote Control is fixed (15°), if sensors are installed too close to each other, settings of both sensors will be configured. Please refer to the below chart for the distance of the installation of the sensor:

Mounting height	Distance between sensors
15m	4m
12m	3.4m
9m	2.4m
6m	1.6m
3m	0.8m

Button	Remarks																														
	Press the "ON/OFF" button, the light goes to constant on or constant off mode, sensor is disabled. Press "Reset" or "Auto Mode" button to quit from this mode.																														
	Press "Reset" button, all parameters are same as setting of DIP switch.																														
	Press "Auto Mode" button, the sensor starts to work and all parameter setting will remain the same as the previous status before the light was switched on/off.																														
	Press "DIM Test" button to test dimming function. Sensor will dim automatically and return to normal work mode.																														
	The button "Test(2s)" is for factory testing purpose only. The sensor will go to test mode. Detection sensitivity: 100%. Hold time: 2sec. Stand-by dim level: 10%. Stand-by period: 0s. Daylight sensor: Disable. Test mode can be quit by pressing any button.																														
	<table border="1"> <thead> <tr> <th>Scene Options</th> <th>Detection Area</th> <th>Hold Time</th> <th>Stand-by period</th> <th>Stand-by dim level</th> <th>Daylight Sensor</th> </tr> </thead> <tbody> <tr> <td>QS1</td> <td>100%</td> <td>30s</td> <td>1min</td> <td>10%</td> <td>5Lux</td> </tr> <tr> <td>QS2</td> <td>100%</td> <td>1min</td> <td>3min</td> <td>10%</td> <td>10Lux</td> </tr> <tr> <td>QS3</td> <td>100%</td> <td>5min</td> <td>10min</td> <td>10%</td> <td>30Lux</td> </tr> <tr> <td>QS4</td> <td>100%</td> <td>10min</td> <td>30min</td> <td>10%</td> <td>Disable</td> </tr> </tbody> </table> <p>Note: Detection area / Hold time / Stand-by period / Stand-by dim level / Daylight sensor can be adjusted by pressing corresponding button. The latest setting stays valid.</p>	Scene Options	Detection Area	Hold Time	Stand-by period	Stand-by dim level	Daylight Sensor	QS1	100%	30s	1min	10%	5Lux	QS2	100%	1min	3min	10%	10Lux	QS3	100%	5min	10min	10%	30Lux	QS4	100%	10min	30min	10%	Disable
Scene Options	Detection Area	Hold Time	Stand-by period	Stand-by dim level	Daylight Sensor																										
QS1	100%	30s	1min	10%	5Lux																										
QS2	100%	1min	3min	10%	10Lux																										
QS3	100%	5min	10min	10%	30Lux																										
QS4	100%	10min	30min	10%	Disable																										











MOTION SENSOR UHBHV-MSK2 AND INTEGRATED MICROWAVE MOTION SENSOR (in mod. UHB22) SETTINGS

Please follow the additional motion sensor manual to setup your motion sensor.

USING REMOTE CONTROL ASD-CELPO2H-MS (sold separately)



Remote control waive is 10 ft, every fixture needs to be set up separately

	Press the "ON/OFF" button, the light stays permanently on or off. *Press "Auto Mode", "RESET" or "Scene mode" buttons to quit from this mode.																									
	Press "Auto Mode" button, the sensor starts to work and all settings remain the same before the light gets switched on/off.																									
	Press "RESET" button, products with DIP switch will be controlled by DIP switches																									
Auto Mode																										
Scene mode	<table border="1"> <thead> <tr> <th>Detection area</th> <th>Hold-time</th> <th>Daylight threshold</th> <th>Stand-by period</th> <th>Stand-by dimming level</th> </tr> </thead> <tbody> <tr> <td>SC1</td> <td>100%</td> <td>30s</td> <td>0.2Fc</td> <td>1min</td> </tr> <tr> <td>SC2</td> <td>100%</td> <td>5min</td> <td>1Fc</td> <td>10min</td> </tr> <tr> <td>SC3</td> <td>100%</td> <td>10min</td> <td>5Fc</td> <td>30min</td> </tr> <tr> <td>SC4</td> <td>100%</td> <td>30min</td> <td>Disable</td> <td>+∞</td> </tr> </tbody> </table>	Detection area	Hold-time	Daylight threshold	Stand-by period	Stand-by dimming level	SC1	100%	30s	0.2Fc	1min	SC2	100%	5min	1Fc	10min	SC3	100%	10min	5Fc	30min	SC4	100%	30min	Disable	+∞
Detection area	Hold-time	Daylight threshold	Stand-by period	Stand-by dimming level																						
SC1	100%	30s	0.2Fc	1min																						
SC2	100%	5min	1Fc	10min																						
SC3	100%	10min	5Fc	30min																						
SC4	100%	30min	Disable	+∞																						
	The button "Test (2s)" is for testing purposes. After pressing this button, the sensor goes to test mode(hold time is only 2s) automatically, stand-by period and daylight sensor are disabled. This mode can be ended by pressing «reset», "Auto mode" «scene mode» or «hold time». The sensor setting is changed accordingly. Brightness settings: Disable Test mode (can press any key to exit this mode).																									
	On/off control There are 4 fixed scene mode programs built into the remote control to choose for different applications.		Daylight threshold Press the button "daylight sensor" to set daylight threshold as 0.2Fc / 1Fc / 3Fc / 5Fc / 8Fc / 11Fc / disable.																							
	Detection area Press the button "detection range" to set detection range as 100% / 75% / 50% / 10%.		Stand-by period Press the button "stand-by period" to set stand-by period as 0s / 10s / 30s / 1min / 5min / 10min / 30min / +∞. Note: "0s" means on/off control; "+∞" means bi-level dimming control.																							
	Hold-time Press the button "hold-time" to set hold-time as 5s / 30s / 1min / 3min / 5min / 10min / 20min / 30min.		Stand-by dimming Press the button "stand-by dimming level" to set the stand-by dimming level as 10% / 20% / 30% / 50%.																							

For most up-to-date spec sheets please refer to asd-lighting.com



LED UFO High Bay

Standard and Premium Series

ORDERING INFORMATION

LED UFO HIGH-BAY FIXTURE:

Model	Watts	Motion Sensor	CCT	Pcs in one Carton	Carton Size	Carton Weight	UPC
ASD-UHB2-100D35-STD	100 W	no	3,500 K	1	12.2" x 12.2" x 6.9"	7.7 lb	819201025664
ASD-UHB2-150D35-STD	150 W	no	3,500 K	1	12.2" x 12.2" x 6.9"	7.7 lb	819201025671
ASD-UHB2-200D35-STD	200 W	no	3,500 K	1	12.2" x 12.2" x 7.7"	8.6 lb	819201025688
ASD-UHB2-100D50-PRM	100 W	no	5,000 K	1	12.2" x 12.2" x 6.9"	7.7 lb	819201023486
ASD-UHB2-150D50-PRM	150 W	no	5,000 K	1	12.2" x 12.2" x 6.9"	7.7 lb	819201023493
ASD-UHB2-200D50-PRM	200 W	no	5,000 K	1	12.2" x 12.2" x 7.7"	8.6 lb	819201023509
ASD-UHB2-240D50-PRM	240 W	no	5,000 K	1	15.2" x 15.2" x 7.9"	10 lb	819201024018
ASD-UHB2-300D50-PRM	300 W	no	5,000 K	1	15.2" x 15.2" x 7.9"	17.2 lb	819201025855
ASD-UHB2HV-100D50-PRM	100 W	no	5,000 K	1	12.2" x 12.2" x 6.9"	7.7 lb	819201023516
ASD-UHB2HV-150D50-PRM	150 W	no	5,000 K	1	12.2" x 12.2" x 6.9"	8.4 lb	819201023523
ASD-UHB2HV-200D50-PRM	200 W	no	5,000 K	1	12.2" x 12.2" x 7.7"	9.7 lb	819201023530
ASD-UHB2HV-240D50-PRM	240 W	no	5,000 K	1	15.2" x 15.2" x 7.9"	10 lb	819201026029
ASD-UHB22-100D50-MS-PRM	100 W	yes	5,000 K	1	15.4" x 15.4" x 9.4"	8.6 lb	819201026937
ASD-UHB22-150D50-MS-PRM	150 W	yes	5,000 K	1	15.4" x 15.4" x 9.4"	8.8 lb	819201026944
ASD-UHB22-200D50-MS-PRM	200 W	yes	5,000 K	1	15.4" x 15.4" x 10"	8.8 lb	819201026951
ASD-UHB22-240D50-MS-PRM	240 W	yes	5,000 K	1	15.4" x 15.4" x 10"	9 lb	819201026968
ASD-UHB22-300D50-MS-PRM	300 W	yes	5,000 K	1	15.4" x 15.4" x 10"	13.5 lb	819201026975
ASD-UHB7-240D50-PRM	240 W	yes	5,000 K	1	13" x 13" x 8"	14.8 lb	819201025862
ASD-UHB7-300D50-PRM	300 W	yes	5,000 K	1	15" x 15" x 11"	19.6 lb	819201025879
ASD-UHB7-400D50-PRM	400 W	yes	5,000 K	1	16" x 16" x 11"	24 lb	819201025886
ASD-UHB7-500D50-PRM	500 W	yes	5,000 K	1	16" x 16" x 11"	24.5 lb	819201025893
ASD-UHB7HV-300D50-PRM	300 W	yes	5,000 K	1	15" x 15" x 11"	20 lb	819201025909
ASD-UHB7HV-400D50-PRM	400 W	yes	5,000 K	1	16" x 16" x 11"	24.9 lb	819201025916
ASD-UHB7HV-500D50-PRM	500 W	yes	5,000 K	1	16" x 16" x 11"	24.9 lb	819201025923

ACCESSORIES:

Model	Name	Materials	Weight	Dimensions	
ASD-H02-UHB2	Hook for LED UFO High Bays UHB2	Stainless Steel	0.2 lb (0.1 kg)	3 1/2" x 2 1/8" x 1"	
ASD-SMB100/300-UHB2	Surface mount Bracket for 100/300W LED UFO High Bays UHB2	Iron	1 lb (0.4 kg)	9 11/16" x 3 1/8" x 5 5/16"	
ASD-DUHB-16-90AL	Aluminium Reflector 16" 90° for LED UFO High Bays UHB	Aluminum	1.4 lb (0.6 kg)	15 3/4" x 5 1/8"	
ASD-DUHB-21-120ALG	Aluminium Reflector 21" 120° for LED UFO High Bays UHB	Aluminum	1.1 lb (0.5 kg)	21" x 4 1/8"	
ASD-DUHB-16-90PC	Polycarbonate Reflector 16" 90° for LED UFO High Bays UHB	Polycarbonate	1.4 lb (0.6 kg)	16 1/4" x 3 7/8"	
ASD-DUHB-19-90PC	Polycarbonate Reflector 19" 90° for LED UFO High Bays UHB	Polycarbonate	1.3 lb (0.6 kg)	18 7/8" x 5 1/2"	
ASD-BLUHB-16PC	Polycarbonate Bottom Conical Lens for 16" Reflector DUHB	Polycarbonate	1.1 lb (0.5 kg)	16" x 1 1/4"	
ASD-BLUHB-19PC	Polycarbonate Bottom Conical Lens for 19" Reflector DUHB	Polycarbonate	1.4 lb (0.6 kg)	18 3/4" x 1 5/8"	
UHB-MSK1	Microwave motion sensor kit for LED UFO High Bays UHB	Polycarbonate	1 lb (0.4 kg)	3 1/8" x 2 1/2"	
UHB-RC-MSK1	Remote Control	Nylon	0.1 lb (0.04 kg)	4 1/2" x 2 1/8" x 1/2"	
UHBHV-MSK2	Microwave motion sensor kit High Voltage for LED UFO High Bays UHB	Polycarbonate	1.1 lb (0.5 kg)	3 1/8" x 2 1/2"	
ASD-CELP02H-MS	Remote Control	Nylon	0.1 lb (0.04 kg)	2" x 1" x 1/2"	
LLT-M19CS03	Inline Wire Connector	Nylon	0.1 lb (0.04 kg)	7 5/8" x 2 1/8"	
ASD-CRD6-TLP-277V	6-foot Cord 120V-277V 3-Blade Twist-Lock Plug	PVC+PC	0.6 lbs (0.3 kg)	70 7/8" x 3/8"	
ASD-CRD6-SBP-277V	6-foot Cord 120V-277V Straight Blade Plug	PVC+PC	0.7 lbs (0.3 kg)	70 7/8" x 3/8"	
Model	Pcs in one Carton	Carton Size	Carton Weight	UPC	GTIN 14
ASD-H02-UHB2	200	18.3" x 9.3" x 10.6"	41.7 lbs	819201025312	10819201025319
ASD-SMB100/300-UHB2	20	20.3" x 16.9" x 11.8"	23.1 lbs	819201026999	10819201026996
ASD-DUHB-16-90AL	20	16.5" x 16.5" x 14.6"	16.8 lbs	819201020621	10819201020628
ASD-DUHB-21-120ALG	10	22" x 22" x 7.5"	14.6 lbs	819201020638	10819201020635
ASD-DUHB-16-90PC	10	16.9" x 16.9" x 7.9"	16.8 lbs	819201020607	10819201020604
ASD-DUHB-19-90PC	10	19.7" x 19.7" x 9.1"	16.1 lbs	819201020614	10819201020611
ASD-BLUHB-16PC	10	16.9" x 16.9" x 5.1"	11.7 lbs	819201020645	10819201020642
ASD-BLUHB-19PC	10	19.7" x 19.7" x 5.1"	16.1 lbs	819201020652	10819201020659
UHB-MSK1	40	20.7" x 12.4" x 19"	49.0 lbs	819201021994	10819201021991
UHB-RC-MSK1	100	9.8" x 6.9" x 12"	11.3 lbs	819201022007	10819201022004
UHBHV-MSK2	32	21.9" x 14.8" x 12.6"	40.2 lbs	819201025848	20819201025842
ASD-CELP02H-MS	50	11.4" x 6.5" x 5.3"	6.6 lbs	819201023479	10819201023476
LLT-M19CS03	1000	17.7" x 11" x 10.2"	55.1 lbs	819201020591	10819201020598
ASD-CRD6-TLP-277V	25	10.8" x 9.8" x 11.6"	15.9 lbs	819201026296	10819201026293
ASD-CRD6-SBP-277V	25	10.8" x 9.8" x 11.6"	17.6 lbs	819201026302	10819201026309

For most up-to-date spec sheets please refer to asd-lighting.com

ASD LIGHTING CORP

E-mail: orders@asd-lighting.com | Web site: www.asd-lighting.com





LED UFO High Bay

Standard and Premium Series

Our UFO style round high bay is the latest in LED technology. More efficient and longer lasting, our IP65 – WET location rated, LED UFO high bay fixture achieves desired light levels while using less power per fixture than most other LED High bay fixtures. Light can be dimmed to ideal brightness levels to save energy and achieve the exact light level needed for your application.

This one-piece aluminum heat sink provides excellent thermal management and gives the fixture it's water-tight IP65 rating. This fixture features Integrated dimming and can be used with 1-10v, PWM and VR dimmers to save energy and achieve specific light levels. Optional accessories include 16" and 21" aluminum reflectors, 16" and 19" polycarbonate reflectors and diffusers, and twist lock connectors.

This fixture is the perfect commercial or industrial solution for warehouses, supermarkets, retail stores, gyms, garages, general task areas and many other applications.

Catalog number	
Notes	
Type	



FEATURES AND BENEFITS:

- ▶ Integrated sensor models are available
- ▶ Dimmable (1-10v, PWM and VR dimmers)
- ▶ PF/THD: > 0.9 / < 15%
- ▶ Operating temperature -22 to 122°F (-30 to 50°C)
- ▶ L-70 Life > 54,000 hrs
- ▶ cULus listed
- ▶ Design Lights Consortium (DLC) listed (Classification: Standard and Premium Series)
- ▶ 5 Year warranty

PRODUCT LEGEND:

Family	Modification	Voltage	Watts	Dimmable	CCT	Option	Series
ASD-UHB	XX	XX	XX	D	XX	MS	XXX
LED UFO High Bay	2	Blank = Regular	100 = 100 W; 150 = 150 W	Dimmable	35 = 3,500 K	Motion sensor	STD = Standard
	22	HV = High Voltage	200 = 200 W; 240 = 240 W		50 = 5,000 K		PRM = Premium
	7		300 = 300 W; 400 = 400 W				
			500 = 500 W				

LED UFO HIGH BAY FIXTURE:

Model	Watts	Voltage	Dimming	Motion Sensor	CCT	Lumens	Dimensions (LxWxH)	Cord
ASD-UHB2-100D35-STD	100 W	120-277V	yes	-	3,500 K	12,799 lm	10 1/4" x 10 1/4" x 5 1/16"	4 ft
ASD-UHB2-150D35-STD	150 W	120-277V	yes	-	3,500 K	18,069 lm	10 1/4" x 10 1/4" x 5 1/16"	4 ft
ASD-UHB2-200D35-STD	200 W	120-277V	yes	-	3,500 K	24,706 lm	10 1/4" x 10 1/4" x 5 15/16"	4 ft
ASD-UHB2-100D50-PRM	100 W	120-277V	yes	-	5,000 K	15,288 lm	10 1/4" x 10 1/4" x 5 5/16"	4 ft
ASD-UHB2-150D50-PRM	150 W	120-277V	yes	-	5,000 K	22,703 lm	10 1/4" x 10 1/4" x 5 5/16"	4 ft
ASD-UHB2-200D50-PRM	200 W	120-277V	yes	-	5,000 K	29,776 lm	10 1/4" x 10 1/4" x 5 15/16"	4 ft
ASD-UHB2-240D50-PRM	240 W	120-277V	yes	-	5,000 K	35,623 lm	12 5/8" x 12 5/8" x 5 5/8"	4 ft
ASD-UHB2-300D50-PRM	300 W	120-277V	yes	-	5,000 K	41,350 lm	12 5/8" x 12 5/8" x 6 3/16"	4 ft
ASD-UHB2HV-100D50-PRM	100 W	200-480V	yes	-	5,000 K	13,905 lm	10 1/4" x 10 1/4" x 5 5/16"	4 ft
ASD-UHB2HV-150D50-PRM	150 W	200-480V	yes	-	5,000 K	20,510 lm	10 1/4" x 10 1/4" x 5 5/16"	4 ft
ASD-UHB2HV-200D50-PRM	200 W	200-480V	yes	-	5,000 K	26,921 lm	10 1/4" x 10 1/4" x 6 5/16"	4 ft
ASD-UHB2HV-240D50-PRM	240 W	200-480V	yes	-	5,000 K	33,286 lm	12 5/8" x 12 5/8" x 5 3/4"	4 ft
ASD-UHB22-100D50-MS-PRM	100 W	120-277V	yes	yes	5,000 K	15,144 lm	12 5/8" x 12 5/8" x 7 1/2"	4 ft
ASD-UHB22-150D50-MS-PRM	150 W	120-277V	yes	yes	5,000 K	22,622 lm	12 5/8" x 12 5/8" x 7 1/2"	4 ft
ASD-UHB22-200D50-MS-PRM	200 W	120-277V	yes	yes	5,000 K	29,789 lm	12 5/8" x 12 5/8" x 8 1/8"	4 ft
ASD-UHB22-240D50-MS-PRM	240 W	120-277V	yes	yes	5,000 K	35,623 lm	12 5/8" x 12 5/8" x 8 1/8"	4 ft
ASD-UHB22-300D50-MS-PRM	300 W	120-277V	yes	yes	5,000 K	41,832 lm	12 5/8" x 12 5/8" x 8 5/8"	4 ft
ASD-UHB7-240D50-PRM	240 W	120-277V	yes	-	5,000 K	36,272 lm	11 3/8" x 11 3/8" x 8 3/8"	4 ft
ASD-UHB7-300D50-PRM	300 W	120-277V	yes	-	5,000 K	45,760 lm	12 5/8" x 12 5/8" x 10 1/2"	4 ft
ASD-UHB7-400D50-PRM	400 W	120-277V	yes	-	5,000 K	60,967 lm	14 1/8" x 14 1/8" x 14 1/4"	4 ft
ASD-UHB7-500D50-PRM	500 W	120-277V	yes	-	5,000 K	75,234 lm	14 1/8" x 14 1/8" x 14 1/4"	4 ft
ASD-UHB7HV-300D50-PRM	300 W	200-480V	yes	-	5,000 K	44,816 lm	12 5/8" x 12 5/8" x 10 1/2"	4 ft
ASD-UHB7HV-400D50-PRM	400 W	200-480V	yes	-	5,000 K	60,143 lm	14 1/8" x 14 1/8" x 14 1/4"	4 ft
ASD-UHB7HV-500D50-PRM	500 W	200-480V	yes	-	5,000 K	74,896 lm	14 1/8" x 14 1/8" x 14 1/4"	4 ft

For most up-to-date spec sheets please refer to asd-lighting.com



LED UFO High Bay

Standard and Premium Series

PRODUCT SPECIFICATIONS:

Construction & Materials						
Housing	Die cast Aluminum					
Finish	Black					
Weight	ASD-UHB2-100D35-STD	6 lb (2.7 kg)	ASD-UHB2HV-100D50-PRM	6 lb (2.7 kg)	ASD-UHB7-240D50-PRM	11.5 lb (5.2 kg)
	ASD-UHB2-150D35-STD	6 lb (2.7 kg)	ASD-UHB2HV-150D50-PRM	6.6 lb (3 kg)	ASD-UHB7-300D50-PRM	16.3 lb (7.4 kg)
	ASD-UHB2-200D35-STD	7.1 lb (3.2 kg)	ASD-UHB2HV-200D50-PRM	8.4 lb (3.8 kg)	ASD-UHB7-400D50-PRM	20.7 lb (9.4 kg)
	ASD-UHB2-100D50-PRM	6 lb (2.7 kg)	ASD-UHB2HV-240D50-PRM	8.4 lb (3.8 kg)	ASD-UHB7-500D50-PRM	21.2 lb (9.6 kg)
	ASD-UHB2-150D50-PRM	6 lb (2.7 kg)	ASD-UHB22-100D50-MS-PRM	6.5 lb (3 kg)	ASD-UHB7HV-300D50-PRM	16.8 lb (7.6 kg)
	ASD-UHB2-200D50-PRM	7.1 lb (3.2 kg)	ASD-UHB22-150D50-MS-PRM	6.7 lb (3 kg)	ASD-UHB7HV-400D50-PRM	21.6 lb (9.8 kg)
	ASD-UHB2-240D50-PRM	8.4 lb (3.8 kg)	ASD-UHB22-200D50-MS-PRM	6.7 lb (3 kg)	ASD-UHB7HV-500D50-PRM	21.6 lb (9.8 kg)
	ASD-UHB2-300D50-PRM	15 lb (6.8 kg)	ASD-UHB22-240D50-MS-PRM	7.1 lb (3.2 kg)		
			ASD-UHB22-300D50-MS-PRM	11.5 lb (5.2 kg)		
Environmental System						
Work Environment	Suitable for Wet Locations, IP65					
Operating Temperature	-22°F to 122°F (-30°C to 50°C)					
L-70 Life	UHB2 / UHB2HV	> 54,000 hrs	UHB22 / UHB7 / UHB7HV	> 50,000 hrs		
Optical System						
Luminous Flux	ASD-UHB2-100D35-STD	12,799 lm	ASD-UHB2HV-100D50-PRM	13,905 lm	ASD-UHB7-240D50-PRM	36,272 lm
	ASD-UHB2-150D35-STD	18,069 lm	ASD-UHB2HV-150D50-PRM	20,510 lm	ASD-UHB7-300D50-PRM	45,760 lm
	ASD-UHB2-200D35-STD	24,706 lm	ASD-UHB2HV-200D50-PRM	26,921 lm	ASD-UHB7-400D50-PRM	60,967 lm
	ASD-UHB2-100D50-PRM	15,288 lm	ASD-UHB2HV-240D50-PRM	33,286 lm	ASD-UHB7-500D50-PRM	75,234 lm
	ASD-UHB2-150D50-PRM	22,703 lm	ASD-UHB22-100D50-MS-PRM	15,144 lm	ASD-UHB7HV-300D50-PRM	44,816 lm
	ASD-UHB2-200D50-PRM	29,776 lm	ASD-UHB22-150D50-MS-PRM	22,622 lm	ASD-UHB7HV-400D50-PRM	60,143 lm
	ASD-UHB2-240D50-PRM	35,623 lm	ASD-UHB22-200D50-MS-PRM	29,789 lm	ASD-UHB7HV-500D50-PRM	74,896 lm
	ASD-UHB2-300D50-PRM	41,350 lm	ASD-UHB22-240D50-MS-PRM	35,623 lm		
			ASD-UHB22-300D50-MS-PRM	41,832 lm		
Color Temperature	3,500 K, 5,000 K					
CRI	ASD-UHB2-100D35-STD	>70	ASD-UHB2HV-100D50-PRM	>80	ASD-UHB7-240D50-PRM	>70
	ASD-UHB2-150D35-STD		ASD-UHB2HV-150D50-PRM		ASD-UHB7-300D50-PRM	
	ASD-UHB2-200D35-STD		ASD-UHB2HV-200D50-PRM		ASD-UHB7-400D50-PRM	
	ASD-UHB2-100D50-PRM	>70	ASD-UHB2HV-240D50-PRM	>70	ASD-UHB7-500D50-PRM	>70
	ASD-UHB2-150D50-PRM		ASD-UHB22-100D50-MS-PRM	ASD-UHB7HV-300D50-PRM		
	ASD-UHB2-200D50-PRM		ASD-UHB22-150D50-MS-PRM	ASD-UHB7HV-400D50-PRM		
	ASD-UHB2-240D50-PRM	>80	ASD-UHB22-200D50-MS-PRM	>80	ASD-UHB7HV-500D50-PRM	
	ASD-UHB2-300D50-PRM		ASD-UHB22-240D50-MS-PRM			
		ASD-UHB22-300D50-MS-PRM				
Electrical System						
Input Voltage	ASD-UHB2-100D35-STD	120-277VAC 50/60Hz	ASD-UHB2HV-100D50-PRM	200-480VAC 50/60Hz	ASD-UHB7-240D50-PRM	120-277VAC 50/60Hz
	ASD-UHB2-150D35-STD		ASD-UHB2HV-150D50-PRM		ASD-UHB7-300D50-PRM	
	ASD-UHB2-200D35-STD		ASD-UHB2HV-200D50-PRM		ASD-UHB7-400D50-PRM	
	ASD-UHB2-100D50-PRM		ASD-UHB2HV-240D50-PRM		ASD-UHB7-500D50-PRM	
	ASD-UHB2-150D50-PRM		ASD-UHB22-100D50-MS-PRM	ASD-UHB7HV-300D50-PRM	200-480VAC 50/60Hz	
	ASD-UHB2-200D50-PRM		ASD-UHB22-150D50-MS-PRM	ASD-UHB7HV-400D50-PRM		
	ASD-UHB2-240D50-PRM		ASD-UHB22-200D50-MS-PRM	ASD-UHB7HV-500D50-PRM		
	ASD-UHB2-300D50-PRM		ASD-UHB22-240D50-MS-PRM			
		ASD-UHB22-300D50-MS-PRM				
Max input current	ASD-UHB2-100D35-STD	1.44 A	ASD-UHB2HV-100D50-PRM	0.6 A	ASD-UHB7-240D50-PRM	0.6 A
	ASD-UHB2-150D35-STD	1.8 A	ASD-UHB2HV-150D50-PRM	0.9 A	ASD-UHB7-300D50-PRM	
	ASD-UHB2-200D35-STD	2.4 A	ASD-UHB2HV-200D50-PRM	1.2 A	ASD-UHB7-400D50-PRM	
	ASD-UHB2-100D50-PRM	1.44 A	ASD-UHB2HV-240D50-PRM	1.2 A	ASD-UHB7-500D50-PRM	
	ASD-UHB2-150D50-PRM	1.8 A	ASD-UHB22-100D50-MS-PRM	0.6 A	ASD-UHB7HV-300D50-PRM	0.6 A
	ASD-UHB2-200D50-PRM	2.4 A	ASD-UHB22-150D50-MS-PRM		ASD-UHB7HV-400D50-PRM	
	ASD-UHB2-240D50-PRM	2.88 A	ASD-UHB22-200D50-MS-PRM		ASD-UHB7HV-500D50-PRM	
	ASD-UHB2-300D50-PRM	3.6 A	ASD-UHB22-240D50-MS-PRM			
		ASD-UHB22-300D50-MS-PRM				
Inrush current (Action time)	ASD-UHB2-100D35-STD	100 A (0.15 S)	ASD-UHB2HV-100D50-PRM	60 A (0.5 S)	ASD-UHB7-240D50-PRM	35 A (<1 S)
	ASD-UHB2-150D35-STD	130 A (0.15 S)	ASD-UHB2HV-150D50-PRM		ASD-UHB7-300D50-PRM	35 A (0.5 S)
	ASD-UHB2-200D35-STD	100 A (0.15 S)	ASD-UHB2HV-200D50-PRM		ASD-UHB7-400D50-PRM	
	ASD-UHB2-100D50-PRM	100 A (0.15 S)	ASD-UHB2HV-240D50-PRM		ASD-UHB7-500D50-PRM	
	ASD-UHB2-150D50-PRM	130 A (0.15 S)	ASD-UHB22-100D50-MS-PRM	1.44 A (0.15 S)	ASD-UHB7HV-300D50-PRM	
	ASD-UHB2-200D50-PRM		ASD-UHB22-150D50-MS-PRM	1.8 A (0.15 S)	ASD-UHB7HV-400D50-PRM	
	ASD-UHB2-240D50-PRM		ASD-UHB22-200D50-MS-PRM	2.4 A (0.15 S)	ASD-UHB7HV-500D50-PRM	
	ASD-UHB2-300D50-PRM		ASD-UHB22-240D50-MS-PRM	2.88 A (0.15 S)		
	120 A (0.8 S)	ASD-UHB22-300D50-MS-PRM	3.6 A (0.8 S)			

For most up-to-date spec sheets please refer to asd-lighting.com



LED UFO High Bay

Standard and Premium Series

Electrical System						
AC input range	ASD-UHB2-100D35-STD	min 90 V max 305 V	ASD-UHB2HV-100D50-PRM	min 180 V max 528 V	ASD-UHB7-240D50-PRM	
	ASD-UHB2-150D35-STD		ASD-UHB2HV-150D50-PRM		ASD-UHB7-300D50-PRM	
	ASD-UHB2-200D35-STD		ASD-UHB2HV-200D50-PRM		ASD-UHB7-400D50-PRM	
	ASD-UHB2-100D50-PRM	min 90 V max 305 V	ASD-UHB2HV-240D50-PRM	min 90 V max 305 V	ASD-UHB7-500D50-PRM	
	ASD-UHB2-150D50-PRM		ASD-UHB22-100D50-MS-PRM		ASD-UHB7HV-300D50-PRM	
	ASD-UHB2-200D50-PRM		ASD-UHB22-150D50-MS-PRM		ASD-UHB7HV-400D50-PRM	
ASD-UHB2-240D50-PRM	ASD-UHB22-200D50-MS-PRM		ASD-UHB7HV-500D50-PRM			
ASD-UHB2-300D50-PRM		ASD-UHB22-240D50-MS-PRM				
ASD-UHB22-300D50-MS-PRM		ASD-UHB22-300D50-MS-PRM				
Off State Power	0 W					
Power Consumption	ASD-UHB2-100D35-STD	100 W	ASD-UHB2HV-100D50-PRM	100 W	ASD-UHB7-240D50-PRM	240 W
	ASD-UHB2-150D35-STD	150 W	ASD-UHB2HV-150D50-PRM	150 W	ASD-UHB7-300D50-PRM	300 W
	ASD-UHB2-200D35-STD	200 W	ASD-UHB2HV-200D50-PRM	200 W	ASD-UHB7-400D50-PRM	400 W
	ASD-UHB2-100D50-PRM	100 W	ASD-UHB2HV-240D50-PRM	240 W	ASD-UHB7-500D50-PRM	500 W
	ASD-UHB2-150D50-PRM	150 W	ASD-UHB22-100D50-MS-PRM	100 W	ASD-UHB7HV-300D50-PRM	300 W
	ASD-UHB2-200D50-PRM	200 W	ASD-UHB22-150D50-MS-PRM	150 W	ASD-UHB7HV-400D50-PRM	400 W
	ASD-UHB2-240D50-PRM	240 W	ASD-UHB22-200D50-MS-PRM	200 W	ASD-UHB7HV-500D50-PRM	500 W
	ASD-UHB2-300D50-PRM	300 W	ASD-UHB22-240D50-MS-PRM	240 W		
		ASD-UHB22-300D50-MS-PRM	300 W			
Power Factor	ASD-UHB2-100D35-STD	0.96	ASD-UHB2HV-100D50-PRM	0.95	ASD-UHB7-240D50-PRM	
	ASD-UHB2-150D35-STD	0.97	ASD-UHB2HV-150D50-PRM		ASD-UHB7-300D50-PRM	
	ASD-UHB2-200D35-STD	0.97	ASD-UHB2HV-200D50-PRM		ASD-UHB7-400D50-PRM	
	ASD-UHB2-100D50-PRM	0.96	ASD-UHB2HV-240D50-PRM		ASD-UHB7-500D50-PRM	
	ASD-UHB2-150D50-PRM	0.97	ASD-UHB22-100D50-MS-PRM	> 0.9	ASD-UHB7HV-300D50-PRM	
	ASD-UHB2-200D50-PRM	0.97	ASD-UHB22-150D50-MS-PRM		ASD-UHB7HV-400D50-PRM	
	ASD-UHB2-240D50-PRM	0.97	ASD-UHB22-200D50-MS-PRM		ASD-UHB7HV-500D50-PRM	
	ASD-UHB2-300D50-PRM	0.98	ASD-UHB22-240D50-MS-PRM			
		ASD-UHB22-300D50-MS-PRM				
Output voltage	ASD-UHB2-100D35-STD	130 V	ASD-UHB2HV-100D50-PRM	58 V	ASD-UHB7-240D50-PRM	
	ASD-UHB2-150D35-STD	260 V	ASD-UHB2HV-150D50-PRM		ASD-UHB7-300D50-PRM	
	ASD-UHB2-200D35-STD		ASD-UHB2HV-200D50-PRM		ASD-UHB7-400D50-PRM	
	ASD-UHB2-100D50-PRM	130 V	ASD-UHB2HV-240D50-PRM		ASD-UHB7-500D50-PRM	
	ASD-UHB2-150D50-PRM		ASD-UHB22-100D50-MS-PRM	130 V	ASD-UHB7HV-300D50-PRM	
	ASD-UHB2-200D50-PRM	260 V	ASD-UHB22-150D50-MS-PRM		ASD-UHB7HV-400D50-PRM	
	ASD-UHB2-240D50-PRM		ASD-UHB22-200D50-MS-PRM	260 V	ASD-UHB7HV-500D50-PRM	
	ASD-UHB2-300D50-PRM	56 V	ASD-UHB22-240D50-MS-PRM			
		ASD-UHB22-300D50-MS-PRM	56 V			
Max output current	ASD-UHB2-100D35-STD	920 mA	ASD-UHB2HV-100D50-PRM	1.65 A	ASD-UHB7-240D50-PRM	1.85 A
	ASD-UHB2-150D35-STD	570 mA	ASD-UHB2HV-150D50-PRM	2.6 A	ASD-UHB7-300D50-PRM	5.6 A
	ASD-UHB2-200D35-STD	770 mA	ASD-UHB2HV-200D50-PRM	4.1 A	ASD-UHB7-400D50-PRM	7.6 A
	ASD-UHB2-100D50-PRM	920 mA	ASD-UHB2HV-240D50-PRM	4.1 A	ASD-UHB7-500D50-PRM	9.5 A
	ASD-UHB2-150D50-PRM	570 mA	ASD-UHB22-100D50-MS-PRM	920 mA	ASD-UHB7HV-300D50-PRM	5.6 A
	ASD-UHB2-200D50-PRM	770 mA	ASD-UHB22-150D50-MS-PRM	570 mA	ASD-UHB7HV-400D50-PRM	7.6 A
	ASD-UHB2-240D50-PRM	920 mA	ASD-UHB22-200D50-MS-PRM	770 mA	ASD-UHB7HV-500D50-PRM	9.5 A
	ASD-UHB2-300D50-PRM	5.4 A	ASD-UHB22-240D50-MS-PRM	920 mA		
		ASD-UHB22-300D50-MS-PRM	5.4 A			
LED driver class	ASD-UHB2-100D35-STD	Non-isolated	ASD-UHB2HV-100D50-PRM	Class 2	ASD-UHB7-240D50-PRM	
	ASD-UHB2-150D35-STD		ASD-UHB2HV-150D50-PRM	Isolated	ASD-UHB7-300D50-PRM	
	ASD-UHB2-200D35-STD		ASD-UHB2HV-200D50-PRM		ASD-UHB7-400D50-PRM	
	ASD-UHB2-100D50-PRM		ASD-UHB2HV-240D50-PRM	ASD-UHB7-500D50-PRM		
	ASD-UHB2-150D50-PRM	Non-isolated	ASD-UHB22-100D50-MS-PRM	-	ASD-UHB7HV-300D50-PRM	
	ASD-UHB2-200D50-PRM		ASD-UHB22-150D50-MS-PRM		ASD-UHB7HV-400D50-PRM	
	ASD-UHB2-240D50-PRM		ASD-UHB22-200D50-MS-PRM		ASD-UHB7HV-500D50-PRM	
	ASD-UHB2-300D50-PRM		ASD-UHB22-240D50-MS-PRM			
	HL	ASD-UHB22-300D50-MS-PRM				
		ASD-UHB22-300D50-MS-PRM				
Dimming compatible controls			Regular and Voluntary Certifications			
Brand	Leviton	Lutron	5-year limited warranty			
Models	ZS057-DOZ	DVTV	UHB22 series not compatible with dimmers	cULus listed		
	IP710	DVSTV		E473804		
	DS710	NTSTV		DesignLights Consortium (DLC) listed (Classification: Standard and Premium series)		
	DD710	MS-Z101	- Main: Indoor Luminaires; - General Application: High-Bay; - Primary Use: High-Bay Luminaires for Commercial and Industrial Buildings			

This fixture features Integrated dimming and can be 1-10v, PWM signal or resistance dimming to save energy and achieve specific light levels. The LED UFO High Bay is designed to install as a surface mounted luminaire.

For most up-to-date spec sheets please refer to asd-lighting.com

ASD LIGHTING CORP

E-mail: orders@asd-lighting.com | Web site: www.asd-lighting.com





LED UFO High Bay

Standard and Premium Series

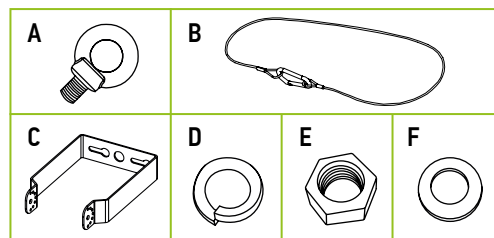

PACKAGE CONTENTS:

Description	Q-ty
LED High Bay Fixture	1
Mounting ring (A)	1
Safety cable (B)	1
Surface mount bracket (C)**	1
M12 Spring washer (D)*	1
M18 Nut (E)**	1
M18 Flat Washer (F)**	2
Box	1
Installation Instructions	3

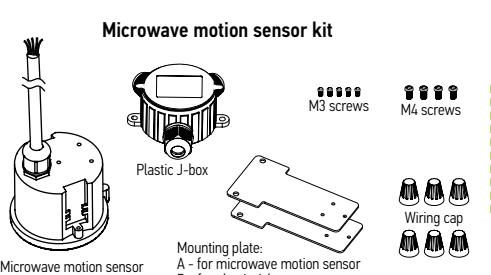
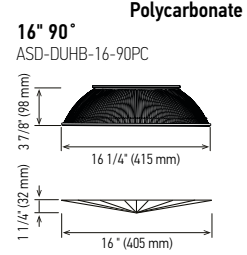
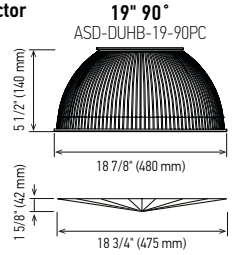
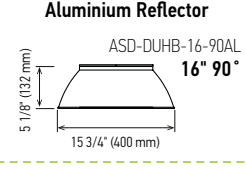
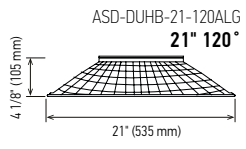
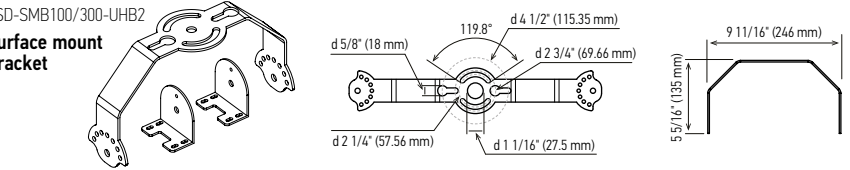

*Only for UHB7 modification
 **Only for UHB7 modification (300W, 400W, 500W models)

ACCESSORIES (sold separately):

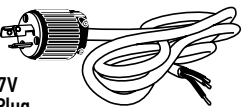
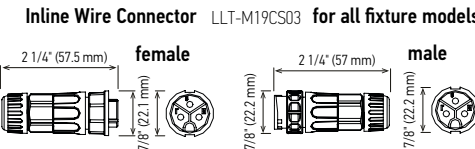
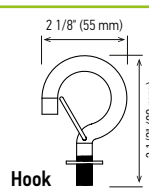
Accessories models	Fixture models
<p>Microwave motion sensor kit</p>  <p>Microwave motion sensor Plastic J-box Mounting plate: A - for microwave motion sensor B - for plastic J-box</p> <p>M3 screws M4 screws Wiring cap</p> <p>for regular voltage UHB-MSK1</p> <p>for high voltage UHBHV-MSK2</p>	<p>Remote Control for UHB-MSK1 UHB-RC-MSK1</p> <p>Remote Control for UHBHV-MSK2 ASD-CELP02H-MS</p> <p>ASD-UHB2-100D35-STD ASD-UHB2-150D35-STD ASD-UHB2-200D35-STD ASD-UHB7-240D50-PRM ASD-UHB7-300D50-PRM</p> <p>ASD-UHB2-100D50-PRM ASD-UHB2-150D50-PRM ASD-UHB2-200D50-PRM ASD-UHB2-240D50-PRM ASD-UHB2-300D50-PRM</p>
<p>Polycarbonate Reflector</p> <p>16" 90° ASD-DUHB-16-90PC</p>  <p>3 7/8" (98 mm) 16 1/4" (415 mm)</p> <p>for 16" ASD-BLUHB-16PC</p> <p>19" 90° ASD-DUHB-19-90PC</p>  <p>5 1/2" (140 mm) 18 7/8" (480 mm)</p> <p>for 19" ASD-BLUHB-19PC</p> <p>Aluminium Reflector</p> <p>16" 90° ASD-DUHB-16-90AL</p>  <p>5 1/8" (132 mm) 15 3/4" (400 mm)</p> <p>21" 120° ASD-DUHB-21-120ALG</p>  <p>4 1/8" (105 mm) 21" (535 mm)</p>	<p>ASD-UHB2-100D35-STD ASD-UHB2-150D35-STD ASD-UHB2-200D35-STD</p> <p>ASD-UHB2-100D50-PRM ASD-UHB2-150D50-PRM ASD-UHB2-200D50-PRM ASD-UHB2-240D50-PRM ASD-UHB2-300D50-PRM</p> <p>ASD-UHB22-100D50-MS-PRM ASD-UHB22-150D50-MS-PRM ASD-UHB22-200D50-MS-PRM ASD-UHB22-240D50-MS-PRM ASD-UHB22-300D50-MS-PRM</p> <p>ASD-UHB7-240D50-PRM ASD-UHB7-300D50-PRM</p> <p>ASD-UHB7HV-300D50-PRM</p>
<p>Polycarbonate Bottom Conical Lens</p> <p>ASD-SMB100/300-UHB2</p> <p>Surface mount Bracket</p>  <p>9 11/16" (246 mm) 5 5/16" (135 mm)</p> <p>ASD-UHB2-100D35-STD ASD-UHB2-150D35-STD ASD-UHB2-200D35-STD</p> <p>ASD-UHB2-100D50-PRM ASD-UHB2-150D50-PRM ASD-UHB2-200D50-PRM ASD-UHB2-240D50-PRM ASD-UHB2-300D50-PRM</p> <p>ASD-UHB22-100D50-MS-PRM ASD-UHB22-150D50-MS-PRM ASD-UHB22-200D50-MS-PRM ASD-UHB22-240D50-MS-PRM ASD-UHB22-300D50-MS-PRM</p>	<p>ASD-UHB2-100D35-STD ASD-UHB2-150D35-STD ASD-UHB2-200D35-STD</p> <p>ASD-UHB2-100D50-PRM ASD-UHB2-150D50-PRM ASD-UHB2-200D50-PRM ASD-UHB2-240D50-PRM ASD-UHB2-300D50-PRM</p> <p>ASD-UHB22-100D50-MS-PRM ASD-UHB22-150D50-MS-PRM ASD-UHB22-200D50-MS-PRM ASD-UHB22-240D50-MS-PRM ASD-UHB22-300D50-MS-PRM</p>
<p>6-foot Cord 120V-277V Straight Blade Plug ASD-CRD6-SBP-277V</p>  <p>6-foot Cord 120V-277V 3-Blade Twist-Lock Plug ASD-CRD6-TLP-277V</p> 	<p>ASD-UHB2-100D35-STD ASD-UHB2-150D35-STD ASD-UHB2-200D35-STD</p> <p>ASD-UHB2-100D50-PRM ASD-UHB2-150D50-PRM ASD-UHB2-200D50-PRM ASD-UHB2-240D50-PRM ASD-UHB2-300D50-PRM</p> <p>ASD-UHB7-240D50-PRM ASD-UHB7-300D50-PRM ASD-UHB7-400D50-PRM ASD-UHB7-500D50-PRM</p>
<p>Inline Wire Connector LLT-M19CS03 for all fixture models</p>  <p>female 2 1/4" (57.5 mm) 7/8" (22.1 mm)</p> <p>male 2 1/4" (57 mm) 7/8" (22.2 mm)</p> <p>Note: For power wiring ONLY. Do not use for dimmer wires</p>	<p>Hook ASD-H02-UHB2</p>  <p>2 1/8" (55 mm) 3 1/2" (90 mm)</p> <p>ASD-UHB2-100D35-STD ASD-UHB2-150D35-STD ASD-UHB2-200D35-STD</p> <p>ASD-UHB2-100D50-PRM ASD-UHB2-150D50-PRM ASD-UHB2-200D50-PRM</p> <p>ASD-UHB2HV-100D50-PRM ASD-UHB2HV-150D50-PRM ASD-UHB2HV-200D50-PRM</p> <p>ASD-UHB22-100D50-MS-PRM ASD-UHB22-150D50-MS-PRM ASD-UHB22-200D50-MS-PRM</p>

For most up-to-date spec sheets please refer to asd-lighting.com



LED UFO High Bay

Standard and Premium Series

INSTALLATION GUIDE

IMPORTANT SAFETY INFORMATION:

Please read all the instructions below before installation.

- ▶ Make sure that the supply voltage corresponds to the rated product voltage.
- ▶ The product must be installed by a qualified electrician in accordance with the National Electrical Code and corresponding local codes.
- ▶ If the product is damaged, do not use it.

⚠ WARNING

RISK OF PERSONAL INJURY – READ and follow all WARNINGS and installation instructions.

Keep or give to the owner for future reference.

Risk of cuts: Wear gloves to prevent cuts or abrasions when removing from carton, handling, installing, and maintaining this product.

Risk of electric shock: This product must be installed in accordance with the applicable installation code by a person familiar with the construction and operation of the product and the hazards involved.

Risk of Fire: Minimum 194°F supply conductors. Consult a qualified electrician to ensure correct branch circuit conductor.

ASD® assumes no responsibility for claims arising out of improper or careless installation or handling of this product.

ELECTRICAL SCHEMATIC DIAGRAM:

for UHB2/UHB7 Regular voltage

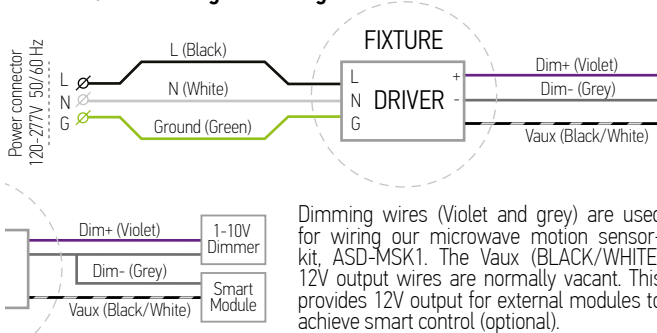

for UHB2HV/UHB7HV High voltage

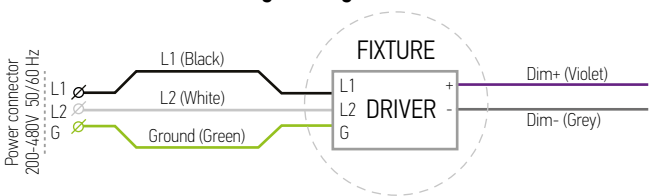

for UHB22

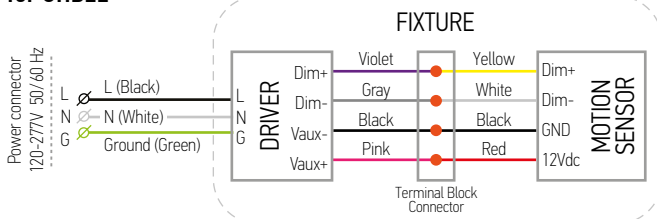

INSTALLATION STEPS:

1. Screw the included Hanging Ring clockwise into the hole at the top of the fixture and tighten.
2. Using the Hanging Ring, hang the fixture on the hook in the ceiling. Attach one end of the included safety cable through the hole between the fins on the luminaire. Ensure the safety cable is secured on the fixture. Secure the other end of the safety cable to the mounting structure.
3. Connect the black wire (Line wire), white wire (Neutral) and yellow green (ground) to the appropriate wires inside the junction box. Alternatively, you may use our connector LLT-M19CS03 (not included). To make the lamp dimmable, please connect a 1-10 V dimmer(not included) with the dimming signal line of the lamp, connect the Dim + port and Dim – port with the corresponding line on the dimmer.

Note:

- ▶ The dimmer can also be replaced by an active 1-10V voltage source signal or passive components like resistors and zener diodes.
- ▶ Do NOT connect Dim- to be output V- or V+, otherwise the driver will not work properly.
- ▶ If 1-10V dimming is not used, Dim+ should be open.
- ▶ When 1-10V negative logic dimming mode and Dim+ is open, the driver will output minimum current

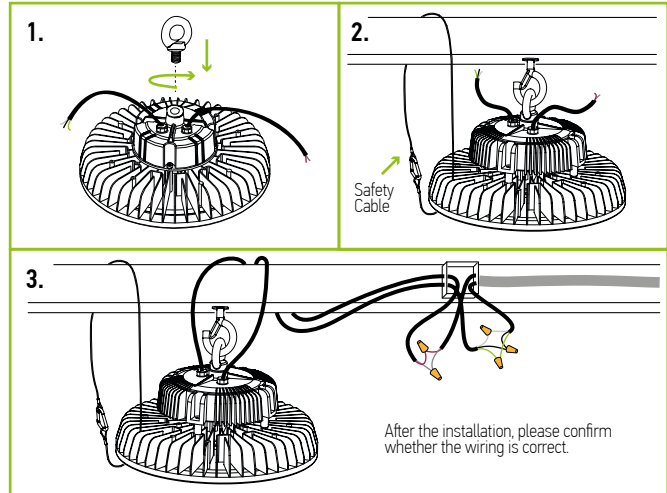

DIFFUSER AND LENS INSTALLATION (sold separately):

1. Install the diffuser, tighten the screws
2. Attach the conical lens with included clamp

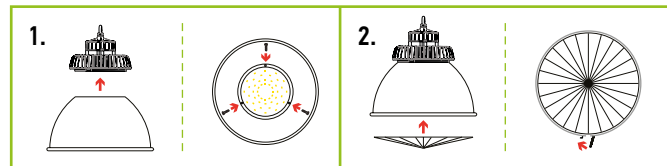

For most up-to-date spec sheets please refer to asd-lighting.com

ASD LIGHTING CORP

E-mail: orders@asd-lighting.com | Web site: www.asd-lighting.com





LED UFO High Bay

Standard and Premium Series

BRACKET INSTALLATION (sold separately):

1. Use four PM5x16 mm screws (included) to install bracket swivel on the top of the lamp body.
2. Use two PM5x12 mm screws (include) to fix bracket on the swivels.
3. Adjust the lighting direction and fix it by two M8x20 mm screws (include).

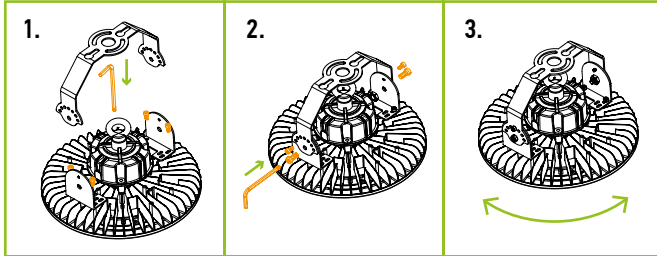

POLE INSTALLATION:

1. Make sure your conduit can support the weight of the fixture. Attach bracket to pipe.
2. Connect power and dimming wires according to wiring diagram.
3. Put the wires inside the pole and finish installation.

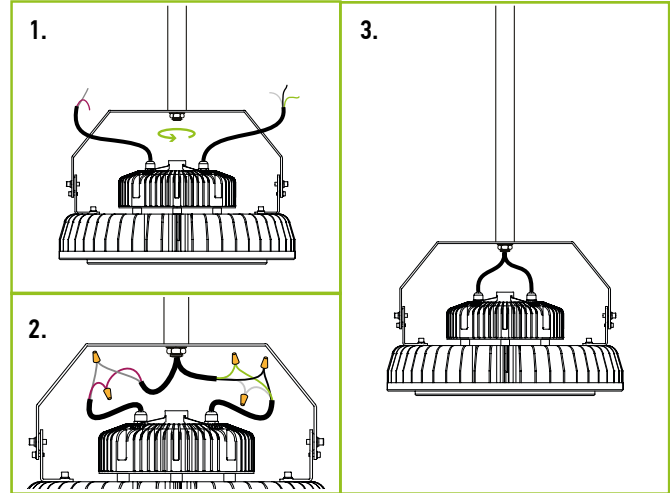

WALL INSTALLATION:

1. Drill holes in the ceiling and install the expansion screws.
2. Surface mount bracket and hook directly to wall or beam.
3. Adjust bracket to desired angle. Clip safety cable to outside of UFO housing. Wire in accordance to wiring diagram. Finish installation and test.

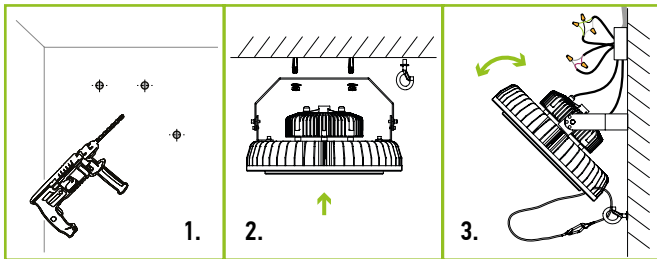

INTEGRATED MICROWAVE MOTION SENSOR INFORMATION

Specifications	Model HD06VCRH	
For fixtures models	ASD-UHB22-100D50-MS-PRM ASD-UHB22-150D50-MS-PRM ASD-UHB22-200D50-MS-PRM	ASD-UHB22-240D50-MS-PRM ASD-UHB22-300D50-MS-PRM
Operating voltage	10-15VDC	
Operating current	30mA±5%	
Output	DIM 1-10V	
Stand-by power	<0.5W	
Detection area	25%/50%/75%/100%	
Hold time	5s/30s/1min/3min/5min/10min/20min/30min	
Daylight threshold	2Lux/10Lux/30Lux/50Lux/80Lux/120Lux/Disable	
Stand-by period	0s/10s/30s/1min/5min/10min/30min/+∞	
Stand-by dimming level	10%/20%/30%/50%	
Microwave frequency	5.8GHz±75MHz	
Microwave power	<0.3mW	
Mounting height	Max.15m/49.2ft	
Detection range	Max.14m/45.92ft	

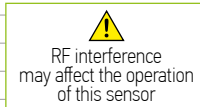

- ▶ Sensor parameters can be conveniently set by a remote control
- ▶ Mounting height up to 45ft max., suitable for warehouse use
- ▶ Built-in adjustable daylight sensor
- ▶ Sensor default setting - 100% detection range, hold time 5S, no stand-by time and daylight threshold disabled

Adopted dual PD technology, is able to differentiate artificial light brightness from natural light after installed inside the fixture, and automatically turn off light when ambient brightness exceeds preset lux level.

Preconditions to use the Lux-off function:

1. Standby period is +∞
2. Standby dimming level is on 10% or 30%;
3. Daylight threshold is on 30Lux, 50Lux, 80Lux or 120Lux.

UF022 series use integrated motion sensors, which are controlled by remote (ASD-CELP02H-MS sold separate). For more information please check page 8.

For most up-to-date spec sheets please refer to asd-lighting.com



LED UFO High Bay

Standard and Premium Series

MICROWAVE MOTION SENSOR KITS INFORMATION

- ▶ Sensor parameters can be conveniently set by a remote control
- ▶ Mounting height up to 15m max., suitable for warehouse use
- ▶ Water proof sensor with IP65 rating
- ▶ Automatic dimming when used in combination with 1-10V dimmable control gears
- ▶ Built-in adjustable daylight sensor
- ▶ 1-10V interface can match up with Merrytek stand-alone daylight sensor MS01 to achieve daylight harvesting
- ▶ Optional mounting brackets for different applications

Specifications	model UHB-MSK1 (sold separately)			model UHBHV-MSK2 (sold separately)		
For fixtures models	ASD-UHB2-100D35-STD ASD-UHB2-150D35-STD ASD-UHB2-200D35-STD ASD-UHB2-100D50-PRM	ASD-UHB2-150D50-PRM ASD-UHB2-200D50-PRM ASD-UHB2-240D50-PRM ASD-UHB2-300D50-PRM	ASD-UHB7-240D50-PRM ASD-UHB7-300D50-PRM ASD-UHB7-400D50-PRM ASD-UHB7-500D50-PRM	ASD-UHB2HV-100D50-PRM ASD-UHB2HV-150D50-PRM ASD-UHB2HV-200D50-PRM ASD-UHB2HV-240D50-PRM	ASD-UHB7HV-300D50-PRM ASD-UHB7HV-400D50-PRM ASD-UHB7HV-500D50-PRM	
Rated load	120 Vac - 400 W max; 277 Vac - 800 W max			347 Vac - 800 W max; 480 Vac - 1200 W max		
Detection area	25% / 50% / 75% / 100%					
Hold time	5 s/30 s/1 min/3 min/5 min/10 min/20 min/30 min					
Daylight sensor	5 lux/15 lux/30 lux/50 lux/100 lux/150 lux/Disable			2 lux/10 lux/30 lux/50 lux/80 lux/120 lux/Disable		
Stand-by period	0 s/10 s/1 min/3 min/5 min/10 min/30 min/+∞					
Stand-by dimming level	10% / 20% / 30% / 50%					
Sensor principle	Microwave motion detector					
Microwave frequency	5.8 GHz ± 75 MHz, ISM wave band					
Transmitting power	<0.5 mW (1% of transmitting power for cell phone)			<1 mW (1% of transmitting power for cell phone)		
Mounting height	3-15 m (10-50 ft)					
Detection angle	150° (Wall installation); 360° (Ceiling installation)					
Motion detection	0.5-3 m/s					
Operating temperature	-31 to 158°F (-35°C to 70°C)					
IP rating	IP65					



RF interference may affect the operation of this sensor

INSTALLATION STEPS ON FIXTURE WITHOUT REFLECTOR

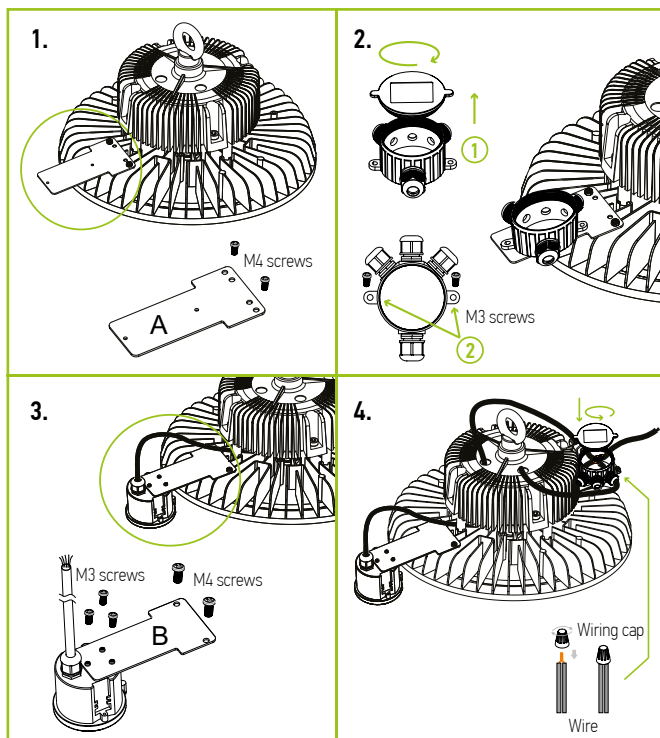

ON FIXTURE WITH AL REFLECTOR

Note: while using PC reflector or PC reflector + conical lens sensor can be installed on fixture body. Installation on reflector needed while using Aluminum reflectors only
Install j-box mounting plate as shown adjacent left (Step 1 and Step 2) for installation on fixture without reflector.

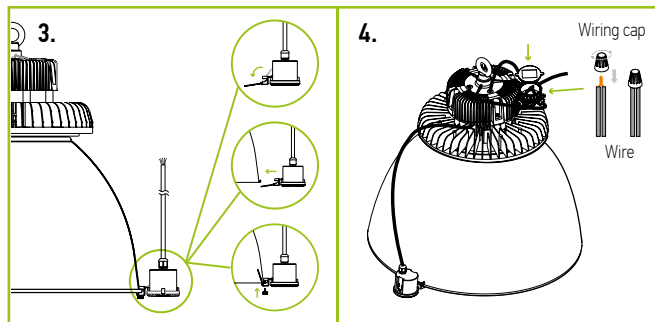

ELECTRICAL SCHEMATIC DIAGRAM:

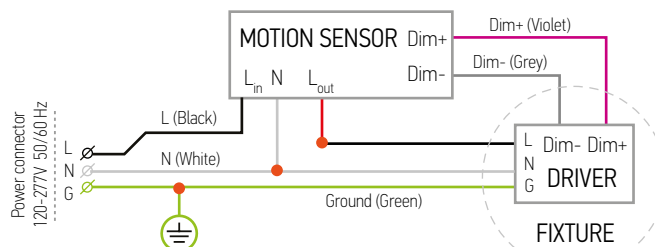

For most up-to-date spec sheets please refer to asd-lighting.com

ASD LIGHTING CORP

E-mail: orders@asd-lighting.com | Web site: www.asd-lighting.com





LED UFO High Bay

Standard and Premium Series

MOTION SENSOR UHB-MSK1 SETTINGS

Please follow the additional motion sensor manual to setup your motion sensor.

USING DIP SWITCHES

Detection area, hold time, stand-by period, stand-by DIM level and daylight sensor can be set by using DIP switches on the sensor. Note that reducing the detection area will also reduce the sensitivity.

ON ↑	1	
I	ON	100%
II	-	50%

Detection area

ON ↑	2	3	4	
I	ON	ON	ON	5s
II	-	ON	ON	30s
III	ON	-	ON	1min
IV	-	-	ON	3min
V	ON	ON	-	20min
VI	-	-	-	30min

Hold time
Refers to the time period the lamp remains at 100% illumination after no motion detected.

ON ↑	1	2	3	
I	ON	ON	ON	0s
II	-	ON	ON	1min
III	ON	-	ON	3min
IV	-	-	ON	10min
V	ON	ON	-	30min
VI	-	-	-	+∞

Stand-by period

Refers to the time period the lamp remains at a pre-set dimming level before it completely switches off in the long absence of people. *When set to 0s, the lamp will work in an on/off function. *When daylight sensor is set to "Disable" and stand-by period to "+", the lamp will work using 2-step dimming control.

ON ↑	4	5	
I	ON	ON	10%
II	ON	-	20%
III	-	ON	30%
IV	-	-	50%

Stand-by dimming level

This is the pre-set dimming level you would like to have after the hold time in the long absence of people.

ON ↑	6	7	8	9	
I	ON	ON	ON	ON	5lux
II	-	ON	ON	ON	15lux
III	ON	-	ON	ON	30Lux
IV	-	-	ON	ON	50Lux
V	ON	ON	-	ON	100Lux
VI	ON	ON	ON	-	150Lux
VII	-	-	-	-	Disable

Daylight sensor





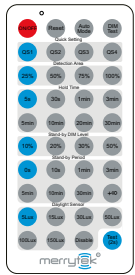

The sensor can be set to only allow the lamp to illuminate below a defined ambient brightness threshold. The settings are as follows: *When set to Disable Mode, the sensor will switch on the lamp when motion is detected regardless of ambient light levels.

USING REMOTE CONTROL UHB-PC-MSK1 (sold separately)



As the control angle of the Infrared Remote Control is fixed (15°), if sensors are installed too close to each other, settings of both sensors will be configured. Please refer to the below chart for the distance of the installation of the sensor:

Mounting height	Distance between sensors
15m	4m
12m	3.4m
9m	2.4m
6m	1.6m
3m	0.8m

Button	Remarks																														
	Press the "ON/OFF" button, the light goes to constant on or constant off mode, sensor is disabled. Press "Reset" or "Auto Mode" button to quit from this mode.																														
	Press "Reset" button, all parameters are same as setting of DIP switch.																														
	Press "Auto Mode" button, the sensor starts to work and all parameter setting will remain the same as the previous status before the light was switched on/off.																														
	Press "DIM Test" button to test dimming function. Sensor will dim automatically and return to normal work mode.																														
	The button "Test(2s)" is for factory testing purpose only. The sensor will go to test mode. Detection sensitivity: 100%. Hold time: 2sec. Stand-by dim level: 10%. Stand-by period: 0s. Daylight sensor: Disable. Test mode can be quit by pressing any button.																														
	<table border="1"> <thead> <tr> <th>Scene Options</th> <th>Detection Area</th> <th>Hold Time</th> <th>Stand-by period</th> <th>Stand-by dim level</th> <th>Daylight Sensor</th> </tr> </thead> <tbody> <tr> <td>QS1</td> <td>100%</td> <td>30s</td> <td>1min</td> <td>10%</td> <td>5Lux</td> </tr> <tr> <td>QS2</td> <td>100%</td> <td>1min</td> <td>3min</td> <td>10%</td> <td>10Lux</td> </tr> <tr> <td>QS3</td> <td>100%</td> <td>5min</td> <td>10min</td> <td>10%</td> <td>30Lux</td> </tr> <tr> <td>QS4</td> <td>100%</td> <td>10min</td> <td>30min</td> <td>10%</td> <td>Disable</td> </tr> </tbody> </table> <p>Note: Detection area / Hold time / Stand-by period / Stand-by dim level / Daylight sensor can be adjusted by pressing corresponding button. The latest setting stays valid.</p>	Scene Options	Detection Area	Hold Time	Stand-by period	Stand-by dim level	Daylight Sensor	QS1	100%	30s	1min	10%	5Lux	QS2	100%	1min	3min	10%	10Lux	QS3	100%	5min	10min	10%	30Lux	QS4	100%	10min	30min	10%	Disable
Scene Options	Detection Area	Hold Time	Stand-by period	Stand-by dim level	Daylight Sensor																										
QS1	100%	30s	1min	10%	5Lux																										
QS2	100%	1min	3min	10%	10Lux																										
QS3	100%	5min	10min	10%	30Lux																										
QS4	100%	10min	30min	10%	Disable																										











MOTION SENSOR UHBHV-MSK2 AND INTEGRATED MICROWAVE MOTION SENSOR (in mod. UHB22) SETTINGS

Please follow the additional motion sensor manual to setup your motion sensor.

USING REMOTE CONTROL ASD-CELPO2H-MS (sold separately)



Remote control waive is 10 ft, every fixture needs to be set up separately

	ON / OFF	Press the "ON/OFF" button, the light stays permanently on or off. *Press "Auto Mode" , "RESET" or "Scene mode" buttons to quit from this mode.																									
	Auto Mode	Press "Auto Mode" button, the sensor starts to work and all settings remain the same before the light gets switched on/off.																									
	Reset	Press "RESET" button, products with DIP switch will be controlled by DIP switches																									
Auto Mode																											
	Scene mode	<table border="1"> <thead> <tr> <th>Detection area</th> <th>Hold-time</th> <th>Daylight threshold</th> <th>Stand-by period</th> <th>Stand-by dimming level</th> </tr> </thead> <tbody> <tr> <td>SC1</td> <td>100%</td> <td>30s</td> <td>0.2Fc</td> <td>1min</td> </tr> <tr> <td>SC2</td> <td>100%</td> <td>5min</td> <td>1Fc</td> <td>10min</td> </tr> <tr> <td>SC3</td> <td>100%</td> <td>10min</td> <td>5Fc</td> <td>30min</td> </tr> <tr> <td>SC4</td> <td>100%</td> <td>30min</td> <td>Disable</td> <td>+∞</td> </tr> </tbody> </table>	Detection area	Hold-time	Daylight threshold	Stand-by period	Stand-by dimming level	SC1	100%	30s	0.2Fc	1min	SC2	100%	5min	1Fc	10min	SC3	100%	10min	5Fc	30min	SC4	100%	30min	Disable	+∞
Detection area	Hold-time	Daylight threshold	Stand-by period	Stand-by dimming level																							
SC1	100%	30s	0.2Fc	1min																							
SC2	100%	5min	1Fc	10min																							
SC3	100%	10min	5Fc	30min																							
SC4	100%	30min	Disable	+∞																							
	Test (2s)	The button "Test (2s)" is for testing purposes. After pressing this button, the sensor goes to test mode(hold time is only 2s) automatically, stand-by period and daylight sensor are disabled. This mode can be ended by pressing «reset», "Auto mode" «scene mode» or «hold time». The sensor setting is changed accordingly. Brightness settings: Disable Test mode (can press any key to exit this mode).																									
	On/off control	There are 4 fixed scene mode programs built into the remote control to choose for different applications.																									
	Detection area	Press the button "detection range" to set detection range as 100% / 75% / 50% / 10%.																									
	Hold-time	Press the button "hold-time" to set hold-time as 5s / 30s / 1min / 3min / 5min / 10min / 20min / 30min.																									
	Daylight threshold	Press the button "daylight sensor" to set daylight threshold as 0.2Fc / 1Fc / 3Fc / 5Fc / 8Fc / 11Fc / disable.																									
	Stand-by period	Press the button "stand-by period" to set stand-by period as 0s / 10s / 30s / 1min / 5min / 10min / 30min / +∞. Note: "0s" means on/off control; "+∞" means bi-level dimming control.																									
	Stand-by dimming	Press the button "stand-by dimming level" to set the stand-by dimming level as 10% / 20% / 30% / 50%.																									

For most up-to-date spec sheets please refer to asd-lighting.com



LED UFO High Bay

Standard and Premium Series

ORDERING INFORMATION

LED UFO HIGH-BAY FIXTURE:

Model	Watts	Motion Sensor	CCT	Pcs in one Carton	Carton Size	Carton Weight	UPC
ASD-UHB2-100D35-STD	100 W	no	3,500 K	1	12.2" x 12.2" x 6.9"	7.7 lb	819201025664
ASD-UHB2-150D35-STD	150 W	no	3,500 K	1	12.2" x 12.2" x 6.9"	7.7 lb	819201025671
ASD-UHB2-200D35-STD	200 W	no	3,500 K	1	12.2" x 12.2" x 7.7"	8.6 lb	819201025688
ASD-UHB2-100D50-PRM	100 W	no	5,000 K	1	12.2" x 12.2" x 6.9"	7.7 lb	819201023486
ASD-UHB2-150D50-PRM	150 W	no	5,000 K	1	12.2" x 12.2" x 6.9"	7.7 lb	819201023493
ASD-UHB2-200D50-PRM	200 W	no	5,000 K	1	12.2" x 12.2" x 7.7"	8.6 lb	819201023509
ASD-UHB2-240D50-PRM	240 W	no	5,000 K	1	15.2" x 15.2" x 7.9"	10 lb	819201024018
ASD-UHB2-300D50-PRM	300 W	no	5,000 K	1	15.2" x 15.2" x 7.9"	17.2 lb	819201025855
ASD-UHB2HV-100D50-PRM	100 W	no	5,000 K	1	12.2" x 12.2" x 6.9"	7.7 lb	819201023516
ASD-UHB2HV-150D50-PRM	150 W	no	5,000 K	1	12.2" x 12.2" x 6.9"	8.4 lb	819201023523
ASD-UHB2HV-200D50-PRM	200 W	no	5,000 K	1	12.2" x 12.2" x 7.7"	9.7 lb	819201023530
ASD-UHB2HV-240D50-PRM	240 W	no	5,000 K	1	15.2" x 15.2" x 7.9"	10 lb	819201026029
ASD-UHB22-100D50-MS-PRM	100 W	yes	5,000 K	1	15.4" x 15.4" x 9.4"	8.6 lb	819201026937
ASD-UHB22-150D50-MS-PRM	150 W	yes	5,000 K	1	15.4" x 15.4" x 9.4"	8.8 lb	819201026944
ASD-UHB22-200D50-MS-PRM	200 W	yes	5,000 K	1	15.4" x 15.4" x 10"	8.8 lb	819201026951
ASD-UHB22-240D50-MS-PRM	240 W	yes	5,000 K	1	15.4" x 15.4" x 10"	9 lb	819201026968
ASD-UHB22-300D50-MS-PRM	300 W	yes	5,000 K	1	15.4" x 15.4" x 10"	13.5 lb	819201026975
ASD-UHB7-240D50-PRM	240 W	yes	5,000 K	1	13" x 13" x 8"	14.8 lb	819201025862
ASD-UHB7-300D50-PRM	300 W	yes	5,000 K	1	15" x 15" x 11"	19.6 lb	819201025879
ASD-UHB7-400D50-PRM	400 W	yes	5,000 K	1	16" x 16" x 11"	24 lb	819201025886
ASD-UHB7-500D50-PRM	500 W	yes	5,000 K	1	16" x 16" x 11"	24.5 lb	819201025893
ASD-UHB7HV-300D50-PRM	300 W	yes	5,000 K	1	15" x 15" x 11"	20 lb	819201025909
ASD-UHB7HV-400D50-PRM	400 W	yes	5,000 K	1	16" x 16" x 11"	24.9 lb	819201025916
ASD-UHB7HV-500D50-PRM	500 W	yes	5,000 K	1	16" x 16" x 11"	24.9 lb	819201025923

ACCESSORIES:

Model	Name	Materials	Weight	Dimensions
ASD-H02-UHB2	Hook for LED UFO High Bays UHB2	Stainless Steel	0.2 lb (0.1 kg)	3 1/2" x 2 1/8" x 1"
ASD-SMB100/300-UHB2	Surface mount Bracket for 100/300W LED UFO High Bays UHB2	Iron	1 lb (0.4 kg)	9 11/16" x 3 1/8" x 5 5/16"
ASD-DUHB-16-90AL	Aluminium Reflector 16" 90° for LED UFO High Bays UHB	Aluminum	1.4 lb (0.6 kg)	15 3/4" x 5 1/8"
ASD-DUHB-21-120ALG	Aluminium Reflector 21" 120° for LED UFO High Bays UHB	Aluminum	1.1 lb (0.5 kg)	21" x 4 1/8"
ASD-DUHB-16-90PC	Polycarbonate Reflector 16" 90° for LED UFO High Bays UHB	Polycarbonate	1.4 lb (0.6 kg)	16 1/4" x 3 7/8"
ASD-DUHB-19-90PC	Polycarbonate Reflector 19" 90° for LED UFO High Bays UHB	Polycarbonate	1.3 lb (0.6 kg)	18 7/8" x 5 1/2"
ASD-BLUHB-16PC	Polycarbonate Bottom Conical Lens for 16" Reflector DUHB	Polycarbonate	1.1 lb (0.5 kg)	16" x 1 1/4"
ASD-BLUHB-19PC	Polycarbonate Bottom Conical Lens for 19" Reflector DUHB	Polycarbonate	1.4 lb (0.6 kg)	18 3/4" x 1 5/8"
UHB-MSK1	Microwave motion sensor kit for LED UFO High Bays UHB	Polycarbonate	1 lb (0.4 kg)	3 1/8" x 2 1/2"
UHB-RC-MSK1	Remote Control	Nylon	0.1 lb (0.04 kg)	4 1/2" x 2 1/8" x 1/2"
UHBHV-MSK2	Microwave motion sensor kit High Voltage for LED UFO High Bays UHB	Polycarbonate	1.1 lb (0.5 kg)	3 1/8" x 2 1/2"
ASD-CELP02H-MS	Remote Control	Nylon	0.1 lb (0.04 kg)	2" x 1" x 1/2"
LLT-M19CS03	Inline Wire Connector	Nylon	0.1 lb (0.04 kg)	7 5/8" x 2 1/8"
ASD-CRD6-TLP-277V	6-foot Cord 120V-277V 3-Blade Twist-Lock Plug	PVC+PC	0.6 lbs (0.3 kg)	70 7/8" x 3/8"
ASD-CRD6-SBP-277V	6-foot Cord 120V-277V Straight Blade Plug	PVC+PC	0.7 lbs (0.3 kg)	70 7/8" x 3/8"

Model	Pcs in one Carton	Carton Size	Carton Weight	UPC	GTIN 14
ASD-H02-UHB2	200	18.3" x 9.3" x 10.6"	41.7 lbs	819201025312	10819201025319
ASD-SMB100/300-UHB2	20	20.3" x 16.9" x 11.8"	23.1 lbs	819201026999	10819201026996
ASD-DUHB-16-90AL	20	16.5" x 16.5" x 14.6"	16.8 lbs	819201020621	10819201020628
ASD-DUHB-21-120ALG	10	22" x 22" x 7.5"	14.6 lbs	819201020638	10819201020635
ASD-DUHB-16-90PC	10	16.9" x 16.9" x 7.9"	16.8 lbs	819201020607	10819201020604
ASD-DUHB-19-90PC	10	19.7" x 19.7" x 9.1"	16.1 lbs	819201020614	10819201020611
ASD-BLUHB-16PC	10	16.9" x 16.9" x 5.1"	11.7 lbs	819201020645	10819201020642
ASD-BLUHB-19PC	10	19.7" x 19.7" x 5.1"	16.1 lbs	819201020652	10819201020659
UHB-MSK1	40	20.7" x 12.4" x 19"	49.0 lbs	819201021994	10819201021991
UHB-RC-MSK1	100	9.8" x 6.9" x 12"	11.3 lbs	819201022007	10819201022004
UHBHV-MSK2	32	21.9" x 14.8" x 12.6"	40.2 lbs	819201025848	20819201025842
ASD-CELP02H-MS	50	11.4" x 6.5" x 5.3"	6.6 lbs	819201023479	10819201023476
LLT-M19CS03	1000	17.7" x 11" x 10.2"	55.1 lbs	819201020591	10819201020598
ASD-CRD6-TLP-277V	25	10.8" x 9.8" x 11.6"	15.9 lbs	819201026296	10819201026293
ASD-CRD6-SBP-277V	25	10.8" x 9.8" x 11.6"	17.6 lbs	819201026302	10819201026309

For most up-to-date spec sheets please refer to asd-lighting.com

ASD LIGHTING CORP

E-mail: orders@asd-lighting.com | Web site: www.asd-lighting.com

