

COOPER LIGHTING - ALLPRO®

DESCRIPTION

The APW-GPW Series is a general purpose wraparound luminaire featuring ideal performance for any application. The luminaire's low profile design is both appealing and functional. The APW-GPW Series utilizes a clear, low brightness, extruded acrylic refractor to meet your performance and aesthetics needs.

The APW-GPW Series is the perfect wraparound for schools, offices and other commercial and retail spaces.

Catalog #		Type
Project		
Comments		Date
Prepared by		

SPECIFICATION FEATURES

Construction

Housing consists of die formed cold rolled steel. Ends formed with the housing for strength. Steel end plates with 7/8" KO's and provisions for continuous row aligners. Ballast cover easily removed without tools.

Electrical*

Equipped with T8 NEMA premium ballast. Rotor lock lampholders. UL/CUL listed. Suitable for damp locations.

Finish

Baked enamel finish ensures maximum bonding and rust prevention.

Lens

100% clear prismatic lens. Sides have inside linear prisms and bottom has pyramidal prisms for low brightness control.

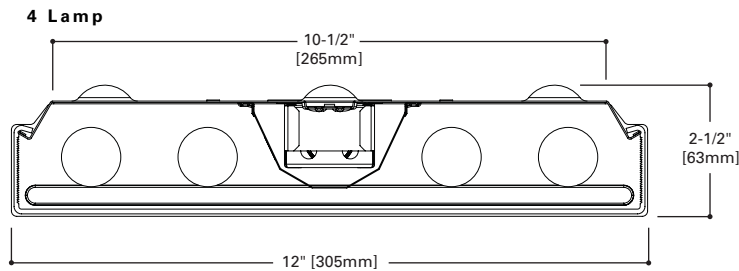
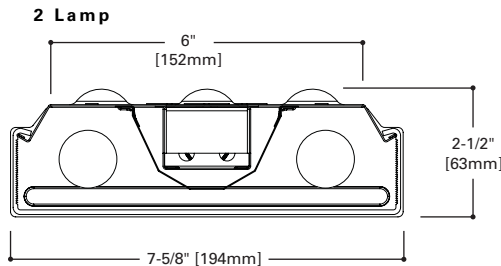

APW-GPW

432
232
217

2', 4' LAMPS
2' OR 4' SURFACE

Commercial Wrap

PRODUCT SPECIFICATIONS

Catalog Number	Product Description	Wattage	UPC
APW-GPW217	2', 2 LAMP, T8, GENERAL PURPOSE WRAP	17W	080083622146
APW-GPW232	4', 2 LAMP, T8, GENERAL PURPOSE WRAP	32W	080083622115
APW-GPW432	4', 4 LAMP, T8, GENERAL PURPOSE WRAP	32W	080083622139

SHIPPING INFORMATION

Catalog Number	WGT.	Pallet Qty.
APW-GPW217	5.02	90
APW-GPW232	10.03	54
APW-GPW432	11.41	180

LAMPS CONTAIN MERCURY. DISPOSE ACCORDING TO LOCAL, STATE OR FEDERAL LAWS

LINEAR DISCONNECT

Safe and convenient means of disconnecting power.

*Reference the lamp/ballast data in the Technical Section for specific lamp/ballast requirements.

PHOTOMETRICS

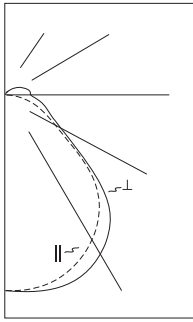

APW-GPW232
Energy Saving
Ballast

F32T8/35K Lamps
3100 Lumens

Spacing criterion:
(||) 1.3 x mounting
height, (⊥) 1.4 x
mounting height

Efficiency 79.1%

Test Report:
APW-GPW232.IES

Coefficients of Utilization

rc	Effective floor cavity reflectance																				
	80%					70%					20%										
	50	30	10	70	50	30	10	50	30	10	50	30	10	50	30	10	50	30	10	0%	
RCR																					
0	93	93	93	93	90	90	90	90	84	84	84	79	79	79	74	74	74	72			
1	85	81	77	74	82	78	75	73	74	71	69	69	67	66	66	64	63	60			
2	77	71	66	61	75	69	64	60	65	61	58	61	58	55	58	55	53	51			
3	71	63	57	52	68	61	55	51	58	53	49	55	51	47	52	48	46	44			
4	65	56	49	44	63	54	48	43	52	46	42	49	44	41	46	43	40	38			
5	60	50	43	38	58	49	43	38	46	41	37	44	39	36	42	38	35	33			
6	55	45	38	34	53	44	38	33	42	36	32	40	35	32	38	34	31	29			
7	51	41	34	30	50	40	34	29	38	33	29	37	32	28	35	31	27	26			
8	48	38	31	27	46	37	31	26	35	30	26	34	29	25	32	28	25	23			
9	45	34	28	24	43	34	28	24	32	27	23	31	26	23	30	25	22	21			
10	42	32	26	22	41	31	25	21	30	25	21	29	24	21	28	23	20	19			

Zonal Lumen Summary

Zone	Lumens	%Lamp	%Fixture
0-30	2652	21.4	27.0
0-40	4407	35.5	44.9
0-60	7345	59.2	74.8
0-90	8954	72.2	91.2
90-180	860	6.9	8.8
0-180	9814	79.1	100.0

Typical VCP Percentages

Room Size (Ft.)	Height Along		Height Across	
	8.5'	10.0'	8.5'	10.0'
20 x 20	45	51	40	47
30 x 30	38	42	30	36
30 x 60	32	35	16	21
60 x 30	37	42	33	39
60 x 60	30	33	18	22

Candela

Angle	Along	45°	Across ⊥
0	3220	3220	3220
5	3225	3244	3247
10	3206	3249	3276
15	3158	3236	3288
20	3071	3194	3264
25	2952	3117	3192
30	2802	3002	3071
35	2623	2843	2905
40	2402	2629	2683
45	2100	2316	2319
50	1650	1842	1773
55	1174	1394	1305
60	902	1067	1019
65	714	806	844
70	561	608	739
75	408	463	661
80	258	366	567
85	123	286	476
90	6	196	407

LAMP CONFIGURATIONS

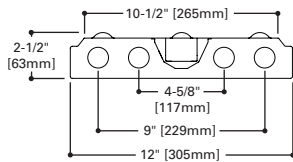

LENS REMOVAL

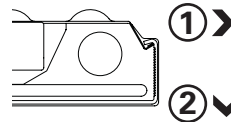

MOUNTING DATA

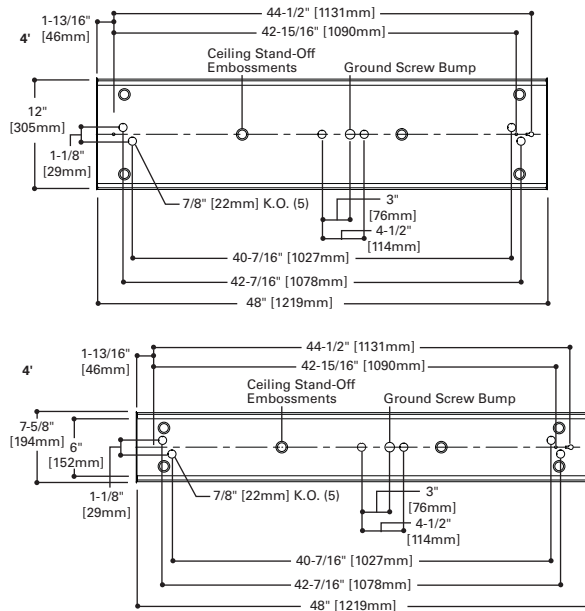

For complete product data, reference the Fluorescent Specification binder. Specifications & dimensions subject to change without notice. Consult your Cooper Lighting Representative for availability and ordering information.

COOPER LIGHTING - ALLPRO®

DESCRIPTION

The APW-GPW Series is a general purpose wraparound luminaire featuring ideal performance for any application. The luminaire's low profile design is both appealing and functional. The APW-GPW Series utilizes a clear, low brightness, extruded acrylic refractor to meet your performance and aesthetics needs.

The APW-GPW Series is the perfect wraparound for schools, offices and other commercial and retail spaces.

Catalog #		Type
Project		
Comments		Date
Prepared by		

SPECIFICATION FEATURES

Construction

Housing consists of die formed cold rolled steel. Ends formed with the housing for strength. Steel end plates with 7/8" KO's and provisions for continuous row aligners. Ballast cover easily removed without tools.

Electrical*

Equipped with T8 NEMA premium ballast. Rotor lock lampholders. UL/CUL listed. Suitable for damp locations.

Finish

Baked enamel finish ensures maximum bonding and rust prevention.

Lens

100% clear prismatic lens. Sides have inside linear prisms and bottom has pyramidal prisms for low brightness control.

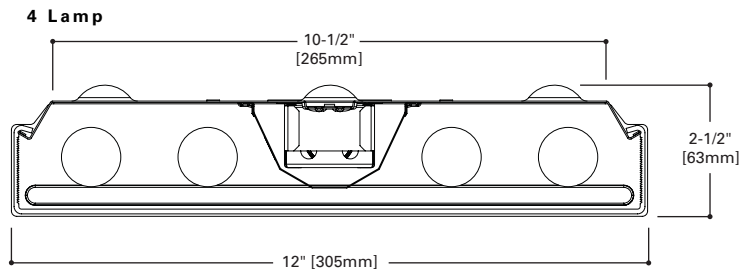
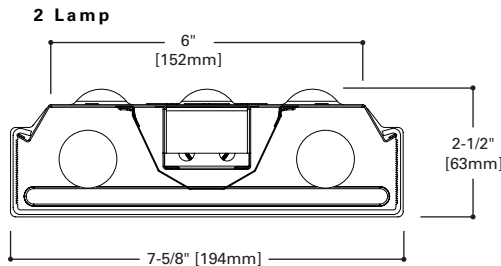

APW-GPW

432
232
217

2', 4' LAMPS
2' OR 4' SURFACE

Commercial Wrap

Catalog Number	Product Description	Wattage	UPC
APW-GPW217	2', 2 LAMP, T8, GENERAL PURPOSE WRAP	17W	080083622146
APW-GPW232	4', 2 LAMP, T8, GENERAL PURPOSE WRAP	32W	080083622115
APW-GPW432	4', 4 LAMP, T8, GENERAL PURPOSE WRAP	32W	080083622139

SHIPPING INFORMATION

Catalog Number	WGT.	Pallet Qty.
APW-GPW217	5.02	90
APW-GPW232	10.03	54
APW-GPW432	11.41	180

LAMPS CONTAIN MERCURY. DISPOSE ACCORDING TO LOCAL, STATE OR FEDERAL LAWS

LINEAR DISCONNECT

Safe and convenient means of disconnecting power.

*Reference the lamp/ballast data in the Technical Section for specific lamp/ballast requirements.

PHOTOMETRICS

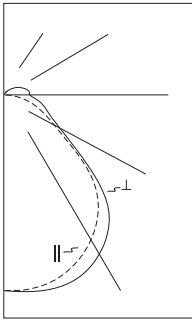

APW-GPW232
Energy Saving
Ballast

F32T8/35K Lamps
3100 Lumens

Spacing criterion:
(||) 1.3 x mounting
height, (⊥) 1.4 x
mounting height

Efficiency 79.1%

Test Report:
APW-GPW232.IES

Coefficients of Utilization

rc	Effective floor cavity reflectance																			
	80%				70%				20%											
	50	30	10	0	50	30	10	0	50	30	10	0								
rw	70	50	30	10	70	50	30	10	50	30	10	0	50	30	10	0	50	30	10	0
RCR																				
0	93	93	93	93	90	90	90	90	84	84	84	84	79	79	79	79	74	74	74	72
1	85	81	77	74	82	78	75	73	74	71	69	66	69	67	66	66	66	64	63	60
2	77	71	66	61	75	69	64	60	65	61	58	55	61	58	55	55	58	55	53	51
3	71	63	57	52	68	61	55	51	58	53	49	47	55	51	47	47	52	48	46	44
4	65	56	49	44	63	54	48	43	52	46	42	41	49	44	41	41	46	43	40	38
5	60	50	43	38	58	49	43	38	46	41	37	36	44	39	36	36	42	38	35	33
6	55	45	38	34	53	44	38	33	42	36	32	32	40	35	32	32	38	34	31	29
7	51	41	34	30	50	40	34	29	38	33	29	28	37	32	28	28	35	31	27	26
8	48	38	31	27	46	37	31	26	35	30	26	26	34	29	25	25	32	28	25	23
9	45	34	28	24	43	34	28	24	32	27	23	23	31	26	23	23	30	25	22	21
10	42	32	26	22	41	31	25	21	30	25	21	21	29	24	21	21	28	23	20	19

Zonal Lumen Summary

Zone	Lumens	%Lamp	%Fixture
0-30	2652	21.4	27.0
0-40	4407	35.5	44.9
0-60	7345	59.2	74.8
0-90	8954	72.2	91.2
90-180	860	6.9	8.8
0-180	9814	79.1	100.0

Typical VCP Percentages

Room Size (Ft.)	Height Along		Height Across	
	8.5'	10.0'	8.5'	10.0'
20 x 20	45	51	40	47
30 x 30	38	42	30	36
30 x 60	32	35	16	21
60 x 30	37	42	33	39
60 x 60	30	33	18	22

Candela

Angle	Along	45°	Across ⊥
0	3220	3220	3220
5	3225	3244	3247
10	3206	3249	3276
15	3158	3236	3288
20	3071	3194	3264
25	2952	3117	3192
30	2802	3002	3071
35	2623	2843	2905
40	2402	2629	2683
45	2100	2316	2319
50	1650	1842	1773
55	1174	1394	1305
60	902	1067	1019
65	714	806	844
70	561	608	739
75	408	463	661
80	258	366	567
85	123	286	476
90	6	196	407

LAMP CONFIGURATIONS

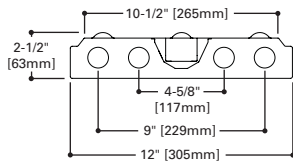

LENS REMOVAL

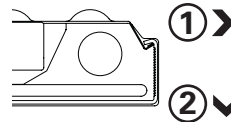

MOUNTING DATA

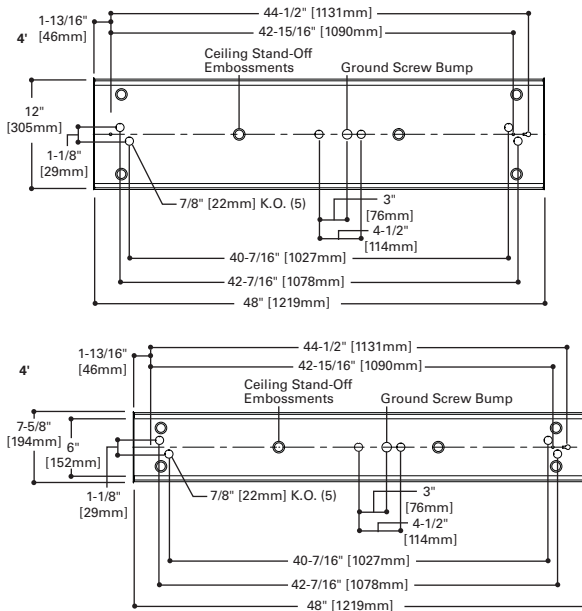

For complete product data, reference the Fluorescent Specification binder. Specifications & dimensions subject to change without notice. Consult your Cooper Lighting Representative for availability and ordering information.