



Powering Business Worldwide

# APX/APXH Polycarbonate LED Exit



APX



APXH

The APX series is a fully code compliant, polycarbonate LED solution for exit needs. The series has universal mounting flexibility (ceiling, wall, end), is configurable to single or double-sided, and is available with red or green letters. Options include a white or black housing and remote capacity that can power the APWR LED remote series.

Features	Benefits
LED source with nickel cadmium battery	Up to 10 years with no maintenance
Universal mount; single or double sided	Ease of ordering & installation
Optional remote capacity to drive 2 or 4 LED heads	Design flexibility; labor and material savings

Certification/Warranty
UL 924 damp location listed
NFPA/NEC/OSHA/CEC code compliant
5 year product warranty
7 year prorated battery warranty



## Ordering Information

SAMPLE NUMBER: APX6R, APX6G, APX6RBK, APX6GBK, APX7R, APX7G, APX7RBK, APX7GBK

Series	Battery	Face Options	Letter Colors	Housing Color
APX = All-Pro exit	6 = no battery ( AC only ) 7 = nickel cadmium battery	_ = Universal	R = red G = green	_ = white BK = black

SAMPLE NUMBER: APXH7R, APXH7G, APXH7RBK, APXH7GBK

Series	Battery	Face Options	Letter Colors	Housing Color	Remote Heads Powered
APXH = All-Pro exit w/ remote capacity	7 = nickel cadmium battery	_ = Universal	R = red G = green	_ = white BK = black	2 = two 3.6 V LED heads 4 = four 3.6 V LED heads

Series	Remote Heads Powered	Housing Color
APWR = All-Pro emergency remote	1 = one LED head 2 = two LED heads	_ = White BK = Black

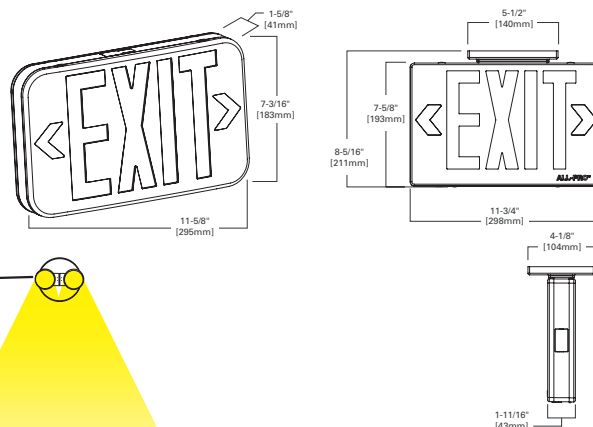

## Spacing

APXH7R2 (Remotes not included)

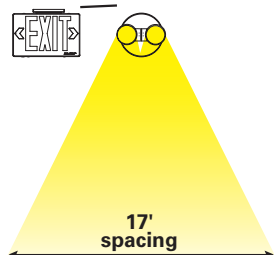

APXH7R4 (Remotes not included)

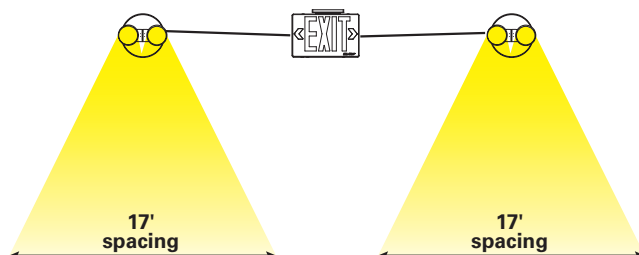

# APC/APCH Polycarbonate LED Exit



The APC series is a fully code compliant, polycarbonate LED solution for exit and emergency needs. The series has universal mounting flexibility (ceiling, wall, end), is configurable to single or double-sided, and is available with red or green letters. The LED emergency heads can be side or top mounted and will run for a minimum of 90 minutes. Options include a white or black housing and remote capacity that can power the APWR LED remote series.

Features	Benefits
LED source with nickel cadmium battery	Up to 10 years with no maintenance
Universal mount; single or double sided	Ease of ordering & installation
Optional remote capacity to drive 2 or 4 LED heads	Up to 50 feet of indoor/outdoor egress coverage

Certification/Warranty
UL 924 damp location listed
NFPA/NEC/OSHA/CEC code compliant
5 year product warranty
7 year prorated battery warranty



## Ordering Information

SAMPLE NUMBER: APXH7R, APXH7G, APXH7RBK, APXH7GBK

Series	Remote Heads Powered	Battery	Face Options	Letter Colors	Housing Color
APC = All-Pro exit/emergency combo	_ = no remote heads	7 = nickel cadmium battery	_ = Universal	R = red G = green	_ = white BK = black
	H = two 3.6 V LED heads	7 = nickel cadmium battery	_ = Universal	R = red G = green	_ = white BK = black

Series	Remote Heads Powered	Housing Color
APWR = All-Pro emergency remote	1 = one LED head 2 = two LED heads	_ = White BK = Black

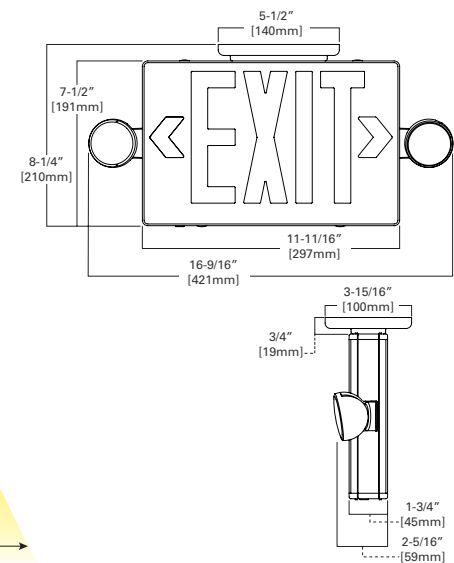

## Spacing

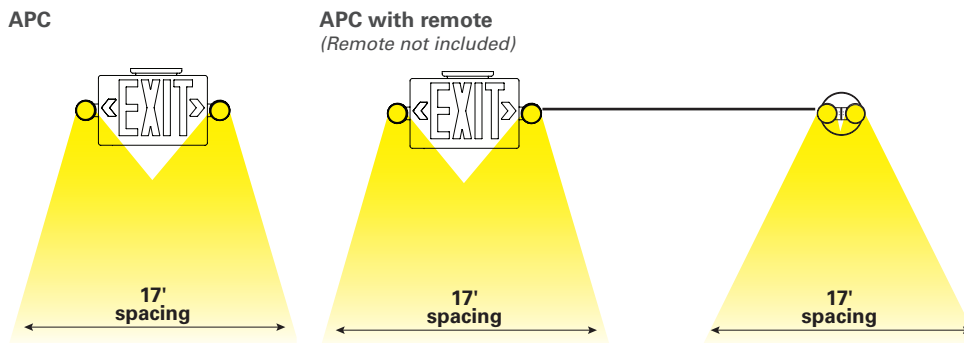



# APEL/APELH2 Polycarbonate LED Emergency



APEL



APELH2

The APEL series is a fully code compliant, polycarbonate LED solution for emergency needs. The LED emergency heads will run for a minimum of 90 minutes. The universal j-box mounting pattern and snap fit housing construction significantly reduce installation time. Options include a white or black housing and remote capacity that can power the APWR LED remote series.

Features	Benefits
LED source with nickel cadmium battery	Up to 10 years with no maintenance
Adjustable heads	Design flexibility
Optional remote capacity to drive 2 LED heads	Up to 34 feet of indoor/outdoor egress coverage

Certification/Warranty
UL 924 damp location listed
NFPA/NEC/OSHA/CEC code compliant
5 year product warranty
7 year prorated battery warranty



## Ordering Information

SAMPLE NUMBER: APEL, APELH2, APELH2BK

Series	Remote Heads Powered	Housing Color
APEL = All-Pro emergency light	_ = no LED heads H2 = two LED heads	_ = White BK = Black
APWR = All-Pro emergency remote	1 = one LED head 2 = two LED heads	_ = White BK = Black

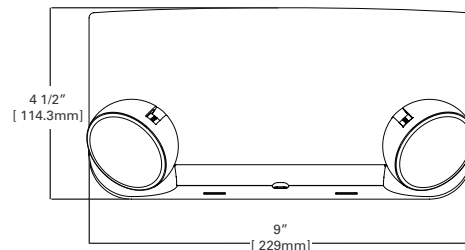

## Spacing

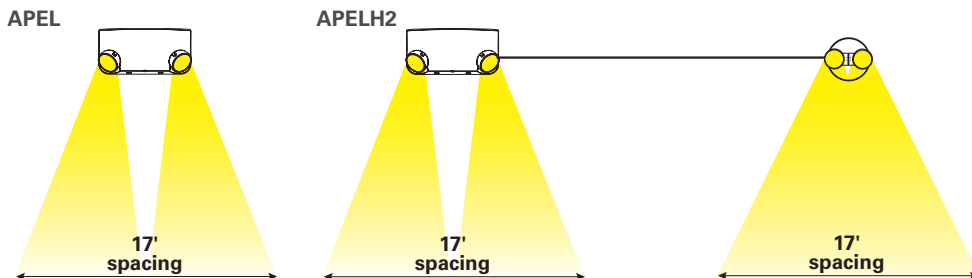



# APWR Polycarbonate LED remote



APWR2



APWR2BK

The APWR series is fully code compliant, polycarbonate LED solution for emergency needs. The heads are fully adjustable and available with a white or black housing. This product is wet location listed and suitable for outdoor applications.

Features	Benefits
LED source	Up to 10 years with no maintenance
Adjustable heads	Design flexibility
Wet location capable	Up to 17 feet of indoor/outdoor egress coverage

Certification/Warranty
UL 924 wet location listed
NFPA/NEC/OSHA code compliant
5 year product warranty
7 year prorated battery warranty



## Ordering Information

SAMPLE NUMBER: APWR1, APWR2, APWR1BK, APWR2BK

Series	Remote Heads Powered	Housing Color
APWR = All-Pro emergency remote	1 = one LED head 2 = two LED heads	_ = White BK = Black

## Spacing

APWR

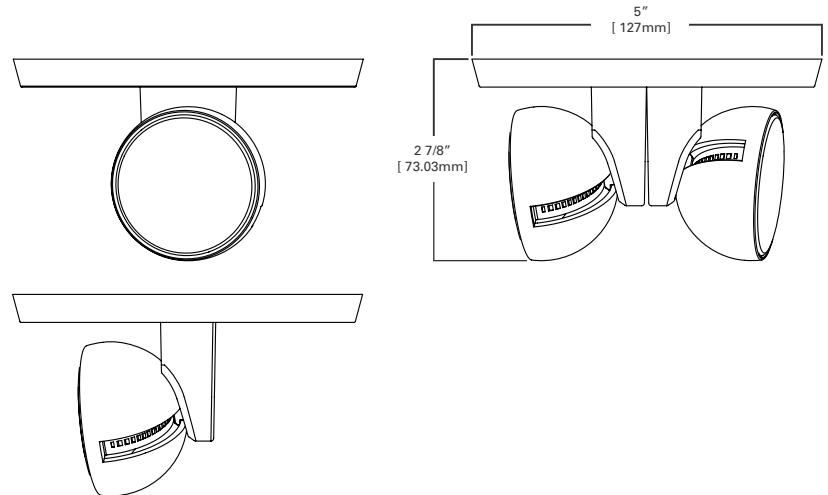
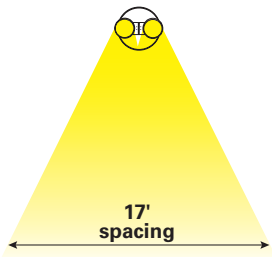

# EBPLED LED Emergency battery pack



The EBPLED series enables electrical contractors to add a UL924 code compliant emergency option to an existing LED fixture. While compatible with almost any LED fixture that has an accessible driver, this series offers guaranteed quality and compatibility with Eaton products.

Features	Benefits
Field installable	Meet emergency code with no aesthetic impact
Satisfies all wiring configurations as conduit and test button are included	Design ease; less SKU's to stock
7 watt or 14 watt output creates 600 to 2500 lumens in emergency mode	Design flexibility; superior egress coverage
Laser test feature enables simplified NFPA testing	Labor savings

Certification/Warranty
UL 924 Classified
NFPA/NEC/OSHA/CEC code compliant
Guaranteed compatibility w/Eaton Fixtures
5 year product warranty
7 year prorated battery warranty



## Ordering Information

SAMPLE NUMBER: EBPLED7W

Series	Output	Run Time
EBPLED = LED emergency battery pack	7W = 7 Watt	_ = 90 minute -3H = 180 minute
	14W = 14 Watt	_ = 90 minute

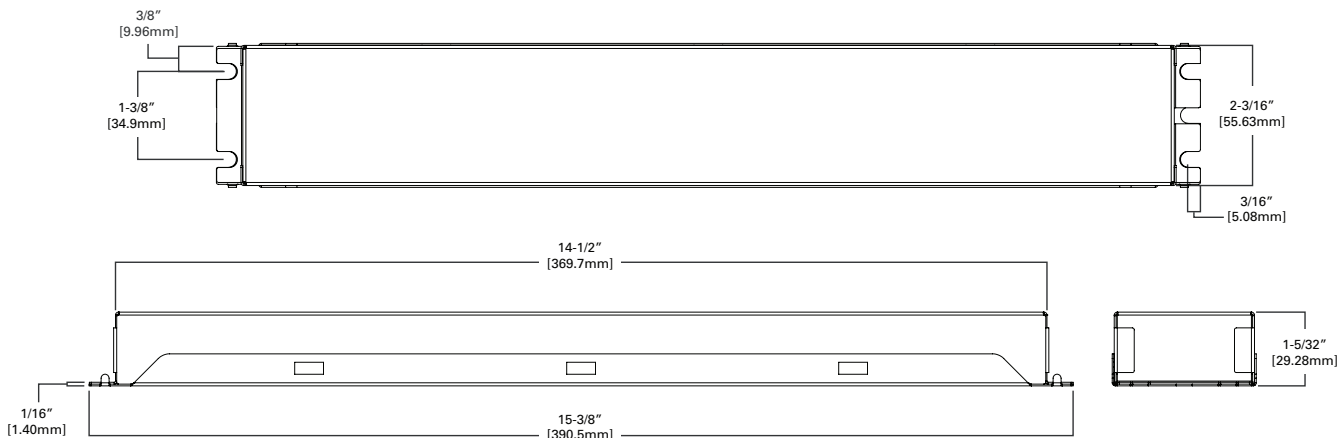

# Cross Reference

Description	All-Pro	Acuity	Hubbell	Barron	Thomas & Betts	Philips	Mule
Green LED Polycarbonate Exit, AC only	APX6G	LQM S W 3 G 120/277	CAG	ILX-G-AC-WH	QLX500G	VEGW	MXAGU
Red LED Polycarbonate Exit, AC only	APX6R	LQM S W 3 R 120/277	CAR	ILX-R-AC-WH	QLX500R	VERW	MXARU
Green LED Polycarbonate Exit, Nickel Cadmium Battery	APX7G	LQM S W 3 G 120/277 EL N	CEG	ILX-G-EM-WH	QLXN500G	VEGWEM	MXBGU
Red LED Polycarbonate Exit, Nickel Cadmium Battery	APX7R	LQM S W 3 R 120/277 EL N	CER	ILX-R-EM-WH	QLXN500R	VERWEM	MXBRU
Green LED Polycarbonate Exit, AC only, Black Option	APX6GBK	LQM S 3 G 120/277	CAGB	ILX-G-AC-BL	N/A	VEGB	MXAGU-BL
Red LED Polycarbonate Exit, AC only, Black Option	APX6RBK	LQM S 3 R 120/277	CARB	ILX-R-AC-BL	N/A	VERB	MXARU-BL
Green LED Polycarbonate Exit, Nickel Cadmium Battery, Black Option	APX7GBK	LQM S 3 G 120/277 EL N	CEGB	ILX-G-EM-BL	N/A	VEGBEM	MXBGU-BL
Red LED Polycarbonate Exit, Nickel Cadmium Battery, Black Option	APX7RBK	LQM S 3 R 120/277 EL N	CERB	ILX-R-EM-BL	N/A	VERBEM	MXBRU-BL
Green LED polycarbonate exit, Remote capacity	APXH7G2	N/A	CERRC	N/A	N/A	VREGWEM	MXBGU-REM
Red LED polycarbonate exit, Remote capacity	APXH7R2	N/A	CEGRC	N/A	N/A	VRERWEM	MXBRU-REM
Green LED polycarbonate exit, Remote capacity	APXH7G4	N/A	CERRC	N/A	N/A	VREGWEM	N/A
Red LED polycarbonate exit, Remote capacity	APXH7R4	N/A	CEGRC	N/A	N/A	VRERWEM	N/A
LED Adjustable Heads, Nickel Cadmium Battery, 90-min Run-Time	APEL	EU2 LED M12	CU2	LL90-G2	LCAB-2SQLED	VLLU	SQ-80
High-powered, Two LED Adjustable Heads, Nickel Cadmium Battery, 90-min Run-Time	APEL H2	EU2 LED HO M6	CU2RC	LL90-R	LCAB-2SQLEDRID	VLLUR	SQ-120
LED adjustable heads, Nickel cadmium battery, 90-min run-time, Black option	APELBK	ELM2 LED B	CU2SQ	LL90-G2-B	N/A	N/A	SQ-LED-80-B
High-powered, Two LED adjustable heads, Nickel cadmium battery, 90-min run-time, Black option	APEL BK H2	ELM2 LED B HO	CU2SQB	LL90-R-B	N/A	N/A	SQ-LED-120-B
3.6V LED adjustable head, Outdoor rated	APWR1	ELA LED WP M12	CIRS	LED-51-WH	ELF612D	VLT1R	RLED-1-SD-WP-3.6V
Outdoor rated, 3.6V LED adjustable heads	APWR2	ELA LED T WP M12	CIRD	LED-52-WH-G2	ELF612D/LED	VLT2R	RLED-2-SD-WP-3.6V
3.6V LED Adjustable Head, Outdoor rated, Black option	APWR1BK	N/A	N/A	LED-51-BL	N/A	VLL1RGO	N/A
Outdoor rated, 3.6V LED adjustable heads, Black option	APWR2BK	N/A	N/A	LED-52-BL-R2	N/A	VLL2RGO	N/A
LED source with nickel cadmium battery, Red	APC7R	ECR LED M6	CCR	VLED-U-WH-EL90	UQLX-N500R-2LD1N	VLLCR	SQC-LED-U-R-WW
LED source with nickel cadmium battery, Green	APC7G	ECG LED M6	CCG	GVLED-U-WH-EL90	UQLXN500G-2LD1N	VLLCG	SQC-LED-U-G-WW
LED source with nickel cadmium battery, Red, Black option	APC7RBK	N/A	CCRB	VLED-U-BL-EL90	N/A	N/A	SQC-LED-U-R-BB
LED source with nickel cadmium battery, Green, Black option	APC7GBK	N/A	CCGB	GVLED-U-BL-EL90	N/A	N/A	SQC-LED-U-G-BB
3.6V LED heads with nickel cadmium battery, Remote capacity, Red	APCH7R	ECR LED HO M6	CCRRC	VLEDC-51-WH-R	UQLXN500R-2LED R	VLLCR2R	SQC-LED-U-R-WW-REM
3.6V LED heads with nickel cadmium battery, Remote capacity, Green	APCH7G	ECG LED HO M6	CCGRC	GVLEDC-51-WH-R	UQLXN500G-2LED R	VLLCG2R	SQC-LED-U-G-WW-REM
3.6V LED heads with nickel cadmium battery, Remote capacity, Red, Black option	APCH7RBK	N/A	CCRRCB	VLEDC-51-BK-R	UQLXN500R-2LEDRB	N/A	SQC-LED-U-R-BB-REM
3.6V LED heads with nickel cadmium battery, Remote capacity, Green, Black option	APCH7GBK	N/A	N/A	GVLEDC-51-BK-R	UQLXN500G-2LEDRB	N/A	SQC-LED-U-G-BB-REM



**Lighting Product Lines**

Halo  
Halo Commercial  
Portfolio  
Iris  
RSA  
Metalux  
Corelite  
Neo-Ray  
Fail-Safe  
MWS  
Ametrix  
Shaper  
io  
Lumark  
McGraw-Edison  
Invue  
Ephesus  
Lumière  
Streetworks  
AtLite  
Sure-Lites

**Controls Product Lines**

Greengate  
iLumin  
Zero 88  
Fifth Light Technology  
iLight (International Only)

**Connected Lighting Systems**

LumaWatt Pro  
WaveLinx  
Distributed Low-Voltage Power  
ConnectWorks

**Eaton**  
1121 Highway 74 South  
Peachtree City, GA 30269  
P: 770-486-4800  
[www.eaton.com/lighting](http://www.eaton.com/lighting)

**Canada Sales**  
5925 McLaughlin Road  
Mississauga, Ontario L5R 1B8  
P: 905-501-3000  
F: 905-501-3172

© 2017 Eaton  
All Rights Reserved  
Printed in USA  
Publication No. BR505016EN  
November 15, 2017

Eaton is a registered trademark.

All other trademarks are property  
of their respective owners.

Product availability, specifications,  
and compliances are subject to  
change without notice.



Powering Business Worldwide

# APX/APXH Polycarbonate LED Exit



APX



APXH

The APX series is a fully code compliant, polycarbonate LED solution for exit needs. The series has universal mounting flexibility (ceiling, wall, end), is configurable to single or double-sided, and is available with red or green letters. Options include a white or black housing and remote capacity that can power the APWR LED remote series.

Features	Benefits
LED source with nickel cadmium battery	Up to 10 years with no maintenance
Universal mount; single or double sided	Ease of ordering & installation
Optional remote capacity to drive 2 or 4 LED heads	Design flexibility; labor and material savings

Certification/Warranty
UL 924 damp location listed
NFPA/NEC/OSHA/CEC code compliant
5 year product warranty
7 year prorated battery warranty



## Ordering Information

SAMPLE NUMBER: APX6R, APX6G, APX6RBK, APX6GBK, APX7R, APX7G, APX7RBK, APX7GBK

Series	Battery	Face Options	Letter Colors	Housing Color
APX = All-Pro exit	6 = no battery ( AC only ) 7 = nickel cadmium battery	_ = Universal	R = red G = green	_ = white BK = black

SAMPLE NUMBER: APXH7R, APXH7G, APXH7RBK, APXH7GBK

Series	Battery	Face Options	Letter Colors	Housing Color	Remote Heads Powered
APXH = All-Pro exit w/ remote capacity	7 = nickel cadmium battery	_ = Universal	R = red G = green	_ = white BK = black	2 = two 3.6 V LED heads 4 = four 3.6 V LED heads

Series	Remote Heads Powered	Housing Color
APWR = All-Pro emergency remote	1 = one LED head 2 = two LED heads	_ = White BK = Black

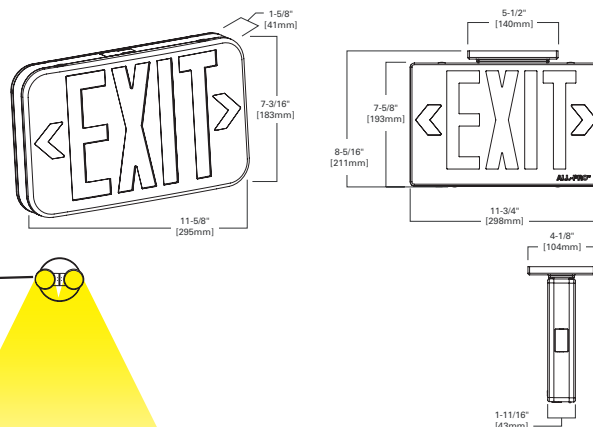

## Spacing

APXH7R2 (Remotes not included)

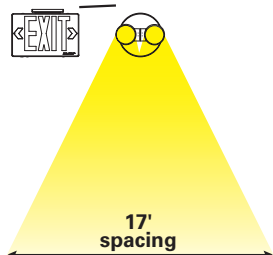

APXH7R4 (Remotes not included)

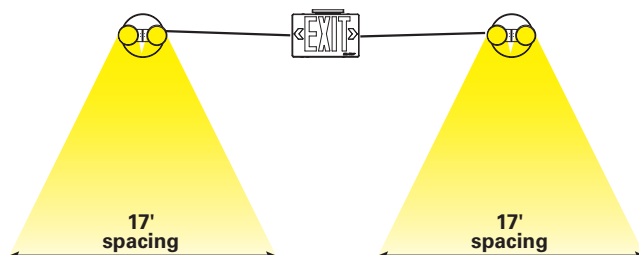



# APC/APCH Polycarbonate LED Exit

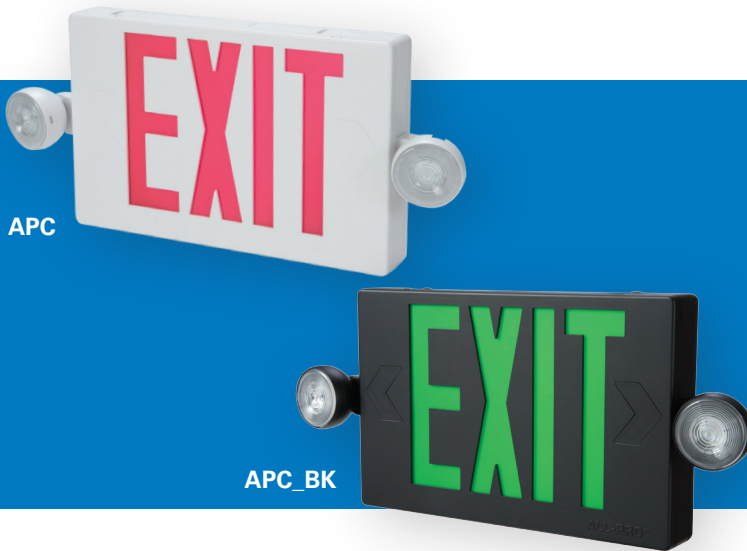

The APC series is a fully code compliant, polycarbonate LED solution for exit and emergency needs. The series has universal mounting flexibility (ceiling, wall, end), is configurable to single or double-sided, and is available with red or green letters. The LED emergency heads can be side or top mounted and will run for a minimum of 90 minutes. Options include a white or black housing and remote capacity that can power the APWR LED remote series.

Features	Benefits
LED source with nickel cadmium battery	Up to 10 years with no maintenance
Universal mount; single or double sided	Ease of ordering & installation
Optional remote capacity to drive 2 or 4 LED heads	Up to 50 feet of indoor/outdoor egress coverage

Certification/Warranty
UL 924 damp location listed
NFPA/NEC/OSHA/CEC code compliant
5 year product warranty
7 year prorated battery warranty



## Ordering Information

SAMPLE NUMBER: APXH7R, APXH7G, APXH7RBK, APXH7GBK

Series	Remote Heads Powered	Battery	Face Options	Letter Colors	Housing Color
APC = All-Pro exit/emergency combo	_ = no remote heads	7 = nickel cadmium battery	_ = Universal	R = red G = green	_ = white BK = black
	H = two 3.6 V LED heads	7 = nickel cadmium battery	_ = Universal	R = red G = green	_ = white BK = black

Series	Remote Heads Powered	Housing Color
APWR = All-Pro emergency remote	1 = one LED head 2 = two LED heads	_ = White BK = Black

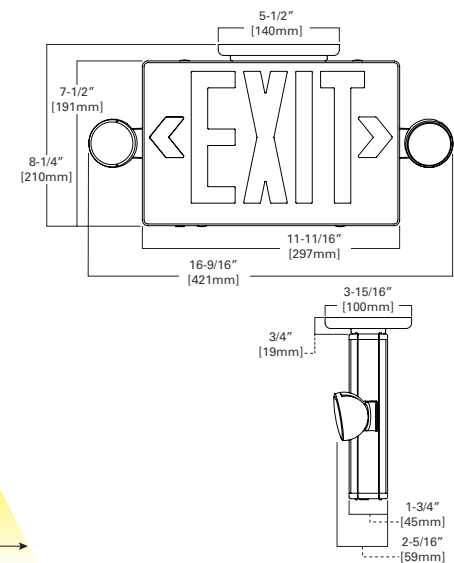

## Spacing

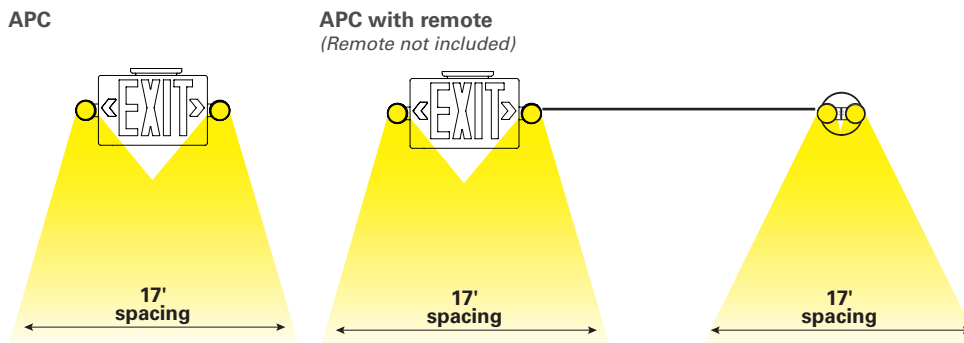

# APEL/APELH2 Polycarbonate LED Emergency



APEL



APELH2

The APEL series is a fully code compliant, polycarbonate LED solution for emergency needs. The LED emergency heads will run for a minimum of 90 minutes. The universal j-box mounting pattern and snap fit housing construction significantly reduce installation time. Options include a white or black housing and remote capacity that can power the APWR LED remote series.

Features	Benefits
LED source with nickel cadmium battery	Up to 10 years with no maintenance
Adjustable heads	Design flexibility
Optional remote capacity to drive 2 LED heads	Up to 34 feet of indoor/outdoor egress coverage

Certification/Warranty
UL 924 damp location listed
NFPA/NEC/OSHA/CEC code compliant
5 year product warranty
7 year prorated battery warranty



## Ordering Information

SAMPLE NUMBER: APEL, APELH2, APELH2BK

Series	Remote Heads Powered	Housing Color
APEL = All-Pro emergency light	_ = no LED heads H2 = two LED heads	_ = White BK = Black
APWR = All-Pro emergency remote	1 = one LED head 2 = two LED heads	_ = White BK = Black

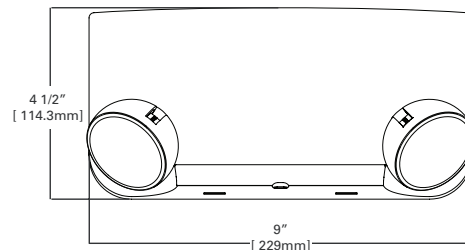

## Spacing

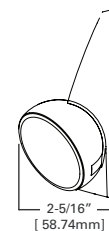
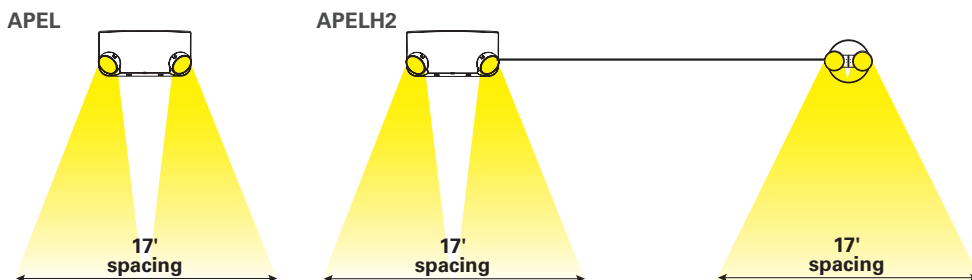

# APWR Polycarbonate LED remote



APWR2



APWR2BK

The APWR series is fully code compliant, polycarbonate LED solution for emergency needs. The heads are fully adjustable and available with a white or black housing. This product is wet location listed and suitable for outdoor applications.

Features	Benefits
LED source	Up to 10 years with no maintenance
Adjustable heads	Design flexibility
Wet location capable	Up to 17 feet of indoor/outdoor egress coverage

Certification/Warranty
UL 924 wet location listed
NFPA/NEC/OSHA code compliant
5 year product warranty
7 year prorated battery warranty



## Ordering Information

SAMPLE NUMBER: APWR1, APWR2, APWR1BK, APWR2BK

Series	Remote Heads Powered	Housing Color
APWR = All-Pro emergency remote	1 = one LED head 2 = two LED heads	_ = White BK = Black

## Spacing

APWR

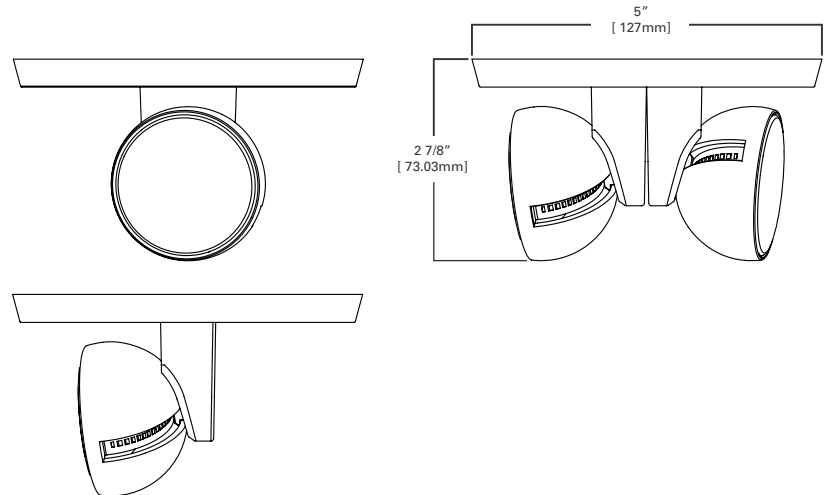
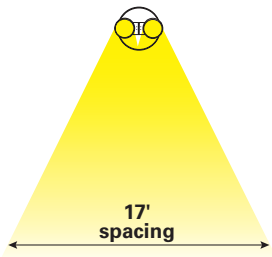



# EBPLED LED Emergency battery pack



The EBPLED series enables electrical contractors to add a UL924 code compliant emergency option to an existing LED fixture. While compatible with almost any LED fixture that has an accessible driver, this series offers guaranteed quality and compatibility with Eaton products.

Features	Benefits
Field installable	Meet emergency code with no aesthetic impact
Satisfies all wiring configurations as conduit and test button are included	Design ease; less SKU's to stock
7 watt or 14 watt output creates 600 to 2500 lumens in emergency mode	Design flexibility; superior egress coverage
Laser test feature enables simplified NFPA testing	Labor savings

Certification/Warranty
UL 924 Classified
NFPA/NEC/OSHA/CEC code compliant
Guaranteed compatibility w/Eaton Fixtures
5 year product warranty
7 year prorated battery warranty



## Ordering Information

SAMPLE NUMBER: EBPLED7W

Series	Output	Run Time
EBPLED = LED emergency battery pack	7W = 7 Watt	_ = 90 minute -3H = 180 minute
	14W = 14 Watt	_ = 90 minute

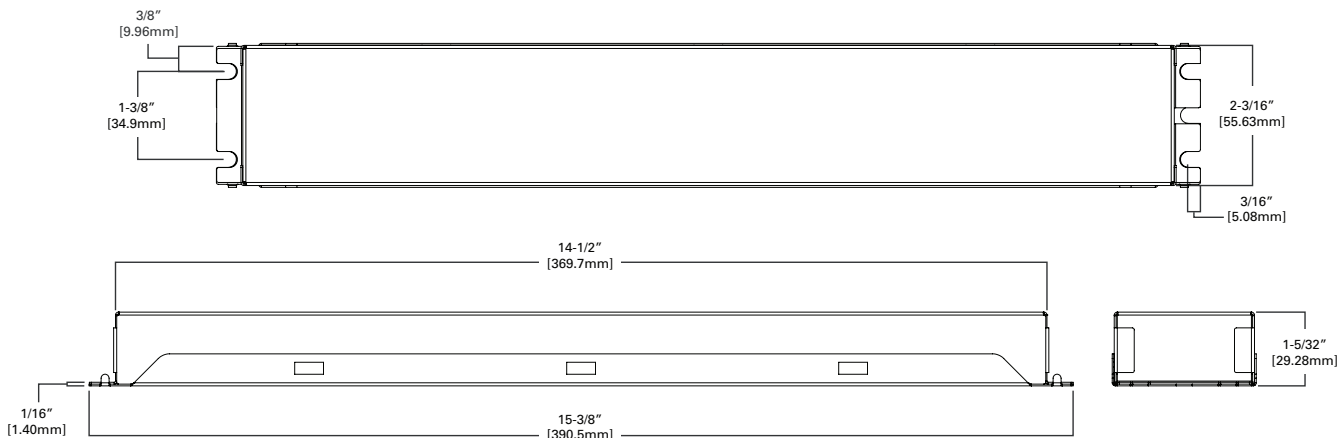

# Cross Reference

Description	All-Pro	Acuity	Hubbell	Barron	Thomas & Betts	Philips	Mule
Green LED Polycarbonate Exit, AC only	APX6G	LQM S W 3 G 120/277	CAG	ILX-G-AC-WH	QLX500G	VEGW	MXAGU
Red LED Polycarbonate Exit, AC only	APX6R	LQM S W 3 R 120/277	CAR	ILX-R-AC-WH	QLX500R	VERW	MXARU
Green LED Polycarbonate Exit, Nickel Cadmium Battery	APX7G	LQM S W 3 G 120/277 EL N	CEG	ILX-G-EM-WH	QLXN500G	VEGWEM	MXBGU
Red LED Polycarbonate Exit, Nickel Cadmium Battery	APX7R	LQM S W 3 R 120/277 EL N	CER	ILX-R-EM-WH	QLXN500R	VERWEM	MXBRU
Green LED Polycarbonate Exit, AC only, Black Option	APX6GBK	LQM S 3 G 120/277	CAGB	ILX-G-AC-BL	N/A	VEGB	MXAGU-BL
Red LED Polycarbonate Exit, AC only, Black Option	APX6RBK	LQM S 3 R 120/277	CARB	ILX-R-AC-BL	N/A	VERB	MXARU-BL
Green LED Polycarbonate Exit, Nickel Cadmium Battery, Black Option	APX7GBK	LQM S 3 G 120/277 EL N	CEGB	ILX-G-EM-BL	N/A	VEGBEM	MXBGU-BL
Red LED Polycarbonate Exit, Nickel Cadmium Battery, Black Option	APX7RBK	LQM S 3 R 120/277 EL N	CERB	ILX-R-EM-BL	N/A	VERBEM	MXBRU-BL
Green LED polycarbonate exit, Remote capacity	APXH7G2	N/A	CERRC	N/A	N/A	VREGWEM	MXBGU-REM
Red LED polycarbonate exit, Remote capacity	APXH7R2	N/A	CEGRC	N/A	N/A	VRERWEM	MXBRU-REM
Green LED polycarbonate exit, Remote capacity	APXH7G4	N/A	CERRC	N/A	N/A	VREGWEM	N/A
Red LED polycarbonate exit, Remote capacity	APXH7R4	N/A	CEGRC	N/A	N/A	VRERWEM	N/A
LED Adjustable Heads, Nickel Cadmium Battery, 90-min Run-Time	APEL	EU2 LED M12	CU2	LL90-G2	LCAB-2SQLED	VLLU	SQ-80
High-powered, Two LED Adjustable Heads, Nickel Cadmium Battery, 90-min Run-Time	APEL H2	EU2 LED HO M6	CU2RC	LL90-R	LCAB-2SQLEDRID	VLLUR	SQ-120
LED adjustable heads, Nickel cadmium battery, 90-min run-time, Black option	APELBK	ELM2 LED B	CU2SQ	LL90-G2-B	N/A	N/A	SQ-LED-80-B
High-powered, Two LED adjustable heads, Nickel cadmium battery, 90-min run-time, Black option	APEL BK H2	ELM2 LED B HO	CU2SQB	LL90-R-B	N/A	N/A	SQ-LED-120-B
3.6V LED adjustable head, Outdoor rated	APWR1	ELA LED WP M12	CIRS	LED-51-WH	ELF612D	VLT1R	RLED-1-SD-WP-3.6V
Outdoor rated, 3.6V LED adjustable heads	APWR2	ELA LED T WP M12	CIRD	LED-52-WH-G2	ELF612D/LED	VLT2R	RLED-2-SD-WP-3.6V
3.6V LED Adjustable Head, Outdoor rated, Black option	APWR1BK	N/A	N/A	LED-51-BL	N/A	VLL1RGO	N/A
Outdoor rated, 3.6V LED adjustable heads, Black option	APWR2BK	N/A	N/A	LED-52-BL-R2	N/A	VLL2RGO	N/A
LED source with nickel cadmium battery, Red	APC7R	ECR LED M6	CCR	VLED-U-WH-EL90	UQLX-N500R-2LD1N	VLLCR	SQC-LED-U-R-WW
LED source with nickel cadmium battery, Green	APC7G	ECG LED M6	CCG	GVLED-U-WH-EL90	UQLXN500G-2LD1N	VLLCG	SQC-LED-U-G-WW
LED source with nickel cadmium battery, Red, Black option	APC7RBK	N/A	CCRB	VLED-U-BL-EL90	N/A	N/A	SQC-LED-U-R-BB
LED source with nickel cadmium battery, Green, Black option	APC7GBK	N/A	CCGB	GVLED-U-BL-EL90	N/A	N/A	SQC-LED-U-G-BB
3.6V LED heads with nickel cadmium battery, Remote capacity, Red	APCH7R	ECR LED HO M6	CCRRC	VLEDC-51-WH-R	UQLXN500R-2LED R	VLLCR2R	SQC-LED-U-R-WW-REM
3.6V LED heads with nickel cadmium battery, Remote capacity, Green	APCH7G	ECG LED HO M6	CCGRC	GVLEDC-51-WH-R	UQLXN500G-2LED R	VLLCG2R	SQC-LED-U-G-WW-REM
3.6V LED heads with nickel cadmium battery, Remote capacity, Red, Black option	APCH7RBK	N/A	CCRRCB	VLEDC-51-BK-R	UQLXN500R-2LEDRB	N/A	SQC-LED-U-R-BB-REM
3.6V LED heads with nickel cadmium battery, Remote capacity, Green, Black option	APCH7GBK	N/A	N/A	GVLEDC-51-BK-R	UQLXN500G-2LEDRB	N/A	SQC-LED-U-G-BB-REM

### **Lighting Product Lines**

Halo  
Halo Commercial  
Portfolio  
Iris  
RSA  
Metalux  
Corelite  
Neo-Ray  
Fail-Safe  
MWS  
Ametrix  
Shaper  
io  
Lumark  
McGraw-Edison  
Invue  
Ephesus  
Lumière  
Streetworks  
AtLite  
Sure-Lites

### **Controls Product Lines**

Greengate  
iLumin  
Zero 88  
Fifth Light Technology  
iLight (International Only)

### **Connected Lighting Systems**

LumaWatt Pro  
WaveLinx  
Distributed Low-Voltage Power  
ConnectWorks

**Eaton**  
1121 Highway 74 South  
Peachtree City, GA 30269  
P: 770-486-4800  
[www.eaton.com/lighting](http://www.eaton.com/lighting)

**Canada Sales**  
5925 McLaughlin Road  
Mississauga, Ontario L5R 1B8  
P: 905-501-3000  
F: 905-501-3172

© 2017 Eaton  
All Rights Reserved  
Printed in USA  
Publication No. BR505016EN  
November 15, 2017

Eaton is a registered trademark.

All other trademarks are property of their respective owners.

Product availability, specifications, and compliances are subject to change without notice.