



Dual-Rated Mechanical Connectors

Type ADR-ALCÜL™ — Single Conductor, One-Hole Mount

- For copper and aluminum conductors
- Easy installation – no special tools required
- Tin-plated for low contact resistance
- CSA Certified and UL Listed, AL9CU, 600 V Rated
- All aluminum bodies
- Slotted screw on lugs up through 2/0 str.; 5/16 socket screw on sizes 250 through 350 kcmil; 3/8 hex socket on sizes 500 kcmil and above



Cat. No.	Conductor Range		Dimensions (in.)						
	Max.	Min.	L	W	H	D	E	F	G
Slotted Screw									
ADR6	6 str.	14 AWG	1-3/64	1/2	31/64	15/64	1/4	5/64	43/64
ADR2	2 str.		1-5/32		9/16	19/64		7/64	11/16
ADR11	1/0 str.		1-15/32	5/8	25/32	7/16		3/16	27/32
ADR21	2/0 str.								
Socket Screw									
ADR25	250 kcmil	6 str.	2	1	1-1/8	15/32	5/16	1/4	1
ADR30	300 kcmil								
ADR35	350 kcmil	6 str.	2-1/4	1-1/8	1-1/4	1/2	3/8	5/16	1-1/8
ADR50	500 kcmil	4 str.	2-13/16	1-1/2	1-9/16	3/4		7/16	1-19/32
ADR60	600 kcmil	2 str.	3-3/16			13/16		5/16	1-13/16
ADR6004*	600 kcmil (2) 250 kcmil	4 str. (2) 1/0 str.	2-13/16	1-3/8	1-13/16	5/8		5/16	1-1/2
ADR80	800 kcmil	300 kcmil	3-3/8	1-3/4	1-15/16	7/8	1/2	1-3/4	
ADR99	1000 kcmil	500 kcmil							

* UL and CSA not applicable.

Type ADR-ALCÜL™ — Anti-Rotational Connector

- Unique bottom rib keeps connector from turning
- Eliminates the need for excessive torque, which can damage large conductors
- Prevents connector loosening, even in heavy-vibration applications



Cat. No.	Conductor Range		Bolt Hole (in.)	Figure
	Max.	Min.		
ADR21-AR	2/0	14 AWG	1/4	1
ADR30-AR	300 kcmil	6 AWG	7/16	
ADR35-AR	350 kcmil	6 AWG	5/16	
ADR60-AR	600 kcmil	2 AWG	1/2	
ADR35-21-AR	350 kcmil	6 AWG	3/8	2
ADR60-21-AR	600 kcmil	2 AWG	1/2	2



Fig. 1

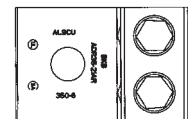

Fig. 2

Dual-Rated Mechanical Connectors

Type ADR-ALCÜL™ — Single Conductor, Two-Hole Mount*

- For copper and aluminum conductors
- Easy installation – no special tools required
- Tin-plated for low contact resistance
- All aluminum bodies

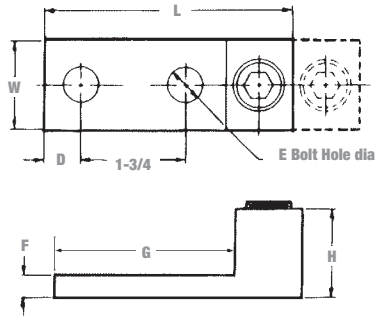

Fig. 1



Fig. 2



Cat. No.	Figure	Conductor Range (Al or Cu)		Dimensions (in.)						
		Max.	Min.	L	W	H	D	E	F	G
ADR35-12	2	350 kcmil	6 str.	4-1/4	1-1/4	1-3/8	5/8	1/2	5/16	3
ADR60-12D		600 kcmil	2 str.	5-5/16	1-1/2	1-1/2			3/8	3-1/16
ADR80-12D		800 kcmil	300 kcmil	6-3/16	1-3/4	1-7/8			9/16	3-7/16
ADR99-12D		1,000 kcmil	350 kcmil							

* NEMA spacing: 1-3/4 in. centers.
Connectors accommodating conductors 600 kcmil and larger have double row of set screws (D suffix).

Type ADR-ALCÜL™ — Single Conductor, Switchgear Mount*

- For copper and aluminum conductors
- Easy installation – no special tools required
- Tin-plated for low contact resistance
- All aluminum bodies

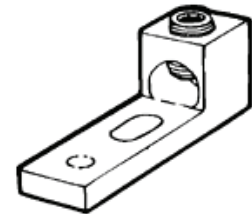
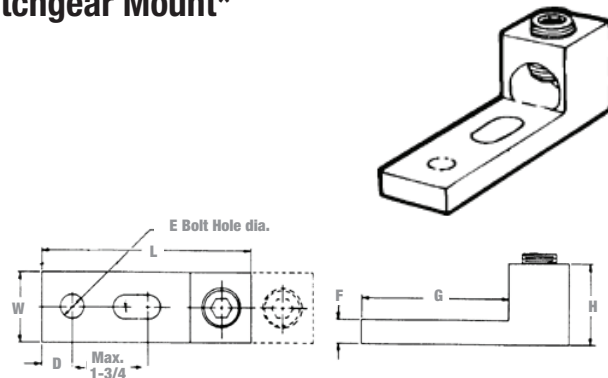

Cat. No.	Conductor Range (Al or Cu)		Dimensions (in.)						
	Max.	Min.	L	W	H	D	E	F	G
ADR35-12S	350 kcmil	4 str.	4-11/16	1-1/4	1-9/16	23/32	1/2	7/16	3-5/16
ADR80-12DS	800 kcmil	300 kcmil	6-3/16	1-5/8	1-7/8			9/16	3-7/16

* NEMA spacing: 1-3/4 in. centers except ADR25-12S: 1 in. centers.
Connectors accommodating conductors 600 kcmil and larger have double row of set screws (D suffix).



Dual-Rated Mechanical Connectors

Type ASL-ALCÜL™ — Two Conductors, One-Hole Mount

- For copper and aluminum conductors
- Easy installation – no special tools required
- Tin-plated for low contact resistance
- All aluminum bodies

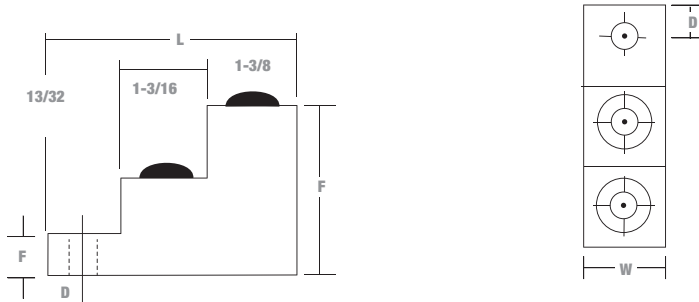

Cat. No.	Conductor Range		Dimensions (in.)					Mtg. Hole Dia.
	Max.	Min.	L	W	H	D	F	
ASL30-21	300 kcmil	6 str.	3	1-1/8	2	15/32	1/2	5/16



Type ASL-ALCÜL™ — Two Conductors, Two-Hole Mount

- For copper and aluminum conductors
- Easy installation – no special tools required
- Tin-plated for low contact resistance
- All aluminum bodies

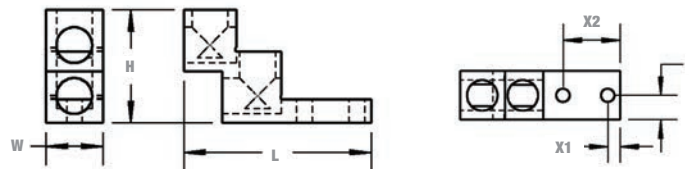

Cat. No.	Conductor Range		Dimensions (in.)					
	Max.	Min.	L	W	H	X1	X2	Y1
ASL60-22	600 kcmil	2 str.	4.91	1.50	2.96	0.375	1.75	0.75
ASL75-22	750 kcmil	3/0 str.		1.69				0.84

Dual-Rated Mechanical Connectors

Type ADR-ALCÜL™ — Two Conductors, One-Hole Mount

- For copper and aluminum conductors
- Easy installation – no special tools required
- Tin-plated for low contact resistance
- All aluminum bodies

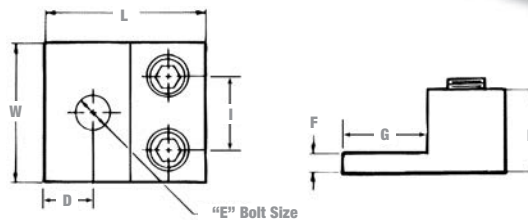

Cat. No.	Conductor Range		Dimensions (in.)							
	Max.	Min.	L	W	H	D	E	F	G	I
ADR11-21	1/0 str.	14 AWG	1-15/32	1-7/32	25/32	7/16	1/4	3/16	27/32	35/64
ADR21-21	2/0 str.			1-1/4		27/64				
ADR25-21	250 kcmil	6 str.	2-9/16	1-41/64	1-3/16	7/8	3/8	1/4	1-9/16	13/16
ADR35-21	350 kcmil			1-59/64						
ADR60-21	600 kcmil	2 str.	3-3/16	2-13/32	1-9/16	5/8	1/2	7/16	1-13/16	1-7/32
ADR80-21	800 kcmil	300 kcmil	3-3/8	3-3/16	1-15/16	7/8		5/8	1/2	1-3/4
ADR99-21	1000 kcmil	500 kcmil								

Type ADR-ALCÜL™ — Two Conductors, Two-Hole Mount*

- For copper and aluminum conductors
- Easy installation – no special tools required
- Tin-plated for low contact resistance
- All aluminum bodies

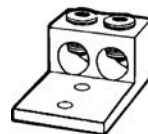

Fig. 1

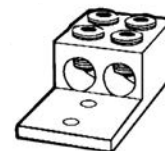
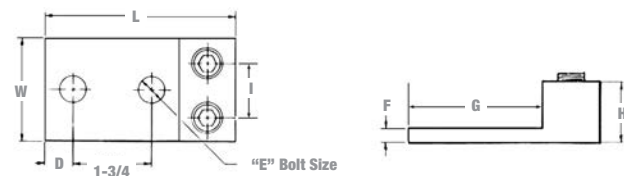

Fig. 2



Cat. No.	Figure	Conductor Range		Dimensions (in.)							
		Max.	Min.	L	W	H	D	E	F	G	I
ADR35-22	1	350 kcmil	6 str.	4-1/4	2-19/64	1-3/8	5/8	1/2	5/16	3	1-7/32
ADR60-22D		600 kcmil	2 str.	5-5/16	2-3/4	1-1/2			3/8		1-7/16
ADR80-22D	2	800 kcmil	300 kcmil	6-3/16	3-1/2	1-7/8	5/8	1/2	9/16	3-1/16	1-13/16
ADR99-22D		1000 kcmil	350 kcmil								

* NEMA Spacing: 1-3/4 in. centers.
Connectors accommodating conductors 600 kcmil and larger have double row of set screws (D suffix).



Dual-Rated Mechanical Connectors

Type ASL-ALCÜL™ — Three Conductors, Two-Hole Mount

- For copper and aluminum conductors
- Easy installation – no special tools required
- Tin-plated for low contact resistance
- All aluminum bodies

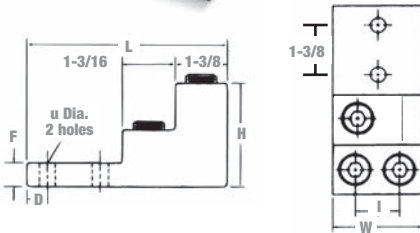

Cat. No.	Conductor Range		Dimensions (in.)								
	Max.	Min.	L	W	H	F	D	I	X2	X1	Y
ASL60-32	600 kcmil	2 str.	4-29/32	2-1/2	3	3/4	3/8	1-7/32	1.75	0.375	1.234

Type ASL-ALCÜL™ — Four Conductors, Two-Hole Mount

- For copper and aluminum conductors
- Easy installation – no special tools required
- Tin-plated for low contact resistance
- All aluminum bodies

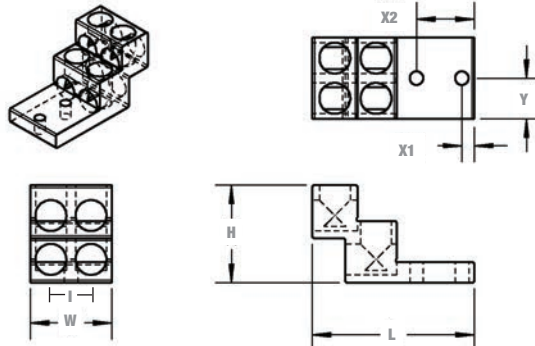

Cat. No.	Conductor Range		Dimensions (in.)								
	Max.	Min.	L	W	H	F	D	I	X2	X1	Y
ASL60-42	600 kcmil	2 str.	4-29/32	2-1/2	3	3/4	3/8	1-7/32	1.75	0.375	1.234
ASL75-42	750 kcmil	3/0 str.	4-49/32	2-27/21				1-5/16			

Dual-Rated Mechanical Connectors

Type ADR-ALCÜL™ — Three Conductors, Two-Hole Mount*

- For copper and aluminum conductors
- Easy installation – no special tools required
- Tin-plated for low contact resistance
- CSA Certified and UL Listed
- All aluminum bodies

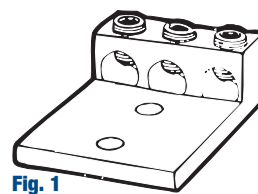
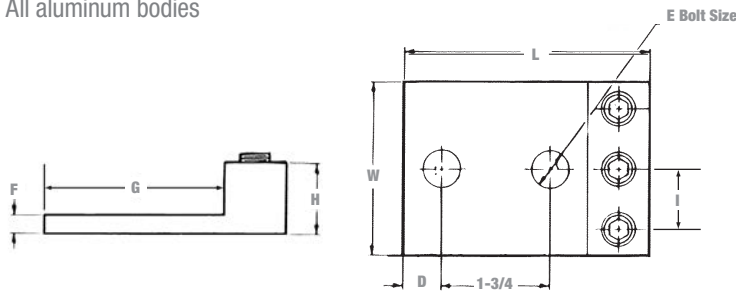

Fig. 1

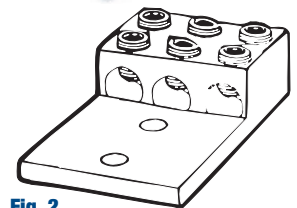

Fig. 2



Cat. No.	Fig. No.	Conductor Range		Dimensions (in.)								
		Max.	Min.	L	W	H	D	E	F	G	I	
ADR02-32	1	2 str.	14 AWG	2-3/16	1-5/8	5/8	11/32	5/16	3/16	1-11/16	9/16	
ADR11-32		1/0 str.		2-29/32	2	7/8		3/8	1/4	2-5/32	45/64	
ADR31-32		3/0 str.	6 str.	4	2-13/16	1-3/16	5/8	1/2	5/16	3	31/32	
ADR25-32		250 kcmil		4-3/16					3-3/16	1-1/4	1/4	3-1/16
ADR35-32		350 kcmil		6 str.	3-3/16	1-1/4			7/16	3-5/16	1-1/4	
ADR50-32		2	500 kcmil	4 str.	4-11/16	3-3/4	1-9/16	5/8	1/2	3/8	3-1/6	1-7/16
ADR60-32D			600 kcmil	2 str.	5-5/16	4-3/16	1-1/2			9/16	3-7/16	1-9/16
ADR80-32	800 kcmil		300 kcmil	6-3/16	4-1/2	1-7/8	9/16			3-7/16	1-41/64	
ADR99-32	1000 kcmil		500 kcmil		4-3/4							

* NEMA Spacing: 1-3/4 in. centers except ADR02-32; 7/8 in. centers and ADR11-32; 1 in. centers. Connectors accommodating conductors 600 kcmil and larger have double row of set screws (D suffix).

Dual-Rated Mechanical Connectors

Type ADR-ALCÜL™ — Three Conductors, Four-Hole Mount**

- For copper and aluminum conductors
- Easy installation – no special tools required
- Tin-plated for low contact resistance
- All aluminum bodies

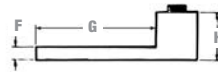
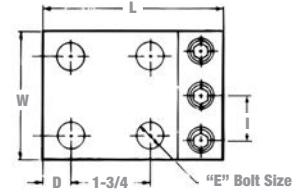
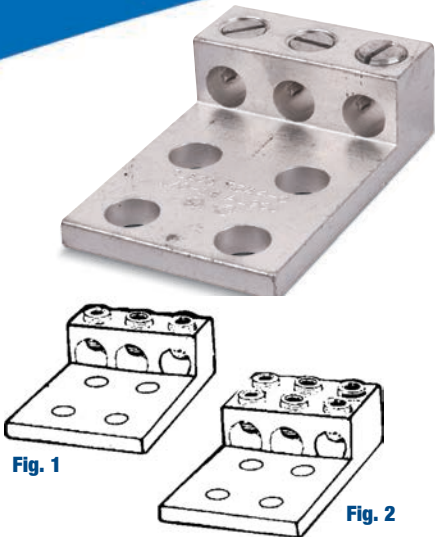

Cat. No.	Fig. No.	Conductor Range		Dimensions (in.)							
		Max.	Min.	L	W	H	D	E	F	G	I
ADR02-34	1	2 str.	14 AWG	2-3/16	1-5/8	5/8	11/32	5/16	3/16	1-11/16	9/16
ADR11-34		1/0 str.		2-29/32	2	7/8		3/8	1/4	2-5/32	45/64
ADR31-34		3/0 str.		4	1-3/16	5/8		5/16	3	31/32	
ADR25-34*		250 kcmil	6 str.	4-3/16	2-13/16	1-1/4	5/8	1/2	1/4	3-1/16	1-1/32
ADR35-34*		350 kcmil		3-3/16	1-1/4	1-1/4			1-1/4		
ADR50-34*		500 kcmil	4 str.	4-11/16	3-3/4	1-9/16			7/16	3-5/16	1-1/4
ADR60-34D		600 kcmil	2 str.	5-5/16	4-3/16	1-1/2			3/8	3-1/16	1-7/16
ADR80-34*		800 kcmil	300 kcmil	6-3/16	4-1/2	1-7/8			9/16	3-7/16	1-9/16
ADR99-34*		1000 kcmil	500 kcmil		4-3/4	1-7/8					1-41/64

* UL Listed.
 ** NEMA Spacing: 1-3/4 in. centers except ADR02-34; 7/8 in. centers and ADR11-34; 1 in. centers.
 Connectors accommodating conductors 600 kcmil and larger have double row of set screws (D suffix).

Type ADR-ALCÜL™ — Four Conductors, Four-Hole Mount*

- For copper and aluminum conductors
- Easy installation – no special tools required
- Tin-plated for low contact resistance
- All aluminum bodies

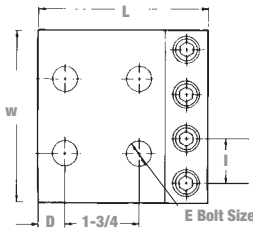

Cat. No.	Fig. No.	Conductor Range		Dimensions (in.)							
		Max.	Min.	L	W	H	D	E	F	G	I
ADR25-44	1	250 kcmil	6 str.	4	4-1/16	1-3/16	5/8	1/2	5/16	3	1-3/64
ADR35-44		350 kcmil		4-1/4	4-23/32	1-3/8			3/8	3-1/16	1-7/32
ADR60-44D	2	600 kcmil	2 str.	5-5/16	5-5/8	1-1/2	5/8	1/2	3/8	3-1/16	1-7/16
ADR80-44D		800 kcmil		350 kcmil	6-3/16	7-1/8			1-7/8	9/16	3-7/16

* NEMA Spacing: 1-3/4 in. centers.
 Connectors accommodating conductors 600 kcmil and larger have double row of set screws (D suffix).

Dual-Rated Mechanical Connectors

Type ASR-ALCÜL™ — Splice Reducers with Solid Barrier Wire Stop

- For copper and aluminum conductors
- Easy installation – no special tools required
- Tin-plated for low contact resistance
- All aluminum bodies

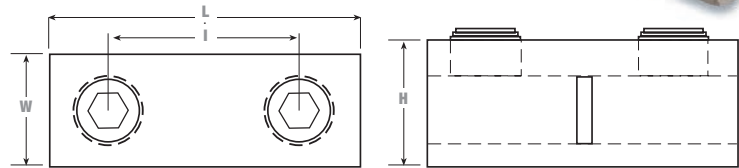

Cat. No.	Conductor Range (Al or Cu)		Dimensions (in.)				
	Max.	Min.	L	W	H	I	
ASR0214*	2 str.	14 AWG	1-1/4	33/64	39/64	21/32	
ASR1114*	1/0 str.		1-1/2	39/64	23/32	51/64	
ASR2506	250 kcmil	6 str.	2-1/8	55/64	31/32	1-7/64	
ASR3506	350 kcmil		2-3/8	1-1/32	1-1/8	1-1/4	
ASR7525**	750 kcmil	250 kcmil	6-1/4	1-5/8	1-3/4	1-5/8	

* Slotted screws.

** Two set screws per end. CSA not applicable.

Type BX-ALCÜL™ — Rectangular Connectors

- Recognized component in accordance with UL standard – 90°C rating
- Anti-rotational boss
- For copper and aluminum conductors
- Easy installation – no special tools required
- Tin-plated for low contact resistance
- All aluminum bodies



Cat. No.	Conductor Range		Style & Size of Boss	Boss Hole Tapped	Dimensions (in.)		
	Max.	Min.			L	W	H
BX0214	2	14 Cu 12 Al	Square 0.229 in.	10-32	15/32	15/32	9/16
BX1114	1/0				5/8	17/32	39/64

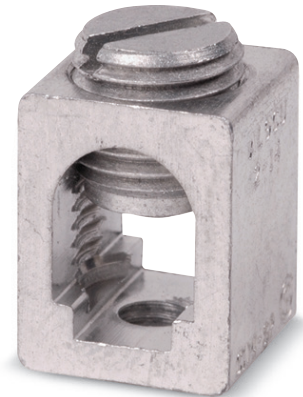
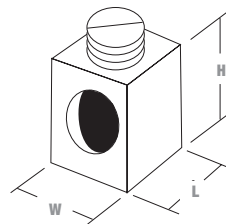

Tightening Torque Values for Aluminum Dual-Rated Socket Screw Connectors

AWG or Circular Mil Size	Tightening Torque (in.-lb.)		AWG or Circular Mil Size	Tightening Torque (in.-lb.)		
	Screwdriver	Wrench		Screwdriver	Wrench	
12	20	75	4/0	-	200	
10			250			
8			350			
6	35	100	500			300
4			600			
2			700			
1	50	125	750	400		
1/0			800			
2/0			1000			
3/0	-	200	-			



Dual-Rated Mechanical Connectors

Type ADR-ALCÜL™ — Single Conductor, One-Hole Mount

- For copper and aluminum conductors
- Easy installation – no special tools required
- Tin-plated for low contact resistance
- CSA Certified and UL Listed, AL9CU, 600 V Rated
- All aluminum bodies
- Slotted screw on lugs up through 2/0 str.; 5/16 socket screw on sizes 250 through 350 kcmil; 3/8 hex socket on sizes 500 kcmil and above



Cat. No.	Conductor Range		Dimensions (in.)						
	Max.	Min.	L	W	H	D	E	F	G
Slotted Screw									
ADR6	6 str.	14 AWG	1-3/64	1/2	31/64	15/64	1/4	5/64	43/64
ADR2	2 str.		1-5/32		9/16	19/64		7/64	11/16
ADR11	1/0 str.		1-15/32	5/8	25/32	7/16		3/16	27/32
ADR21	2/0 str.								
Socket Screw									
ADR25	250 kcmil	6 str.	2	1	1-1/8	15/32	5/16	1/4	1
ADR30	300 kcmil								
ADR35	350 kcmil	6 str.	2-1/4	1-1/8	1-1/4	1/2	3/8	5/16	1-1/8
ADR50	500 kcmil	4 str.	2-13/16	1-1/2	1-9/16	3/4		7/16	1-19/32
ADR60	600 kcmil	2 str.	3-3/16			13/16		5/16	1-13/16
ADR6004*	600 kcmil (2) 250 kcmil	4 str. (2) 1/0 str.	2-13/16	1-3/8	1-13/16	5/8		5/16	1-1/2
ADR80	800 kcmil	300 kcmil	3-3/8	1-3/4	1-15/16	7/8	1/2	1-3/4	
ADR99	1000 kcmil	500 kcmil							

* UL and CSA not applicable.

Type ADR-ALCÜL™ — Anti-Rotational Connector

- Unique bottom rib keeps connector from turning
- Eliminates the need for excessive torque, which can damage large conductors
- Prevents connector loosening, even in heavy-vibration applications



Cat. No.	Conductor Range		Bolt Hole (in.)	Figure
	Max.	Min.		
ADR21-AR	2/0	14 AWG	1/4	1
ADR30-AR	300 kcmil	6 AWG	7/16	
ADR35-AR	350 kcmil	6 AWG	5/16	
ADR60-AR	600 kcmil	2 AWG	1/2	
ADR35-21-AR	350 kcmil	6 AWG	3/8	2
ADR60-21-AR	600 kcmil	2 AWG	1/2	2



Fig. 1

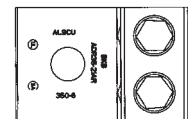

Fig. 2

Dual-Rated Mechanical Connectors

Type ADR-ALCÜL™ — Single Conductor, Two-Hole Mount*

- For copper and aluminum conductors
- Easy installation – no special tools required
- Tin-plated for low contact resistance
- All aluminum bodies

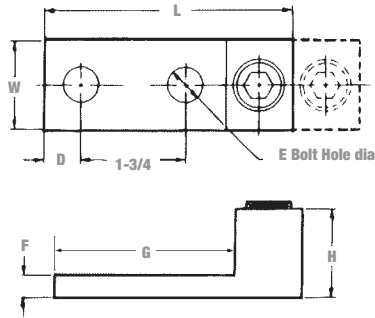

Fig. 1



Fig. 2



Cat. No.	Figure	Conductor Range (Al or Cu)		Dimensions (in.)						
		Max.	Min.	L	W	H	D	E	F	G
ADR35-12	2	350 kcmil	6 str.	4-1/4	1-1/4	1-3/8	5/8	1/2	5/16	3
ADR60-12D		600 kcmil	2 str.	5-5/16	1-1/2	1-1/2			3/8	3-1/16
ADR80-12D		800 kcmil	300 kcmil	6-3/16	1-3/4	1-7/8			9/16	3-7/16
ADR99-12D		1,000 kcmil	350 kcmil							

* NEMA spacing: 1-3/4 in. centers.
Connectors accommodating conductors 600 kcmil and larger have double row of set screws (D suffix).

Type ADR-ALCÜL™ — Single Conductor, Switchgear Mount*

- For copper and aluminum conductors
- Easy installation – no special tools required
- Tin-plated for low contact resistance
- All aluminum bodies

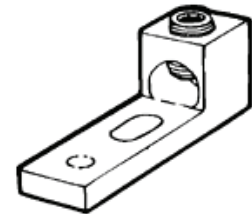
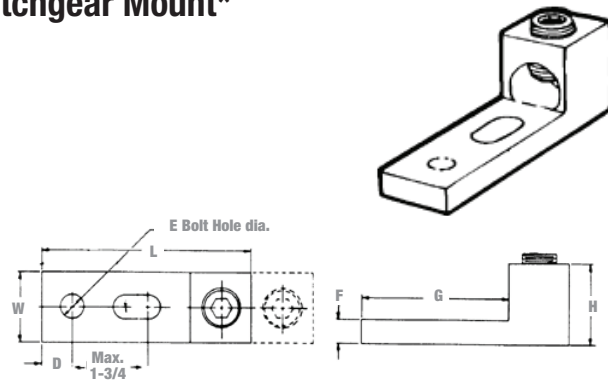

Cat. No.	Conductor Range (Al or Cu)		Dimensions (in.)						
	Max.	Min.	L	W	H	D	E	F	G
ADR35-12S	350 kcmil	4 str.	4-11/16	1-1/4	1-9/16	23/32	1/2	7/16	3-5/16
ADR80-12DS	800 kcmil	300 kcmil	6-3/16	1-5/8	1-7/8			9/16	3-7/16

* NEMA spacing: 1-3/4 in. centers except ADR25-12S: 1 in. centers.
Connectors accommodating conductors 600 kcmil and larger have double row of set screws (D suffix).



Dual-Rated Mechanical Connectors

Type ASL-ALCÜL™ — Two Conductors, One-Hole Mount

- For copper and aluminum conductors
- Easy installation – no special tools required
- Tin-plated for low contact resistance
- All aluminum bodies

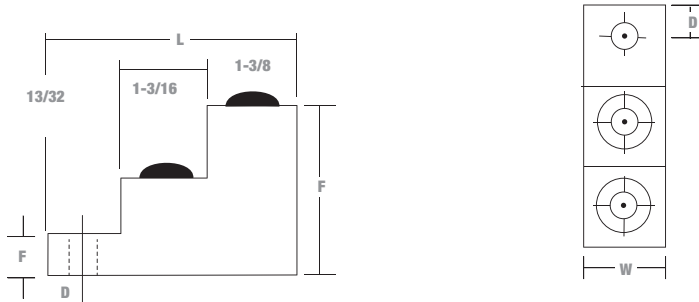

Cat. No.	Conductor Range		Dimensions (in.)					Mtg. Hole Dia.
	Max.	Min.	L	W	H	D	F	
ASL30-21	300 kcmil	6 str.	3	1-1/8	2	15/32	1/2	5/16



Type ASL-ALCÜL™ — Two Conductors, Two-Hole Mount

- For copper and aluminum conductors
- Easy installation – no special tools required
- Tin-plated for low contact resistance
- All aluminum bodies

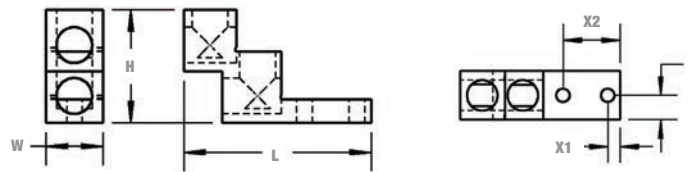

Cat. No.	Conductor Range		Dimensions (in.)					
	Max.	Min.	L	W	H	X1	X2	Y1
ASL60-22	600 kcmil	2 str.	4.91	1.50	2.96	0.375	1.75	0.75
ASL75-22	750 kcmil	3/0 str.		1.69				0.84

Dual-Rated Mechanical Connectors

Type ADR-ALCÜL™ — Two Conductors, One-Hole Mount

- For copper and aluminum conductors
- Easy installation – no special tools required
- Tin-plated for low contact resistance
- All aluminum bodies

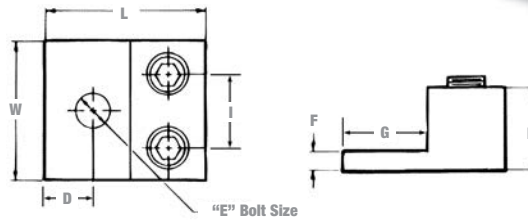

Cat. No.	Conductor Range		Dimensions (in.)							
	Max.	Min.	L	W	H	D	E	F	G	I
ADR11-21	1/0 str.	14 AWG	1-15/32	1-7/32	25/32	7/16	1/4	3/16	27/32	35/64
ADR21-21	2/0 str.			1-1/4		27/64				
ADR25-21	250 kcmil	6 str.	2-9/16	1-41/64	1-3/16	7/8	3/8	1/4	1-9/16	13/16
ADR35-21	350 kcmil			1-59/64						
ADR60-21	600 kcmil	2 str.	3-3/16	2-13/32	1-9/16	5/8	1/2	7/16	1-13/16	1-7/32
ADR80-21	800 kcmil	300 kcmil	3-3/8	3-3/16	1-15/16	7/8		5/8	1/2	1-3/4
ADR99-21	1000 kcmil	500 kcmil								

Type ADR-ALCÜL™ — Two Conductors, Two-Hole Mount*

- For copper and aluminum conductors
- Easy installation – no special tools required
- Tin-plated for low contact resistance
- All aluminum bodies

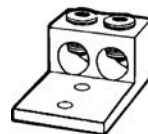

Fig. 1

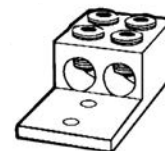
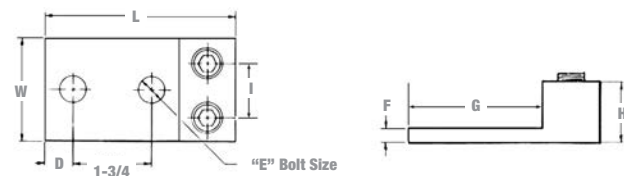

Fig. 2



Cat. No.	Figure	Conductor Range		Dimensions (in.)							
		Max.	Min.	L	W	H	D	E	F	G	I
ADR35-22	1	350 kcmil	6 str.	4-1/4	2-19/64	1-3/8	5/8	1/2	5/16	3	1-7/32
ADR60-22D		600 kcmil	2 str.	5-5/16	2-3/4	1-1/2			3/8		1-7/16
ADR80-22D	2	800 kcmil	300 kcmil	6-3/16	3-1/2	1-7/8	5/8	1/2	9/16	3-1/16	1-13/16
ADR99-22D		1000 kcmil	350 kcmil								

* NEMA Spacing: 1-3/4 in. centers.
Connectors accommodating conductors 600 kcmil and larger have double row of set screws (D suffix).



Dual-Rated Mechanical Connectors

Type ASL-ALCÜL™ — Three Conductors, Two-Hole Mount

- For copper and aluminum conductors
- Easy installation – no special tools required
- Tin-plated for low contact resistance
- All aluminum bodies

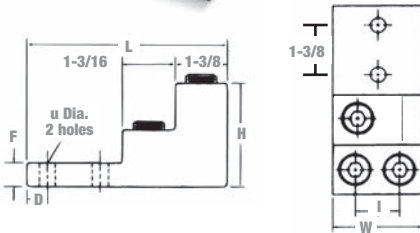

Cat. No.	Conductor Range		Dimensions (in.)								
	Max.	Min.	L	W	H	F	D	I	X2	X1	Y
ASL60-32	600 kcmil	2 str.	4-29/32	2-1/2	3	3/4	3/8	1-7/32	1.75	0.375	1.234

Type ASL-ALCÜL™ — Four Conductors, Two-Hole Mount

- For copper and aluminum conductors
- Easy installation – no special tools required
- Tin-plated for low contact resistance
- All aluminum bodies

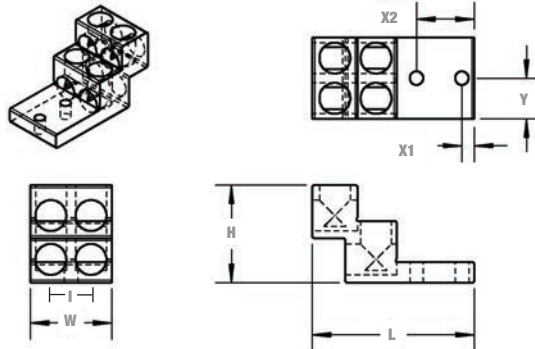

Cat. No.	Conductor Range		Dimensions (in.)								
	Max.	Min.	L	W	H	F	D	I	X2	X1	Y
ASL60-42	600 kcmil	2 str.	4-29/32	2-1/2	3	3/4	3/8	1-7/32	1.75	0.375	1.234
ASL75-42	750 kcmil	3/0 str.	4-49/32	2-27/21				1-5/16			

Dual-Rated Mechanical Connectors

Type ADR-ALCÜL™ — Three Conductors, Two-Hole Mount*

- For copper and aluminum conductors
- Easy installation – no special tools required
- Tin-plated for low contact resistance
- CSA Certified and UL Listed
- All aluminum bodies

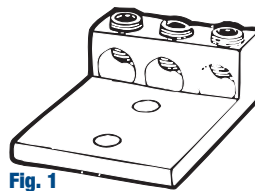
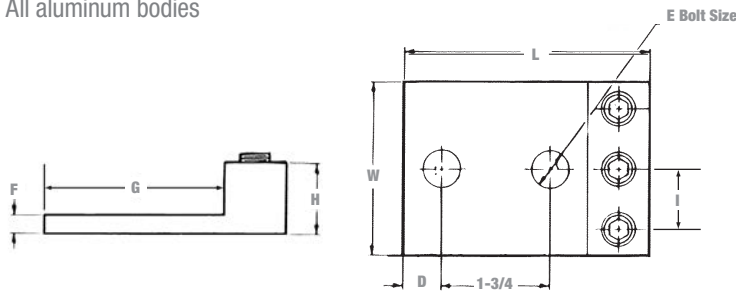

Fig. 1

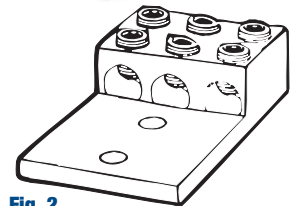

Fig. 2



Cat. No.	Fig. No.	Conductor Range		Dimensions (in.)							
		Max.	Min.	L	W	H	D	E	F	G	I
ADR02-32	1	2 str.	14 AWG	2-3/16	1-5/8	5/8	11/32	5/16	3/16	1-11/16	9/16
ADR11-32		1/0 str.		2-29/32	2	7/8		3/8	1/4	2-5/32	45/64
ADR31-32		3/0 str.	6 str.	4	2-13/16	1-3/16	5/8	1/2	5/16	3	31/32
ADR25-32		250 kcmil		4-3/16					3-3/16	1-1/4	1/4
ADR35-32		350 kcmil		4 str.	4-11/16	3-3/4			1-9/16	7/16	3-5/16
ADR50-32		2	500 kcmil	2 str.	5-5/16	4-3/16	1-1/2	3/8	3-1/6	3-1/6	1-7/16
ADR60-32D			600 kcmil		6-3/16	4-1/2	1-7/8				
ADR80-32	800 kcmil		300 kcmil	4-3/4	1-7/8	1-7/8	9/16	3-7/16	1-41/64		
ADR99-32	1000 kcmil		500 kcmil								

* NEMA Spacing: 1-3/4 in. centers except ADR02-32; 7/8 in. centers and ADR11-32; 1 in. centers. Connectors accommodating conductors 600 kcmil and larger have double row of set screws (D suffix).

Dual-Rated Mechanical Connectors

Type ADR-ALCÜL™ — Three Conductors, Four-Hole Mount**

- For copper and aluminum conductors
- Easy installation – no special tools required
- Tin-plated for low contact resistance
- All aluminum bodies

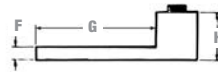
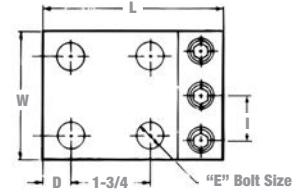
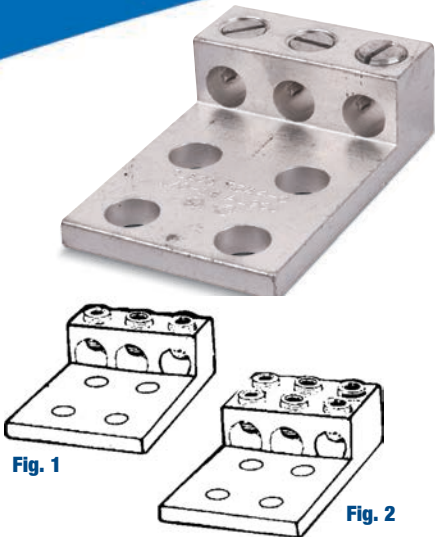

Cat. No.	Fig. No.	Conductor Range		Dimensions (in.)							
		Max.	Min.	L	W	H	D	E	F	G	I
ADR02-34	1	2 str.	14 AWG	2-3/16	1-5/8	5/8	11/32	5/16	3/16	1-11/16	9/16
ADR11-34		1/0 str.		2-29/32	2	7/8		3/8	1/4	2-5/32	45/64
ADR31-34		3/0 str.	4	1-3/16	5/8	5/16		3	31/32		
ADR25-34*		250 kcmil	6 str.	4-3/16	2-13/16	1-1/4	5/8	1/2	1/4	3-1/16	1-1/32
ADR35-34*		350 kcmil									
ADR50-34*		500 kcmil	4 str.	4-11/16	3-3/4	1-9/16					
ADR60-34D		600 kcmil	2 str.	5-5/16	4-3/16	1-1/2			3/8	3-1/16	1-7/16
ADR80-34*		800 kcmil	300 kcmil	6-3/16	4-1/2	1-7/8			9/16	3-7/16	1-9/16
ADR99-34*		1000 kcmil									

* UL Listed.
 ** NEMA Spacing: 1-3/4 in. centers except ADR02-34; 7/8 in. centers and ADR11-34; 1 in. centers.
 Connectors accommodating conductors 600 kcmil and larger have double row of set screws (D suffix).

Type ADR-ALCÜL™ — Four Conductors, Four-Hole Mount*

- For copper and aluminum conductors
- Easy installation – no special tools required
- Tin-plated for low contact resistance
- All aluminum bodies

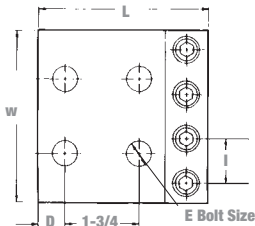

Cat. No.	Fig. No.	Conductor Range		Dimensions (in.)							
		Max.	Min.	L	W	H	D	E	F	G	I
ADR25-44	1	250 kcmil	6 str.	4	4-1/16	1-3/16	5/8	1/2	5/16	3	1-3/64
ADR35-44		350 kcmil		4-1/4	4-23/32	1-3/8					1-7/32
ADR60-44D	600 kcmil	2 str.	5-5/16	5-5/8	1-1/2	3/8			3-1/16	1-7/16	
ADR80-44D	800 kcmil	350 kcmil	6-3/16	7-1/8	1-7/8	9/16	3-7/16	1-13/16			

* NEMA Spacing: 1-3/4 in. centers.
 Connectors accommodating conductors 600 kcmil and larger have double row of set screws (D suffix).

Dual-Rated Mechanical Connectors

Type ASR-ALCÜL™ — Splice Reducers with Solid Barrier Wire Stop

- For copper and aluminum conductors
- Easy installation – no special tools required
- Tin-plated for low contact resistance
- All aluminum bodies

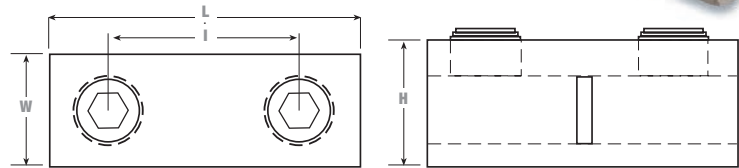

Cat. No.	Conductor Range (Al or Cu)		Dimensions (in.)			
	Max.	Min.	L	W	H	I
ASR0214*	2 str.	14 AWG	1-1/4	33/64	39/64	21/32
ASR1114*	1/0 str.		1-1/2	39/64	23/32	51/64
ASR2506	250 kcmil	6 str.	2-1/8	55/64	31/32	1-7/64
ASR3506	350 kcmil		2-3/8	1-1/32	1-1/8	1-1/4
ASR7525**	750 kcmil	250 kcmil	6-1/4	1-5/8	1-3/4	1-5/8

* Slotted screws.

** Two set screws per end. CSA not applicable.

Type BX-ALCÜL™ — Rectangular Connectors

- Recognized component in accordance with UL standard – 90°C rating
- Anti-rotational boss
- For copper and aluminum conductors
- Easy installation – no special tools required
- Tin-plated for low contact resistance
- All aluminum bodies



Cat. No.	Conductor Range		Style & Size of Boss	Boss Hole Tapped	Dimensions (in.)		
	Max.	Min.			L	W	H
BX0214	2	14 Cu 12 Al	Square 0.229 in.	10-32	15/32	15/32	9/16
BX1114	1/0				5/8	17/32	39/64

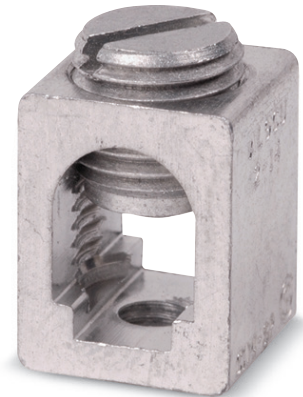
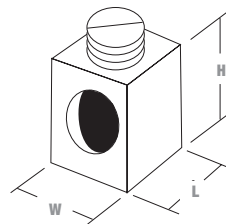

Tightening Torque Values for Aluminum Dual-Rated Socket Screw Connectors

AWG or Circular Mil Size	Tightening Torque (in.-lb.)		AWG or Circular Mil Size	Tightening Torque (in.-lb.)		
	Screwdriver	Wrench		Screwdriver	Wrench	
12	20	75	4/0	-	200	
10			250			
8			350			
6	35	100	500			300
4			600			
2			700			
1	50	125	750	-	400	
1/0			800			
2/0			1000			
3/0	-	200	-	-	-	