

Full range of small dimension fast-acting and time-delay fuses



- 5x15mm
- 5x20mm IEC
- 5x20mm UL
- 1/4" x 5/8"
- 1/4" x 7/8"
- 1/4" x 1"
- 1/4" x 1-1/4"

PLUS
PCB fuse holders
and clips

Contents

Description		Section page
Product	Catalog symbol/type	
Fuses		
5x15mm fuses	C515, C519 time-delay	2
	C518, C520 fast-acting	
	C517 fast acting	3
IEC 5x20mm fuses	GDB, S500, S500-V fast-acting	4
	GDA, S501, S501-V fast-acting	
	S505, S506SC time-delay	5
UL 5x20mm fuses	GDC, S505H, S505H-V, S505SCH, S506 S506-V time-delay	6
	GMA, GMA-V fast-acting	
	GMC, GMC-V time-delay	7
1/4" x 5/8" fuse	AGA fast-acting	8
1/4" x 7/8" fuse	AGW fast-acting	
1/4" x 1" fuse	AGX fast acting	
1/4" x 1-1/4" fuses	ACG, AGC-V, ABC, ABC-V fast-acting	9
	GBB, GBB-V fast-acting	10
	MDL, MDL-V time-delay	
	MDQ, MDQ-V, MDA, MDA-V time-delay	11
PCB holders and fuseclips		
5x20mm holders	H15-V, H15-H, HTC-60M	12
1/4" x 1-1/4" holders	HBH-I, HBH-M, HBV-I, HBV-M, HBW-I, HBW-M	13
5mm fuseclips	HTC-15M, HTC-140M, HTC-200M, HTC-210M, 1A3399, 1A5018, 1A5601, 1A5602	14
1/4" fuseclips	1A1119, 1A1120, 1A1907, 1A3398, 1A4533, 1A4534	15
	5681, 5682	
9/32" fuseclips	5672, 5674	16
13/32" fuseclips	5956 5960 1A3400	
9/16" fuseclips	5591 5592	

Electronic, PCB, small dimension fuses

For blocks and holders, see the following pages in Section 8

Fuse diameter	Pages
Panel mount blocks	
1/4" fuses	4-5
Through panel holders	
5mm fuses	41-42
1/4" fuses	43-45
In-line holders	
5mm fuses	48
1/4" fuses	48-50

C519 ferrule and C515 axial lead time-delay 5x15mm glass tube fuses

Ratings

- Volts
 - 125 Vac (3.5-7 A)
 - 250 Vac (125mA-3 A)
 - 32 Vdc (self certified)
- Amps 125mA-7 A
- IR
 - 25 A (350mA @ 600 Vac)
 - 35 A (125mA-1A @ 250 Vac)
 - 100 A (1.25-3 A @ 250 Vac)
 - 400 A (3.5-7 A @ 125 Vac)
 - 10 kA (125mA-3 A @ 125 Vac)



Agency information

- UL Listed, Guide JDYX, File E19180 125mA-250mA and 375mA-3 A, UL Recognized, Guide JDYX2, File E19180, 350mA and 3.5-7 A, CSA Certified, Class 1422-01, File 53787 125mA-250mA and 375mA-3 A, RoHS compliant, CE

Features

- Time-delay for closer sizing on inductive circuits

Typical application

- Electronic circuits
- Printed circuit boards

C520 ferrule and C518 axial lead fast-acting 5x15mm glass tube fuses

Ratings

- Volts
 - 250 Vac
 - 32 Vdc (self certified)
- Amps 100mA-5 A
- IR
 - 35 A (100mA-750mA @ 250 Vac)
 - 10 kA (100mA-5 A @ 125 Vac)
 - 100 A (1.5-3.5 A @ 250 Vac)
 - 200 A (4-5 A @ 250 Vac)

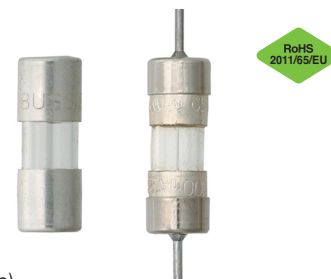

Agency information

- UL Recognized, Guide JDYX2, File E19180, CSA Certified, Class 1422-01, File 53787, RoHS compliant, CE

Features

- Small footprint saves space in equipment
- Fast-acting for maximum component protection
- Available in ferrule and axial lead configurations

Typical applications

- Electronic circuits
- Printed circuit boards

Catalog no. (amps)			
Ferrule			
C520-100-R	C520-500-R	C520-2.5-R	C520-5-R
C520-125-R	C520-750-R	C520-3-R	
C520-250-R	C520-1.5-R	C520-3.5-R	
C520-375-R	C520-2-R	C520-4-R	
Axial lead			
C518-100-R	C518-375-R	C518-2-R	C518-3.5-R
C518-125-R	C518-500-R	C518-2.5-R	C518-4-R
C518-250-R	C518-750-R	C518-3-R	C518-5-R

Catalog no. (amps)			
Ferrule			
C519-125-R	C519-600-R	C519-1.6-R	C519-3.5-R
C519-250-R	C519-750-R	C519-2-R	C519-4-R
C519-350-R	C519-1-R	C519-2.25-R	C519-5-R
C519-375-R	C519-1.25-R	C519-2.5-R	
C519-500-R	C519-1.5-R	C519-3-R	
Axial lead			
C515-125-R	C515-750-R	C515-2-R	C515-5-R
C515-250-R	C515-800-R	C515-2.25-R	C515-6-R
C515-350-R	C515-1-R	C515-2.5-R	C515-7-R
C515-375-R	C515-1.25-R	C515-3-R	
C515-500-R	C515-1.5-R	C515-3.5-R	
C515-600-R	C515-1.6-R	C515-4-R	

C517 axial lead fast-acting 5x15mm glass tube fuse

Ratings

- Volts
 - 350 Vac
 - 32 Vdc (self certified)
 - Amps 3 A
 - IR
 - 100 A @ 350 Vac*
 - 100 A @ 250 Vac
 - 10 kA @ 125 Vac
- * 350 Vac/100 A IR is UL Recognized.



Agency information

- UL Listed, Guide JDYX, File E19180, CSA Certified, Class 1422-01, File 53787, UL Recognized, Guide JDYX2, File E19180, RoHS compliant, CE

Features

- Small footprint saves space in equipment
- Fast-acting for maximum component protection
- 350 Vac rating for 277 V ballast circuit protection

Typical applications

- Electronic circuits
- Printed circuit boards
- Electronic ballast protection

To order, use catalog number **C517-3-R**

S500 ferrule (GDB†) and S500-V axial lead fast-acting, low breaking capacity 5x20mm glass tube fuses

Ratings

- Volts
 - 250 Vac (or less)
 - 32 Vdc (self certified)
- Amps 32mA-10 A
- IR
 - 35 A (32mA-3.15 A)
 - 40 A (4 A)
 - 63 A (6.3 A)
 - 80 A (8 A)
 - 100 A (10 A)



Agency information

- cURus, SEMKO, VDE, BSI, IMQ, CCC, RoHS compliant, CE
- Agency information not applicable to all ratings; see data sheet for details.

Features

- Fast-acting for maximum protection, conforms to IEC 60127-2 (160mA-10 A)

Typical applications

- Electronic circuits

Catalog no. (amps)*			
S500-32-R	S500-160-R	S500-800-R	S500-4-R
S500-40-R	S500-200-R	S500-1-R	S500-5-R
S500-50-R	S500-250-R	S500-1.25-R	S500-6.3-R
S500-63-R	S500-315-R	S500-1.6-R	S500-8-R
S500-80-R	S500-400-R	S500-2-R	S500-10-R
S500-100-R	S500-500-R	S500-2.5-R	
S500-125-R	S500-630-R	S500-3.15-R	

* GDB is not available with axial leads. To order axial leads, place "V" in the S500 catalog number. E.g., S500-V-32-R.

† When ordering GDB versions, do not add "-R" suffix to catalog number.

Electronic, PCB, small dimension fuses

S501 ferrule (GDA†) and S501-V Axial lead fast-acting high breaking capacity 5x20mm ceramic tube fuses

Ratings

- Volts
 - 250 Vac (or less)
 - 32 Vdc (self certified)
- Amps 50mA-10 A**
- IR 1500 A @ 250 Vac

Agency information

- cURus, SEMKO, VDE, IMQ, CCC, CSA, BSI, MITI/JET, RoHS compliant, CE
- Agency information not applicable to all ratings, see data sheet for details.

Features

- Fast-acting for maximum protection
- High break capacity for use in higher fault energy electronic circuitry
- Conforms to IEC standards

Typical applications

- Electronic circuits

Catalog no. (amps)*

S501-50-R	S501-200-R	S501-800-R	S501-3.15-R
S501-63-R	S501-250-R	S501-1-R	S501-4-R
S501-80-R	S501-315-R	S501-1.25-R	S501-5-R
S501-100-R	S501-400-R	S501-1.6-R	S501-6.3-R
S501-125-R	S501-500-R	S501-2-R	S501-8-R
S501-160-R	S501-630-R	S501-2.5-R	S501-10-R

* GDA is not available with axial leads. To order axial leads, place "V" in the S501 catalog number. E.g., S501-V-125-R.

† When ordering GDA version, do not add "-R" suffix to catalog number, GDA is not available above 6.3 A.



S505 ferrule, and S505SC axial lead time-delay, high-breaking capacity 5x20mm ceramic tube fuses

Ratings

- Volts
 - 250 Vac (or less)
 - 32 Vdc (self certified)
- Amps 500mA-12 A
- IR 1500 A @ 250 Vac

Agency information

- cURus, CSA, IMQ, VDE, SEMKO, CCC/CQC, PSE/JET, KC, BS, RoHS compliant
- Agency information not applicable to all ratings, see data sheet for details.

Features

- Time-delay performance ideal for inductive circuits.
- Conforms to IEC standards.

Typical applications

- Electronic circuits



Catalog no. (amps)*

S505-500-R**	S505-1.6-R	S505-4-R	S505-10-R
S505-800-R**	S505-2-R	S505-5-R	S505-12-R**
S505-1-R	S505-2.5-R	S505-6.3-R	
S505-1.25-R	S505-3.15-R	S505-8-R	

* To order axial leads, place "SC" in catalog number. E.g., S505SC-2-R.

**Axial leads not available.

S505H ferrule, and S505H-V and S505SCH axial time-delay high breaking capacity 5x20mm ceramic tube fuses

Ratings

- Volts
 - 600 Vac/400 Vdc (S505H 500mA-5 A)
 - 500 Vac/400 Vdc (S505H 6.3-10 A)
 - 250 Vac (S505SCH)
- Amps
 - 500mA-10 A (S505H)
 - 3.15-6.3 A (S505SCH)
- IR @ 250 Vac
 - 35 A (S505H)
 - 1.5 kA (S505SCH / 50 Hz / 250 Vac / 400 Vdc)
 - 100 A max AC



Agency information

- cURus, CCC, CQC, TUV, PSE/JET (S505H)
- cURus, KC, CQC, TUV (S505SCH)
- RoHS compliant
- Agency information not applicable to all ratings; see data sheets for details.

Features

- Time-delay, high breaking capacity
- Conforms to IEC standards

Typical applications

- Power supplies/adapters
- Desktops/notebooks

Catalog no. (amps)

S505H*

S505H-500-R	S505H-1.6-R	S505H-4-R	S505H-10-R
S505H-800-R	S505H-2-R	S505H-5-R	
S505H-1-R	S505H-2.5-R	S505H-6.3-R	
S505H-1.25-R	S505H-3.15-R	S505H-8-R	

S505SCH (axial lead only)

S505SCH-3.15-R	S505SCH-5-R	S505SCH-6.3-R
----------------	-------------	---------------

* To order an axial lead S505H fuse, place "V" in catalog number. E.g., S505H-V-5-R.

S506 ferrule (GDC†) and S506-V axial lead time-delay low breaking capacity 5x20mm glass tube fuses

Ratings

- Volts
 - 250 Vac (or less)
 - 32 Vdc (self certified)
- Amps 32mA-15 A**
- IR 35 A @ 250 Vac



Agency information

- UR, CSA, cURus, SEMKO, VDE, BSI, IMQ, VDE, PSE/JET, CCC, RoHS compliant
- Agency information not applicable to all ratings; see data sheet for details.

Features

- Time-delay for inductive circuits
- Conforms to IEC standards

Typical applications

- Electronic circuits

Catalog no. (amps)*

S506-32-R	S506-160-R	S506-800-R	S506-4-R
S506-40-R	S506-200-R	S506-1-R	S506-5-R
S506-50-R	S506-250-R	S506-1.25-R	S506-6.3-R
S506-63-R	S506-315-R	S506-1.6-R	S506-8-R
S506-80-R	S506-400-R	S506-2-R	S506-10-R
S506-100-R	S506-500-R	S506-2.5-R	S506-12.5-R
S506-125-R	S506-630-R	S506-3.15-R	S506-15-R

* GDC is not available with axial leads. To order axial leads, place "V" in the S506 catalog number. E.g., S506-V-15-R.

† When ordering GDC version, do not add "-R" suffix to catalog number., GDC fuses are not available above 6.3 A.

Electronic, PCB, small dimension fuses

GMA ferrule and GMA-V axial leads fast-acting 5x20mm glass tube fuses

Ratings

- Volts
 - 250 Vac (63mA-2.5 A)
 - 125 Vac (3.15-15 A)
 - 32 Vdc (self certified)
- Amps 63mA-15 A
- IR
 - 35 A (63mA-1 A @ 250 Vac, p.f. = 0.7-0.8)
 - 10 kA (63mA-6 A @ 125 Vac, p.f. = 0.7-0.8)
 - 100 A (1.25-2.5 A @ 250 Vac, p.f. = 0.7-0.8)
 - 200 A (7-8 A @ 125 Vac, p.f. = 1.0)
 - 150 A (10-15 A @ 125 Vac, p.f. = 1.0)



Agency information

- UL Listed, Std. 248-14 Guide JDYX, File E19180 up to 6 A, UL Recognized, Guide JDYX2, File E19180, 7-15 A, CSA Certified, Class 1422-01, File 53787 up to 6 A, PSE Approval 1-15 A, RoHS compliant, CE

Features

- Fast-acting for maximum protection

Typical applications

- Electronic circuits

Catalog no. (amps)*

GMA-63-R	GMA-600-R	GMA-2-R	GMA-7-R
GMA-100-R	GMA-750-R	GMA-2.5-R	GMA-8-R
GMA-125-R	GMA-800-R	GMA-3.15-R	GMA-10-R
GMA-200-R	GMA-1-R	GMA-3.5-R	GMA-15-R
GMA-250-R	GMA-1.25-R	GMA-4-R	
GMA-300-R	GMA-1.5-R	GMA-5-R	
GMA-500-R	GMA-1.6-R	GMA-6-R	

* To order axial leads, place "V" in catalog number. E.g., GMA-V-8-R.

GMC ferrule and GMC-V axial lead medium time-delay 5x20mm glass tube fuses

Ratings

- Volts
 - 250 Vac (63mA-3.15 A)
 - 125 Vac (3.5-10 A)
 - 32 Vdc (self certified)
- Amps 63mA-10 A
- IR
 - 35 A (63mA-1 A @ 250 Vac, p.f. = 0.7-0.8)
 - 10 kA (63mA-6 A @ 125 Vac, p.f. = 0.7-0.8)
 - 100 A (1.25-3.15 A @ 250 Vac, p.f. = 0.7-0.8)
 - 200 A (6.3-10 A @ 125 Vac, p.f. = 1.0)



Agency information

- UL Listed, Std. 248-14, Guide JDYX, File E19180 up to 6.3 A, UL Recognized, Guide JDYX2, File E19180 7-10 A, CSA Certified, Class 1422-01, File 53787 up to 6.3 A, MITI Approval, 1-10 A, KC, RoHS compliant, CE
- KC not applicable to all ratings; see data sheet for details

Features

- Conforms to UL standards

Typical applications

- Electronic circuits

Catalog no. (amps)*

GMC-63-R	GMC-315-R	GMC-1.25-R	GMC-5-R
GMC-80-R	GMC-400-R	GMC-1.5-R	GMC-6-R
GMC-100-R	GMC-500-R	GMC-1.6-R	GMC-6.3-R
GMC-125-R	GMC-600-R	GMC-2-R	GMC-7-R
GMC-150-R	GMC-630-R	GMC-2.5-R	GMC-8-R
GMC-200-R	GMC-750-R	GMC-3.15-R	GMC-10-R
GMC-250-R	GMC-800-R	GMC-3.5-R	
GMC-300-R	GMC-1-R	GMC-4-R	

* To order axial leads, place "V" in catalog number. E.g., GMC-V-5-R.

GMD ferrule and GMD-V axial leads time-delay 5x20mm glass tube fuses

Ratings

- Volts
 - 250 Vac
 - 32 Vdc (self certified)
- Amps 125mA-4 A
- IR
 - 10 kA (125mA-3 A @ 125 Vac, p.f. = 0.7-0.8)
 - 10 kA (4 A @ 125 Vac, p.f. = 1.0)
 - 35 A (125mA-1 A @ 250 Vac, p.f. = 0.7-0.8)
 - 100 A (1.2-3. A @ 250 Vac, p.f. = 0.7-0.8)
 - 200 A (4 A @ 250 Vac, p.f. = 1.0)



Agency information

- UL Listed Guide JDYX, File E19180, UL Recognized Card (4 A), Guide JDYX2, File E19180, 4 A, CSA Certified, Class 1422-01, File 53787, PSE/JET, File 1641-31003-1001, RoHS complaint, CE
- Agency information not applicable to all ratings; see data sheet for details

Features

- Time-delay for inductive circuits
- Conforms to UL standards

Typical applications

- Electronic circuits

Catalog no. (amps)*			
GMD-125-R	GMD-375-R	GMD-800-R	GMD-2-R
GMD-150-R	GMD-400-R	GMD-1-R	GMD-2.5-R
GMD-200-R	GMD-500-R	GMD-1.2-R	GMD-3-R
GMD-250-R	GMD-600-R	GMD-1.25-R	GMD-4-R
GMD-300-R	GMD-630-R	GMD-1.5-R	
GMD-315-R	GMD-750-R	GMD-1.6-R	

* To order axial leads, place "V" in catalog number. E.g., GMD-V-2.5-R.

AGA fast-acting 1/4" x 5/8" glass tube fuse

Ratings

- Volts
 - 125 Vac (or less)
 - 32 Vdc (self certified)
- Amps 1-30 A
- IR
 - 10 kA (1 to 1-1/2 A @ 125 Vac)
 - 200 A (2-5 A @ 125 Vac)
 - 1000 A (6-30 A @ 32 Vac)



Agency information

- UL Listed, Std. 248-14, Guide JDYX, File E19180 up to 3-1/2 A UL Recognized, Guide JDYX2 12-30 A, CE

Features

- Fast-acting for maximum protection
- Size rejects insertion of other fuse types

Typical applications

- Electronic circuits

Catalog no. (amps)			
AGA-1	AGA-3	AGA-7-1/2	AGA-25
AGA-1-1/2	AGA-5	AGA-10	AGA-30
AGA-2	AGA-6	AGA-15	
AGA-2-1/2	AGA-7	AGA-20	

Electronic, PCB, small dimension fuses

AGW fast-acting 1/4" x 7/8" glass tube fuse

Ratings

- Volts
 - 32 Vac
 - 32 Vdc (self certified)
- Amps 1-30 A
- IR 1 kA AC



Features

- Fast-acting for maximum protection

Typical applications

- Electronic circuits

Catalog no. (amps)

AGW-1	AGW-3	AGW-7-1/2	AGW-25
AGW-1-1/2	AGW-4	AGW-10	AGW-30
AGW-2	AGW-5	AGW-15	
AGW-2-1/2	AGW-6	AGW-20	

AGX fast-acting 1/4" x 1" glass tube fuse

Ratings

- Volts
 - 250 Vac (1/4-20 A)
 - 125 Vac (25-30 A)
 - 32 Vdc (1/4-30 A)
- Amps 1/4-30 A
- IR
 - 35 A (1/4-1 A @ 250 Vac)
 - 10 kA (1/4-10 A @ 125 Vac)
 - 200 A (15-20 A @ 125 Vac)
 - 100 A (25-30 A @ 125 Vac)
 - 1000 A (8-30 A @ 32 Vac)



Agency information

- cULus up to 10 A, Guide JDYX, File E 19180 and Guide JDYX7, File E19180, UL Recognized Card 15-30 A Guide JDYX2, File E19180, CSA Component Acceptance Card 15-30 A Class No. 1422-01, File 53787

Features

- Size rejects insertion of other fuse types

Typical applications

- Electronic circuits

Catalog no. (amps)

AGX-1/4	AGX-1	AGX-4	AGX-15
AGX-3/10	AGX-1-1/4	AGX-5	AGX-20
AGX-3/8	AGX-1-1/2	AGX-6	AGX-25
AGX-4/10	AGX-2	AGX-7	AGX-30
AGX-1/2	AGX-2-1/2	AGX-8	
AGX-3/4	AGX-3	AGX-10	

AGC ferrule and AGC-V axial lead fast-acting 1/4" x 1-1/4" glass tube fuses

Ratings

- Volts
 - 250 Vac (1/20-10 A)
 - 32 Vac (12-40 A)
 - 32 Vdc (self certified)
- Amps 1/20-40 A
- IR
 - 35 A (1/20-1 A @ 250 Vac)
 - 100 A (11/4-3 A @ 250 Vac)
 - 200 A (4-10 A @ 250 Vac)
 - 10 kA (1/20-10 A @ 125 Vac)
 - 1000 A (12-40 A @ 32 Vac)



Agency information

- UL Listed, Guide JDYX, File E19180, up to 10 A, UL Recognized, Guide JDYX2, File E19180, 12-30 A, CSA Certified, Class 1422-01, CSA Component Acceptance Card, Class No. 1422-30, RoHS compliant, CE

Features

- Original electronic glass tube fuse
- Fast-acting for maximum protection
- Wide amp/volt ratings allow versatility of protecting electronic circuits

Typical applications

- Electronic circuits

Catalog no. (amps)*

AGC-1/20-R	AGC-3/4-R	AGC-5-R	AGC-15-R
AGC-1/10-R	AGC-1-R	AGC-6-R	AGC-20-R
AGC-1/8-R	AGC-1-1/4-R	AGC-7-R	AGC-25-R
AGC-3/16-R	AGC-1-1/2-R	AGC-7-1/2-R	AGC-30-R
AGC-2/10-R	AGC-2-R	AGC-8-R	AGC-35-R
AGC-1/4-R	AGC-2-1/4-R	AGC-9-R	AGC-40-R
AGC-3/10-R	AGC-2-1/2-R	AGC-10-R	
AGC-3/8-R	AGC-3-R	AGC-12-R	
AGC-1/2-R	AGC-4-R	AGC-14-R	

* To order axial leads, place "V" in catalog number. E.g., AGC-V-1/10-R.

ABC ferrule and ABC-V axial leads fast-acting 1/4" x 1-1/4" ceramic tube fuse

Ratings

- Volts
 - 250 Vac/125 Vdc (1/4-15 A, 20-30 A)*
 - 250 Vac (18 A)
 - 32 Vdc (self certified)
- Amps 1/4-30 A
- IR**
 - 35 A (1/4-1 A @ 250 Vac)
 - 100 A (11/2-3 A @ 250 Vac)
 - 200 A (4-10 A @ 250 Vac)
 - 750 A (12-15 A @ 250 Vac)
 - 400 A (18-20 A @ 250 Vac)
 - 10 kA (1/4-15 A @ 125 Vac)
 - 1 kA (18-30 A @ 125 Vac)
 - 10 kA (1/4-15, 20 A @ 125 Vdc)
 - 400 A (25-30 A @ 125 Vdc)
 - 200 A (25-30 A @ 250 Vac)



* CSA approvals for 25 A and 30 A are at 125 Vac – IR 1000 A and Vdc – IR 400 A (IR 1000 A at 75 Vdc)

** Interrupting ratings measured at 70% – 80% power factor on AC. The interrupting ratings for 18 A and 20 A were measured at 85%-95% power factor on AC. The interrupting ratings for 25 A and 30 A were measured at 89% power factor on AC.

Agency information

- UL Listed, Std. 248-14, Guide JDYX File E19180 up to 15 A; UL Recognized, Guide JDYX2, File E19180, 18-30 A; CSA Certified, Class 1422-01 and 1422-30, File 53787, RoHS compliant, CE

Features

- Ceramic body allows for higher amp/volt rating combinations

Typical applications

- Electronic circuits

Catalog no. (amps)

ABC-1/4-R	ABC-2-R	ABC-6-R	ABC-15-R
ABC-1/2-R	ABC-2-1/2-R	ABC-7-R	ABC-18-R
ABC-3/4-R	ABC-3-R	ABC-8-R	ABC-20-R
ABC-1-R	ABC-4-R	ABC-10-R	ABC-25-R
ABC-1-1/2-R	ABC-5-R	ABC-12-R	ABC-30-R

* To order axial leads, place "V" in catalog number. E.g., ABC-V-7-R.

Electronic, PCB, small dimension fuses

GBB ferrule and GBB-V axial lead very-fast-acting 1/4" x 1-1/4" ceramic tube fuses

Ratings

- Volts 250 Vac/125 Vdc
- Amps 1-30 A
- IR
 - 200 A @ 250 Vac
 - 200 A (20-30 A @ 125 Vac/dc)
 - 10 kA (1-15 A @ 125 Vac/dc)



Agency information

- UL Recognized, Std. 248-14, Guide JFHR2, File E56412, CSA Component Acceptance Class 1422-30, File 53787, RoHS complaint, CE

Features

- Very fast-acting performance allows protection of highly sensitive electronic circuitry

Typical applications

- Electronic circuits

Catalog no. (amps)*

GBB-1-R	GBB-4-R	GBB-8-R	GBB-15-R
GBB-1-1/4-R	GBB-5-R	GBB-9-R	GBB-20-R
GBB-2-R	GBB-6-R	GBB-10-R	GBB-25-R
GBB-3-R	GBB-7-R	GBB-12-R	GBB-30-R

* To order axial leads, place "V" in catalog number. E.g., GBB-V-10-R.

MDL ferrule and MDL-V axial lead time-delay 1/4" x 1-1/4" glass tube fuses

Ratings

- Volts
 - 250 Vac (1/16-8 A)
 - 32 Vac (9-30 A)
 - 32 Vdc (self certified)
- Amps 1/16-30 A
- IR*
 - 35 A (1/16-1 A @ 250 Vac)
 - 100 A (11/4-3 A @ 250 Vac)
 - 200 A (4-8 A @ 250 Vac)
 - 10000 A (1/16-8 A @ 125 Vac)
 - 1000 A (9-30 A @ 32 Vac)



* Interrupting ratings were measured at 70% – 80% power factor on AC, and at a time constant described in UL 198L.

Agency information

- UL Listed, Guide JDYX, File E19180 up to 8 A; CSA Certified Class 1422-01 up to 8 A; UL Recognized, Guide JDYX2, File E19180, 9-30 A; CSA Component Acceptance, Class 1422-30, 9-30 A, RoHS compliant, CE

Features

- Time-delay allows close sizing on inductive circuits

Typical applications

- Electronic circuits

Catalog no. (amps)*

MDL-1/16-R	MDL-1/2-R	MDL-3-R	MDL-10-R
MDL-1/10-R	MDL-3/4-R	MDL-3-2/10-R	MDL-12-R
MDL-1/8-R	MDL-1-R	MDL-4-R	MDL-15-R
MDL-2/10-R	MDL-1-1/4-R	MDL-5-R	MDL-20-R
MDL-3/16-R	MDL-1-1/2-R	MDL-6-R	MDL-25**
MDL-1/4-R	MDL-2-R	MDL-7-R	MDL-30**
MDL-3/10-R	MDL-2-1/4-R	MDL-8-R	
MDL-3/8-R	MDL-2-1/2-R	MDL-9-R	

* To order axial leads, place "V" in catalog number. E.g., MDL-V-3-R.
 **RoHS compliant construction not available.

MDQ ferrule and MDQ-V axial lead dual-element, time-delay 1/4" x 1-1/4" glass tube fuses

Ratings

- Volts
 - 250 Vac (1/100-7 A)
 - 32 Vac (7-1/2 to 15 A)
 - 32 Vdc (self certified)
- Amps 1/100-15 A
- IR
 - 35 A (1/100-1 A @ 250 Vac)
 - 100 A (1-1/4 to 3 A @ 250 Vac)
 - 200 A (4-7 A @ 250 Vac)
 - 1000 A (7-1/2 to 12 A @ 32 Vac)

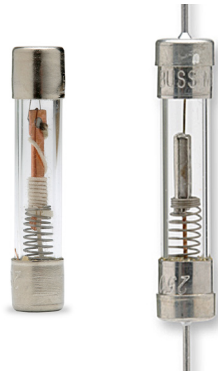

Agency information

- UL Listed, Std. 248-14, Guide JDYX, File E19180 1/16-7 A, CSA Component Acceptance, Class 1422-01, File 47233 1/16 -15 A, UL Recognized, Guide JDYX2, File E19180, 7-1/2-15 A.

Features

- Dual-element design allows closer sizing to inductive circuits than any other fuses

Typical applications

- Electronic relay and control circuits

Catalog no. (amps)*

MDQ-1/100	MDQ-3/10	MDQ-1-1/2	MDQ-5
MDQ-1/32	MDQ-3/8	MDQ-1-6/10	MDQ-6
MDQ-1/16	MDQ-4/10	MDQ-1-8/10	MDQ-6-1/4
MDQ-1/10	MDQ-1/2	MDQ-2	MDQ-7
MDQ-1/8	MDQ-6/10	MDQ-2-1/4	MDQ-7-1/2
MDQ-15/100	MDQ-3/4	MDQ-2-1/2	MDQ-8
MDQ-175/1000	MDQ-8/10	MDQ-2-8/10	MDQ-9
MDQ-3/16	MDQ-1	MDQ-3	MDQ-10
MDQ-2/10	MDQ-1-2/10	MDQ-3-2/10	MDQ-12
MDQ-1/4	MDQ-1-1/4	MDQ-4	MDQ-15

* To order axial leads, place "V" in catalog number. E.g., MDQ-V-1-1/4.

MDA ferrule and MDA-V axial lead time-delay 1/4" x 1-1/4" ceramic tube fuses

Ratings

- Volts
 - 250 Vac (or less)
 - 125 Vdc (20-30 A)
 - 32 Vdc (self certified)
- Amps 1/4-30 A
- IR**
 - 35 A (1/4 to 1 A @ 250 Vac)
 - 100 A (1-1/2 to 2 A @ 250 Vac)
 - 200 A (2-1/2 to 10 A @ 250 Vac)
 - 750 A (12-15 A @ 250 Vac)
 - 1500 A (20-30 A @ 250 Vac)
 - 10 kA (1/4-30 A @ 125 Vac)
 - 10 kA (20-30 A @ 125 Vdc)



**Interrupting ratings were measured at 70% – 80% power factor on AC, and at a time constant described in UL 248.

Agency information

- UL Listed, Std. 248-14, Guide JDYX, File E19180 up to 20 A, CSA Certified, Class 1422-01, File 53787 up to 20 A. UL Recognized, Guide JDYX2, File E19180, 25-30 A, CSA Component Acceptance, Class 1422-30, 25-30 A, RoHS compliant, CE

Features

- Ceramic body for higher amp/volt ratings
- Inventory consolidation by replacing MDL fuses allows for reduced SKU investment and minimizing potential for misapplying fuse

Typical applications

- Electronic circuits

Catalog no. (amps)*

MDA-1/4-R	MDA-2-R	MDA-6-R	MDA-15-R
MDA-1/2-R	MDA-2-1/2-R	MDA-7-R	MDA-20-R
MDA-3/4-R	MDA-3-R	MDA-8-R	MDA-25 A-R
MDA-1-R	MDA-4-R	MDA-10-R	MDA-30 A-R
MDA-1-1/2-R	MDA-5-R	MDA-12-R	

* To order axial leads, place "V" in catalog number. E.g., MDA-V-1-1/2-R.

Electronic, PCB, small dimension fuses

H15-V vertical mount holder with threaded cap



Ratings

- Volts 250 Vac
- Amps 10 A (cURus and VDE)
- Temperature rise 41°C

Agency information

- cURus Recognized, Guide IZLT2/IZLT8, File E14853
- VDE File 40039714

Materials

- Tin-plated clip
- Tin-plated copper terminals
- Thermoplastic body (UL 94V0, glow wire test: 960°C per IEC 695-2-1)

Catalog no.	Carton qty.
BK-H15-V-1	200
BK1-H15-V-1	1000
BK-H15-V-1-B	100 holder body only
BK-H15-V-1-K	100 holder cap only

Dimensions - in (mm)

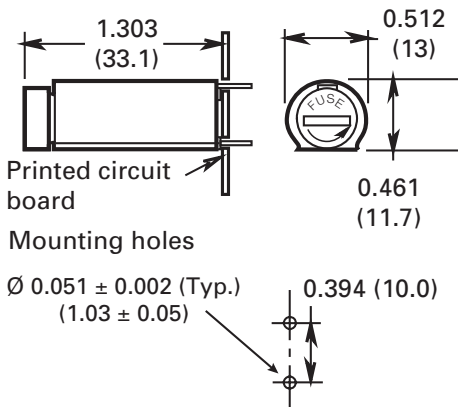

H15-H horizontal mount holder with threaded cap



Ratings

- Volts 250 Vac
- Amps 10 A (cURus) 6.3 A (VDE)
- Temperature rise 41°C

Agency information

- cURus Recognized, Guide IZLT2/IZLT8, File E14853
- VDE File 40039714

Materials

- Tin-plated clip
- Tin-plated copper terminals
- Thermoplastic body (UL 94V0, glow wire test: 960°C per IEC 695-2-1)

Catalog no.	Carton qty.
BK-H15-H-1	200
BK1-H15-H-1	1000
BK-H15-H-1-B	100 holder body only
BK-H15-H-1-K	100 holder cap only

Dimensions - in (mm)

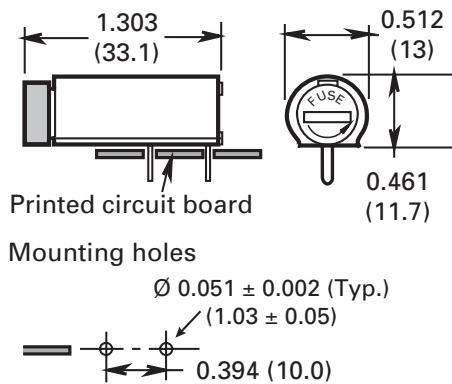

HTC-60M four-leg stand-off mount fuse holder



Ratings

- Volts 250 Vac
- Amps 6.3 (cURus and VDE)

Agency information

- cURus Recognized, Guide IZLT2/IZLT8, File E14853
- VDE File 4004459

Materials

- Tin-plated brass terminals

Catalog no.	Qty.
HTC-60M	10
BK-HTC-60M	100 (bulk)

Dimensions - in (mm)

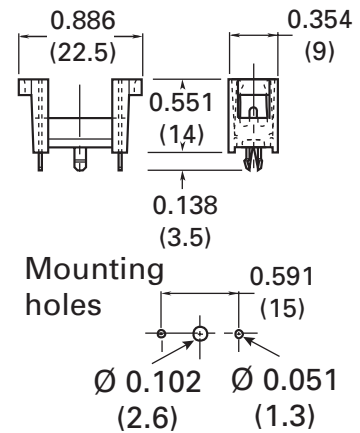

HBH-I (1/4" x 1-1/4") and HBH-M (5x20mm) horizontal mount fuse holders

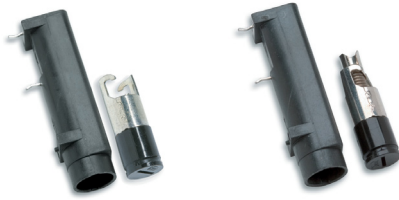

Dimensions - in (mm)

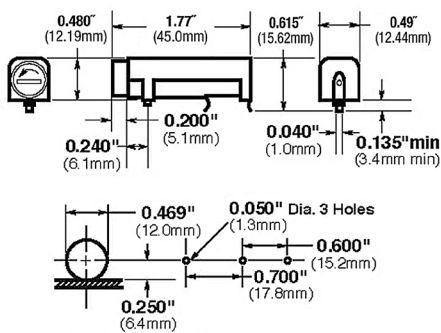

Ratings

- UL 16 A/250 V
- CSA 12 A/250 V
- VDE 6.3 A/250 V
- SEMKO 10 A/250 V

Agency information

- UL Recognized, Guide IZLT2, File E14853, CSA Certified, Class 6225-01, File 47235, VDE 4009241 (HBV, HBW), SEMKO 800444, CE

Electrical

- Insulation resistance 10 MΩ 500 Vdc
- Contact resistance less than 0.005 Ω @ 200mV
- Dielectric strength over 200 V/mil

HBV-I (1/4" x 1-1/4") and HBV-M (5x20mm) vertical mount fuse holders with stability pins



Dimensions - in (mm)

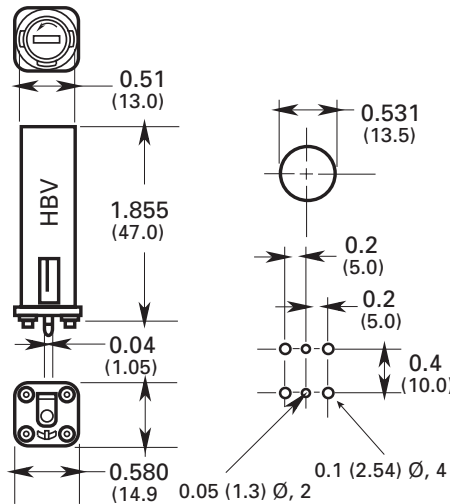

Material

- High dielectric molded phenolic with a UL 94V0 flammability rating
- Fuse carrier and knob: spring-loaded, bayonet-type, tin-plated brass with screwdriver slot

Mounting

- "Kicked" terminals (all) and stability pins on HBV and HBW
- Temperature rating (RTI): body 150°C, knob 130°C

HBW-I (1/4" x 1-1/4") and HBW-M (5x20mm) vertical mount fuse holder without stability pins



Dimensions - in (mm)

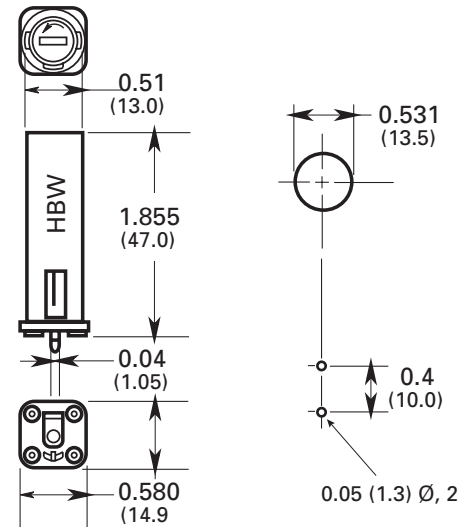

Replacement fuse caps

FBI and FBM fuse caps fit PCB fuse holders HBH-, HBV-, and HBW-.

To order, specify Catalog numbers:

- FBI for 1/4" diameter fuses
- FBM for 5mm diameter fuses



FBI



FBM

Electronic, PCB, small dimension fuses

HTC-15M, HTC-140M holder and snap-on cover

Ratings

- 250 V / 6.3 A / 1.6 W

Agency information

- cURus, Guide 1ZLT2 and 1ZLT8, File E14853
- VDE 40004458
- RoHS compliant

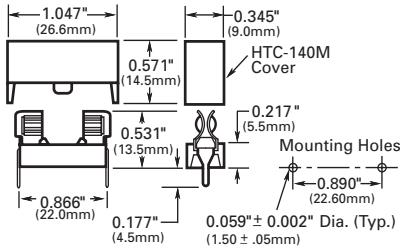

1A3399 low profile fuseclips with end stops and straight leads

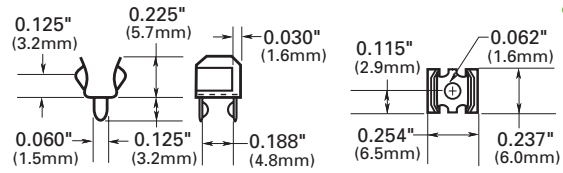

Catalog no.	Material*	Finish
1A3399-01	BeCu	Silver
1A3399-04-R	BeCu	Bright tin
1A3399-10-R	Spring bronze	Bright tin

* BeCu recommended for more than 15 A.

1A5018 high profile fuseclips with end stops and straight leads

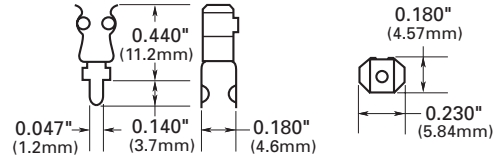

Catalog no.	Material*	Finish
1A5018-07	Spring bronze	Silver
1A5018-10-R	Spring bronze	Bright tin

* BeCu 1A3399 fuseclips recommended for more than 15 A.

HTC-200M fuseclip

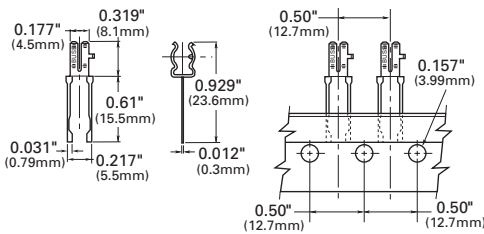

1A5601 fuseclip (≤ 7 A)

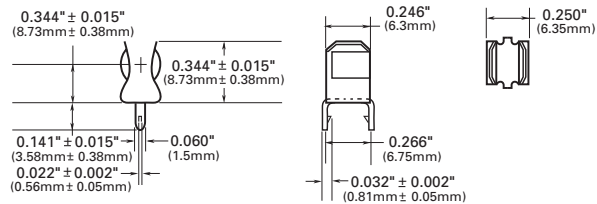

Catalog no.	Material	Finish
1A5601	Cartridge brass	Bright tin

HTC-210M fuseclip with end stops

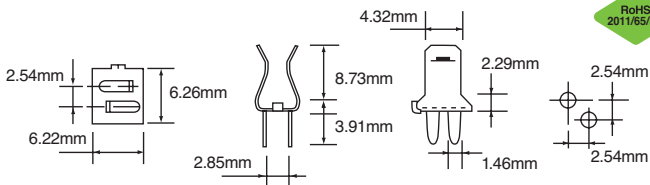

1A5602 fuseclip with end stops (≤ 7 A)

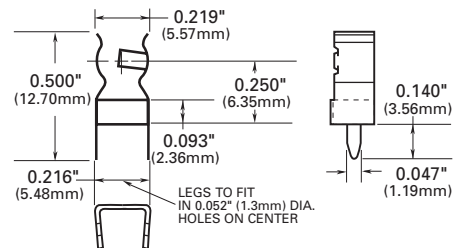

Catalog no.	Material	Finish
1A5602	Cartridge brass	Bright tin

Catalog no.	Material	Description
HTC-200M	Tin-plated bronze	Tape and fan fold pack
AP/HTC-200M		Ammo pack 1000 pieces per box

1A1119 fuseclips with end stops and angled-in leads

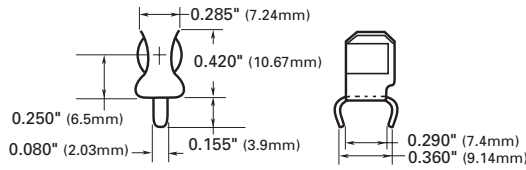

Catalog no.	Material*	Finish
1A1119-04-R	High performance copper	Bright tin
1A1119-05	High performance copper	Silver
1A1119-10-R	Cartridge brass	Bright tin

* High performance copper recommended for more than 15 A.

1A3398 PCB fuseclips without end stops with straight leads

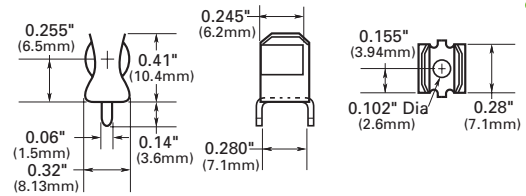

Catalog no.	Material	Finish
1A3398-07-R	Cartridge brass	Bright tin

1A1120 fuseclips without end stops or angled-in leads

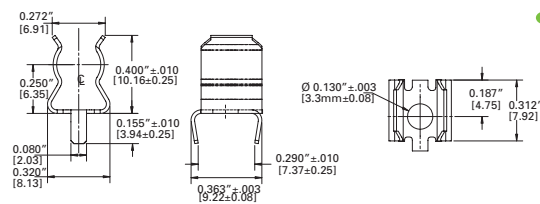

Catalog no.	Material*	Finish
1A1120-02	Cartridge brass	None/bright dipped
1A1120-05	High performance copper	Silver
1A1120-06-R	High performance copper	Bright tin
1A1120-09-R	Cartridge brass	Bright tin

* High performance copper recommended for more than 15 A.

1A4533 fuseclips without end stops or angled out leads

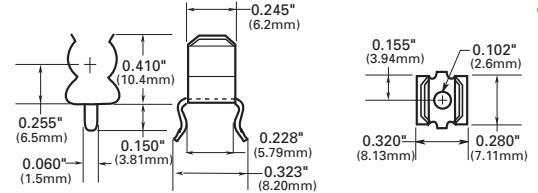

Catalog no.	Material*	Finish
1A4533-01-R	High performance copper	Bright tin
1A4533-06-R	Cartridge brass	Bright tin

* High performance copper recommended for more than 15 A.

1A1907 fuseclips with end stops and straight leads

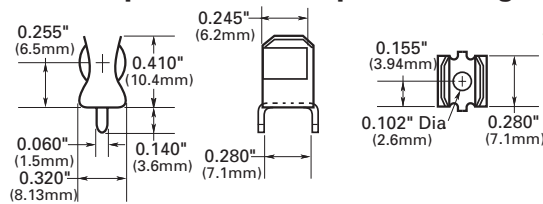

Catalog no.	Material*	Finish
1A1907-02	Cartridge brass	None/bright dipped
1A1907-03-R	High performance copper	Bright tin
1A1907-05	High performance copper	Silver
1A1907-06-R	Cartridge brass	Bright tin

* High performance copper recommended for more than 15 A.

1A4534 fuseclips with end stops and angled out leads

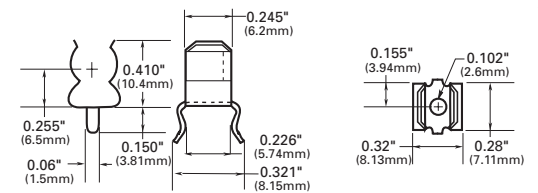

Catalog no.	Material*	Finish
1A4534-01-R	High performance copper	Bright tin
1A4534-06-R	Cartridge brass	Bright tin

* High performance copper recommended for more than 15 A.

Electronic, PCB, small dimension fuses

5681 and 5682 fuseclips with mounting holes for 1/4" diameter fuses

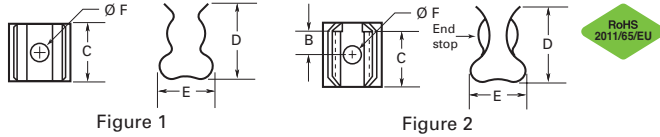

RoHS 2011/65/EU

Catalog no.	Clip mat.	Finish	Dimensions - in					Ref.
			B	C	D	E	Ø F	
Without end stop								
5681-01	BeCu	Silver						
5681-08	Spr. br.	Nickel	†	0.265	0.41	0.32	0.132	Fig. 1
5681-15-R		Bright tin						
With end stop								
5682-01	BeCu	Silver		0.108				
5682-02				0.131				
5682-11-R	BeCu	Bright tin	0.106	0.262	0.41	0.32	0.132	Fig. 2
5682-41-R	Spr. br.		0.106					
5682-44-R			0.132					

5956 and 5960 PCB fuseclips with mounting holes for 13/32" diameter fuses

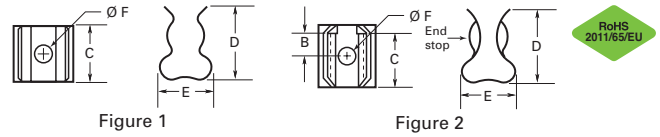

RoHS 2011/65/EU

Catalog no.	Clip mat.	Finish	Dimensions - in					Ref.
			B	C	D	E	Ø F	
Without end stop								
5956-16	Spr. br.	Bright tin	†	0.312	0.71	0.47	0.172	Fig. 1
With end stop								
5960-07	BeCu	Silver		0.168				0.196
5960-09				0.2				0.172
5960-44		Nickel					0.197	
5960-51		Bright dip*		0.168				0.196
5960-53			0.2	0.387	0.71	0.47	0.172	Fig. 2
5960-61-R	Spr. br.	Bright tin		0.168				0.196
5960-62-R				0.132				0.172
5960-63-R							0.172	
5960-64-R				0.2				0.128

* Treated bare metal with no plating.

5672 and 5674 PCB fuseclips with mounting holes for 9/32" diameter fuses

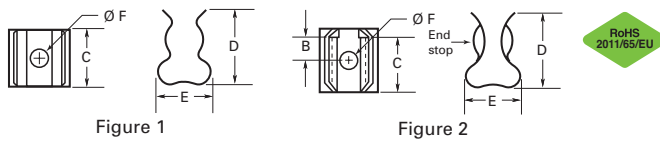

RoHS 2011/65/EU

Catalog no.	Clip mat.	Finish	Dimensions - in					Ref.
			B	C	D	E	Ø F	
Without end stop								
5672-11	Spr. br.	Bright tin	†	0.362	0.52	0.38	0.172	Fig. 1
With end stop								
5674-01	BeCu	Silver						
5674-10				0.168	0.356	0.52	0.38	0.172
5674-41	Spr. br.	Bright tin						

5591 and 5592 PCB fuseclips with mounting holes for 9/16" diameter fuses

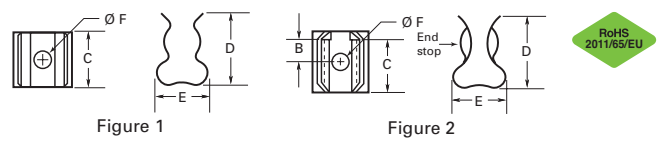

RoHS 2011/65/EU

Catalog no.	Clip mat.	Finish	Dimensions - in					Ref.
			B	C	D	E	Ø F	
Without end stop								
5592-01	BeCu	Silver	0.252	0.56	0.875	0.6	0.2	Fig. 1
With end stop								
5591-42	Spr. br.	Bright dip*	0.26	0.51	0.89	0.6	0.172	Fig. 2
5591-52-R		Bright tin						

* Treated bare metal with no plating.

1A3400 fuseclips with end stops and straight leads for 13/32" diameter fuses

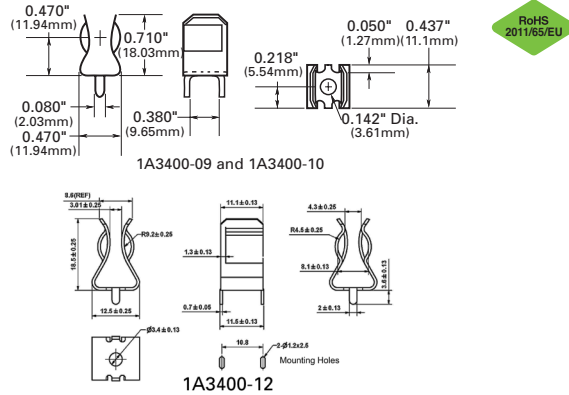

RoHS 2011/65/EU

Catalog no.	Clip mat.	Finish	Max amps
1A3400-09-R	Copper-clad steel	Bright tin	20
1A3400-10-R	Copper-clad steel	Silver	30
1A3400-12-R	Spr. br.	Bright tin	15

Full range of small dimension fast-acting and time-delay fuses



- 5x15mm
- 5x20mm IEC
- 5x20mm UL
- 1/4" x 5/8"
- 1/4" x 7/8"
- 1/4" x 1"
- 1/4" x 1-1/4"

PLUS
PCB fuse holders
and clips

Contents

Description		Section page
Product	Catalog symbol/type	
Fuses		
5x15mm fuses	C515, C519 time-delay	2
	C518, C520 fast-acting	
	C517 fast acting	3
IEC 5x20mm fuses	GDB, S500, S500-V fast-acting	4
	GDA, S501, S501-V fast-acting	
	S505, S506SC time-delay	5
UL 5x20mm fuses	GDC, S505H, S505H-V, S505SCH, S506 S506-V time-delay	6
	GMA, GMA-V fast-acting	
	GMC, GMC-V time-delay	7
1/4" x 5/8" fuse	GMD GMD-V time-delay	8
	AGA fast-acting	
	1/4" x 7/8" fuse	AGW fast-acting
1/4" x 1" fuse	AGX fast acting	10
	ACG, AGC-V, ABC, ABC-V fast-acting	
	1/4" x 1-1/4" fuses	GBB, GBB-V fast-acting
	MDL, MDL-V time-delay	11
	MDQ, MDQ-V, MDA, MDA-V time-delay	
	PCB holders and fuseclips	
5x20mm holders	H15-V, H15-H, HTC-60M	12
1/4" x 1-1/4" holders	HBH-I, HBH-M, HBV-I, HBV-M, HBW-I, HBW-M	13
5mm fuseclips	HTC-15M, HTC-140M, HTC-200M, HTC-210M, 1A3399, 1A5018, 1A5601, 1A5602	14
1/4" fuseclips	1A1119, 1A1120, 1A1907, 1A3398, 1A4533, 1A4534	15
	5681, 5682	
9/32" fuseclips	5672, 5674	16
13/32" fuseclips	5956 5960 1A3400	
9/16" fuseclips	5591 5592	

Electronic, PCB, small dimension fuses

For blocks and holders, see the following pages in Section 8

Fuse diameter	Pages
Panel mount blocks	
1/4" fuses	4-5
Through panel holders	
5mm fuses	41-42
1/4" fuses	43-45
In-line holders	
5mm fuses	48
1/4" fuses	48-50

C519 ferrule and C515 axial lead time-delay 5x15mm glass tube fuses

Ratings

- Volts
 - 125 Vac (3.5-7 A)
 - 250 Vac (125mA-3 A)
 - 32 Vdc (self certified)
- Amps 125mA-7 A
- IR
 - 25 A (350mA @ 600 Vac)
 - 35 A (125mA-1A @ 250 Vac)
 - 100 A (1.25-3 A @ 250 Vac)
 - 400 A (3.5-7 A @ 125 Vac)
 - 10 kA (125mA-3 A @ 125 Vac)



Agency information

- UL Listed, Guide JDYX, File E19180 125mA-250mA and 375mA-3 A, UL Recognized, Guide JDYX2, File E19180, 350mA and 3.5-7 A, CSA Certified, Class 1422-01, File 53787 125mA-250mA and 375mA-3 A, RoHS compliant, CE

Features

- Time-delay for closer sizing on inductive circuits

Typical application

- Electronic circuits
- Printed circuit boards

Catalog no. (amps)

Ferrule

C519-125-R	C519-600-R	C519-1.6-R	C519-3.5-R
C519-250-R	C519-750-R	C519-2-R	C519-4-R
C519-350-R	C519-1-R	C519-2.25-R	C519-5-R
C519-375-R	C519-1.25-R	C519-2.5-R	
C519-500-R	C519-1.5-R	C519-3-R	

Axial lead

C515-125-R	C515-750-R	C515-2-R	C515-5-R
C515-250-R	C515-800-R	C515-2.25-R	C515-6-R
C515-350-R	C515-1-R	C515-2.5-R	C515-7-R
C515-375-R	C515-1.25-R	C515-3-R	
C515-500-R	C515-1.5-R	C515-3.5-R	
C515-600-R	C515-1.6-R	C515-4-R	

C520 ferrule and C518 axial lead fast-acting 5x15mm glass tube fuses

Ratings

- Volts
 - 250 Vac
 - 32 Vdc (self certified)
- Amps 100mA-5 A
- IR
 - 35 A (100mA-750mA @ 250 Vac)
 - 10 kA (100mA-5 A @ 125 Vac)
 - 100 A (1.5-3.5 A @ 250 Vac)
 - 200 A (4-5 A @ 250 Vac)

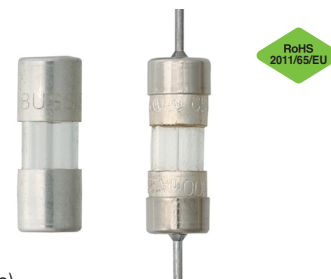

Agency information

- UL Recognized, Guide JDYX2, File E19180, CSA Certified, Class 1422-01, File 53787, RoHS compliant, CE

Features

- Small footprint saves space in equipment
- Fast-acting for maximum component protection
- Available in ferrule and axial lead configurations

Typical applications

- Electronic circuits
- Printed circuit boards

Catalog no. (amps)

Ferrule

C520-100-R	C520-500-R	C520-2.5-R	C520-5-R
C520-125-R	C520-750-R	C520-3-R	
C520-250-R	C520-1.5-R	C520-3.5-R	
C520-375-R	C520-2-R	C520-4-R	

Axial lead

C518-100-R	C518-375-R	C518-2-R	C518-3.5-R
C518-125-R	C518-500-R	C518-2.5-R	C518-4-R
C518-250-R	C518-750-R	C518-3-R	C518-5-R

C517 axial lead fast-acting 5x15mm glass tube fuse

Ratings

- Volts
 - 350 Vac
 - 32 Vdc (self certified)
 - Amps 3 A
 - IR
 - 100 A @ 350 Vac*
 - 100 A @ 250 Vac
 - 10 kA @ 125 Vac
- * 350 Vac/100 A IR is UL Recognized.



Agency information

- UL Listed, Guide JDYX, File E19180, CSA Certified, Class 1422-01, File 53787, UL Recognized, Guide JDYX2, File E19180, RoHS compliant, CE

Features

- Small footprint saves space in equipment
- Fast-acting for maximum component protection
- 350 Vac rating for 277 V ballast circuit protection

Typical applications

- Electronic circuits
- Printed circuit boards
- Electronic ballast protection

To order, use catalog number **C517-3-R**

S500 ferrule (GDB†) and S500-V axial lead fast-acting, low breaking capacity 5x20mm glass tube fuses

Ratings

- Volts
 - 250 Vac (or less)
 - 32 Vdc (self certified)
- Amps 32mA-10 A
- IR
 - 35 A (32mA-3.15 A)
 - 40 A (4 A)
 - 63 A (6.3 A)
 - 80 A (8 A)
 - 100 A (10 A)



Agency information

- cURus, SEMKO, VDE, BSI, IMQ, CCC, RoHS compliant, CE
- Agency information not applicable to all ratings; see data sheet for details.

Features

- Fast-acting for maximum protection, conforms to IEC 60127-2 (160mA-10 A)

Typical applications

- Electronic circuits

Catalog no. (amps)*			
S500-32-R	S500-160-R	S500-800-R	S500-4-R
S500-40-R	S500-200-R	S500-1-R	S500-5-R
S500-50-R	S500-250-R	S500-1.25-R	S500-6.3-R
S500-63-R	S500-315-R	S500-1.6-R	S500-8-R
S500-80-R	S500-400-R	S500-2-R	S500-10-R
S500-100-R	S500-500-R	S500-2.5-R	
S500-125-R	S500-630-R	S500-3.15-R	

* GDB is not available with axial leads. To order axial leads, place "V" in the S500 catalog number. E.g., S500-V-32-R.

† When ordering GDB versions, do not add "-R" suffix to catalog number.

Electronic, PCB, small dimension fuses

S501 ferrule (GDA†) and S501-V Axial lead fast-acting high breaking capacity 5x20mm ceramic tube fuses

Ratings

- Volts
 - 250 Vac (or less)
 - 32 Vdc (self certified)
- Amps 50mA-10 A**
- IR 1500 A @ 250 Vac

Agency information

- cURus, SEMKO, VDE, IMQ, CCC, CSA, BSI, MITI/JET, RoHS compliant, CE
- Agency information not applicable to all ratings, see data sheet for details.

Features

- Fast-acting for maximum protection
- High break capacity for use in higher fault energy electronic circuitry
- Conforms to IEC standards

Typical applications

- Electronic circuits

Catalog no. (amps)*

S501-50-R	S501-200-R	S501-800-R	S501-3.15-R
S501-63-R	S501-250-R	S501-1-R	S501-4-R
S501-80-R	S501-315-R	S501-1.25-R	S501-5-R
S501-100-R	S501-400-R	S501-1.6-R	S501-6.3-R
S501-125-R	S501-500-R	S501-2-R	S501-8-R
S501-160-R	S501-630-R	S501-2.5-R	S501-10-R

* GDA is not available with axial leads. To order axial leads, place "V" in the S501 catalog number. E.g., S501-V-125-R.

† When ordering GDA version, do not add "-R" suffix to catalog number, GDA is not available above 6.3 A.



S505 ferrule, and S505SC axial lead time-delay, high-breaking capacity 5x20mm ceramic tube fuses

Ratings

- Volts
 - 250 Vac (or less)
 - 32 Vdc (self certified)
- Amps 500mA-12 A
- IR 1500 A @ 250 Vac

Agency information

- cURus, CSA, IMQ, VDE, SEMKO, CCC/CQC, PSE/JET, KC, BS, RoHS compliant
- Agency information not applicable to all ratings, see data sheet for details.

Features

- Time-delay performance ideal for inductive circuits.
- Conforms to IEC standards.

Typical applications

- Electronic circuits



Catalog no. (amps)*

S505-500-R**	S505-1.6-R	S505-4-R	S505-10-R
S505-800-R**	S505-2-R	S505-5-R	S505-12-R**
S505-1-R	S505-2.5-R	S505-6.3-R	
S505-1.25-R	S505-3.15-R	S505-8-R	

* To order axial leads, place "SC" in catalog number. E.g., S505SC-2-R.

**Axial leads not available.

S505H ferrule, and S505H-V and S505SCH axial time-delay high breaking capacity 5x20mm ceramic tube fuses

Ratings

- Volts
 - 600 Vac/400 Vdc (S505H 500mA-5 A)
 - 500 Vac/400 Vdc (S505H 6.3-10 A)
 - 250 Vac (S505SCH)
- Amps
 - 500mA-10 A (S505H)
 - 3.15-6.3 A (S505SCH)
- IR @ 250 Vac
 - 35 A (S505H)
 - 1.5 kA (S505SCH / 50 Hz / 250 Vac / 400 Vdc)
 - 100 A max AC



Agency information

- cURus, CCC, CQC, TUV, PSE/JET (S505H)
- cURus, KC, CQC, TUV (S505SCH)
- RoHS compliant
- Agency information not applicable to all ratings; see data sheets for details.

Features

- Time-delay, high breaking capacity
- Conforms to IEC standards

Typical applications

- Power supplies/adapters
- Desktops/notebooks

Catalog no. (amps)

S505H*

S505H-500-R	S505H-1.6-R	S505H-4-R	S505H-10-R
S505H-800-R	S505H-2-R	S505H-5-R	
S505H-1-R	S505H-2.5-R	S505H-6.3-R	
S505H-1.25-R	S505H-3.15-R	S505H-8-R	

S505SCH (axial lead only)

S505SCH-3.15-R	S505SCH-5-R	S505SCH-6.3-R
----------------	-------------	---------------

* To order an axial lead S505H fuse, place "V" in catalog number. E.g., S505H-V-5-R.

S506 ferrule (GDC†) and S506-V axial lead time-delay low breaking capacity 5x20mm glass tube fuses

Ratings

- Volts
 - 250 Vac (or less)
 - 32 Vdc (self certified)
- Amps 32mA-15 A**
- IR 35 A @ 250 Vac



Agency information

- UR, CSA, cURus, SEMKO, VDE, BSI, IMQ, VDE, PSE/JET, CCC, RoHS compliant
- Agency information not applicable to all ratings; see data sheet for details.

Features

- Time-delay for inductive circuits
- Conforms to IEC standards

Typical applications

- Electronic circuits

Catalog no. (amps)*

S506-32-R	S506-160-R	S506-800-R	S506-4-R
S506-40-R	S506-200-R	S506-1-R	S506-5-R
S506-50-R	S506-250-R	S506-1.25-R	S506-6.3-R
S506-63-R	S506-315-R	S506-1.6-R	S506-8-R
S506-80-R	S506-400-R	S506-2-R	S506-10-R
S506-100-R	S506-500-R	S506-2.5-R	S506-12.5-R
S506-125-R	S506-630-R	S506-3.15-R	S506-15-R

* GDC is not available with axial leads. To order axial leads, place "V" in the S506 catalog number. E.g., S506-V-15-R.

† When ordering GDC version, do not add "-R" suffix to catalog number., GDC fuses are not available above 6.3 A.

GMA ferrule and GMA-V axial leads fast-acting 5x20mm glass tube fuses

Ratings

- Volts
 - 250 Vac (63mA-2.5 A)
 - 125 Vac (3.15-15 A)
 - 32 Vdc (self certified)
- Amps 63mA-15 A
- IR
 - 35 A (63mA-1 A @ 250 Vac, p.f. = 0.7-0.8)
 - 10 kA (63mA-6 A @ 125 Vac, p.f. = 0.7-0.8)
 - 100 A (1.25-2.5 A @ 250 Vac, p.f. = 0.7-0.8)
 - 200 A (7-8 A @ 125 Vac, p.f. = 1.0)
 - 150 A (10-15 A @ 125 Vac, p.f. = 1.0)



Agency information

- UL Listed, Std. 248-14 Guide JDYX, File E19180 up to 6 A, UL Recognized, Guide JDYX2, File E19180, 7-15 A, CSA Certified, Class 1422-01, File 53787 up to 6 A, PSE Approval 1-15 A, RoHS compliant, CE

Features

- Fast-acting for maximum protection

Typical applications

- Electronic circuits

Catalog no. (amps)*

GMA-63-R	GMA-600-R	GMA-2-R	GMA-7-R
GMA-100-R	GMA-750-R	GMA-2.5-R	GMA-8-R
GMA-125-R	GMA-800-R	GMA-3.15-R	GMA-10-R
GMA-200-R	GMA-1-R	GMA-3.5-R	GMA-15-R
GMA-250-R	GMA-1.25-R	GMA-4-R	
GMA-300-R	GMA-1.5-R	GMA-5-R	
GMA-500-R	GMA-1.6-R	GMA-6-R	

* To order axial leads, place "V" in catalog number. E.g., GMA-V-8-R.

GMC ferrule and GMC-V axial lead medium time-delay 5x20mm glass tube fuses

Ratings

- Volts
 - 250 Vac (63mA-3.15 A)
 - 125 Vac (3.5-10 A)
 - 32 Vdc (self certified)
- Amps 63mA-10 A
- IR
 - 35 A (63mA-1 A @ 250 Vac, p.f. = 0.7-0.8)
 - 10 kA (63mA-6 A @ 125 Vac, p.f. = 0.7-0.8)
 - 100 A (1.25-3.15 A @ 250 Vac, p.f. = 0.7-0.8)
 - 200 A (6.3-10 A @ 125 Vac, p.f. = 1.0)



Agency information

- UL Listed, Std. 248-14, Guide JDYX, File E19180 up to 6.3 A, UL Recognized, Guide JDYX2, File E19180 7-10 A, CSA Certified, Class 1422-01, File 53787 up to 6.3 A, MITI Approval, 1-10 A, KC, RoHS compliant, CE
- KC not applicable to all ratings; see data sheet for details

Features

- Conforms to UL standards

Typical applications

- Electronic circuits

Catalog no. (amps)*

GMC-63-R	GMC-315-R	GMC-1.25-R	GMC-5-R
GMC-80-R	GMC-400-R	GMC-1.5-R	GMC-6-R
GMC-100-R	GMC-500-R	GMC-1.6-R	GMC-6.3-R
GMC-125-R	GMC-600-R	GMC-2-R	GMC-7-R
GMC-150-R	GMC-630-R	GMC-2.5-R	GMC-8-R
GMC-200-R	GMC-750-R	GMC-3.15-R	GMC-10-R
GMC-250-R	GMC-800-R	GMC-3.5-R	
GMC-300-R	GMC-1-R	GMC-4-R	

* To order axial leads, place "V" in catalog number. E.g., GMC-V-5-R.

GMD ferrule and GMD-V axial leads time-delay 5x20mm glass tube fuses

Ratings

- Volts
 - 250 Vac
 - 32 Vdc (self certified)
- Amps 125mA-4 A
- IR
 - 10 kA (125mA-3 A @ 125 Vac, p.f. = 0.7-0.8)
 - 10 kA (4 A @ 125 Vac, p.f. = 1.0)
 - 35 A (125mA-1 A @ 250 Vac, p.f. = 0.7-0.8)
 - 100 A (1.2-3. A @ 250 Vac, p.f. = 0.7-0.8)
 - 200 A (4 A @ 250 Vac, p.f. = 1.0)



Agency information

- UL Listed Guide JDYX, File E19180, UL Recognized Card (4 A), Guide JDYX2, File E19180, 4 A, CSA Certified, Class 1422-01, File 53787, PSE/JET, File 1641-31003-1001, RoHS complaint, CE
- Agency information not applicable to all ratings; see data sheet for details

Features

- Time-delay for inductive circuits
- Conforms to UL standards

Typical applications

- Electronic circuits

Catalog no. (amps)*

GMD-125-R	GMD-375-R	GMD-800-R	GMD-2-R
GMD-150-R	GMD-400-R	GMD-1-R	GMD-2.5-R
GMD-200-R	GMD-500-R	GMD-1.2-R	GMD-3-R
GMD-250-R	GMD-600-R	GMD-1.25-R	GMD-4-R
GMD-300-R	GMD-630-R	GMD-1.5-R	
GMD-315-R	GMD-750-R	GMD-1.6-R	

* To order axial leads, place "V" in catalog number. E.g., GMD-V-2.5-R.

AGA fast-acting 1/4" x 5/8" glass tube fuse

Ratings

- Volts
 - 125 Vac (or less)
 - 32 Vdc (self certified)
- Amps 1-30 A
- IR
 - 10 kA (1 to 1-1/2 A @ 125 Vac)
 - 200 A (2-5 A @ 125 Vac)
 - 1000 A (6-30 A @ 32 Vac)



Agency information

- UL Listed, Std. 248-14, Guide JDYX, File E19180 up to 3-1/2 A UL Recognized, Guide JDYX2 12-30 A, CE

Features

- Fast-acting for maximum protection
- Size rejects insertion of other fuse types

Typical applications

- Electronic circuits

Catalog no. (amps)

AGA-1	AGA-3	AGA-7-1/2	AGA-25
AGA-1-1/2	AGA-5	AGA-10	AGA-30
AGA-2	AGA-6	AGA-15	
AGA-2-1/2	AGA-7	AGA-20	

AGW fast-acting 1/4" x 7/8" glass tube fuse

Ratings

- Volts
 - 32 Vac
 - 32 Vdc (self certified)
- Amps 1-30 A
- IR 1 kA AC



Features

- Fast-acting for maximum protection

Typical applications

- Electronic circuits

Catalog no. (amps)

AGW-1	AGW-3	AGW-7-1/2	AGW-25
AGW-1-1/2	AGW-4	AGW-10	AGW-30
AGW-2	AGW-5	AGW-15	
AGW-2-1/2	AGW-6	AGW-20	

AGX fast-acting 1/4" x 1" glass tube fuse

Ratings

- Volts
 - 250 Vac (1/4-20 A)
 - 125 Vac (25-30 A)
 - 32 Vdc (1/4-30 A)
- Amps 1/4-30 A
- IR
 - 35 A (1/4-1 A @ 250 Vac)
 - 10 kA (1/4-10 A @ 125 Vac)
 - 200 A (15-20 A @ 125 Vac)
 - 100 A (25-30 A @ 125 Vac)
 - 1000 A (8-30 A @ 32 Vac)



Agency information

- cULus up to 10 A, Guide JDYX, File E 19180 and Guide JDYX7, File E19180, UL Recognized Card 15-30 A Guide JDYX2, File E19180, CSA Component Acceptance Card 15-30 A Class No. 1422-01, File 53787

Features

- Size rejects insertion of other fuse types

Typical applications

- Electronic circuits

Catalog no. (amps)

AGX-1/4	AGX-1	AGX-4	AGX-15
AGX-3/10	AGX-1-1/4	AGX-5	AGX-20
AGX-3/8	AGX-1-1/2	AGX-6	AGX-25
AGX-4/10	AGX-2	AGX-7	AGX-30
AGX-1/2	AGX-2-1/2	AGX-8	
AGX-3/4	AGX-3	AGX-10	

AGC ferrule and AGC-V axial lead fast-acting 1/4" x 1-1/4" glass tube fuses

Ratings

- Volts
 - 250 Vac (1/20-10 A)
 - 32 Vac (12-40 A)
 - 32 Vdc (self certified)
- Amps 1/20-40 A
- IR
 - 35 A (1/20-1 A @ 250 Vac)
 - 100 A (11/4-3 A @ 250 Vac)
 - 200 A (4-10 A @ 250 Vac)
 - 10 kA (1/20-10 A @ 125 Vac)
 - 1000 A (12-40 A @ 32 Vac)



Agency information

- UL Listed, Guide JDYX, File E19180, up to 10 A, UL Recognized, Guide JDYX2, File E19180, 12-30 A, CSA Certified, Class 1422-01, CSA Component Acceptance Card, Class No. 1422-30, RoHS compliant, CE

Features

- Original electronic glass tube fuse
- Fast-acting for maximum protection
- Wide amp/volt ratings allow versatility of protecting electronic circuits

Typical applications

- Electronic circuits

Catalog no. (amps)*

AGC-1/20-R	AGC-3/4-R	AGC-5-R	AGC-15-R
AGC-1/10-R	AGC-1-R	AGC-6-R	AGC-20-R
AGC-1/8-R	AGC-1-1/4-R	AGC-7-R	AGC-25-R
AGC-3/16-R	AGC-1-1/2-R	AGC-7-1/2-R	AGC-30-R
AGC-2/10-R	AGC-2-R	AGC-8-R	AGC-35-R
AGC-1/4-R	AGC-2-1/4-R	AGC-9-R	AGC-40-R
AGC-3/10-R	AGC-2-1/2-R	AGC-10-R	
AGC-3/8-R	AGC-3-R	AGC-12-R	
AGC-1/2-R	AGC-4-R	AGC-14-R	

* To order axial leads, place "V" in catalog number. E.g., AGC-V-1/10-R.

ABC ferrule and ABC-V axial leads fast-acting 1/4" x 1-1/4" ceramic tube fuse

Ratings

- Volts
 - 250 Vac/125 Vdc (1/4-15 A, 20-30 A)*
 - 250 Vac (18 A)
 - 32 Vdc (self certified)
- Amps 1/4-30 A
- IR**
 - 35 A (1/4-1 A @ 250 Vac)
 - 100 A (11/2-3 A @ 250 Vac)
 - 200 A (4-10 A @ 250 Vac)
 - 750 A (12-15 A @ 250 Vac)
 - 400 A (18-20 A @ 250 Vac)
 - 10 kA (1/4-15 A @ 125 Vac)
 - 1 kA (18-30 A @ 125 Vac)
 - 10 kA (1/4-15, 20 A @ 125 Vdc)
 - 400 A (25-30 A @ 125 Vdc)
 - 200 A (25-30 A @ 250 Vac)



* CSA approvals for 25 A and 30 A are at 125 Vac – IR 1000 A and Vdc – IR 400 A (IR 1000 A at 75 Vdc)

** Interrupting ratings measured at 70% – 80% power factor on AC. The interrupting ratings for 18 A and 20 A were measured at 85%-95% power factor on AC. The interrupting ratings for 25 A and 30 A were measured at 89% power factor on AC.

Agency information

- UL Listed, Std. 248-14, Guide JDYX File E19180 up to 15 A; UL Recognized, Guide JDYX2, File E19180, 18-30 A; CSA Certified, Class 1422-01 and 1422-30, File 53787, RoHS compliant, CE

Features

- Ceramic body allows for higher amp/volt rating combinations

Typical applications

- Electronic circuits

Catalog no. (amps)

ABC-1/4-R	ABC-2-R	ABC-6-R	ABC-15-R
ABC-1/2-R	ABC-2-1/2-R	ABC-7-R	ABC-18-R
ABC-3/4-R	ABC-3-R	ABC-8-R	ABC-20-R
ABC-1-R	ABC-4-R	ABC-10-R	ABC-25-R
ABC-1-1/2-R	ABC-5-R	ABC-12-R	ABC-30-R

* To order axial leads, place "V" in catalog number. E.g., ABC-V-7-R.

Electronic, PCB, small dimension fuses

GBB ferrule and GBB-V axial lead very-fast-acting 1/4" x 1-1/4" ceramic tube fuses

Ratings

- Volts 250 Vac/125 Vdc
- Amps 1-30 A
- IR
 - 200 A @ 250 Vac
 - 200 A (20-30 A @ 125 Vac/dc)
 - 10 kA (1-15 A @ 125 Vac/dc)



Agency information

• UL Recognized, Std. 248-14, Guide JFHR2, File E56412, CSA Component Acceptance Class 1422-30, File 53787, RoHS complaint, CE

Features

- Very fast-acting performance allows protection of highly sensitive electronic circuitry

Typical applications

- Electronic circuits

Catalog no. (amps)*

GBB-1-R	GBB-4-R	GBB-8-R	GBB-15-R
GBB-1-1/4-R	GBB-5-R	GBB-9-R	GBB-20-R
GBB-2-R	GBB-6-R	GBB-10-R	GBB-25-R
GBB-3-R	GBB-7-R	GBB-12-R	GBB-30-R

* To order axial leads, place "V" in catalog number. E.g., GBB-V-10-R.

MDL ferrule and MDL-V axial lead time-delay 1/4" x 1-1/4" glass tube fuses

Ratings

- Volts
 - 250 Vac (1/16-8 A)
 - 32 Vac (9-30 A)
 - 32 Vdc (self certified)
- Amps 1/16-30 A
- IR*
 - 35 A (1/16-1 A @ 250 Vac)
 - 100 A (11/4-3 A @ 250 Vac)
 - 200 A (4-8 A @ 250 Vac)
 - 10000 A (1/16-8 A @ 125 Vac)
 - 1000 A (9-30 A @ 32 Vac)



* Interrupting ratings were measured at 70% – 80% power factor on AC, and at a time constant described in UL 198L.

Agency information

• UL Listed, Guide JDYX, File E19180 up to 8 A; CSA Certified Class 1422-01 up to 8 A; UL Recognized, Guide JDYX2, File E19180, 9-30 A; CSA Component Acceptance, Class 1422-30, 9-30 A, RoHS compliant, CE

Features

- Time-delay allows close sizing on inductive circuits

Typical applications

- Electronic circuits

Catalog no. (amps)*

MDL-1/16-R	MDL-1/2-R	MDL-3-R	MDL-10-R
MDL-1/10-R	MDL-3/4-R	MDL-3-2/10-R	MDL-12-R
MDL-1/8-R	MDL-1-R	MDL-4-R	MDL-15-R
MDL-2/10-R	MDL-1-1/4-R	MDL-5-R	MDL-20-R
MDL-3/16-R	MDL-1-1/2-R	MDL-6-R	MDL-25**
MDL-1/4-R	MDL-2-R	MDL-7-R	MDL-30**
MDL-3/10-R	MDL-2-1/4-R	MDL-8-R	
MDL-3/8-R	MDL-2-1/2-R	MDL-9-R	

* To order axial leads, place "V" in catalog number. E.g., MDL-V-3-R.
 **RoHS compliant construction not available.

MDQ ferrule and MDQ-V axial lead dual-element, time-delay 1/4" x 1-1/4" glass tube fuses

Ratings

- Volts
 - 250 Vac (1/100-7 A)
 - 32 Vac (7-1/2 to 15 A)
 - 32 Vdc (self certified)
- Amps 1/100-15 A
- IR
 - 35 A (1/100-1 A @ 250 Vac)
 - 100 A (1-1/4 to 3 A @ 250 Vac)
 - 200 A (4-7 A @ 250 Vac)
 - 1000 A (7-1/2 to 12 A @ 32 Vac)

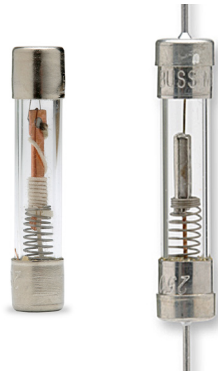

Agency information

- UL Listed, Std. 248-14, Guide JDYX, File E19180 1/16-7 A, CSA Component Acceptance, Class 1422-01, File 47233 1/16 -15 A, UL Recognized, Guide JDYX2, File E19180, 7-1/2-15 A.

Features

- Dual-element design allows closer sizing to inductive circuits than any other fuses

Typical applications

- Electronic relay and control circuits

Catalog no. (amps)*

MDQ-1/100	MDQ-3/10	MDQ-1-1/2	MDQ-5
MDQ-1/32	MDQ-3/8	MDQ-1-6/10	MDQ-6
MDQ-1/16	MDQ-4/10	MDQ-1-8/10	MDQ-6-1/4
MDQ-1/10	MDQ-1/2	MDQ-2	MDQ-7
MDQ-1/8	MDQ-6/10	MDQ-2-1/4	MDQ-7-1/2
MDQ-15/100	MDQ-3/4	MDQ-2-1/2	MDQ-8
MDQ-175/1000	MDQ-8/10	MDQ-2-8/10	MDQ-9
MDQ-3/16	MDQ-1	MDQ-3	MDQ-10
MDQ-2/10	MDQ-1-2/10	MDQ-3-2/10	MDQ-12
MDQ-1/4	MDQ-1-1/4	MDQ-4	MDQ-15

* To order axial leads, place "V" in catalog number. E.g., MDQ-V-1-1/4.

MDA ferrule and MDA-V axial lead time-delay 1/4" x 1-1/4" ceramic tube fuses

Ratings

- Volts
 - 250 Vac (or less)
 - 125 Vdc (20-30 A)
 - 32 Vdc (self certified)
- Amps 1/4-30 A
- IR**
 - 35 A (1/4 to 1 A @ 250 Vac)
 - 100 A (1-1/2 to 2 A @ 250 Vac)
 - 200 A (2-1/2 to 10 A @ 250 Vac)
 - 750 A (12-15 A @ 250 Vac)
 - 1500 A (20-30 A @ 250 Vac)
 - 10 kA (1/4-30 A @ 125 Vac)
 - 10 kA (20-30 A @ 125 Vdc)



**Interrupting ratings were measured at 70% – 80% power factor on AC, and at a time constant described in UL 248.

Agency information

- UL Listed, Std. 248-14, Guide JDYX, File E19180 up to 20 A, CSA Certified, Class 1422-01, File 53787 up to 20 A. UL Recognized, Guide JDYX2, File E19180, 25-30 A, CSA Component Acceptance, Class 1422-30, 25-30 A, RoHS compliant, CE

Features

- Ceramic body for higher amp/volt ratings
- Inventory consolidation by replacing MDL fuses allows for reduced SKU investment and minimizing potential for misapplying fuse

Typical applications

- Electronic circuits

Catalog no. (amps)*

MDA-1/4-R	MDA-2-R	MDA-6-R	MDA-15-R
MDA-1/2-R	MDA-2-1/2-R	MDA-7-R	MDA-20-R
MDA-3/4-R	MDA-3-R	MDA-8-R	MDA-25 A-R
MDA-1-R	MDA-4-R	MDA-10-R	MDA-30 A-R
MDA-1-1/2-R	MDA-5-R	MDA-12-R	

* To order axial leads, place "V" in catalog number. E.g., MDA-V-1-1/2-R.

Electronic, PCB, small dimension fuses

H15-V vertical mount holder with threaded cap



Ratings

- Volts 250 Vac
- Amps 10 A (cURus and VDE)
- Temperature rise 41°C

Agency information

- cURus Recognized, Guide IZLT2/IZLT8, File E14853
- VDE File 40039714

Materials

- Tin-plated clip
- Tin-plated copper terminals
- Thermoplastic body (UL 94V0, glow wire test: 960°C per IEC 695-2-1)

Catalog no.	Carton qty.
BK-H15-V-1	200
BK1-H15-V-1	1000
BK-H15-V-1-B	100 holder body only
BK-H15-V-1-K	100 holder cap only

Dimensions - in (mm)

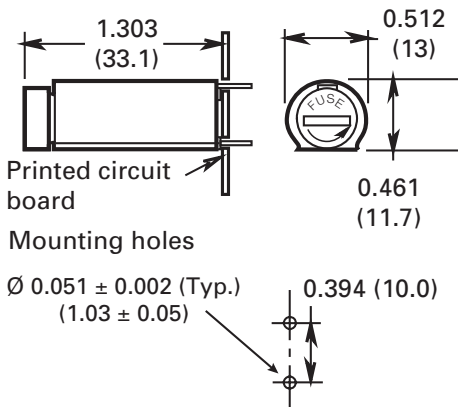

H15-H horizontal mount holder with threaded cap



Ratings

- Volts 250 Vac
- Amps 10 A (cURus) 6.3 A (VDE)
- Temperature rise 41°C

Agency information

- cURus Recognized, Guide IZLT2/IZLT8, File E14853
- VDE File 40039714

Materials

- Tin-plated clip
- Tin-plated copper terminals
- Thermoplastic body (UL 94V0, glow wire test: 960°C per IEC 695-2-1)

Catalog no.	Carton qty.
BK-H15-H-1	200
BK1-H15-H-1	1000
BK-H15-H-1-B	100 holder body only
BK-H15-H-1-K	100 holder cap only

Dimensions - in (mm)

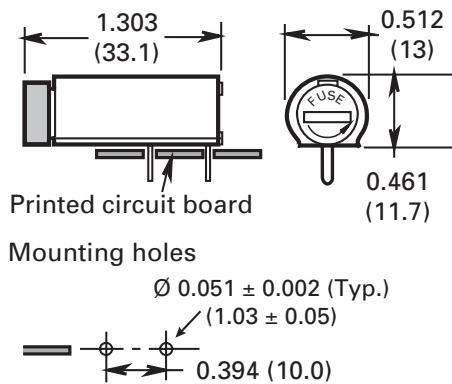

HTC-60M four-leg stand-off mount fuse holder



Ratings

- Volts 250 Vac
- Amps 6.3 (cURus and VDE)

Agency information

- cURus Recognized, Guide IZLT2/IZLT8, File E14853
- VDE File 4004459

Materials

- Tin-plated brass terminals

Catalog no.	Qty.
HTC-60M	10
BK-HTC-60M	100 (bulk)

Dimensions - in (mm)

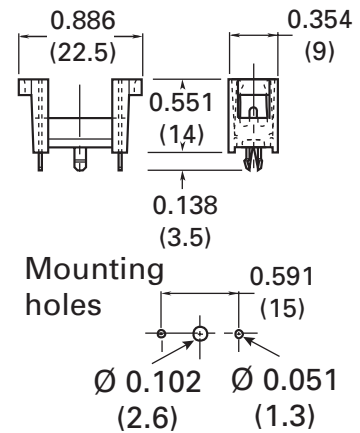

HBH-I (1/4" x 1-1/4") and HBH-M (5x20mm) horizontal mount fuse holders

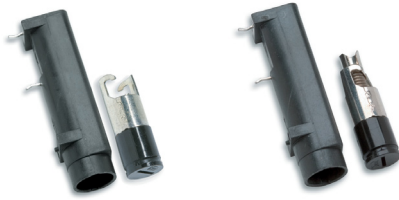

Dimensions - in (mm)

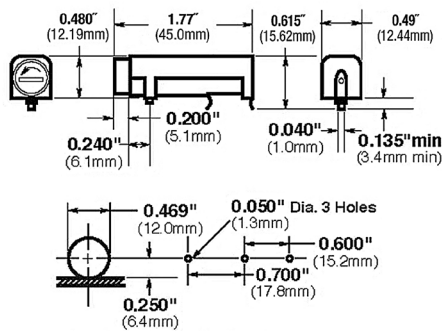

Ratings

- UL 16 A/250 V
- CSA 12 A/250 V
- VDE 6.3 A/250 V
- SEMKO 10 A/250 V

Agency information

- UL Recognized, Guide IZLT2, File E14853, CSA Certified, Class 6225-01, File 47235, VDE 4009241 (HBV, HBW), SEMKO 800444, CE

Electrical

- Insulation resistance 10 MΩ 500 Vdc
- Contact resistance less than 0.005 Ω @ 200mV
- Dielectric strength over 200 V/mil

HBV-I (1/4" x 1-1/4") and HBV-M (5x20mm) vertical mount fuse holders with stability pins



Dimensions - in (mm)

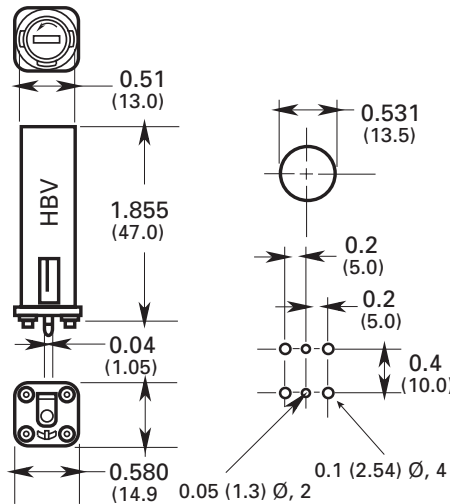

Material

- High dielectric molded phenolic with a UL 94V0 flammability rating
- Fuse carrier and knob: spring-loaded, bayonet-type, tin-plated brass with screwdriver slot

Mounting

- "Kicked" terminals (all) and stability pins on HBV and HBW
- Temperature rating (RTI): body 150°C, knob 130°C

HBW-I (1/4" x 1-1/4") and HBW-M (5x20mm) vertical mount fuse holder without stability pins



Dimensions - in (mm)

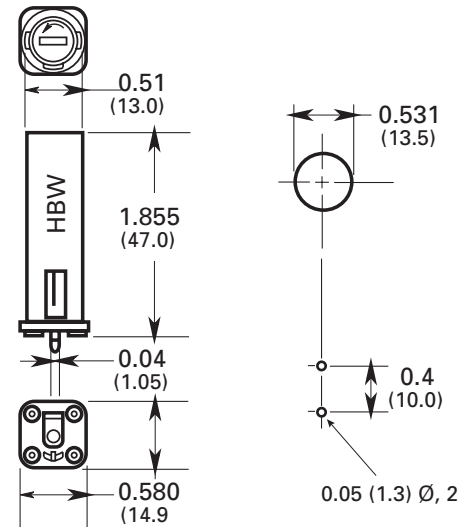

Replacement fuse caps

FBI and FBM fuse caps fit PCB fuse holders HBH-, HBV-, and HBW-.

To order, specify Catalog numbers:

- FBI for 1/4" diameter fuses
- FBM for 5mm diameter fuses



FBI



FBM

Electronic, PCB, small dimension fuses

HTC-15M, HTC-140M holder and snap-on cover

Ratings

- 250 V / 6.3 A / 1.6 W

Agency information

- cURus, Guide 1ZLT2 and 1ZLT8, File E14853
- VDE 40004458
- RoHS compliant

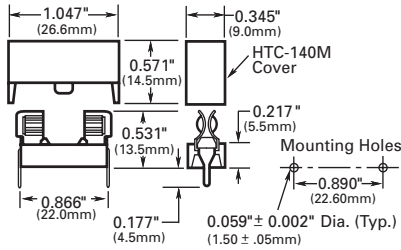

1A3399 low profile fuseclips with end stops and straight leads

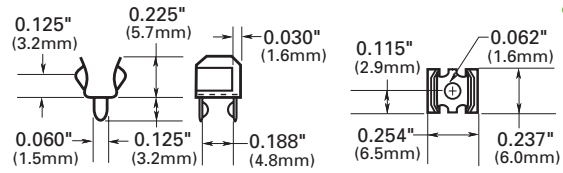

Catalog no.	Material*	Finish
1A3399-01	BeCu	Silver
1A3399-04-R	BeCu	Bright tin
1A3399-10-R	Spring bronze	Bright tin

* BeCu recommended for more than 15 A.

1A5018 high profile fuseclips with end stops and straight leads

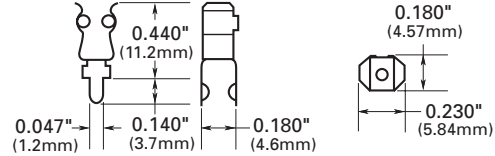

Catalog no.	Material*	Finish
1A5018-07	Spring bronze	Silver
1A5018-10-R	Spring bronze	Bright tin

* BeCu 1A3399 fuseclips recommended for more than 15 A.

HTC-200M fuseclip

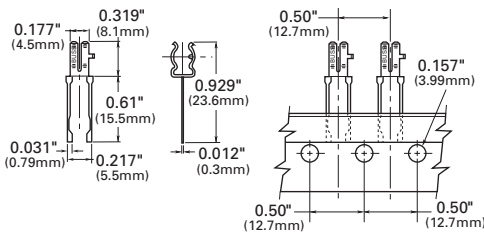

1A5601 fuseclip (≤ 7 A)

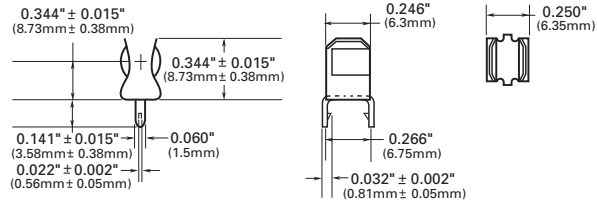

Catalog no.	Material	Finish
1A5601	Cartridge brass	Bright tin

HTC-210M fuseclip with end stops

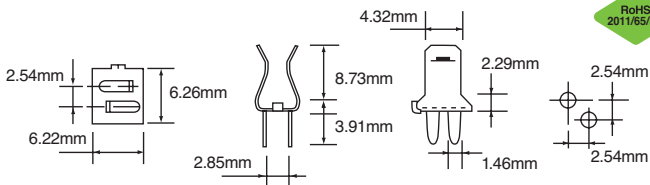

1A5602 fuseclip with end stops (≤ 7 A)

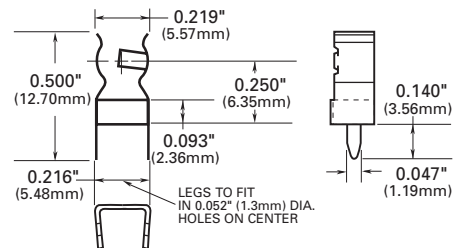

Catalog no.	Material	Finish
1A5602	Cartridge brass	Bright tin

Catalog no.	Material	Description
HTC-200M	Tin-plated bronze	Tape and fan fold pack
AP/HTC-200M		Ammo pack 1000 pieces per box

1A1119 fuseclips with end stops and angled-in leads

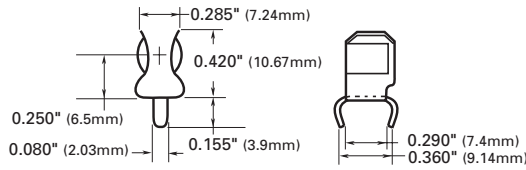

Catalog no.	Material*	Finish
1A1119-04-R	High performance copper	Bright tin
1A1119-05	High performance copper	Silver
1A1119-10-R	Cartridge brass	Bright tin

* High performance copper recommended for more than 15 A.

1A3398 PCB fuseclips without end stops with straight leads

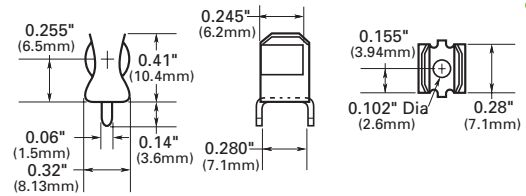

Catalog no.	Material	Finish
1A3398-07-R	Cartridge brass	Bright tin

1A1120 fuseclips without end stops or angled-in leads

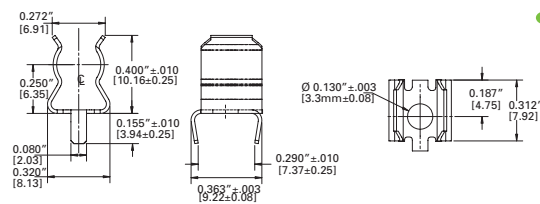

Catalog no.	Material*	Finish
1A1120-02	Cartridge brass	None/bright dipped
1A1120-05	High performance copper	Silver
1A1120-06-R	High performance copper	Bright tin
1A1120-09-R	Cartridge brass	Bright tin

* High performance copper recommended for more than 15 A.

1A4533 fuseclips without end stops or angled out leads

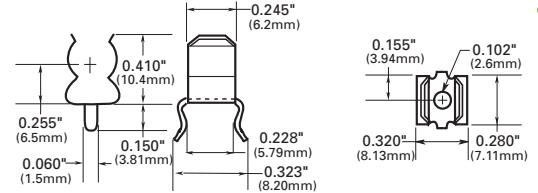

Catalog no.	Material*	Finish
1A4533-01-R	High performance copper	Bright tin
1A4533-06-R	Cartridge brass	Bright tin

* High performance copper recommended for more than 15 A.

1A1907 fuseclips with end stops and straight leads

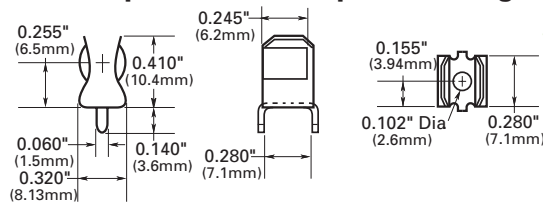

Catalog no.	Material*	Finish
1A1907-02	Cartridge brass	None/bright dipped
1A1907-03-R	High performance copper	Bright tin
1A1907-05	High performance copper	Silver
1A1907-06-R	Cartridge brass	Bright tin

* High performance copper recommended for more than 15 A.

1A4534 fuseclips with end stops and angled out leads

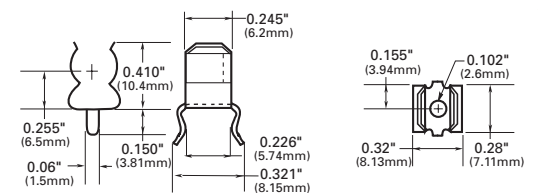

Catalog no.	Material*	Finish
1A4534-01-R	High performance copper	Bright tin
1A4534-06-R	Cartridge brass	Bright tin

* High performance copper recommended for more than 15 A.

Electronic, PCB, small dimension fuses

5681 and 5682 fuseclips with mounting holes for 1/4" diameter fuses

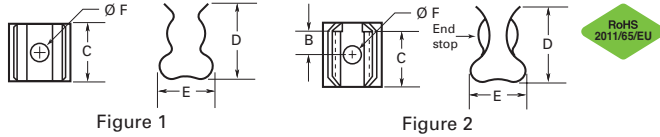

Catalog no.	Clip		Dimensions - in					Ref.
	mat.	Finish	B	C	D	E	Ø F	
Without end stop								
5681-01	BeCu	Silver						
5681-08	Spr. br.	Nickel	†	0.265	0.41	0.32	0.132	Fig. 1
5681-15-R		Bright tin						
With end stop								
5682-01	BeCu	Silver		0.108				
5682-02				0.131				
5682-11-R	BeCu	Bright tin	0.106	0.262	0.41	0.32	0.132	Fig. 2
5682-41-R	Spr. br.		0.106					
5682-44-R			0.132					

5956 and 5960 PCB fuseclips with mounting holes for 13/32" diameter fuses

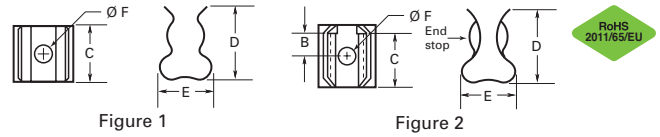

Catalog no.	Clip		Dimensions - in					Ref.
	mat.	Finish	B	C	D	E	Ø F	
Without end stop								
5956-16	Spr. br.	Bright tin	†	0.312	0.71	0.47	0.172	Fig. 1
With end stop								
5960-07	BeCu	Silver		0.168				0.196
5960-09				0.2				0.172
5960-44		Nickel						0.197
5960-51		Bright dip*		0.168				0.196
5960-53			0.2	0.387	0.71	0.47	0.172	Fig. 2
5960-61-R	Spr. br.	Bright tin		0.168				0.196
5960-62-R								0.132
5960-63-R								0.172
5960-64-R				0.2				0.128

* Treated bare metal with no plating.

5672 and 5674 PCB fuseclips with mounting holes for 9/32" diameter fuses

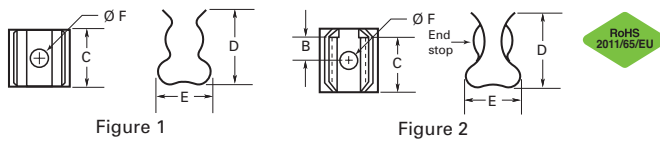

Catalog no.	Clip		Dimensions - in					Ref.
	mat.	Finish	B	C	D	E	Ø F	
Without end stop								
5672-11	Spr. br.	Bright tin	†	0.362	0.52	0.38	0.172	Fig. 1
With end stop								
5674-01	BeCu	Silver						
5674-10				0.168	0.356	0.52	0.38	0.172
5674-41	Spr. br.	Bright tin						

5591 and 5592 PCB fuseclips with mounting holes for 9/16" diameter fuses

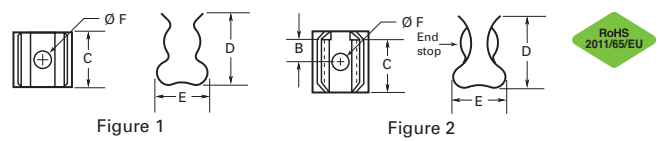

Catalog no.	Clip		Dimensions - in					Ref.
	mat.	Finish	B	C	D	E	Ø F	
Without end stop								
5592-01	BeCu	Silver	0.252	0.56	0.875	0.6	0.2	Fig. 1
With end stop								
5591-42	Spr. br.	Bright dip*	0.26	0.51	0.89	0.6	0.172	Fig. 2
5591-52-R		Bright tin						

* Treated bare metal with no plating.

1A3400 fuseclips with end stops and straight leads for 13/32" diameter fuses

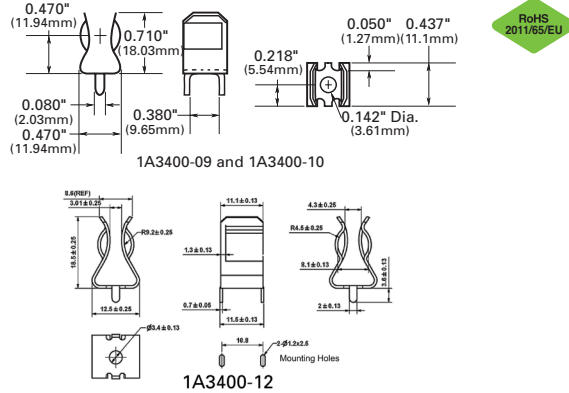

Catalog no.	Clip mat.	Finish	Max amps
1A3400-09-R	Copper-clad steel	Bright tin	20
1A3400-10-R	Copper-clad steel	Silver	30
1A3400-12-R	Spr. br.	Bright tin	15