

**CONTINUOUS HINGE WITH CLAMPS, TYPE 12**

**INDUSTRY STANDARDS**

 UL 50, 50E Listed; Type 12, 13; File No. E27567  
 cUL Listed per CSA 22.2 No. 94; Type 12, 13; File No. E27567  
 UL 508A Listed; Type 12, 13; File No. E61997  
 cUL Listed per CSA 22.2 No. 94; Type 12, 13; File No. E61997

 NEMA/EEMAC Type 12 and 13  
 CSA, File No. 42184: Type 12  
 IEC 60529, IP65

**APPLICATION**

This easy-to-open, continuous hinge enclosure features screw-down clamps for secure closure and can be used in a wide variety of applications.

**SPECIFICATIONS**

- 16 or 14 gauge steel
- Seams continuously welded and ground smooth
- Continuous hinge
- Screw-down door clamps
- Bonding provision on door
- External welded-on mounting brackets for easy installation
- Oil-resistant gasket
- Weldnuts provided for mounting optional panels and terminal block kits in size 6.00 x 4.00 in. (152 x 102 mm) and larger

**FINISH**

ANSI 61 gray polyester powder paint inside and out

**ACCESSORIES**

 Panels for Junction Boxes  
 Clamp Kits  
 Fast-Operating Clamp-Cover Junction Box Clamp  
 Lock Kit for Clamp Cover Junction Boxes  
 Junction Box and Wall-Mount Enclosure Swing Out Panel Kit  
 Hole Seals

**MODIFICATION AND CUSTOMIZATION**

Hoffman excels at modifying and customizing products to your specifications. Contact your local Hoffman sales office or distributor for complete information.

**BULLETIN: A51CH**

## Standard Product

Catalog Number	AxBxC in./mm	Gauge	UL Listed	Panel	Conductive Panel	Panel Size D x E in./mm	Mounting G x H in./mm	Overall L x W in./mm	F in./mm	J in./mm	K in./mm	P in./mm	T in./mm	V in./mm	Y in./mm
A404CH	4.00 x 4.00 x 3.00 102 x 102 x 76	16	508A	No Panel	No Panel	No Panel	4.75 x 2.00 121 x 51	5.50 x 4.94 140 x 125	—	2.62 66	0.54 14	1.38 35	3.00 76	—	—
A604CH	6.00 x 4.00 x 3.00 152 x 102 x 76	16	508A	A6P4	A6P4G	4.88 x 2.88 124 x 73	6.75 x 2.00 171 x 51	7.50 x 4.94 191 x 125	2.53 64	2.62 66	0.54 14	2.38 60	3.00 76	0.31 8	0.56 14
A806CH	8.00 x 6.00 x 3.50 203 x 152 x 89	14	50, 50E	A8P6	A8P6G	6.75 x 4.88 171 x 124	8.75 x 4.00 222 x 102	9.50 x 6.94 241 x 176	3.03 77	3.12 79	0.56 14	2.38 60	5.00 127	0.25 6	0.62 16
A8063CHS	8.00 x 6.00 x 3.50 203 x 152 x 89	14	50, 50E	A8P6	A8P6G	6.75 x 4.88 171 x 124	8.75 x 4.00 222 x 102	9.50 x 6.94 241 x 176	3.03 77	3.12 79	0.56 14	2.38 60	5.00 127	0.25 6	0.62 16
A4044CH	4.00 x 4.00 x 4.00 102 x 102 x 102	16	508A	No Panel	No Panel	No Panel	4.75 x 2.00 121 x 51	5.50 x 4.94 140 x 125	—	3.62 92	0.54 14	1.38 35	3.00 76	—	—
A6044CH	6.00 x 4.00 x 4.00 152 x 102 x 102	16	508A	A6P4	A6P4G	4.88 x 2.88 124 x 73	6.75 x 2.00 171 x 51	7.50 x 4.94 191 x 125	3.53 90	3.62 92	0.54 14	2.38 60	3.00 76	0.31 8	0.56 14
A606CH	6.00 x 6.00 x 4.00 152 x 152 x 102	16	50, 50E	A6P6	A6P6G	4.88 x 4.88 124 x 73	6.75 x 4.00 171 x 102	7.50 x 6.94 191 x 176	3.53 90	3.62 92	0.54 14	2.38 60	5.00 127	0.31 8	0.56 14
A808CH	8.00 x 8.00 x 4.00 203 x 203 x 102	14	50, 50E	A8P8	A8P8G	6.75 x 6.88 171 x 175	8.75 x 6.00 222 x 152	9.50 x 8.94 241 x 227	3.53 90	3.62 92	0.56 14	1.00 25	7.00 178	0.25 6	0.62 16
A12044CH	12.00 x 6.00 x 4.00 305 x 152 x 102	14	50, 50E	A12P6	A12P6G	10.75 x 4.88 273 x 124	12.75 x 4.00 324 x 102	13.50 x 6.94 343 x 176	3.53 90	3.62 92	0.56 14	1.00 25	5.00 127	0.25 6	0.62 16
A1008CH	10.00 x 8.00 x 4.00 254 x 203 x 102	14	50, 50E	A10P8	A10P8G	8.75 x 6.88 222 x 175	10.75 x 6.00 273 x 152	11.50 x 8.94 292 x 227	3.53 90	3.62 92	0.56 14	1.00 25	7.00 178	0.25 6	0.62 16
A1008CHS	10.00 x 8.00 x 4.00 254 x 203 x 102	14	50, 50E	A10P8	A10P8G	8.75 x 6.88 222 x 175	10.75 x 6.00 273 x 152	11.50 x 8.94 292 x 227	3.53 90	3.62 92	0.56 14	1.00 25	7.00 178	0.25 6	0.62 16
A1210CH	12.00 x 10.00 x 5.00 305 x 254 x 127	14	50, 50E	A12P10	A12P10G	10.75 x 8.88 273 x 226	12.75 x 8.00 324 x 203	13.50 x 10.94 343 x 278	4.53 115	4.62 117	0.56 14	1.00 25	9.00 229	0.25 6	0.62 16
A1210CHS	12.00 x 10.00 x 5.00 305 x 254 x 127	14	50, 50E	A12P10	A12P10G	10.75 x 8.88 273 x 226	12.75 x 8.00 324 x 203	13.50 x 10.94 343 x 278	4.53 115	4.62 117	0.56 14	1.00 25	9.00 229	0.25 6	0.62 16
A8066CH	8.00 x 6.00 x 6.00 203 x 152 x 152	14	50, 50E	A8P6	A8P6G	6.75 x 4.88 171 x 124	8.75 x 4.00 222 x 102	9.50 x 6.94 241 x 176	5.53 140	5.62 143	0.56 14	1.00 25	5.00 127	0.25 6	0.62 16
A8086CH	8.00 x 8.00 x 6.00 203 x 203 x 152	14	50, 50E	A8P8	A8P8G	6.75 x 6.88 171 x 175	8.75 x 6.00 222 x 152	9.50 x 8.94 241 x 227	5.53 140	5.62 143	0.56 14	1.00 25	7.00 178	0.25 6	0.62 16
A10086CH	10.00 x 8.00 x 6.00 254 x 203 x 152	14	50, 50E	A10P8	A10P8G	8.75 x 6.88 222 x 175	10.75 x 6.00 273 x 152	11.50 x 8.94 292 x 227	5.53 140	5.62 143	0.56 14	1.00 25	7.00 178	0.25 6	0.62 16
A14086CH	14.00 x 8.00 x 6.00 356 x 203 x 152	14	50, 50E	A14P8	A14P8G	12.75 x 6.88 324 x 175	14.75 x 6.00 375 x 152	15.50 x 8.94 394 x 227	5.53 140	5.62 143	0.56 14	1.00 25	7.00 178	0.25 6	0.62 16
A10106CH	10.00 x 10.00 x 6.00 254 x 254 x 152	14	50, 50E	A10P10	A10P10G	8.75 x 8.88 222 x 226	10.75 x 8.00 273 x 203	11.50 x 10.94 292 x 278	5.53 140	5.62 143	0.56 14	1.00 25	9.00 229	0.25 6	0.62 16
A16106CH	16.00 x 10.00 x 6.00 406 x 254 x 152	14	50, 50E	A16P10	A16P10G	14.75 x 8.88 375 x 226	16.75 x 8.00 425 x 203	17.50 x 10.94 445 x 278	5.53 140	5.62 143	0.56 14	1.00 25	9.00 229	0.25 6	0.62 16
A1212CH	12.00 x 12.00 x 6.00 305 x 305 x 152	14	50, 50E	A12P12	A12P12G	10.75 x 10.88 273 x 276	12.75 x 10.00 324 x 254	13.50 x 12.94 343 x 329	5.53 140	5.62 143	0.56 14	1.00 25	11.00 279	0.25 6	0.62 16

Catalog Number	AxBxC in./mm	Gauge	UL Listed	Panel	Conductive Panel	Panel Size D x E in./mm	Mounting C x H in./mm	Overall L x W in./mm	F in./mm	J in./mm	K in./mm	P in./mm	T in./mm	V in./mm	Y in./mm
A1412CH	14.00 x 12.00 x 6.00 356 x 305 x 152	14	50, 50E	A14P12	A14P12G	12.75 x 10.88 324 x 276	14.75 x 10.00 375 x 254	15.50 x 12.94 394 x 329	5.53 140	5.62 143	0.56 14	1.00 25	11.00 279	0.25 6	0.62 16
A1412CHS	14.00 x 12.00 x 6.00 356 x 305 x 152	14	50, 50E	A14P12	A14P12G	12.75 x 10.88 324 x 276	14.75 x 10.00 375 x 254	15.50 x 12.94 394 x 329	5.53 140	5.62 143	0.56 14	1.00 25	11.00 279	0.25 6	0.62 16
A1614CH	16.00 x 14.00 x 6.00 406 x 356 x 152	14	50, 50E	A16P14	A16P14G	14.75 x 12.88 375 x 327	16.75 x 12.00 425 x 305	17.50 x 14.94 445 x 379	5.53 140	5.62 143	0.56 14	1.00 25	13.00 330	0.25 6	0.62 16
A1614CHS	16.00 x 14.00 x 6.00 406 x 356 x 152	14	50, 50E	A16P14	A16P14G	14.75 x 12.88 375 x 327	16.75 x 12.00 425 x 305	17.50 x 14.94 445 x 379	5.53 140	5.62 143	0.56 14	1.00 25	13.00 330	0.25 6	0.62 16
A10108CH	10.00 x 10.00 x 8.00 254 x 254 x 203	14	50, 50E	A10P10	A10P10G	8.75 x 8.88 222 x 226	10.75 x 8.00 273 x 203	11.50 x 10.94 292 x 278	5.53 140	5.62 143	0.56 14	1.00 25	9.00 229	0.25 6	0.62 16
A12108CH	12.00 x 10.00 x 8.00 305 x 254 x 203	14	50, 50E	A12P10	A12P10G	10.75 x 8.88 273 x 226	12.75 x 8.00 324 x 203	13.50 x 10.94 343 x 278	7.53 191	7.62 194	0.56 14	1.00 25	9.00 229	0.25 6	0.62 16
A14128CH	14.00 x 12.00 x 8.00 356 x 305 x 203	14	50, 50E	A14P12	A14P12G	12.75 x 10.88 324 x 276	14.75 x 10.00 375 x 254	15.50 x 12.94 394 x 329	7.53 191	7.62 194	0.56 14	1.00 25	11.00 279	0.25 6	0.62 16
A16148CH	16.00 x 14.00 x 8.00 406 x 356 x 203	14	50, 50E	A16P14	A16P14G	14.75 x 12.88 375 x 327	16.75 x 12.00 425 x 305	17.50 x 14.94 445 x 379	7.53 191	7.62 194	0.56 14	1.00 25	13.00 330	0.25 6	0.62 16
A161410CH	16.00 x 14.00 x 10.00 406 x 356 x 254	14	50, 50E	A16P14	A16P14G	14.75 x 12.88 375 x 327	16.75 x 12.00 425 x 305	17.50 x 14.94 445 x 379	9.53 242	9.62 244	0.56 14	1.00 25	13.00 330	0.25 6	0.62 16

Catalog numbers ending in "S" are hinged on short side.

Purchase panels separately. Optional stainless steel, conductive, composite and aluminum panels are available for most sizes.

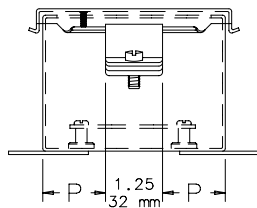
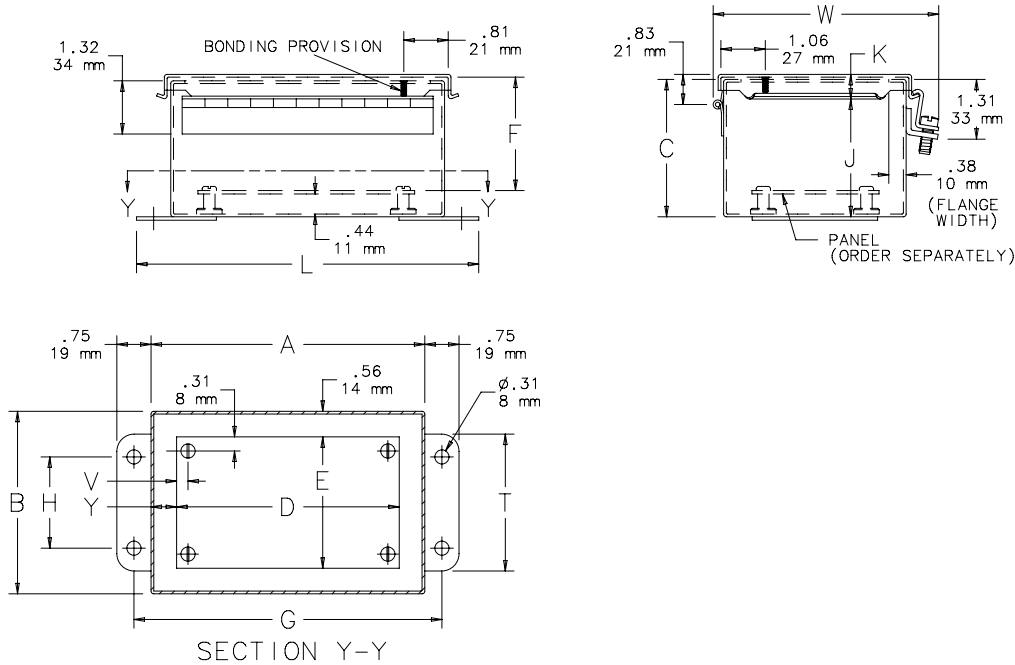

View showing clamp end of box when one clamp is used.

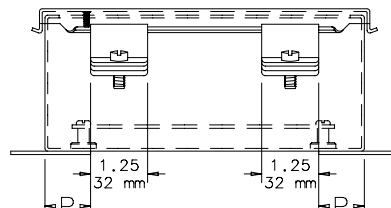

View showing clamp end of box when two clamps are used. When A=8.00 (203mm) or more, use two clamps.

C2476-C

**CONTINUOUS HINGE WITH CLAMPS, TYPE 12**

**INDUSTRY STANDARDS**

 UL 50, 50E Listed; Type 12, 13; File No. E27567  
 cUL Listed per CSA 22.2 No. 94; Type 12, 13; File No. E27567  
 UL 508A Listed; Type 12, 13; File No. E61997  
 cUL Listed per CSA 22.2 No. 94; Type 12, 13; File No. E61997

 NEMA/EEMAC Type 12 and 13  
 CSA, File No. 42184: Type 12  
 IEC 60529, IP65

**APPLICATION**

This easy-to-open, continuous hinge enclosure features screw-down clamps for secure closure and can be used in a wide variety of applications.

**SPECIFICATIONS**

- 16 or 14 gauge steel
- Seams continuously welded and ground smooth
- Continuous hinge
- Screw-down door clamps
- Bonding provision on door
- External welded-on mounting brackets for easy installation
- Oil-resistant gasket
- Weldnuts provided for mounting optional panels and terminal block kits in size 6.00 x 4.00 in. (152 x 102 mm) and larger

**FINISH**

ANSI 61 gray polyester powder paint inside and out

**ACCESSORIES**

 Panels for Junction Boxes  
 Clamp Kits  
 Fast-Operating Clamp-Cover Junction Box Clamp  
 Lock Kit for Clamp Cover Junction Boxes  
 Junction Box and Wall-Mount Enclosure Swing Out Panel Kit  
 Hole Seals

**MODIFICATION AND CUSTOMIZATION**

Hoffman excels at modifying and customizing products to your specifications. Contact your local Hoffman sales office or distributor for complete information.

**BULLETIN: A51CH**

## Standard Product

Catalog Number	AxBxC in./mm	Gauge	UL Listed	Panel	Conductive Panel	Panel Size D x E in./mm	Mounting G x H in./mm	Overall L x W in./mm	F in./mm	J in./mm	K in./mm	P in./mm	T in./mm	V in./mm	Y in./mm
A404CH	4.00 x 4.00 x 3.00 102 x 102 x 76	16	508A	No Panel	No Panel	No Panel	4.75 x 2.00 121 x 51	5.50 x 4.94 140 x 125	—	2.62 66	0.54 14	1.38 35	3.00 76	—	—
A604CH	6.00 x 4.00 x 3.00 152 x 102 x 76	16	508A	A6P4	A6P4G	4.88 x 2.88 124 x 73	6.75 x 2.00 171 x 51	7.50 x 4.94 191 x 125	2.53 64	2.62 66	0.54 14	2.38 60	3.00 76	0.31 8	0.56 14
A806CH	8.00 x 6.00 x 3.50 203 x 152 x 89	14	50, 50E	A8P6	A8P6G	6.75 x 4.88 171 x 124	8.75 x 4.00 222 x 102	9.50 x 6.94 241 x 176	3.03 77	3.12 79	0.56 14	2.38 60	5.00 127	0.25 6	0.62 16
A8063CHS	8.00 x 6.00 x 3.50 203 x 152 x 89	14	50, 50E	A8P6	A8P6G	6.75 x 4.88 171 x 124	8.75 x 4.00 222 x 102	9.50 x 6.94 241 x 176	3.03 77	3.12 79	0.56 14	2.38 60	5.00 127	0.25 6	0.62 16
A4044CH	4.00 x 4.00 x 4.00 102 x 102 x 102	16	508A	No Panel	No Panel	No Panel	4.75 x 2.00 121 x 51	5.50 x 4.94 140 x 125	—	3.62 92	0.54 14	1.38 35	3.00 76	—	—
A6044CH	6.00 x 4.00 x 4.00 152 x 102 x 102	16	508A	A6P4	A6P4G	4.88 x 2.88 124 x 73	6.75 x 2.00 171 x 51	7.50 x 4.94 191 x 125	3.53 90	3.62 92	0.54 14	2.38 60	3.00 76	0.31 8	0.56 14
A606CH	6.00 x 6.00 x 4.00 152 x 152 x 102	16	50, 50E	A6P6	A6P6G	4.88 x 4.88 124 x 73	6.75 x 4.00 171 x 102	7.50 x 6.94 191 x 176	3.53 90	3.62 92	0.54 14	2.38 60	5.00 127	0.31 8	0.56 14
A808CH	8.00 x 8.00 x 4.00 203 x 203 x 102	14	50, 50E	A8P8	A8P8G	6.75 x 6.88 171 x 175	8.75 x 6.00 222 x 152	9.50 x 8.94 241 x 227	3.53 90	3.62 92	0.56 14	1.00 25	7.00 178	0.25 6	0.62 16
A12044CH	12.00 x 6.00 x 4.00 305 x 152 x 102	14	50, 50E	A12P6	A12P6G	10.75 x 4.88 273 x 124	12.75 x 4.00 324 x 102	13.50 x 6.94 343 x 176	3.53 90	3.62 92	0.56 14	1.00 25	5.00 127	0.25 6	0.62 16
A1008CH	10.00 x 8.00 x 4.00 254 x 203 x 102	14	50, 50E	A10P8	A10P8G	8.75 x 6.88 222 x 175	10.75 x 6.00 273 x 152	11.50 x 8.94 292 x 227	3.53 90	3.62 92	0.56 14	1.00 25	7.00 178	0.25 6	0.62 16
A1008CHS	10.00 x 8.00 x 4.00 254 x 203 x 102	14	50, 50E	A10P8	A10P8G	8.75 x 6.88 222 x 175	10.75 x 6.00 273 x 152	11.50 x 8.94 292 x 227	3.53 90	3.62 92	0.56 14	1.00 25	7.00 178	0.25 6	0.62 16
A1210CH	12.00 x 10.00 x 5.00 305 x 254 x 127	14	50, 50E	A12P10	A12P10G	10.75 x 8.88 273 x 226	12.75 x 8.00 324 x 203	13.50 x 10.94 343 x 278	4.53 115	4.62 117	0.56 14	1.00 25	9.00 229	0.25 6	0.62 16
A1210CHS	12.00 x 10.00 x 5.00 305 x 254 x 127	14	50, 50E	A12P10	A12P10G	10.75 x 8.88 273 x 226	12.75 x 8.00 324 x 203	13.50 x 10.94 343 x 278	4.53 115	4.62 117	0.56 14	1.00 25	9.00 229	0.25 6	0.62 16
A8066CH	8.00 x 6.00 x 6.00 203 x 152 x 152	14	50, 50E	A8P6	A8P6G	6.75 x 4.88 171 x 124	8.75 x 4.00 222 x 102	9.50 x 6.94 241 x 176	5.53 140	5.62 143	0.56 14	1.00 25	5.00 127	0.25 6	0.62 16
A8086CH	8.00 x 8.00 x 6.00 203 x 203 x 152	14	50, 50E	A8P8	A8P8G	6.75 x 6.88 171 x 175	8.75 x 6.00 222 x 152	9.50 x 8.94 241 x 227	5.53 140	5.62 143	0.56 14	1.00 25	7.00 178	0.25 6	0.62 16
A10086CH	10.00 x 8.00 x 6.00 254 x 203 x 152	14	50, 50E	A10P8	A10P8G	8.75 x 6.88 222 x 175	10.75 x 6.00 273 x 152	11.50 x 8.94 292 x 227	5.53 140	5.62 143	0.56 14	1.00 25	7.00 178	0.25 6	0.62 16
A14086CH	14.00 x 8.00 x 6.00 356 x 203 x 152	14	50, 50E	A14P8	A14P8G	12.75 x 6.88 324 x 175	14.75 x 6.00 375 x 152	15.50 x 8.94 394 x 227	5.53 140	5.62 143	0.56 14	1.00 25	7.00 178	0.25 6	0.62 16
A10106CH	10.00 x 10.00 x 6.00 254 x 254 x 152	14	50, 50E	A10P10	A10P10G	8.75 x 8.88 222 x 226	10.75 x 8.00 273 x 203	11.50 x 10.94 292 x 278	5.53 140	5.62 143	0.56 14	1.00 25	9.00 229	0.25 6	0.62 16
A16106CH	16.00 x 10.00 x 6.00 406 x 254 x 152	14	50, 50E	A16P10	A16P10G	14.75 x 8.88 375 x 226	16.75 x 8.00 425 x 203	17.50 x 10.94 445 x 278	5.53 140	5.62 143	0.56 14	1.00 25	9.00 229	0.25 6	0.62 16
A1212CH	12.00 x 12.00 x 6.00 305 x 305 x 152	14	50, 50E	A12P12	A12P12G	10.75 x 10.88 273 x 276	12.75 x 10.00 324 x 254	13.50 x 12.94 343 x 329	5.53 140	5.62 143	0.56 14	1.00 25	11.00 279	0.25 6	0.62 16

Catalog Number	AxBxC in./mm	Gauge	UL Listed	Panel	Conductive Panel	Panel Size D x E in./mm	Mounting C x H in./mm	Overall L x W in./mm	F in./mm	J in./mm	K in./mm	P in./mm	T in./mm	V in./mm	Y in./mm
A1412CH	14.00 x 12.00 x 6.00 356 x 305 x 152	14	50, 50E	A14P12	A14P12G	12.75 x 10.88 324 x 276	14.75 x 10.00 375 x 254	15.50 x 12.94 394 x 329	5.53 140	5.62 143	0.56 14	1.00 25	11.00 279	0.25 6	0.62 16
A1412CHS	14.00 x 12.00 x 6.00 356 x 305 x 152	14	50, 50E	A14P12	A14P12G	12.75 x 10.88 324 x 276	14.75 x 10.00 375 x 254	15.50 x 12.94 394 x 329	5.53 140	5.62 143	0.56 14	1.00 25	11.00 279	0.25 6	0.62 16
A1614CH	16.00 x 14.00 x 6.00 406 x 356 x 152	14	50, 50E	A16P14	A16P14G	14.75 x 12.88 375 x 327	16.75 x 12.00 425 x 305	17.50 x 14.94 445 x 379	5.53 140	5.62 143	0.56 14	1.00 25	13.00 330	0.25 6	0.62 16
A1614CHS	16.00 x 14.00 x 6.00 406 x 356 x 152	14	50, 50E	A16P14	A16P14G	14.75 x 12.88 375 x 327	16.75 x 12.00 425 x 305	17.50 x 14.94 445 x 379	5.53 140	5.62 143	0.56 14	1.00 25	13.00 330	0.25 6	0.62 16
A10108CH	10.00 x 10.00 x 8.00 254 x 254 x 203	14	50, 50E	A10P10	A10P10G	8.75 x 8.88 222 x 226	10.75 x 8.00 273 x 203	11.50 x 10.94 292 x 278	5.53 140	5.62 143	0.56 14	1.00 25	9.00 229	0.25 6	0.62 16
A12108CH	12.00 x 10.00 x 8.00 305 x 254 x 203	14	50, 50E	A12P10	A12P10G	10.75 x 8.88 273 x 226	12.75 x 8.00 324 x 203	13.50 x 10.94 343 x 278	7.53 191	7.62 194	0.56 14	1.00 25	9.00 229	0.25 6	0.62 16
A14128CH	14.00 x 12.00 x 8.00 356 x 305 x 203	14	50, 50E	A14P12	A14P12G	12.75 x 10.88 324 x 276	14.75 x 10.00 375 x 254	15.50 x 12.94 394 x 329	7.53 191	7.62 194	0.56 14	1.00 25	11.00 279	0.25 6	0.62 16
A16148CH	16.00 x 14.00 x 8.00 406 x 356 x 203	14	50, 50E	A16P14	A16P14G	14.75 x 12.88 375 x 327	16.75 x 12.00 425 x 305	17.50 x 14.94 445 x 379	7.53 191	7.62 194	0.56 14	1.00 25	13.00 330	0.25 6	0.62 16
A161410CH	16.00 x 14.00 x 10.00 406 x 356 x 254	14	50, 50E	A16P14	A16P14G	14.75 x 12.88 375 x 327	16.75 x 12.00 425 x 305	17.50 x 14.94 445 x 379	9.53 242	9.62 244	0.56 14	1.00 25	13.00 330	0.25 6	0.62 16

Catalog numbers ending in "S" are hinged on short side.

Purchase panels separately. Optional stainless steel, conductive, composite and aluminum panels are available for most sizes.

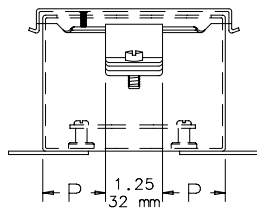
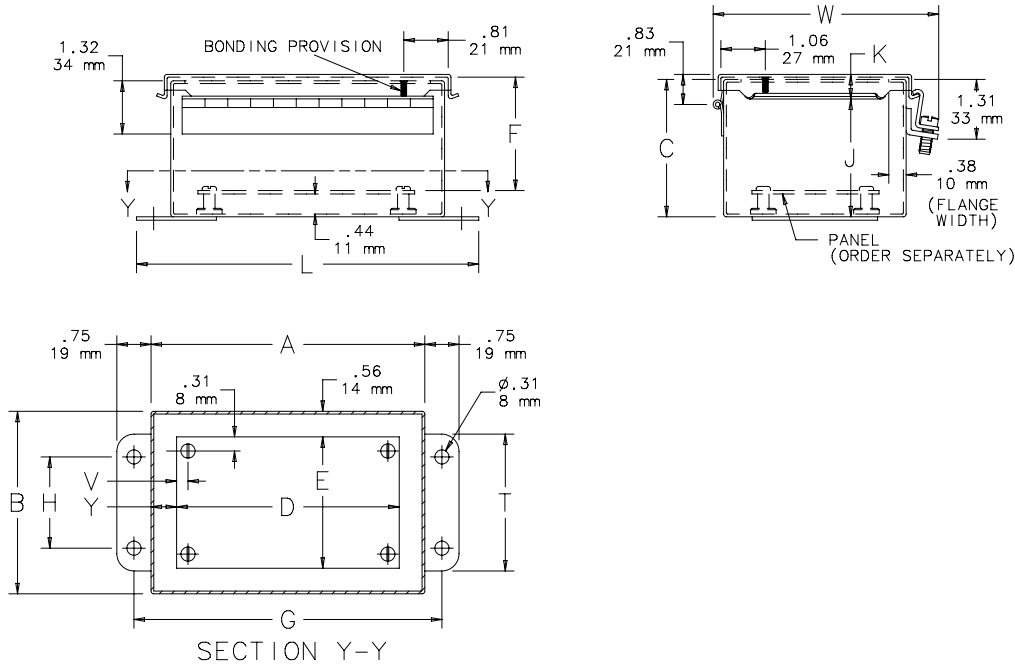

View showing clamp end of box when one clamp is used.

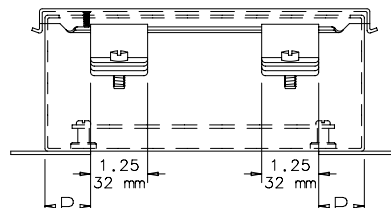

View showing clamp end of box when two clamps are used. When A=8.00 (203mm) or more, use two clamps.

C2476-C