



**Blank - Box Mounted**

Description	Material	Catalog No.	Colors		
1-Gang	Nylon	□ 5129__	A, B, BK, GY, LA, V, W		•
	Thermoset	□ 2129__	A, B, LA, V, W		•
	302/304 Stainless Steel	□ 93151	—		•
	REPEL, 302/304 Stainless Steel	□ 93151AM	—	•	•
	Brass	□ 94151	—		•
2-Gang	Nylon	□ 5137__	A, B, BK, GY, LA, V, W		•
	Thermoset	□ 2137__	A, B, LA, V, W		•
	302/304 Stainless Steel,	□ 93152	—		•
	REPEL, 302/304 Stainless Steel	□ 93152AM	—	•	•
3-Gang	302/304 Stainless Steel	□ 93153	—		•
	REPEL, 302/304, Stainless Steel	□ 93153AM	—	•	•
4-Gang	302/304 Stainless Steel	□ 93154	—		•
	REPEL, 302/304 Stainless Steel	□ 93154AM	—	•	•



1-Gang

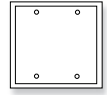

2-Gang

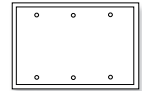

3-Gang

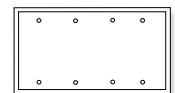

4-Gang

**Louver**

Description	Material	Catalog No.	
Horizontal	302/304 Stainless Steel	□ 93630	•
Vertical	302/304 Stainless Steel	□ 93631	•

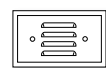

93630

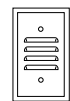



93631

**Color Ordering Information**

For ordering wallplates, include Cat. No. followed by the color code: A (Almond), B (Brown), BK (Black), BL (Blue), GY (Gray), LA (Light Almond), RD (Red), RN (Orange), V (Ivory), W (White)

**Icon Key**

-  NAFTA Compliant - see page O-30
-  REPEL Wallplates - see page J-1

**Certifications**

2000 series wallplates are cULus certified  
 5000 series wallplates are cULus certified  
 90000 series wallplates are UL and CSA certified

**Specification Information:**

Wallplates: J-21

## Mounting Holes for Wallplates and Covers

These are the most common nominal spacings for mounting holes on wallplates and covers. Holes are normally countersunk for oval head #6-32 screws.

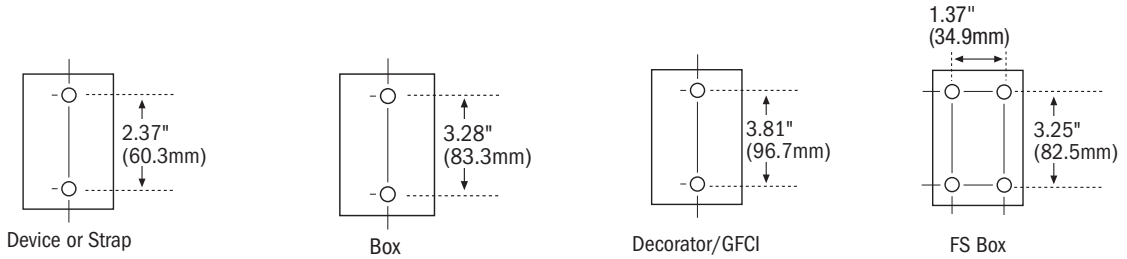

## Plate and Cover Opening Dimensions

### Cover Openings

Nominal dimensions for plate and cover openings conform to industry standards and practices.

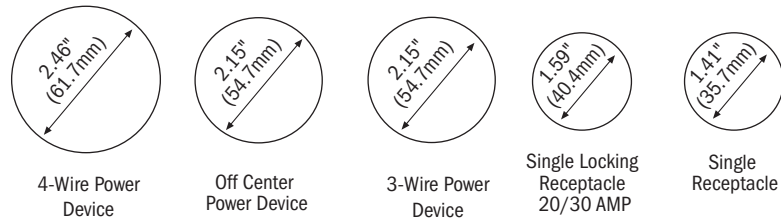

### Common Opening Configurations

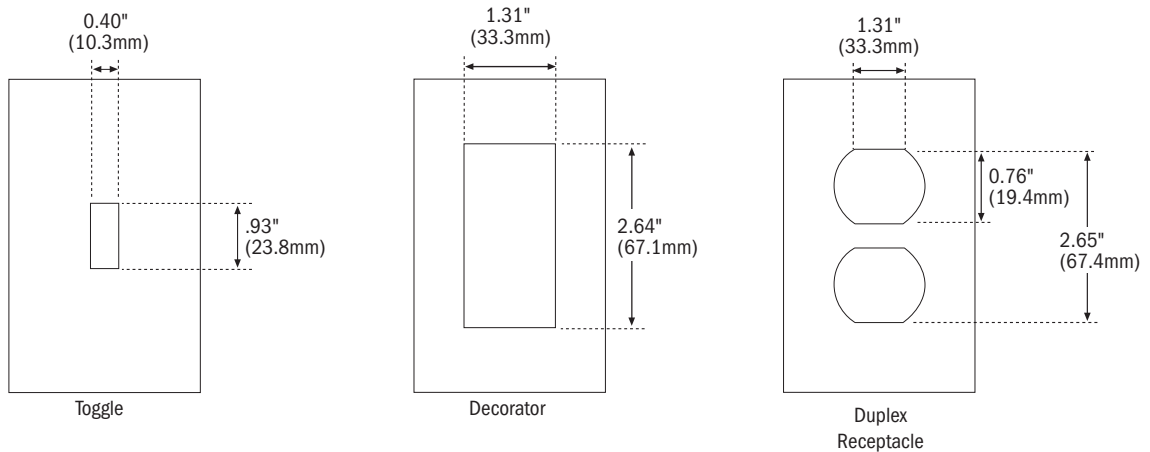

## Wallplate Sizes

Description		Height	Width	First Gang to Edge	Gang to Gang
1-Gang	Standard	4.50" (114.3mm)	2.75" (69.8mm)	1.37" (34.9mm)	—
	Mid-Size	4.87" (123.8mm)	3.12" (79.4mm)	1.56" (39.7mm)	—
	Oversize	5.25" (133.3mm)	3.50" (88.9mm)	1.75" (44.4mm)	—
2-Gang	Standard	4.50" (114.3mm)	4.56" (115.9mm)	1.37" (34.9mm)	1.81" (46.0mm)
	Mid-Size	4.87" (123.8mm)	4.94" (125.4mm)	1.56" (39.7mm)	1.81" (46.0mm)
	Oversize	5.25" (133.3mm)	5.31" (134.9mm)	1.75" (44.4mm)	1.81" (46.0mm)
3-Gang	Standard	4.50" (114.3mm)	6.37" (161.9mm)	1.37" (34.9mm)	1.81" (46.0mm)
	Mid-Size	4.87" (123.8mm)	6.75" (171.4mm)	1.56" (39.7mm)	1.81" (46.0mm)
	Oversize	5.25" (133.4mm)	7.17" (182.2mm)	1.75" (44.4mm)	1.81" (46.1mm)
4-Gang	Standard	4.50" (114.3mm)	8.19" (207.9mm)	1.37" (34.9mm)	1.81" (46.0mm)
	Mid-Size	4.87" (123.8mm)	8.56" (217.5mm)	1.56" (39.7mm)	1.81" (46.0mm)
	Oversize	5.25" (133.3mm)	8.94" (227.0mm)	1.75" (44.4mm)	1.81" (46.0mm)
5-Gang	Standard	4.50" (114.3mm)	10.00" (254.0mm)	1.37" (34.9mm)	1.81" (46.0mm)
	Mid-Size	4.87" (123.8mm)	10.37" (263.5mm)	1.56" (39.7mm)	1.81" (46.0mm)
6-Gang	Standard	4.50" (114.3mm)	11.81" (300.0mm)	1.37" (34.9mm)	1.81" (46.0mm)
	Mid-Size	4.87" (123.8mm)	12.18" (309.5mm)	1.56" (39.7mm)	1.81" (46.0mm)

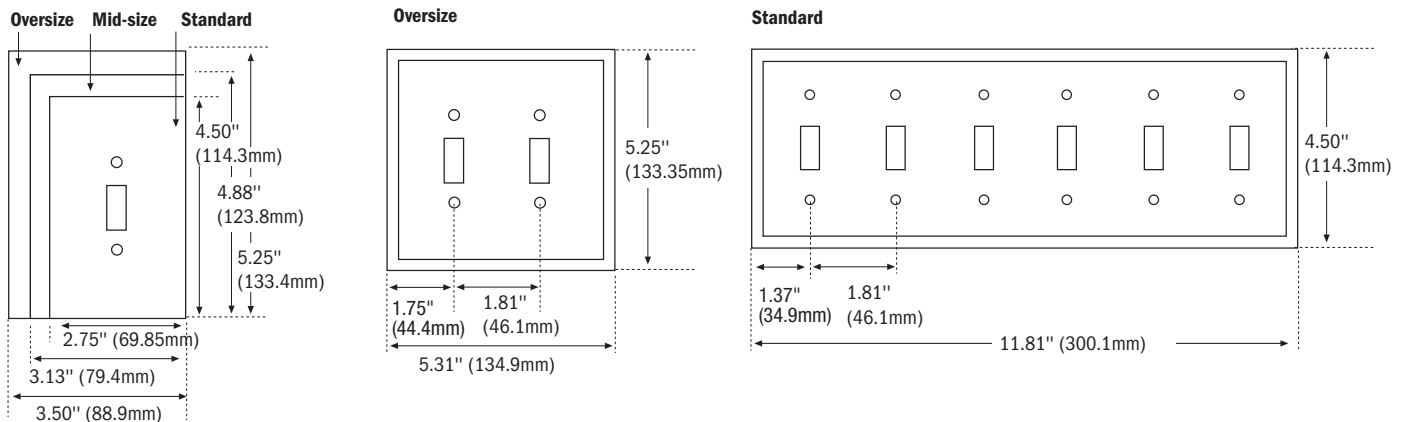



# Wallplates

Standard Size  
Mid-Size  
Oversize  
REPEL

	Wallplate Type	Standard Size, Mid-Sized & Oversize Wallplates				REPEL	
		Material Type	Material Type	Material Type	Material Type	REPEL Polycarbonate Mid-Sized Wallplates PJ_AM and PJS_AM Series	REPEL Stainless Steel Standard Size Wallplates 93070_AM, 93090_AM, 93100_AM, 93400_AM Series
	Manufacturing Process	Injection Molded	Injection Molded	Stamped	Injection Molded	Injection Molded	Stamped
	Testing & Code Compliance	UL Listed to UL 514D, file no. E33216	UL Listed to UL 514D, file no. E33216	UL Listed to UL 514D, file no. E92003	UL Listed to UL 514D, file no. E33216	UL Listed to UL 514D, file no. E33216	UL Listed to UL 514D, file no. E92003
		cUL certified to C22.2, no. 42.1, UL file E33216	cUL certified to C22.2, no. 42.1, UL file E33216	CSA certified to C22.2, no. 42.1	cUL, UL file E33216 certified to C22.2, no. 42.1	Agion® Antimicrobial Additive: EPA approved for use as product ingredient  PJ_AM only: cUL Listed to CSA C22.2, no 42.1, file no. E33216	Agion® Antimicrobial Additive: EPA approved for use as product ingredient  CSA certified to C22.2, no. 42.1
Specifications: Environmental	Flammability	Meets UL 94 requirements; 5V rated	Meets UL 94 requirements; 5V rated	N/A	Meets UL 94 requirements 5VA rated	Meets UL 94 requirements; 5V rated	N/A
	Temperature Rating	-40°C to 90°C (-40°F to 194°F)	-40°C to 70°C (-40°F to 158°F)	-40°C to 70°C (-40°F to 158°F)	-40° to 70° C (-40°F to 158°F)	-40°C to 70°C (-40°F to 158°F)	-40°C to 70°C (-40°F to 158°F)
Materials:	Body	0.080" thick thermoset urea or phenolic	0.060" thick thermoplastic	0.032" thick stainless steel alloy, 18% chromium and 8% nickel for corrosion resistance	0.08" thick thermoplastic polycarbonate	0.071" thick polycarbonate with Agion® Antimicrobial Additive incorporated	0.032" thick 302/304 stainless steel alloy, 18% chromium and 8% nickel for corrosion resistance, DuPont® Alesta® powder coating with Agion® Antimicrobial incorporated
	Inner Wallplate	N/A	N/A	N/A	0.071" thick polycarbonate	PJS_AM only: 0.071" thick polycarbonate	N/A

NOTE: REPEL products do not protect the user against disease causing organisms and ongoing regular cleaning practices should be maintained. Agion is a registered trademark of Agion Technologies, Inc., Wakefield, MA

**Blank - Box Mounted**

Description	Material	Catalog No.	Colors		
1-Gang	Nylon	□ 5129__	A, B, BK, GY, LA, V, W		•
	Thermoset	□ 2129__	A, B, LA, V, W		•
	302/304 Stainless Steel	□ 93151	—		•
	REPEL, 302/304 Stainless Steel	□ 93151AM	—	•	•
	Brass	□ 94151	—		•
2-Gang	Nylon	□ 5137__	A, B, BK, GY, LA, V, W		•
	Thermoset	□ 2137__	A, B, LA, V, W		•
	302/304 Stainless Steel,	□ 93152	—		•
	REPEL, 302/304 Stainless Steel	□ 93152AM	—	•	•
3-Gang	302/304 Stainless Steel	□ 93153	—		•
	REPEL, 302/304, Stainless Steel	□ 93153AM	—	•	•
4-Gang	302/304 Stainless Steel	□ 93154	—		•
	REPEL, 302/304 Stainless Steel	□ 93154AM	—	•	•



1-Gang

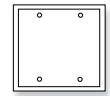

2-Gang

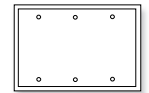

3-Gang

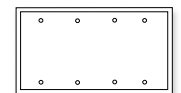

4-Gang

**Louver**

Description	Material	Catalog No.	
Horizontal	302/304 Stainless Steel	□ 93630	•
Vertical	302/304 Stainless Steel	□ 93631	•

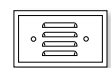

93630

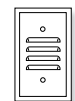



93631

**Color Ordering Information**

For ordering wallplates, include Cat. No. followed by the color code: A (Almond), B (Brown), BK (Black), BL (Blue), GY (Gray), LA (Light Almond), RD (Red), RN (Orange), V (Ivory), W (White)

**Icon Key**

-  NAFTA Compliant - see page O-30
-  REPEL Wallplates - see page J-1

**Certifications**

2000 series wallplates are cULus certified  
 5000 series wallplates are cULus certified  
 90000 series wallplates are UL and CSA certified

**Specification Information:**

Wallplates: J-21

## Mounting Holes for Wallplates and Covers

These are the most common nominal spacings for mounting holes on wallplates and covers. Holes are normally countersunk for oval head #6-32 screws.

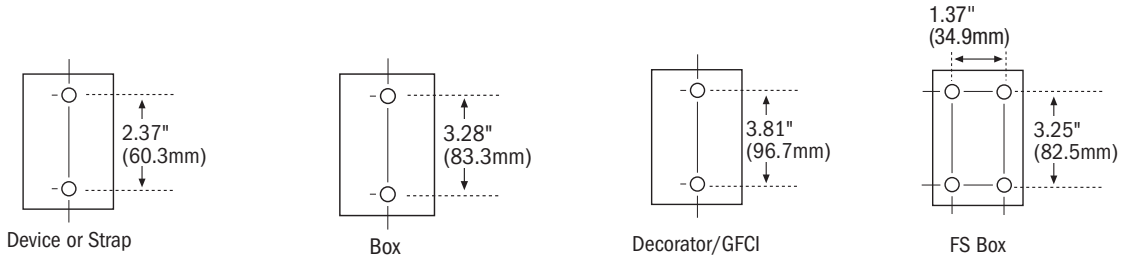

## Plate and Cover Opening Dimensions

### Cover Openings

Nominal dimensions for plate and cover openings conform to industry standards and practices.

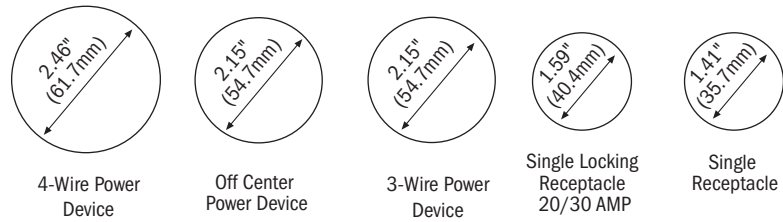

### Common Opening Configurations

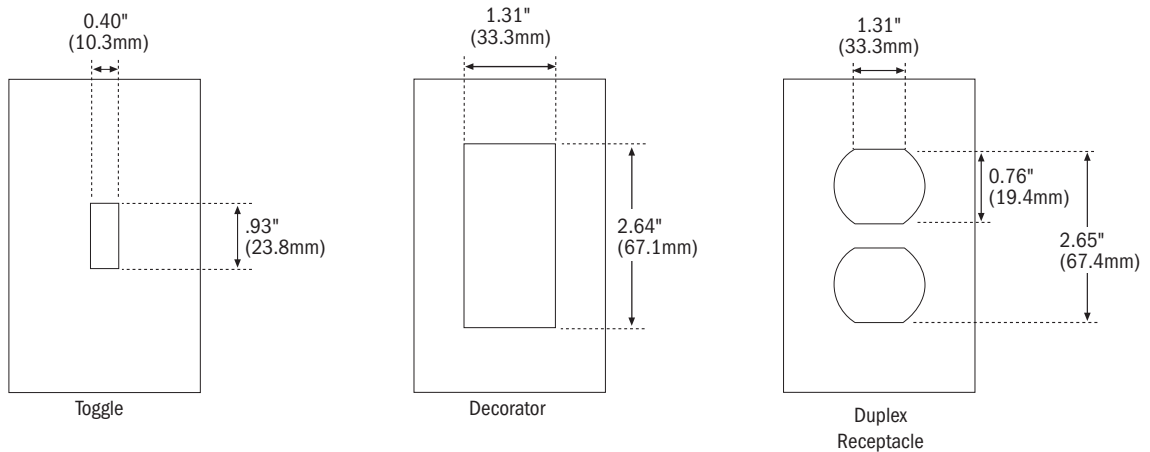

## Wallplate Sizes

Description		Height	Width	First Gang to Edge	Gang to Gang
1-Gang	Standard	4.50" (114.3mm)	2.75" (69.8mm)	1.37" (34.9mm)	—
	Mid-Size	4.87" (123.8mm)	3.12" (79.4mm)	1.56" (39.7mm)	—
	Oversize	5.25" (133.3mm)	3.50" (88.9mm)	1.75" (44.4mm)	—
2-Gang	Standard	4.50" (114.3mm)	4.56" (115.9mm)	1.37" (34.9mm)	1.81" (46.0mm)
	Mid-Size	4.87" (123.8mm)	4.94" (125.4mm)	1.56" (39.7mm)	1.81" (46.0mm)
	Oversize	5.25" (133.3mm)	5.31" (134.9mm)	1.75" (44.4mm)	1.81" (46.0mm)
3-Gang	Standard	4.50" (114.3mm)	6.37" (161.9mm)	1.37" (34.9mm)	1.81" (46.0mm)
	Mid-Size	4.87" (123.8mm)	6.75" (171.4mm)	1.56" (39.7mm)	1.81" (46.0mm)
	Oversize	5.25" (133.4mm)	7.17" (182.2mm)	1.75" (44.4mm)	1.81" (46.1mm)
4-Gang	Standard	4.50" (114.3mm)	8.19" (207.9mm)	1.37" (34.9mm)	1.81" (46.0mm)
	Mid-Size	4.87" (123.8mm)	8.56" (217.5mm)	1.56" (39.7mm)	1.81" (46.0mm)
	Oversize	5.25" (133.3mm)	8.94" (227.0mm)	1.75" (44.4mm)	1.81" (46.0mm)
5-Gang	Standard	4.50" (114.3mm)	10.00" (254.0mm)	1.37" (34.9mm)	1.81" (46.0mm)
	Mid-Size	4.87" (123.8mm)	10.37" (263.5mm)	1.56" (39.7mm)	1.81" (46.0mm)
6-Gang	Standard	4.50" (114.3mm)	11.81" (300.0mm)	1.37" (34.9mm)	1.81" (46.0mm)
	Mid-Size	4.87" (123.8mm)	12.18" (309.5mm)	1.56" (39.7mm)	1.81" (46.0mm)

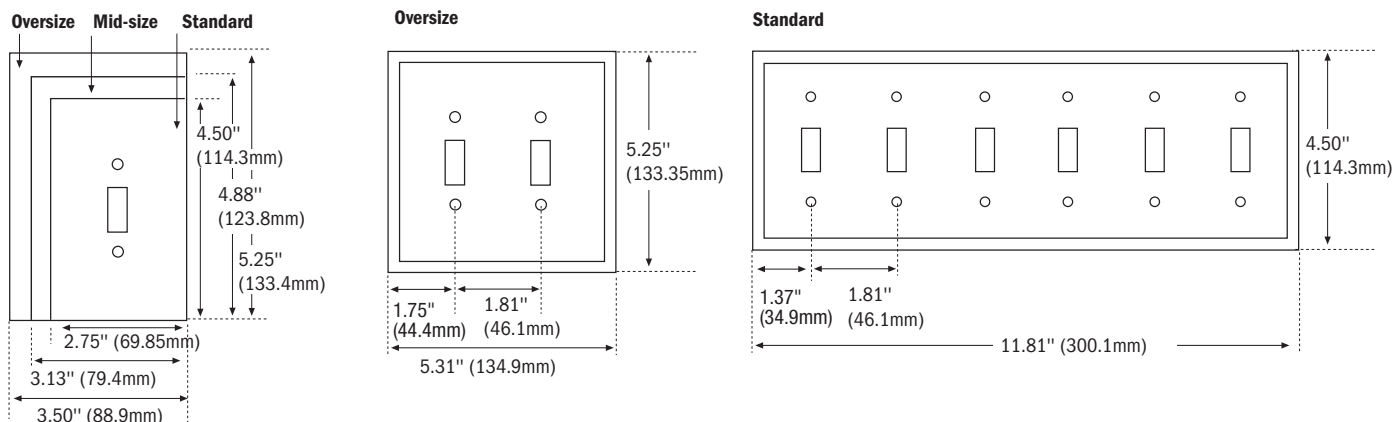

Wallplates

Standard Size  
Mid-Size  
Oversize  
REPEL

	Wallplate Type	Standard Size, Mid-Sized & Oversize Wallplates				REPEL	
		Material Type	Material Type	Material Type	Material Type	REPEL Polycarbonate Mid-Sized Wallplates PJ_AM and PJS_AM Series	REPEL Stainless Steel Standard Size Wallplates 93070_AM, 93090_AM, 93100_AM, 93400_AM Series
	Manufacturing Process	Injection Molded	Injection Molded	Stamped	Injection Molded	Injection Molded	Stamped
	Testing & Code Compliance	UL Listed to UL 514D, file no. E33216	UL Listed to UL 514D, file no. E33216	UL Listed to UL 514D, file no. E92003	UL Listed to UL 514D, file no. E33216	UL Listed to UL 514D, file no. E33216	UL Listed to UL 514D, file no. E92003
		cUL certified to C22.2, no. 42.1, UL file E33216	cUL certified to C22.2, no. 42.1, UL file E33216	CSA certified to C22.2, no. 42.1	cUL, UL file E33216 certified to C22.2, no. 42.1	Agion® Antimicrobial Additive: EPA approved for use as product ingredient  PJ_AM only: cUL Listed to CSA C22.2, no 42.1, file no. E33216	Agion® Antimicrobial Additive: EPA approved for use as product ingredient  CSA certified to C22.2, no. 42.1
Specifications: Environmental	Flammability	Meets UL 94 requirements; 5V rated	Meets UL 94 requirements; 5V rated	N/A	Meets UL 94 requirements 5VA rated	Meets UL 94 requirements; 5V rated	N/A
	Temperature Rating	-40°C to 90°C (-40°F to 194°F)	-40°C to 70°C (-40°F to 158°F)	-40°C to 70°C (-40°F to 158°F)	-40° to 70° C (-40°F to 158°F)	-40°C to 70°C (-40°F to 158°F)	-40°C to 70°C (-40°F to 158°F)
Materials:	Body	0.080" thick thermoset urea or phenolic	0.060" thick thermoplastic	0.032" thick stainless steel alloy, 18% chromium and 8% nickel for corrosion resistance	0.08" thick thermoplastic polycarbonate	0.071" thick polycarbonate with Agion® Antimicrobial Additive incorporated	0.032" thick 302/304 stainless steel alloy, 18% chromium and 8% nickel for corrosion resistance, DuPont® Alesta® powder coating with Agion® Antimicrobial incorporated
	Inner Wallplate	N/A	N/A	N/A	0.071" thick polycarbonate	PJS_AM only: 0.071" thick polycarbonate	N/A

NOTE: REPEL products do not protect the user against disease causing organisms and ongoing regular cleaning practices should be maintained. Agion is a registered trademark of Agion Technologies, Inc., Wakefield, MA