



Metalux lighting solutions are designed to suit even the most discerning taste. Metalux offers an extensive line of fluorescent and LED lighting products including parabolics, lensed, recessed, surface, strip and industrial fixtures.

Metalux



Heavy-gauge steel construction, durable finishes and high-quality electrical assemblies ensure years of performance integrity for commercial, educational, retail and healthcare settings. Metalux also offers an energy-efficient residential line available in an array of styles and sizes for general, cove, task and undercabinet needs.

SEE PAGE 7-113 FOR NEW PRODUCTS.



ARCHITECTURAL



Accord LED Series
Page 7-5



AC Accord Series
Page 7-6



2ACS Accord Series
Page 7-7



AC2 Accord II Series
Page 7-8



ArcLine Series
Page 7-9



RDIA Ovation Series
Page 7-10



RDI, 2RDI Ovation Series
Page 7-11



RWW Series
Page 7-13

INDUSTRIALS



Cricket SM, SML Series
Page 7-14



F-Bay HBI Series
Page 7-15



F-Bay HBE Series
Page 7-16



F-Bay HBL Series
Page 7-17



F-Bay 2HBG Series
Page 7-18



F-Bay 2HBHD Series
Page 7-19



F-Bay 2HBHT Series
Page 7-20



ABI Arctic Bay Series
Page 7-21



F-Bay I5 Series
Page 7-22



F-Bay I8 Series
Page 7-23



F-Bay MBF Micro-Bay Series
Page 7-24



Vaportite LED Series
Page 7-25



VT4 Series
Page 7-26



VT3 Series
Page 7-27



VT1 Series
Page 7-28



IAF, ICF Series
Page 7-29

PARABOLICS



DIF Series
Page 7-30



DMF Series
Page 7-31



DVMF Series
Page 7-32



OpticaHP Series
Page 7-33



2HP2 Series
Page 7-34



2HP3 Series
Page 7-35



2EP3GAX Series
Page 7-36



2P2GAX Series
Page 7-37

RESIDENTIAL



2PGAX Series
Page 7-38



2P5GAX Series
Page 7-39



P3 Series
Page 7-40



PMX Series
Page 7-41



Shop Light Series
Page 7-42



Circline Decorative Series
Page 7-43



Circline Utility Series
Page 7-43



Decorative Series
Page 7-44



Small Circline Decorative Series
Page 7-45



Wall Bracket, Undercabinet Series
Page 7-46



WP Series
Page 7-47



Wraparound Oak Trim Series
Page 7-48



WSC Series
Page 7-49

SEE PAGE 7-113 FOR NEW PRODUCTS.

RETROFIT



Industrial Retrofit Kit (ECS)
Page 7-50

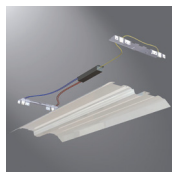

Commercial Retrofit Kit (ART)
Page 7-51

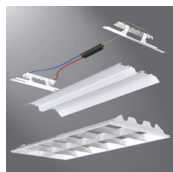

OpticalHP Retrofit Kit (ART)
Page 7-52

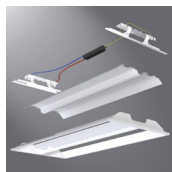

ArcDuo, Cruze Retrofit Kits (ART)
Page 7-53

STRIPS



RCG Series
Page 7-54



SNF Series
Page 7-55



SSF Series
Page 7-57



SMF Series
Page 7-59

SURFACE



SNL, SSL Series
Page 7-60



SNSM, SNRA, SMSL Series
Page 7-61



M Series
Page 7-62



SA Series
Page 7-63

TROFFER



GC Series
Page 7-64



GC8 Series
Page 7-65



GR5 Series
Page 7-66



GR8 Series
Page 7-67

WALL - UNDERCABINET



GCAFA Series
Page 7-68



2GCAML Series
Page 7-69



BA, BAU Series
Page 7-70



BE, BEU Series
Page 7-71



BC Series
Page 7-72



BI, BIU Series
Page 7-73



CL, UC Series
Page 7-74

WRAPS



CR Series
Page 7-75



WN Series
Page 7-76



WS Series
Page 7-77



WSC Series
Page 7-78

OPTIONS AND ACCESSORIES

Commitment Kit (CKIT) Accessory..... 7-79
 Louver and Lens Options..... 7-80
 Ceiling Compatibility..... 7-81
 Drywall Framing Kit (DF) Series Options..... 7-83
 Standard Product Options and Accessories..... 7-84
 Parabolic, Recessed and Surface Options and Accessories..... 7-85
 Lamp Options..... 7-87
 Emergency Options - Parabolics and Recessed..... 7-88
 Emergency Surface Options..... 7-89
 Strips - Industrials Emergency Options..... 7-90
 Extended Options..... 7-91
 Strip Reflector Accessories..... 7-93
 Strips and Industrials Options and Accessories..... 7-96
 F-Bay Mounting Accessories..... 7-99
 F-Bay Mounting Methods..... 7-100
 F-Bay Occupancy Sensors..... 7-101
 F-Bay Power Connections..... 7-102
 F-Bay I5, I8 Door Frames and Wireguards..... 7-103
 F-Bay HBI, HBL, HBE Door Frames and Wireguards..... 7-104
 Strips and Industrials Extended Options..... 7-105
 Strips and Industrials Packaging Options..... 7-106
 Master - Satellite Wiring Options..... 7-107
 Wiring Options..... 7-108
 MWS Wiring Options..... 7-109
 Tandem In-Line Wiring (TILW) Options..... 7-110
 Cross-over Plug-in (CPI) Options..... 7-110
 Plug-In (PI) System Options..... 7-111
 Troubleshooting Guide..... 7-112

SEE PAGE 7-113 FOR NEW PRODUCTS.

COMMERCIAL SPECIFICATION LED TROFFER



FEATURES

- Available in 1' x 4', 2' x 2' and 2' x 4' recessed versions
- Advanced optical control
- High performance efficacy up to 109 lumens per watt
- Over 45% energy savings when compared to fluorescent troffers
- Three CCT options: 3000K, 3500K and 4000K at 85 CRI
- Four stocked lumen packages offered along with multiple MTO options
- Standard 0-10V continuous dimming driver
- L70 at 50,000 hours
- Shallow depth housing (3.25") with tool-less driver access from below

DIMENSIONS

1' x 4', 2' x 2', 2' x 4'

ACCORD LED SERIES

Compliances may not apply to all product configurations. Please consult the product spec sheet for compliance details.

COMPLIANCES: UL/cUL Listed, NOM Certified, IC Rated, LM79 and/or LM80 Tested, City of Chicago Approved



ORDERING INFORMATION

SAMPLE NUMBER: 24AC-LD3-55-UNV-L835-CD1-U

Rating	Series	Type	Lamp Type	LED Lumens Output		
[Blank]=Standard ATW-SW4=Air-Tight Wire Way (Chicago Rated)	22AC=Accord Series (2' x 2') 22ACS=Accord Surface Series (2' x 2') ¹ 24AC=Accord Series (2' x 4') 24ACS=Accord Surface Series (2' x 4') ¹ AC=Accord Series (1' x 4')	[Blank]=Standard A=Air (Vented) ²	LD3=LED 3.0	1' x 4' MTO 19=1900 Lumens ³ 25=2500 Lumens ³ 29=2900 Lumens 35=3500 Lumens 39=3900 Lumens	2' x 2' Stock 23=2300 Lumens ³ 34=3400 Lumens MTO 18=1800 Lumens ³ 27=2700 Lumens 38=3800 Lumens	2' x 4' Stock 48=4800 Lumens 55=5500 Lumens MTO 31=3100 Lumens 36=3600 Lumens 39=3900 Lumens 63=6300 Lumens 68=6800 Lumens 73=7300 Lumens
Shielding	Voltage ⁴	Options ⁵		CCT	Options	
[Blank]=Frosted Acrylic (Standard) RDP=Lens with Round Pattern Insert SQP=Lens with Square Pattern Insert	UNV=Universal Voltage 120-277	Emergency EL=Emergency Installed, 700 Lumens EL14=Emergency Installed, 1400 Lumens		L830=3000K L835=3500K L840=4000K	Flex Flex=Multiple Configurations Available	
Driver Type	Number of Drivers	Packaging		Accessories (Order Separately)		
CD=0-10V Dimming Driver (Standard) 5LTD=Fifth Light (DALI) Driver ⁶	1=1 Driver	PALC=Job Pack, in Carton U=Unit Pack		EQ-CLIP-U=T-BAR Safety Earthquake Clips ⁷ T3A END E.Q. BRACKET PARTS BAG=Earthquake Brackets DF-14-W=1' x 4' Drywall Frame Kit DF-22-W=2' x 2' Drywall Frame Kit DF-24-W=2' x 4' Drywall Frame Kit		

NOTES: 1. Surface mount Accord is not designed for continuous row mount applications. 2. Must specify voltage (120V or 277V) when selecting Air option. Air versions are not designed for continuous row mount applications. 3. Not available with a Fifth Light (DALI) driver. 4. Products also available in non-US voltage and frequencies for international markets. 5. Must specify voltage (120V or 277V) when selecting EL option. 6. For a complete listing of Fifth Light Technology products and other solutions from Cooper Controls, visit www.coopercontrol.com. 7. An EQ Grid Clip is recommended for all 9/16" ceiling systems.

1' x 4' RECESSED

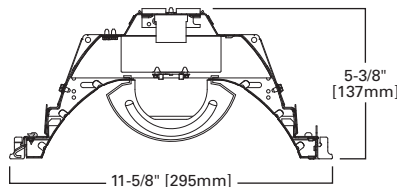

2' x 2', 2' x 4' RECESSED

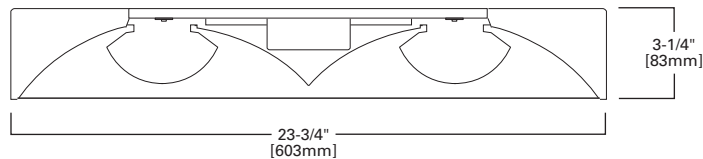

2' x 2' SURFACE

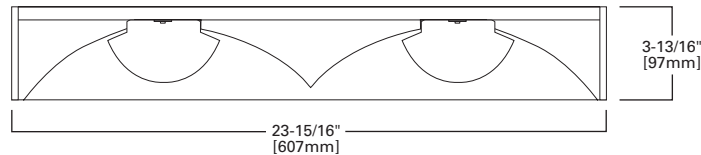

Specifications and dimensions subject to change without notice. Consult your Cooper Lighting Representative or visit www.cooperlighting.com for available options, accessories and ordering information.

FEATURES

- Improved visual perception and increased comfort levels
- Attractive contemporary design
- Significant energy savings
- T5 or T8 lamps
- Shallow depth and structural integrity for quick installation
- Remove refractor for simple lamp maintenance
- Ballast can be removed from below without tools
- Dark spots associated with parabolics eliminated

DIMENSIONS

1' x 4', 2' x 2', 2' x 4'

Compliances may not apply to all product configurations. Please consult the product spec sheet for compliance details.

COMPLIANCES: UL/cUL Listed - Damp Location, NOM Certified, IC Rated, City of Chicago Approved



AC ACCORD SERIES



ORDERING INFORMATION

SAMPLE NUMBER: 2AC-232-UNV-EB82-U

Rating	Width	Series	Type	Number of Lamps (Not Included) ⁵	Wattage (Length)	Shielding	Voltage ⁶
[Blank]=Standard ATW-SW4=Chicago Rated	2=2' Width [Blank]=1' Width ^{1,2}	AC=Accord Series	A=Air (Optional) ³ IC=IC Rated ⁴	1=1 Lamp 2=2 Lamps	14T5=14W T5 (24") 17=17WT8 (24") 24T5=24W T5HO (24") 28T5=28W T5 (48") 32=32W T8 (48") 54T5=54W T5HO Lamps (48") BX40=40W Compact Fluorescent (24")	[Blank]=Frosted Acrylic (Standard) RDP=Lens with Round Pattern Insert SQP=Lens with Square Pattern Insert	024V=24 Volt DC ⁷ 120V=120 Volt 277V=277 Volt 347V=347 Volt UNV=Universal Voltage 120-277 ^{8,9}
Options				Lamps			
EL=Emergency Installed (Must Specify Battery Pack, See Options) ⁹ Flex=Flex Installed (Reference Flex Ordering Information) GL=Single Element Fuse GM=Double Element Fuse LVDC10=Low Voltage 10 Foot DC Connector and Cable Assembly LVDC5=Low Voltage 5 Foot DC Connector and Cable Assembly				L5835=T5 Lamp, 3500K L5835HL=T5 Lamp, 28W, 3500K, 2900 Lumens L5841=T5 Lamp, 4100K L5841HL=T5 Lamp, 28W, 4100K, 2900 Lumens		L8835=T8 Lamp, 17W and 32W, 3500 K L8835HL=T8 Lamp, 32W, 3500K, 3100 Lumens L8841=T8 Lamp, 17W and 32W, 4100K L8841HL=T8 Lamp, 32W, 4100K, 3100 Lumens	
Ballast Type							
Biax Ballasts EB5_=T5 Biax Electronic Instant Start. Total Harmonic Distortion < 20%. T5 Ballasts EBT_=T5 or T5HO Electronic Program Rapid Start. Total Harmonic Distortion < 10%. Standard Ballast Factor=1.0 Ballast/Factor Type (T5) EBT_H=T5 Electronic Program Rapid Start. Total Harmonic Distortion < 10%. High Ballast Factor=1.15 ^{14,15} EBT_HDIM=T5 Electronic Program Rapid Start. Total Harmonic Distortion < 10%. Step Dimming, High Ballast Factor=1.15 ^{16,17} EBT_N=T5 Electronic Program Rapid Start. Total Harmonic Distortion < 10%. Normal Ballast Factor=.90 ¹⁵ EBT_NDIM=T5 Electronic Program Rapid Start. Total Harmonic Distortion < 10%. Step Dimming, Normal Ballast Factor=.95-1.0 ^{18,16,17} Ballast Factor/Type (For 14W T5 Lamp Only) [Blank]=Standard H=High Light Output 1.15 BF ¹⁰ HDIM=High 1.15 BF Step Dimming ¹⁰ N=Normal Light Output .95 BF ¹¹				Ballast Factor/Type (For 24VDC Only) DC5_Dim=T5 24VDC Dimming 0-10V, Ballast Factor=1.0 ¹² DC8_DIM=T8 24VDC Dimming = 0-10V, Ballast Factor=0.75 ¹³ T8 Ballasts EB8_=T8 Electronic Start. Total Harmonic Distortion < 10% EB8_/PLUS=T8 Electronic Start. Total Harmonic Distortion < 10%. High Ballast Factor > 1.15 ER8_=T8 Electronic Program Rapid Start. Total Harmonic Distortion < 10% High Performance T8 Ballasts HB8_=T8 Electronic Instant Start. Total Harmonic Distortion < 10%. Standard Ballast Factor .86 - .88 HB8_H=T8 Electronic Instant Start. Total Harmonic Distortion < 10%. High Ballast Factor 1.15 - 1.20 HB8_L=T8 Electronic Instant Start. Total Harmonic Distortion < 10%. Low Ballast Factor .77 - .82 HB8_N=T8 Electronic Instant Start. Total Harmonic Distortion < 10%. Normal Ballast Factor 1.0 HR8_=T8 Electronic Program Rapid Start. Total Harmonic Distortion < 10%. Standard Ballast Factor .86 - .88 HR8_DIM=T8 Electronic Program Rapid Start. Total Harmonic Distortion < 10%. Step Dimming, Ballast Factor .88 HR8_H=T8 Electronic Program Rapid Start. Total Harmonic Distortion < 10%. High Ballast Factor 1.15 - 1.20 HR8_L=T8 Electronic Program Rapid Start. Total Harmonic Distortion < 10%. Low Ballast Factor .71 - .79			
Number of Ballasts		Packaging	Accessories (Order Separately) ^{19,20}				
1=1 Ballast 2=2 Ballasts 3=3 Ballasts		PALC=Job Pack, in Carton U=Unit Pack	T3A END E.Q. BRACKET PARTS BAG=Earthquake Brackets				

NOTES: 1. 1' x 4' Accord is not designed for continuous row mount applications. 2. IC Rated option not available. 3. Air option is not available with 1' x 4'. 4. IC version is only available in T5 lamp fixtures. 5. Stem Mounting not available on 3-lamp fixtures. 6. Products also available in non-US voltage and frequencies for international markets. 7. 24VDC version is EMerge Alliance® Registered (available in 2 lamp version only). 8. Not available when specifying emergencies, voltage must be specified. 9. See options section. 10. Step Dimming ballast available for 2 or 3 14WT5 lamps only. 11. .95 ballast factor available for 14WT5 lamps only. 12. For Emerge 2' x 2' T5HO = one lamp ballast only. 13. For Emerge 2' x 4' T8 1.0 Ballast Factor, two ballast must be ordered. 14. 1-Lamp ballast in a High Ballast factor not available. 15. .90 ballast factor available for 2 or 3 28W T5 lamps only. 16. Step Dimming ballast available for 2 or 3 28W T5 lamps only. 17. Step dimming ballast available for 2 or 3 lamp 14WT5 lamps only. 18. 1-Lamp step dimming ballast in a Normal Ballast factor not available. 2-Lamp ballast will not operate 1-Lamp. 19. For complete product data, reference the Fluorescent Specification binder. Specifications and dimensions subject to change without notice. Consult your Cooper Lighting Representative for availability and ordering information. 20. Specifications and dimensions subject to change without notice.

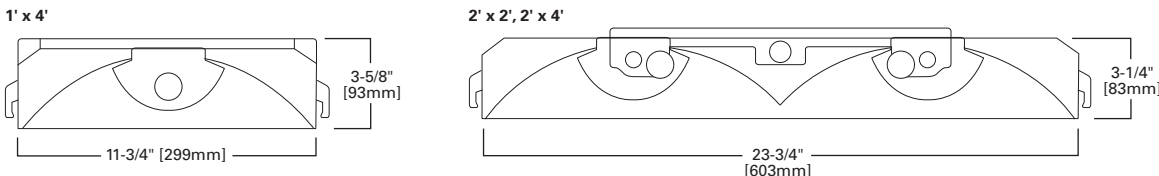

Specifications and dimensions subject to change without notice. Consult your Cooper Lighting Representative or visit www.cooperlighting.com for available options, accessories and ordering information.

SURFACE MOUNT COMMERCIAL SPECIFICATION T5 TROFFER



FEATURES

- Surface mount units designed for non-grid ceiling systems
- Low-profile housing is formed from cold rolled steel
- Class P ballasts are positively secured to housing
- Baked matte-white, polyester powder-enamel finish
- High-reflectant and luminous uniform reflector
- 2" wiring access hole for centered junction box
- Positively retained frosted acrylic profile lenses; three options
- Ballast can be removed from below without tools
- Backplate provided with knockouts and mounting holes for surface mount

DIMENSIONS

2' x 2', 2' x 4'

2ACS ACCORD SERIES

Compliances may not apply to all product configurations. Please consult the product spec sheet for compliance details.

COMPLIANCES: UL/cUL Listed - Damp Location, NOM Certified



ORDERING INFORMATION

SAMPLE NUMBER: 2ACS-228T5-UNV-L5841-EBT1-U

Width	Series	Type	Number of Lamps (Not Included)	Wattage (Length)	Shielding	Voltage ²
2=2' Width	AC=Accord Series	S=Surface Mount ¹	2=2 Lamp	14T5=14W T5 (24") 24T5=24W T5HO (24") 28T5=28W T5 (48") 54T5=54W T5HO (48")	[Blank]=Frosted Acrylic (Standard) RDP=Lens with Round Pattern Insert SQP=Lens with Square Pattern Insert	UNV=Universal Voltage 120-277
Options		Lamps	Ballast Type			
EL=Emergency Battery Installed (Must Specify Battery Pack, See Options) Flex=Flex Installed (Reference Flex Ordering Information) GL=Single Element Fuse GM=Double Element Fuse		L5835=T5 Lamp, 3500K L5835HL=T5 Lamp, 28W, 3500K, 2900 Lumens L5841=T5 Lamp, 4100K L5841HL=T5 Lamp, 28W, 4100K, 2900 Lumens	T5 Ballasts EBT=T5 of T5HO Electronic Program Rapid Start. Total Harmonic Distortion < 10%. Standard Ballast Factor=1.0 Ballast/Factor Type (T5) EBT_H=T5 Electronic Program Rapid Start. Total Harmonic Distortion < 10%. High Ballast Factor=1.15 ³ EBT_HDIM=T5 Electronic Program Rapid Start. Total Harmonic Distortion < 10%. Step Dimming, High Ballast Factor=1.15 ^{4,5} EBT_N=T5 Electronic Program Rapid Start. Total Harmonic Distortion < 10%. Normal Ballast Factor=.90 ^{6,7} EBT_NDIM=T5 Electronic Program Rapid Start. Total Harmonic Distortion < 10%. Step Dimming, Normal Ballast Factor=.95-1.0 ⁸			
Number of Ballasts		Packaging				
1=1 Ballast 2=2 Ballasts		PALC=Job Pack, in Carton U=Unit Pack				

NOTES: 1. Surface mount Accord is not designed for continuous row mount applications. 2. Products also available in non-US voltage and frequencies for international markets. 3. 1-Lamp ballast in a High Ballast factor not available. 4. Step Dimming ballast available for 2 or 3 14WT5 lamps only. 5. Step Dimming ballast available for 2 or 3 28W T5 lamps only. 6. .90 ballast factor available for 2 or 3 28W T5 lamps only. 7. .90 ballast factor available for 2 or 3 14W T5 lamps only. 8. 1-Lamp step dimming ballast in a Normal Ballast factor not available. 2-Lamp ballast will not operate 1-Lamp.

2' x 2', 2' x 4'

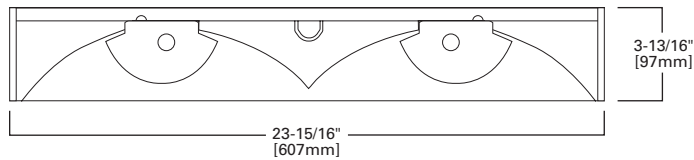

Specifications and dimensions subject to change without notice. Consult your Cooper Lighting Representative or visit www.cooperlighting.com for available options, accessories and ordering information.

FEATURES

- Attractive contemporary design
- T5 or T8 lamps
- Increases comfort levels while providing energy savings
- White or semi-specular baffle
- Shallow depth and tool-less design for quick installation
- Hinged and latched door frame for simple lamp maintenance
- Knockouts for continuous row mounting
- Large access plate for supply connection

DIMENSIONS

2' x 2', 2' x 4'

Compliances may not apply to all product configurations. Please consult the product spec sheet for compliance details.

COMPLIANCES: UL/cUL Listed - Damp Location, NOM Certified, ARRA Compliant



AC2 ACCORD II SERIES



ORDERING INFORMATION

SAMPLE NUMBER: 2AC2-228T5BI-UNV-EBT1-U

Width	Series	Number of Lamps (Not Included)	Wattage (Length)	Shielding	Voltage ¹
2=2' Width	AC2=Accord II Series	2=2 Lamps	14T5=14W T5 (24") 17=17W T8 (24") 24T5=24W T5HO (24") 28T5=28W T5 (48") 32=32W T8 (48") 54T5=54W T5HO (48")	BI=Frosted Lens and Semi-Specular Baffle BP=Frosted Lens and White Baffle	UNV=Universal Voltage 120-277
Options		Ballast Type		Number of Ballasts	Packaging
EL=Emergency Installed (Must Specify Battery Pack, See Options) Flex=Flex Installed (Reference Flex Ordering Information) GL=Single Element Fuse GM=Double Element Fuse Lamps=Lamps Installed (Refer to Lamp Ordering Options)		T5 Ballasts EBT_=T5 or T5HO Electronic Program Rapid Start. Total Harmonic Distortion < 10%. Standard Ballast Factor=1.0 Ballast Factor/Type (For 14W and 28W T5 Lamp Only) H=High Light Output 1.15 BF ² HDIM=High 1.15 BF Step Dimming ³ N=Normal Light Output .95 BF ³ NDIM=Normal .9 BF Step Dimming ⁴ T8 Ballasts EB8_=T8 Electronic Start. Total Harmonic Distortion < 10% EB8_/PLUS=T8 Electronic Start. Total Harmonic Distortion < 10%. High Ballast Factor > 1.15 ER8_=T8 Electronic Program Rapid Start. Total Harmonic Distortion < 10%		1=1 Ballast 2=2 Ballasts	PALC=Job Pack, in Carton U=Unit Pack

NOTES: 1. Products also available in non-US voltage and frequencies for international markets. 2. Step Dimming ballast available for 28WT5 lamps only. 3. Available for 2 or 3 T5 lamps only. 4. 1 Lamp step dimming ballast in normal ballast factor not available. 2-lamp ballast will not operate 1 lamp.

2' x 2', 2' x 4'

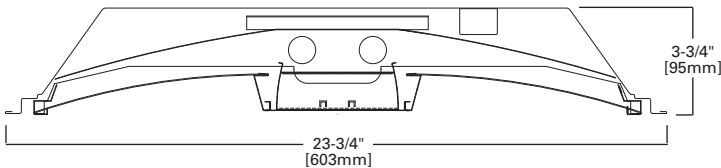

COMMERCIAL SPECIFICATION T5 OR T8 TROFFER



FEATURES

- Full array of lamp (T5/T5HO, T8, Biax) and ballast options
- Attractive contemporary design
- Clean modern detailing with uniformly illuminated center panel
- Shallow depth (3-1/4") and structural integrity for ease of install
- Significant energy savings
- Improved visual perception and increased comfort levels
- Even light distribution with optimal uniformity
- One piece enclosure, hinged door and tool-less design

DIMENSIONS

1' x 1', 1' x 4', 2' x 2', 2' x 4'

Compliances may not apply to all product configurations. Please consult the product spec sheet for compliance details.

COMPLIANCES: UL/cUL Listed - Damp Location, NOM Certified, IC Rated, City of Chicago Approved

ARCLINE SERIES



ORDERING INFORMATION

SAMPLE NUMBER: 2ALNG-224T5-UNV-EBT1-U

Rating	Width	Series	Trim Type ¹	Door Frame Standard	Number of Lamps	Wattage (Length)
[Blank]=Standard ATW-SW4=Chicago Rated	2=2' Width [Blank]=1' Width	ALN=ArcLine Series	F=Aluminum Flange G=Grid/Lay-in - Standard ¹³ G=Concealed-T/Slot Grid	[Blank]=Flat White Steel Door	1=1 Lamp (Not Included) ² 2=2 Lamps (Not Included)	14T5=14W T5 (24") 54T5=54W T5 (48") 17=17W T8 (24") BX18=18W Biax PH (12") 24T5=24W T5 (24") BX18 =18W Biax RS (12") 28T5=28W T5 (48") BX40=40W Biax (24") 28T8=28W T8 (48") OC16=16W T8 (12") 32=32W T8 (48") U1-5/8=31W T8 (24")
Shielding	Option - Aluminum Flange Trim ³		Voltage ⁷		Options	
[Blank]=Smooth Frosted Acrylic (Standard) SDL=Smooth Diffused Lens with Insert ¹	[Blank]=Single White Color N=Natural W=White	Type E=End of Row R=In Row S=Single	120V=120 Volt 277V=277 Volt 347V=347 Volt UNV=Universal Voltage 120-277 ⁴		EL=Emergency Installed (Must Specify Battery Pack, See Options) ^{5,6} Flex=Flex Installed (Reference Flex Ordering Information) GL=Single Element Fuse GM=Double Element Fuse Lamps=Lamps Installed (Refer to Lamp Ordering Options)	
Ballast Type					Number of Ballasts	Options
[Blank]=Standard Magnetic (1' x 1' Only)					1=1 Ballast 2=2 Ballasts	FR=Fire Rated Label LAO=Less Access Opening RLS=Rotor Lock Socket (T8 Lamps Only) ¹²
<p>Biax Ballasts TEB5 =T5 Biax Electronic Instant Start. Total Harmonic Distortion < 10%.</p> <p>T5 Ballasts EBT =T5 or T5HO Electronic Program Rapid Start. Total Harmonic Distortion < 10%. Standard Ballast Factor=1.0</p> <p>Ballast/Factor Type (T5) EBT_H=T5 Electronic Program Rapid Start. Total Harmonic Distortion < 10%. High Ballast Factor=1.15⁸ EBT_HDIM=T5 Electronic Program Rapid Start. Total Harmonic Distortion < 10%. Step Dimming, High Ballast Factor=1.15⁹ EBT_N=T5 Electronic Program Rapid Start. Total Harmonic Distortion < 10%. Normal Ballast Factor=.90¹⁰ EBT_NDIM=T5 Electronic Program Rapid Start. Total Harmonic Distortion < 10%. Step Dimming, Normal Ballast Factor=.95-1.0¹¹</p> <p>T8 Ballasts EB8 =T8 Electronic Start. Total Harmonic Distortion < 10%. EB8 /PLUS=T8 Electronic Start. Total Harmonic Distortion < 10%. High Ballast Factor > 1.15 ER8 =T8 Electronic Program Rapid Start, Total Harmonic Distortion < 10%.</p> <p>High Performance T8 Ballasts HB8 =T8 Electronic Instant Start. Total Harmonic Distortion < 10%. Standard Ballast Factor = .86 - .88 HB8_H=T8 Electronic Instant Start. Total Harmonic Distortion < 10%. High Ballast Factor = 1.15 - 1.20 HB8_L=T8 Electronic Instant Start. Total Harmonic Distortion < 10%. Low Ballast Factor = .77 - .82 HB8_N=T8 Electronic Instant Start. Total Harmonic Distortion < 10%. Normal Ballast Factor 1.0 HR8 =T8 Electronic Program Rapid Start. Total Harmonic Distortion < 10%. Standard Ballast Factor .86 - .88 HR8_DIM=T8 Electronic Program Rapid Start. Total Harmonic Distortion < 10%. Step Dimming, Ballast Factor .88 HR8_H=T8 Electronic Program Rapid Start. Total Harmonic Distortion < 10%. High Ballast Factor 1.15 - 1.20 HR8_L=T8 Electronic Program Rapid Start. Total Harmonic Distortion < 10%. Low Ballast Factor .71 - .79</p>						
Packaging		Accessories (Order Separately)				
PALC=Job Pack, in Carton U=Unit Pack		EQ-CLIP-U=T-BAR Safety Earthquake Clips ¹³ F2M-14S-W-U=1' x 4' Field Installed Flange Kit		FCTKA-22W-U=2' x 2' Field Installed Flange Kit FCTKA-24W-U=2' x 4' Field Installed Flange Kit		

NOTES: 1. Only required in ordering information for 2' x 2' and 2' x 4'. 2. 1' x 4' only. 3. Specify row configuration, type in catalog number when ordering complete fixtures. 4. Not available when specifying emergencies, voltage must be specific. 5. Must specify voltage (120V or 277V) when selecting EL option. 6. For 2' x 2' and 2' x 4' low profile emergency unit only, no access plate wire through end plate. Please specify voltage. 7. Products also available in non-US voltage and frequencies for international markets. 8. 1-Lamp ballast in a High Ballast factor not available. 9. Step Dimming ballast available for 2 or 3 14WT5 or 28W T5 lamps only. 10. 90 ballast factor available for 2 or 3 14W T5 or 28W T5 lamps only. 11. 1-Lamp step dimming ballast in a Normal Ballast factor not available. 2-Lamp ballast will not operate 1-Lamp. 12. Standard on 2' x 2' and 2' x 4' fixtures. 13. An EQ Grid Clip is recommended for all 9/16" ceiling systems. Four required per fixture.

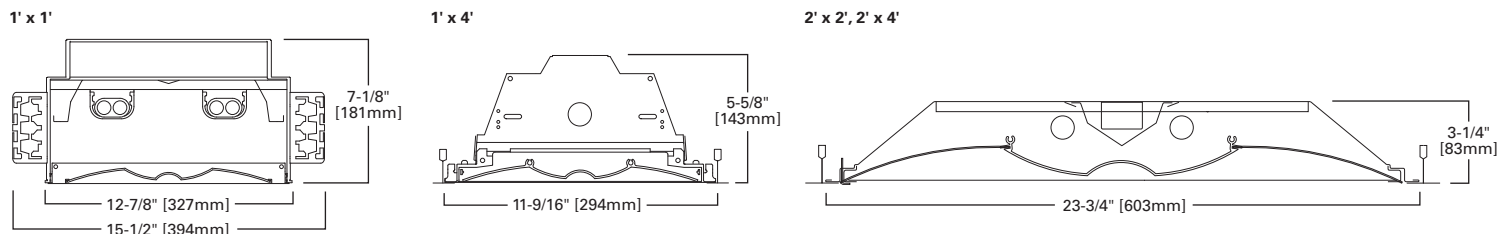

Specifications and dimensions subject to change without notice. Consult your Cooper Lighting Representative or visit www.cooperlighting.com for available options, accessories and ordering information.

FEATURES

- Wide variety of commercial applications
- Air-handling directional air vane
- Direct-Indirect design provides optimum brightness and glare control
- High-reflectance, matte-white finish painted after fabrication
- Ballasts are CBM/ETL Class P
- Heavy-gauge end plates are securely attached for strength and rigidity
- Positively retained direct lamp shield
- Die-formed, code-gauge steel; nominal 6" deep fixture

DIMENSIONS

2' x 2', 2' x 4'

Compliances may not apply to all product configurations. Please consult the product spec sheet for compliance details.

COMPLIANCES: UL/cUL Listed - Damp Location, NOM Certified



RDIA OVATION SERIES



ORDERING INFORMATION

SAMPLE NUMBER: 2RDIA-232RP-UNV-EB81-U

Width	Series	Trim Type	Lamp Position	Air Supply	Number of Lamps (Not Included)	Wattage
2=2' Width	RDIA =Recessed Direct-Indirect with Air Handling	[Blank] =Grid/Lay-in (Standard)	[Blank] =Center Mounted Lamps (Only)	VX =Directional Air Vane	1=1 Lamp 2=2 Lamps 3=3 Lamps	14T5 =14W T5 (24") 17 =17W T8 (24") 24T5 =24W T5HO (24") 28T5 =28W T5 (48") ¹ 32 =32W T8 (48") 54T5 =54W T5HO (48") BX40 =40W Biax (24")
Lamp Shield	Debris Shield ³	Voltage ⁴	Options			
FLS =Frosted Lamp Shield RP =Round Perforated White Steel RP/PLI =RP with Semi-Specular Parabolic Baffle RP/PLMI =RP with Specular Parabolic Baffle RP/TBW =RP White Steel with Thin Blade White Baffle SLS =Split Lamp Shield ² X =Solid Matte White	/DS =Debris Shield	120V =120 Volt 277V =277 Volt 347V =347 Volt UNV =Universal Voltage 120-277 ⁵	EL =Emergency Battery Installed (Must Specify Battery Pack, See Options) ⁶ Flex =Flex Installed (Reference Flex Ordering Information) GL =Single Element Fuse GM =Double Element Fuse Lamps =Lamps Installed			
Options	Ballast Type	Number of Ballasts				
EL =Emergency Battery Installed (Must Specify Battery Pack, See Options) ⁶ Flex =Flex Installed (Reference Flex Ordering Information) GL =Single Element Fuse GM =Double Element Fuse Lamps =Lamps Installed	T5 Ballasts EBT _=T5 or T5HO Electronic Program Rapid Start. Total Harmonic Distortion < 10%. Standard Ballast Factor=1.0 ⁷ Ballast/Factor Type (T5) EBT_H =T5 Electronic Program Rapid Start. Total Harmonic Distortion < 10%. High Ballast Factor=1.15 ⁸ EBT_HDIM =T5 Electronic Program Rapid Start. Total Harmonic Distortion < 10%. Step Dimming, High Ballast Factor=1.15 ^{9, 10} EBT_N =T5 Electronic Program Rapid Start. Total Harmonic Distortion < 10%. Normal Ballast Factor=.90 ¹¹ EBT_NDIM =T5 Electronic Program Rapid Start. Total Harmonic Distortion < 10%. Step Dimming, Normal Ballast Factor=.95-1.0 ¹² T8 Ballasts EB8 _=T8 Electronic Start. Total Harmonic Distortion < 10%. EB8 /PLUS =T8 Electronic Start. Total Harmonic Distortion < 10%. High Ballast Factor > 1.15 ER8 _=T8 Electronic Program Rapid Start. Total Harmonic Distortion < 10% ER8 /PLUS =T8 Electronic Program Rapid Start. Total Harmonic Distortion < 10%. High Ballast Factor > 1.15 High Performance T8 Ballasts HB8 _=T8 Electronic Instant Start. Total Harmonic Distortion < 10%. Standard Ballast Factor .86 - .88 HB8_H =T8 Electronic Instant Start. Total Harmonic Distortion < 10%. High Ballast Factor 1.15 - 1.20 HB8_L =T8 Electronic Instant Start. Total Harmonic Distortion < 10%. Low Ballast Factor .77 - .82 HB8_N =T8 Electronic Instant Start. Total Harmonic Distortion < 10%. Normal Ballast Factor 1.0 HR8 _=T8 Electronic Program Rapid Start. Total Harmonic Distortion < 10%. Standard Ballast Factor .86 - .88 HR8_DIM =T8 Electronic Program Rapid Start. Total Harmonic Distortion < 10%. Step Dimming. Ballast Factor .88 HR8_H =T8 Electronic Program Rapid Start. Total Harmonic Distortion < 10%. High Ballast Factor 1.15 - 1.20 HR8_L =T8 Electronic Program Rapid Start. Total Harmonic Distortion < 10%. Low Ballast Factor .71 - .79	1=1 Ballast 2=2 Ballasts 3=3 Ballasts				
Options ¹³	Packaging	Accessories (Order Separately)				
LSC =Lamp Shield Cable	PALC =Palletized Fixtures in Carton U =Unit Pack	DF-22-W =2' x 2' Drywall Frame Kit DF-24-W =2' x 4' Drywall Frame Kit EQ-CLIP-U =T-BAR Safety Earthquake Clips				

NOTES: 1. .90 ballast factor available for 2 or 3 28W T5 lamps only. 2. 2' x 2' and 2' x 4' Center Lamp Shield models only. 3. Only compatible with X, FLS and RP lamp shields. 4. Products also available in non-US voltage and frequencies for international markets. 5. Not available when specifying emergencies, voltage must be specified. 6. For EM option, single ballast configurations only. 7. .90 ballast factor available for 2 or 3 14W T5 or 28W T5 lamps only. 8. 1-Lamp ballast in a High Ballast factor not available. 9. Step Dimming ballast available for 2 or 3 14WT5 lamps only. 10. Step Dimming ballast available for 2 or 3 28W T5 lamps only. 11. .90 ballast factor available for 2 or 3 14W T5 lamps only. 12. 1-Lamp step dimming ballast in a Normal Ballast factor not available. 2-Lamp ballast will not operate 1-Lamp. 13. See options section.

2' x 2', 2' x 4'

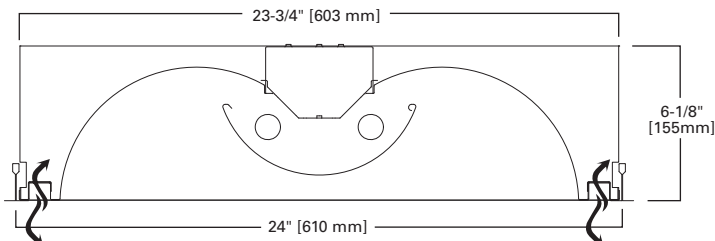

Specifications and dimensions subject to change without notice. Consult your Cooper Lighting Representative or visit www.cooperlighting.com for available options, accessories and ordering information.

COMMERCIAL SPECIFICATION DIRECT-INDIRECT



FEATURES

- Biax, T8 and T5/T5HO lamp sources
- Center-mount and side-mount lamp shield configurations
- High-reflectance, matte-white finish painted after fabrication
- 1, 2, 3 and 4 lamp modules
- Lamps and all hardware are completely shielded from view
- Direct-Indirect design provides optimum brightness and glare control
- Debris shield and lens option available
- Drywall applications in conjunction with drywall frame kit

DIMENSIONS

1' x 2', 1' x 4', 2' x 2', 2' x 4'

Compliances may not apply to all product configurations. Please consult the product spec sheet for compliance details.

COMPLIANCES: UL/cUL Listed - Damp Location, NOM Certified, IC Rated, City of Chicago Approved

RDI, 2RDI
OVATION SERIES



RP, X CENTER MOUNT

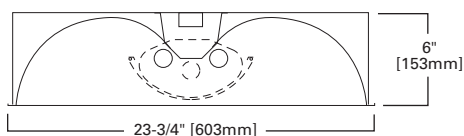

RP/PLI, RP/PLMI 2' x 2', 2' x 4'

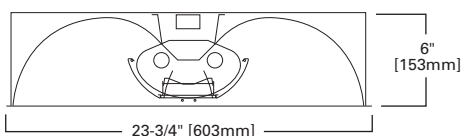

FLS 2' x 2', 2' x 4'

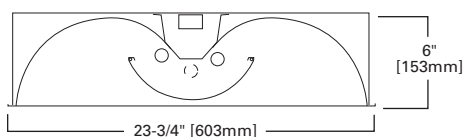

RP/TBW 2' x 2', 2' x 4'

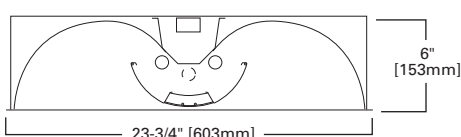

SLS 2' x 2', 2' x 4'

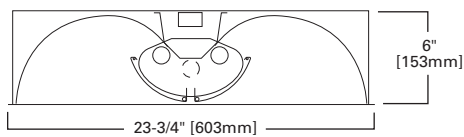

RP, X SIDE MOUNT 2' x 2', 2' x 4'

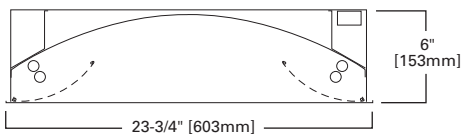

RPD 2' x 2', 2' x 4'

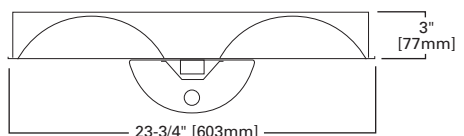

RP, X SIDE MOUNT 1' x 2', 1' x 4'

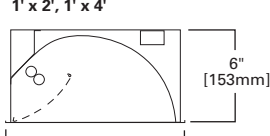

RP, X CENTER MOUNT 1' x 2', 1' x 4'

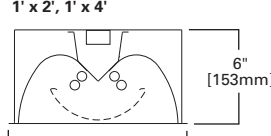

Specifications and dimensions subject to change without notice. Consult your Cooper Lighting Representative or visit www.cooperlighting.com for available options, accessories and ordering information.

ORDERING INFORMATION

SAMPLE NUMBER: 2RDI-2BX40RP-120V-EB51-U

Rating	Width	Series	Type	Trim Type	Lamp Position
[Blank]=Standard ATW-SW4=Chicago Rated	2=2' Width [Blank]=1' Width	RDI=Recessed Direct-Indirect	IC=IC Rated ¹	[Blank]=Grid/Lay-in (Standard) ²	[Blank]=Center Mounted Lamps (Standard) ASY=Asymmetric S=Side Mounted Lamps (2 or 4 Lamps Only)
Number of Lamps (Not Included) ^{3,4}		Wattage (Length)	Lamp Shield		Voltage ⁷
1=1 Lamp 2=2 Lamps 3=3 Lamps 4=4 Lamps T1=2' x 4' Fixture with One Biax Lamp at Each End T2=2' x 4' Fixture with Two Biax Lamps at Each End T3=2' x 4' Fixture with Three Biax Lamps at Each End		14T5=14W T5 (24") ⁵ 17=17W T8 (24") 24T5=24W T5HO (24") ⁵ 28T5=28W T5 (48") ⁵ 28T8=28W T8 (48") 32=32W T8 (48") 54T5=54W T5HO (48") ⁵ BX40=40W Biax (24") BX50=50W Biax (24") ^{4,5,6} BX55=55W Biax (24") ^{4,5,6}	FLS=Frosted Lamp Shield ⁵ RP=Round Perforated White Steel RP/PLI=RP with Semi-Specular Parabolic Baffle RP/PLMI=RP with Specular Parabolic Baffle RP/TBW=RP White Steel with Thin Blade White Baffle RP/TBWO/020=RP White Steel with Thin Blade White Baffle and Acrylic overlay RPD=Round Perforated Steel Below Ceiling Lamp Shield RPD/TBW=Round Perforated Below Ceiling Lamp Shield with Thin Blade White Baffle SLS=Split Perforated Center Basket X=Solid Matte White		024V=24 Volt DC 120V=120 Volt 277V=277 Volt 347V=347 Volt UNV=Universal Voltage 120-277 ⁸
Options			Ballast Type		
EL=Emergency Battery Installed (Must Specify Battery Pack, See Options) ⁹ Flex=Flex Installed (Reference Flex Ordering Information) GL=Single Element Fuse GM=Double Element Fuse Lamps=Lamps Installed (Refer to Lamp Ordering Options)			<p>Dimming Ballasts DC54_DIM=T5HO 24VDC Dimming= 0-10V, Ballast Factor=.78¹⁰ DC5_DIM=T5 24VDC Dimming 0-10V, Ballast Factor=1.0¹¹ DC8_DIM=T8 24VDC Dimming= 0-10V, Ballast Factor=1.0¹² DCX_DIM=Biax 24VDC Dimming= 0-10V, Ballast Factor=1.0^{13,14}</p> <p>Biax Ballasts EB5_=T5 Biax Electronic Instant Start. Total Harmonic Distortion < 20%.¹⁵ TEB5_=T5 Biax Electronic Instant Start. Total Harmonic Distortion < 10%.¹⁵ ER5_=T5 Biax Electronic Program Rapid Start. Total Harmonic Distortion < 10%.</p> <p>T5 Ballasts EBT_=T5 or T5HO Electronic Program Rapid Start. Total Harmonic Distortion < 10%. Standard Ballast Factor=1.0</p> <p>Ballast/Factor Type (T5) EBT_H=T5 Electronic Program Rapid Start. Total Harmonic Distortion < 10%. High Ballast Factor=1.15¹⁶ EBT_HDIM=T5 Electronic Program Rapid Start. Total Harmonic Distortion < 10%. Step Dimming, High Ballast Factor=1.15^{17,18} EBT_N=T5 Electronic Program Rapid Start. Total Harmonic Distortion < 10%. Normal Ballast Factor=.90¹⁹ EBT_NDIM=T5 Electronic Program Rapid Start. Total Harmonic Distortion < 10%. Step Dimming, Normal Ballast Factor=.95-1.0^{20,16,17,18}</p> <p>T8 Ballasts EB8_=T8 Electronic Start. Total Harmonic Distortion < 10%. EB8_/PLUS=T8 Electronic Start. Total Harmonic Distortion < 10%. High Ballast Factor > 1.15 ER8_=T8 Electronic Program Rapid Start. Total Harmonic Distortion < 10%.</p> <p>High Performance T8 Ballasts HB8_=T8 Electronic Instant Start. Total Harmonic Distortion < 10%. Standard Ballast Factor .86 - .88 HB8_H=T8 Electronic Instant Start. Total Harmonic Distortion < 10%. High Ballast Factor 1.15 - 1.20 HB8_L=T8 Electronic Instant Start. Total Harmonic Distortion < 10%. Low Ballast Factor .77 - .82 HB8_N=T8 Electronic Instant Start. Total Harmonic Distortion < 10%. Normal Ballast Factor 1.0 HR8_=T8 Electronic Program Rapid Start. Total Harmonic Distortion < 10%. Standard Ballast Factor .86 - .88 HR8_DIM=T8 Electronic Program Rapid Start. Total Harmonic Distortion < 10%. Step Dimming, Ballast Factor .88 HR8_H=T8 Electronic Program Rapid Start. Total Harmonic Distortion < 10%. High Ballast Factor 1.15 - 1.20 HR8_L=T8 Electronic Program Rapid Start. Total Harmonic Distortion < 10%. Low Ballast Factor .71 - .79</p>		
Number of Ballasts ²¹	Options	Packaging	Accessories (Order Separately)		
1=1 Ballast 2=2 Ballasts 3=3 Ballasts	LSC=Lamp Shield Cable LVDC10=Low Voltage 10 Foot DC Connector and Cable Assembly Installed LVDC5=Low Voltage 5 Foot DC Connector and Cable Assembly Installed RIF1=Radio Interference Suppressor RLS=Rotor Lock Socket (T8 Lamps Only) ST=Semi-Specular Tannenbaum	PAL=Job Pack Out of Carton PALC=Palletized Fixtures in Carton U=Unit Pack	DF-12-W=1' x 2' Drywall Frame Kit DF-14-W=1' x 4' Drywall Frame Kit DF-22-W=2' x 2' Drywall Frame Kit DF-24-W=2' x 4' Drywall Frame Kit EQ-CLIP-U=T-BAR Safety Earthquake Clips ²²		

NOTES: 1. IC versions only available for select 2' x 2' and 2' x 4' models. 2. Louver is recessed by 5/16" in Concealed T or Slot Grid T. 3. Stem Mounting not available on 3-lamp fixtures. 4. 50W or 55W Biax only available in a 1-lamp option. 5. 2' x 2' and 2' x 4' Center Lamp Shield models only. 6. Biax 50 or 55W only available in tandem 1 lamp option. 7. Products also available in non-US voltage and frequencies for international markets. 8. Not available when specifying emergencies, voltage must be specified. 9. Fixtures equipped with "EL" option may require a 5-1/2" housing depth. If installing in field, must use low profile battery pack. 10. 54T5 is only available in 1-lamp. 11. 24VDC version is EMerge Alliance® Registered. (T5HO 1 lamp ballast only). 12. 24VDC version is EMerge Alliance® Registered (T8 = 2 lamp ballast only). 13. 24VDC version is EMerge Alliance® Registered (Biax = 1 lamp ballast only). 14. BX40 is only available in 1-lamp. 15. Not available in UNV voltage. Must specify voltage. 16. 1-Lamp ballast in a High Ballast factor not available. 17. Step Dimming ballast available for 2 or 3 14WT5 lamps only. 18. Step Dimming ballast available for 28W T5 and 14WT5 lamps only. 19. 90 ballast factor available for 2 or 3 14W T5 or 28W T5 lamps only. 20. 1-Lamp step dimming ballast in a Normal Ballast factor not available. 2-Lamp ballast will not operate 1-Lamp. 21. For Emerge 2' x 4' T8 1.0 Ballast Factor, two ballast must be ordered. 22. An EQ Grid Clip is recommended for all 9/16" ceiling systems. Four required per fixture.

COMMERCIAL SPECIFICATION WALL WASH



FEATURES

- Utilizes efficient fluorescent T8, T5 and Biax lamp sources
- 2' and 4' lengths
- Adjustable end-support mounting brackets
- Optional baffle and lens accessories available
- Easy ballast access from above or below ceiling
- Die-formed housing in code-gauge, cold-rolled steel
- Durable high-reflective finish
- Specular and semi-specular low iridescent anodized-aluminum reflectors
- Can be used in drywall applications using drywall frame kit

DIMENSIONS

1' x 2', 1' x 4'

RWW SERIES

Compliances may not apply to all product configurations. Please consult the product spec sheet for compliance details.

COMPLIANCES: UL Listed - Damp Location, NOM Certified



ORDERING INFORMATION

SAMPLE NUMBER: RWW-232MI-120V-EB81-U

Series	Number of Lamps (Not Included)	Wattage (Length)	Louver/Reflector Finish	Voltage ³	Options ⁵
RWW=Recessed Wall Wash	1=1 Lamp 2=2 Lamps T1=1' x 4' Fixture with One Biax Lamp at Each End	14 T5=14W T5 (24") 17=17W T8 (24") 24 T5=24W T5HO (24") 28T5=28W T5 (48") 32=32W T8 (48") 54 T5=54W T5HO (48") BX40=40W Biax (24") ^{1,2} BX50=50W Biax (24") ^{1,2} BX55=55W Biax (24") ^{1,2}	I=Semi-Specular Low Iridescent MI=Specular Low Iridescent (Standard) W=White	120V=120 Volt 277V=277 Volt 347V=347 Volt UNV=Universal Voltage 120-277 ⁴	EL=Emergency Battery Installed (Must Specify Battery Pack, See Options) GL=Single Element Fuse GM=Double Element Fuse

Ballast Type

Biax Ballasts

EB5 =T5 Biax Electronic Instant Start. Total Harmonic Distortion < 20%.⁶
ER5 =T5 Biax Electronic Program Rapid Start. Total Harmonic Distortion < 10%.
TEB5 =T5 Biax Electronic Instant Start. Total Harmonic Distortion < 10%.⁶

T5 Ballasts

EBT =T5 or T5HO Electronic Program Rapid Start. Total Harmonic Distortion < 10%. Standard Ballast Factor=1.0

Ballast/Factor Type (T5)

EBT_H=T5 Electronic Program Rapid Start. Total Harmonic Distortion < 10%. High Ballast Factor=1.15⁷
EBT_HDIM=T5 Electronic Program Rapid Start. Total Harmonic Distortion < 10%. Step Dimming, High Ballast Factor=1.15⁸
EBT_N=T5 Electronic Program Rapid Start. Total Harmonic Distortion < 10%. Normal Ballast Factor=.90⁹
EBT_NDIM=T5 Electronic Program Rapid Start. Total Harmonic Distortion < 10%. Step Dimming, Normal Ballast Factor=.95-1.0¹⁰

T8 Ballasts

EB8 =T8 Electronic Start. Total Harmonic Distortion < 10%.
EB8_PLUS=T8 Electronic Start. Total Harmonic Distortion < 10%. High Ballast Factor > 1.15.
ER8 =T8 Electronic Program Rapid Start. Total Harmonic Distortion < 10%.

Number of Ballasts	Options	Packaging
1=1 Ballast 2=2 Ballasts 3=3 Ballasts	CAL2=Clear Acrylic Lens (2' Fixture) ¹¹ CAL4=Clear Acrylic Lens (4' Fixture) ¹¹ DF-102-W=2' Version. Drywall Frame Kit (Order Individually as Accessory) DF-104-W=4' Version. Drywall Frame Kit (Order Individually as Accessory) RLS=Rotor Lock Socket (T8 Lamps Only) TBW2=Thin White Baffle Accessory (2' Fixture) TBW4=Thin White Baffle Accessory (4' Fixture)	PALC=Palletized Fixtures in Carton U=Unit Pack

NOTES: 1. Biax only available in 1 lamp cross section. 2. Electronic ballast only. 3. Products also available in non-US voltage and frequencies for international markets. 4. UNV available in T5 and T8 linear only. Not available when specifying emergencies, voltage must be specified. 5. See Options or Accessories. 6. Not available in UNV voltage. Must specify voltage. 7. 1-Lamp ballast in a High Ballast factor not available. 8. Step Dimming ballast available for 2 or 3 14WT5 or 28W T5 lamps only. 9. .90 ballast factor available for 2 or 3 14W T5 or 28W T5 lamps only. 10. 1-Lamp step dimming ballast in a Normal Ballast factor not available. 2-Lamp ballast will not operate 1-Lamp. 11. Field installed accessory ships in separate carton.

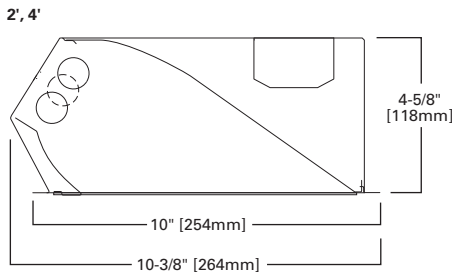

Specifications and dimensions subject to change without notice. Consult your Cooper Lighting Representative or visit www.cooperlighting.com for available options, accessories and ordering information.

FEATURES

- Miniature profile design ideal for architectural lighting solutions
- Equipped with T5 energy-saving electronic ballast
- Die-formed from rolled-steel with baked white enamel finish
- SM can be surface or pendant mount, individual or row mounting
- SML for shadow-free continuous illumination in cove lighting
- Numerous knockouts for easy installation
- Easy wireway access; wireway cover removed without tools
- Lamps not included on SM/SML/SMW striplight series

DIMENSIONS

2', 3', 4', 8'

Compliances may not apply to all product configurations. Please consult the product spec sheet for compliance details.

COMPLIANCES: UL/cUL Listed - Damp Location



CRICKET SM, SML SERIES

ORDERING INFORMATION

SAMPLE NUMBER: SML-228T5-120V-EBT1

Tandem	Series	Number of Lamps (Not Included)	Wattage	Voltage	Options	
8T=8' Length [Blank]=2', 3' or 4' Lengths	SM=T5 Micro Striplight SML=Staggered T5 Micro Striplight	1=1 Lamp 2=2 Lamps 3=3 Lamps 4=4 Lamps	14T5=14W T5 (24") ^{1,2} 21T5=21W T5 (36") ¹ 24T5=24W T5HO (24") ^{1,2} 28T5=28W T5 (48") ¹	35T5=35W T5 (60") ¹ 39T5=39W T5HO (36") ¹ 54T5=54W T5HO (48") ¹	120V=120 Volt 277V=277 Volt 347V=347 Volt UNV=Universal Voltage 120-277 ³	EL=Emergency Installed ⁴ GL=Single Element Fuse GM=Double Element Fuse
Ballast Type			Number of Ballasts	Options		
T5 Ballasts EBT=T5 or T5HO Electronic Program Rapid Start. Total Harmonic Distortion < 10%. Standard Ballast Factor=1.0 ⁵ Ballast/Factor Type (T5) EBT_H=T5 Electronic Program Rapid Start. Total Harmonic Distortion < 10%. High Ballast Factor=1.15 ⁵ EBT_HDIM=T5 Electronic Program Rapid Start. Total Harmonic Distortion < 10%. Step Dimming, High Ballast Factor=1.15 EBT_N=T5 Electronic Program Rapid Start. Total Harmonic Distortion < 10%. Normal Ballast Factor=.90 ⁵ EBT_NDIM=T5 Electronic Program Rapid Start. Total Harmonic Distortion < 10%. Step Dimming, Normal Ballast Factor=.95-1.0 ⁷			1=1 Ballast 2=2 Ballasts	PI/CPI=Plug-In Option RLS=Rotor-Lock Socket (T8 Lamps Only) TILW=Tandem Inline Wiring		
Packaging	Accessories (Order Separately)					
U=Unit Pack	SM-ASY-4=Asymmetrical 4' Reflector SM-ASY-RP-4=Perforated Asymmetrical 4' Reflector SM-SYM-4=Symmetrical 4' Reflector SM-SYM-RP-4=Perforated Symmetrical 4' Reflector		SML-2IN-ASY=Asymmetrical Reflector SML-2IN-ASY/REV=Reverse Asymmetrical Reflector SML-2IN-SYM=Symmetrical Reflector			

NOTES: 1. Nominal dimension. See mounting data for exact measurements. 2. SML 1-lamp not available for these lamp types. 3. Not available when specifying emergencies, voltage must be specified. 4. Available for 4' and 1-lamp 5' units only. 5. .90 ballast factor available for 2 or 3 14W T5 or 28W T5 lamps only. 6. 1-Lamp ballast in a High Ballast factor not available. 7. 1-Lamp step dimming ballast in a Normal Ballast factor not available. 2-Lamp ballast will not operate 1-Lamp.

ORDERING INFORMATION⁴

SAMPLE NUMBER: SML-ASY-SS-4-1 (Accessory Reflector)

Strip Series	Number of Lamps (Not Included)
SML=Micro Staggered SMW=Micro Wide	4=3 or 4 Lamp ¹

NOTES: Δ See accessories page for additional reflectors. 1. For SMW only.

SML 2', 3', 4', 5'

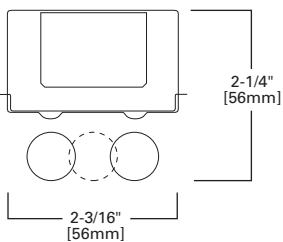

SM 2', 3', 4', 5'

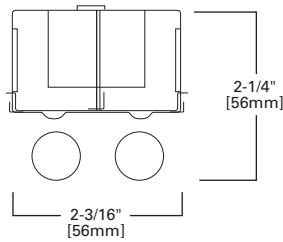

SM 3 AND 4 LAMP

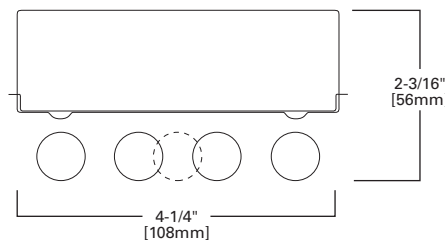

HIGH-BAY INDUSTRIAL



FEATURES

- Full-bodied steel housing for rigidity and strength
- Segmented optical design optimizes performance by three distributions
- Five-year, 55°C or three-year, 65°C ballast warranty
- High-performance polyester powder-coat to protect from corrosion
- Door frame and lens available in clear and prismatic acrylic
- F-Bay modular power supply available for quick power disconnect
- Suspension-mount with optional wire hook and chain set
- Single monopoint-mounting also available with HB-SPM tong hanger

DIMENSIONS

17" x 48"

Compliances may not apply to all product configurations. Please consult the product spec sheet for compliance details.

COMPLIANCES: UL/cUL Listed, UL/cUL Listed - Damp Location

F-BAY HBI SERIES



ORDERING INFORMATION

SAMPLE NUMBER: HBI-654T5-N-UNV-EBT2-U

Series ¹	Number of Lamps (Not Included)	Lamp Type	Distribution	Shielding	Voltage ³
HBI=High Bay Industrial	4=4 Lamps 5=5 Lamps 6=6 Lamps	28T5=28W T5 Lamps (48") 32=32W T8 Lamps (48") 47T5=47W T5HO Lamps (48") ² 49T5=49W T5HO Lamps (48") ² 51T5=51W T5HO Lamps (48") ² 54T5=54W T5HO Lamps (48") ²	M=Medium Beam N=Narrow Beam (Standard) W=Wide Beam	[Blank]=None A=Prismatic Acrylic Lens and Doorframe A/WG=Acrylic Lens, Wireguard and Doorframe CL=Clear Acrylic Lens and Doorframe CL/WG=Clear Lens, Wireguard and Doorframe WG=Wireguard and Doorframe	120V=120 Volt 277V=277 Volt 347V=347 Volt 480V=480 Volt UNC=Universal 347/480 Voltage ⁴ UNV=Universal 120/277 Voltage
Options			Ballast Type	Number of Ballasts	
EL=Emergency Battery Installed (Must Specify Battery Pack, See Options) ⁵ GL=Single Element Fuse GM=Double Element Fuse Lamps Installed⁶ HL=Add HL at end of Lamp for High Lumen Lamps, T8 Only L5830=T5 Lamp, 85CRI 3000K L5835=T5 Lamp, 85CRI 3500K L5841=T5 Lamp, 85CRI 4100K L5850=T5 Lamp, 85CRI 5000K L8830=T8 Lamp, 85CRI 3000K L8835=T8 Lamp, 85CRI 3500K L8841=T8 Lamp, 85CRI 4100K L8850=T8 Lamp, 85CRI 5000K			T5 Ballasts EBT_=T5 or T5HO Electronic Program Rapid Start. Total Harmonic Distortion < 10%. Standard Ballast Factor=1.0 ⁷ EHT_=T5HO Linear Electronic Program Rapid Start High Ambient. Total Harmonic Distortion < 10%. ⁸ T8 Ballasts⁹ EB8_=T8 Electronic Start. Total Harmonic Distortion < 10%. EB8_/PLUS=T8 Electronic Start, Total Harmonic Distortion < 10%. High Ballast Factor > 1.15 ER8_=T8 Electronic Program Rapid Start. Total Harmonic Distortion < 10%. ¹⁰ ER8_/PLUS=T8 Electronic Program Rapid Start. Total Harmonic Distortion < 10%. High Ballast Factor > 1.15 ¹⁰	2=2 Ballasts 3=3 Ballasts	
Options		Packaging	Accessories (Order Separately)		
G2=Gasketed Door (Requires Selection of Lensed Doorframe) MP=Modular Power Receptacle (Used for All Cord or Cord and Plug Options) ¹¹ MS=360° or 180° motion sensor installed, 120V through 347V, or 480V ¹² MWS=Modular Wiring System ^{13, 14} NUA=No Uplight Apertures In Housing (Cannot be Combined with UPL) SDF=Slotted Doorframe (Requires Selection of Lensed Doorframe) UPL=Uplight Apertures		PAL=Job Pack Out of Carton PALC=Palletized In Carton U=Unit Pack	FH-1=Fixture Hook FL-1=Fixture Loop HB-SPM=Single Monopoint Hanger with Hub HB-SPM-S=Single Monopoint Hanger for Surface Mount HBAYC-CHAIN/SET-U=(2) V-Hook Hangers, 36" Chain Sets with S-Hooks MC3=3' Modular Power Cord MC6=6' Modular Power Cord MDS6=6' Modular Power Cord with MWS 27DS18/2G06MP Connector ¹³ MMS=360° or 180° Aisle Motion Sensor with Modular Power Receptacle (120-277V) MPC3=3' Modular Power Cord and Plug (Specify Voltage) MPC6=6' Modular Power Cord and Plug (Specify Voltage) RH-1=Retrofit Hanger SWG=Heavy Duty Wireguard for Field Installation Y-TOGGLE=Y Mounting Toggle, #2 Cable (Specify 10' or 30', Requires 2 Per Fixture)		

NOTES: 1. Includes V Hangers for rapid installation. 2. EHT standard with T5HO lamps. 3. Voltage must be specified when ordered with plugs or emergency ballasts. For MS option, indicate UNV (for 120V or 277V), 347V or 480V. 4. 2 lamp ballast configurations only for T5 UNC versions. 2/3 lamp ballast configurations in EB8/PLUS only for T8 UNC versions. 5. Voltage must be specified when ordered with plugs or emergency ballasts. 6. Must specify lamps when ordering. 7. EBT ballast systems suitable for operation in ambient environments up to 104°F (40°C) in upright configuration. 8. EHT/HT5/HCT5 ballast systems suitable for ambient environments not to exceed 149°F (65°C) in open upright configurations and less lens option. 9. ER8 and EB8 ballast systems suitable for operation in ambient environments up to 122°F (50°C) in open upright configurations. 10. Recommended when using motion sensor options or accessories. 11. Requires use of MC or MPC cord accessories, specify voltage for plugs. 12. When ordering MS option, specify UNV (for 120 or 277V), 347 or 480V. 13. For MWS with MP, choose MP in fixture logic and then choose MWS accessory such as MDS6. 14. Cannot be combined with Modular Power Receptacle (MP).

4 LAMP

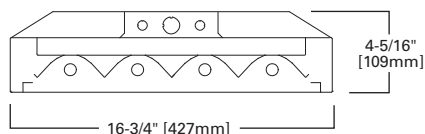

5 LAMP

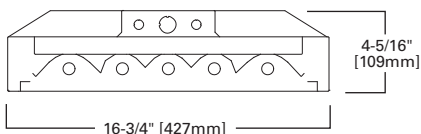

6 LAMP

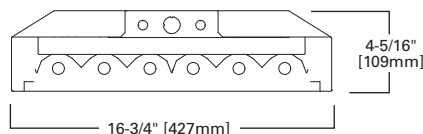

Specifications and dimensions subject to change without notice. Consult your Cooper Lighting Representative or visit www.cooperlighting.com for available options, accessories and ordering information.

FEATURES

- Primary applications include "big box" retail and industrial
- Full-body construction with channel, sides and end plates
- Class P electronic ballast
- Segmented optical design optimizes performance by three distributions
- F-Bay modular power supply available for quick power disconnect
- Suspension-mount with optional wire hook and chain set
- Single monopoint-mounting also available with SPM tong hanger
- Door frame and lens assembly optional for demanding environments

DIMENSIONS

20" x 48", 25" x 48"

Compliances may not apply to all product configurations. Please consult the product spec sheet for compliance details.

COMPLIANCES: UL/cUL Listed, UL/cUL Listed - Damp Location



F-BAY HBE SERIES

ORDERING INFORMATION⁴

SAMPLE NUMBER: HBE-632-N-UNV-L8850-ER82-U

Series	Number of Lamps (Not Included)	Lamp Type	Distribution	Shielding ^{1,2}	Voltage ³
HBE =High Bay Efficiency	4=4 Lamps 6=6 Lamps 8=8 Lamps ¹ 10=10 Lamps ¹	23T5=28W T5 Lamps (48") 32=32W T8 Lamps (48") 47T5=47W T5HO Lamps (48") 49T5=49W T5HO Lamps (48") 51T5=51W T5HO Lamps (48") 54T5=54W T5HO Lamps (48")	M=Medium Beam N=Narrow Beam (Standard) W=Wide Beam	[Blank]=None A=Prismatic Acrylic Lens and Doorframe A/WG=Acrylic Lens, Wireguard and Doorframe CL=Clear Acrylic Lens and Doorframe CL/WG=Clear Lens, Wireguard and Doorframe WG=Wireguard and Doorframe	120V=120 Volt 277V=277 Volt 347V=347 Volt UNC=Universal 347/480 Voltage ⁴ UNV=Universal 120/277 Voltage
Options			Ballast Type		
EL=Emergency Battery Installed (Must Specify Battery Pack, See Options) GL=Single Element Fuse GM=Double Element Fuse Lamps Installed⁵ HL=Add HL at end of Lamp for High Lumen Lamps, T8 Only L5830=T5 Lamp, 85CRI 3000K L5835=T5 Lamp, 85CRI 3500K L5841=T5 Lamp, 85CRI 4100K L5850=T5 Lamp, 85CRI 5000K L8830=T8 Lamp, 85CRI 3000K L8835=T8 Lamp, 85CRI 3500K L8841=T8 Lamp, 85CRI 4100K L8850=T8 Lamp, 85CRI 5000K			T5 Ballasts EBT=T5 or T5HO Electronic Program Rapid Start. Total Harmonic Distortion < 10%. Standard Ballast Factor=1.0 ⁶ EHT=T5HO Linear Electronic Program Rapid Start High Ambient. Total Harmonic Distortion < 10%. ⁷ T8 Ballasts⁸ EB8=T8 Electronic Start. Total Harmonic Distortion < 10%. EB8 /PLUS=T8 Electronic Start. Total Harmonic Distortion < 10%. High Ballast Factor > 1.15 ER8=T8 Electronic Program Rapid Start. Total Harmonic Distortion < 10%. ⁹ ER8 /PLUS=T8 Electronic Program Rapid Start. Total Harmonic Distortion < 10%. High Ballast Factor > 1.15 ⁹		
Number of Ballasts	Options	Packaging	Accessories (Order Separately)		
1=1 Ballast 2=2 Ballasts 3=3 Ballasts	[Blank]=Side Rails (Standard) MP=Modular Power Receptacle (Used for All Cord or Cord and Plug Options) ¹⁰ MS=360° or 180° motion sensor installed, 120V through 347V, or 480V ¹¹ MWS=Modular Wiring System ^{12, 13} UPL=Uplight Apertures on Reflector	PAL=Job Pack Out of Carton PALC=Job Pack, in carton U=Unit Pack	FH-1=Fixture Hook FL-1=Fixture Loop HBAYC-CHAIN/SET/U=(2) V-Hook Hangers, 36" Chain Sets with S-Hooks HBL-SPM=Single Monopoint Hanger with Hub HBL-SPM-S=Single Monopoint Surface Mount Hanger MC3=3' Modular Power Cord MC6=6' Modular Power Cord MDS6=6' Modular Power Cord with MWS 27DS18/2G06MP Connector ¹² MMS=360° or 180° Aisle Motion Sensor with Modular Power Receptacle (120-277V) ¹⁰ MPC3=3' Modular Power Cord and Plug (Specify Voltage) MPC6=6' Modular Power Cord and Plug (Specify Voltage) RH-1=Retrofit Hanger WG/HBL6-4FT-B=Field Installable, Wireguard for HBE 4 and 6 Lamp WG/HBL8-4FT-B=Field Installable, Wireguard for HBE 8 and 10 Lamp Y-TOGGLE=Y Mounting Toggle, #2 Cable (Specify 10' or 30')		

NOTES: ¹ Includes V Hangers for rapid installation. ² EHT ballast recommended when using lens option on 8 or 10 lamp configurations. ³ Not recommended in 10 Lamp configurations at ambient temperatures above 120°F (40°C). ⁴ Voltage must be specified when ordered with plugs or emergency ballasts. For MS option, indicate UNV (for 120V or 277V), 347V or 480V. ⁵ 2 lamp ballast configurations only for T5 UNC versions. 2/3 lamp ballast configurations in EB8/PLUS only for T8 UNC versions. ⁶ Must specify lamps when ordering. ⁷ EBT ballast systems suitable for operation in ambient environments up to 104°F (40°C) in upright configuration. ⁸ EHT/HT5/HCT5 ballast systems suitable for ambient environments not to exceed 149°F (65°C) in open upright configurations and less lens option. ⁹ T8 ballast systems suitable for operation in ambient environments up to 131°F (55°C) in open upright configuration. ¹⁰ Recommended when using motion sensor options or accessories. ¹¹ Requires use of MC or MPC cord accessories, specify voltage for plugs. ¹² When ordering MS option, specify UNV (for 120 or 277V), 347 or 480V. ¹³ For MWS with MP, choose MP in fixture logic and then choose MWS accessory such as MDS6. ¹⁴ Cannot be combined with Modular Power Receptacle (MP).

25" x 48", 8 LAMP

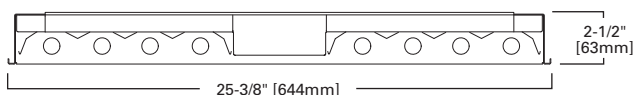

25" x 48", 10 LAMP

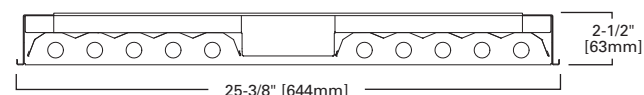

20" x 48", 4 LAMP

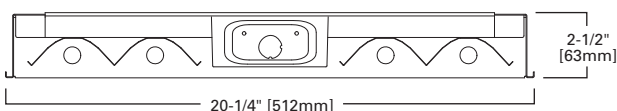

20" x 48", 6 LAMP

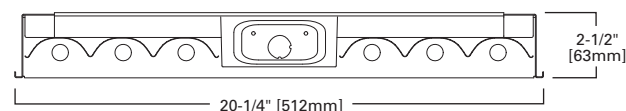
Specifications and dimensions subject to change without notice. Consult your Cooper Lighting Representative or visit www.cooperlighting.com for available options, accessories and ordering information.

HIGH-BAY INDUSTRIAL



FEATURES

- Retail, industrial and warehouse applications
- Channel and end plates constructed of die-formed steel
- Class P electronic ballast and twistlock lampholders
- Segmented optical design optimizes performance by three distributions
- Stiffening brackets add additional strength and rigidity to channel
- Uplight option available to permit ceiling uniformity
- Excellent thermal dissipation without any special components
- Suspension-mount with optional wire hook and chain set
- F-Bay modular power supply available for quick power disconnect

DIMENSIONS

20" x 48", 25" x 48"

F-BAY HBL SERIES

Compliances may not apply to all product configurations. Please consult the product spec sheet for compliance details.

COMPLIANCES: UL/cUL Listed, UL/cUL Listed - Damp Location



ORDERING INFORMATION^A

SAMPLE NUMBER: HBL-632-N-UNV-EB81-UPL-U

Series	Number of Lamps (Not Included)	Lamp Type	Distribution	Voltage ¹
HBL=Linear High Bay	4=4 Lamps 6=6 Lamps 8=8 Lamps 10=10 Lamps	28T5=28W T5 Lamp (48") 32=32WT8 Lamp (48") 47T5=47W T5HO Lamp (48") 49T5=49W T5HO Lamp (48") 51T5=51W T5HO Lamp (48") 54T5=54W T5HO Lamp (48")	M=Medium Beam N=Narrow Beam (Standard) W=Wide Beam	120V=120 Volt 277V=277 Volt 347V=347 Volt UNC=Universal 347/480 Voltage ² UNV=Universal 120/277 Voltage
Options		Ballast Type	Number of Ballasts	
EL=Emergency Battery Installed (Must Specify Battery Pack, See Options) ³ GL=Single Element Fuse GM=Double Element Fuse Lamps Installed ⁴ HL=Add HL at end of Lamp for high lumen Lamps, T8 Only L5830=T5 Lamp, 85GR L5835=T5HO Lamp, 85CRI 3500K L5841=T5HO Lamp, 85CRI 4100K L5850=T5HO Lamp, 85CRI 5000K L8830=T8 Lamp, 85CRI 3000K L8835=T8 Lamp, 85CRI 3500K L8841=T8 Lamp, 85CRI 4100K L8850=T8 Lamp, 85CRI 5000K		T5 Ballasts EBT_=T5 or T5HO Electronic Program Rapid Start. Total Harmonic Distortion < 10%. Standard Ballast Factor=1.0 ⁵ EHT_=T5HO Linear Electronic Program Rapid Start High Ambient. Total Harmonic Distortion < 10% ⁶ T8 Ballasts ⁷ EB8_=T8 Electronic Start. Total Harmonic Distortion < 10%. EB8_/PLUS=T8 Electronic Start. Total Harmonic Distortion < 10%. High Ballast Factor > 1.15 ER8_=T8 Electronic Program Rapid Start. Total Harmonic Distortion < 10%. ⁸ ER8_/PLUS=T8 Electronic Program Rapid Start. Total Harmonic Distortion < 10%. High Ballast Factor > 1.15 ⁸	1=1 Ballast 2=2 Ballasts 3=3 Ballasts	
Options		Packaging	Accessories (Order Separately)	
MP=Modular Power Receptacle (Used for All Cord or Cord and Plug Options) ⁹ MS=360° or 180° Motion Sensor installed (120V through 347V or 480V) ¹⁰ MWS=Modular Wiring System ^{11, 12} UPL=Uplight Apertures on Reflector		PAL=Job Pack Out of Carton PALC=Palletized in Carton U=Unit Pack	FH-1=Fixture Hook FL-1=Fixture Loop HBAYC-CHAIN/SET-U=(2) V-Hook Hanger, 36" Chain Sets with S-Hooks HBL-SPM=Single Monopoint Hanger with Hub HBL-SPM-S=Single Monopoint Surface Mount Hanger MC3=3' Modular Power Cord MDS6=6' Modular Power Cord with MWS 27DS18/2G06MP Connector ¹² MMS=360° or 180° Aisle Motion Sensor with Modular Power Receptacle (120-277V) ⁹ MP6=6' Modular Power Cord MPC3=3' Modular Power Cord and Plug (Specify Voltage) MPC6=6' Modular Power Cord and Plug (Specify Voltage) RH-1=Retrofit Hanger WG/HBL6-4FT-B=Field Installable, Wireguard for HBL 4 and 6 Lamp WG/HBL8-4FT-B=Field Installable, Wireguard for HBL 8 and 10 Lamp Y-TOGGLE=Y Mounting Toggle, #2 Cable (Specify 10' or 30')	

NOTES: Δ Includes V Hangers for rapid installation. 1. Voltage must be specified when ordered with plugs or emergency ballasts. For MS option, indicate UNV (for 120V or 277V), 347V or 480V. 2. 2 lamp ballast configurations only for T5 UNC versions. 2/3 lamp ballast configurations in EB8/PLUS only for T8 UNC versions. 3. Voltage must be specified when ordered with plugs or emergency ballasts. 4. Must specify lamps when ordering. 5. EBT ballast systems suitable for operation in ambient environments up to 104°F (40°C) in upright configuration. 6. EHT/HT5/HCT5 ballast systems suitable for ambient environments not to exceed 149°F (65°C) in open upright configurations and less lens option. 7. T8 ballast systems suitable for operation in ambient environments up to 131°F (55°C) in open upright configuration. 8. Recommended when using motion sensor options or accessories. 9. Requires use of MC or MPC cord accessories, specify voltage for plugs. 10. When ordering MS option, specify UNV (for 120 or 277V). 11. Cannot be combined with Modular Power Receptacle (MP). 12. For MWS with MP, choose MP in fixture logic and then choose MWS accessory such as MDS6.

4 LAMP

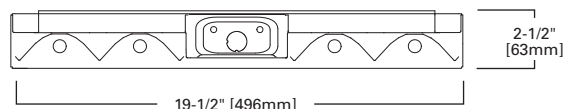

8 LAMP

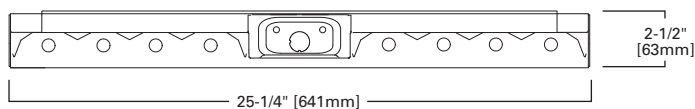

6 LAMP

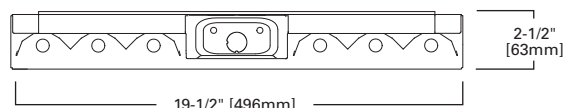

10 LAMP

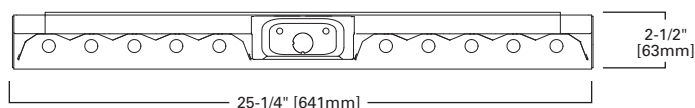

Specifications and dimensions subject to change without notice. Consult your Cooper Lighting Representative or visit www.cooperlighting.com for available options, accessories and ordering information.

FEATURES

- Specular enhanced aluminum standard for medium optical distribution
- Open or lensed option with reinforced aluminum door
- Four auxiliary fixture-end suspension points provided
- End plate grid-lock feature
- Superior lumen maintenance exceeds that of HID
- Instant strike and re-strike ability
- Occupancy sensor instantly turn lights on and off

DIMENSIONS

2' x 2', 2' x 4'

Compliances may not apply to all product configurations. Please consult the product spec sheet for compliance details.

COMPLIANCES: UL/cUL Listed, UL/cUL Listed - Damp Location



F-BAY 2HBG SERIES

ORDERING INFORMATION

SAMPLE NUMBER: 2HBG-654T5A-UNV-EHT2-U

Width	Series	Trim Type	Number of Lamps (Not Included)	Lamp Type	Distribution	Shielding ³
2=24"	HB=High Bay	F=Aluminum Flange Trim ¹ G=Grid/Lay-in (Standard)	4=4 Lamps 6=6 Lamps	28T5=28W T5 Lamps (48") ² 32=32W T8 Lamps (48") 47T5=47W T5HO Lamp (48") 49T5=49W T5HO (48") 51T5=51W T5HO (48") 54T5=54W T5HO Lamps (48")	[Blank]=Medium (Specular Aluminum) G=Wide (High Reflectance White)	[Blank]=Open A=Prismatic Acrylic Lens and Door Frame CL=Clear Acrylic Lens and Doorframe
Optional Aluminum Flange Trim ¹		Voltage ⁴		Options		
[Blank]=SW (Single White) EN=End of Row Natural Finish EW=End of Row White Finish RN=In Row Natural Finish RW=In Row White Finish SN=Single, Natural Finish		120V=120 Volt 277V=277 Volt 347V=347 Volt UNC=Universal 347/480 Voltage ⁵ UNV=Universal 120/277 Voltage ⁴		EL=Emergency Battery Installed (Must Specify Battery Pack, See Options) ⁴ Flex=Flex Installed (Reference Flex Ordering Information) GL=Single Element Fuse GM=Double Element Fuse Lamps Installed HL=Add HL at end of Lamp for High Lumen Lamps, T8 Only L5830=T5 Lamp, 85CRI 3000K L5835=T5 Lamp, 85CRI 3500K L5841=T5 Lamp, 85CRI 4100K L5850=T5 Lamp, 85CRI 5000K L8830=T8 Lamp, 85CRI 3000K L8835=T8 Lamp, 85CRI 3500K L8841=T8 Lamp, 85CRI 4100K L8850=T8 Lamp, 85CRI 5000K		
Ballast Type				Number of Ballasts	Options	Packaging
T5 Ballasts EBT_=T5 or T5HO Linear Electronic Program Start High Ambient. Total Harmonic Distortion < 10%. Standard Ballast Factor=1.0 EHT_=T5HO Linear Electronic Program Rapid Start High Ambient. Total Harmonic Distortion < 10%. T8 Ballasts⁶ EB8_=T8 Electronic Start. Total Harmonic Distortion < 10%. EB8_/PLUS=T8 Electronic Start. Total Harmonic Distortion < 10%. High Ballast Factor > 1.15 ER8_=T8 Electronic Program Rapid Start. Total Harmonic Distortion < 10%. ER8_/PLUS=T8 Electronic Program Rapid Start. Total Harmonic Distortion < 10%. High Ballast Factor > 1.15				1=1 Ballast 2=2 Ballasts 3=3 Ballasts	MWS=Modular Wiring System	PAL=Pallet Pack PALC=Job Pack, in carton U=Unit Pack

NOTES: 1. Specify row configuration, type in catalog number when ordering complete fixtures. 2. 2 ballasts are required when specifying 3 or more 28T5 lamps. 3. Exposed sockets and acrylic lenses may not be suitable for all environments. 4. Voltage must be specified when ordered with plugs or emergency ballasts. 5. 2 lamp ballast configurations only for T5 UNC versions. 2/3 lamp ballast configurations in EB8/PLUS only for T8 UNC versions. 6. ER8 and EB8 ballast systems suitable for operation in ambient environments up to 122°F (50°C) without lens option.

2' x 4', 4 LAMP

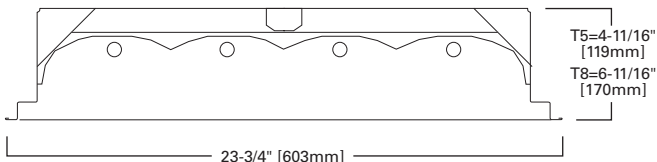

2' x 4', 6 LAMP

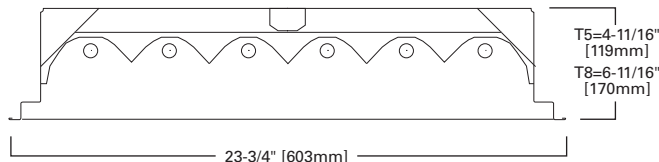

HOSE DOWN HIGH-BAY INDUSTRIAL



FEATURES

- White enamel finish improves efficiency and protects from corrosion
- Enclosed and gasketed hole-free housing
- 200 PSI hose-down rating is standard
- 4- or 6-lamp versions
- Particulock™ gasket system provides 200 PSI hose down rating

DIMENSIONS

2' x 4'

Compliances may not apply to all product configurations. Please consult the product spec sheet for compliance details.

COMPLIANCES: UL Listed - Wet Location, UL/cUL Listed, CSA Listed, CSA Listed - Wet Location, USDA, FDA, NSF, Federal Standard 209E

F-BAY 2HBHD SERIES



ORDERING INFORMATION

SAMPLE NUMBER: 2HBHD-654T5-A-UNV-EBT2-U

Width	Series	Number of Lamps (Not Included)	Lamp Type	Distribution	Shielding	Voltage ¹
2=24"	HBHD=High Bay Hose Down	4=4 Lamps 6=6 Lamps	28T5=28W T5 Lamps (48") 32=32W T8 Lamps (48") 49T5=49W T5HO (48") 51T5=51W T5HO (48") 54T5=54W T5HO Lamps (48")	[Blank]=Medium (Specular Aluminum) G=Wide (High Reflectance White)	A=Prismatic Acrylic Lens and Door Frame CL=Clear Acrylic Lens and Doorframe	120V=120 Volt 277V=277 Volt 347V=347 Volt 480V=480 Volt UNC=Universal 347/480 Voltage ² UNV=Universal 120/277 Voltage
Options		Ballast Type				Number of Ballasts
Emergency =EM Installed ¹ GL =Single Element Fuse GM =Double Element Fuse Lamps Installed HL =Add HL at end of Lamp for High Lumen Lamps, T8 Only L5830=T5 Lamp, 85CRI 3000K L5835=T5 Lamp, 85CRI 3500K L5841=T5 Lamp, 85CRI 4100K L5850=T5 Lamp, 85CRI 5000K L8830=T8 Lamp, 85CRI 3000K L8835=T8 Lamp, 85CRI 3500K L8841=T8 Lamp, 85CRI 4100K L8850=T8 Lamp, 85CRI 5000K		T5 Ballasts EBT =T5 or T5HO Electronic Program Rapid Start. Total Harmonic Distortion < 10%. Standard Ballast Factor=1.0 EHT =T5HO Linear Electronic Program Rapid Start High Ambient. Total Harmonic Distortion < 10%. T8 Ballasts EB8 =T8 Electronic Start. Total Harmonic Distortion < 10%. EB8 /PLUS =T8 Electronic Start. Total Harmonic Distortion < 10%. High Ballast Factor > 1.15 ER8 =T8 Electronic Program Rapid Start. Total Harmonic Distortion < 10%. ER8 /PLUS =T8 Electronic Program Rapid Start. Total Harmonic Distortion < 10%. High Ballast Factor > 1.15				1=1 Ballast 2=2 Ballasts 3=3 Ballasts
Options		Packaging				
C3=3' Power Cord C6=6' Power Cord PC3=3' Power Cord and Plug (Specify Voltage) ¹ PC6=6' Power Cord and Plug (Specify Voltage) ¹ SHN=Stainless Steel Housing Brushed 304 Finish SSN=Stainless Steel Door/Brushed 304 Finish		PAL=Pallet Pack PALC=Job Pack, in carton U=Unit Pack				

NOTES: 1. Voltage must be specified when ordered with plugs or emergency ballasts. 2. 2 lamp ballast configurations only in UNC versions. 2/3 lamp ballast configurations in EB8/PLUS only for T8 UNC versions.

4 LAMP

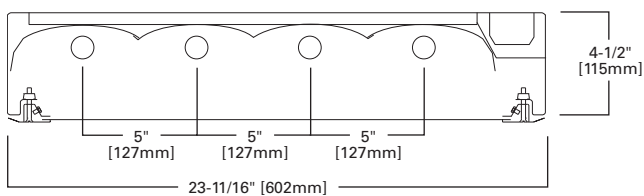

6 LAMP

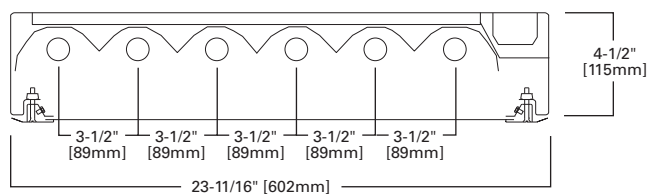

Specifications and dimensions subject to change without notice. Consult your Cooper Lighting Representative or visit www.cooperlighting.com for available options, accessories and ordering information.

FEATURES

- Food processing and demanding areas where cleaning is required
- Powder-coat finish or stainless steel
- Gasketed doorframe and lens seals housing to 800 PSI and IP65 rating
- Articulated top allows for water runoff during cleaning
- One-piece, heavy-gauge lens in clear or prismatic acrylic
- Segmented optical design optimizes performance by two distributions
- Product can be cable- or stem-mounted
- Standard, Class P, CBM/ETL ballast

DIMENSIONS

2' x 4'

Compliances may not apply to all product configurations. Please consult the product spec sheet for compliance details.

COMPLIANCES: UL Listed, CSA Listed - Wet Location, USDA, FDA, NSF, Federal Standard 209E



F-BAY 2HBHT SERIES

ORDERING INFORMATION

SAMPLE NUMBER: 2HBHT-654T5-A-UNV-EBT2-U

Width	Series	Number of Lamps (Not Included)	Lamp Type	Distribution	Shielding
2=24"	HBHT =High Bay Hose Down with Tented Top	4=4 Lamps 6=6 Lamps	28T5 =28W T5 Lamps (48") 32 =32W T8 Lamps (48") 49T5 =49W T5HO Lamps (48") 51T5 =51W T5HO Lamps (48") 54T5 =54W T5HO Lamps (48")	[Blank] =Medium (Specular Aluminum) G =Wide (High Reflectance White)	93 =Prismatic Tempered Glass and Steel Door Frame 94 =Clear Tempered Glass and Steel Door Frame A =Prismatic Acrylic Lens and Steel Door Frame CL =Clear Acrylic Lens and Steel Door Frame
Voltage ¹		Options		Ballast Type	
120V =120 Volt 277V =277 Volt 347V =347 Volt UNC =Universal 347/480 Voltage ² UNV =Universal 120/277 Voltage		EL =Emergency Battery Installed (Must Specify Battery Pack, See Options) ¹ GL =Single Element Fuse GM =Double Element Fuse Lamps Installed HL =Add HL at end of Lamp for High Lumen Lamps, T8 Only L5830 =T5 Lamp, 85CRI 3000K L5835 =T5 Lamp, 85CRI 3500K L5841 =T5 Lamp, 85CRI 4100K L5850 =T5 Lamp, 85CRI 5000K L8830 =T8 Lamp, 85CRI 3000K L8835 =T8 Lamp, 85CRI 3500K L8841 =T8 Lamp, 85CRI 4100K L8850 =T8 Lamp, 85CRI 5000K		T5 Ballasts ² EHT =T5 or T5HO Linear Electronic Program Rapid Start High Ambient. Total Harmonic Distortion < 10%. T8 Ballasts EB8 =T8 Electronic Start. Total Harmonic Distortion < 10%. EB8 /PLUS =T8 Electronic Start. Total Harmonic Distortion < 10%. High Ballast Factor > 1.15 ² ER8 =T8 Electronic Program Rapid Start. Total Harmonic Distortion < 10%. ER8 /PLUS =T8 Electronic Program Rapid Start. Total Harmonic Distortion < 10%. High Ballast Factor > 1.15	
Number of Ballasts		Options		Accessories (Order Separately)	
1=1 Ballast 2=2 Ballasts 3=3 Ballasts		C3 =3' Power Cord ³ C6 =6' Power Cord ³ PC3 =3' Power Cord and Plug (Specify Voltage) ^{1,3} PC6 =6' Power Cord and Plug (Specify Voltage) PM =Pendant Mount Stem ⁴ SHN =Brushed Stainless Steel Housing Finish SSN =Brushed Stainless Steel Door Finish		PAL =Pallet Pack PALC =Job Pack, in carton U =Unit Pack HBHT-Chain/Set =(2) 6 Foot Stainless Steel Chains, (4) Large S-Hooks Y-Hook =(2) Snap Hooks, #2 Cable (Specify 10' or 30'), Order (2) Per Fixture	

NOTES: 1. Voltage must be specified when ordered with plugs, motion sensor or emergency ballasts. 2. 2 lamp ballast configurations only for T5 UNC versions. 2/3 lamp ballast configurations in EB8/PLUS only for T8 UNC versions. 3. Available for chain or cable mount options only. 4. Always supplied with a 6 Foot 3-wire cord as standard through pendant stem hub.

2' x 4', 4 LAMP

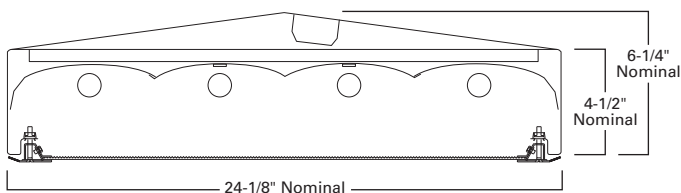

2' x 4', 6 LAMP

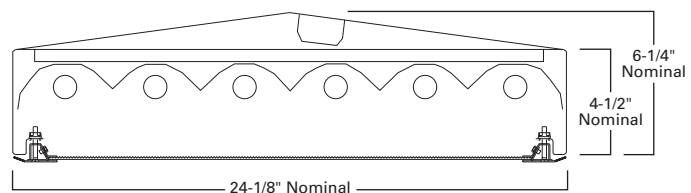

COLD STORAGE HIGH-BAY INDUSTRIAL



FEATURES

- For use in environments with ambient temperatures as low as -20° F
- Die-formed, cold-rolled steel housing, end plates and socket tracks
- Class P ballast, rated for -29°C to 90°C operation
- Finish is preceded by a multi-stage cleaning cycle
- Wide distribution for general open area lighting
- Sealed and gasketed doorframe available with a clear or prismatic lens
- Optical design optimizes performance across three distributions
- Suspension-mount with optional wire hook/chain, HB-SPM or cable mount
- Suited for surface and suspension mounting

DIMENSIONS

17" x 48"

ABI ARCTIC BAY SERIES

Compliances may not apply to all product configurations. Please consult the product spec sheet for compliance details.

COMPLIANCES: UL/cUL Listed, UL/cUL Listed - Damp Location



ORDERING INFORMATION

SAMPLE NUMBER: ABI-654T5-UNV-EBT2-MS/OB-U

Series	Number of Lamps (Not Included)	Lamp Type	Distribution	Shielding	Voltage ¹
ABI=Arctic Bay	4=4 Lamps 5=5 Lamps 6=6 Lamps	49T5=49W T5HO Lamps (48") 51T5=51W T5HO Lamps (48") 54T5=54W T5HO Lamps (48")	M=Medium Beam N=Narrow Beam (Standard) W=Wide Beam	[Blank]=Prismatic Acrylic Lens with Gasketed Door Frame CL=Clear Acrylic Lens with Gasketed Door Frame	120V=120 Volt 277V=277 Volt 347V=347 Volt 480V=480 Volt UNC=Universal 347/480 Voltage ² UNV=Universal 120/277 Voltage
Options			Ballast Type	Number of Ballasts	
EL=Emergency Installed (Must Specify Battery Pack, See Options) GL=Single Element Fuse GM=Double Element Fuse <u>Lamps Installed</u> L5830=T5 Lamp, 85CRI 3000K L5835=T5 Lamp, 85CRI 3500K L5841=T5 Lamp, 85CRI 4100K L5850=T5 Lamp, 85CRI 5000K			T5 Ballasts EBTL=T5 Linear Electronic Program Rapid Start. Total Harmonic Distortion < 10%. Minimum Start Temp. -20°F (-29°C)	1=1 Ballast 2=2 Ballasts 3=3 Ballasts	
Options			Packaging	Accessories (Order Separately)	
C3=3' White Cord Fixture Attached C6=6' White Cord Fixture Attached MS/IB=360° or 180° Motion Sensor Installed, Outside Lamps Constant On ³ MS/OB=360° or 180° Motion Sensor Installed, Inner 2 Lamps Constant On (4L, 5L) ³ PC3-Voltage=3' Cord/Plug Fixture Attached ¹ PC6-Voltage=6' Cord/Plug Fixture Attached ¹			PAL=Job Pack Out of Carton PALC=Job Pack In Carton U=Unit Pack	FH-1=Fixture Hook FL-1=Fixture Loop HB-SPM=Single Monopoint Hanger with Hub HBAYC-CHAIN/SET-U=(2) V-Hook Hangers, 36" Chain Sets with S-Hooks RH-1=Retrofit Hanger Y-TOGGLE=Y Mounting Toggle, #2 Cable (Specify 10' or 30', Requires 2 Per Fixture)	

NOTES: 1. Voltage must be specified when ordered with plugs or emergency ballasts. 2. 2 Lamp ballast configuration only for T5 UNC versions. 3. Specify voltage of ballast as UNV (120V-277V), 347V or 480V.

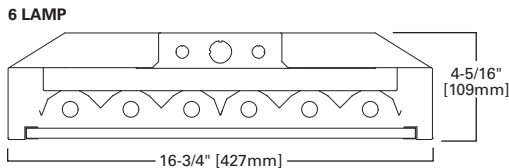
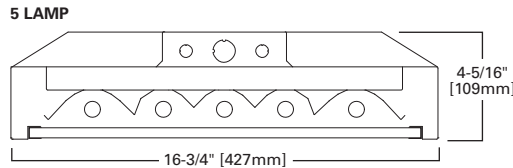
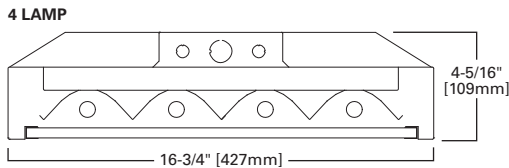

Specifications and dimensions subject to change without notice. Consult your Cooper Lighting Representative or visit www.cooperlighting.com for available options, accessories and ordering information.

T5 LINEAR INDUSTRIAL



F-BAY I5 SERIES

FEATURES

- Specification-grade, full-body housing end plates and socket tracks
- Narrow linear design for applications requiring T5 lamping
- Five-year, 55°C or three-year, 65°C ballast warranty
- Segmented optical design optimizes performance by 2 distributions
- Numerous shielding options available
- Standard 4' or 8' lengths
- Suspension-mount with optional wire hook and chain set
- F-Bay modular power supply available for quick power disconnect

DIMENSIONS

4', 8'

Compliances may not apply to all product configurations. Please consult the product spec sheet for compliance details.

COMPLIANCES: UL/cUL Listed, UL/cUL Listed - Damp Location



ORDERING INFORMATION

SAMPLE NUMBER: I5-354T5-UNV-EBT1-UPL-U

Length	Series	Mounting Arrangement	Number of Lamps (Not Included)	Lamp Type	Distribution Optic
8T=8' Length [Blank]=4' Length	I5=T5 Industrial	[Blank]=Stand Alone R=Continuous Row Mount (2" Row Coupler Included)	2=2 Lamps 3=3 Lamps 4=4 Lamps	28T5=28W T5 Std (4') Lamps 47T5=47W T5 HO (4') Lamps (48') 49T5=49W T5HO (4') Lamps 51T5=51W T5HO (4') Lamps 54T5=54W T5HO (4') Lamps	[Blank]=Medium (Specular Aluminum) G=Wide (High Reflectance White)
Shielding Options	Voltage ²	Options	Ballast Type	Number of Ballasts	
[Blank]=Open ASY=Asymmetric Directional Louver ¹ CL=Clear Acrylic Lens and Door Frame FL=Frosted Acrylic Lens and Frame ¹ TBW=Thin White Baffle WG=Heavy Duty Wireguard	120V=120 Volt 277V=277 Volt 347V=347 Volt 480V=480 Volt UNC=Universal 347/480 Voltage ³ UNV=Universal 120/277 Voltage	EL=Emergency Installed (Must Specify Battery Pack, See Options) GL=Single Element Fuse GM=Double Element Fuse I5 Lamps Installed⁴ L5830=T5 Lamp, 85CRI 3000K L5835=T5 Lamp, 85CRI 3500K L5841=T5 Lamp, 85CRI 4100K L5850=T5 Lamp, 85CRI 5000K	T5 Ballasts EBT=T5 or T5HO Linear Electronic Program Rapid Start Total Harmonic Distortion < 10%. Standard Ballast Factor=1.0 ⁵ EHT=T5HO Linear Electronic Program Rapid Start High Ambient. Total Harmonic Distortion < 10%. ⁶	1=1 Ballast 2=2 Ballasts 3=3 Ballasts	
Options	Packaging	Accessories (Order Separately)			
MP=Modular Power Receptacle (Used for All Cord or Cord and Plug Options) ⁷ MS=360° or 180° motion sensor installed, 120V through 347V, or 480V ⁸ MWS=Modular Wiring System ^{9,10} NUA=No upright apertures in housing. (Cannot be Combined with UPL) PI/CPI=Plug-In (1, 2 or 3) TILW=Tandem Inline Wiring UPL=Uplight Apertures	PAL=Palletized Out of Carton PALC=Palletized In Carton U=Unit Pack	AYC-CHAIN/SET/U=(2) Hooks, 36" Chain Sets with S-Hooks ¹¹ FH-1=Fixture Hook FL-1=Fixture Loop I5/I8-SPM=Single Monopoint Hanger with Hub LOOP=Loop Hanger, #2 Cable (Specify 10' or 30') MC6=6' Modular Power Cord MDS6=6' Modular Power Cord with MWS 27DS18/2G06MP Connector ⁹ MMS=360° or 180° Aisle Motion Sensor with Modular Power Receptacle (120-277V) ⁷ MPC6=6' Modular Power Cord and Plug (Specify Voltage) RH-1=Retrofit Hanger SHK=Hook with Safety Screw TOGGLE=Single Toggle, #2 Cable (Specify 10' or 30') Door Frames (For Field Installation) 90800PPK=Thin White Blade Baffle (I5) 90801PPK=Asymmetrical Directional Louver (I5) I5-FRM/CL PK=Clear Acrylic Lens and Frame (I5) I5-FRM/LENS=Frosted Acrylic Lens and Frame (I5) WG/I5-4FT-B=Heavy Duty Wireguard (I5)			

NOTES: 1. Use with wide distribution optic only. 2. Voltage must be specified when ordered with plugs, motion sensor or emergency ballasts. 3. 2 Lamp ballast configuration only for T5 UNC versions. 4. Must specify lamps when ordering. 5. EBT ballast systems suitable for operation in ambient environments up to 104°F (40°C). 6. EHT ballast systems suitable for ambient environments not to exceed 149°F (65°C) in open up light configurations and less lens option. 7. Requires use of MC or MPC cord accessories, specify voltage for plugs. 8. When ordering MS option, specify UNV (for 120 or 277V), 347 or 480V. 9. For MWS with MP, choose MP in fixture logic and then choose MWS accessory such as MDS6. 10. Cannot be combined with Modular Power Receptacle (MP). 11. Not for use in gymnasiums or similar recreational facilities.

4' or 8', 2 OR 4T LAMPS

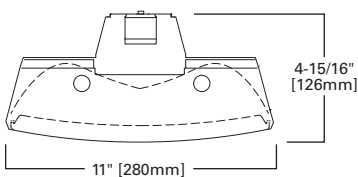

4' or 8', 3 OR 6T LAMPS

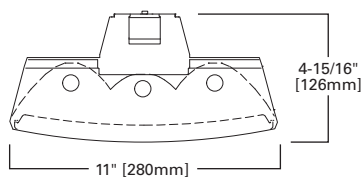

4' or 8', 4 OR 8T LAMPS

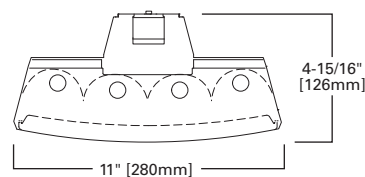

Specifications and dimensions subject to change without notice. Consult your Cooper Lighting Representative or visit www.cooperlighting.com for available options, accessories and ordering information.

T8 LINEAR INDUSTRIAL



FEATURES

- Specification-grade, full-body housing end plates and socket tracks
- Narrow linear design for applications requiring T8 lamping
- Five-year, 55°C or three-year, 65°C ballast warranty
- Segmented optical design optimizes performance by two distributions
- Numerous shielding options available
- Standard 4' or 8' lengths
- Suspension-mount with optional wire hook and chain set
- F-Bay modular power supply available for quick power disconnect

DIMENSIONS

4', 8'

Compliances may not apply to all product configurations. Please consult the product spec sheet for compliance details.

COMPLIANCES: UL/cUL Listed, UL/cUL Listed - Damp Location

F-BAY I8 SERIES

ORDERING INFORMATION

SAMPLE NUMBER: 8T18-432-L8830-UNV-EB81/PLUS-UPL-U

Length	Series	Mounting Arrangement	Number of Lamps (Not Included)	Lamp Type	Distribution Optic	Shielding Options
8T=8' Length [Blank]=4' Length	I8=T8 Industrial	[Blank]=Stand Alone R=Continuous Row Mount (2" Row Coupler Included)	2=2 Lamps 3=3 Lamps 4=4 Lamps	32=32W T8 (4') Lamps	[Blank]=Medium (Specular Aluminum) G=Wide (High Reflectance White)	[Blank]=Open ASY=Asymmetric Directional Louver ¹ CL=Clear Acrylic Lens and Door Frame ¹ FL=Frosted Acrylic Lens and Frame ¹ TBW=Thin White Baffle WG=Heavy Duty Wireguard
Voltage ²	Options	Ballast Type			Number of Ballasts	
120V=120 Volt 277V=277 Volt 347V=347 Volt 480V=480 Volt UNC=Universal 347/480 Voltage ³ UNV=Universal 120/277 Voltage	EL=Emergency Installed (Must Specify Battery Pack, See Options) GL=Single Element Fuse GM=Double Element Fuse I8 Lamps Installed HL=Add HL at end of Lamp for High Lumen Lamps, T8 Only L8830=T8 Lamp, 85CRI 3000K L8835=T8 Lamp, 85CRI 3500K L8841=T8 Lamp, 85CRI 4100K L8850=T8 Lamp, 85CRI 5000K	T8 Ballasts ⁴ EB8 =T8 Electronic Instant Start. Total Harmonic Distortion < 10%. EB8 /PLUS=T8 Electronic Instant Start. Total Harmonic Distortion < 10%. High Ballast Factor > 1.15 ER8 =T8 Electronic Program Rapid Start. Total Harmonic Distortion < 10%. ⁵ ER8 /PLUS=T8 Electronic Program Rapid Start. Total Harmonic Distortion < 10%. High Ballast Factor > 1.15 ⁵			1=1 Ballast 2=2 Ballast 3=3 Ballast	
Options	Packaging	Accessories (Order Separately)				
MP=Modular Power Receptacle (Used for All Cord or Cord and Plug Options) ⁶ MS=360° or 180° Motion Sensor, 120 through 347, or 480V ⁷ MWS=Modular Wiring System ^{8,9} NUA=No Uplight Apertures In Housing (Cannot be Combined with UPL) PI/CPI=Plug-In (1, 2 or 3) TILW=Tandem Inline Wiring UPL=Uplight Apertures	PAL=Palletized Out of Carton PALC=Palletized In Carton U=Unit Pack	AYC-CHAIN/SET/U=(2) Hooks, 36" Chain Sets with S-Hooks ¹⁰ FH-1=Fixture Hook FL-1=Fixture Loop I5/I8-SPM=Single Monopoint Hanger with Hub LOOP=Loop Hanger, #2 Cable (Specify 10' or 30') MC6=6' Modular Power Cord MDS6=6' Modular Power Cord with MWS 27DS18/2G06MP Connector ⁸ MMS=360° or 180° Aisle Motion Sensor with Modular Power Receptacle (120-277V) ⁶ MPC6=6' Modular Power Cord and Plug (Specify Voltage) RH-1=Retrofit Hanger SHK=Hook with Safety Screw TOGGLE=Single Toggle, #2 Cable (Specify 10' or 30') Door Frames (For Field Installation) BAFFLE 4FT I8=Thin White Blade Baffle (I8) I8-FRM/CL PK=Clear Acrylic Lens and Frame (I8) I8-FRM/FL PK=Frosted Acrylic Lens and Frame (I8) WG/I8-4FT-B=Heavy Duty Wireguard (I8)				

NOTES: 1. Use with wide distribution optic only. 2. Voltage must be specified when ordered with plugs, motion sensor or emergency ballasts. 3. 2/3 lamp ballast configuration in EB8/PLUS for T8 UNC version. 4. ER8 and EB8 ballast systems suitable for operation in ambient environments up to 122°F (50°C) in open upright configurations. 5. Recommended when using motion sensor options or accessories. 6. Requires use of MC or MPC cord accessories, specify voltage for plugs. 7. When ordering MS option, specify UNV (for 120 or 277V), 347 or 480V. 8. For MWS with MP, choose MP in fixture logic and then choose MWS accessory such as MDS6. 9. Cannot be combined with Modular Power Receptacle (MP). 10. Not for use in gymnasiums or similar recreational facilities.

4' or 8', 2 LAMPS

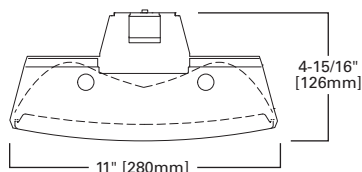

4' or 8', 3 LAMPS

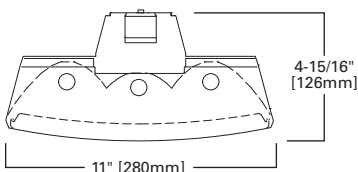

4' or 8', 4 LAMPS

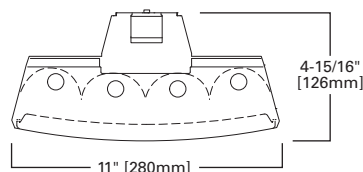
Specifications and dimensions subject to change without notice. Consult your Cooper Lighting Representative or visit www.cooperlighting.com for available options, accessories and ordering information.

FEATURES

- Available in one- or two-lamp version, using T5 or T8 lamps
- Specular Miro® 4 reflectors for precise light control
- Three optical distribution patterns available
- White enamel finish improves efficiency and protects from corrosion
- Easily suspended and adjusted using various cable-mounting methods
- Ideal for continuous row-mounting in narrow-aisle applications
- Occupancy sensor instantly turn lights on and off
- Flip-up socket feature for faster installation out of the box
- Optional pre-wire multiple circuit plug-in connectors

DIMENSIONS

4', 8'

Compliances may not apply to all product configurations. Please consult the product spec sheet for compliance details.

COMPLIANCES: UL/cUL Listed, UL/cUL Listed - Damp Location



**F-BAY MBF
MICRO-BAY
SERIES**



ORDERING INFORMATION

SAMPLE NUMBER: MBF-132-NB-UNV-EB81-U

Tandem	Series	Number of Lamps (Not Included)	Lamp Types	Reflector	Voltage ¹	Options
8T=8' Length [Blank]=4' Length	MBF=Micro-Bay	1=1 Lamp 2=2 Lamps	32=32W T8 (48") 47T5=47W T5HO (48") 49T5=49W T5HO (48") 51T5=51W T5HO (48") 54T5=54W T5HO (48")	FB=Focus Beam NB=Normal Beam TB=Task Beam (Medium-1 Lamp Only)	120V=120 Volt 277V=277 Volt 347V=347 Volt UNC=Universal 347/480 Voltage ² UNV=Universal 120/277 Voltage	EL=Emergency Battery Installed (Must Specify Battery Pack, See Options) GL=Single Element Fuse GM=Double Element Fuse
Ballast Type				Number of Ballasts	Options	
T5 Ballasts EBT =T5 or T5HO Electronic Program Rapid Start. Total Harmonic Distortion < 10%. Standard Ballast Factor=1.0 EHT =T5HO Linear Electronic Program Rapid Start High Ambient. Total Harmonic Distortion < 10%. T8 Ballasts³ EB8 =T8 Electronic Start. Total Harmonic Distortion < 10%. EB8 /PLUS=T8 Electronic Start. Total Harmonic Distortion < 10%. High Ballast Factor > 1.15 ER8 =T8 Electronic Program Rapid Start. Total Harmonic Distortion < 10%. ER8 /PLUS=T8 Electronic Program Rapid Start. Total Harmonic Distortion < 10%. High Ballast Factor > 1.15 ⁴				1=1 Ballast 2=2 Ballasts	C3=3' Power Cord C6=6' Power Cord PC3=3' Power Cord and Plug (Specify Voltage) ¹ PC6=6' Power Cord and Plug (Specify Voltage) ¹ PI/CPI=Plug-In (1, 2 or 3)	
Packaging		Accessories (Order Separately)				
U=Unit Pack		ATG-SSF-4-U=Tong Hanger AYC-CHAIN/SET/U=(2) Hooks, 36" Chain Sets with S-Hooks MBF-SENSOR-KIT-CTR/MT-U=Aisle Coverage Motion Sensor, Center Mount Hardware, 120/277V ^{1,5} MBF-SENSOR-KIT-END/MT-U=Aisle Coverage Motion Sensor, End Mount Hardware, 120/277V ^{1,5} SSF-EXT-LONG-CONN-KIT-U=Rigid Connector Support for Continuous Channel Installation TOGGLE=Single Toggle, #2 Cable (Specify 10' or 30') Y-TOGGLE=Y Mounting Toggle, #2 Cable (Specify 10' or 30') ⁶				

NOTES: 1. Voltage must be specified when ordered with plugs, motion sensor or emergency ballasts. 2. 2 lamp ballast configurations only for T5 UNC versions. 2/3 lamp ballast configurations in EB8/PLUS only for T8 UNC versions. 3. ER8 and EB8 ballast systems suitable for operation in ambient environments up to 50°C. 4. Recommended when using motion sensor options or accessories. 5. Must ship separately. 6. Use with continuous row mount at fixture joint only.

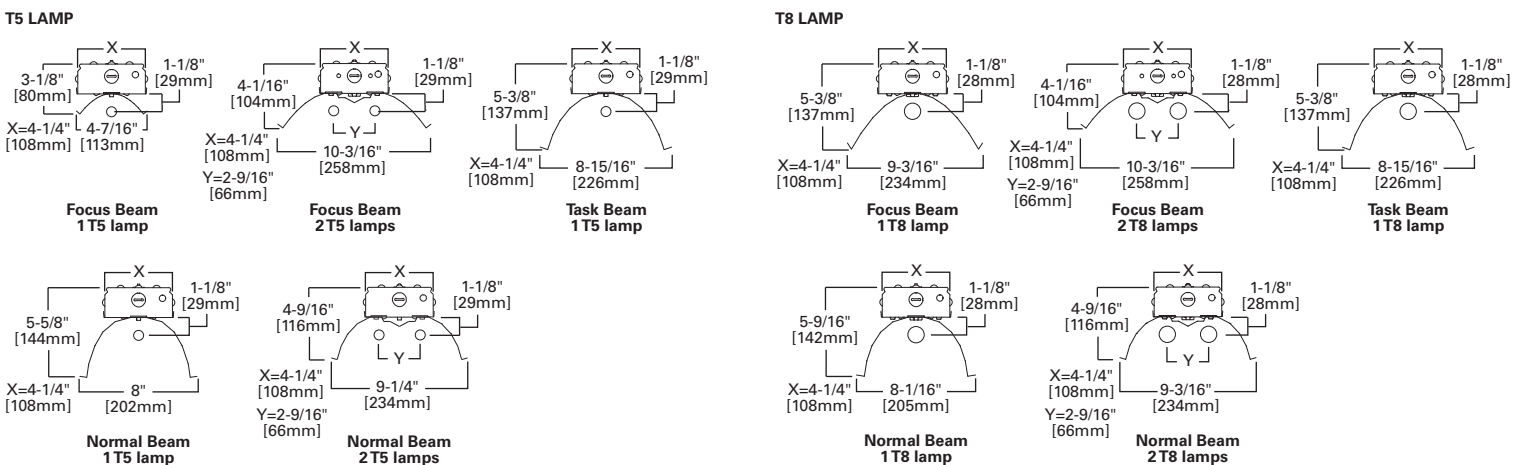

Specifications and dimensions subject to change without notice. Consult your Cooper Lighting Representative or visit www.cooperlighting.com for available options, accessories and ordering information.

VAPORTITE INDUSTRIAL



FEATURES

- Ideal for cold-storage applications
- LEDs available in 3500K or 4000K with 85 CRI
- Wet-location rated
- Narrow and wide distributions
- 2' and 4' housings
- Modular design with quick disconnects
- 0-10V dimming driver is standard

DIMENSIONS

2', 4'

Compliances may not apply to all product configurations. Please consult the product spec sheet for compliance details.

COMPLIANCES: UL Listed, UL Listed - Wet Location, IP65 Rated

VAPORTITE LED SERIES



ORDERING INFORMATION

SAMPLE NUMBER: VT-58DR-UNV-L835-CD2-WL-U

Series	LED Lumens Output	Lens	Distribution	Voltage	Lamps	Driver Type	Number of Drivers
VT=Vaportite	2' Housing 27=2700 Lumens ¹ 30=3000 Lumens 4' Housing 55=5500 Lumens ¹ 58=5800 Lumens	DR =Internal Prismatic Lens/15% DR High Impact Additive (Standard) DR-100% =100% High Impact Additive	[Blank] =Narrow Standard W =Wide Distribution	UNV =Universal Voltage 120-277	L835 =3500K L840 =4000K	CD =0-10V Dimming Driver	1 =1 Driver 2 =2 Drivers
Wet Location		Options	Packaging	Accessories (Order Separately)			
WL =Wet Location Label		SSL =Stainless Steel Latches	U =Unit Pack	VT2-Chain/Set-U =Chain Hanging Set (Order One Kit for Each 2' or 4' Fixture, Two Kits for Each 8' Fixture) VT2-SS-MBK =Stainless Steel Mounting Bracket			

NOTES: 1. Only available in Wide Distribution.

NARROW DISTRIBUTION

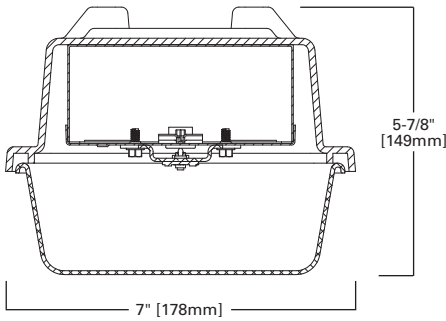

WIDE DISTRIBUTION

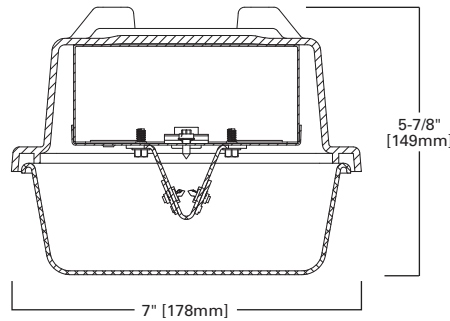

Specifications and dimensions subject to change without notice. Consult your Cooper Lighting Representative or visit www.cooperlighting.com for available options, accessories and ordering information.

FEATURES

- Enclosed Vaportite® high bay for food processing and demanding areas
- Polyester fiberglass housing UL94 and UL746 5VA flammability rated
- Rotolock lampholders and CBM/ETL Class P certified to 70°C
- High-impact, clear acrylic or optional 100% polycarbonate lens
- IP65 and IP67 certified; NSF listed and NEMA 4X rated
- Internal specular aluminum reflector
- Electrical components and fixtures are UL/cUL listed for wet location
- Two stainless mounting bails or optional Y-hook cable mount
- Water-tight hubs for 1/2" conduit entry provided at end of housing

DIMENSIONS

4'

Compliances may not apply to all product configurations. Please consult the product spec sheet for compliance details.
COMPLIANCES: UL/cUL Listed - Wet Location, IP65 Rated, IP67 Rated, NSF Certified, NEMA 4X Rated



VT4 SERIES



ORDERING INFORMATION

SAMPLE NUMBER: VT4-654T5-M-DR-UNC-EHT2-WL-U

Series	Number of Lamps (Not Included)	Wattage (Length)	Distribution	Lens	Voltage ¹
VT4=Vaportite 4 or 6 Lamp	4=4 Lamps 6=6 Lamps	32=32W T8 (48") 47T5=47W T5HO (48") 49T5=49W T5HO Lamps (48") 51T5=51W T5HO Lamps (48") 54T5=54W T5HO (48")	M=Medium Beam W=Wide Beam (White)	DR=Clear Acrylic High Impact (Standard) PC=Polycarbonate, Clear	120V=120 Volt 277V=277 Volt 347V=347 Volt UNC=Universal Voltage 347/480 ² UNV=Universal Voltage 120/277
Options		Ballast Type		Number of Ballasts	
EL=Emergency Installed (Must Specify Battery Pack, See Options) GL=Single Element Fuse GM=Double Element Fuse		T5 Ballasts EHT_=T5HO Linear Electronic Program Rapid Start High Ambient. Total Harmonic Distortion < 10%. ³ T8 Ballasts EB8_=T8 Electronic Instant Start. Total Harmonic Distortion < 10%. EB8_/PLUS=T8 Electronic Instant Start. Total Harmonic Distortion < 10%. High Ballast Factor > 1.15 ER8_=T8 Electronic Program Rapid Start. Total Harmonic Distortion < 10%. ER8_/PLUS=T8 Electronic Program Rapid Start. Total Harmonic Distortion < 10%. High Ballast Factor > 1.15		1=1 Ballast 2=2 Ballasts 3=3 Ballasts	
Label	Options	Packaging	Accessories (Order Separately)		
WL=Wet Label	[Blank]=(2) End Watertite Hubs (All Watertite Hubs have 1/2" Conduit Entry) C3=3' Power Cord C6=6' Power Cord MS=360° or 180° Motion Sensor, Damp Location ^{4,5} MS/WL=180° Motion Sensor, Wet Location ^{6,7} MSO/WL=360° Motion Sensor, Wet Location ^{6,7} PC3=3' Power Cord and Plug (Specify Voltage) ¹ PC6=6' Power Cord and Plug (Specify Voltage) ¹ VRS=Vandal Resistant Screws for Latches	U=Unit Pack	VT4-SS-SM=(2) Stainless Steel Surface Mounting Bracket Y-TOGGLE=Y Mounting Toggle, #2 Cable (Specify 10' or 30')		

NOTES: 1. Voltage must be specified when ordered with plugs or emergency ballasts. 2. 2 lamp ballast configurations only for T5 UNC versions. 2/3 lamp ballast configurations in EB8/PLUS only for T8 UNC versions.
 3. For ambient greater than 40°C (102°F) EHT3 is recommended for 654T5 configuration. 4. When ordering MS option, specify UNV (for 120 or 277V), 347 or 480V. 5. Must specify DL when ordering MS option. 6. Must specify voltage. 7. Must specify WL when ordering MS/WL or MSO/WL.

4', 4 LAMP

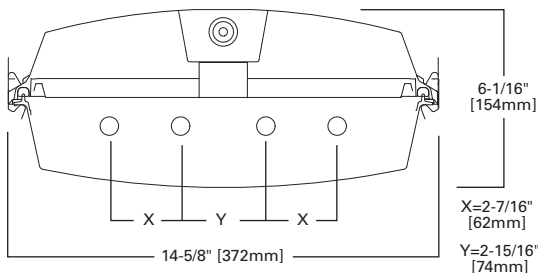

4', 6 LAMP

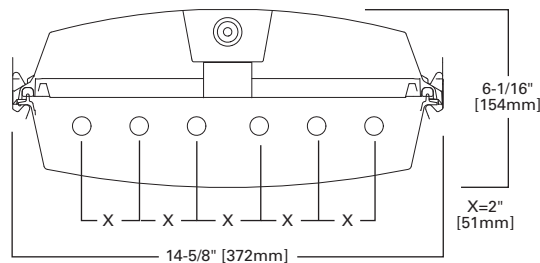

VAPORTITE INDUSTRIAL



FEATURES

- Maximum operation in commercial and industrial environments
- Polyester and self-extinguishing (ASTM-D635-74) plastic
- Ballasts are CBM/ETL Class P certified suitable to 70°F
- New contemporary-styled, clear acrylic, impact-resistant lens
- Rotolock electrical components and fixture UL/cUL listed
- IP65 certified and NSF listed, IP67 (4' only) with eight latches
- Optional chain mount hanging set or snap-on brackets
- Surface-mount fixture using two galvanized brackets
- Internal fasteners and tethers provide maximum protection and rigidity

DIMENSIONS

4', 8'

VT3 SERIES

Compliances may not apply to all product configurations. Please consult the product spec sheet for compliance details.

COMPLIANCES: UL/cUL Listed - Wet Location, IP65 Rated, IP67 Rated

ORDERING INFORMATION

SAMPLE NUMBER: VT3-232DR-UNV-EB81-WL-U

Tandem	Series	Number of Lamps (Not Included) ¹	Wattage (Length)	Lens	Voltage ²
8T=8' Length [Blank]=4' Length	VT3=Vaporite (Gasketed Enclosure)	1=1 Lamp 2=2 Lamps 3=3 Lamps (Not Included)	28T5=28W T5 (48") 32=32W T8 (48") 54T5=54W T5HO (48") ¹	DR=Internal Prismatic Lens/15% DR High Impact Additive (Standard) DR-100=100% High Impact Additive (Extreme) DR-50=50% High Impact Additive	120V=120 Volt 277V=277 Volt 347V=347 Volt UNC=Universal 347/480 Voltage ³ UNV=Universal Voltage 120/277V
Options	Ballast Type			Number of Ballasts	Label
EL=Emergency Installed (Must Specify Battery Pack, See Options) GL=Single Element Fuse GM=Double Element Fuse	T5 Ballasts EBT_=T5 or T5HO Electronic Program Rapid Start. Total Harmonic Distortion < 10%. Standard Ballast Factor=1.0 EHT_=T5HO Linear Electronic Program Rapid Start High Ambient. Total Harmonic Distortion < 10%. ⁴ T8 Ballasts EB8_=T8 Electronic Instant Start. Total Harmonic Distortion < 10%. EB8_/PLUS=T8 Electronic Instant Start. Total Harmonic Distortion < 10%. High Ballast Factor > 1.15 ER8_=T8 Electronic Program Rapid Start. Total Harmonic Distortion < 10%. ⁵ ER8_/PLUS=T8 Electronic Program Rapid Start. Total Harmonic Distortion < 10%. High Ballast Factor > 1.15 ⁵			1=1 Ballast 2=2 Ballasts	DL=Damp Location WL=Wet Location Label ⁶
Options	Packaging	Accessories (Order Separately)			
8L=8 Latches (IP67 Rating), (4' Only) BKS=(2) Snap-on Brackets for Chain or Surface Mount M4=Specular Reflector MS=360° or 180° Motion Sensor, Damp Location ^{7,8} MS/WL=180° Motion Sensor, Wet Location ^{9,6} MSO/WL=360° Motion Sensor, Wet Location ^{9,6} SSL=Stainless Steel Latches TEH=(2) Top and (2) End Watertite Hubs (All Watertite Hubs Have 1/2" Conduit Entry) ¹⁰ TH=(2) Top Watertite Hubs ¹⁰ VRS=Vandal Resistant Screws for Latches	PALC=Job Pack, in carton U=Unit Pack	VT2 Stem Bushing=1/2" - 3/8" (Required When Using Stem/Sets, Requires (1) Per (Stem/Set) VT2-Chain/Set-U=Chain Hanging Set Includes 6 Foot of chain, 4 Large S-Hooks and 4 Small S-Hooks. ¹¹ VT2-SS-MBK=Stainless Steel Mounting Brackets. ¹¹ VT3-4FT-M4 PK=4' Specular Interior Reflector Pack for VT3 (Stock Product) VT3-BKS2-PK=(2) Snap-on Brackets for Surface or Chain Mount. Adjustable along length of Fixture.			

NOTES: 1. EHT2 ballasts are recommended for ambient temperatures above 102°F (40°C) 3 Lamp 54W T5HO configuration. 2. Voltage must be specified when ordered with plugs, motion sensor or emergency ballasts. 3. 2 lamp ballast configurations only for T5 UNC versions. 2/3 lamp ballast configurations in EB8/PLUS only for T8 versions. 4. Use EHT1 ballast in ambient temperatures below 0°F (-18°C) on 3 Lamp 54W T5HO configurations. 5. Recommended when using motion sensor options or accessories. 6. Must specify WL when ordering MS/WL or MSO/WL. 7. When ordering MS option, specify UNV (for 120 or 277V), 347 or 480V. 8. Must specify DL when ordering MS option. 9. Must specify voltage. 10. Top Hub required when stem mounting. 11. Order one (1) kit for 4 Foot fixture, or two (2) kits for 8 Foot fixture.

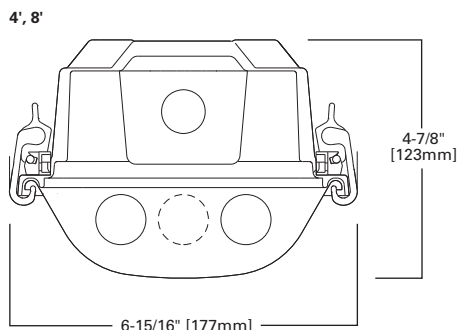
Specifications and dimensions subject to change without notice. Consult your Cooper Lighting Representative or visit www.cooperlighting.com for available options, accessories and ordering information.

FEATURES

- Designed for commercial, institutional and industrial environments
- Fiberglass housing is self-extinguishing (ASTM-D635-74) plastic
- Ballasts are CBM/ETL Class P certified to 70°C
- Optional clear injection-molded internal prism lens
- Full-metal gear tray secured by internal fasteners
- Electrical components and fixtures are IP65 certified and NSF listed
- Two stainless steel brackets with chain-mount bail
- Adjustable brackets along fixture length for variable mounting centers



VT1 SERIES

DIMENSIONS

4'

Compliances may not apply to all product configurations. Please consult the product spec sheet for compliance details.

COMPLIANCES: UL/cUL Listed - Wet Location, IP65 Rated, NSF Certified



ORDERING INFORMATION

SAMPLE NUMBER: VT1-154T5-PCR-UNV-EBT1-WL-U

Series	Number of Lamps (Not Included)	Wattage (Length)	Lens	Voltage ¹	Options
VT1=Vaportite	1=1 Lamp	28T5=28W T5 (48") 32=32W T8 (48") 54T5=54W T5HO Lamps (48")	PCR=Lineal Ribs Polycarbonate (Standard)	120V=120 Volt 277V=277 Volt 347V=347 Volt UNC=Universal Voltage 347/480 UNV=Universal Voltage 120-277	EL=Emergency Installed (Must Specify Battery Pack, See Options) GL=Single Element Fuse GM=Double Element Fuse
Ballast Type			Number of Ballasts	Label	Options
T5 Ballasts EBT_=T5 or T5HO Electronic Program Rapid Start. Total Harmonic Distortion < 10%. Standard Ballast Factor=1.0 EHT_=T5HO Linear Electronic Program Rapid Start High Ambient. Total Harmonic Distortion < 10%. T8 Ballasts EB8_= T8 Electronic Start. Total Harmonic Distortion < 10%. EB8_/PLUS=T8 Electronic Start. Total Harmonic Distortion < 10%. High Ballast Factor > 1.15 ER8_= T8 Electronic Program Rapid Start. Total Harmonic Distortion < 10%. ER8_/PLUS=T8 Electronic Program Rapid Start. Total Harmonic Distortion < 10%. High Ballast Factor > 1.15			1=1 Ballast	WL=Wet Label	[Blank]=(2) End Watertite Hubs (All Watertite Hubs have 1/2" Conduit Entry) C3=3' Power Cord C6=6' Power Cord PC3=3' Power Cord and Plug (Specify Voltage) ¹ PC6=6' Power Cord and Plug (Specify Voltage) ¹ SSL=Stainless Steel Latches VRS=Vandal Resistant Screws for Latches
Packaging		Accessories (Order Separately)			
U=Unit Pack		VT2-CHAIN/SET-U=Chain Hanging Set Includes 6 Foot of Chain, 4 Large S-Hooks and 4 Small S-Hooks. Order One (1) Kit for Each 4' Fixture			

NOTES: 1. Voltage must be specified when ordered with plugs or emergency ballasts.

4', 1 LAMP

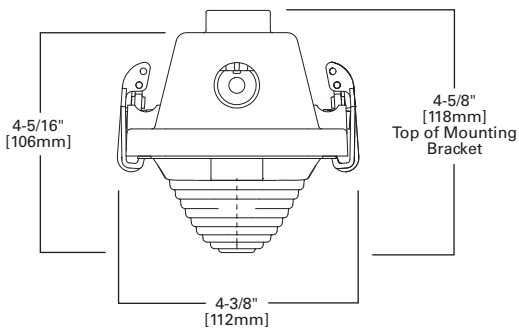

INDUSTRIALS T5, T8, T5HO



FEATURES

- Heavy-duty, apertured or closed-top reflector
- Apertured reflector standard with 8% uplight
- Flip-up socket feature for faster installation
- Die-formed channel with baked-white enamel finish
- Pressure lock or spring-loaded lampholders
- Wire guards available for special application
- Silver-lining reflector finish available
- Tandem 8' lengths
- Lamps not included with either IAF or ICF series

DIMENSIONS

4', 8'

IAF, ICF SERIES

Compliances may not apply to all product configurations. Please consult the product spec sheet for compliance details.

COMPLIANCES: UL/cUL Listed - Damp Location



ORDERING INFORMATION

SAMPLE NUMBER: ICF-232-UNV-HB81-U

Tandem	Series	SilverLining	Number of Lamps (Not Included)	Wattage	Voltage ²	
8T=8' Length [Blank]=4' Length	IAF=Apertured Reflector ICF=Closed Top Reflector	[Blank]=White (Standard) SS=Silver-Lining Reflector ⁸	1=1 Lamp 2=2 Lamps 3=3 Lamps	17=17W T8 (24") 28T5=28W T5 (48") 28T8=28W T8 (48") ⁷ 32=32W T8 (48") 40=40W T12 (48")	48HO=60W T12HO (48") 48T8HO=44W T8HO (48") 54T5=54W T5HO (48") 96=59W T8SL (96") 96HO=95/110W T12HO (96") 96T8HO=86W T8HO (96")	120V=120 Volt 277V=277 Volt 347V=347 Volt UNV=Universal Voltage 120-277 ¹
Options ³	Ballast Type			Number of Ballasts		
EL4=Emergency Installed EL5=Emergency Installed EL5HO=Emergency Installed for T5HO EL8=Emergency Installed GL=Single Element Fuse GM=Double Element Fuse	<p>T5 Ballasts EBT_T5 or T5HO Electronic Program Rapid Start. Total Harmonic Distortion < 10%. Standard Ballast Factor=1.0</p> <p>Ballast/Factor Type (T5) EBT_H=T5 Electronic Program Rapid Start. Total Harmonic Distortion < 10%. High Ballast Factor=1.15¹¹ EBT_HDIM=T5 Electronic Program Rapid Start. Total Harmonic Distortion < 10%. Step Dimming, High Ballast Factor=1.15¹² EBT_N=T5 Electronic Program Rapid Start. Total Harmonic Distortion < 10%. Normal Ballast Factor=.90 EBT_NDIM=T5 Electronic Program Rapid Start. Total Harmonic Distortion < 10%. Step Dimming, Normal Ballast Factor=.95-1.0¹³</p> <p>T8 Ballasts EB8_T8 Electronic Start. Total Harmonic Distortion < 10%. EB8_PLUS=T8 Electronic Start. Total Harmonic Distortion < 10%. High Ballast Factor > 1.15 ER8_T8 Electronic Program Rapid Start. Total Harmonic Distortion < 10%. ER8_PLUS=T8 Electronic Program Rapid Start. Total Harmonic Distortion < 10%. High Ballast Factor > 1.15</p> <p>High Performance T8 Ballasts HB8_T8 Electronic Instant Start. Total Harmonic Distortion < 10%. Standard Ballast Factor .86-.88 HB8_H=T8 Electronic Instant Start. Total Harmonic Distortion < 10%. High Ballast Factor 1.15-1.20 HB8_L=T8 Electronic Instant Start. Total Harmonic Distortion < 10%. Low Ballast Factor .77-.82 HB8_N=T8 Electronic Instant Start. Total Harmonic Distortion < 10%. Normal Ballast Factor 1.0 HR8_T8 Electronic Program Rapid Start. Total Harmonic Distortion < 10%. Standard Ballast Factor .86-.88 HR8_DIM=T8 Electronic Program Rapid Start. Total Harmonic Distortion < 10%. Step Dimming, Ballast Factor .88 HR8_H=T8 Electronic Program Rapid Start. Total Harmonic Distortion < 10%. High Ballast Factor 1.15-1.20 HR8_L=T8 Electronic Program Rapid Start. Total Harmonic Distortion < 10%. Low Ballast Factor .71-.79</p> <p>T12 Ballasts EB2_T12 Electronic Rapid Start. Total Harmonic Distortion < 20%.</p>			1=1 Ballast 2=2 Ballasts		
Options	Accessories (Order Separately)					
PI/CPI=Plug-In Option RIF1=Radio Interference Suppressor TILW=Tandem In-Line Wiring Option (Consult TILW Options Catalog Page) ^{3,9} WG/IC-4FT-U (IAF, ICF)=Wireguard for IAF/ICF	<p>A1B/Spacer-U=Spacer 1-1/2" to 2-1/2" From Ceiling (Use 2 Per Fixture) AYC-Chain/Set-U=Chain Hanger Set (Use 1 Set Per Fixture) CLC-SSF=Long Channel Connector SSF GRP-SSF=Gripper Hanger (Use 2 Per Fixture) SCA=Adjustable 48" Stem Set SCF=Fixed Stem Set (Specify Length) SCS=Swivel Stem Set (Specify Length) TOGGLE=Single Toggle Number 2 (Specify Length) WG/ICF-4FT-U=Wire Guard Y-TOGGLE=Y Toggle Number 2 (Specify Length)</p>					

NOTES: 1. Not available when specifying emergencies, voltage must be specified. Exception EL4. 2. Products also available in non-US voltage and frequencies for international markets. 3. See Options or Accessories.
4. 1-Lamp ballast in a High Ballast factor not available. 5. Step Dimming ballast available for 28W T5 and 14WT5 lamps only. 6. 1 Lamp step dimming ballast in normal ballast factor not available. 2-lamp ballast will not operate 1 lamp. 7. HPT8 Ballast required with 28W T8 lamps. 8. Not available with HO lamps. 9. Socket brackets left uninstalled. 10. Not available when specifying emergencies, voltage must be specified. 11. 1-Lamp ballast in a High Ballast factor not available. 12. Step Dimming ballast available for 28W T5 and 14WT5 lamps only. 13. 1-Lamp step dimming ballast in a Normal Ballast factor not available. 2-Lamp ballast will not operate 1-Lamp.

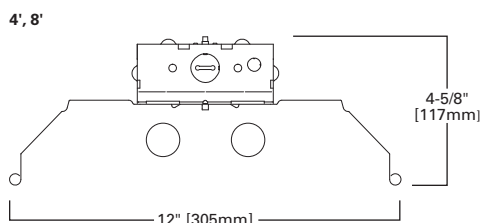

Specifications and dimensions subject to change without notice. Consult your Cooper Lighting Representative or visit www.cooperlighting.com for available options, accessories and ordering information.

FEATURES

- Equipped with energy-saving ballasts
- Die-formed channels
- Heavy-duty, apertured or closed-top reflector
- Pressure-lock lampholders (RS), spring loaded lampholders (SL, HO)
- Deep-draw, full-width reflector ribs add rigidity
- Baked white enamel finish
- Apertured reflector standard with 6% uplight
- Porlux and silver-lined finishes
- Also available in tandem 8' lengths

DIMENSIONS

4', 8'

Compliances may not apply to all product configurations. Please consult the product spec sheet for compliance details.

COMPLIANCES: UL/cUL Listed, UL/cUL Listed - Damp Location



DIF SERIES



ORDERING INFORMATION

SAMPLE NUMBER: DIF-232-UNV-EB81-U

Tandem	Series	Silver Reflector	Number of Lamps (Not Included)	Wattage (Length)	Voltage	Options
8T=8' Length [Blank]=4' Length	DCIF=Closed Top Reflector DIF=Apertured Reflector	SS=SilverLining Reflector ¹	2=2 Lamps	28T5=28W T5 (48") 28T8=28W T8 (48") 32=32W T8 (48") 48HO=44W T8 (48") HO 54T5=54W T5HO (48") 96=59W T8 SL (96") 96HO=86W T8 (96") HO	120V=120 Volt 277V=277 Volt 347V=347 Volt UNV=Universal Voltage 120-277	EL=Emergency Battery Installed (Must Specify Battery Pack, See Options) GL=Single Element Fuse GM=Double Element Fuse

Ballast Type

T5 Ballasts

EBT =T5 or T5HO Linear Electronic Program Rapid Start. Total Harmonic Distortion < 10%.

Ballast/Factor Type (T5)

EBT_H=T5 Electronic Program Rapid Start. Total Harmonic Distortion < 10%. High Ballast Factor 1.15²

EBT_HDIM=T5 Electronic Program Rapid Start. Total Harmonic Distortion < 10%. Step Dimming, High Ballast Factor = 1.15³

EBT_N=T5 Electronic Program Rapid Start. Total Harmonic Distortion < 10%. Normal Ballast Factor .90

EBT_NDIM=T5 Electronic Program Rapid Start. Total Harmonic Distortion < 10%. Step Dimming, Normal Ballast Factor .95-1.0⁴

T8 Ballasts

EB8 =T8 Electronic Instant Start, Total Harmonic Distortion < 10%.

EB8_/PLUS=T8 Electronic Instant Start, Total Harmonic Distortion < 10%. High Ballast Factor > 1.15

ER8 =T8 Electronic Program Rapid Start. Total Harmonic Distortion < 10%.

ER8_/PLUS=T8 Electronic Program Rapid Start. Total Harmonic Distortion < 10%. High Ballast Factor > 1.15

High Performance T8 Ballasts

HB8 =T8 Electronic Instant Start. Total Harmonic Distortion < 10%. Standard Ballast Factor .86 - .88

HB8_H=T8 Electronic Instant Start. Total Harmonic Distortion < 10%. High Ballast Factor 1.15 - 1.20

HB8_L=T8 Electronic Instant Start. Total Harmonic Distortion < 10%. Low Ballast Factor .77 - .82

HB8_N=T8 Electronic Instant Start. Total Harmonic Distortion < 10%. Normal Ballast Factor 1.0

HR8 =T8 Electronic Program Rapid Start. Total Harmonic Distortion < 10%. Standard Ballast Factor .86 - .88

HR8_DIM=T8 Electronic Program Rapid Start. Total Harmonic Distortion < 10%. Step Dimming, Ballast Factor .88

HR8_H=T8 Electronic Program Rapid Start. Total Harmonic Distortion < 10%. High Ballast Factor 1.15 - 1.20

HR8_L=T8 Electronic Program Rapid Start. Total Harmonic Distortion < 10%. Low Ballast Factor .71 - .79

Number of Ballasts	Options	Accessories (Order Separately)
1=1 Ballast 2=2 Ballasts 3=3 Ballasts	6-3/18 SJT-C&P-515P=Cord and Plug (120V) 6-3/18 SJT-C&PL715P=Cord and Plug (277V) PI/CPI=Plug-in Option POX=Porlux Finish RIF1=Radio Interference Suppressor TILW=Tandem in line wiring Option (Consult TILW Option Catalog Page).	A1B/SPACER-U=Spacer 1-1/2" to 2-1/2" from ceiling (Use 2 Per Fixture) ATG-DIF-4-U=Tong Hanger (Use 2 Per Fixture) AYC-CHAIN/SET-U=Chain Hanger Set (Use 1 Set Per Fixture) DIF CLOSED END PLATE=Closed End Plate DIF2 LONG CONN (PREPAINTED)=Long Connector GYM GUARD, GG-DIF=Wire Gym Guard MECL-DIF/SL-48-U=Metal Egg Crate Louver MECL-DIF/SL-96-U=Metal Egg Crate Louver SCA=Adjustable 48" Stem Set SCF=Fixed Stem Set (Specify Length) SCS=Swivel Stem Set (Specify Length) WG/DIF4FT-U=Wire Guard

NOTES: 1. Silver lining not available on fixtures with HO. 2. 1-Lamp ballast in a High Ballast factor not available. 3. Step Dimming ballast available for 28W T5 and 14WT5 lamps only. 4. 1-Lamp step dimming ballast in a Normal Ballast factor not available. 2-Lamp ballast will not operate 1-Lamp.

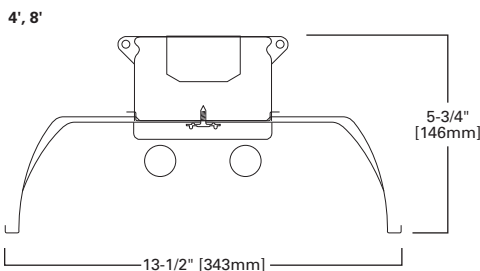

Specifications and dimensions subject to change without notice. Consult your Cooper Lighting Representative or visit www.cooperlighting.com for available options, accessories and ordering information.

T8 INDUSTRIAL



FEATURES

- Equipped with energy-saving ballasts
- Die-formed channels
- Heavy-duty, apertured (DMF) or closed-top (DCMF) reflector
- Deep-draw, full-width reflector ribs add rigidity
- Metal-clad lampholders with spring-loaded sockets
- Apertured reflector standard with uplight
- Baked white enamel finish
- Porlux and silver-lined finishes
- Wire guards, gym guards, lens frames and metal louvers

DIMENSIONS

4', 8'

DMF SERIES

Compliances may not apply to all product configurations. Please consult the product spec sheet for compliance details.

COMPLIANCES: UL/cUL Listed, UL/cUL Listed - Damp Location



ORDERING INFORMATION

SAMPLE NUMBER: DMF-232-UNV-EB81-U

Tandem	Series	Lamp Spacing	Silver Reflector	Number of Lamps (Not Included)	Wattage (Length)	Voltage
[Blank]=4' Length T8=8' Length	DCMF=Closed Top Reflector DMF=Apertured Reflector	[Blank]=Standard Spacing N=Narrow Spacing for 2 Lamps Only (10% uplight)	SS=SilverLining Reflector ¹	2=2 Lamps 3=3 Lamps 4=4 Lamps	28T8=28W T8 (48") 32=32W T8 (48") 48HO=44W T8 (48") HO 96=59W T8 SL (96") 96HO=86W T8 (96") HO	120V=120 Volt 277V=277 Volt 347V=347 Volt UNV=Universal Voltage 120-277
Options		Ballast Type			Number of Ballasts	
EL=Emergency Battery Installed (Must Specify Battery Pack, See Options) GL=Single Element Fuse GM=Double Element Fuse		<p>T8 Ballasts</p> <p>EB8_=T8 Electronic Instant Start. Total Harmonic Distortion < 10%.</p> <p>EB8_/PLUS=T8 Electronic Instant Start. Total Harmonic Distortion < 10%. High Ballast Factor > 1.15</p> <p>ER8_=T8 Electronic Program Rapid Start. Total Harmonic Distortion < 10%.</p> <p>ER8_/PLUS=T8 Electronic Program Rapid Start. Total Harmonic Distortion < 10%. High Ballast Factor > 1.15</p> <p>High Performance T8 Ballasts</p> <p>HB8_=T8 Electronic Instant Start. Total Harmonic Distortion < 10%. Standard Ballast Factor .86 - .88</p> <p>HB8_H=T8 Electronic Instant Start. Total Harmonic Distortion < 10%. High Ballast Factor 1.15 - 1.20</p> <p>HB8_L=T8 Electronic Instant Start. Total Harmonic Distortion < 10%. Low Ballast Factor .77 - .82</p> <p>HB8_N=T8 Electronic Instant Start. Total Harmonic Distortion < 10%. Normal Ballast Factor 1.0</p> <p>HR8_=T8 Electronic Program Rapid Start. Total Harmonic Distortion < 10%. Standard Ballast Factor .86 - .88</p> <p>HR8_DIM=T8 Electronic Program Rapid Start. Total Harmonic Distortion < 10%. Step Dimming. Ballast Factor .88</p> <p>HR8_H=T8 Electronic Program Rapid Start. Total Harmonic Distortion < 10%. High Ballast Factor 1.15 - 1.20</p> <p>HR8_L=T8 Electronic Program Rapid Start. Total Harmonic Distortion < 10%. Low Ballast Factor .71 - .79</p>			1=1 Ballast 2=2 Ballasts 3=3 Ballasts	
Options		Packaging	Accessories (Order Separately)			
6-3/18 SJT-C&P-515P=Cord and Plug (120V) 6-3/18 SJT-C&PL715P=Cord and Plug (277V) PI/CP1=Plug-In Option POX=Porlux Finish RIF1=Radio Interference Suppressor TILW=Tandem In-Line Wiring Option		4B=4 Bulk U=Unit Pack	<p>A-1-B/SPACER-B=Spacer 1-1/2" to 2-1/2" from ceiling (Use 2 Per Fixture)</p> <p>ATG-DIF-4-U=Tong Hanger (Use 2 Per Fixture)</p> <p>AYC-CHAIN/SET-U=(2) V-Hook Hangers, 36" Chain Sets with S Hooks</p> <p>DIF CLOSED END PLATE=Closed End Plate</p> <p>DIF2 LONG CONN (PREPAINTED)=Long Connector</p> <p>GYM GUARD, GG-DIF=Wire Gym Guard</p> <p>MECL-DIF/RS-49-3/4-U=Metal Egg Crate Louver</p> <p>MECL-DIF/RS-99-1/2-U=Metal Egg Crate Louver</p> <p>MECL-DIF/SL-48-U=Metal Egg Crate Louver</p> <p>MECL-DIF/SL-96-U=Metal Egg Crate Louver</p> <p>SCA=Adjustable 48" Stem Set</p> <p>SCF=Fixed Stem Set (Specify Length)</p> <p>SCS=Swivel Stem Set (Specify Length)</p> <p>WG/DIF4FT-U=Wire Guard</p> <p>WG/PA-4FT=Wire Gym Guard with Acrylic Lens</p>			

NOTES: 1. Silver lining not available on fixtures with HO.

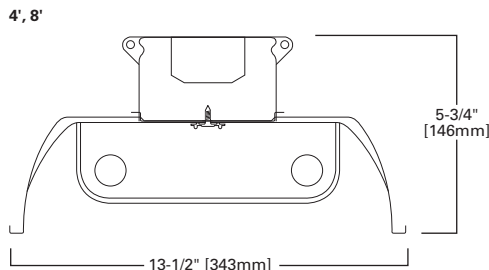

Specifications and dimensions subject to change without notice. Consult your Cooper Lighting Representative or visit www.cooperlighting.com for available options, accessories and ordering information.

FEATURES

- Equipped with energy-saving ballasts
- Die-formed channels
- Heavy-duty, deep-draw, full-width reflector ribs add rigidity
- Baked white enamel finish
- Metal-clad lampholders with spring-loaded sockets
- Porlux and silver-lined finishes
- Apertured or closed-top reflector with Center "V" helps reduce glare
- Wire guards, gym guards, lens frames and metal louvers

DIMENSIONS

4', 8'

Compliances may not apply to all product configurations. Please consult the product spec sheet for compliance details.

COMPLIANCES: UL/cUL Listed - Damp Location



DVMF SERIES



ORDERING INFORMATION

SAMPLE NUMBER: DVMF-232-UNV-EB81-U

Tandem	Series	Silver Reflector	Number of Lamps (Not Included)	Wattage (Length)	Voltage	Options
8T=8' Length [Blank]=4' Length	DCVMF=Closed Top Reflector DVMF=Apertured Reflector	SS=SilverLining Reflector ¹	2=2 Lamps	28T8=28W T8 (48") 32=32W T8 (48") 48HO=48W T8 (48") HO ² 96=59W T8 SL (96") 96=60/75W T12 SL (96") 96HO=86W T8 (96") HO	120V=120 Volt 277V=277 Volt 347V=347 Volt UNV=Universal Voltage 120-277	EL=Emergency Battery Installed (Must Specify Battery Pack, See Options) GL=Single Element Fuse GM=Double Element Fuse
Ballast Type				Number of Ballasts	Options	
T8 Ballasts EB8_=T8 Electronic Instant Start. Total Harmonic Distortion < 10%. EB8_/PLUS=T8 Electronic Instant Start. Total Harmonic Distortion < 10%. High Ballast Factor > 1.15 ER8_=T8 Electronic Program Rapid Start. Total Harmonic Distortion < 10%. ER8_/PLUS=T8 Electronic Program Rapid Start. Total Harmonic Distortion < 10%. High Ballast Factor > 1.15 High Performance T8 Ballasts HB8_=T8 Electronic Instant Start. Total Harmonic Distortion < 10%. Standard Ballast Factor .86 - .88 HB8_H=T8 Electronic Instant Start. Total Harmonic Distortion < 10%. High Ballast Factor 1.15 - 1.20 HB8_L=T8 Electronic Instant Start. Total Harmonic Distortion < 10%. Low Ballast Factor .77 - .82 HB8_N=T8 Electronic Instant Start. Total Harmonic Distortion < 10%. Normal Ballast Factor 1.0 HR8_=T8 Electronic Program Rapid Start. Total Harmonic Distortion < 10%. Standard Ballast Factor .86 - .88 HR8_DIM=T8 Electronic Program Rapid Start. Total Harmonic Distortion < 10%. Step Dimming. Ballast Factor .88 HR8_H=T8 Electronic Program Rapid Start. Total Harmonic Distortion < 10%. High Ballast Factor 1.15 - 1.20 HR8_L=T8 Electronic Program Rapid Start. Total Harmonic Distortion < 10%. Low Ballast Factor .71 - .79				1=1 Ballast 2=2 Ballasts 3=3 Ballasts	6-3/18 SJT-C&P-515P=Cord and Plug (120V) 6-3/18 SJT-C&PL715P=Cord and Plug (277V) PI/CPI=Plug-in Option POX=Porlux Finish RIF1=Radio Interference Suppressor TILW=Tandem In-Line Wiring Option	
Packaging	Accessories (Order Separately)					
4B=4 Bulk U=Unit Pack	A-1-B/SPACER-B=Spacer 1-1/2" to 2-1/2" from ceiling (Use 2 Per Fixture) ATG-DIF-4-U=Tong Hanger (Use 2 Per Fixture) AYC-CHAIN/SET-U=(2) V-Hook Hangers, 36" Chain Sets with S Hooks DIF CLOSED END PLATE=Closed End Plate DIF2 LONG CONN (PREPAINTED)=Long Connector GYM GUARD, GG-DIF=Wire Gym Guard MECL-DIF/RS-49-3/4-U=Metal Egg Crate Louver MECL-DIF/RS-99-1/2-U=Metal Egg Crate Louver MECL-DIF/SL-48-U=Metal Egg Crate Louver MECL-DIF/SL-96-U=Metal Egg Crate Louver			SCA=Adjustable 48" Stem Set SCF=Fixed Stem Set (Specify Length) SCS=Swivel Stem Set (Specify Length) WG/DIF4FT-U=Wire Guard WG/PA-4FT=Wire Gym Guard with Acrylic Lens		

NOTES: 1. Silver lining not available on fixtures with HO. 2. For use with EB2_ Ballasts.

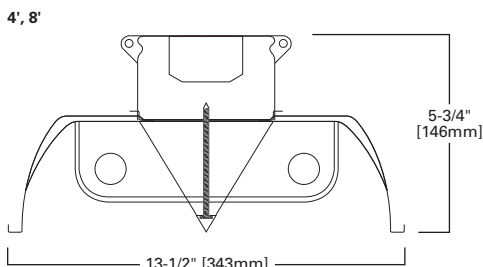

Specifications and dimensions subject to change without notice. Consult your Cooper Lighting Representative or visit www.cooperlighting.com for available options, accessories and ordering information.

OPTICAHP HIGH PERFORMANCE ENERGY SAVINGS T8 PARABOLIC



FEATURES

- High-performance T8 system for maximum energy savings
- Die-formed nominal 4-3/4" deep para-contoured housing
- High-reflectance matte finish maximizes efficiency and performance
- 2" nominal precision-cell, straight-blade faceted, steel louver
- Positive cam latch, safety lock T-hinges allow hinging on either side
- Provided with CEE-listed, energy-saving ballasts
- 97% reflective white optics material available
- Rotor-lock lampholders and end plate grid-lock features
- Commercial, school, hospital or retail merchandising areas

DIMENSIONS

1' x 4', 2' x 2', 2' x 4'

OPTICAHP SERIES

Compliances may not apply to all product configurations. Please consult the product spec sheet for compliance details.

COMPLIANCES: UL/cUL Listed, UL/cUL Listed - Damp Location, IC Rated, City of Chicago Approved



ORDERING INFORMATION

SAMPLE NUMBER: 2OPG-232FB26W-UNV-HB81L-U

Rating	Width	Series	Trim Type	White Optics	Type	Number of Lamps (Not Included)
[Blank]=Standard ATW-SW4=Air-Tight Wire Way (Chicago Rated)	2=2' Width [Blank]=1' Width	OP=Optica HP Series	F=Aluminum Flange Trim ¹ G=Concealed-T/Slot Grid ² G=Grid/Lay-in (Standard) MZ=Modular Trim	WO=97% Reflective White Optics Finish	IC=IC Rated	1=1 Lamp ³ 2=2 Lamps
Wattage (Length)	Cross Blade	Cell Configuration	Louver Finish	Option - Aluminum Flange Trim ¹	Voltage ⁴	
17=17W T8 (24") 28T8=28W T8 (48") 32=32W T8 (48") U1-5/8=31W T8 (24")	FB=Faceted Blade	16=1 Rows of 6, 6 Cell (1' x 4') 23=2 Rows of 3, 6 Cell (2' x 2') 26=2 Rows of 6, 12 Cell (2' x 4')	W=Matte White	[Blank]=SW (Single White) EN=End of Row, Natural Finish EW=End of Row, White Finish RN=In Row, Natural Finish RW=In Row, White Finish SN=Single, Natural Finish	120V=120 Volt 277V=277 Volt 347V=347 Volt UNV=Universal Voltage 120-277 ⁵	
Options		Ballast Type				
EL=Emergency Installed (Must Specify Battery Pack, See Options) ⁶ Flex=Flex Installed (Reference Flex Ordering Information) GL=Single Element Fuse GM=Double Element Fuse Lamps=Lamps Installed (Refer to Lamp Ordering Options)		T8 Ballasts EB8_=T8 Electronic Instant Start. Total Harmonic Distortion < 10%. EB8_/PLUS=T8 Electronic Start. Total Harmonic Distortion < 10%. High Ballast Factor > 1.15 ER8_=T8 Electronic Program Rapid Start. Total Harmonic Distortion < 10%. High Performance T8 Ballasts HB8_=T8 Electronic Instant Start. Total Harmonic Distortion < 10%. Standard Ballast Factor .86-.88 HB8_H=T8 Electronic Instant Start. Total Harmonic Distortion < 10%. High Ballast Factor 1.15-1.20 HB8_L=T8 Electronic Instant Start. Total Harmonic Distortion < 10%. Low Ballast Factor .77-.82 HB8_N=T8 Electronic Instant Start. Total Harmonic Distortion < 10%. Normal Ballast Factor 1.0 HR8_=T8 Electronic Program Rapid Start. Total Harmonic Distortion < 10%. Standard Ballast Factor .86-.88 HR8_DIM=T8 Electronic Program Rapid Start. Total Harmonic Distortion < 10%. Step Dimming. Ballast Factor .88 HR8_H=T8 Electronic Program Rapid Start. Total Harmonic Distortion < 10%. High Ballast Factor 1.15-1.20 HR8_L=T8 Electronic Program Rapid Start. Total Harmonic Distortion < 10%. Low Ballast Factor .71-.79				
Number of Ballasts	Options	Packaging	Accessories (Order Separately)			
1=1 Ballast 2=2 Ballasts	R=Internal Reflector (Not available for U1-5/8 Lamp)	PAL=Job Pack, out of carton PALC=Job Pack, in carton U=Unit Pack	EQ-CLIP-U=T-BAR Safety Earthquake Clips ⁷			

NOTES: 1. Specify row configuration, type in catalog number when ordering complete fixtures. 2. Louver is recessed by 5/16" in Concealed T or Slot Grid T. 3. 1' x 4' only. 4. Products also available in non-US voltage and frequencies for international markets. 5. Not available when specifying emergencies, voltage must be specified. 6. Fixtures equipped with "EL" option may require a 5-1/2" housing depth. If installing in field, must use low profile battery pack. 7. An EQ Grid Clip is recommended for all 9/16" ceiling systems. Four required per fixture.

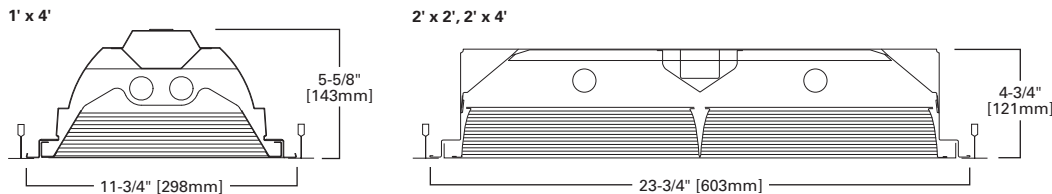

Specifications and dimensions subject to change without notice. Consult your Cooper Lighting Representative or visit www.cooperlighting.com for available options, accessories and ordering information.

FEATURES

- High-performance T8 system for maximum energy savings
- Die-formed nominal 4-3/4" deep para-contoured housing
- Computer-designed, 2" tall precision-cell parabolic louver
- Louvers available in white or silver semi-specular finish
- High-reflectance finish maximizes efficiency and performance
- Positive cam latch, safety lock T-hinges allow hinging on either side
- Positively secured Class P ballast
- 97% reflective white optics material available
- Rotor-lock lampholders, end plate grid-lock and air supply options

DIMENSIONS

2' x 2', 2' x 4'

Compliances may not apply to all product configurations. Please consult the product spec sheet for compliance details.

COMPLIANCES: UL/cUL Listed, UL/cUL Listed - Damp Location, IC Rated, City of Chicago Approved



2HP2 SERIES



ORDERING INFORMATION

SAMPLE NUMBER: 2HP2GX-232W26P-UNV-HB81-U

Rating	Heat Removal ¹	Width	Series	Trim Type ²	Air Supply	White Optics	Type
[Blank]=Standard ATW-SW4=Chicago Rated	HR=Heat Removal ¹	2=2' Width	HP2=High Performance 2" Parallax Louver	F=Aluminum Flange Trim ⁴ G=Concealed-T/Slot Grid ³ G=Grid/Lay-in (Standard) MZ=Modular Trim	AVX=Air Supply Floating Louver with Directional Air Vane AX=Air Supply Floating Louver X=Blank Side/Floating Louver - Non Air Supply	WO=97% Reflective White Optics Finish	IC=IC Rated
Number of Lamps (Not Included)	Wattage	Louver Color	Cell Configuration	Louver Finish	Option - Aluminum Flange Trim ⁴		
2=2 Lamps 3=3 Lamps ⁹	17=17W T8 (24") 28T8=28W T8 (48") 32=32W T8 (48") U1-5/8=31W T8 (24")	S=Silver W=White	23=2 Rows of 3, 6 Cell (2' x 2') 26=2 Rows of 6, 12 Cell (2' x 4') 33=3 Rows of 3, 9 Cell (2' x 2') 36=3 Rows of 6, 18 Cell (2' x 4')	I=Semi-Specular/Haze (Low Iridescent) Standard (Silver Only) P=Painted White (Standard)	[Blank]=SW (Single White) EN=End of Row Natural Finish EW=End of Row, White Finish RN=In Row, Natural Finish RW=In Row, White Finish SN=Single, Natural Finish		
Voltage ⁵	Options	Ballast Type					
120V=120 Volt 277V=277 Volt 347V=347 Volt UNV=Universal Voltage 120-277 ⁶	EL=Emergency Battery Installed (Must Specify Battery Pack, See Options) ⁷ Flex=Flex Installed (Reference Flex Ordering Information) GL=Single Element Fuse GM=Double Element Fuse Lamps=Lamps Installed (Refer to Lamp Ordering) WTR=White Reveal	High Performance T8 Ballasts HB8 =T8 Electronic Instant Start. Total Harmonic Distortion < 10%. Standard Ballast Factor .86 - .88 HB8_H=T8 Electronic Instant Start. Total Harmonic Distortion < 10%. High Ballast Factor 1.15 - 1.20 HB8_L=T8 Electronic Instant Start. Total Harmonic Distortion < 10%. Low Ballast Factor .77 - .82 HB8_N=T8 Electronic Instant Start. Total Harmonic Distortion < 10%. Normal Ballast Factor 1.0 HR8 =T8 Electronic Program Rapid Start. Total Harmonic Distortion < 10%. Standard Ballast Factor .86 - .88 HR8_DIM=T8 Electronic Program Rapid Start. Total Harmonic Distortion < 10%. Step Dimming. Ballast Factor .88 HR8_H=T8 Electronic Program Rapid Start. Total Harmonic Distortion < 10%. High Ballast Factor 1.15 - 1.20 HR8_L=T8 Electronic Program Rapid Start. Total Harmonic Distortion < 10%. Low Ballast Factor .71 - .79					
Options	Packaging	Accessories (Order Separately)					
REP=Riveted End Plates RIF1=Radio Interference Suppressor	PAL=Job Pack, out of carton PALC=Job Pack, in carton U=Unit Pack	EQ-CLIP-U=T-BAR Safety Earthquake Clips ²					

NOTES: 1. Integral End Plate Grid Lock feature not available in Heat Removal. 2. An EQ Grid Clip is recommended for all 9/16" ceiling systems. Four required per fixture. 3. Louver is recessed by 5/16" in Concealed T or Slot Grid T. 4. Specify row configuration, type in catalog number when ordering complete fixtures. 5. Products also available in non-US voltage and frequencies for international markets. 6. Not available when specifying emergencies, voltage must be specified. 7. Fixtures equipped with "EL" option may require a 5-1/2" housing depth. If installing in field, must use low profile battery pack. 8. 2' x 4' only. 9. Standard off-center ballast on 3-lamp fixtures.

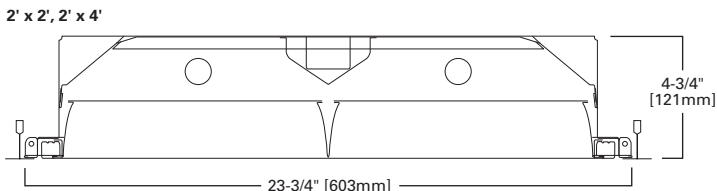

PARALUX III HIGH PERFORMANCE T8 PARABOLIC



FEATURES

- High-performance T8 system for maximum energy savings
- Die-formed nominal 4-3/4" deep para-contoured housing
- Housing features die-formed stiffeners for added rigidity
- Louvers available in white or silver semi-specular finish
- 3" nominal precision-cell, parabolic, high-performance louver
- High-reflectance finish maximizes efficiency and performance
- 97% reflective white optics material available
- Positively secured Class P ballast
- Rotolock lampholders, end plate grid-lock and air supply options

DIMENSIONS

2' x 2', 2' x 4'

2HP3 SERIES

Compliances may not apply to all product configurations. Please consult the product spec sheet for compliance details.

COMPLIANCES: UL/cUL Listed, UL/cUL Listed - Damp Location, IC Rated, City of Chicago Approved



ORDERING INFORMATION

SAMPLE NUMBER: 2HP3GX-332W36P-UNV-HB81-U

Rating	Heat Removal ¹	Width	Series	Trim Type	Air Supply	White Optics	Type	Number of Lamps (Not Included)
[Blank]=Standard ATW-SW4=Chicago Rated	HR=Heat Removal ¹	2=2' Width	HP3=High Performance 3" Parallax Louver	F=Aluminum Flange Trim ² G=Concealed-T/Slot Grid ³ G=Grid/Lay-in (Standard) MZ=Modular Trim	AVX=Air Supply Floating Louver with Directional Air Vane AX=Air Supply Floating Louver X=Blank Side/ Floating Louver - Non Air Supply	WO=97% Reflective White Optics Finish	IC=IC Rated	2=2 Lamps 3=3 Lamps ⁴
Wattage	Louver Color	Cell Configuration	Louver Finish	Option - Aluminum Flange Trim ²	Voltage ⁵			
17=17W T8 (24") 28T8=28W T8 (48") 32=32W T8 (48") U15/8=31W T8 (24")	S=Silver W=White	23=2 Rows of 3, 6 Cell (2' x 2') 26=2 Rows of 6, 12 Cell (2' x 4') 33=3 Rows of 3, 9 Cell (2' x 2', 2024) 36=3 Rows of 6, 18 Cell (2' x 4')	I=Semi-Specular/Haze (Low Iridescent) (Silver Only) P=Painted White (Standard)	[Blank]=SW (Single White) EN=End of Row, Natural Finish EW=End of Row, White Finish RN=In Row, Natural Finish RW=In Row, White Finish SN=Single, Natural Finish	120V=120 Volt 277V=277 Volt 347V=347 Volt UNV=Universal Voltage 120-277 ⁶			
Options				Ballast Type				
EL=Emergency Battery Installed (Must Specify Battery Pack, See Options) ⁷ Flex=Flex Installed (Reference Flex Ordering Information) GL=Single Element Fuse GM=Double Element Fuse Lamps=Lamps Installed (Refer to Lamp Ordering Options) WTR=White Reveal Lamps Installed [Blank]=No Lamps Installed L8835=T8 Lamp, 28W and 32W, 3500K L8835HL=T8 Lamp, 32W 3500K, 3100 Lumens L8841=T8 Lamp, 28W and 32W, 4100K L8841HL=T8 Lamp, 32W 4100K, 3100 Lumens				High Performance T8 Ballasts HB8 =T8 Electronic Instant Start. Total Harmonic Distortion < 10%. Standard Ballast Factor .86 - .88 HB8_H=T8 Electronic Instant Start. Total Harmonic Distortion < 10%. High Ballast Factor 1.15 - 1.20 HB8_L=T8 Electronic Instant Start. Total Harmonic Distortion < 10%. Low Ballast Factor .77 - .82 HB8_N=T8 Electronic Instant Start. Total Harmonic Distortion < 10%. Normal Ballast Factor 1.0 HR8 =T8 Electronic Program Rapid Start. Total Harmonic Distortion < 10%. Standard Ballast Factor .86 - .88 HR8_DIM=T8 Electronic Program Rapid Start. Total Harmonic Distortion < 10%. Step Dimming. Ballast Factor .88 HR8_H=T8 Electronic Program Rapid Start. Total Harmonic Distortion < 10%. High Ballast Factor 1.15 - 1.20 HR8_L=T8 Electronic Program Rapid Start. Total Harmonic Distortion < 10%. Low Ballast Factor .71 - .79				
Number of Ballasts	Options	Packaging	Accessories (Order Separately)					
1=1 Ballast 2=2 Ballasts 3=3 Ballasts ⁸	REP=Riveted End Plates RIF1=Radio Interference Suppressor	PAL=Job Pack, out of carton PALC=Job Pack, in carton U=Unit Pack	EQ-CLIP-U=T-BAR Safety Earthquake Clips ⁹					

NOTES: 1. Integral End Plate Grid Lock feature not available in Heat Removal. 2. Specify row configuration, type in catalog number when ordering complete fixtures. 3. Louver is recessed by 5/16" in Concealed T or Slot Grid T. 4. Standard off-center ballast on 3-lamp fixtures. 5. Products also available in non-US voltage and frequencies for international markets. 6. Not available when specifying emergencies, voltage must be specified. 7. Fixtures equipped with "EL" option may require a 5-1/2" housing depth. If installing in field, must use low profile battery pack. 8. 2' x 4' only. 9. An EQ Grid Clip is recommended for all 9/16" ceiling systems. Four required per fixture.

2' x 2', 2' x 4'

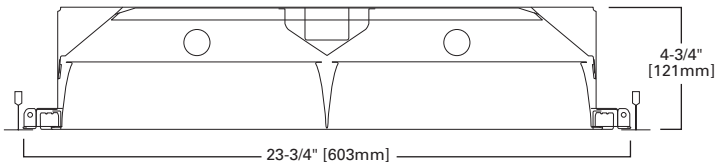

Specifications and dimensions subject to change without notice. Consult your Cooper Lighting Representative or visit www.cooperlighting.com for available options, accessories and ordering information.

FEATURES

- Provided with CEE-listed energy-saving ballasts
- Computer-designed, 3" nominal precision-cell parabolic louver
- Die-formed, para-contoured body with stiffeners for rigidity
- Louvers available in white or silver semi-specular finish
- Positive cam latch, safety lock T-hinges allow hinging on either side
- Floating louver with black reveal
- Efficient air-handling options with or without air control vanes
- Four auxiliary fixture-end suspension points provided
- Unique louver tannenbaum design option



2EP3GAX SERIES

DIMENSIONS

1' x 4', 2' x 2', 2' x 4', 20" x 24", 20" x 48"

Compliances may not apply to all product configurations. Please consult the product spec sheet for compliance details.

COMPLIANCES: UL/cUL Listed, UL/cUL Listed - Damp Location, IC Rated, City of Chicago Approved, NOM Certified



ORDERING INFORMATION

SAMPLE NUMBER: 2EP3GX-332S36I-L8835-UNV-EB81-U

Rating	Hard Metric	Heat Removal ¹	Width	Series	Trim Type	Air Supply	20" Width	Type
[Blank]=Standard ATW-SW4=Air-Tight Wire Way (Chicago Rated)	HM=Hard Metric	HR=Heat Removal	2=2' Width [Blank]=1' Width ²	EP3=Paralux III	F=Aluminum Flange Trim ³ G=Concealed-T/Slot Grid ⁴ G=Grid/Lay-in (Standard) MZ=Modular Trim ⁴	AVX=Air Supply Floating Louver with Directional Air Vane AX=Air Supply Floating Louver X=Blank Side/Floating Louver - Non-Air Supply	2024=20" Width x 24" Length 2048=20" Width x 48" Length	IC=IC Rated

Number of Lamps (Not Included)	Wattage	Louver Color	Cell Configuration	Louver Finish	Distribution	
1=1 Lamp ⁵ 2=2 Lamps 3=3 Lamps ^{6,19} 4=4 Lamps ⁶	14T5=14W T5 (24") 17=17W T8 (24") 24T5=24W T5HO (24") 28T5=28W T5 (48") 28T8=28W T8 (48") 32=32W T8 (48") 54T5=54W T5HO (48") BX40=40W Biax (24") U15/8=31W T8 (24") ⁷ U6T8=32W T8 (24") ^{8,7}	S=Silver ST=Silver Tannenbaum W=White	112=1 Row of 12, 12 Cell (1' x 4') ¹⁰ 16=1 Row of 6, 6 Cells (1' x 4') 18=1 Row of 8, 8 Cells (1' x 4') 212=2 Rows of 12, 24 Cell (1' x 4') ¹⁰ 23=2 Rows of 3, 6 Cell (2' x 2') 26=2 Rows of 6, 12 Cell (2' x 4') 28=2 Rows of 8, 16 Cell (2' x 4') 312=3 Rows of 12, 36 Cell (2' x 4') ¹⁰	33=3 Rows of 3, 9 Cell (2' x 2', 2024) 34=3 Rows of 4, 12 Cell (2' x 2', 2024) 36=3 Rows of 6, 18 Cell (2' x 4', 2048) 36=3 Rows of 6, 18 Cell (2' x 2', ST Only) ⁹ 38=3 Rows of 8, 24 Cell (2' x 4', 2048) 44=4 Rows of 4, 16 Cell (2' x 2', 2024) 46=4 Rows of 6, 24 Cell (2' x 4') 48=4 Rows of 8, 32 Cell (2' x 4', 2048)	I=Semi-Specular/Haze (Low Iridescent) Standard MI=Specular/Mirrored (Low Iridescent) P=Painted	[Blank]=Standard ASY=Asymmetric High Throw Wall Wash ⁵ SYM=Symmetric High Throw Wall Wash ⁵

Option - Aluminum Flange Trim ³	Voltage ¹¹	Options
[Blank]=SW (Single White) EN=End of Row, Natural Finish EW=End of Row, White Finish RN=In Row, Natural Finish	RW=In Row, White Finish SN=Single, Natural Finish SW=Single, White Finish 120V=120 Volt 277V=277 Volt 347V=347 Volt UNV=Universal Voltage 120-277 ¹²	EL=Emergency Installed (Must Specify Battery Pack, See Options) ¹³ Flex=Flex Installed (Reference Flex Ordering Information) GL=Single Element Fuse GM=Double Element Fuse Lamps=Lamps Installed (Refer to Lamp Ordering Options) WTR=White Reveal

Ballast Type

EB5 =T5 Biax Electronic Instant Start. Total Harmonic Distortion < 20%. ¹⁴ EB8 =T8 Electronic Start. Total Harmonic Distortion < 10%. EB8 /PLUS=T8 Electronic Start. Total Harmonic Distortion < 10%. High Ballast Factor > 1.15 EBT =T5 or T5HO Electronic Program Rapid Start. Total Harmonic Distortion < 10%. ER5 =T5 Biax Electronic Program Rapid Start. Total Harmonic Distortion < 10%. ¹⁴ ER8 =T8 Electronic Program Rapid Start. Total Harmonic Distortion < 10%. TEB5 =T5 Biax Electronic Instant Start. Total Harmonic Distortion < 10%. ¹⁴	High Performance T8 Ballasts HB8 =T8 Electronic Instant Start. Total Harmonic Distortion < 10%. Standard Ballast Factor .86 - .88 HB8_H=T8 Electronic Instant Start. Total Harmonic Distortion < 10%. High Ballast Factor 1.15 - 1.20 HB8_L=T8 Electronic Instant Start. Total Harmonic Distortion < 10%. Low Ballast Factor .77 - .82 HB8_N=T8 Electronic Instant Start. Total Harmonic Distortion < 10%. Normal Ballast Factor 1.0 HR8 =T8 Electronic Program Rapid Start. Total Harmonic Distortion < 10%. Standard Ballast Factor .86 - .88 HR8_DIM=T8 Electronic Program Rapid Start. Total Harmonic Distortion < 10%. Step Dimming. Ballast Factor .88 HR8_H=T8 Electronic Program Rapid Start. Total Harmonic Distortion < 10%. High Ballast Factor 1.15 - 1.20 HR8_L=T8 Electronic Program Rapid Start. Total Harmonic Distortion < 10%. Low Ballast Factor .71 - .79
Ballast/Factor Type (T5) EBT_H=T5 Electronic Program Rapid Start. Total Harmonic Distortion < 10%. High Ballast Factor=1.15 ¹⁵ EBT_HDIM=T5 Electronic Program Rapid Start. Total Harmonic Distortion < 10%. Step Dimming, High Ballast Factor=1.15 ¹⁶ EBT_N=T5 Electronic Program Rapid Start. Total Harmonic Distortion < 10%. Normal Ballast Factor=.90 EBT_NDIM=T5 Electronic Program Rapid Start. Total Harmonic Distortion < 10%. Step Dimming, Normal Ballast Factor=.95-1.0 ¹⁷	

Number of Ballasts	Options	Packaging	Accessories (Order Separately)
1=1 Ballast 2=2 Ballasts 3=3 Ballasts (2' x 4')	LAO=Less Access Opening ⁷ PAF=Painted After Fabrication REP=Riveted End Plates RIF1=Radio Interference Suppressor	PAL=Job Pack Out of Carton PALC=Job Pack, in carton U=Unit Pack	EQ-CLIP-U=T-BAR Safety Earthquake Clips ¹⁸

NOTES: 1. Integral End Plate Grid Lock feature not available in Heat Removal. 2. For 20" width, must specify 2024 or 2048 in ordering logic. 3. Specify row configuration, type in catalog number when ordering complete fixtures. 4. Louver is recessed by 5/16" in Concealed T or Slot Grid T. 5. 1' x 4' only. 6. 2' x 2' and 2' x 4' only. 7. 2' x 2' only. 8. 2 lamp 2' x 2' only. 9. These cell configurations are also available in Silver Tannenbaum (ST). 10. 112, 212 and 312 are only available in Silver Tannenbaum (ST). 11. Products also available in non-US voltage and frequencies for international markets. 12. Not available when specifying emergencies, voltage must be specified. 13. Fixtures equipped with "EL" option may require a 5-1/2" housing depth. If installing in field, must use low profile battery pack. 14. Not available in UNV voltage. Must specify voltage. 15. 1-Lamp ballast in a High Ballast factor not available. 16. Step Dimming ballast available for 28W T5 and 14WT5 lamps only. 17. 1-Lamp step dimming ballast in a Normal Ballast factor not available. 2-Lamp ballast will not operate 1-Lamp. 18. Recommended for all 9/16" ceiling systems. Four per fixture. 19. Standard off-center ballast on 3-lamp fixtures.

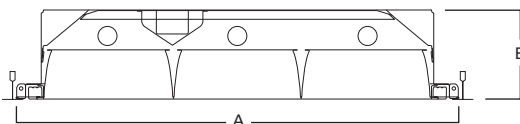

NOMINAL SIZE	A	B
1' x 4'	11-3/4" (298mm)	6-5/8" (168mm)
1' x 4' (OU)	11-3/4" (298mm)	8-1/4" (210mm)
2' x 2'	23-3/4" (603mm)	4-3/4" (121mm)
2' x 4'	23-3/4" (603mm)	4-3/4" (121mm)
20" x 24"	19-3/4" (502mm)	5-5/8" (143mm)
20" x 48"	19-3/4" (502mm)	5-5/8" (143mm)

PRODUCT INFORMATION FOR PARALUX III

Housing Size	Louver Cell Configuration*	Number of Cells
1' x 4'	16, 18, 26, 28	6, 8, 12, 16
2' x 2'	23, 33, 34, 44	6, 9, 12, 16
20" x 24"	23, 24, 33, 34	6, 8, 9, 12
20" x 48"	26, 36, 38	12, 18, 24
2' x 4'	26, 28, 36, 38, 46, 48	12, 16, 18, 24, 24, 32

*example: 36= 3 rows of 6 (18 cells)

Specifications and dimensions subject to change without notice. Consult your Cooper Lighting Representative or visit www.cooperlighting.com for available options, accessories and ordering information.

PARALUX II RECESSED AIR SUPPLY TROFFER



FEATURES

- Provided with CEE-listed, energy-saving ballasts
- Computer-designed, 2" tall precision-cell parabolic louver
- Die-formed housing with four auxiliary end suspension points
- Positive cam latch, safety lock T-hinges allow hinging on either side
- Rotor-lock lampholders, end plate grid-lock and air supply options
- Efficient air-handling options with or without air control vanes
- Floating louver with black reveal
- Louvers available in white or silver semi-specular finish

DIMENSIONS

1' x 4', 2' x 2', 2' x 4', 20" x 24", 20 x 48"

Compliances may not apply to all product configurations. Please consult the product spec sheet for compliance details.

COMPLIANCES: UL/cUL Listed, UL/cUL Listed - Damp Location, City of Chicago Approved, NOM Certified

2P2GAX SERIES



ORDERING INFORMATION

SAMPLE NUMBER: 2P2GAX-232S511-UNV-EB81-U

Rating	Heat Removal	Width	Series	Trim Type	Air Supply	20" Width	Number of Lamps	Wattage	Louver Color
[Blank]=Standard ATW-SW4=Air-Tight Wire Way (Chicago Rated)	HR=Heat Removal ¹	2=2' Width [Blank]=1' Width ²	P2=Paralux II, 2" Louver Depth	F=Aluminum Flange Trim ³ G=Concealed-T/Slot Grid ⁴ G =Grid/Lay-in (Standard) MZ=Modular Trim ⁴	AVX=Air Supply Floating Louver with Directional Air Vane AX=Air Supply Floating Louver X=Blank Side/ Floating Louver - Non Air Supply	2024=20" Width x 24" Length 2048=20" Width x 48" Length	(Not Included) 1=1 Lamp ⁵ 2=2 Lamps 3=3 Lamps ⁶ 4=4 Lamps	14WT5=14W T5 (24") 17=17W T8 (24") 24WT5=24W T5HO (24") 28T5=28W T5 (48") 28T8=28W T8 (48") 32=32W T8 (48") 54T5=54W T5HO (48") BX40=40W Biax (24") ⁷ U15/8=31W T8 (24") U6T8=32W T8 (24") ^{7,8}	S=Silver W=White
Cell Configuration				Louver Finish	Option - Aluminum Flange Trim ³	Voltage ⁹	Options		
111=1 Row of 11, 11 Cell (1' x 4') 113=1 Row of 13, 13 Cell (1' x 4') 211=2 Rows of 11, 22 Cell (1' x 4') 213=2 Rows of 13, 26 Cell (1' x 4') 22=2 Rows of 2, 4 Cell (2' x 2') 23=2 Rows of 3, 6 Cell (2' x 2') 26=2 Rows of 6, 12 Cell (2' x 4') 28=2 Rows of 8, 16 Cell (2' x 4') 311=3 Rows of 11, 33 Cell (1' x 4', 2' x 4')				I=Semi-Specular/Haze (Low Iridescent) Standard (Silver Only) MI=Specular/Mirrored (Low Iridescent) (Silver Only) P=Painted (White Only)	[Blank]=SW (Single White) EN=End of Row, Natural Finish EW=End of Row, White Finish RN=In Row, Natural Finish RW=In Row, White Finish SN=Single, Natural Finish	120V=120 Volt 277V=277 Volt 347V=347 Volt UNV=Universal Voltage 120-277 ¹⁰	EL=Emergency Installed (Must Specify Battery Pack, See Options) Flex=Flex Installed (Reference Flex Ordering Information) GL=Single Element Fuse GM=Double Element Fuse Lamps=Lamps Installed (Refer to Lamp Ordering Options) WTR=White Reveal		

Ballast Type

EB5=T5 Biax Electronic Instant Start. Total Harmonic Distortion < 20%.¹¹
 EB8=T8 Electronic Start. Total Harmonic Distortion < 10%.
 EB8_/PLUS=T8 Electronic Start. Total Harmonic Distortion < 10%. High Ballast Factor > 1.15.
 EBT=T5 or T5HO Electronic Program Rapid Start. High Ambient. Total Harmonic Distortion < 10%.
 ER5=T5 Biax Electronic Program Rapid Start. Total Harmonic Distortion < 10%.
 ER8=T8 Electronic Program Rapid Start. Total Harmonic Distortion < 10%.
 TEB5=T5 Biax Electronic Instant Start. Total Harmonic Distortion < 10%.¹¹

Ballast/Factor Type (T5)

EBT_H=T5 Electronic Program Rapid Start. Total Harmonic Distortion < 10%. High Ballast Factor=1.15¹²
 EBT_HDIM=T5 Electronic Program Rapid Start. Total Harmonic Distortion < 10%. Step Dimming, High Ballast Factor=1.15¹³
 EBT_N=T5 Electronic Program Rapid Start. Total Harmonic Distortion < 10%. Normal Ballast Factor=.90
 EBT_NDIM=T5 Electronic Program Rapid Start. Total Harmonic Distortion < 10%. Step Dimming, Normal Ballast Factor=.95-1.0¹⁴

High Performance T8 Ballasts

HB8=T8 Electronic Instant Start. Total Harmonic Distortion < 10%. Standard Ballast Factor .86 - .88
 HB8_H=T8 Electronic Instant Start. Total Harmonic Distortion < 10%. High Ballast Factor 1.15 - 1.20
 HB8_L=T8 Electronic Instant Start. Total Harmonic Distortion < 10%. Low Ballast Factor .77 - .82
 HB8_N=T8 Electronic Instant Start. Total Harmonic Distortion < 10%. Normal Ballast Factor 1.0
 HR8=T8 Electronic Program Rapid Start. Total Harmonic Distortion < 10% Standard Ballast Factor .86 - .88
 HR8_DIM=T8 Electronic Program Rapid Start. Total Harmonic Distortion < 10%. Step Dimming, Ballast Factor .88
 HR8_H=T8 Electronic Program Rapid Start. Total Harmonic Distortion < 10%. High Ballast Factor 1.15 - 1.20
 HR8_L=T8 Electronic Program Rapid Start. Total Harmonic Distortion < 10%. Low Ballast Factor .71 - .79

Number of Ballast	Options	Packaging	Accessories (Order Separately)
1=1 Ballast 2=2 Ballasts ¹⁵ 3=3 Ballasts ¹⁶	LAO=Less Access Opening ¹⁵ PAF=Painted After Fabrication	REP=Riveted End Plates RIF1=Radio Interference Filter	EQ-CLIP-U=T-BAR Safety Earthquake Clips ¹⁷

NOTES: 1. Integral End Plate Grid Lock feature not available in Heat Removal. 2. For 20" width, must specify 2024 or 2048 in ordering logic. 3. Specify row configuration, type in catalog number when ordering complete fixtures. 4. Louver is recessed by 5/16" in Concealed T or Slot Grid T. 5. 1' x 4' only. 6. Standard off-center ballast on 3-lamp fixtures. 7. 2' x 2' only. 8. 2 lamp only. 9. Products also available in non-US voltage and frequencies for international markets. 10. Not available when specifying emergencies, voltage must be specified. 11. Not available in UNV voltage. Must specify voltage. 12. 1-Lamp ballast in a High Ballast factor not available. 13. Step Dimming ballast available for 28W T5 and 14WT5 lamps only. 14. 1-Lamp step dimming ballast in a Normal Ballast factor not available. 2-Lamp ballast will not operate 1-Lamp. 15. Less Access Opening (LAO) in housing is required for 2' x 2' sizes. 16. 2' x 4' only. 17. An EQ Grid Clip is recommended for all 9/16" ceiling systems. Four required per fixture.

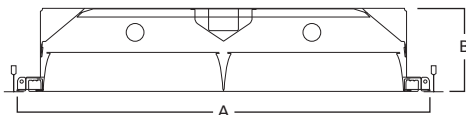

NOMINAL SIZE	A	B
1' x 4'	11-3/4" (298mm)	5-5/8" (143mm)
2' x 2'	23-3/4" (603mm)	4-3/4" (121mm)
2' x 4'	23-3/4" (603mm)	4-3/4" (121mm)
20" x 24"	19-3/4" (502mm)	4-5/8" (117mm)
20" x 48"	19-3/4" (502mm)	4-5/8" (117mm)

PRODUCT INFORMATION FOR PARALUX II

Housing Size	Louver Cell Configuration*	Number of Cells
1' x 4'	111, 113, 211, 213, 311	11, 13, 22, 26, 33
2' x 2'	22, 23, 33, 34, 44, 55	4, 6, 9, 12, 16, 25
20" x 24"	33, 34, 44, 45	9, 12, 16, 20
20" x 48"	36, 38, 48, 411	18, 24, 32, 44
2' x 4'	26, 28, 36, 38, 311, 46, 48, 411	12, 16, 18, 24, 33, 24, 32, 44

*Example: 36= 3 rows of 6 (18 cells)

FEATURES

- Provided with CEE-listed energy-saving ballasts
- Computer-designed, 4" tall precision-cell parabolic louver
- Die-formed, deep para-contoured body with end plate grid-lock feature
- Positive cam latch, safety lock T-hinges allow hinging on either side
- Louvers available in white, specular or silver semi-specular finish
- Efficient air-handling options with or without air control vanes
- Four auxiliary fixture-end suspension points provided
- Floating louver with black reveal
- Hard metric configurations available

DIMENSIONS

1' x 4', 2' x 2', 2' x 4', 20" x 24", 20" x 48"

Compliances may not apply to all product configurations. Please consult the product spec sheet for compliance details.

COMPLIANCES: UL/cUL Listed, UL/cUL Listed - Damp Location, City of Chicago Approved, NOM Certified



2PGAX SERIES



ORDERING INFORMATION

SAMPLE NUMBER: 2PGAX-232S39I-UNV-EB81-U

Rating	Hard Metric	Heat Removal ¹	Width	Series	Trim Type	Air Supply	20" Width	Number of Lamps (Not Included)	Wattage
[Blank]=Standard ATW-SW4=Air-Tight Wire Way (Chicago Rated)	HM=Hard Metric	HR=Heat Removal	2=2' Width [Blank]=1' Width ²	P=Paralux IV	F=Aluminum Flange Trim ³ G=Concealed-T/Slot Grid ⁴ G=Grid/Lay-in (Standard) MZ=Modular Trim	AVX=Air Supply Floating Louver with Directional Air Vane AX=Air Supply Floating Louver X=Blank Side/Floating Louver - Non Air Supply	2024=20" Width x 24" Length 2048=20" Width x 48" Length	1=1 Lamp ⁵ 2=2 Lamps 3=3 Lamps ¹³ 4=4 Lamps ⁶	28T8=28W T8 (48") 32=32W T8 (48") BX40=40W Biax (24") ⁷ U15/8=31W T8 (24") U6T8=32W T8 (24") ^{7,8}
Louver Color	Cell Configuration		Louver Finish	Option - Aluminum Flange Trim ³		Voltage ⁹	Options		
S=Silver W=White	16=1 Row of 6, 6 Cells (1' x 4') 18=1 Row of 8, 8 Cells (1' x 4') 23=2 Rows of 3, 6 Cell (2' x 2', 20" x 24") 26=2 Rows of 6, 12 Cell (1' x 4', 20" x 48", 2' x 4') 28=2 Rows of 8, 16 Cell (1' x 4', 2' x 4') 29=2 Rows of 9, 18 Cell (1' x 4') 33=3 Rows of 3, 9 Cell (2' x 2', 20" x 24") 34=3 Rows of 4, 12 Cell (2' x 2', 20" x 24") 36=3 Rows of 6, 18 Cell (2' x 4', 20" x 48") 38=3 Rows of 8, 24 Cell (2' x 4', 20" x 48") 39=3 Rows of 9, 27 Cell (2' x 4', 20" x 48") 44=4 Rows of 4, 16 Cell (2' x 2') 46=4 Rows of 6, 24 Cell (2' x 4', 20" x 48") 48=4 Rows of 8, 32 Cell (2' x 4', 20" x 48")		I=Specular/ Haze (Low Iridescent) Standard MI=Specular/ Mirrored (Low Iridescent) P=Painted	[Blank]=SW (Single White) EN=End of Row, Natural Finish EW=End of Row, White Finish RN=In Row, Natural Finish RW=In Row, White Finish SN=Single, Natural Finish		120V=120 Volt 277V=277 Volt 347V=347 Volt UNV=Universal Voltage 120-277 ¹⁰	EL=Emergency Installed (Must Specify Battery Pack, See Options) Flex=Flex Installed (Reference Flex Ordering Information) GL=Single Element Fuse GM=Double Element Fuse Lamps=Lamps Installed (Refer to Lamp Ordering Options) WTR=White Reveal Lamps Installed [Blank]=No Lamps Installed L8835=T8 Lamp, 28W and 32W, 3500K L8835HL=T8 Lamp, 32W 3500K, 3100 Lumens L8841=T8 Lamp, 28W and 32W, 4100K L8841HL=T8 Lamp, 32W 4100K, 3100 Lumens		
Ballast Type									
EB5_=T5 Biax Electronic Instant Start. Total Harmonic Distortion < 20%. ¹¹ EB8_=T8 Electronic Start. Total Harmonic Distortion < 10%. EB8_/PLUS=T8 Electronic Start. Total Harmonic Distortion < 10%. High Ballast Factor > 1.15 ER5_=T5 Biax Electronic Program Rapid Start. Total Harmonic Distortion < 10%. ¹¹ ER8_=T8 Electronic Program Rapid Start. Total Harmonic Distortion < 10%. TEB5_=T5 Biax Electronic Instant Start. Total Harmonic Distortion < 10%. ¹¹					High Performance T8 Ballasts HB8_=T8 Electronic Instant Start. Total Harmonic Distortion < 10%. Standard Ballast Factor .86 - .88 HB8_H=T8 Electronic Instant Start. Total Harmonic Distortion < 10%. High Ballast Factor 1.15 - 1.20 HB8_L=T8 Electronic Instant Start. Total Harmonic Distortion < 10%. Low Ballast Factor .77 - .82 HB8_N=T8 Electronic Instant Start. Total Harmonic Distortion < 10%. Normal Ballast Factor 1.0 HR8_=T8 Electronic Program Rapid Start. Total Harmonic Distortion < 10%. Standard Ballast Factor .86 - .88 HR8_DIM=T8 Electronic Program Rapid Start. Total Harmonic Distortion < 10%. Step Dimming. Ballast Factor .88 HR8_H=T8 Electronic Program Rapid Start. Total Harmonic Distortion < 10%. High Ballast Factor 1.15 - 1.20 HR8_L=T8 Electronic Program Rapid Start. Total Harmonic Distortion < 10%. Low Ballast Factor .71 - .79				
Number of Ballast	Options			Packaging	Accessories (Order Separately)				
1=1 Ballast 2=2 Ballasts 3=3 Ballasts (2' x 4' Only)	PAF=Painted After Fabrication REP=Riveted End Plates RIF1=Radio Interference Suppressor			PAL=Job Pack, out of carton PALC=Job Pack, in carton U=Unit Pack	EQ-CLIP-U=T-BAR Safety Earthquake Clips ¹²				

NOTES: 1. Integral End Plate Grid Lock feature not available in Heat Removal. 2. For 20" width, must specify 2024 or 2048 in ordering logic. 3. Specify row configuration, type in catalog number when ordering complete fixtures. 4. Louver is recessed by 5/16" in Concealed T or Slot Grid T. 5. 1' x 4' only. 6. 2' x 4' and 20" x 48" only. 7. 2' x 2' only. 8. 2 lamps only. 9. Products also available in non-US voltage and frequencies for international markets. 10. Not available when specifying emergencies, voltage must be specified. 11. Not available in UNV voltage. Must specify voltage. 12. An EQ Grid Clip is recommended for all 9/16" ceiling systems. Four required per fixture. 13. Standard off-center ballast on 3-lamp fixtures.

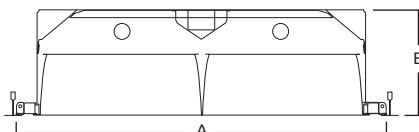

NOMINAL SIZE	A	B
1' x 4'	11-3/4" (298mm)	7-5/8" (194mm)
2' x 2'	23-3/4" (603mm)	6-3/4" (172mm)
2' x 4'	23-3/4" (603mm)	6-3/4" (172mm)
20" x 24"	19-3/4" (502mm)	6-5/8" (168mm)
20" x 48"	19-3/4" (502mm)	6-5/8" (168mm)

PRODUCT INFORMATION FOR PARALUX IV

Housing Size	Louver Cell Configuration*	Number of Cells
1' x 4'	16, 18, 26, 28, 29	6, 8, 12, 16
2' x 2'	23, 33, 34, 44	6, 9, 12, 16
20" x 24"	23, 33, 34	6, 9, 12
20" x 48"	26, 36, 38, 39, 46, 48	12, 18, 24, 27, 24, 32
2' x 4'	26, 28, 36, 38, 39, 46, 48	12, 16, 18, 24, 27, 24, 32

*Example: 36= 3 rows of 6 (18 cells)

PARALUX V RECESSED AIR SUPPLY PRECISION CUT-OFF TROFFER



FEATURES

- Provided with CEE-listed energy-saving ballasts
- Computer-designed, precision-cell parabolic louver
- Louver designed to eliminate glare and control high-angle brightness
- Low-iridescent louvers minimize reflected glare or color
- Die-formed, deep para-contoured body with stiffeners for rigidity
- Efficient air-handling options with or without air control vanes
- Positive cam latch, safety lock T-hinges allow hinging on either side
- Floating louvers with black reveal
- Four auxiliary fixture-end suspension points provided

DIMENSIONS

1' x 2', 1' x 4', 2' x 2', 2' x 4', 20" x 24", 20" x 48"

2P5GAX SERIES

Compliances may not apply to all product configurations. Please consult the product spec sheet for compliance details.

COMPLIANCES: UL/cUL Listed, UL/cUL Listed - Damp Location, City of Chicago Approved, NOM Certified



ORDERING INFORMATION

SAMPLE NUMBER: 2P5GAVX-332S39MI-UNV-EB81-U

Rating	Hard Metric	Heat Removal ¹	Width	Series	Trim Type	Air Supply	20" Width	Number of Lamps (Not Included)
[Blank]=Standard ATW-SW4=Air-Tight Wire Way (Chicago Rated)	HM=Hard Metric	HR=Heat Removal	2-2' Width [Blank]=1' Width ²	P5=5" Parallax Louver	F=Aluminum Flange Trim ³ G=Concealed-T/Slot Grid ⁴ G=Grid/Lay-in (Standard) MZ=Modular Trim	AVX=Air Supply Floating Louver with Directional Air Vane AX=Air Supply Floating Louver X=Blank Side/Floating Louver - Non Air Supply	2024=20" Width x 24" Length	1=1 Lamp ⁵ 2=2 Lamps 3=3 Lamps ^{6, 13}
Wattage	Louver Color	Cell Configuration		Louver Finish	Option - Aluminum Flange Trim ³	Voltage ⁹	Options	
28T8=28W T8 (48") 32=32W T8 (48") BX40=40W Biax (24") ⁷ U15/8=31W T8 (24") ⁸	S=Silver	14=1 Row of 4, 4 Cell (1' x 2') 19=1 Row of 9, 9 Cells (1' x 4') 24=2 Rows of 4, 8 Cell (2' x 2') 24=2 Rows of 4, 8 Cell (20 x 24) 29=2 Rows of 9, 18 Cell (2' x 4') 29=2 Rows of 9, 18 Cell (20 x 48) 34=3 Rows of 4, 12 Cell (2' x 2', 2024) 39=3 Rows of 9, 27 Cell (2' x 4')		MI=Specular/Mirrored (Low Iridescent) VDT=VDT Soft Semi-Specular/Haze	[Blank]=SW (Single White) EN=End of Row, Natural Finish EW=End of Row, White Finish RN=In Row, Natural Finish RW=In Row, White Finish SN=Single, Natural Finish	120V=120 Volt 277V=277 Volt 347V=347 Volt UNV=Universal Voltage 120-277 ¹⁰	EL=Emergency Installed (Must Specify Battery Pack, See Options) Flex=Flex Installed (Reference Flex Ordering Information) GL=Single Element Fuse GM=Double Element Fuse Lamps=Lamps Installed (Refer to Lamp Ordering Options) WTR=White Reveal	

Ballast Type

EB5 =T5 Biax Electronic Instant Start. Total Harmonic Distortion < 20%.¹¹
ER5 =T5 Biax Electronic Program Rapid Start. Total Harmonic Distortion < 10%.¹¹
TEB5 =T5 Biax Electronic Instant Start. Total Harmonic Distortion < 10%.¹¹
EB8 =T8 Electronic Start. Total Harmonic Distortion < 10%.
EB8_/PLUS=T8 Electronic Start. Total Harmonic Distortion < 10%. High Ballast Factor > 1.15
ER8 =T8 Electronic Program Rapid Start. Total Harmonic Distortion < 10%.

High Performance T8 Ballasts

HB8 =T8 Electronic Instant Start. Total Harmonic Distortion < 10%. Standard Ballast Factor .86 - .88
HB8_H=T8 Electronic Instant Start. Total Harmonic Distortion < 10%. High Ballast Factor 1.15 - 1.20
HB8_L=T8 Electronic Instant Start. Total Harmonic Distortion < 10%. Low Ballast Factor .77 - .82
HB8_N=T8 Electronic Instant Start. Total Harmonic Distortion < 10%. Normal Ballast Factor 1.0
HR8 =T8 Electronic Program Rapid Start. Total Harmonic Distortion < 10%. Standard Ballast Factor .86 - .88
HR8_DIM=T8 Electronic Program Rapid Start. Total Harmonic Distortion < 10%. Step Dimming. Ballast Factor .88
HR8_H=T8 Electronic Program Rapid Start. Total Harmonic Distortion < 10%. High Ballast Factor 1.15 - 1.20
HR8_L=T8 Electronic Program Rapid Start. Total Harmonic Distortion < 10%. Low Ballast Factor .71 - .79

Number of Ballasts	Options	Packaging	Accessories (Order Separately)
1=1 Ballast 2=2 Ballasts 3=3 Ballasts (2' x 4' Only)	PAF=Painted After Fabrication REP=Riveted End Plates RIF1=Radio Interference Suppressor	PAL=Job Pack, out of carton PALC=Job Pack, in carton U=Unit Pack	EQ-CLIP-U=T-BAR Safety Earthquake Clips ¹²

NOTES: 1. Integral End Plate Grid Lock feature not available in Heat Removal. 2. For 20" width, must specify 2024 or 2048 in ordering logic. 3. Specify row configuration, type in catalog number when ordering complete fixtures. 4. Louver is recessed by 5/16" in Concealed T or Slot Grid T. 5. 1' x 4' only. 6. 2' x 4' only. 7. 2 lamps only. 8. 2 lamps only. 9. Products also available in non-US voltage and frequencies for international markets. 10. Not available when specifying emergencies, voltage must be specified. 11. Not available in UNV voltage. Must specify voltage. 12. An EQ Grid Clip is recommended for all 9/16" ceiling systems. Four required per fixture. 13. Standard off-center ballast on 3-lamp fixtures.

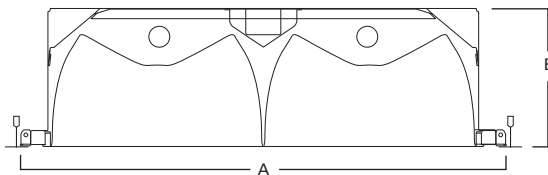

NOMINAL SIZE	A	B
1' x 2'	11-3/4" (298mm)	7" (178mm)
1' x 4'	11-3/4" (298mm)	7" (178mm)
2' x 2'	23-3/4" (603mm)	6-3/4" (172mm)
2' x 4'	23-3/4" (603mm)	6-3/4" (172mm)
20" x 24"	19-3/4" (502mm)	6-1/8" (156mm)
20" x 48"	19-3/4" (502mm)	7-3/8" (187mm)

PRODUCT INFORMATION FOR PARALUX V

Housing Size	Lamp Quantity	Louver Cell Configuration*	Number of Cells
1' x 2'	1 or 2	14	4
1' x 4'	1 or 2	19	9
2' x 2'	2	24	8
	3	34	12
20" x 24"	2	24	8
20" x 48"	2	29	18
2' x 4'	2	29	18
	3	39	27

*Example: 39= 3 rows of 9 (27 cells)

Specifications and dimensions subject to change without notice. Consult your Cooper Lighting Representative or visit www.cooperlighting.com for available options, accessories and ordering information.

FEATURES

- Excellent low-brightness luminaire for accent lighting
- Die-formed nominal 7" deep steel-construction housing
- Ballasts are CBM/ETL Class P and positively secured by mounting bolts
- 3" nominal precision-cell, parabolic louver
- High shielding and low brightness louver for optimal lighting
- Fits into nominal 12" square opening
- Heavy-duty, adjustable mounting brackets

DIMENSIONS

1' x 1'

Compliances may not apply to all product configurations. Please consult the product spec sheet for compliance details.

COMPLIANCES: UL/cUL Listed, UL/cUL Listed - Damp Location



P3 SERIES

ORDERING INFORMATION

SAMPLE NUMBER: P3-2BX18S22I-RS-UNV-EB81-U

Series	Number of Lamps (Not Included)	Wattage	Louver Color	Cell Configuration	Louver Finish	Ballast Start Type
P3=Paralux III	2=2 Lamps 3=3 Lamps	BX18 =18W Biax RS OC16 =16W T8	S =Silver	22 =2 Rows of 2, 4 Cell (1' x 1') 33 =3 Rows of 3, 9 Cell (2' x 2')	I =Semi-Specular/Haze (Low Iridescent) Standard MI =Specular/Mirrored (Low Iridescent)	RS =Rapid Start
Voltage ¹	Options	Ballast Type	Number of Ballasts	Options	Packaging	
120V =120 Volt 277V =277 Volt 347V =347 Volt UNV =Universal Voltage 120-277	GL =Single Element Fuse GM =Double Element Fuse	EB8 =T8 Electronic Instant Start. Total Harmonic Distortion < 10%	1=1 Ballast 2=2 Ballasts	NDF =Natural Aluminum Trim REP =Riveted End Plates RIF1 =Radio Interference Suppressor RLS =Rotor Lock Socket (T8 Lamps Only)	U =Unit Pack	

NOTES: 1. Products also available in non-US voltage and frequencies for international markets.

1' x 1'

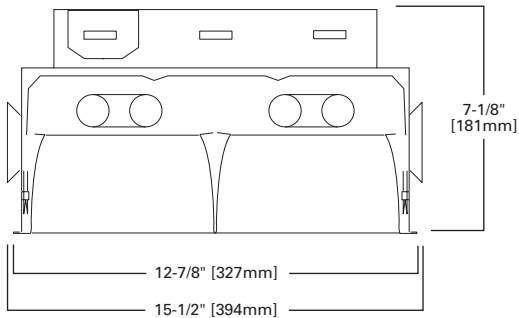

PARALUX III, IV, V SURFACE PARABOLIC



FEATURES

- Provided with CEE-listed, energy-saving ballasts
- Computer-designed, precision-cell parabolic louver
- Die-formed housing
- Full-seam welded corners
- Louvers available in white or silver semi-specular finish
- System complies with RP-1 and meets today's lighting needs
- Self-locking, spring-loaded cam latch with positive hinging mechanism

DIMENSIONS

1' x 4', 2' x 2', 2' x 4'

Compliances may not apply to all product configurations. Please consult the product spec sheet for compliance details.

COMPLIANCES: UL/cUL Listed, UL/cUL Listed - Damp Location

PMX SERIES



ORDERING INFORMATION^A

SAMPLE NUMBER: 2EP3MX-332S36I-UNV-EB81-U

Width	Paralux Louver	Louver Depth	Surface Mount	Number of Lamps (Not Included)	Wattage (Length)	Louver Color
2=2' Width [Blank]=1' Width	EP=Paralux Louver (III) ¹ P=Paralux Louver	3=Paralux III 5=Paralux V [Blank]=Paralux IV	MX=Surface Mount/ Floating Door	1=1 Lamp ² 2=2 Lamps 3=3 Lamps 4=4 Lamps	17=17W T8 (24") 32=32W T8 (48") BX40=40W Biax T5 (24") ³ U1-5/8=31W T8 (24") U6T8=31W T8 (24") ^{4,3}	S=Silver W=White
Cell Configuration	Louver Finish	Voltage ⁵		Options		
18=1 Row of 8, 8 Cell (1' x 4') 26=2 Rows of 6, 12 Cell 28=2 Rows of 8, 16 Cell 33=3 Rows of 3, 9 Cell (2' x 2') 34=3 Rows of 4, 12 Cell (2' x 2') 36=3 Rows of 6, 18 Cell 39=3 Row of 9, 27 Cell 44=4 Rows of 4, 16 Cell (2' x 2') 48=4 Rows of 8, 32 Cell (2'x4')	I=Semi-Specular/Haze (Low Iridescent) Standard MI=Specular/Mirrored (Low Iridescent) P=Painted	120V=120 Volt 277V=277 Volt 347V=347 Volt UNV=Universal Voltage 120-277 ⁶		EL=Emergency Installed (Must Specify Battery Pack, See Options) Flex=Flex Installed (Reference Flex Ordering Information) GL=Single Element Fuse GM=Double Element Fuse		
Ballast Type				Number of Ballasts	Options	Packaging
Biax Ballasts EB5=T5 Biax Electronic Instant Start. Total Harmonic Distortion < 20%. ⁷ TEB5=T5 Biax Electronic Instant Start. Total Harmonic Distortion < 10%. ⁷ T8 Ballasts EB8=T8 Electronic Start. Total Harmonic Distortion < 10%. EB8 /PLUS=T8 Electronic Start. Total Harmonic Distortion < 10%. High Ballast Factor > 1.15. ER8=T8 Electronic Program Rapid Start. Total Harmonic Distortion < 10%. High Performance T8 Ballasts HB8=T8 Electronic Instant Start. Total Harmonic Distortion < 10%. Standard Ballast Factor .86-.88 HB8_H=T8 Electronic Instant Start. Total Harmonic Distortion < 10%. High Ballast Factor 1.15-1.20 HB8_L=T8 Electronic Instant Start. Total Harmonic Distortion < 10%. Low Ballast Factor .77-.82 HB8_N=T8 Electronic Instant Start. Total Harmonic Distortion < 10%. Normal Ballast Factor 1.0 HR8=T8 Electronic Program Rapid Start. Total Harmonic Distortion < 10%. Standard Ballast Factor .86-.88 HR8_DIM=T8 Electronic Program Rapid Start. Total Harmonic Distortion < 10%. Step Dimming. Ballast Factor .88 HR8_H=T8 Electronic Program Rapid Start. Total Harmonic Distortion < 10%. High Ballast Factor 1.15-1.20 HR8_L=T8 Electronic Program Rapid Start. Total Harmonic Distortion < 10%. Low Ballast Factor .71-.79				1=1 Ballast 2=2 Ballasts 3=3 Ballasts ¹	EKO=7/8" KOs in End of Fixture Housing ⁶ PI/CPI=Plug-In Option SMB=Side Mounted Ballast For Stem Applications WTR=White Reveal	PAL=Job Pack Out of Carton PALC=Job Pack, in carton U=Unit Pack

NOTES: 1. 2' x 4' only. 2. 1' x 4' only. 3. 2' x 2' only. 4. 2 lamps only. 5. Products also available in non-US voltage and frequencies for international markets. 6. Not available when specifying emergencies, voltage must be specified. 7. Must specify voltage.

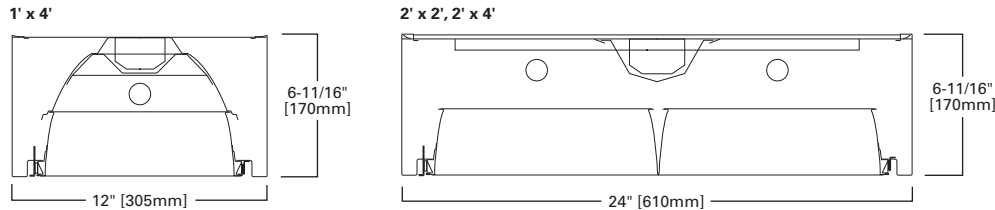

Specifications and dimensions subject to change without notice. Consult your Cooper Lighting Representative or visit www.cooperlighting.com for available options, accessories and ordering information.

RESIDENTIAL T8 SHOP LIGHT



SHOP LIGHT SERIES

FEATURES

- Uses two fluorescent lamps (not included)
- Cold rolled steel with baked white enamel paint
- Cord and plug installed
- Chain included (for chain hanging applications only)
- Easily installed
- Suitable for damp locations
- UL/cUL listed

DIMENSIONS

4'

Compliances may not apply to all product configurations. Please consult the product spec sheet for compliance details.

COMPLIANCES: UL/cUL Listed - Damp Location, ENERGY STAR Qualified



ORDERING INFORMATION

Catalog Number	Description	Lamp	Shipping Weight
SL232R - Utility Shop Light	2 Lamp 48" Shop Light <ul style="list-style-type: none"> • Electronic Ballast, Start Temp 0°F • 4" Reflector • 6 Foot Cord • Pull Chain • (2) S-hook 12" Chains • Pre-assembled 	(2) 32W T8 Lamps (Not Included)	6.42 lbs.
SLNR232R - Medium-grade Shop Light	2 Lamp 48" Shop Light <ul style="list-style-type: none"> • Electronic Ballast, Start Temp 0°F • 7" Reflector • 6 Foot Cord • Pull Chain • (2) S-hook 12" Chains • Pre-assembled 	(2) 32W T8 Lamps (Not Included)	7.9 lbs.
SLWR232R - Heavy-duty Shop Light	2 Lamp 48" Shop Light <ul style="list-style-type: none"> • Electronic Ballast, Start Temp 0°F • 12" Reflector • 6 Foot Cord • Pull Chain • (2) S-hook 12" Chains • Some assembly required 	(2) 32W T8 Lamps (Not Included)	12 lbs.

UTILITY SHOP LIGHT - SL232R

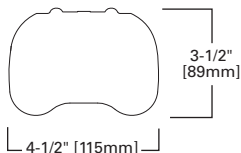

MEDIUM-GRADE SHOP LIGHT - SLNR232R

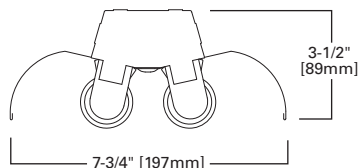

HEAVY-DUTY SHOP LIGHT - SLWR232R

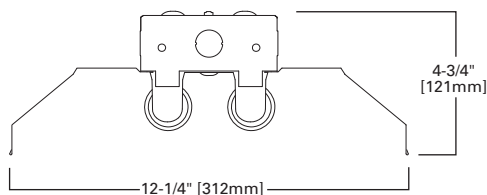

SERIES OPTIONS



SL232R



SLNR232R



SLWR232R

Specifications and dimensions subject to change without notice. Consult your Cooper Lighting Representative or visit www.cooperlighting.com for available options, accessories and ordering information.

CIRCLINE ROUND, SQUARE



FEATURES

- Opal white acrylic diffuser
- Baked white enamel finish with reflective base
- Uses one or two circline lamps (included)
- Diffuser easily removed for lamp replacement or service
- Square or saucer profiles

DIMENSIONS

11", 14", 19"

Compliances may not apply to all product configurations. Please consult the product spec sheet for compliance details.

COMPLIANCES: UL Listed - Damp LocationCIRCLINE
DECORATIVE
SERIES

ORDERING INFORMATION

Catalog Number	Description	Lamp	Shipping Weight
DECORATIVE			
7413	Round Acrylic Saucer, 11" Diameter White Circline	11" Diameter, Single 22W Lamp	4 lbs. (1.8kg)
7013	Square Acrylic Puff, 12" Diameter White Circline	12" Diameter, Single 22W Lamp	5 lbs. (2.3kg)
7033	Square Acrylic Puff, 14" Diameter White Circline	14" Diameter, (1) 22W and (1) 32W Lamp	7 lbs. (3.2kg)

ROUND SERIES

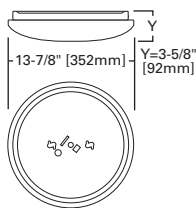
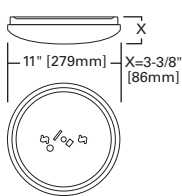

SQUARE SERIES

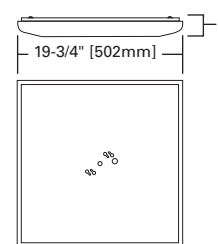
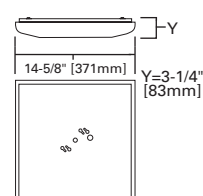
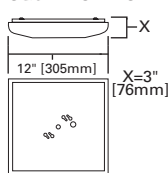

SERIES OPTIONS



Round Acrylic Saucer

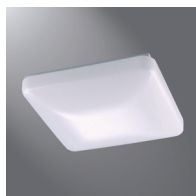

Square Acrylic Puff

CIRCLINE UTILITY



FEATURES

- Uses one or two circline lamps (not included)
- Bare lamp
- Lamps secured by spring lamp clips
- Chrome-plate finish

DIMENSIONS

8"

Compliances may not apply to all product configurations. Please consult the product spec sheet for compliance details.

COMPLIANCES: UL/cUL Listed - Damp LocationCIRCLINE UTILITY
SERIES

ORDERING INFORMATION

Catalog Number	Description	Lamp	Shipping Wt.
UTILITY			
7112	Bare Lamp, 8" Diameter Chrome Circline	8" Diameter, Single 22W Lamp	3 lbs. (1.4kg)

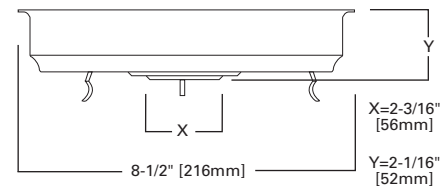

FEATURES

- Opal white acrylic diffuser with solid wood trims
- Snap-flush mounting for easy installation
- Heavy-gauge steel housing with baked white enamel finish
- Uses two or four fluorescent lamps (not included)

DIMENSIONS

15" x 48", 24" x 24"

Compliances may not apply to all product configurations. Please consult the product spec sheet for compliance details.

COMPLIANCES: UL Listed - Damp Location, ENERGY STAR Qualified**DECORATIVE WOOD TRIMS****DECORATIVE SERIES****ORDERING INFORMATION**

Catalog Number	Product Description	Size	Lamp	Shipping Weight
DT432WR	Wood Trim, 15" x 48", (4) T8/32W Lamps, 120V Resi Ballast, White Finish	15" x 48"	4 - F32T8	27 lbs. (12.2 kg)
DT432OR	Wood Trim, 15" x 48", (4) T8/32W Lamps, 120V Resi Ballast, Natural Oak Finish	15" x 48"	4 - F32T8	27 lbs. (12.2 kg)
DT432UNR	Wood Trim, 15" x 48", (4) T8/32W Lamps, 120V Resi Ballast, Unfinished Finish	15" x 48"	4 - F32T8	27 lbs. (12.2 kg)
DT2U632WR	Wood Trim, 24" x 24", (2) U6T8/32W Lamps, 120V Resi Ballast, White Finish	24" x 24"	2 - FU32T8	20 lbs. (9 kg)
DT2U632OR	Wood Trim, 24" x 24", (2) U6/32W Lamps, 120V Resi Ballast, Natural Oak Finish	24" x 24"	2 - FU32T8	20 lbs. (9 kg)
DT2U632UNR	Wood Trim, 24" x 24", (2) U6T8/32W Lamps, 120V Resi Ballast, Unfinished Finish	24" x 24"	2 - FU32T8	20 lbs. (9 kg)

FINISH OPTIONS

White Finish



Natural Oak Finish



Unfinished Finish

Specifications and dimensions subject to change without notice. Consult your Cooper Lighting Representative or visit www.cooperlighting.com for available options, accessories and ordering information.

CIRCLINE DECORATIVE

**FEATURES**

- Unique decorative trims with matte white lenses
- Residential electronic ballast
- Fully assembled and ready to install (mounting hardware included)
- Uses one 22W or one 32W circline lamp (included)

DIMENSIONS

14"

Compliances may not apply to all product configurations. Please consult the product spec sheet for compliance details.

COMPLIANCES: UL Listed - Damp LocationSMALL CIRCLINE
DECORATIVE
SERIES**ORDERING INFORMATION**

Catalog Number	Description	Shipping Weight
Amber Mission Square 7508	14", 2-Lamp 22/32W, Mission Trim w/Classic Amber Stain	7 lbs. (3.2kg)
Satin Nickel Round 7235-REB1	14", 2-Lamp 26W Compact Fluorescent, Contemporary Satin Nickle Trim	7 lbs. (3.2kg)

TRIM OPTIONS

Satin Nickel Round



Amber Mission Square

Specifications and dimensions subject to change without notice. Consult your Cooper Lighting Representative or visit www.cooperlighting.com for available options, accessories and ordering information.

WALL BRACKET AND WALL CLOUD



WALL BRACKET, UNDERCABINET SERIES

FEATURES

- Uses one or two fluorescent lamps
- Contemporary styling
- Die-formed housing
- Baked white enamel finish
- Extruded, smooth opal, white acrylic refractor
- 180° uniform light distribution
- Decorative opaque injection molded white end plates
- Easy wiring access
- Vertical-wall or horizontal-ceiling-mount applications

DIMENSIONS

2', 3', 4'

Compliances may not apply to all product configurations. Please consult the product spec sheet for compliance details.

COMPLIANCES: UL/cUL Listed - Damp Location



ORDERING INFORMATION

Catalog Number ^{1,2}	Description	Shipping Weight
(White Ends / 1 Light)		
6212	1 lamp 24", 20W T12	7 lbs. (3.2kg)
6313	1 lamp 36", 30W T12	9 lbs. (4.1kg)
6414	1 lamp 48", 40W T12	12 lbs. (5.4kg)
(White Ends / 2 Light)		
6222	2 lamp 24", 20W T12	7 lbs. (3.2kg)
6424	2 lamp 48", 40W T12	12 lbs. (5.4kg)
(Wall Cloud)		
6232	2 lamp 24", 20W T12	8 lbs. (3.6kg)
6434	2 lamp 48", 40W T12	13 lbs. (5.9kg)
6434E ¹	2 lamp 48", with LE3, 40W T12	13 lbs. (5.9kg)
6434-REB1	2 lamp 48", with LE3, 32W T8	13 lbs. (5.9kg)

NOTES: 1. "E" in catalog number means Electronic Ballast that operates T12 lamps. 2. Commercial Grade Electronic Ballast (EB81) available on a "made to order" basis.

WALL BRACKET SERIES

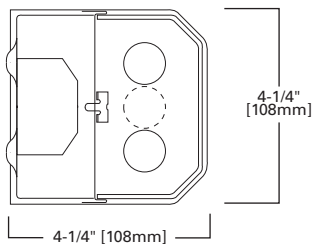

WALL CLOUD SERIES

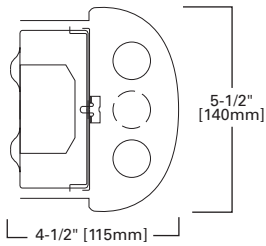

SERIES OPTIONS



Wall Cloud



Wall Bracket

Specifications and dimensions subject to change without notice. Consult your Cooper Lighting Representative or visit www.cooperlighting.com for available options, accessories and ordering information.

SURFACE T8



FEATURES

- Residential application
- High-impact acrylic lens offers superior durability
- 120V residential ballast
- Die-formed housing with high quality paint finish
- Lift-and-shift lens is mechanically retained by end caps
- Lamps not included

DIMENSIONS

2', 4'

Compliances may not apply to all product configurations. Please consult the product spec sheet for compliance details.

COMPLIANCES: UL/cUL Listed - Damp Location, ENERGY STAR Qualified

WP SERIES



ORDERING INFORMATION

SAMPLE NUMBER: WP232R

Series	Number of Lamps (Not Included)	Wattage	Application
WP=Surface Wrap	2=2 Lamps	17=17W T8 (24") 32=32W T8 (48")	R=Residential (120V)

2', 4'

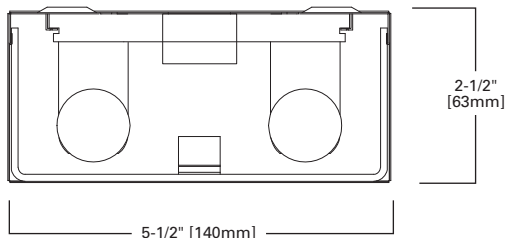

SURFACE WRAPAROUND

WRAPAROUND
OAK TRIM SERIES

FEATURES

- White acrylic diffuser with low brightness
- Low-profile design with light oak wood ends
- Lift-and-shift refractor offers easy re-lamping
- Uses two or four fluorescent lamps (not included)

DIMENSIONS

2', 4'

Compliances may not apply to all product configurations. Please consult the product spec sheet for compliance details.

COMPLIANCES: UL/cUL Listed - Damp Location

ORDERING INFORMATION

Catalog Number	Description	Shipping Weight
W2324-REB1	2 lamp, 4', 32W T8, Light Oak Wood Ends	13 lbs. (5.9kg)
W2344-REB1	4 lamp, 4', 32W T8, Light Oak Wood Ends	20 lbs. (9kg)

2 LAMP

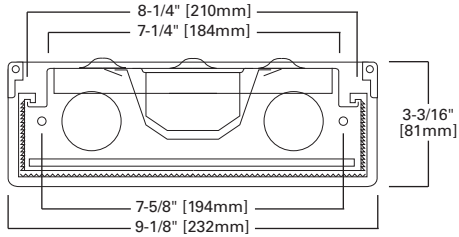

4 LAMP

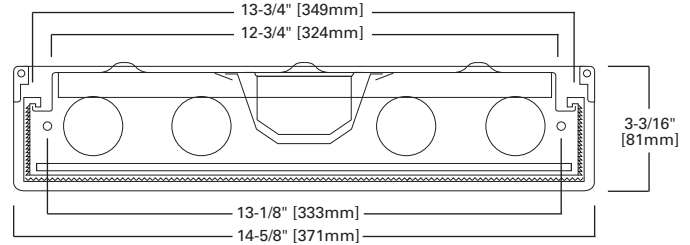

SURFACE T8



FEATURES

- Acrylic lens formulated to protect against lens breakage
- Tuff' R' Puff commercial-grade acrylic lens
- 120V instant-start residential or commercial ballast
- Housing manufactured with die-formed, cold-rolled steel
- Snap-fit for ease of service and re-lamping
- Ideal choice for most residential and commercial applications
- Lamps not included

DIMENSIONS

1' x 4', 1-1/2' x 4'

Compliances may not apply to all product configurations. Please consult the product spec sheet for compliance details.

COMPLIANCES: UL/cUL Listed - Damp Location, ENERGY STAR Qualified

WSC SERIES



ORDERING INFORMATION

SAMPLE NUMBER: WSC232R

Series	Number of Lamps (Not Included)	Wattage (Length)	Application
WSC=Softside Cloud	2=2 Lamps 4=4 Lamps	32=32W T8 (48") U6T8=32W T8 (24") ¹	R=Residential

NOTES: 1. Two lamp only.

1' x 4', 2 LAMP

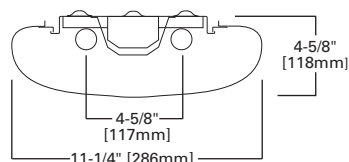

1-1/2' x 4', 4 LAMP

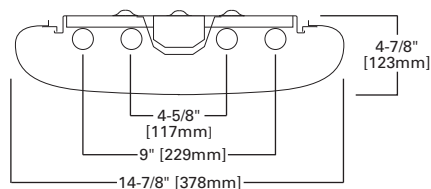

2' x 2', 2 U-LAMPS

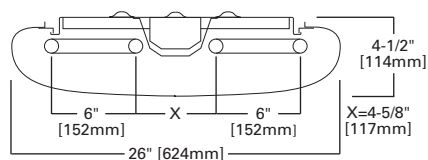

ALTERNATE PRODUCTS



1' x 4'

Specifications and dimensions subject to change without notice. Consult your Cooper Lighting Representative or visit www.cooperlighting.com for available options, accessories and ordering information.

FEATURES

- Energy-saving applications where fixture removal is cost-prohibitive
- Convert standard 4' and 8' T8 or T12 industrial or strips
- Fits industrial or strip channels from 4" to 5-5/8" wide
- Two optical distributions, specular or high-performance white
- Twist-lock sockets; 20-gauge socket tracks; mounting hardware provided
- Bulk-packed kits for easier handling
- Order with or without ballasts
- Pre-wiring options to speed installation
- Quick, safe and efficient installation and maintenance

DIMENSIONS

4', 8'

Compliances may not apply to all product configurations. Please consult the product spec sheet for compliance details.

COMPLIANCES: UL Classified



ORDERING INFORMATION

SAMPLE NUMBER: 8ECS-232-M-NB-EB8-U

Width	Series	Number of Lamps (Not Included)	Lamp Type	Optics	Voltage ¹
8=8' [Blank]=4'	ECS=Ecofit Strip	1=1 Lamp 2=2 Lamps	32=32W T8 Lamps (48") 54=54W T5HO Lamp (48")	BC=Ballast/Channel Cover (Covers from 4" to 5-1/4" Wide) M=Medium (Specular Aluminum) W=Wide (White)	NB=No Ballast UNV=Universal Voltage Ballast Included
Ballast - Socket Type ¹				Number of Ballasts	Order Quantity - Packaging
T5 Ballasts EBT_=T5 or T5HO Electronic Program Start. Total Harmonic Distortion < 10%. Standard Ballast Factor =1.0 T8 Ballasts EB8_=T8 Electronic Instant Start. Total Harmonic Distortion < 10%. EB8_/L=T8 Electronic Instant Start with < 0.80 Ballast Factor. EB8_/PLUS=T8 Electronic Start. Total Harmonic Distortion < 10%. High Ballast Factor > 1.15 ER8_=T8 Electronic Program Rapid Start. Total Harmonic Distortion < 10%. ²				1=1 Ballast 2=2 Ballasts [Blank]=No Ballast (NB Options Only)	U=Unit Qty (Packaging will be Determined by Factory)

NOTES: 1. When using Ecofit Kits without ballasts, indicate ballast type and system to designate shunted or unshunted sockets. Ex: ECS-23 2-M-EB81-10B. 2. Recommended when using retrofits together with motion sensor, daylight harvesting or similar controls.

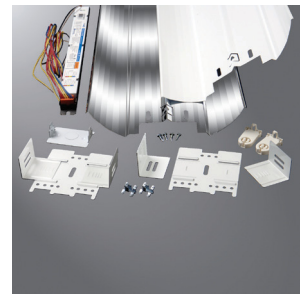

**INDUSTRIAL
RETROFIT KIT
(ECS)**

4' or 8', 1 or 2 LAMPS

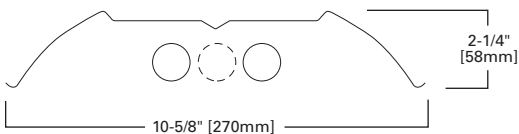

INSTALLATION, 2 LAMP

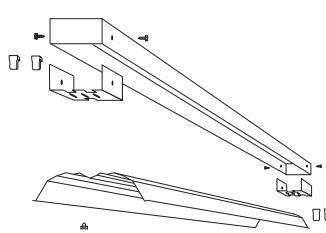

STRIP KIT (WITH REFLECTOR)

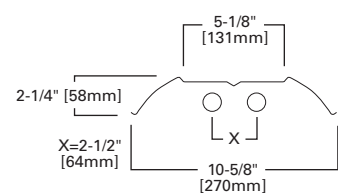

STRIP KIT (NO REFLECTOR)

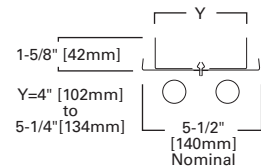

RETROFIT KITS - COMMERCIAL TROFFER OR PARABOLIC

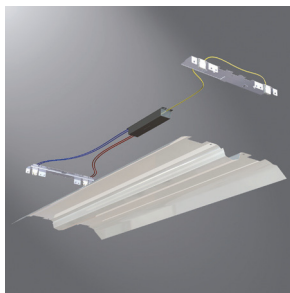

FEATURES

- Save 50% or more in energy over existing 4-lamp T12 luminaires
- Fast and cost-effective solution for saving time and money
- Reuses existing housing and shielding for a below-the-plenum install
- Ready-Set™ captive screws for quick, easy installation
- Installs in less than 10 minutes
- Pre-wired assembly with or without CEE-listed ballast
- One-piece, tool-less reflector eliminates the need for parts bag
- Fits troffers or parabolics as shallow as 3-1/4"
- Optional white optics 97% reflective finish

DIMENSIONS

2' x 2', 2' x 4'

COMMERCIAL RETROFIT KIT (ART)

Compliances may not apply to all product configurations. Please consult the product spec sheet for compliance details.

COMPLIANCES: UL Classified



ORDERING INFORMATION

SAMPLE NUMBER: ART-2CRK-232-W-NB-EB8-10B

Product	Width	Series	Number of Lamps (Not Included)	Wattage (Length)	Distribution
ART=Advanced Retrofit Technology	2=24" Wide	CRK=Commercial Retrofit Kit	2=2 Lamps 3=3 Lamps	14T5=14W T5 (24") 17=17W T8 (24") 24T5=24W T5HO (24") 28T5=28W T5 (48") 32=32W T8 (48") U1-5/8=31W 1-5/8" U-Lamp (24") ¹	W=White (Medium) WO=White Optics (High Reflectance)
Voltage ²	Ballast Type			Number of Ballasts	Packaging
NB=No Ballast UNV=Universal Voltage ³	<p>T5 Ballasts EBT_=T5 or T5HO Electronic Program Rapid Start. Total Harmonic Distortion < 10%. Standard Ballast Factor=1.0⁴</p> <p>Ballast/Factor Type (T5) EBT_H=T5 Electronic Program Rapid Start. Total Harmonic Distortion < 10%. High Ballast Factor=1.15⁵ EBT_N=T5 Electronic Program Rapid Start. Total Harmonic Distortion < 10%. Normal Ballast Factor=.90⁶</p> <p>T8 Ballasts EB8_=T8 Electronic Start. Total Harmonic Distortion < 10%. EB8_/PLUS=T8 Electronic Start. Total Harmonic Distortion < 10%. High Ballast Factor > 1.15 ER8_=T8 Electronic Program Rapid Start. Total Harmonic Distortion < 10%. ER8_/PLUS=T8 Electronic Program Rapid Start. Total Harmonic Distortion < 10%. High Ballast Factor > 1.15</p>			1=1 Ballast 2=2 Ballasts ⁴ [Blank]=No Ballast (NB Option Only)	10B=Bulk Pack U=Unit Pack (Consult Factory for Other Packaging Options)

NOTES: 1. 2 lamp 2' x 2' only. 2. Products also available in non-US voltage and frequencies for international markets. 3. Not available when specifying emergencies, voltage must be specific. 4. 2 ballasts are required when specifying 3 or more 28T5 lamps. 5. 1-Lamp ballast in a High Ballast factor not available. 6. .90 ballast factor available for 2 or 3 14W T5 or 28W T5 lamps only.

COMMERCIAL RETROFIT 2' x 2', 2' x 4'

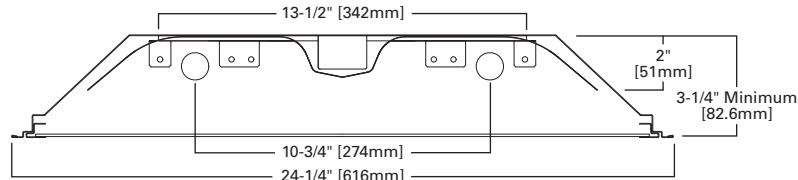

Specifications and dimensions subject to change without notice. Consult your Cooper Lighting Representative or visit www.cooperlighting.com for available options, accessories and ordering information.

FEATURES

- Ideal for commercial, educational and retail merchandising retrofits
- White louver straight-blade cross-members for optimal light efficiency
- Save 50% or more in energy over existing 4-lamp T12 luminaires
- Fits troffers or parabolics as shallow as 3-1/2"
- Pre-assembled and wired to CEE-listed ballast
- Ready-Set™ captive screws for quick, easy installation in 10 minutes
- One-piece, tool-less reflector eliminates the need for parts bag
- Reuse existing housing to lower installation time and removal cost

DIMENSIONS

2' x 2', 2 x 4'

Compliances may not apply to all product configurations. Please consult the product spec sheet for compliance details.

COMPLIANCES: UL Classified

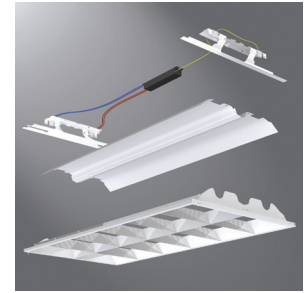

**OPTICAHP
RETROFIT KIT
(ART)**

ORDERING INFORMATION

SAMPLE NUMBER: ART-20P-232-UNV-EB81-10B

Product	Width	Series	Number of Lamps (Not Included)	Wattage (Length)	Distribution	Voltage ²
ART=Advanced Retrofit Technology	2=24" Wide	OP=Optica Retrofit Kit	2=2 Lamps	14T5=14W T5 (24") 17=17W T8 (24") 24T5=24W T5HO (24") 254T5=54W T5HO (48") 28T5=28W T5 (48") 32=32W T8 (48") U1-5/8=31W 1-5/8" U-Lamp (24") ¹	[Blank]=White (Medium) WO=White Optics (High Reflectance)	120V=120 Volt 277V=277 Volt 347V=347 Volt NB=No Ballast UNV=Universal Voltage ³
Emergency Option	Ballast Type				Number of Ballasts	Packaging
EL=Emergency Installed (Consult Factory)	<p>T5 Ballasts EBT_=T5 or T5HO Electronic Program Rapid Start. Total Harmonic Distortion < 10%. Standard Ballast Factor=1.0</p> <p>Ballast/Factor Type (T5) EBT_H=T5 Electronic Program Rapid Start. Total Harmonic Distortion < 10%. High Ballast Factor=1.15⁵ EBT_N=T5 Electronic Program Rapid Start. Total Harmonic Distortion < 10%. Normal Ballast Factor=.90⁶</p> <p>T8 Ballasts EB8_=T8 Electronic Start. Total Harmonic Distortion < 10%. EB8_/PLUS=T8 Electronic Start. Total Harmonic Distortion < 10%. High Ballast Factor > 1.15 ER8_=T8 Electronic Program Rapid Start. Total Harmonic Distortion < 10%.</p> <p>High Performance T8 Ballasts HB8_=T8 Electronic Instant Start. Total Harmonic Distortion < 10%. Standard Ballast Factor .86-.88 HB8_H=T8 Electronic Instant Start. Total Harmonic Distortion < 10%. High Ballast Factor 1.15-1.20 HB8_L=T8 Electronic Instant Start. Total Harmonic Distortion < 10%. Low Ballast Factor .77-.82 HB8_N=T8 Electronic Instant Start. Total Harmonic Distortion < 10%. Normal Ballast Factor 1.0 HR8_DIM=T8 Electronic Program Rapid Start. Total Harmonic Distortion < 10%. Step Dimming. Ballast Factor .88⁴ HR8_H=T8 Electronic Program Rapid Start. Total Harmonic Distortion < 10%. High Ballast Factor 1.15-1.20⁴ HR8_L=T8 Electronic Program Rapid Start. Total Harmonic Distortion < 10%. Low Ballast Factor .71-.79⁴ HR8_T8=T8 Electronic Program Rapid Start. Total Harmonic Distortion < 10%. Standard Ballast Factor .86-.88⁴</p>	1=1 Ballast 2=2 Ballasts [Blank]=No Ballast (NB Option Only)	10B=Bulk Pack U=Unit Pack (Consult Factory for Other Packaging Options)			

NOTES: 1. 2 lamp 2'x2' only. 2. Products also available in non-US voltage and frequencies for international markets. 3. Not available when specifying emergencies, voltage must be specific. 4. Recommended when using retrofits together with motion sensor, daylight harvesting or similar controls. 5. 1-Lamp ballast in a High Ballast factor not available. 6. .90 ballast factor available for 2 or 3 14W T5 or 28W T5 lamps only.

OPTICAHP RETROFIT 2' x 2', 2' x 4'

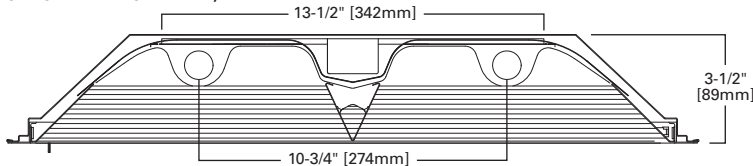

RETROFIT KITS - ARCHITECTURAL



FEATURES

- Ideal for office, government, educational and retail retrofits
- Architectural-inspired center basket or dual-lens design
- Save 50% or more in energy over existing 4-lamp T12 luminaires
- Pre-assembled and wired to CEE-listed ballast
- Ready-Set™ captive screws for quick, easy installation in 10 minutes
- One-piece, tool-less reflector eliminates the need for parts bag
- Fits troffers or parabolics as shallow as 3-1/2" deep
- Reuse existing housing to lower installation time and removal cost

DIMENSIONS

2' x 2', 2' x 4'

Compliances may not apply to all product configurations. Please consult the product spec sheet for compliance details.

COMPLIANCES: UL Classified



ARCDUO, CRUZE
RETROFIT KITS
(ART)

ORDERING INFORMATION

SAMPLE NUMBER: ART-2ARC-232L-UNV-EB81-10B

Product	Width	Series	Number of Lamps (Not Included)	Wattage (Length)	Shielding	Distribution	Voltage ¹
ART=Advanced Retrofit Technology	2=24" Wide	ARC=ArcDuo Retrofit Kit CRZ=Cruze Retrofit Kit	2=2 Lamps	14T5=14W T5 (24") 17=17W T8 (24") 24T5=24W T5HO (24") 28T5=28W T5 (48") 32=32W T8 (48") 54T5=54W T5HO (48")	L=Acrylic Lens Shield (Standard)	[Blank]=White (Medium) WO=White Optics (High Reflectance)	120V=120 Volt 277V=277 Volt 347V=347 Volt NB=No Ballast UNV=Universal Voltage ²
Emergency Option	Ballast Type					Number of Ballasts	Packaging
EL=Emergency Installed (Consult Factory)	<p>T5 Ballasts EBT_<u>T</u>5 or T5HO Electronic Program Rapid Start. Total Harmonic Distortion < 10%. Standard Ballast Factor=1.0</p> <p>Ballast/Factor Type (T5) EBT_<u>H</u>5=T5 Electronic Program Rapid Start. Total Harmonic Distortion < 10%. High Ballast Factor=1.15⁴ EBT_<u>N</u>5=T5 Electronic Program Rapid Start. Total Harmonic Distortion < 10%. Normal Ballast Factor=.90⁵</p> <p>T8 Ballasts EB8_<u>T</u>8=T8 Electronic Start. Total Harmonic Distortion < 10%. EB8_<u>/PLUS</u>8=T8 Electronic Start. Total Harmonic Distortion < 10%. High Ballast Factor > 1.15 ER8_<u>T</u>8=T8 Electronic Program Rapid Start. Total Harmonic Distortion < 10%.</p> <p>High Performance T8 Ballasts HB8_<u>T</u>8=T8 Electronic Instant Start. Total Harmonic Distortion < 10%. Standard Ballast Factor .86-.88 HB8_<u>H</u>8=T8 Electronic Instant Start. Total Harmonic Distortion < 10%. High Ballast Factor 1.15-1.20 HB8_<u>L</u>8=T8 Electronic Instant Start. Total Harmonic Distortion < 10%. Low Ballast Factor .77-.82 HB8_<u>N</u>8=T8 Electronic Instant Start. Total Harmonic Distortion < 10%. Normal Ballast Factor 1.0 HR8_<u>DIM</u>8=T8 Electronic Program Rapid Start. Total Harmonic Distortion < 10%. Step Dimming. Ballast Factor .88³ HR8_<u>H</u>8=T8 Electronic Program Rapid Start. Total Harmonic Distortion < 10%. High Ballast Factor 1.15-1.20³ HR8_<u>L</u>8=T8 Electronic Program Rapid Start. Total Harmonic Distortion < 10%. Low Ballast Factor .71-.79³ HR8_<u>T</u>8=T8 Electronic Program Rapid Start. Total Harmonic Distortion < 10%. Standard Ballast Factor .86-.88³</p>					1=1 Ballast 2=2 Ballasts [Blank]=No Ballast (NB Option Only)	10B=Bulk Pack U=Unit Pack (Consult Factory for Other Packaging Options)

NOTES: 1. Products also available in non-US voltage and frequencies for international markets. 2. Not available when specifying emergencies, voltage must be specific. 3. Recommended when using retrofits together with motion sensor, daylight harvesting or similar controls. 4. 1-Lamp ballast in a High Ballast factor not available. 5. .90 ballast factor available for 2 or 3 14W T5 or 28W T5 lamps only.

CRUZE RETROFIT 2' x 2', 2' x 4'

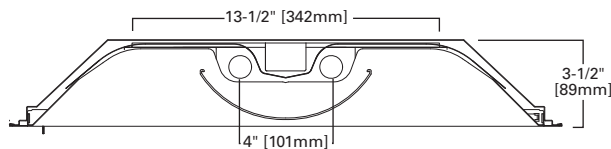

ARCHOS RETROFIT 2' x 2', 2' x 4'

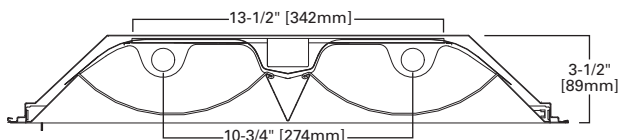

Specifications and dimensions subject to change without notice. Consult your Cooper Lighting Representative or visit www.cooperlighting.com for available options, accessories and ordering information.

FEATURES

- Equipped with energy-saving ballasts
- One-piece, die-formed steel raceway reflector assembly
- Designed to direct 50% more light into the workplace area
- Reflector finish reduces high-angle glare by over 50%
- Optional continuous row mount fixtures available
- Simplified unit or row installation
- Full-access wireway
- Baked white enamel finish
- Optional enhanced recessed silver steel reflector reduces glare

DIMENSIONS

4', 8'

Compliances may not apply to all product configurations. Please consult the product spec sheet for compliance details.

COMPLIANCES: UL/cUL Listed, UL/cUL Listed - Damp Location



RCG SERIES



ORDERING INFORMATION

SAMPLE NUMBER: RCG-A-232-120V-EB81-U

Tandem	Series	Row Configuration	Rails	Number of Lamps (Not Included) ³	Wattage
8T=8' Length [Blank]=4' Length	RC=Recessed Lighting System	C=Continuous Row (In Row) ¹ E=Continuous Row End (End of Row) ¹ G=Single Fixture ²	[Blank]=Open, No Lens/Rail A=Factory Installed Lens and Rail	1=1 Lamp 2=2 Lamps 3=3 Lamps	32=32W T8 (48") 40=40W T12 (48") 48=40W T12 SL (48") 48HO=60W T12HO (48") 48T8HO=44W T8HO (48") 72=55W T12SL (72") 72HO=85W T12HO (72") 72T8HO=65W T8HO (72") 96=75W T12SL (72") ⁴ 96HO=110W T12HO (96") ⁴ 96T8=59W T8SL (96") 96T8HO=86W T8HO (96")
SilverLining	Voltage ⁶	Options	Ballast Type		
[Blank]=White (Standard) ⁵	120V=120 Volt 277V=277 Volt 347V=347 Volt UNV=Universal Voltage 120-277 ⁷	EL=Emergency Installed (Must Specify Battery Pack, See Options) GL=Single Element Fuse GM=Double Element Fuse	[Blank]=Standard Magnetic Ballast T8 Ballasts EB8_=T8 Electronic Start. Total Harmonic Distortion < 10%. EB8_/PLUS=T8 Electronic Start. Total Harmonic Distortion < 10%. High Ballast Factor > 1.15 ER8_=T8 Electronic Program Rapid Start. Total Harmonic Distortion < 10%. T12 Ballasts EB2_=T12 Electronic Rapid Start		
Number of Ballasts	Options	Packaging	Accessories (Order Separately)		
1=1 Ballast 2=2 Ballasts 3=3 Ballasts	FR=Fire Rated Label PI/CPI=Plug-In Option RIF1=Radio Interference Suppressor RLS=Rotor Lock Socket (T8 Lamps Only) TILW=Tandem In-Line Wiring Option	U=Unit Pack	RCG-A-4FT-FRM-U=4' Lens Rail Kit ⁶ RCG-A-4FT-LENS-B=4' Prismatic Acrylic Lens ⁶ RCG-A-6FT-FRM-U=6' Lens Rail Kit ⁶ RCG-A-6FT-LENS-B=6' Prismatic Acrylic Lens ⁶ RCG-A-8FT-FRM-U=8' Lens Rail Kit ⁶ RCG-A-8FT-LENS-B=8' Prismatic Acrylic Lens ⁶ T3 End EQ Bracket=Earthquake Bracket		

NOTES: 1. RCC and RCE fixtures do not require cross tees. 2. RCG fixture requires cross tees. 3. 3-lamp fixture available with T8 lamps only. 4. 296 and 296HO with LE3 only available in 120V. 5. Not available on fixtures using HO lamps. 6. Products also available in non-US voltage and frequencies for international markets. 7. Not available when specifying emergencies, voltage must be specified.

4' or 8', 1 LAMP

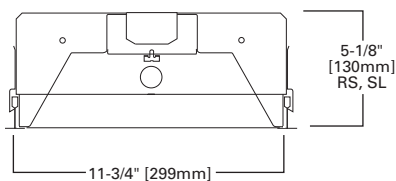

4' or 8', 2 LAMP

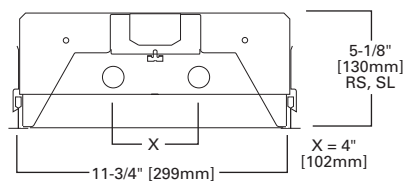

4' or 8', 3 LAMP

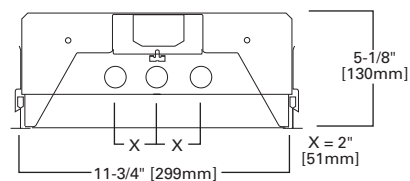

NARROW STRIPLIGHTS



FEATURES

- Flip-up socket feature for faster installation
- Commercial or residential ballast types available
- Heavy-duty, die-formed, cold-rolled steel channel includes knockouts
- Tong hanger groove offered for easy mounting
- Pre-painted material standard; PAF optional
- Tandem 8' lengths
- Optional reflectors in specular or white finishes
- Storage and utility, display case, cove, task and general applications
- Lamps are not included

DIMENSIONS

2', 3', 4', 8'

SNF SERIES

Compliances may not apply to all product configurations. Please consult the product spec sheet for compliance details.

COMPLIANCES: UL/cUL Listed - Damp Location



T5 LAMPS

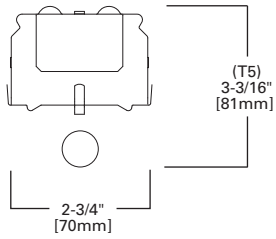

2', 4'
1 lamp T5

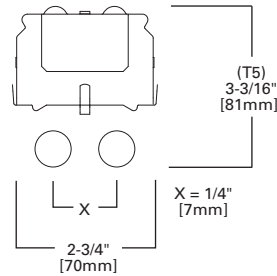

2', 4'
2 lamp T5

T8 LAMPS

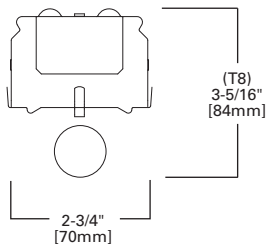

2', 4'
1 lamp T8

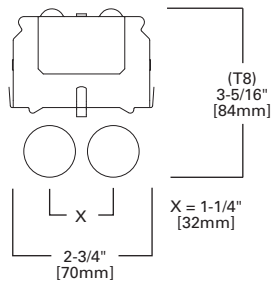

2', 4'
2 lamp T8

T12 LAMPS

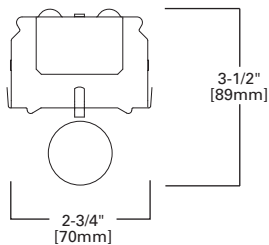

2', 3'
1 lamp T12

ORDERING INFORMATION

SAMPLE NUMBER: SNF-232-UNV-EB81-U

Tandem	Series	Number of Lamps (Not Included)	Wattage	Voltage ^{1,3}	Options
8T=8' Length [Blank]= 2', 3' or 4' Length	SNF=Commercial Narrow Striplight	1=1 Lamp 2=2 Lamp	14T5=14W T5 (24") 17=17W T8 (24") 24T5=24W T5HO (24") 25=25W T8 (36") 28T5=28W T5 (48") 28T8=28W T8 (48") 32=32W T8 (48") 54T5=54W T5HO (48")	120V=120 Volt 277V=277 Volt 347V=347 Volt UNV=Universal Voltage 120-277	EL=Emergency Installed (Must Specify Battery Pack, See Options) EL4LP=Low Profile Emergency Installed ^{2,3} EL5HOLP=Emergency Installed for T5HO EL5LP=Emergency Installed ² GL=Single Element Fuse GM=Double Element Fuse

Ballast Type³

T5 Ballasts

EBT_=T5 or T5HO Electronic Program Rapid Start. Total Harmonic Distortion < 10%.
Standard Ballast Factor=1.0

Ballast Factor/Type (For 28WT5 and 14WT5 Lamps Only)

H=High Light Output 1.15 BF⁴

HDIM=High 1.15 BF Step Dimming⁵

N=Normal Light Output .95 BF

NDIM=Normal .95-1.0 BF Step Dimming⁶

T8 Ballasts

EB8_=T8 Electronic Instant Start. Total Harmonic Distortion < 10%.

EB8_/PLUS=T8 Electronic Start. Total Harmonic Distortion < 10%. High Ballast Factor > 1.15

ER8_=T8 Electronic Program Rapid Start. Total Harmonic Distortion < 10%.

High Performance T8 Ballasts

HB8_=T8 Electronic Instant Start. Total Harmonic Distortion < 10%.
Standard Ballast Factor .86 - .88

HB8_H=T8 Electronic Instant Start. Total Harmonic Distortion < 10%.
High Ballast Factor 1.15 - 1.20

HB8_L=T8 Electronic Instant Start. Total Harmonic Distortion < 10%. Low Ballast Factor .77 - .82

HB8_N=T8 Electronic Instant Start. Total Harmonic Distortion < 10%. Normal Ballast Factor 1.0

HR8_=T8 Electronic Program Rapid Start. Total Harmonic Distortion < 10%.

Standard Ballast Factor .86 - .88

HR8_DIM=T8 Electronic Program Rapid Start. Total Harmonic Distortion < 10%.
Step Dimming. Ballast Factor .88

HR8_H=T8 Electronic Program Rapid Start. Total Harmonic Distortion < 10%.
High Ballast Factor 1.15 - 1.20

HR8_L=T8 Electronic Program Rapid Start. Total Harmonic Distortion < 10%.
Low Ballast Factor .71 - .79

T12 Ballasts

EB2_=T12 Electronic Rapid Start. Total Harmonic Distortion < 20% (30 Watt Only)

LE3=T12 Magnetic Energy Saving

Number of Ballasts	Options	Packaging	Accessories (Order Separately)
1=1 Ballast 2=2 Ballasts	6-3/18 SJT-C&P 515P=Locking Cord and Plug (120V) (15 AMP) ⁷ 6-3/18 SJT-C&P-L715P=Locking Cord and Plug (277V) (15 AMP) ⁷ PI/CPI=Plug-In Option ⁷ RIF1=Radio Interference Suppressor	4B=4 Bulk Packing (48" and 96") U=Unit Pack	A1B/Spacer-U=Spacer 1-1/2" to 2-1/2" from ceiling (Use 2 Per Fixture) AYC-Chain/Set=36" Chain Hanger (Use 1 Set Per Fixture) EYE-CHAIN/SET-B=Eye Bolt Chain (Use 1 Set Per Fixture) SCA=Adjustable 48" Stem Set SCF=Fixed Stem Set (Specify Length) SCS=Swivel Stem Set (Specify Length) SNF-ASY-3=3" Asymmetric Reflector (Specify 18", 2', or 3') ⁸ SNF-ASY-4=3" Asymmetric Reflector (Specify 2', 3', or 4') ⁸ SNF-ASY-4T5=3" Asymmetric Reflector (Specify 2' or 4') ⁸ SNF-REV-3=Reverse Asymmetric Reflector (Specify 18", 2', or 3') ⁸ SNF-REV-4=Reverse Asymmetric Reflector (Specify 2', 3', or 4') ⁸ SNF-REV-4T5=Reverse Asymmetric Reflector (Specify 2' or 4') ⁸ SNF-SYM-3=6" Symmetric Reflector (Specify 18", 2', or 3') ⁸ SNF-SYM-4=6" Symmetric Reflector (Specify 2', 3', or 4') ⁸ SNF-SYM-4T5=6" Symmetric Reflector (Specify 2' or 4') ⁸ TOGGLE=Single Toggle Number 2 (Specify Length) WG/SNF-2FT=2' Wire Guard WG/SNF-3FT=3' Wire Guard WG/SNF-4FT=4' Wire Guard WG/SNFT5-4FT=4' Wire Guard Y-TOGGLE=Y Toggle Number 2 (Specify Length)

NOTES: 1. Products also available in non-US voltage and frequencies for international markets. 2. Not available for 2' units. 3. Maximum width clearance for ballast in channel is 2-7/32". 4. 1-Lamp ballast in a High Ballast factor not available. 5. Step Dimming ballast available for 28W T5 and 14WT5 lamps only. 6. 1 Lamp step dimming ballast in normal ballast factor not available. 2-lamp ballast will not operate 1 lamp. 7. Socket brackets left uninstalled. 8. For SilverLining reflector add SS in Catalog Number, Example: SNF-ASY-SS-4.

WIDE VERSION STRIPLIGHT



FEATURES

- Flip-up socket feature for faster installation out of the box
- Die-formed cold-rolled steel channel construction with numerous KOs
- Pressure lock lampholders (RS), spring loaded lampholders (SL)
- Easy wireway access/wireway cover removed without tools
- Pre-painted material standard; PAF optional
- Tandem 8' lengths
- Optional reflectors in silver-lined reflector finish
- Storage or utility area, cove or display case application
- Lamp not included

DIMENSIONS

2', 3', 4', 8'

SSF SERIES

Compliances may not apply to all product configurations. Please consult the product spec sheet for compliance details.

COMPLIANCES: UL/cUL Listed - Damp Location

T5/T5HO LAMPS

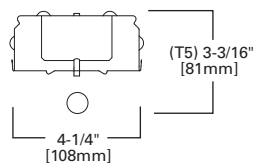
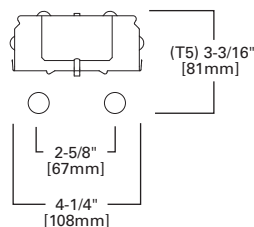
2', 4'
T5 or T5HO 1 lamp2', 4'
T5 or T5HO 2 lamp

T8/SLIMLINE LAMPS

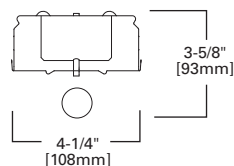
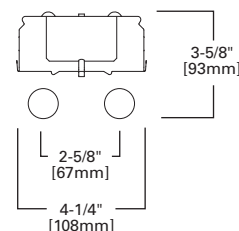
2', 3', 4'
T8 or Slimline 1 lamp2', 3', 4'
T8 or Slimline 2 lamp

T12 LAMPS

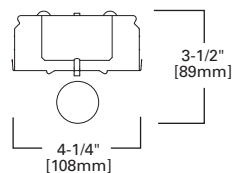
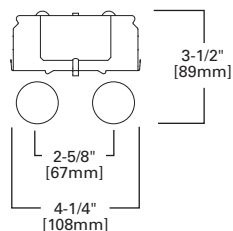
2', 3'
T12 1 lamp2', 3'
T12 2 lamp

SLIMLINE/T12HO LAMPS

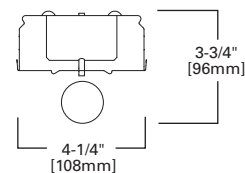
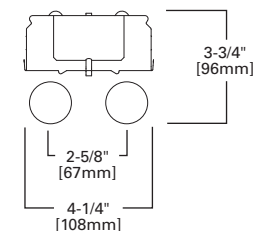
4', 8'
Slimline or T12HO 1 lamp4', 8'
Slimline or T12HO 2 lamp

ORDERING INFORMATION

SAMPLE NUMBER: SSF-232-UNV-EB81-U

Tandem	Series ¹	Number of Lamps (Not Included) ²	Wattage		Ballast Start Type
8T=8' Lengths [Blank]=2', 3' or 4' Length	SSF=Wide Version Striplight	1=1 Lamp 2=2 Lamps 3=3 Lamps ³ 4=4 Lamps	14T5=14W T5 (24") 17=17W T8 (24") 20=20W T12 (24") 21T5=21W T5 (36") 24T5=24W T5HO (24") ⁴ 25=25W T8 (36") 28T5=28W T5 (48") 28T8=28W T8 (48") ⁵ 30=30W T12 (36")	32=32W T8 (48") 40=40W T12 (48") 48HO=60W T12HO (48") 48T8HO=44W T8HO (48") 54T5=54W T5HO (48") ⁴ 96=75W T12 SL (96") 96HO=110W T12HO (96") 96T8=59W T8SL (96") 96T8HO=86W T8HO (96")	HRS=High Rapid Start (30W Only) (120V Only) HTS=High Trigger Start (20W Only) LRS=Low Rapid Start (30W Only) (120V Only) LTS=Low Trigger Start (20W Only) (120V Only)
Voltage ⁶		Options ⁶	Ballast Type		
120V=120 Volt 277V=277 Volt 347V=347 Volt UNV=Universal Voltage 120-277 ⁷		EL=Emergency Battery Installed (Must Specify Battery Pack, See Options) ^{8,9} EL4=Emergency Installed ^{9,10} EL5=Emergency Installed EL5HO=Emergency Installed for T5HO EL8=Emergency Installed ¹¹ GL=Single Element Fuse GM=Double Element Fuse	T5 Ballasts EBT_=T5 or T5HO Electronic Program Rapid Start. Total Harmonic Distortion < 10%. Standard Ballast Factor=1.0 Ballast/Factor Type (T5) EBT_H=T5 Electronic Program Rapid Start. Total Harmonic Distortion < 10%. High Ballast Factor=1.15 ¹² EBT_HDIM=T5 Electronic Program Rapid Start. Total Harmonic Distortion < 10%. Step Dimming, High Ballast Factor=1.15 ¹³ EBT_N=T5 Electronic Program Rapid Start. Total Harmonic Distortion < 10%. Normal Ballast Factor=.90 ¹⁴ EBT_NDIM=T5 Electronic Program Rapid Start. Total Harmonic Distortion < 10%. Step Dimming, Normal Ballast Factor=.95-1.0 ¹⁵ T8 Ballasts EB8_=T8 Electronic Start. Total Harmonic Distortion < 10%. EB8_/PLUS=T8 Electronic Start. Total Harmonic Distortion < 10%. High Ballast Factor > 1.15 ER8_=T8 Electronic Program Rapid Start. Total Harmonic Distortion < 10%. High Performance T8 Ballasts HB8_=T8 Electronic Instant Start. Total Harmonic Distortion < 10%. Standard Ballast Factor .86-.88 HB8_H=T8 Electronic Instant Start. Total Harmonic Distortion < 10%. High Ballast Factor 1.15-1.20 HB8_L=T8 Electronic Instant Start. Total Harmonic Distortion < 10%. Low Ballast Factor .77-.82 HB8_N=T8 Electronic Instant Start. Total Harmonic Distortion < 10%. Normal Ballast Factor 1.0 HR8_=T8 Electronic Program Rapid Start. Total Harmonic Distortion < 10%. Standard Ballast Factor .86-.88 HR8_DIM=T8 Electronic Program Rapid Start. Total Harmonic Distortion < 10%. Step Dimming. Ballast Factor .88 HR8_H=T8 Electronic Program Rapid Start. Total Harmonic Distortion < 10%. High Ballast Factor 1.15-1.20 HR8_L=T8 Electronic Program Rapid Start. Total Harmonic Distortion < 10%. Low Ballast Factor .71-.79 T12 Ballasts EB2_=T12 Electronic Rapid Start. Total Harmonic Distortion < 20% LE3=T12 Magnetic Energy Saving		
Number of Ballasts	Options	Packaging	Accessories (Order Separately)		
1=1 Ballast 2=2 Ballasts	6-3/18 SJT-C&P 515P=Locking Cord and Plug (120V) (15 AMP) ¹⁵ 6-3/18 SJT-C&P-L715P=Locking Cord and Plug (277V) (15 AMP) ¹⁶ PI/CPI=Plug-In Option ¹⁶ RIF1=Radio Interference Suppressor TILW=Tandem Inline Wiring	4B=4 Bulk Packing (48" and 96") U=Unit Pack	A1B/Spacer-U=Spacer 1-1/2" to 2-1/2" from ceiling (Use 2 Per Fixture) AYC-Chain/Set=36" Chain Hanger (Use 1 Set Per Fixture) CLC-SSF=Long Channel Connector SSF GRP-SSF=Gripper Hanger (Use 2 Per Fixture) ICF-4FT-REFL=12" Symmetric Reflector SCA=Adjustable 48" Stem Set SCF=Fixed Stem Set (Specify Length) SCS=Swivel Stem Set (Specify Length) SSF-ASY-3=3" Asymmetric Reflector (Specify 2' or 3') ¹⁷ SSF-ASY-4=3" Asymmetric Reflector (Specify 2', 3', or 4') ¹⁷ SSF-ASY-4T5=3" Asymmetric Reflector (Specify 2' or 4') ¹⁷ SSF-REV-3=3" Asymmetric Reverse Reflector (Specify 2' or 3') ¹⁷ SSF-REV-4=3" Asymmetric Reverse Reflector (Specify 2', 3', or 4') ¹⁷ SSF-REV-4T5=3" Asymmetric Reverse Reflector (Specify 2' or 4') ¹⁷ SSF-SYM-3=6" Symmetric Reflector Specify (2' or 3') ¹⁷ SSF-SYM-4=6" Symmetric Reflector Specify (2', 3' or 4') ¹⁷ SSF-SYM-4HO=6" Symmetric Reflector (2-Lamp Only), Specify (4' or 8') ¹⁷ SSF-SYM-4T5=6" Symmetric Reflector Specify (2' or 4') ¹⁷ SSF-SYM12-4HO=12" Symmetric Reflector (2-Lamp Only), Specify (4' or 8') ¹⁷ TOGGLE=Single Toggle Number 2 (Specify Length) WG/SSF-2FT=2' Wire Guard WG/SSF-3FT=3' Wire Guard WG/SSF-4FT=4' Wire Guard Y-TOGGLE=Y Toggle Number 2 (Specify Length)		

NOTES: 1. Steel endplates with 7/8" KO standard for continuous row mounting. 2. 2 point suspension recommended (up to 4'). 3. Available in 28T8 and 32 watt. Requires two ballasts for tandem option. 4. Not for temperatures that exceed 40°C (102°F). 5. HPT8 Ballast required with 28W T8 lamps. 6. Products also available in non-US voltage and frequencies for international markets. 7. Not available when specifying emergencies, voltage must be specified. 8. Not available for 2' units. 9. For other emergency options specify manufacturer part number and consult the factory for availability (example: EL-180). 10. Not available for 2' units. 11. For other emergency options specify manufacturer part number and consult the factory for availability (example: EL-180). 12. 1-Lamp ballast in a High Ballast factor not available. 13. Step Dimming ballast available for 28W T5 and 14WT5 lamps only. 14. .90 ballast factor available for 2.28W T5 lamps only. 15. 1-Lamp step dimming ballast in a Normal Ballast factor not available. 2-Lamp ballast will not operate 1-Lamp. 16. Socket brackets left uninstalled. 17. For SilverLining reflector add SS in Catalog Number, Example: SSF-ASY-SS-4.

HEAVY DUTY STRIPLIGHT



FEATURES

- Die-formed channel with white enamel finish
- Spring-loaded or rotor lampholders available
- Easy wireway access/wireway cover removed without tools
- Numerous knockouts for easy installation
- Also available in tandem 8' lengths

DIMENSIONS

4', 8'

Compliances may not apply to all product configurations. Please consult the product spec sheet for compliance details.

COMPLIANCES: UL/cUL Listed - Damp Location

SMF SERIES



ORDERING INFORMATION

SAMPLE NUMBER: SMF-232-120V-EB81-U

Tandem	Series ¹	Number of Lamps (Not Included)	Wattage (Length)	Voltage ²	Options
8T=8' Length [Blank]=4' Length	SMF=Commercial Heavy Duty Striplight	2=2 Lamps 3=3 Lamps 4=4 Lamps	32=32W T8 (48") 48T8HO=44W T8HO (48") 96=59W T8SL (96") 96HO=86W T8HO (96")	120V=120 Volt 277V=277 Volt 347V=347 Volt UNV=Universal Voltage 120-277	EL=Emergency Installed (Must Specify Battery Pack, See Options) GL=Single Element Fuse GM=Double Element Fuse
Ballast Type		Number of Ballasts	Options		Packaging
T8 Ballasts EB8=T8 Electronic Start. Total Harmonic Distortion < 10%. EB8_/PLUS=T8 Electronic Start. Total Harmonic Distortion < 10%. High Ballast Factor > 1.15 ER8=T8 Electronic Program Rapid Start. Total Harmonic Distortion < 10%.		1=1 Ballast 2=2 Ballasts 3=3 Ballasts	PI/CPI=Plug-In Option RIF1=Radio Interference Suppressor RLS=Rotor-Lock Socket (T8 Lamps Only) TILW=Tandem In-Line Wiring Option (Consult TILW Option Catalog Page).		U=Unit Pack

NOTES: 1. For SilverLining reflector add SS in Catalog Number, Example: STM-SS-SYM-6. 2. Products also available in non-US voltage and frequencies for international markets.

4', 6' or 8', 2 LAMP

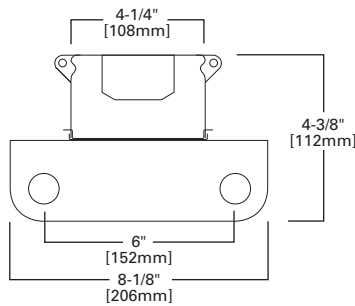

4', 6' or 8', 3 LAMP

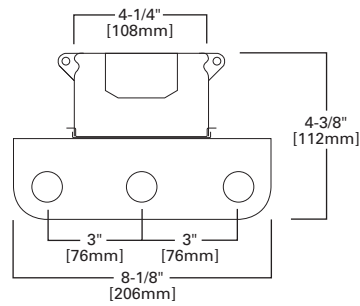

4', 6' or 8', 4 LAMP

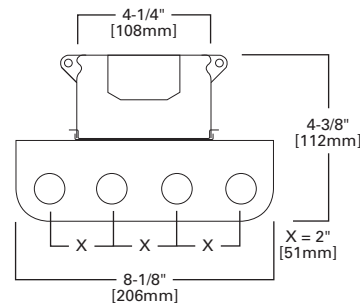

FEATURES

- For shadow-free continuous illumination in cove lighting applications
- Die-formed channel with baked white enamel finish
- Numerous knockouts for easy installation
- Easy wireway access/wireway cover removed without tools
- Surface- or pendant-mounted, individually or in rows

DIMENSIONS

2', 3', 4', 8'

Compliances may not apply to all product configurations. Please consult the product spec sheet for compliance details.

COMPLIANCES: UL/cUL Listed - Damp Location



SNL, SSL SERIES

ORDERING INFORMATION⁴

SAMPLE NUMBER: SSL-232-120V-EB81-U

Tandem	Series	Number of Lamps	Wattage	Voltage ²	Options ⁴
8T=8' Lengths [Blank]=2', 3' or 4' Lengths	SNL=Narrow Staggered Striplight SSL=Wide Staggered Striplight	1=1 Lamp 2=2 Lamps	17=17W T8 (24") 25=25W T8 (36") 32=32W T8 (48") 96T8=59W T8SL (96") ¹ 96T8HO=86W T8HO (96") ¹	120V=120 Volt 277V=277 Volt 347V=347 Volt UNV=Universal Voltage 120-277 ³	EL=Emergency Installed (Must Specify Battery Pack, See Options) GL=Single Element Fuse GM=Double Element Fuse
Ballast Type		Number of Ballasts	Options	Options	Packaging
T8 Ballasts EB8 =T8 Electronic Start. Total Harmonic Distortion < 10%. EB8_/PLUS=T8 Electronic Start. Total Harmonic Distortion < 10%. High Ballast Factor > 1.15 ER8 =T8 Electronic Program Rapid Start. Total Harmonic Distortion < 10%.		1=1 Ballast 2=2 Ballasts 3=3 Ballasts	(See Options and Accessories) PI/CPI=Plug-In (1, 2 or 3) TILW=Tandem Inline Wiring		U=Unit Pack

NOTES: Δ For complete product data, reference the Fluorescent Specification binder. Specifications and dimensions subject to change without notice. Consult your Cooper Lighting Representative for availability and ordering information. 1. 96" High Output available in T8 only. 2. Products also available in non-US voltage and frequencies for international markets. 3. Not available when specifying emergencies, voltage must be specified. 4. Sufficient starter kits are provided with each fixture for multiple fixture rows. If rows consist of only one fixture, an additional row starter kit must also be ordered.

ORDERING INFORMATION⁴

SAMPLE NUMBER: SNL-2 (Additional Starter Kits)

Series	Number of Lamps	Type
SNL=Narrow Staggered Striplight SSL=Staggered Striplight	1=1 Lamp 2=2 Lamps	[Blank]=Bipin Rapid Start Lamp SL=Slimline or HO Lamp

NOTES: Δ Sufficient starter kits are provided with each fixture for multiple fixture rows. If rows consist of only one fixture, an additional row starter kit must also be ordered.

SNL 2', 3' or 4'

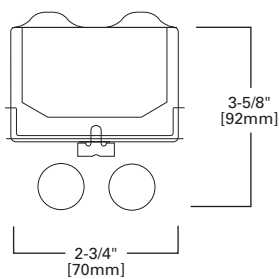

SSL 2', 3', 4' or 8'

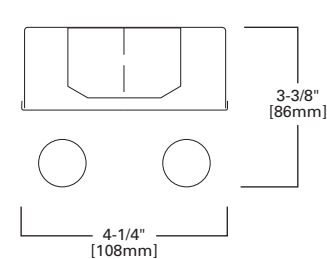

LAMP ORIENTATION

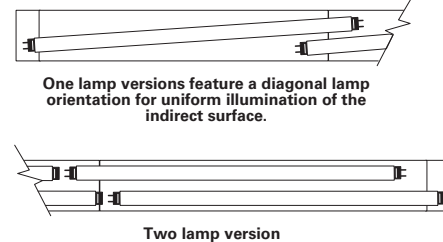

SIDE MOUNTED, RIGHT ANGLE, STAGGERED STRIPLIGHT



FEATURES

- Die-formed channel with numerous knockouts for easy installation
- Pressure lock lampholders ensure lamps are secure
- Easy wireway access/wireway cover removed without tools
- Lamps not included
- For shadow-free continuous illumination in cove lighting applications
- Ideal for cove, specialty showcase, signage and display lighting

DIMENSIONS

2', 3', 4', 8'

Compliances may not apply to all product configurations. Please consult the product spec sheet for compliance details.

COMPLIANCES: UL/cUL Listed - Damp LocationSNSM, SNRA,
SMSL SERIES

ORDERING INFORMATION

SAMPLE NUMBER: SMSL-232-UNV-EB81-U

Tandem	Series	Number of Lamps (Not Included) ¹	Wattage	Ballast Start Type	Voltage ²
8T=8' Length [Blank]=2', 3' or 4' Lengths	SMSL=Side Mounted Staggered Striplight SNRA=Right Angle Striplight SNSM=Side Mounted Striplight	1=1 Lamps 2=2 Lamps 3=3 Lamps (SNRA Only)	17=17W T8 (24") 20=20W T12 (24") ² 25=25W T8 (36") 30=30W T12 (36") ² 32=32W T8 (48") 40=40W T12 (48")	HRS=High Rapid Start (3' or 4') (T12 Only) HTS=High Trigger Start (20W Only) LRS=Low Rapid Start (3' or 4') (T12 Only) (120V Only) LTS=Low Trigger Start (20W Only) (120V Only)	120V=120 Volt 277V=277 Volt 347V=347 Volt UNV=Universal Voltage 120-277 ³
Options	Ballast Type	Number of Ballasts		Options	
EL=Emergency Installed (Must Specify Battery Pack, See Options) GL=Single Element Fuse GM=Double Element Fuse	[Blank]=Standard Magnetic Ballast T8 Ballasts EB8=T8 Electronic Start. Total Harmonic Distortion < 10%. EB8_/PLUS=T8 Electronic Start. Total Harmonic Distortion < 10%. High Ballast Factor > 1.15 ER8=T8 Electronic Program Rapid Start. Total Harmonic Distortion < 10%. T12 Ballasts EB2=T12 Electronic Rapid Start	1=1 Ballast 2=2 Ballasts		FR=Fire Rated Label PAF=Painted After Fabrication RIF1=Radio Interference Suppressor RLS=Rotor Lock Socket (T8 Lamps Only)	
Packaging	Accessories (Order Separately)				
U=Unit Pack	EQ-CLIP-U=T-BAR Safety Earthquake Clips				

NOTES: 1. Lamps not included. 2. Products also available in non-US voltage and frequencies for international markets. 3. Not available when specifying emergencies, voltage must be specified.

SMSL 2', 3' or 4'

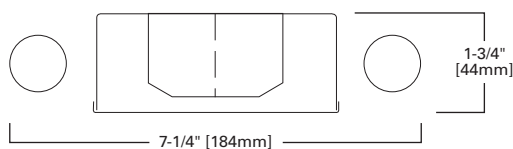

SNRA 2', 3' or 4'

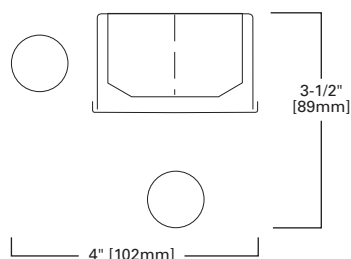

SNSM 2', 3' or 4'

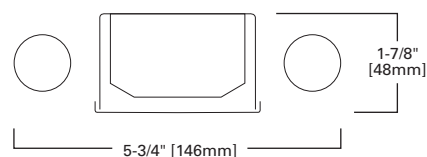

FEATURES

- Equipped with energy-saving ballasts
- Low-profile modular look
- Die-formed housing
- Surface- or stem-mount in single or continuous row
- End and side panels secured with interlocking tabs
- Full-seam welded corners
- Dihedral recessed-top design for cooler operation
- Reinforced quadra-sealed, flat-white, steel door and mitered corners
- Spring-loaded cam latch and T-hinge

DIMENSIONS

1' x 4', 2' x 2', 2' x 4'

Compliances may not apply to all product configurations. Please consult the product spec sheet for compliance details.

COMPLIANCES: UL/cUL Listed - Damp Location



M SERIES



ORDERING INFORMATION⁴

SAMPLE NUMBER: 2M-314T5A-UNV-EBT2-U

Width	Series ^{1,2}	Door Frame	Number of Lamps (Not Included) ³	Wattage
2=2' Width [Blank]=1' Width	M=1' Width (3 Lamp), 2' Width MC=1' Width (2 Lamp)	[Blank]=Flat White Steel Door (Standard) FA=Flush White Extruded Aluminum c/w Spring Latch FAB=Flush Black Extruded Aluminum FAN=Flush Natural Anodized Extruded Aluminum RA=Regressed White Extruded Aluminum (3/8") RAB=Regressed Black Extruded Aluminum (3/8") RAN=Regressed Natural Anodized Extruded Aluminum (3/8")	1=1 Lamp ⁴ 2=2 Lamps 3=3 Lamps 4=4 Lamps	14T5=14W T5 (24") 17=17W T8 (24") 24T5=24W T5O (24") 28T5=28W T5 (48") 32=32W T8 (48") 54T5=54W T5HO (48") BX40=40W Biax (24") ⁵ U15/8=31W T8 (24") ⁵ U6T8=31W T8 (24") ^{5, 6}
Lens		Voltage ⁷	Options	
A=#12 Acrylic Pattern A125=#12 Pattern Acrylic (.125" Thickness) A19/156=#19 Pattern Acrylic (.156" Thickness) PB1S=Silver Parabolic Louver (1/2" x 1/2" x 1/2")		120V=120 Volt 277V=277 Volt 347V=347 Volt UNV=Universal Voltage 120-277 ⁸	EL=Emergency Installed (Must Specify Battery Pack, See Options) GL=Single Element Fuse GM=Double Element Fuse	
Ballast Type				
Biax Ballasts EB5=T5 Biax Electronic Instant Start. Total Harmonic Distortion < 20%. ⁹ TEB5=T5 Biax Electronic Instant Start. Total Harmonic Distortion < 10%. ⁹		T8 Ballasts EB8=T8 Electronic Start. Total Harmonic Distortion < 10%. EB8_/PLUS=T8 Electronic Instant Start. Total Harmonic Distortion < 10%. High Ballast Factor > 1.15 ER8=T8 Electronic Program Rapid Start. Total Harmonic Distortion < 10%.		
T5 Ballasts EBT=T5 or T5HO Electronic Program Rapid Start. Total Harmonic Distortion < 10%. Standard Ballast Factor=1.0				
Ballast/Factor Type (T5) EBT_H=T5 Electronic Program Rapid Start. Total Harmonic Distortion < 10%. High Ballast Factor=1.15 ¹⁰ EBT_HDIM=T5 Electronic Program Rapid Start. Total Harmonic Distortion < 10%. Step Dimming, High Ballast Factor=1.15 ¹¹ EBT_N=T5 Electronic Program Rapid Start. Total Harmonic Distortion < 10%. Normal Ballast Factor=.90 ¹² EBT_NDIM=T5 Electronic Program Rapid Start. Total Harmonic Distortion < 10%. Step Dimming, Normal Ballast Factor=.95-1.0 ¹³				
Number of Ballasts ¹⁴	Options	Packaging	Accessories (Order Separately)	
1=1 Ballast 2=2 Ballasts	BE=Black Exterior EKO=End plate with 7/8" KO (Required for Continuous Row Mounting) RIF1=Radio Interference Suppressor RLS=Rotor Lock Socket (T8 Lamps Only) SMB=Side Mount Ballast VRS=Vandal Resistant Screws ¹⁵	U=Unit Pack	SCA=Adjustable 48" Stem Set SCF=Fixed Stem Set (Specify Length) SCS=Swivel Stem Set (Specify Length)	

NOTES: 1. Full seam welded corners on 1'x4', 2'x2', 2'x4' fixtures. 2. 2'x2', 2'x4' require 4-point suspension, side mounted ballast recommended. 3. 1'x4' 3-lamp, 2'x4' 3 and 4-lamp have side mounted ballasts covers. 4. 1'x4' only. 5. 2' x 2' only. 6. 2 lamps only. 7. Products also available in non-US voltage and frequencies for international markets. 8. Not available when specifying emergencies, voltage must be specified. 9. Not available in UNV voltage. Must specify voltage. 10. 1 lamp ballast in high ballast factor not available. 11. Step Dimming ballast available for 2 or 3 T5 lamps only. 12. .90 ballast factor available for 2 or 3 T5 lamps. 13. 1-lamp step dimming ballast in normal ballast factor not available. 2-lamp ballast will not operate 1-lamp. 14. For 3 and 4 lamp T5/T5HO configurations, minimum (2) ballasts required. 15. Available on flat doors only.

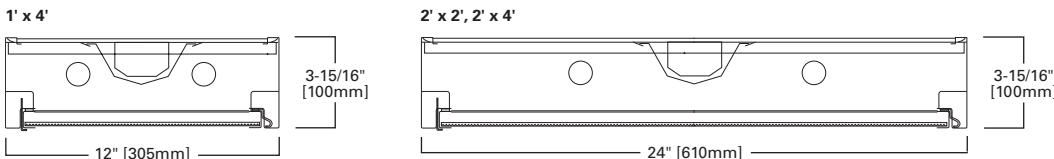

SURFACE MODULAR WRAP



FEATURES

- Provided with CEE-listed, energy-saving ballasts
- Seam-welded corners for a clean, finished exterior
- Architectural low-profile design with full luminous refractor sides
- Micro-base prisms for excellent lamp image control
- Square, conical prisms in IMA lens for precision light control
- Unique refractor design conceals lamp image and controls brightness
- Sonically welded, injection-molded refractor end caps
- Secure, positive lens attachment with hinge feature
- Smooth sides permit flush-mount continuous row installation

DIMENSIONS

4', 8'

SA SERIES

Compliances may not apply to all product configurations. Please consult the product spec sheet for compliance details.

COMPLIANCES: UL/cUL Listed, UL/cUL Listed - Damp Location, CSA Listed



ORDERING INFORMATION

SAMPLE NUMBER: SA-432IMA-UNV-EB81-U

Tandem	Series	Width	Number of Lamps (Not Included)	Wattage	Lens	Voltage ⁵
8T=8' Length (Uses 4' Door Frame Sections) ¹ [Blank]=4' Length	SA=Series	[Blank]=Standard A=Wide Body for 2 Lamps ^{2,3}	2=2 Lamps 3=3 Lamps ⁴ 4=4 Lamps	28T8=28W T8 (48") 32=32W T8 (48")	A=Acrylic Refractor Lens IMA=Injection Molded Acrylic Lens	120V=120 Volt 277V=277 Volt 347V=347 Volt UNV=Universal Voltage 120-277 ⁶
Options	Ballast Type	Number of Ballasts		Options	Packaging	
EL=Emergency Installed (Must Specify Battery Pack, See Options) GL=Single Element Fuse GM=Double Element Fuse	T8 Ballasts EB8 =T8 Electronic Start. Total Harmonic Distortion < 10%. EB8_/PLUS=T8 Electronic Start. Total Harmonic Distortion < 10%. High Ballast Factor > 1.15. ER8 =T8 Electronic Program Rapid Start. Total Harmonic Distortion < 10%.	1=1 Ballast 2=2 Ballasts 3=3 Ballasts		EKO=End Plate with 7/8" KO (Required for Continuous Row Mounting) PI/CPI=Plug-In Option	U=Unit Pack	

NOTES: 1. 8T available in 2-lamp only. 2. Wide body available in 4' units only. 3. Must specify lamp spacing by adding IB or OB as a suffix: IB (Inboard)=5 1/2" lamp spacing; OB (Outboard)=11" lamp spacing. 4. Stem Mounting not available on 3-lamp fixtures. 5. Products also available in non-US voltage and frequencies for international markets. 6. Not available when specifying emergencies, voltage must be specified.

4', 2 LAMP (IMA)

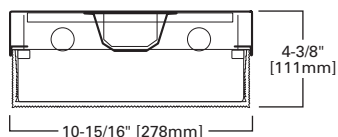

4', 3 LAMP (IMA)

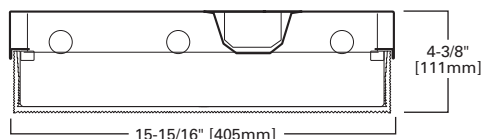

4', 4 LAMP (IMA)

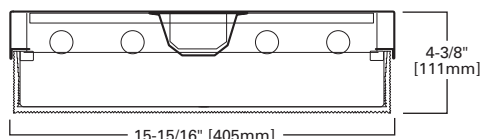

4', 2 LAMP (A)

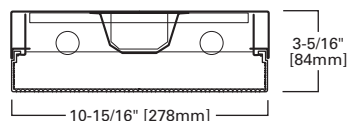

4', 3 LAMP (A)

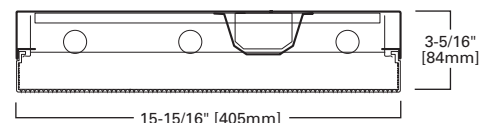

4', 4 LAMP (A)

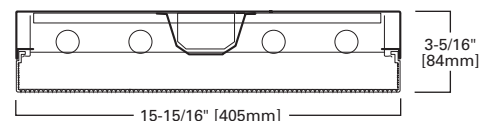
Specifications and dimensions subject to change without notice. Consult your Cooper Lighting Representative or visit www.cooperlighting.com for available options, accessories and ordering information.

FEATURES

- Equipped with energy-saving ballasts
- Reinforced quadra-sealed, flat-white, steel door and mitered corners
- Self-locking spring loaded latches/T-hinges
- Deep "V" raceway/ballast cover distributes light uniformly across lens
- Lamp-to-lens spacing produces high-comfort photometrics
- Four auxiliary fixture-end suspension points provided
- End plate grid-lock feature

DIMENSIONS

1' x 4', 2' x 2', 2' x 4', 20" x 48"

Compliances may not apply to all product configurations. Please consult the product spec sheet for compliance details.

COMPLIANCES: UL/cUL Listed - Damp Location, NOM Certified, City of Chicago Approved



GC SERIES

ORDERING INFORMATION

SAMPLE NUMBER: 2GC-228T5A-UNV-EBT1-U

Rating	Width	Trim Type	Series	Doorframes	Width ⁹
[Blank]=Standard ATW-SW4=Chicago Rated	2=2' Width [Blank]=1' Width	F=Aluminum Flange Trim ¹⁷ G=Concealed-T/Slot Grid ¹⁸ G=Grid/Lay-in (Standard)	C=Specification Deep Troffer	[Blank]=Flat White Steel Door (Standard) FA=Flush White Extruded Aluminum c/w Spring Latch FAB=Flush Black Extruded Aluminum FAN=Flush Natural Anodized Extruded Aluminum RA=Regressed White Extruded Aluminum (3/8") RAB=Regressed Black Extruded Aluminum (3/8") RAN=Regressed Natural Anodized Extruded Aluminum (3/8")	2024=20" Width x 24" Length 2048=20" Width x 48" Length
White Optics	Number of Lamps (Not Included)	Wattage (Length)		Shielding	Voltage ⁷
WO=97% Reflective White Optics Finish	1=1 Lamp 2=2 Lamps 3=3 Lamps ⁴ 4=4 Lamps	14T5=14W T5 (24") 17=17W T8 (24") 24T5=24W T5HO (24") 28T5=28W T5 (48") 28T8=28W T8 (48")	32=32W T8 (48") 54T5=54W T5HO (48") BX40=40W Biax (24") U15/8=31W T8 (24") ⁵ U6T8=32W T8 (24") ⁶	A=#12 Pattern Acrylic A125=#12 Pattern Acrylic (.125" Thickness) A19/156=#19 Pattern Acrylic (.156" Thickness) DA=Dropped Dish Matte White Acrylic IMA48=Injection Molded Acrylic (.150" Thickness) PB1S=1/2"x1/2"x1/2" Silver Parabolic Louver (Styrene)	120V=120 Volt 277V=277 Volt 347V=347 Volt UNV=Universal Voltage 120-277 ⁸
Options		Ballast Type			
EL=Emergency Battery Installed (Must Specify Battery Pack, See Options) ⁹ Flex=Flex Installed (Reference Flex Ordering Information) GL=Single Element Fuse GM=Double Element Fuse Lamps=Lamps Installed (Refer to Lamp Ordering Options)		Biax Ballasts EB5_=T5 Biax Electronic Instant Start. Total Harmonic Distortion < 20%. TEB5_=T5 Biax Electronic Instant Start. Total Harmonic Distortion < 10%. T5 Ballasts EBT_=T5 or T5HO Electronic Program Rapid Start. Total Harmonic Distortion < 10%. Standard Ballast Factor=1.0 ¹¹ Ballast/ Factor Type (T5) EBT_H=T5 Electronic Program Rapid Start. Total Harmonic Distortion < 10%. High Ballast Factor=1.15 ¹² EBT_HDIM=T5 Electronic Program Rapid Start. Total Harmonic Distortion < 10%. Step Dimming, High Ballast Factor=1.15 ¹³ EBT_N=T5 Electronic Program Rapid Start. Total Harmonic Distortion < 10%. Normal Ballast Factor=.90 ¹¹ EBT_NDIM=T5 Electronic Program Rapid Start. Total Harmonic Distortion < 10%. Step Dimming, Normal Ballast Factor=.95-1.0 ¹⁴ T8 Ballasts EB8_=T8 Electronic Start. Total Harmonic Distortion < 10%. EB8_/PLUS=T8 Electronic Start. Total Harmonic Distortion < 10%. High Ballast Factor > 1.15 ER8_=T8 Electronic Program Rapid Start. Total Harmonic Distortion < 10%. High Performance T8 Ballasts HB8_=T8 Electronic Instant Start. Total Harmonic Distortion < 10%. Standard Ballast Factor .86 - .88 HB8_H=T8 Electronic Instant Start. Total Harmonic Distortion < 10%. High Ballast Factor 1.15 - 1.20 HB8_L=T8 Electronic Instant Start. Total Harmonic Distortion < 10%. Low Ballast Factor .77 - .82 HB8_N=T8 Electronic Instant Start. Total Harmonic Distortion < 10%. Normal Ballast Factor 1.0 HR8_=T8 Electronic Program Rapid Start. Total Harmonic Distortion < 10%. Standard Ballast Factor .86 - .88 HR8_DIM=T8 Electronic Program Rapid Start. Total Harmonic Distortion < 10%. Step Dimming, Ballast Factor .88 HR8_H=T8 Electronic Program Rapid Start. Total Harmonic Distortion < 10%. High Ballast Factor 1.15 - 1.20 HR8_L=T8 Electronic Program Rapid Start. Total Harmonic Distortion < 10%. Low Ballast Factor .71 - .79			
Number of Ballasts	Options ¹⁵	Packaging	Accessories (Order Separately)		
1=1 Ballast 2=2 Ballasts	LAO=Less Access Opening PAF=Painted After Fabrication RLS=Rotor-Lock Socket (T8 Lamps Only - Standard on T5)	PAL=Job Pack, out of carton PALC=Job Pack, in carton U=Unit Pack	EQ-CLIP-U=T-BAR Safety Earthquake Clips ¹⁶		

NOTES: 1. Specify row configuration, type in catalog number when ordering complete fixtures. 2. Louver is recessed by 5/16" in Concealed T or Slot Grid T. 3. White optics not available for 2024 and 2048. 4. Standard off-center ballast on 3-lamp fixtures. 5. 3 Lamps maximum for U1-5/8. 6. 2 Lamps maximum for U6T8. 7. Products also available in non-US voltage and frequencies for international markets. 8. Not available when specifying emergencies, voltage must be specified. 9. Fixtures equipped with "EL" option may require a 5-1/2" housing depth. If installing in field, must use low profile battery pack. 10. HPT8 Ballast required with 28W T8 lamps. 11. .90 ballast factor available for 2 or 3 14W T5 or 28W T5 lamps only. 12. 1-Lamp ballast in high ballast factor is not available. 13. Step Dimming ballast available for 2 or 3 14WT5 or 28W T5 lamps only. 14. 1-Lamp step dimming ballast in a Normal Ballast factor not available. 2-Lamp ballast will not operate 1-Lamp. 15. See Options or Accessories. 16. An EQ Grid Clip is recommended for all 9/16" ceiling systems. Four required per fixture. 17. Specify row configuration, type in catalog number when ordering complete fixtures. 18. Louver is recessed by 5/16" in Concealed T or Slot Grid T.

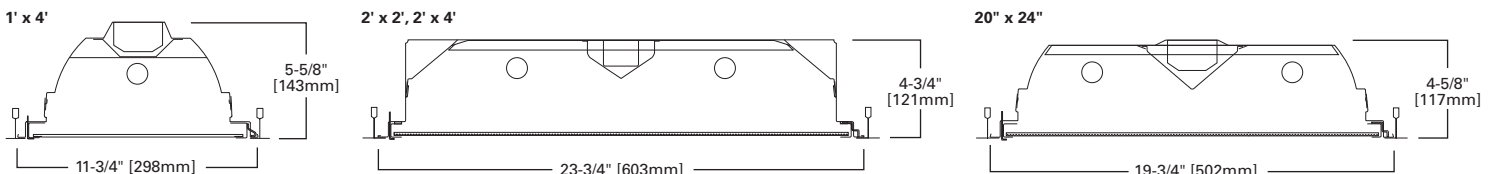

Specifications and dimensions subject to change without notice. Consult your Cooper Lighting Representative or visit www.cooperlighting.com for available options, accessories and ordering information.

COMMERCIAL GRADE T8 TROFFER



FEATURES

- Optimized for T8 lamps
- Equipped with energy-saving ballasts
- Superior lens brightness uniformity
- Reinforced flat steel door or regressed aluminum door available
- Positive spring-loaded steel latches and safety lock T-hinges
- 90% reflective white enamel finish for superior performance
- Micro ballast cover reduces ballast shadow and has tool-less access
- Features full-length, die-formed stiffeners and unibody endplate
- Ample knockouts provided for continuous row wiring

DIMENSIONS

1' x 4', 2' x 2', 2' x 4'

GC8 SERIES

Compliances may not apply to all product configurations. Please consult the product spec sheet for compliance details.

COMPLIANCES: UL/cUL Listed - Damp Location, NOM Certified, IC Rated, City of Chicago Approved

ORDERING INFORMATION

SAMPLE NUMBER: 2GC8-332A-UNV-EB81-U

Rating	Width	Trim Type	Series	Type	Doorframes	Number of Lamps (Not Included)
[Blank]=Standard ATW-SW4=Chicago Rated	2=2' Width [Blank]=1' Width	F=Aluminum Flange Trim ⁹ G=Concealed-T/Slot Grid ¹⁰ G=Grid/Lay-in (Standard)	C8=Commercial T8 Troffer	IC=IC Rated	[Blank]=Flat White Steel Door (Standard) FA=Flush White Extruded Aluminum c/w Spring Latch FAB=Flush Black Extruded Aluminum FAN=Flush Natural Anodized Extruded Aluminum RA=Regressed White Extruded Aluminum (3/8") RAB=Regressed Black Extruded Aluminum (3/8") RAN=Regressed Natural Anodized Extruded Aluminum (3/8")	2=2 Lamps 3=3 Lamps ² 4=4 Lamps ³
Wattage (Length)	Shielding	Option - Aluminum Flange Trim ¹		Voltage ⁴	Options	
17=17W T8 (24") 28T8=28W T8 (48") 32=32W T8 (48") BX40=40W Biax (24") U15/8=31W T8 (24") U6T8=32W T8 (24")	A=#12 Pattern Acrylic A125=#12 Pattern Acrylic (.125" Thickness) A19/156=#19 Pattern Acrylic (.156" Thickness) DA=Dropped Dish Matte White Acrylic IMA48=Injection Molded Acrylic (.150" Thickness) PB1S=1/2" x 1/2" x 1/2" Silver Parabolic Louver (Styrene)	[Blank]=SW (Single White) EN=End of Row Natural EW=End of Row White RN=In Row Natural RW=In Row White SN=Single Natural SW=Single White	120V=120 Volt 277V=277 Volt 347V=347 Volt UNV=Universal Voltage 120-277 ⁵	EL=Emergency Battery Installed (Must Specify Battery Pack, See Options) Flex=Flex Installed (Reference Flex Ordering Information) GL=Single Element Fuse GM=Double Element Fuse Lamps=Lamps Installed (Refer to Lamp Ordering Options)		
Ballast Type						
Biax Ballasts EB5 =T5 Biax Electronic Instant Start. Total Harmonic Distortion < 20%. ⁶ ER5 =T5 Biax Electronic Program Rapid Start. Total Harmonic Distortion < 10%. TEB5 =T5 Biax Electronic Instant Start. Total Harmonic Distortion < 10%. ⁶			High Performance T8 Ballasts HB8 =T8 Electronic Instant Start. Total Harmonic Distortion < 10%. Standard Ballast Factor .86 - .88 HB8_H=T8 Electronic Instant Start. Total Harmonic Distortion < 10%. High Ballast Factor 1.15 - 1.20 HB8_L=T8 Electronic Instant Start. Total Harmonic Distortion < 10%. Low Ballast Factor .77 - .82 HB8_N=T8 Electronic Instant Start. Total Harmonic Distortion < 10%. Normal Ballast Factor 1.0 HR8 =T8 Electronic Program Rapid Start. Total Harmonic Distortion < 10%. Standard Ballast Factor .86 - .88 HR8_DIM=T8 Electronic Program Rapid Start. Total Harmonic Distortion < 10%. Step Dimming, Ballast Factor .88 HR8_H=T8 Electronic Program Rapid Start. Total Harmonic Distortion < 10%. High Ballast Factor 1.15 - 1.20 HR8_L=T8 Electronic Program Rapid Start. Total Harmonic Distortion < 10%. Low Ballast Factor .71 - .79			
T8 Ballasts EB8 =T8 Electronic Start. Total Harmonic Distortion < 10%. EB8_/PLUS=T8 Electronic Start. Total Harmonic Distortion < 10%. High Ballast Factor > 1.15 ER8 =T8 Electronic Program Rapid Start. Total Harmonic Distortion < 10%.						
Number of Ballasts	Options ⁷	Packaging	Accessories (Order Separately)			
1=1 Ballast 2=2 Ballasts	FR=Fire Rated Label PAF=Painted After Fabrication	PAL=Job Pack, out of carton PALC=Job Pack, in carton U=Unit Pack	EQ-CLIP-U=T-BAR Safety Earthquake Clips ⁸ FCS-14W-U=1' x 4' Field Installed Flange Kit FCTKA-22W-U=2' x 2' Field Installed Flange Kit FCTKA-24W-U=2' x 4' Field Installed Flange Kit			

NOTES: 1. Specify row configuration, type in catalog number when ordering complete fixtures. 2. Standard off-center ballast on 3-lamp fixtures. 3. Not available for 1'x4'. 4. Products also available in non-US voltage and frequencies for international markets. 5. Not available when specifying emergencies, voltage must be specified. 6. Not available in UNV voltage. Must specify voltage. 7. See Options or Accessories. 8. Recommended for all 9/16" ceiling systems. Four per fixture. 9. Specify row configuration, type in catalog number when ordering complete fixtures. 10. Louver is recessed by 5/16" in Concealed T or Slot Grid T.

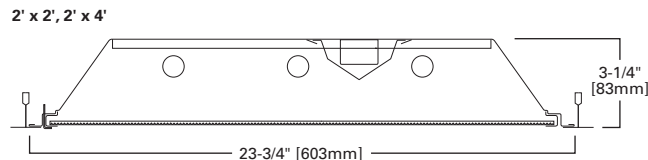
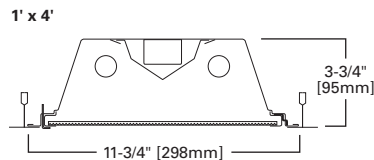
Specifications and dimensions subject to change without notice. Consult your Cooper Lighting Representative or visit www.cooperlighting.com for available options, accessories and ordering information.

FEATURES

- Shallow, low-profile housing
- Spring-loaded steel latches and safety lock T-hinges
- Rotolock T5 lampholders
- Ballast cover easily removed without tools
- Full-length mechanical light-traps and positive end light seals
- Die-formed housing with full-length stiffeners
- End plate grid-lock feature
- Four auxiliary fixture-end suspension points provided
- Field-installation flange kit available, for drywall applications,

DIMENSIONS

1' x 4', 2' x 2', 2' x 4'

Compliances may not apply to all product configurations. Please consult the product spec sheet for compliance details.

COMPLIANCES: UL/cUL Listed - Damp Location, NOM Certified, City of Chicago Approved



GR5 SERIES



ORDERING INFORMATION

SAMPLE NUMBER: 2GR5-228T5A-UNV-EBT1-U

Rating	Width	Trim Type	Series	Number of Lamps (Not Included) ²	Wattage	Shielding
[Blank]=Standard ATW-SW4=Chicago Rated	2=2' Width [Blank]=1' Width	F=Aluminum Flange Trim ¹⁶ G=Concealed-T/Slot Grid ¹⁷ G=Grid/Lay-in (Standard)	R5=General Purpose T5 Commercial Troffer ¹	1=1 Lamp 2=2 Lamps 3=3 Lamps 4=4 Lamps ³	14T5=14W T5 (24") 24T5=24W T5HO (24") 28T5=28W T5 (48") 54T5=54W T5HO (48")	A=#12 Acrylic Pattern A125=#12 Pattern Acrylic(.125" Thick) A19/156=#19 Pattern Acrylic (.156" Thick) PB1S=Silver Parabolic Louver (1/2" x 1/2" x 1/2")
Voltage ⁴	Options		Ballast Type ⁷			
120V=120 Volt 277V=277 Volt 347V=347 Volt UNV=Universal Voltage 120-277 ⁵	EL=Emergency Installed (Must Specify Battery Pack, See Options) Flex=Flex Installed (Reference Flex Ordering Information) GL=Single Element Fuse GM=Double Element Fuse Lamps=Lamps Installed (Refer to Lamp Ordering Options) ⁶		T5 Ballasts EBT_ _{T5} =T5 or T5HO Electronic Program Rapid Start. Total Harmonic Distortion < 10%. Standard Ballast Factor=1.0 Ballast/ Factor Type (T5) EBT_H=T5 Electronic Program Rapid Start. Total Harmonic Distortion < 10%. High Ballast Factor=1.15 ⁸ EBT_HDIM=T5 Electronic Program Rapid Start. Total Harmonic Distortion < 10%. Step Dimming, High Ballast Factor=1.15 ^{9, 10} EBT_N=T5 Electronic Program Rapid Start. Total Harmonic Distortion < 10%. Normal Ballast Factor=.90 ¹¹ EBT_NDIM=T5 Electronic Program Rapid Start. Total Harmonic Distortion < 10%. Step Dimming, Normal Ballast Factor=.95-1.0 ¹²			
Number of Ballasts	Options		Packaging	Accessories (Order Separately)		
1=1 Ballast 2=2 Ballasts 3=3 Ballasts	FR=Can be installed in a Fire Rated Ceiling		U=Unit Pack	EQ-CLIP-U=T-BAR Safety Earthquake Clips FCS-14W-U=1' x 4' Field Installed Flange Kit ⁶ FCTKA-22W-U=2' x 2' Field Installed Flange Kit ⁶ FCTKA-24W-U=2' x 4' Field Installed Flange Kit ⁶		

NOTES: 1. An EQ Grid Clip is recommended for all 9/16" ceiling systems. Four required per fixture. 2. Standard off-center ballast compartment on 3-lamp fixtures. 3. Available with lens only. 4. Products also available in non-US voltage and frequencies for international markets. 5. Not available when specifying emergencies, voltage must be specific. 6. See Options or Accessories. 7. Minimum 2 ballast required for 4 lamp T5HO configurations. 8. 1-Lamp ballast in a High Ballast factor not available. 9. Step Dimming ballast available for 2 28W T5 lamps only. 10. Step Dimming ballast available for 2 14W T5 lamps only. 11. .90 ballast factor available for 2 lamps only. 12. 1-Lamp step dimming ballast in a Normal Ballast factor not available. 2-Lamp ballast will not operate 1-Lamp. 13. Step Dimming ballast available for 2 or 3 28W T5 lamps only. 14. 2 lamps only. 15. Step Dimming ballast available for 2 or 3 14W T5 lamps only. 16. Specify row configuration, type in catalog number when ordering complete fixtures. 17. Louver is recessed by 5/16" in Concealed T or Slot Grid T.

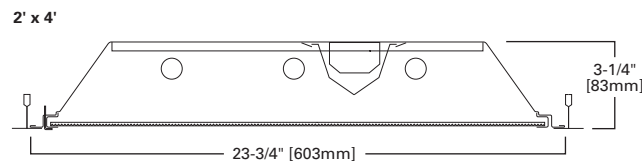
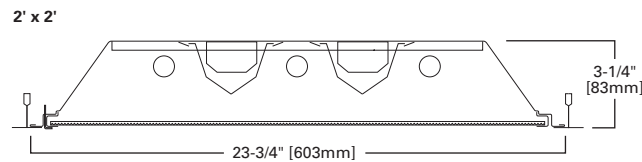
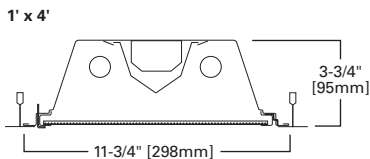

COMMERCIAL GRADE T8 TROFFER



FEATURES

- Optimized for T8 lamps
- Shallow, low-profile housing
- Ballast cover easily removed without tools
- Positive spring-loaded steel latches and safety lock T-hinges
- Full-length stiffeners and unibody end plate for added strength
- Reinforced flat white, steel door and reinforced mitered corners
- Full-width mechanical light traps
- Ample knockouts provided for continuous row wiring

DIMENSIONS

1' x 4', 2' x 2', 2' x 4'

GR8 SERIES

Compliances may not apply to all product configurations. Please consult the product spec sheet for compliance details.

COMPLIANCES: UL/cUL Listed - Damp Location, NOM Certified, IC Rated, City of Chicago Approved



ORDERING INFORMATION

SAMPLE NUMBER: 2GR8-332A-UNV-EB81-U

Rating	Width	Trim Type	Series	Type	Number of Lamps (Not Included) ¹	Wattage (Length)	
[Blank]=Standard ATW-SW4=Chicago Rated	2=2' Width [Blank]=1' Width	F=Aluminum Flange Trim ⁹ G=Concealed-T/Slot Grid ¹⁰ G=Grid/Lay-in (Standard)	R8=General Purpose T8 Commercial Troffer	IC=IC Rated	2=2 Lamps 3=3 Lamps 4=4 Lamps	17=17W T8 (24") 28T8=28W T8 (48") 32=32W T8 (48") BX40=40W Biax (24") U1-5/8=31W T8 (24") ² U6T8=32W T8 (24") ²	
Shielding		Voltage ³	Options				
A=#12 Acrylic Pattern A125=#12 Pattern Acrylic (.125" Thickness) A19/156=#19 Pattern Acrylic (.156" Thickness) PB1S=Silver Parabolic Louver (1/2" x 1/2" x 1/2")		120V=120 Volt 277V=277 Volt 347V=347 Volt UNV=Universal Voltage 120-277 ⁴	EL=Emergency Installed (Must Specify Battery Pack, See Options) Flex=Flex Installed (Reference Flex Ordering Information) GL=Single Element Fuse GM=Double Element Fuse Lamps=Lamps Installed (Refer to Lamp Ordering Options) ⁵			Lamps Installed Blank=No Lamps Installed (Refer to Lamp Ordering Options) L8835=T8 Lamp, 28W and 32W, 3500K L8835HL=T8 Lamp, 28W and 32W, 3500K, 3100 Lumens L8841=T8 Lamp, 28W and 32W, 4100K L8841HL=T8 Lamp, 32W, 4100K, 3100 Lumens	
Ballast Type							
Biax Ballasts EB5 =T5 Biax Electronic Instant Start. Total Harmonic Distortion < 20%. ^{6,7} ER5 =T5 Biax Electronic Program Rapid Start. Total Harmonic Distortion < 10%. TEB5 =T5 Biax Electronic Instant Start. Total Harmonic Distortion < 10%. ^{6,7} T8 Ballasts EB8 =T8 Electronic Start. Total Harmonic Distortion < 10%. EB8_/PLUS=T8 Electronic Start. Total Harmonic Distortion < 10%. High Ballast Factor > 1.15 ER8 =T8 Electronic Program Rapid Start. Total Harmonic Distortion < 10%.			High Performance T8 Ballasts HB8 =T8 Electronic Instant Start. Total Harmonic Distortion < 10%. Standard Ballast Factor .86 - .88 HB8_H=T8 Electronic Instant Start. Total Harmonic Distortion < 10%. High Ballast Factor 1.15 - 1.20 HB8_L=T8 Electronic Instant Start. Total Harmonic Distortion < 10%. Low Ballast Factor .77 - .82 HB8_N=T8 Electronic Instant Start. Total Harmonic Distortion < 10%. Normal Ballast Factor 1.0 HR8 =T8 Electronic Program Rapid Start. Total Harmonic Distortion < 10%. Standard Ballast Factor .86 - .88 HR8_DIM=T8 Electronic Program Rapid Start. Total Harmonic Distortion < 10%. Step Dimming. Ballast Factor .88 HR8_H=T8 Electronic Program Rapid Start. Total Harmonic Distortion < 10%. High Ballast Factor 1.15 - 1.20 HR8_L=T8 Electronic Program Rapid Start. Total Harmonic Distortion < 10%. Low Ballast Factor .71 - .79				
Number of Ballasts			Options		Packaging		
1=1 Ballast 2=2 Ballasts 3=3 Ballasts			FR=Can be installed in a Fire Rated Ceiling		U=Unit Pack		

NOTES: 1. Standard off-center ballast on 3-lamp fixtures. 2. 2 Lamps maximum for U6T8. 3. Products also available in non-US voltage and frequencies for international markets. 4. Not available when specifying emergencies, voltage must be specified. 5. See Options or Accessories. 6. Not available in UNV voltage. Must specify voltage. 7. 4-lamp configuration only available in 17W. 8. An EQ Grid Clip is recommended for all 9/16" ceiling systems. Four required per fixture. 9. Specify row configuration, type in catalog number when ordering complete fixtures. 10. Louver is recessed by 5/16" in Concealed T or Slot Grid T.

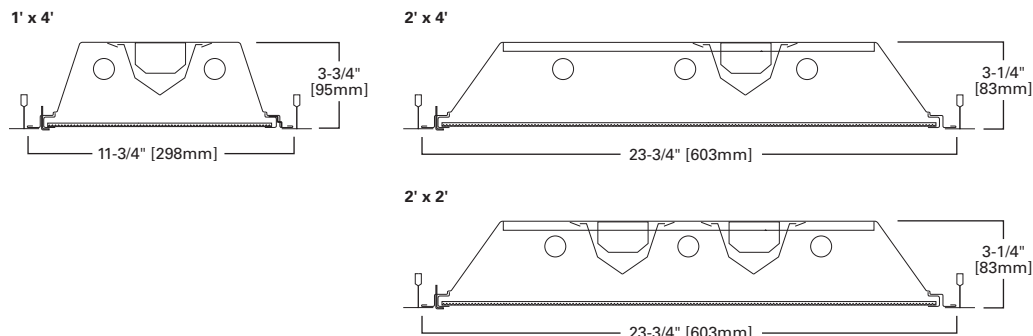

Specifications and dimensions subject to change without notice. Consult your Cooper Lighting Representative or visit www.cooperlighting.com for available options, accessories and ordering information.

FEATURES

- Equipped with energy-saving ballasts
- Efficient air-handling options
- Die-embossed para-contoured housing
- Deep "V" raceway/ballast cover (removes easily without tools)
- High reflectance and optimum lamp-to-lens spacing
- Self-locking, spring-loaded cam latch/T-hinges
- Floating extruded aluminum door
- End plate grid-lock feature
- Four auxiliary fixture-end suspension points provided

DIMENSIONS

1' x 4', 2' x 2', 2' x 4', 20" x 48"

Compliances may not apply to all product configurations. Please consult the product spec sheet for compliance details.

COMPLIANCES: UL/cUL Listed - Damp Location, NOM Certified, City of Chicago Approved



GCAFA SERIES



ORDERING INFORMATION

SAMPLE NUMBER: 2GCAFA-232A-UNV-EB81-U

Rating	Width	Trim Type	Series	Air Supply	Doorframes
[Blank]=Standard ATW-SW4=Chicago Rated	2=2' Width [Blank]=1' Width	F=Aluminum Flange Trim ⁷ G=Concealed-T/Slot Grid ⁸ G=Grid/Lay-in (Standard)	C=Specification Deep Troffer	[Blank]=No Vane A=Air Handling Floating Door, Black Reveal AV=Air Handling with Directional Vanes B=Non-Air Handling Floating Door, Black Reveal	FA=Flush White Extruded Aluminum c/w Spring Latch FAB=Flush Black Extruded Aluminum FAN=Flush Natural Anodized Extruded Aluminum RA=Regressed White Extruded Aluminum (3/8") RAB=Regressed Black Extruded Aluminum RAN=Regressed Natural Anodized Extruded Aluminum
Optional Width/Length	Number of Lamps (Not Included)	Wattage (Length)	Shielding ⁴	Option-Aluminum Flange Trim ¹	
2048=20" Width x 48' Length	1=1 Lamp 2=2 Lamps 3=3 Lamps ² 4=4 Lamps	17=17W T8 (24") 28T8=28W T8 (48") ³ 32=32W T8 (48") BX40=40W Biax (24") U15/8=31W T8 (24") U6T8=32W T8 (24")	A=#12 Acrylic Pattern A125=#12 Pattern Acrylic (.125" Thick) A19/156=#19 Pattern Acrylic (.156" Thick) DA=Dropped Dish Matte White Acrylic IMA 48=Injection Molded Acrylic (.150" Thick) PB1S=1/2" x 1/2" x 1/2" Silver Parabolic Louver (Styrene)	[Blank]=SW (Single White) ¹ EN=End of Row, Natural Finish EW=End of Row, White Finish RN=In Row, Natural Finish RW=In Row, White Finish SN=Single, Natural Finish	
Voltage ⁵	Options	Lamps Installed			
120V=120 Volt 277V=277 Volt 347V=347 Volt UNV=Universal Voltage 120-277 ⁶	EL=Emergency Installed Flex=Flex Installed (Reference Flex Ordering Guide) GL=Single Element Fuse GM=Double Element Fuse Lamps=Lamps Installed (Refer to Lamp Ordering Options) WTR=White Reveal	[Blank]=No Lamps Installed (Refer to Lamp Ordering Options) L8835=T8 Lamp, 28W and 32W, 3500K L8835HL=T8 Lamp 32W, 3500K, 3100 Lumens L8841=T8 Lamp, 28W and 32W, 4100K L8841HL=T8 Lamp, 32W, 4100K, 3100 Lumens			
Ballast Type					
Biax Ballasts EB5 =T5 Biax Electronic Instant Start. Total Harmonic Distortion < 20%. TEB5 =T5 Biax Electronic Instant Start. Total Harmonic Distortion < 10%. T8 Ballasts EB8 =T8 Electronic Start. Total Harmonic Distortion < 10%. EB8 /PLUS=T8 Electronic Start. Total Harmonic Distortion < 10%. High Ballast Factor > 1.15 ER8 =T8 Electronic Program Rapid Start. Total Harmonic Distortion < 10%.		High Performance T8 Ballasts HB8 =T8 Electronic Instant Start. Total Harmonic Distortion < 10%. Standard Ballast Factor .86 - .88 HB8_H=T8 Electronic Instant Start. Total Harmonic Distortion < 10%. High Ballast Factor 1.15 - 1.20 HB8_L=T8 Electronic Instant Start. Total Harmonic Distortion < 10%. Low Ballast Factor .77 - .82 HB8_N=T8 Electronic Instant Start. Total Harmonic Distortion < 10%. Normal Ballast Factor 1.0 HR8 =T8 Electronic Program Rapid Start. Total Harmonic Distortion < 10%. Standard Ballast Factor .86 - .88 HR8_DIM=T8 Electronic Program Rapid Start. Total Harmonic Distortion < 10%. Step Dimming. Ballast Factor .88 HR8_H=T8 Electronic Program Rapid Start. Total Harmonic Distortion < 10%. High Ballast Factor 1.15 - 1.20 HR8_L=T8 Electronic Program Rapid Start. Total Harmonic Distortion < 10%. Low Ballast Factor .71 - .79			
Number of Ballasts	Options ⁴	Packaging	Accessories (Order Separately)		
1=1 Ballast 2=2 Ballasts 3=3 Ballasts	PAF=Painted After Fabrication RLS=Rotor-Lock Socket (T8 Lamps Only)	PAL=Job Pack Out of Carton PALC=Job Pack, in carton U=Unit Pack	EQ-CLIP-U=T-BAR Safety Earthquake Clips		

NOTES: 1. Specify row configuration, type in catalog number when ordering complete fixtures. 2. Standard off-center ballast on 3-lamp fixtures. 3. HPT8 Ballast required with 28W T8 lamps. 4. See Options or Accessories. 5. Products also available in non-US voltage and frequencies for international markets. 6. Not available when specifying emergencies, voltage must be specified. 7. Specify row configuration, type in catalog number when ordering complete fixtures. 8. Louver is recessed by 5/16" in Concealed T or Slot Grid T.

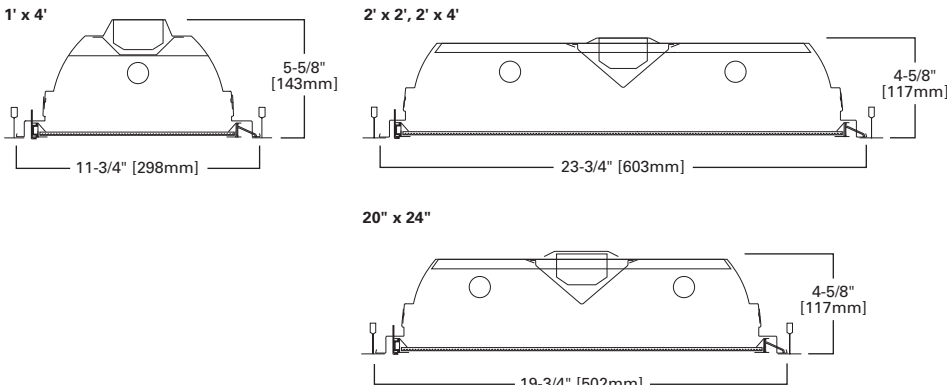

Specifications and dimensions subject to change without notice. Consult your Cooper Lighting Representative or visit www.cooperlighting.com for available options, accessories and ordering information.

AIR SUPPLY MULTI-CELL METAL OR PLASTIC LOUVER TROFFER



FEATURES

- Equipped with energy-saving ballasts
- Concealed frame, multi-cell, 1"-deep injection-molded parabolic louver
- Deep "V" raceway/ballast cover (removes without tools)
- Self-locking, spring-loaded, cam latches / T-hinges
- Multi-cell 3/4" or 1-1/2" deep parabolic aluminum louver
- One-piece para-contoured housing
- Various louver finishes
- High reflectance and optimum lamp-to-lens spacing
- Frameless, full-floating-effect louver assembly

DIMENSIONS

2' x 2', 2' x 4'

2GCAML SERIES

Compliances may not apply to all product configurations. Please consult the product spec sheet for compliance details.

COMPLIANCES: UL/cUL Listed - Damp Location, NOM Certified, City of Chicago Approved

ORDERING INFORMATION

SAMPLE NUMBER: 2GCAML-232S6131-UNV-EB81-U

Rating	Width	Trim Type	Series	Air Supply	Door Frame	Number of Lamps ² (Not Included)
[Blank]=Standard ATW-SW4=Chicago Rated	2=2' Width	F=Aluminum Flange Trim ⁹ G=Concealed-T/Slot Grid ¹⁰ G=Grid/Lay-in (Standard)	C=Specification Deep Troffer	[Blank]=No Vane A=Air Handling Floating Door, Black Reveal AV=Air Handling with Directional Vanes B=Non-Air Handling Floating Door, Black Reveal	ML=Frameless Metal Parabolic (Standard)	2=2 Lamps 3=3 Lamps 4=4 Lamps ³
Wattage	Louver	Cell Configuration	Louver Finish		Option-Aluminum Flange Trim	Voltage ⁵
17=17W T8 (24") 28T8=28W T8 (48") ⁴ 32=32W T8 (48") BX40=40W Biax (24") U15/8=31W T8 (24") U6T8=31WT8 (24")	S=Silver W=White	1313=13 Rows of 13, 169 Cell (2' x 2') 1329=13 Rows of 29, 377 Cell (2' x 4') 613=6 Rows of 13, 78 Cell (2' x 4') 66=6 Rows of 6, 36 Cell (2' x 2') 77=7 Rows of 7, 49 Cell (2' x 2')	I=Semi-Specular/Haze MI=Specular/Mirrored (Low Iridescent) P=White Finish		EN=End of Row, Natural Finish EW=End of Row, White Finish RN=In Row, Natural Finish RW=In Row, White Finish SN=Single, Natural Finish	120V=120 Volt 277V=277 Volt 347V=347 Volt UNV=Universal Voltage 120-277 ⁶

Ballast Type

[Blank]=Standard Magnetic Ballast (Biax and 20W)

Biax Ballasts

EB5=T5 Biax Electronic Instant Start. Total Harmonic Distortion < 20%.

TEB5=T5 Biax Electronic Instant Start. Total Harmonic Distortion < 10%.

T8 Ballasts

EB8=T8 Electronic Start. Total Harmonic Distortion < 10%.

EB8_/PLUS=T8 Electronic Start. Total Harmonic Distortion < 10%.
High Ballast Factor > 1.15

ER8=T8 Electronic Program Rapid Start. Total Harmonic Distortion < 10%.

High Performance T8 Ballasts

HB8=T8 Electronic Instant Start. Total Harmonic Distortion < 10%. Standard Ballast Factor .86 - .88

HB8_H=T8 Electronic Instant Start. Total Harmonic Distortion < 10%. High Ballast Factor 1.15 - 1.20

HB8_L=T8 Electronic Instant Start. Total Harmonic Distortion < 10%. Low Ballast Factor .77 - .82

HB8_N=T8 Electronic Instant Start. Total Harmonic Distortion < 10%. Normal Ballast Factor 1.0

HR8=T8 Electronic Program Rapid Start. Total Harmonic Distortion < 10%. Standard Ballast Factor .86 - .88

HR8_DIM=T8 Electronic Program Rapid Start. Total Harmonic Distortion < 10%. Step Dimming. Ballast Factor .88

HR8_H=T8 Electronic Program Rapid Start. Total Harmonic Distortion < 10%. High Ballast Factor 1.15 - 1.20

HR8_L=T8 Electronic Program Rapid Start. Total Harmonic Distortion < 10%. Low Ballast Factor .71 - .79

Number of Ballasts	Options ⁷	Lamps Installed ⁷	Accessories (Order Separately)
1=1 Ballast 2=2 Ballasts 3=3 Ballasts	EL=Emergency Battery Installed (Must Specify Battery Pack, See Options) Flex=Flex Installed (Reference Flex Ordering Information) GL=Single Element Fuse GM=Double Element Fuse PAF=Painted After Fabrication RIF1=Radio Interference Suppressor RLS=Rotor-Lock Socket (T8 Lamps Only - Standard on T5)	[Blank]=No Lamps Installed (Refer to Lamp Ordering Options) L8730=F32T8 3000K L8735=F32T8 3500K L8741=F32T8 4100K L8835=T8 Lamp, 28W and 32 W, 3500K ⁴ L8835HL=T8 Lamp, 32W, 3500K, 3100 Lumens L8841=T8 Lamp, 28W and 32W, 4100K ⁴ L8841HL=T8 Lamp, 32W, 4100K, 3100 Lumens	EQ-Clip-U=T-BAR Safety Earthquake Clips ⁸

NOTES: 1. Specify row configuration, type in catalog number when ordering complete fixtures. 2. Standard off-center ballast on 3-lamp fixtures. 3. 2' x 4' only. 4. HPT8 Ballast required with 28W T8 lamps. 5. Products also available in non-US voltage and frequencies for international markets. 6. Not available when specifying emergencies, voltage must be specified. 7. See Options or Accessories. 8. An EQ Grid Clip is recommended for all 9/16" ceiling systems. Four required per fixture. 9. Specify row configuration, type in catalog number when ordering complete fixtures. 10. Louver is recessed by 5/16" in Concealed T or Slot Grid T.

GCAML 2' x 2', 2' x 4'

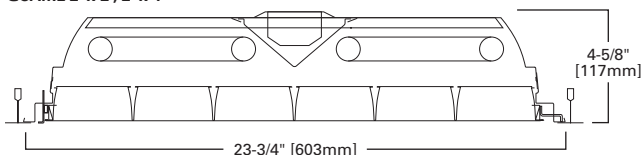

GCAPL 2' x 2', 2' x 4'

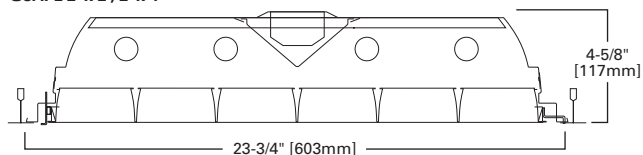

Specifications and dimensions subject to change without notice. Consult your Cooper Lighting Representative or visit www.cooperlighting.com for available options, accessories and ordering information.

FEATURES

- Provided with CEE-listed, energy-saving ballasts
- Lens and housing incorporate contemporary extruded aluminum styling
- Housing has brushed-aluminum finish with matching end plates
- Optional housing finishes include white, matte black and almond
- Die-formed internal steel channell with baked white enamel finish
- Walnut trim stripe, oak or matte black finishes
- Down-only or up-and-down light distribution
- Convenience outlet and multi-level switching available

DIMENSIONS

2', 3', 4'

Compliances may not apply to all product configurations. Please consult the product spec sheet for compliance details.

COMPLIANCES: UL/cUL Listed, UL/cUL Listed - Damp Location



BA, BAU SERIES



ORDERING INFORMATION

SAMPLE NUMBER: BAUB-232-UNV-EB81-WH-BT-U

Series	Number of Lamps (Not Included)	Wattage	Voltage ²	Options
BA =Wall Bracket Downlight Only BAU =Wall Bracket (Up and Down Light) BAUB =Wall Bracket (Up, Down or Combination Light) ¹	1 =1 Lamp 2 =2 Lamps	14T5 =14W T5 (24") 17 =17W T8 (24") 21T5 =21W T5 (36") 25 =25W T8 (36") 28T5 =28W T5 (48") 32 =32W T8 (48")	120V =120 Volt 277V =277 Volt 347V =347 Volt UNV =Universal Voltage 120-277 ³	EL =Emergency Battery Installed (Must Specify Battery Pack, See Options) ⁴ GL =Single Element Fuse GM =Double Element Fuse

Ballast Type

T5 Ballasts

EBT=T5 or T5HO Electronic Program Rapid Start. Total Harmonic Distortion < 10%. Standard Ballast Factor=1.0

Ballast/Factor Type (T5)

EBT_H=T5 Electronic Program Rapid Start. Total Harmonic Distortion < 10%. High Ballast Factor=1.15⁵

EBT_HDIM=T5 Electronic Program Rapid Start. Total Harmonic Distortion < 10%. Step Dimming, High Ballast Factor=1.15⁷

EBT_N=T5 Electronic Program Rapid Start. Total Harmonic Distortion < 10%. Normal Ballast Factor=0.9

EBT_NDIM=T5 Electronic Program Rapid Start. Total Harmonic Distortion < 10%. Step Dimming, Normal Ballast Factor=.95-1.0⁶

T8 Ballasts

EB8=T8 Electronic Start. Total Harmonic Distortion < 10%.

EB8 /PLUS=T8 Electronic Start. Total Harmonic Distortion < 10%. High Ballast Factor > 1.15

ER8=T8 Electronic Program Rapid Start. Total Harmonic Distortion < 10%.

Number of Ballasts	Options	Finishes	Packaging
1 =1 Ballast 2 =2 Ballasts 3 =3 Ballasts	2/1 LB =(2) One-Lamp Ballasts (When RS4 or PS4 Option is Used) BT =Black Accent Trim CO =Convenience Outlet (120V Only) OT =Oak Accent Trim PL5 or PL7 =Fluorescent Night Light (5 or 7 Watt) Only Available in Fixtures Without a Baffle PS1 =Pull Switch (1 Circuit) PS1D =Pull Switch, Wired to the Downlight Circuit on a Two Circuit Fixture (120V Only) PS4 =Four-way pull switch, for Two Circuit, Two Lamp Fixture (120V Only) RLS =Rotor-Lock Socket (T8 Lamp Only) RS1 =Rotary Switch (1 Circuit, 120V Only) RS1D =Rotary Switch, Wired to Downlight Circuit on a Two Circuit Fixture (120V Only) RS4 =Four-way rotary switch, for Two Circuit, Two Lamp Fixture, (120V Only) ²	BH =Matte Black Finish (Lens Housing) IH =Almond Finish (Lens Housing) WH =White Finish (Lens Housing)	U =Unit Pack

NOTES: 1. BAUB series requires two ballast and switch for independent switching. 2. Products also available in non-US voltage and frequencies for international markets. 3. Not available when specifying emergencies, voltage must be specified. 4. Not available for 2' units. 5. 2 lamps only. 6. 1-Lamp step dimming ballast in a Normal Ballast factor not available. 2-Lamp ballast will not operate 1-Lamp. 7. Step Dimming ballast available for 2 14W T5 or 28W T5 lamps only.

2', 3', 4'

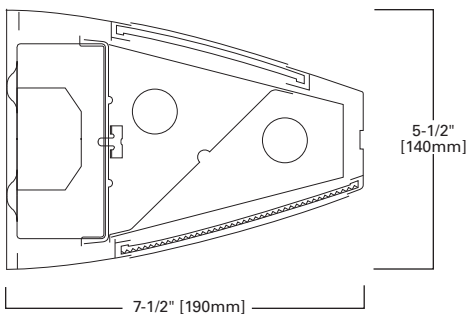

Specifications and dimensions subject to change without notice. Consult your Cooper Lighting Representative or visit www.cooperlighting.com for available options, accessories and ordering information.

COMMERCIAL STEEL WALL BRACKET - FULL END



FEATURES

- Provided with CEE-listed, energy-saving ballasts
- Low-profile design
- Die-formed steel housing
- Baked white enamel finish
- Downlight, uplight or combination uplight and downlight illumination
- Refractor slides forward for easy installation and maintenance
- Easy wiring access
- Low-brightness, extruded-acrylic diffuser
- Injection-molded end plates

DIMENSIONS

7-1/2" Width x 2", 3", 4"

BE, BEU SERIES

Compliances may not apply to all product configurations. Please consult the product spec sheet for compliance details.

COMPLIANCES: UL/cUL Listed, UL/cUL Listed - Damp Location



ORDERING INFORMATION

SAMPLE NUMBER: BE-232-UNV-EB81-U

Series	Number of Lamps (Not Included)	Wattage	Voltage ¹	Options	
BE =Steel Wall Bracket Downlight Only	1=1 Lamp 2=2 Lamps	14T5 =14W T5 (24") 17 =17W T8 (24") 21T5 =21W T5 (36")	25 =25W T8 (36") 28T5 =28W T5 (48") 32 =32W T8 (48")	120V =120 Volt 277V =277 Volt 347V =347 Volt UNV =Universal Voltage 120-277 ²	EL =Emergency Battery Installed (Must Specify Battery Pack, See Options) GL =Single Element Fuse GM =Double Element Fuse

Ballast Type

T5 Ballasts

EBT_T5 or T5HO Electronic Program Rapid Start. Total Harmonic Distortion < 10%. Standard Ballast Factor=1.0

Ballast/Factor Type (T5)

EBT_H=T5 Electronic Program Rapid Start. Total Harmonic Distortion < 10%. High Ballast Factor=1.15³

EBT_HDIM=T5 Electronic Program Rapid Start. Total Harmonic Distortion < 10%. Step Dimming, High Ballast Factor=1.15⁴

EBT_N=T5 Electronic Program Rapid Start. Total Harmonic Distortion < 10%. Normal Ballast Factor=.90

EBT_NDIM=T5 Electronic Program Rapid Start. Total Harmonic Distortion < 10%. Step Dimming, Normal Ballast Factor=.95-1.0⁵

T8 Ballasts

EB8_T8 Electronic Start. Total Harmonic Distortion < 10%.

EB8 /PLUS=T8 Electronic Start. Total Harmonic Distortion < 10%. High Ballast Factor > 1.15

ER8_T8 Electronic Program Rapid Start. Total Harmonic Distortion < 10%.

Number of Ballasts	Options	Packaging
1=1 Ballast 2=2 Ballasts	2/1LB =(2) One-Lamp Ballasts (When RS4 or PS4 Option is Used) BH =Matte Black Finish (Lens Housing) CO =Convenience Outlet (120V Only) PL5 or PL7 =Fluorescent Night Light (5 or 7 Watt) Only Available in Fixtures Without a Baffle PS1 =Pull Switch (1 Circuit) PS1D =Pull Switch, Wired to Downlight Circuit on a Two Circuit Fixture (120V Only) PS4 =Four-way pull switch, for Two Circuit 2 Lamp Fixture (120V Only) RLS =Rotor Lock Socket (T8 Lamps Only) RS1 =Rotary Switch (1 Circuit, 120V Only) RS1D =Rotary Switch Wired to Downlight Circuit on a Two Circuit Fixture (120V Only) RS4 =Four-way rotary switch, for Two Circuit, Two Lamp Fixture (120V Only)	U =Unit Pack

NOTES: 1. Products also available in non-US voltage and frequencies for international markets. 2. Not available when specifying emergencies, voltage must be specified. 3. 1-Lamp ballast in a High Ballast factor not available. 4. Step Dimming ballast available for 2 or 3 14WT5 or 28W T5 lamps only. 5. 1-Lamp step dimming ballast in a Normal Ballast factor not available. 2-Lamp ballast will not operate 1-Lamp.

2", 3", 4"

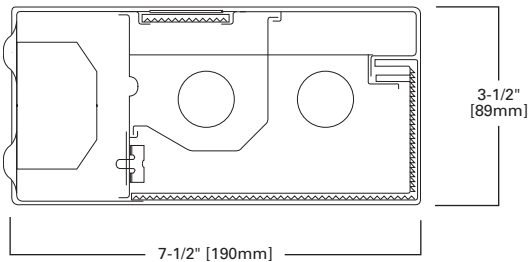

Specifications and dimensions subject to change without notice. Consult your Cooper Lighting Representative or visit www.cooperlighting.com for available options, accessories and ordering information.

ALL PURPOSE WALL BRACKET



BC SERIES

FEATURES

- Provided with CEE-listed, energy-saving ballasts
- Ideal for high vertical illumination areas
- 180° uniform light distribution
- Extruded, smooth opal, white, acrylic refractor
- Decorative, opaque, injection-molded white end caps
- Die-formed housing in a baked white enamel finish
- Vertical-wall- or horizontal-ceiling-mount applications
- Easy maintenance design
- Mounted vertically or horizontally

DIMENSIONS

2', 3', 4'

Compliances may not apply to all product configurations. Please consult the product spec sheet for compliance details.

COMPLIANCES: UL/cUL Listed, UL/cUL Listed - Damp Location



ORDERING INFORMATION

SAMPLE NUMBER: BC-228T5-UNV-EBT1-U

Series	Number of Lamps	Wattage	Voltage ¹	Options	
BC=All Purpose Wall Bracket	1=1 Lamp 2=2 Lamps	14T5=14W T5 (24") 25=25W T8 (36") 17=17W T8 (24") 28T5=28W T5 (48") 21T5=21W T5 (36") 32=32W T8 (48")	120V=120 Volt 277V=277 Volt 347V=347 Volt UNV=Universal Voltage 120-277 ²	EL=Emergency Battery Installed (Must Specify Battery Pack, See Options) GL=Single Element Fuse GM=Double Element Fuse	
Ballast Type			Number of Ballasts	Options	Packaging
T5 Ballasts EBT_=T5 or T5HO Electronic Program Rapid Start. Total Harmonic Distortion < 10%. Standard Ballast Factor=1.0 Ballast/Factor Type (T5) EBT_H=T5 Electronic Program Rapid Start. Total Harmonic Distortion < 10%. High Ballast Factor=1.15 ³ EBT_HDIM=T5 Electronic Program Rapid Start. Total Harmonic Distortion < 10%. Step Dimming, High Ballast Factor=1.15 ⁴ EBT_N=T5 Electronic Program Rapid Start. Total Harmonic Distortion < 10%. Normal Ballast Factor=.90 EBT_NDIM=T5 Electronic Program Rapid Start. Total Harmonic Distortion < 10%. Step Dimming, Normal Ballast Factor=.95-1.0 ⁵ T8 Ballasts EB8_=T8 Electronic Start. Total Harmonic Distortion < 10%. EB8_/PLUS=T8 Electronic Start. Total Harmonic Distortion < 10%. High Ballast Factor > 1.15 ER8_=T8 Electronic Program Rapid Start. Total Harmonic Distortion < 10%.			1=1 Ballast 2=2 Ballasts	CO=Convenience Outlet (120V Only) PS1=Pull Switch (1 Circuit) RLS=Rotor Lock Socket (T8 Lamps Only) RS1=Rotary Switch (1 Circuit, 120V Only)	U=Unit Pack

NOTES: 1. Products also available in non-US voltage and frequencies for international markets. 2. Not available when specifying emergencies, voltage must be specified. 3. 1-Lamp ballast in a High Ballast factor not available. 4. Step Dimming ballast available for 2 or 3 14WT5 or 28W T5 lamps only. 5. 1-Lamp step dimming ballast in a Normal Ballast factor not available. 2-Lamp ballast will not operate 1-Lamp.

2', 3', 4'

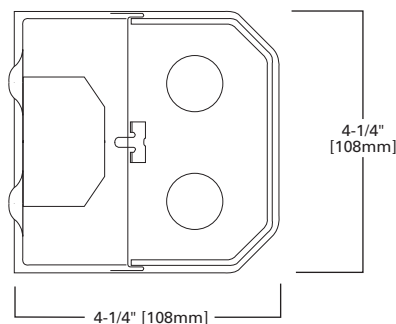

STEEL WALL BRACKET



FEATURES

- Provided with CEE-listed, energy-saving ballasts
- Low-profile design
- Die-formed steel housing
- Baked white enamel finish
- Downlight, uplight or combination uplight and downlight illumination
- Injection-molded diffuser and end plates
- Refractor slides forward for easy installation and maintenance
- Easy wiring access
- Convenience outlet and switching options available

DIMENSIONS

7-1/2" wide x 2', 3', 4'

BI, BIU SERIES

Compliances may not apply to all product configurations. Please consult the product spec sheet for compliance details.

COMPLIANCES: UL/cUL Listed, UL/cUL Listed - Damp Location

ORDERING INFORMATION

SAMPLE NUMBER: BIU-232-120V-EB82-PS4-U

Series	Number of Lamps (Not Included)	Wattage	Voltage ¹	Options
BI=Steel Wall Bracket Downlight Only	1=1 Lamp	14T5=14W T5 (24")	120V=120 Volt	EL=Emergency Battery Installed
BIU=Steel Wall Bracket (Up and Down Light)	2=2 Lamps	17=17W T8 (24")	277V=277 Volt	(Must Specify Battery Pack, See Options)
		21T5=21W T5 (36")	347V=347 Volt	GL=Single Element Fuse
		25=25W T8 (36")	UNV=Universal Voltage 120-277 ²	GM=Double Element Fuse
		28T5=28W T5 (48")		
		32=32W T8 (48")		

Ballast Type

T5 Ballasts

EBT__{T5} or T5HO Electronic Program Rapid Start. Total Harmonic Distortion < 10%. Standard Ballast Factor=1.0

Ballast/Factor Type (T5)

EBT__H=T5 Electronic Program Rapid Start. Total Harmonic Distortion < 10%. High Ballast Factor=1.15³EBT__{HDIM}=T5 Electronic Program Rapid Start. Total Harmonic Distortion < 10%. Step Dimming, High Ballast Factor=1.15⁴EBT__N=T5 Electronic Program Rapid Start. Total Harmonic Distortion < 10%. Normal Ballast Factor=.90EBT__{NDIM}=T5 Electronic Program Rapid Start. Total Harmonic Distortion < 10%. Step Dimming, Normal Ballast Factor=.95-1.0⁵

T8 Ballasts

EB8__{T8} Electronic Start. Total Harmonic Distortion < 10%.EB8__{/PLUS}=T8 Electronic Start. Total Harmonic Distortion < 10%. High Ballast Factor > 1.15ER8__{T8} Electronic Program Rapid Start. Total Harmonic Distortion < 10%.

Number of Ballasts	Options	Packaging
1=1 Ballast 2=2 Ballasts	2/1LB=(2) One-Lamp Ballasts (When RS4 or PS4 Option is Used) BH=Matte Black Finish (Lens Housing) CO=Convenience Outlet (120V Only) PL5 or PL7=Fluorescent Night Light (5 or 7 Watt) Only Available in Fixtures Without a Baffle PS1=Pull Switch (1 Circuit) PS1D=Pull Switch, Wired to Downlight Circuit on a Two Circuit Fixture (120V Only) PS4=Four-way pull switch, for Two Circuit 2 Lamp Fixture (120V Only) RLS=Rotor Lock Socket (T8 Lamps Only) RS1=Rotary Switch (1 Circuit, 120V Only) RS1D=Rotary Switch Wired to Downlight Circuit on a Two Circuit Fixture (120V Only) RS4=Four-way rotary switch, for Two Circuit, Two Lamp Fixture (120V Only)	U=Unit Pack

NOTES: 1. Products also available in non-US voltage and frequencies for international markets. 2. Not available when specifying emergencies, voltage must be specified. 3. 1-Lamp ballast in a High Ballast factor not available. 4. Step Dimming ballast available for 2 or 3 14WT5 or 28W T5 lamps only. 5. 1-Lamp step dimming ballast in a Normal Ballast factor not available. 2-Lamp ballast will not operate 1-Lamp.

2', 3', 4'

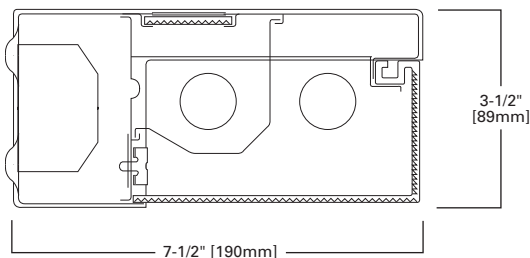

T8 OR T5 UNDERCABINET



CL, UC SERIES

FEATURES

- Post-painted housings and 100% acrylic non-yellowing lenses
- Thin profile housing constructed of heavy-gauge, cold-rolled steel
- Rocker switch (included) can be field-installed (UC series only)
- All fixtures shipped as direct wired
- Easy re-lamping and maintenance
- Various lengths available

DIMENSIONS

12", 18", 21", 24", 33", 36", 42", 48"

Compliances may not apply to all product configurations. Please consult the product spec sheet for compliance details.

COMPLIANCES: UL/cUL Listed - Damp Location



ORDERING INFORMATION

SAMPLE NUMBER: CL-117-120V-EB81-U

Housing Design	Series	Number of Lamps (Not Included)	Wattage (Length)	Starting Type	Voltage ¹	
[Blank]=Lensed Front (Standard) OF=Opaque Front	CL=Series	1=1 Lamp Only	15=15W T8 (18") 17=17W T8 (24") 25=25W T8 (36") 32=32W T8 (48")	HTS=High Trigger Start (15W Only) LTS=Low Trigger Start (15W Only) (120V Only)	120V=120 Volt 277V=277 Volt 347V=347 Volt UNV=Universal Voltage 120-277 ²	
Options	Ballast Type			Number of Ballast	Options	Packaging
GL=Single Element Fuse GM=Double Element Fuse	[Blank]=Standard Magnetic Ballast (15W Only) T8 Ballasts EB8=T8 Electronic Start. Total Harmonic Distortion < 10%. EB8_/PLUS=T8 Electronic Start. Total Harmonic Distortion < 10%. High Ballast Factor > 1.15. ER8=T8 Electronic Program Rapid Start. Total Harmonic Distortion < 10%.			1=1 Ballast 2=2 Ballasts 3=3 Ballasts	6CP=6' White 3-Wire Fuse CO=Convenience Outlet RLS=Rotor Lock Socket (T8 Lamp Only) SW=Rocker Switch ³	U=Unit Pack

NOTES: 1. Products also available in non-US voltage and frequencies for international markets. 2. Not available when specifying emergencies, voltage must be specified. 3. Must specify voltage.

ORDERING INFORMATION

SAMPLE NUMBER: CL-113T5-EB-120V-U

Housing Design	Series	Number of Lamps (Not Included)	Wattage (Length)	Ballast Type	Voltage	Options	Packaging
[Blank]=Lensed Front (Standard) OF=Opaque Front SF=Solid Metal Front	CL=Series	1=1 Lamp Only (12", 21", 33" Fixture) 2=24", 42" Fixture	0813T5=8W and 13W T5 (33") 08T5=8W T5 (12", 24") 13T5=13W T5 (21", 42")	EB=Electronic Ballast PH=Pre-Heat Ballast	120V=120 Volt	6CP=6' White 3-Wire Fuse CO=Convenience Outlet SW=Rocker Switch	U=Unit Pack

ORDERING INFORMATION RESIDENTIAL

Catalog Number	Description	Length	Width	Depth
UC12T518	12", 1 lamp T5, 8W, 120V, electronic ballast, lamp included	12-1/4"	5"	1-3/8"
UC21T5113	21", 1 lamp T5, 13W, 120V, electronic ballast, lamp included	21-1/4"	5"	1-3/8"
UC24T528	24", 2 lamp T5, 2/8W, 120V, electronic ballast, lamps included	24-1/2"	5"	1-3/8"
UC33T51813	33", 2 lamp T5, 8 +13W, 120V, electronic ballast, lamps included	33-3/8"	5"	1-3/8"
UC42T5213	42", 2 lamp T5, (2) 13W, 120V, electronic ballast, lamps included	42-1/2"	5"	1-3/8"
UC18T8115	18", 1 lamp T8, 15W, 120V, electronic ballast, lamp included	18-1/4"	3-7/8"	1-5/8"
UC24T8117	24", 1 lamp T8, 17W, 120V, electronic ballast, lamp included	24-1/4"	3-7/8"	1-5/8"
UC36T8125	36", 1 lamp T8, 25W, 120V, electronic ballast, lamp included	36-1/8"	3-7/8"	1-5/8"
UC48T8132	48", 1 lamp T8, 32W, 120V, electronic ballast, lamp included	48-1/6"	3-7/8"	1-5/8"

CL - 18", 24", 36", 48", 1 T8 LAMP

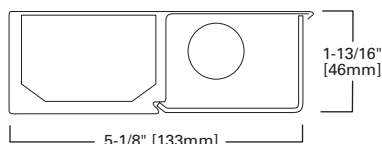

UC - T8

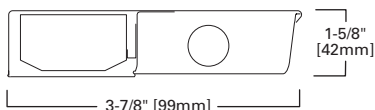

UC DIMENSIONS

Catalog Number	Length
UC12T518	12-1/4"
UC21T5113	21-1/4"
UC24T528	24-1/2"
UC33T51813	33-3/8"
UC42T5213	42-1/2"
UC18T8115	18-1/4"
UC24T8117	24-1/4"
UC36T8125	36-1/8"
UC48T8132	48-1/6"

CL - 2", 21", 24", 33", 42", 1 or 2 T5 LAMPS

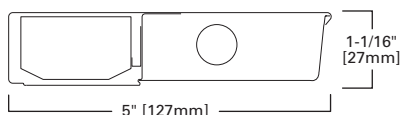

UC - T5

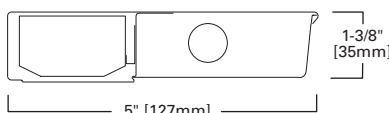

Specifications and dimensions subject to change without notice. Consult your Cooper Lighting Representative or visit www.cooperlighting.com for available options, accessories and ordering information.

SURFACE CORRIDOR MOUNT



FEATURES

- Provided with CEE-listed, energy-saving ballasts
- Die-formed channel and end plates with embossed light seal
- Extruded-acrylic refractor optimizes efficiency and brightness control
- Baked white enamel finish
- Lift-and-shift refractor offers easy re-lamping
- Wireway cover easily removed without tools
- Surface- or stem-mount in single or continuous row
- Tandem 8' lengths
- Optional wall-mount bracket

DIMENSIONS

6-1/8" x 2', 4', 8'

CR SERIES

Compliances may not apply to all product configurations. Please consult the product spec sheet for compliance details.

COMPLIANCES: UL/cUL Listed, UL/cUL Listed - Damp Location

ORDERING INFORMATION

SAMPLE NUMBER: CR-232A-120V-EB81-U

Tandem ¹	Series	Number of Lamps (Not Included)	Wattage	Lens	Voltage ²
8T=8' Length [Blank]=2' or 4' Length	CR=Corridor Lite	1=1 Lamp 2=2 Lamps	14T5=14W T5 (24") 17=17W T8 (24") 28T5=28W T5 (48") 32=32W T8 (48") 96T8=59W T8 SL (96")	A=Acrylic Refractor Lens	120V=120 Volt 277V=277 Volt 347V=347 Volt UNV=Universal Voltage 120-277 ³

Ballast Type

T5 Ballasts

EBT_{T5}=T5 or T5HO Electronic Program Rapid Start. Total Harmonic Distortion < 10%. Standard Ballast Factor=1.0

Ballast/Factor Type (T5)

EBT_H=T5 Electronic Program Rapid Start. Total Harmonic Distortion < 10%. High Ballast Factor=1.15⁴EBT_{HDIM}=T5 Electronic Program Rapid Start. Total Harmonic Distortion < 10%. Step Dimming, High Ballast Factor=1.15EBT_N=T5 Electronic Program Rapid Start. Total Harmonic Distortion < 10%. Normal Ballast Factor=.90⁵EBT_{NDIM}=T5 Electronic Program Rapid Start. Total Harmonic Distortion < 10%. Step Dimming, Normal Ballast Factor=.95-1.0⁶

T8 Ballasts

EB8_{T8}=T8 Electronic Start. Total Harmonic Distortion < 10%.EB8_{PLUS}=T8 Electronic Start. Total Harmonic Distortion < 10%. High Ballast Factor > 1.15ER8_{T8}=T8 Electronic Program Rapid Start. Total Harmonic Distortion < 10%.

High Performance T8 Ballasts

HB8_{T8}=T8 Electronic Instant Start. Total Harmonic Distortion < 10%. Standard Ballast Factor .86 - .88HB8_H=T8 Electronic Instant Start. Total Harmonic Distortion < 10%. High Ballast Factor 1.15 - 1.20HB8_L=T8 Electronic Instant Start. Total Harmonic Distortion < 10%. Low Ballast Factor .77 - .82HB8_N=T8 Electronic Instant Start. Total Harmonic Distortion < 10%. Normal Ballast Factor 1.0HR8_{T8}=T8 Electronic Program Rapid Start. Total Harmonic Distortion < 10%. Standard Ballast Factor .86 - .88HR8_{DIM}=T8 Electronic Program Rapid Start. Total Harmonic Distortion < 10%. Step Dimming, Ballast Factor .88HR8_H=T8 Electronic Program Rapid Start. Total Harmonic Distortion < 10%. High Ballast Factor 1.15 - 1.20HR8_L=T8 Electronic Program Rapid Start. Total Harmonic Distortion < 10%. Low Ballast Factor .71 - .79

Number of Ballasts	Options	Packaging	Accessories (Order Separately)
1=1 Ballast 2=2 Ballasts	RLS=Rotor-Lock Socket (T8 Lamps Only - Standard on T5)	U=Unit Pack	A1B/Spacer-U=Spacer 1-1/2" to 2-1/2" from ceiling (Use 2 Per Fixture) AYC/Chain/Set-U=Chain Hanger (Use 2 Per Fixture) CR-WALLKIT=Wall Mount Accessory GRP-SS-U=Gripper Hanger (1-1/2" Spacing) (Use 2 Per Fixture) SCA=Adjustable 48" Stem Set SCF=Fixed Stem Set (Specify Length) SCS=Swivel Stem Set (Specify Length)

NOTES: 1. Length of fixture (2' or 4') determined by lamp wattage chosen. 2. Products also available in non-US voltage and frequencies for international markets. 3. Not available when specifying emergencies, voltage must be specified. 4. 1-Lamp ballast in a High Ballast factor not available. 5. .90 ballast factor available for 2 or 3 14W T5 or 28W T5 lamps only. 6. 1-Lamp step dimming ballast in a Normal Ballast factor not available. 2-Lamp ballast will not operate 1-Lamp.

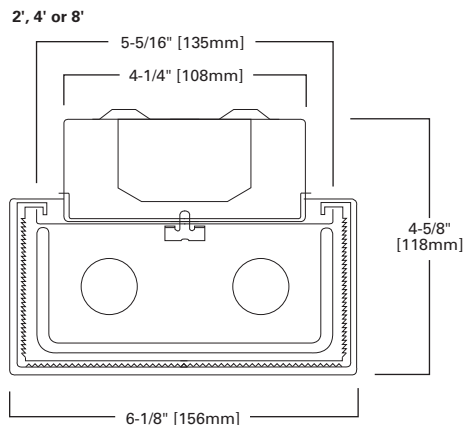
Specifications and dimensions subject to change without notice. Consult your Cooper Lighting Representative or visit www.cooperlighting.com for available options, accessories and ordering information.

FEATURES

- 100% clear acrylic prismatic lens provide excellent illumination
- Lift-and-shift lens offers easy re-lamping
- Ends formed with housing for strength and row alignment
- Commercial or residential electronic ballast
- Rotorlock lampholders enable easy lamp engagement
- Embossed steel end plates with 7/8" knockout
- Ideal for commercial and residential applications

DIMENSIONS

2', 4', 8'

Compliances may not apply to all product configurations. Please consult the product spec sheet for compliance details.

COMPLIANCES: UL/cUL Listed - Damp Location, ENERGY STAR Qualified



WN SERIES



ORDERING INFORMATION

SAMPLE NUMBER: WN-332A-UNV-EB81-U

Length	Series ¹	Number of Lamps(Not Included) ^{2,3}	Wattage	Lens	Voltage ⁵	Options	
8T=8' (Tandem) [Blank]=2' or 4' Length	WN=Commercial Surface Wraparound	2=2 Lamps 3=3 Lamps 4=4 Lamps	14T5=14W T5 (24") 17=17W T8 (24") 24T5=24W T5HO (24")	28T5=28W T5 (48") 28T8=28W T8 (48") ⁴ 32=32W T8 (48") (24") 54T5=54W T5HO (48")	A=Acrylic Refractor Lens	120V=120 Volt 277V=277 Volt 347V=347 Volt UNV=Universal Voltage 120-277 ⁶	EL=Emergency Installed (Must Specify Battery Pack, See Options) GL=Single Element Fuse GM=Double Element Fuse PI/CPI=Plug-In Option TILW=Tandem Inline Wiring

Ballast Type⁷

T5 Ballasts

EBT=T5 or T5HO Electronic Program Rapid Start. Total Harmonic Distortion < 10%.
Standard Ballast Factor=1.0

Ballast/Factor Type (T5)

EBT_H=T5 Electronic Program Rapid Start. Total Harmonic Distortion < 10%.
High Ballast Factor=1.15¹⁰

EBT_HDIM=T5 Electronic Program Rapid Start. Total Harmonic Distortion < 10%.
Step Dimming, High Ballast Factor = 1.15

EBT_N=T5 Electronic Program Rapid Start. Total Harmonic Distortion < 10%.
Normal Ballast Factor=.90¹¹

EBT_NDIM=T5 Electronic Program Rapid Start. Total Harmonic Distortion < 10%.
Step Dimming, Normal Ballast Factor=.95-1.0¹²

Ballast/Factor Type (For 14W T5 and 28W T5 Lamp Only)

[Blank]=Standard T5HO Ballast

H=High Light Output 1.15 BF

HDIM=High 1.15 BF Step Dimming⁸

N=Normal Light Output .95 BF

NDIM=Normal .95-1.0 BF Step Dimming⁹

T8 Ballasts

EB8=T8 Electronic Start. Total Harmonic Distortion < 10%.

EB8_PLUS=T8 Electronic Start. Total Harmonic Distortion < 10%.
High Ballast Factor > 1.15.

ER8=T8 Electronic Program Rapid Start. Total Harmonic Distortion < 10%.

REB1=T8 Electronic Instant Start Residential Ballast

High Performance T8 Ballasts

HB8=T8 Electronic Instant Start. Total Harmonic Distortion < 10%. Standard Ballast Factor .86-.88

HB8_H=T8 Electronic Instant Start. Total Harmonic Distortion < 10%. High Ballast Factor 1.15-1.20

HB8_L=T8 Electronic Instant Start. Total Harmonic Distortion < 10%. Low Ballast Factor .77-.82

HB8_N=T8 Electronic Instant Start. Total Harmonic Distortion < 10%. Normal Ballast Factor 1.0

HR8=T8 Electronic Program Rapid Start. Total Harmonic Distortion < 10%. Standard Ballast Factor .86-.88

HR8_DIM=T8 Electronic Program Rapid Start. Total Harmonic Distortion < 10%. Step Dimming. Ballast Factor .88

HR8_H=T8 Electronic Program Rapid Start. Total Harmonic Distortion < 10%. High Ballast Factor 1.15-1.20

HR8_L=T8 Electronic Program Rapid Start. Total Harmonic Distortion < 10%. Low Ballast Factor .71-.79

Number of Ballasts	Options	Packaging	Accessories (Order Separately)
1=1 Ballast 2=2 Ballasts	CRA=Continuous Row Aligner DEC=Decorative End Cap	4B=4 Bulk Packing (48" and 96") U=Unit Pack	SCA=Adjustable 48" Stem Set SCF=Fixed Stem Set (Specify Length) SCS=Swivel Stem Set (Specify Length) WN-2LT-DEC-ENDS=Decorative End Caps - 2 Lamps (2 Pieces) WN-4LT-DEC-ENDS=Decorative End Caps - 3 or 4 Lamps (2 Pieces) WN-CRA=Continuous Row Aligner (24 Pieces)

NOTES: 1. Steel endplates with 7/8" KO standard for continuous row mounting. 2. 2 point suspension recommended for 2 and 4 lamp models. 3 point suspension recommended for 8 foot tandems. 3. Suspension mounting not recommended for 3 lamp models. 4. HPT8 Ballast required with 28W T8 lamps. 5. Products also available in non-US voltage and frequencies for international markets. 6. Not available when specifying emergencies, voltage must be specified. 7. 2 ballasts are required when specifying 3 or more 28T5 lamps. 8. 1-Lamp ballast in high ballast factor is not available. 9. 1 Lamp step dimming ballast in normal ballast factor not available. 2-lamp ballast will not operate 1 lamp. 10. 1-Lamp ballast in a High Ballast factor not available. 11. .90 ballast factor available for 2 or 3 14W T5 or 28W T5 lamps only. 12. 1-Lamp step dimming ballast in a Normal Ballast factor not available. 2-Lamp ballast will not operate 1-Lamp.

2', 4' or 8', 2 LAMP

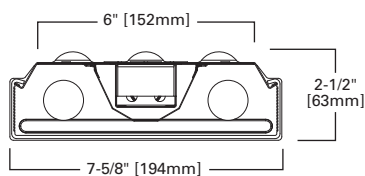

4', 3 LAMP

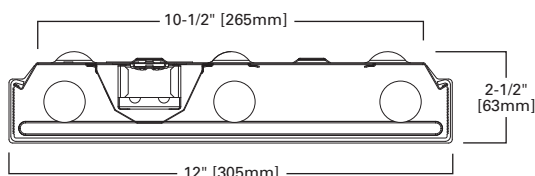

4', 4 LAMP

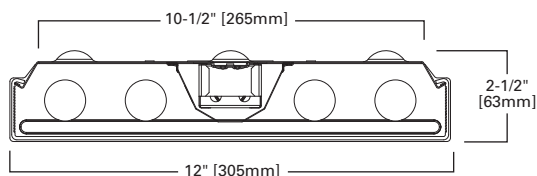

Specifications and dimensions subject to change without notice. Consult your Cooper Lighting Representative or visit www.cooperlighting.com for available options, accessories and ordering information.

SURFACE WRAPAROUND SPECIFICATION GRADE



FEATURES

- Specification wraparound for commercial, school and dormitory spaces
- Steel end plates with 7/8" knockout and light seal embossment
- Ballasts are CBM/ETL Class P and are positively secured to housing
- Multi-stage, iron phosphate pretreatment ensures maximum bonding
- Pressure lock lamp holders, UL and cUL listed
- 100% clear, full-thickness virgin acrylic prismatic refractor
- Internal side linear and bottom pyramidal prisms in lens
- Ballast cover easily removed without tools
- Lens can be hinged from either side in a lift

DIMENSIONS

2', 4', 8'

WS SERIES

Compliances may not apply to all product configurations. Please consult the product spec sheet for compliance details.

COMPLIANCES: UL/cUL Listed, UL/cUL Listed - Damp Location



ORDERING INFORMATION

SAMPLE NUMBER: WS-332A-120V-EB81-U

Tandem	Series ¹	Width	Number of Lamps (Not Included)	Wattage	Lens	Voltage ⁵
8T=8' Length [Blank]=4' Length	WS=Specification Surface Wrap	[Blank]=Standard A=Wide Body for 2 Lamps	2=2 Lamps ² 3=3 Lamps ³ 4=4 Lamps ²	14T5=14W T5 (24") 17=17W T8 (24") 24T5=24W T5HO (24") ⁴ 28T5=28W T5 (48") 32=32W T8 (48") 54T5=54W T5HO (48") ⁴	A=Acrylic Refractor Lens	120V=120 Volt 277V=277 Volt 347V=347 Volt UNV=Universal Voltage 120-277 ⁶
Options		Ballast Type			Number of Ballasts	
EL=Emergency Installed ⁷ GL=Single Element Fuse GM=Double Element Fuse		T5 Ballasts EBT=T5 or T5HO Electronic Program Rapid Start. Total Harmonic Distortion < 10%. Standard Ballast Factor=1.0 Ballast/Factor Type (T5) EBT_H=T5 Electronic Program Rapid Start. Total Harmonic Distortion < 10%. High Ballast Factor=1.15 ⁹ EBT_HDIM=T5 Electronic Program Rapid Start. Total Harmonic Distortion < 10%. Step Dimming, High Ballast Factor = 1.15 ¹⁰ EBT_N=T5 Electronic Program Rapid Start. Total Harmonic Distortion < 10%. Normal Ballast Factor=.90 ⁹ EBT_NDIM=T5 Electronic Program Rapid Start. Total Harmonic Distortion < 10%. Step Dimming, Normal Ballast Factor=.95-1.0 ¹¹ T8 Ballasts EB8=T8 Electronic Start. Total Harmonic Distortion < 10%. EB8_/PLUS=T8 Electronic Start. Total Harmonic Distortion < 10%. High Ballast Factor > 1.15. ER8=T8 Electronic Program Rapid Start. Total Harmonic Distortion < 10%. High Performance T8 Ballasts HB8=T8 Electronic Instant Start. Total Harmonic Distortion < 10%. Standard Ballast Factor .86-.88 HB8_H=T8 Electronic Instant Start. Total Harmonic Distortion < 10%. High Ballast Factor 1.15-1.20 HB8_L=T8 Electronic Instant Start. Total Harmonic Distortion < 10%. Low Ballast Factor .77-.82 HB8_N=T8 Electronic Instant Start. Total Harmonic Distortion < 10%. Normal Ballast Factor 1.0 HR8=T8 Electronic Program Rapid Start. Total Harmonic Distortion < 10%. Standard Ballast Factor .86-.88 HR8_DIM=T8 Electronic Program Rapid Start. Total Harmonic Distortion < 10%. Step Dimming, Ballast Factor .88 HR8_H=T8 Electronic Program Rapid Start. Total Harmonic Distortion < 10%. High Ballast Factor 1.15-1.20 HR8_L=T8 Electronic Program Rapid Start. Total Harmonic Distortion < 10%. Low Ballast Factor .71-.79			1=1 Ballast 2=2 Ballasts 3=3 Ballasts	
Options		Packaging	Accessories (Order Separately)			
PI/CPI=Plug-In Option RIF1=Radio Interference Suppressor RLS=Rotor-Lock Socket (T8 Lamps Only) TILW=Tandem Inline Wiring		U=Unit Pack	A1B/Spacer-U=Spacer 1-1/2" to 2-1/2" from ceiling (Use 2 Per Fixture) SCA=Adjustable 48" Stem Set SCF=Fixed Stem Set (Specify Length) SCS=Swivel Stem Set (Specify Length)			

NOTES: 1. Steel endplates with 7/8" KO standard for continuous row mounting. 2. 2 point suspension recommended for 2 and 4 lamp fixtures. 3. Stem Mounting not available on 3-lamp fixtures. 4. Not for temperatures that exceed 40°C (102°F). 5. Products also available in non-US voltage and frequencies for international markets. 6. Not available when specifying emergencies, voltage must be specified. 7. Not available for 2' version. 8. .90 ballast factor available for 2 or 3 14W T5 or 28W T5 lamps only. 9. 1-Lamp ballast in a High Ballast factor not available. 10. Step Dimming ballast available for 2 or 3 14WT5 or 28W T5 lamps only. 11. 1-Lamp step dimming ballast in a Normal Ballast factor not available. 2-Lamp ballast will not operate 1-Lamp.

2', 4' or 8', 2 LAMP

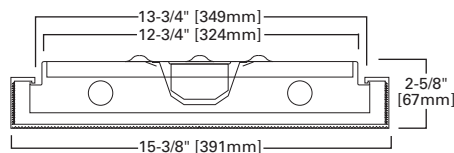

4' or 8', 3 LAMP

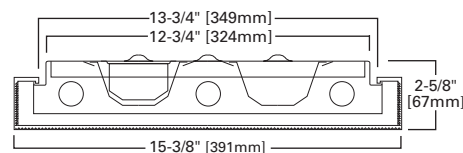

2', 4' or 8', 4 LAMP

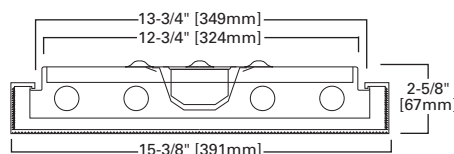

2', 4' or 8', 2 LAMP LTS or HTS

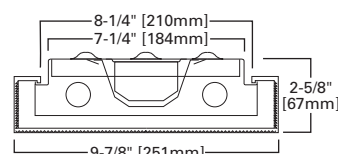
Specifications and dimensions subject to change without notice. Consult your Cooper Lighting Representative or visit www.cooperlighting.com for available options, accessories and ordering information.

FEATURES

- Acrylic lens formulated to protect against lens breakage
- Tuff'R'Puff commercial-grade acrylic lens
- 120V instant-start residential or commercial ballast
- Housing manufactured with die-formed, cold-rolled steel
- Snap-fit for ease of service and re-lamping
- Ideal choice for most residential and commercial applications
- Lamps not included

DIMENSIONS

1' x 4', 1-1/2' x 4'

Compliances may not apply to all product configurations. Please consult the product spec sheet for compliance details.

COMPLIANCES: UL/cUL Listed - Damp Location, ENERGY STAR Qualified



WSC SERIES



ORDERING INFORMATION

SAMPLE NUMBER: WSC-232-D-W-UNV-EB81-U

Series	Number of Lamps	Wattage (Length)	Diffuser/Lens	Frame Finish	Voltage ¹	Options	
WSC=Softside Cloud	2=2 Lamps 4=4 Lamps	32=32W T8 (48") U6T8=32W T8 ("24")	D=Dropped	W=White	120V=120 Volt 277V=277 Volt 347V=347 Volt UNV=Universal Voltage 120-277 ²	EL=Emergency Installed ^{3,4} GL=Single Element Fuse GM=Double Element Fuse	
Ballast Type					Number of Ballast	Options	Packaging
T8 Ballasts EB8_=T8 Electronic Start. Total Harmonic Distortion < 10%. EB8_/PLUS=T8 Electronic Start. Total Harmonic Distortion < 10%. High Ballast Factor > 1.15 ER8_=T8 Electronic Program Rapid Start. Total Harmonic Distortion < 10%. High Performance T8 Ballasts HB8_=T8 Electronic Instant Start. Total Harmonic Distortion < 10%. Standard Ballast Factor = .86 - .88 HB8_H=T8 Electronic Instant Start. Total Harmonic Distortion < 10%. Normal Ballast Factor = 1.15 - 1.20 HB8_L=T8 Electronic Instant Start. Total Harmonic Distortion < 10%. Low Ballast Factor = .77 - .82 HB8_N=T8 Electronic Instant Start. Total Harmonic Distortion < 10%. Normal Ballast Factor = 1.0 HR8_=T8 Electronic Program Rapid Start. Total Harmonic Distortion < 10%. Standard Ballast Factor = .86 - .88 HR8_DIM=T8 Electronic Program Rapid Start. Total Harmonic Distortion < 10%. Step Dimming. Ballast Factor = .88 HR8_H=T8 Electronic Program Rapid Start. Total Harmonic Distortion < 10%. High Ballast Factor = 1.15 - 1.20 HR8_L=T8 Electronic Program Rapid Start. Total Harmonic Distortion < 10%. Low Ballast Factor = .71 - .79					1=1 Ballast 2=2 Ballasts	See Options Section	U=Unit Pack

NOTES: 1. Products also available in non-US voltage and frequencies for international markets. 2. Not available when specifying emergencies, voltage must be specified. 3. Not available for 2' units. 4. A low profile battery pack is required for installation with standard ballast cover (consult Cooper Lighting).

1' x 4', 2 LAMP

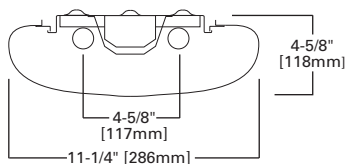

1-1/2' x 4', 4 LAMP

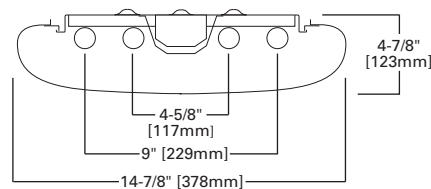

2' x 2', 2 U-LAMPS

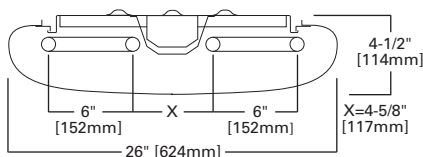

COMMITMENT KIT (CKIT) ACCESSORY



Description

The Contractor Commitment Kit is a supplementary offering intended as an aid for installation and maintenance of Metalux fluorescent fixtures. The kit is comprised of several common lighting accessories to provide the contractor with increased value and convenience. Kit contents include fluorescent lampholders, lamp clips, screws, fasteners and disconnects.

CKIT

KIT CONTENTS

Component Type	Description	Quantity
Access Plate	ACCESS PLATE WITH GRD SCREW	5
Clip	ALIGNER CLIP FOR DIM2/DMF	50
Clip	ALIGNER CLIP FOR IA/IC OR IAF/ICF	50
Clip	LENS FRAME CLIP	50
Disconnect	QUICK DISC 1 CIRCUIT / 2 PORT	25
Fastener	1/4 TURN FASTENER (PLATED)	50
Fastener	SSF/SNF 1/4 TURN FASTNER (PLATED)	100
Hardware	#6 X 3/4 PHILIPS FLAT HEAD, TYPE AB	100
Hardware	#6 X 3/8 PHILIPS FLAT HEAD, TYPE A	100
Hardware	#8 X 1/4 HEX HEAD SLOTTED, TYPE B	100
Hardware	#8-18 X 3/8 SLOTTED HEX HEAD WITH WASHER, TYPE AB, WHITE	100
Hardware	#8-32 X 1/4 SLOT HEAD FOR BALLAST	50
Hardware	#8-32 X 7/16 PHILIPS ROUND HEAD	100
LampHolder	SOCKET RAPID START T5 FEMALE, T8 BASE	10
LampHolder	SOCKET RAPID START T5 MALE, T8 BASE	10
LampHolder	SOCKET RAPID START T5 SHORT WITH NIB	20
LampHolder	SOCKET RAPID START T5 TALL, PIN BASE, SNAP-IN	16
LampHolder	SOCKET T8 INSTANT START FOR HBI, ROTO-LOCK WITH NIB	10
LampHolder	SOCKET T8 INSTANT START MED. ROTO-LOCK WITH NIB	10
LampHolder	SOCKET T8 RAPID START ROTO-LOCK SHORT WITH NIB	10
LampHolder	SOCKET T8 RAPID START MED. ROTO-LOCK WITH NIB	10
L-Clip	LAMP CLIP FOR HORIZONTAL BIAX/PL-L	15
L-Clip	LAMP CLIP FOR VERTICAL BIAX/PL-L LAMP	15
L-Clip	T8 U-LAMP CLIP - STRAIGHT	20
L-Clip	U LAMP CLAMP (LONG) ADJUSTABLE	15

ORDERING INFORMATION

SAMPLE NUMBER: COMMITMENT KIT

COMMITMENT KIT

Customer Commitment Kit

PRODUCT INFORMATION FOR LOUVERS

Brand	Catalog Logic	Size	Description	GC	GC8	GC8FA/RA	GR8/GR5	GCAFA/RA	M/MC ²
Generic	PB1S	1/2" x 1/2" x 1/2" ¹	Small Cell Parabolic, Silver, Styrene	X	X	X	X	X	X
	PB1SA	1/2" x 1/2" x 1/2" ¹	Small Cell Parabolic, Silver, Acrylic	X	X	X	X	X	X
	PB2S	1-1/2" x 1-1/2" x 1"	Medium Cell Parabolic, Silver, Styrene	X	X	X		X	X
	PB2SA	1-1/2" x 1-1/2" x 1"	Medium Cell Parabolic, Silver, Acrylic	X	X	X		X	X
	PB3S	3/4" x 3/4" x 1/2"	Enhanced Efficiency Parabolic, Silver, Styrene	X	X	X		X	X
	PB3SA	3/4" x 3/4" x 1/2"	Enhanced Efficiency Parabolic, Silver, Acrylic	X	X	X		X	X
	PB4S	3" x 3" x 1-1/2"	Large Cell Parabolic, Silver, Styrene	X	X	X		X	X
	PB4SA	3" x 3" x 1-1/2"	Large Cell Parabolic, Silver, Acrylic	X	X	X		X	X
	PB5S	3/4" x 3/4" x 3/8"	High Efficiency Controlled Louver, Silver, Styrene	X	X	X		X	X
	PB5SA	3/4" x 3/4" x 3/8"	High Efficiency Controlled Louver, Silver, Acrylic	X	X	X		X	X
	PL	1/2" x 1/2" x 1/2"	Straight Blade White Louver, Styrene	X	X	X		X	X
	PLA	1/2" x 1/2" x 1/2"	Straight Blade White Louver, Acrylic	X	X	X		X	X
	AL	1/2" x 1/2" x 1/2"	Straight Blade, Mill Finish, Aluminum Louver	X		X		X	X
	ALW	1/2" x 1/2" x 1/2"	Straight Blade, White, Aluminum Louver	X		X		X	X

NOTES: 1. Dimensions are nominal size. 2. For 3-lamp or SMB housing, 1/2" or less shielding thickness only.

PRODUCT INFORMATION FOR LENS³

Brand	Lens	Thickness	GC	GC8	GC8FA/RA	GR8/GR5	GCAFA/RA	M/MC
Generic	A	0.095	X	X	X	X	X	X
	A125	0.125	X	X	X	X	X	X
	AT125	0.125	X	X	X	X	X	X
	A125MIN	.125 min	X	X	X	X	X	X
	AT125MIN	.125 min	X	X	X	X	X	X
	A125/RFI	0.125	X	X	X	X	X	X
	A19/156	0.156	X	X	X	X	X	X
	A19T/156	0.156	X	X	X	X	X	X
	A19/156RFI	0.156	X	X	X	X	X	X
	A12/170	0.170	X				X	X
	A19/187	0.187	X				X	X
	A12/187	0.187	X				X	X
	DA	0.080	X	X	X			X
	DA125	0.125	X	X	X			X
	K12/125	0.125	X	X	X		X	X
	K12/125MIN	.125 min	X	X	X		X	X
	POLY12/125	0.125	X	X	X		X	X
	POLY12/187	0.187	X				X	X
KSH	ACTF140	0.140	X	X	X		X	X
	ACTF187	0.187	X				X	X
	FGW080	0.080	X	X	X		X	X
	FGW125	0.125	X	X	X		X	X
	K12/125	0.125	X	X	X		X	X
	K12/125MIN	.125 min	X	X	X		X	X
	K12/125RFI	0.125	X	X	X		X	X
	A15	0.200	X				X	X
	A19/156	0.156	X	X	X	X	X	X
	A19T/156	0.156	X	X	X		X	X
	A19/156RFI	0.156	X	X	X		X	X
	K12/187	0.187	X				X	X
	A19/187	0.187	X				X	X
	KSH20/140	0.140	X	X	X		X	X
	KSH23/125	0.125	X	X	X		X	X
	KSH3E	0.150	X	X	X		X	X
KSH32	0.130	X	X	X		X	X	
PSI	PSA4/RFI	variable	X				X	X
	P35	0.170	X				X	X

NOTES: Inverted Lens - For inverted lens add "INV" to lens description. (Not available for GR8/GR5). 3. For additional lens options consult factory.

Specifications and dimensions subject to change without notice. Consult your Cooper Lighting Representative or visit www.cooperlighting.com for available options, accessories and ordering information.

GR8, GC8, GC SERIES - NON-FLOATING DOOR ASSEMBLIES

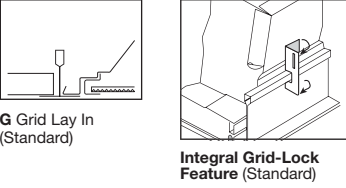
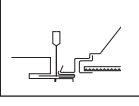
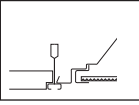
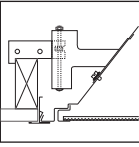
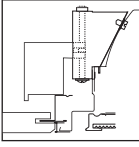
Type "G" Fixture																													
<p>(Exposed Grid)</p>  <p>G Grid Lay In (Standard)</p> <p>Integral Grid-Lock Feature (Standard)</p>	<p>A Recessed Luminaire with Narrow Flanges designed to rest on exposed 15/16" or 9/16" wide Inverted Grid Tees.</p> <ul style="list-style-type: none"> Fixture Example: 2GR8-432-UNV-EB81-U 																												
<p>(Concealed T)</p>  <p>G Concealed T</p>	<p>A Recessed Luminaire with Narrow Flanges designed to rest on 15/16" wide Concealed Inverted Grid Tees</p> <ul style="list-style-type: none"> Fixture Example 2EP3GAX-332S36I Optional Aluminum TK Trim Kit Available Available TK Trim Finishes: Natural Anodized Aluminum (N) Standard and Baked White Enamel (W) <table border="1" data-bbox="1223 430 1510 556"> <thead> <tr> <th colspan="2">TK TRIM KIT</th> </tr> </thead> <tbody> <tr> <td>TK-14N-U</td> <td>1' x 4'</td> </tr> <tr> <td>TK-22N-U</td> <td>2' x 2'</td> </tr> <tr> <td>TK-24N-U</td> <td>2' x 4'</td> </tr> </tbody> </table>	TK TRIM KIT		TK-14N-U	1' x 4'	TK-22N-U	2' x 2'	TK-24N-U	2' x 4'																				
TK TRIM KIT																													
TK-14N-U	1' x 4'																												
TK-22N-U	2' x 2'																												
TK-24N-U	2' x 4'																												
<p>(Slot Grid)</p>  <p>G Slot Grid</p>	<p>A Recessed Luminaire designed to rest on 9/16" Slot T Grid</p> <ul style="list-style-type: none"> Fixture Example: 2GR8-432 T-Bar Safety Clips Required 																												
Type "F" Fixture																													
<p>(Flange Trim)</p>  <p>F Flange Trim</p>	<p>For factory installed flange, replace "G" in fixture trim description with "F". Factory installed flange available on GC8 and GC only, field installed kits are available for all other models and are listed below.</p> <p>A Recessed Luminaire with Horizontal Steel or Aluminum (A) Flanges which conceal the edges of the ceiling opening</p> <ul style="list-style-type: none"> Fixture example 2FC8-332 Adjustable Swing Gates for mounting Optional Flange Kit available Field Convertible, Converts Grid Fixture (G) to Flange Fixture (F) Standard Flange Trim Finish: Baked White Enamel (W) Typical fixture ceiling opening requirements: Single – (Width) One-quarter Inch (1/4") plus nominal width, (Length) 1/4" plus nominal length. Rows - fixture quantity times fixture length plus 1/4". Plaster Frames available, see options and accessories section <p>FLANGE KITS (Field Installed)</p> <table border="1" data-bbox="564 1207 1510 1449"> <thead> <tr> <th>Fixture</th> <th>Fixture Size</th> <th>Flange Kit</th> <th>Ceiling Opening Size</th> </tr> </thead> <tbody> <tr> <td>GR8/GC8/GR5</td> <td>1' x 4'</td> <td>FCS-14W-U (Steel)</td> <td>12-1/4" x 48-1/4"</td> </tr> <tr> <td>GC</td> <td>1' x 4'</td> <td>F2-14W-U (Steel)</td> <td>12-1/4" x 48-1/4"</td> </tr> <tr> <td>GC</td> <td>20" x 24"</td> <td>F2-2024W-U (Steel)</td> <td>20-1/4" x 24-1/4"</td> </tr> <tr> <td>GR8/GC8/GR5</td> <td>2' x 2'</td> <td>FCTKA-22W-U</td> <td>24-1/4" x 24-1/4"</td> </tr> <tr> <td>GC</td> <td>20" x 48"</td> <td>F2-28W-U (Steel)</td> <td>20-1/4" x 48-1/4"</td> </tr> <tr> <td>GR8/GC8/GR5</td> <td>2' x 4'</td> <td>FCTKA-24W-U</td> <td>24-1/4" x 48-1/4"</td> </tr> </tbody> </table>	Fixture	Fixture Size	Flange Kit	Ceiling Opening Size	GR8/GC8/GR5	1' x 4'	FCS-14W-U (Steel)	12-1/4" x 48-1/4"	GC	1' x 4'	F2-14W-U (Steel)	12-1/4" x 48-1/4"	GC	20" x 24"	F2-2024W-U (Steel)	20-1/4" x 24-1/4"	GR8/GC8/GR5	2' x 2'	FCTKA-22W-U	24-1/4" x 24-1/4"	GC	20" x 48"	F2-28W-U (Steel)	20-1/4" x 48-1/4"	GR8/GC8/GR5	2' x 4'	FCTKA-24W-U	24-1/4" x 48-1/4"
Fixture	Fixture Size	Flange Kit	Ceiling Opening Size																										
GR8/GC8/GR5	1' x 4'	FCS-14W-U (Steel)	12-1/4" x 48-1/4"																										
GC	1' x 4'	F2-14W-U (Steel)	12-1/4" x 48-1/4"																										
GC	20" x 24"	F2-2024W-U (Steel)	20-1/4" x 24-1/4"																										
GR8/GC8/GR5	2' x 2'	FCTKA-22W-U	24-1/4" x 24-1/4"																										
GC	20" x 48"	F2-28W-U (Steel)	20-1/4" x 48-1/4"																										
GR8/GC8/GR5	2' x 4'	FCTKA-24W-U	24-1/4" x 48-1/4"																										
Type "MZ" Fixture (GC Only)																													
<p>(Modular Trim / Aluminum)</p>  <p>MZ Modular Trim / Aluminum</p> <p>Concealed "T" Metal Pan and Concealed "Z" Spline Application</p>	<p>A Recessed Luminaire Trimmed to a Modular / Concealed Finished Dimension</p> <ul style="list-style-type: none"> Fixture example: 2MZC-332 (complete fixture / factory installed trim) On complete ordered fixture, Modular MZ Trim matches door frame assembly unless otherwise specified Adjustable Swing Gates for mounting Optional Aluminum Modular (MZ) Trim Kit available Field Convertible, converts Grid Fixture (G) to Modular Fixture (MZ) Available Aluminum Trim Finishes: Baked White Enamel (W) and Natural Anodized Aluminum (N) For Concealed "T" and Concealed "Z" the main ceiling carries must be on the sides of the Luminaire. The weight of the Luminaire exists on the Swing-Gates and must be supported by main carriers, not cross members. At each end of the luminaire, an Angle Spline must be used, Cross or Main T's cannot be used. <table border="1" data-bbox="1223 1543 1510 1732"> <thead> <tr> <th colspan="2">MODULAR / MZ TRIM KIT / ALUMINUM</th> </tr> </thead> <tbody> <tr> <td>F2MZ/E-14W-U</td> <td>1' x 4'</td> </tr> <tr> <td>F2MZ/E-22W-U</td> <td>2' x 2'</td> </tr> <tr> <td>F2MZ/E-24W-U</td> <td>2' x 4'</td> </tr> <tr> <td>F2MZ/E-28W-U</td> <td>20" x 48"</td> </tr> </tbody> </table>	MODULAR / MZ TRIM KIT / ALUMINUM		F2MZ/E-14W-U	1' x 4'	F2MZ/E-22W-U	2' x 2'	F2MZ/E-24W-U	2' x 4'	F2MZ/E-28W-U	20" x 48"																		
MODULAR / MZ TRIM KIT / ALUMINUM																													
F2MZ/E-14W-U	1' x 4'																												
F2MZ/E-22W-U	2' x 2'																												
F2MZ/E-24W-U	2' x 4'																												
F2MZ/E-28W-U	20" x 48"																												

Specifications and dimensions subject to change without notice. Consult your Cooper Lighting Representative or visit www.cooperlighting.com for available options, accessories and ordering information.

PARALUX II, III, IV, V SERIES – FLOATING LOUVER ASSEMBLIES

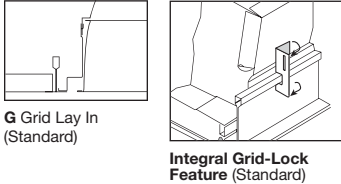
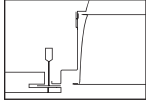
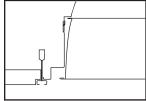
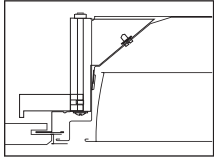
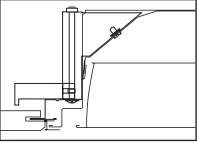
Type "G" Fixture																																																	
<p>(Exposed Grid)</p>  <p>G Grid Lay In (Standard)</p> <p>Integral Grid-Lock Feature (Standard)</p>	<p>A Recessed Luminaire with Narrow Flanges designed to rest on exposed 15/16" or 9/16" wide Inverted Grid Tees.</p> <ul style="list-style-type: none"> • Fixture example: 2P2GX-332S36I 																																																
<p>(Concealed T)</p>  <p>T Concealed T</p>	<p>A Recessed Luminaire with Narrow Flanges designed to rest on 15/16" wide Concealed Inverted Grid Tees</p> <ul style="list-style-type: none"> • Fixture Example 2EP3GX-332S36I • Optional TK Trim Kit available – Available TK trim finishes: Natural Anodized Aluminum (N) standard and Baked White Enamel (W) <table border="1" data-bbox="1263 432 1545 562"> <thead> <tr> <th colspan="2">TK TRIM KIT</th> </tr> </thead> <tbody> <tr> <td>TK-14N-U</td> <td>1' x 4'</td> </tr> <tr> <td>TK-22N-U</td> <td>2' x 2'</td> </tr> <tr> <td>TK-24N-U</td> <td>2' x 4'</td> </tr> </tbody> </table>	TK TRIM KIT		TK-14N-U	1' x 4'	TK-22N-U	2' x 2'	TK-24N-U	2' x 4'																																								
TK TRIM KIT																																																	
TK-14N-U	1' x 4'																																																
TK-22N-U	2' x 2'																																																
TK-24N-U	2' x 4'																																																
<p>(Slot Grid)</p>  <p>G Slot Grid</p>	<p>A Recessed Luminaire designed to rest on 9/16" Slot-T Grid</p> <ul style="list-style-type: none"> • Fixture example: 2EP3GAX-332S36I • T-Bar Safety Clips required • Face of luminaire/door assembly is recessed about 5/16" into ceiling 																																																
Type "F" Fixture																																																	
<p>(Flange)</p>  <p>F Aluminum Flange Trim with Supporting Swing Gates</p>	<p>A Recessed Luminaire with Horizontal Steel or Mitered Aluminum (M) Flanges which conceal the edges of the ceiling opening</p> <ul style="list-style-type: none"> • Complete fixture / factory installed trim. Fixture example: 2EP3FX-332S36I • Adjustable Swing Gates for mounting • Field installed Flange Kit available – Field Convertible, Converts Grid Fixture (G) to Flange Fixture (F) – Standard Flange Trim finish: Baked White Enamel (W) • Typical fixture ceiling opening requirements: Single – (Width) One-quarter Inch (1/4") plus nominal width, (length) 1/4" plus nominal length. • Rows - fixture quantity times fixture length plus 1/4". • Plaster frames available, see options and accessories section <p>FLANGE KITS (Steel) (Field Installed)</p> <table border="1" data-bbox="571 1050 1576 1461"> <thead> <tr> <th>Fixture</th> <th>Fixture Size</th> <th>Flange Kit</th> <th>Ceiling Opening Size</th> </tr> </thead> <tbody> <tr> <td>EP3, P4, P5</td> <td>1' x 2'</td> <td>F3/4-12W-U (steel)</td> <td>12-1/4" x 24-1/4"</td> </tr> <tr> <td>EP3, P4, P5</td> <td>1' x 4'</td> <td>F3/4M-14W-U</td> <td>12-1/4" x 48-1/4"</td> </tr> <tr> <td>P2</td> <td>1' x 4'</td> <td>F2M-14S-W-U</td> <td>12-1/4" x 48-1/4"</td> </tr> <tr> <td>EP3, P4, P5</td> <td>20" x 24"</td> <td>F3/4-2024W-U (steel)</td> <td>20-1/4" x 24-1/4"</td> </tr> <tr> <td>P2</td> <td>20" x 24"</td> <td>F2-2024W-U (steel)</td> <td>20-1/4" x 24-1/4"</td> </tr> <tr> <td>P4, P5</td> <td>2' x 2'</td> <td>F4/5M-22S-W-U</td> <td>24-1/4" x 24-1/4"</td> </tr> <tr> <td>P2, EP3</td> <td>2' x 2'</td> <td>F2/3M-22S-W-U</td> <td>24-1/4" x 24-1/4"</td> </tr> <tr> <td>EP3, P4, P5</td> <td>20" x 48"</td> <td>F3/4-28W-U (steel)</td> <td>20-1/4" x 48-1/4"</td> </tr> <tr> <td>P2</td> <td>20" x 48"</td> <td>F2-28W-U (steel)</td> <td>20-1/4" x 48-1/4"</td> </tr> <tr> <td>P4, P5</td> <td>2' x 4'</td> <td>F4/5M-24S-W-U</td> <td>24-1/4" x 48-1/4"</td> </tr> <tr> <td>P2, EP3</td> <td>2' x 4'</td> <td>F2/3M-24S-W-U</td> <td>24-1/4" x 48-1/4"</td> </tr> </tbody> </table>	Fixture	Fixture Size	Flange Kit	Ceiling Opening Size	EP3, P4, P5	1' x 2'	F3/4-12W-U (steel)	12-1/4" x 24-1/4"	EP3, P4, P5	1' x 4'	F3/4M-14W-U	12-1/4" x 48-1/4"	P2	1' x 4'	F2M-14S-W-U	12-1/4" x 48-1/4"	EP3, P4, P5	20" x 24"	F3/4-2024W-U (steel)	20-1/4" x 24-1/4"	P2	20" x 24"	F2-2024W-U (steel)	20-1/4" x 24-1/4"	P4, P5	2' x 2'	F4/5M-22S-W-U	24-1/4" x 24-1/4"	P2, EP3	2' x 2'	F2/3M-22S-W-U	24-1/4" x 24-1/4"	EP3, P4, P5	20" x 48"	F3/4-28W-U (steel)	20-1/4" x 48-1/4"	P2	20" x 48"	F2-28W-U (steel)	20-1/4" x 48-1/4"	P4, P5	2' x 4'	F4/5M-24S-W-U	24-1/4" x 48-1/4"	P2, EP3	2' x 4'	F2/3M-24S-W-U	24-1/4" x 48-1/4"
Fixture	Fixture Size	Flange Kit	Ceiling Opening Size																																														
EP3, P4, P5	1' x 2'	F3/4-12W-U (steel)	12-1/4" x 24-1/4"																																														
EP3, P4, P5	1' x 4'	F3/4M-14W-U	12-1/4" x 48-1/4"																																														
P2	1' x 4'	F2M-14S-W-U	12-1/4" x 48-1/4"																																														
EP3, P4, P5	20" x 24"	F3/4-2024W-U (steel)	20-1/4" x 24-1/4"																																														
P2	20" x 24"	F2-2024W-U (steel)	20-1/4" x 24-1/4"																																														
P4, P5	2' x 2'	F4/5M-22S-W-U	24-1/4" x 24-1/4"																																														
P2, EP3	2' x 2'	F2/3M-22S-W-U	24-1/4" x 24-1/4"																																														
EP3, P4, P5	20" x 48"	F3/4-28W-U (steel)	20-1/4" x 48-1/4"																																														
P2	20" x 48"	F2-28W-U (steel)	20-1/4" x 48-1/4"																																														
P4, P5	2' x 4'	F4/5M-24S-W-U	24-1/4" x 48-1/4"																																														
P2, EP3	2' x 4'	F2/3M-24S-W-U	24-1/4" x 48-1/4"																																														
Type "MZ" (Fixture 2", 3", 4", 5" Parabolics)																																																	
<p>(Modular Trim / Aluminum)</p>  <p>MZ Modular Trim with Supporting Swing Gates</p> <p>Concealed "T" Metal Pan and Concealed "Z" Spline Application</p>	<p>A Recessed Luminaire trimmed to a Modular / Concealed finished dimension</p> <ul style="list-style-type: none"> • Complete fixture / factory installed trim. Fixture example: 2MZC-332S38I • On complete ordered fixture, Modular MZ Trim matches door frame assembly unless otherwise specified • Adjustable Swing Gates for mounting • Optional Aluminum Modular (MZ) Trim Kit available – Field Convertible, Converts Grid Fixture (G) to Modular Fixture (MZ) – Available Aluminum Trim Finishes: Baked White Enamel (W) and Natural Anodized Aluminum (N) • For Concealed "T" and Concealed "Z" the main ceiling carries must be on the sides of the Luminaire. The weight of the luminaire exists on the Swing-Gates and must be supported by main carriers, not cross members. At each end of the luminaire, an Angle Spline must be used, Cross or Main T's cannot be used. <p>MODULAR / MZ TRIM KIT / ALUMINUM</p> <table border="1" data-bbox="1102 1600 1555 1839"> <thead> <tr> <th>Fixture</th> <th>Flange Kit</th> <th>Fixture Size</th> </tr> </thead> <tbody> <tr> <td>EP3, P4, P5</td> <td>F3/4MZ-14W-U</td> <td>1' x 4'</td> </tr> <tr> <td>P2</td> <td>F2MZ-14-W-U</td> <td>1' x 4'</td> </tr> <tr> <td>P4, P5</td> <td>F4/5MZ/E-22W-U</td> <td>2' x 2'</td> </tr> <tr> <td>EP3, P2</td> <td>F2/3MZ/E-22W-U</td> <td>2' x 2'</td> </tr> <tr> <td>P4, P5</td> <td>F4/5MZ/E-24W-U</td> <td>2' x 4'</td> </tr> <tr> <td>EP3, P2</td> <td>F2/3MZ/E-24W-U</td> <td>2' x 4'</td> </tr> </tbody> </table>	Fixture	Flange Kit	Fixture Size	EP3, P4, P5	F3/4MZ-14W-U	1' x 4'	P2	F2MZ-14-W-U	1' x 4'	P4, P5	F4/5MZ/E-22W-U	2' x 2'	EP3, P2	F2/3MZ/E-22W-U	2' x 2'	P4, P5	F4/5MZ/E-24W-U	2' x 4'	EP3, P2	F2/3MZ/E-24W-U	2' x 4'																											
Fixture	Flange Kit	Fixture Size																																															
EP3, P4, P5	F3/4MZ-14W-U	1' x 4'																																															
P2	F2MZ-14-W-U	1' x 4'																																															
P4, P5	F4/5MZ/E-22W-U	2' x 2'																																															
EP3, P2	F2/3MZ/E-22W-U	2' x 2'																																															
P4, P5	F4/5MZ/E-24W-U	2' x 4'																																															
EP3, P2	F2/3MZ/E-24W-U	2' x 4'																																															

Specifications and dimensions subject to change without notice. Consult your Cooper Lighting Representative or visit www.cooperlighting.com for available options, accessories and ordering information.

DRYWALL FRAMING KIT (DF) SERIES



FEATURES

- Individual modular frame unit
- Nominal 1-1/2" frame depth
- Side and end rails of extruded aluminum
- Offset toleranced corner fasteners
- Painted after fabrication
- Available in satin anodized or baked white enamel finish
- Individual row mount with center mullion support (DFR Series)
- Uninterrupted continuous row (DFC Series). Available for RCC fixtures only
- DF, DFC and DFR Series add 3/16" to nominal width of fixture used. Add 1/4" to nominal length of each fixture used for DF and DFR, add 1/4" to total length of all fixtures for DFC.

DF SERIES

Description

The **DF Drywall Frame Kit Series** features a modular framing unit that will trim out an opening in a drywall ceiling. This opening will resemble a modular grid ceiling when installed. The kits are field assembled and installed into the drywall ceiling independent of the luminaire. The Drywall Frame Kit enables the contractor or end user to frame out a modular opening and install a choice of any standard modular recessed luminaire. The ease of installation feature makes the Framing Kit a good choice for the commercial, residential and architectural market.

The **DF Series** is available in all popular modular sizes to fit any lay-in fixture to include: 1' x 2', 2' x 4', 2' x 2', 1' x 4', 1' x 8', 20" x 24", 20" x 48", 10" x 2' and 10" x 4'.

The **DFR Series** is a modular framing unit for row mounting luminaires with a center mullion support for trimming out an opening in drywall ceilings. The DFR Series is available in all popular modular sizes to fit any lay-in fixture to include: 1' x 2', 2' x 4', 2' x 2', 1' x 4', 1' x 8', 20" x 24", 20" x 48", 10" x 2' and 10" x 4'.

The **DFC Series** is a continuous row uninterrupted modular framing unit with no Cross T supports. It is used for trimming out an opening in drywall ceilings to install continuous row luminaires. The DFC Series is available in Twelve Inch (12") widths. For continuous row RCC luminaires only.

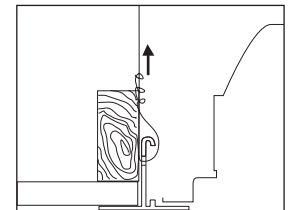

ORDERING INFORMATION

SAMPLE NUMBER: DF-102-W

Series	Application (Leave Blank For DF Series)	Width	Length	Finish
DF=Framing Kit DFR=Framing Kit Support/Center Mullion DFC=Framing Kit Continuous ¹	E=End of Row R=Middle of Row	10=Ten Inch (10") (Not Available on DFC Series) 1=One Foot (1') 20=Twenty Inches (20") (Not Available on DFC Series) 2=Two Feet (2') (Not Available on DFC Series) 4=Four Feet (4') (Not Available on DFC Series)	2=Two Feet (2' Nominal) 4=Four Feet (4' Nominal) 6=Six Feet (6' Nominal) 8=Eight Feet (8' Nominal)	N=Satin Anodized Aluminum W=Baked White Enamel

PRODUCT INFORMATION

Catalog Number	Nominal Luminaire Size (Inches)	Ceiling Opening Size (Inches) (Width x Length)
DF-12-W	1' x 2'	12-3/16" x 24-1/4"
DF-14-W	1' x 4'	12-3/16" x 48-1/4"
DF-18-W ²	1' x 8'	12-3/16" x 96-1/4"
DF-22-W	2' x 2'	24-3/16" x 24-1/4"
DF-24-W	2' x 4'	24-3/16" x 48-1/4"
DF-2024-W	20" x 24"	20-3/16" x 24-1/4"
DF-2048-W	20" x 48"	20-3/16" x 48-1/4"
DF-102-W ³	10" x 2'	10-3/16" x 24-1/4"
DF-104-W ³	10" x 4'	10-3/16" x 48-1/4"
DFR-12-W	1' x 2'	12-3/16" + 1/4" added to each fixture length
DFR-14-W	1' x 4'	12-3/16" + 1/4" added to each fixture length
DFR-18-W ²	1' x 8'	12-3/16" + 1/4" added to each fixture length
DFR-22-W	2' x 2'	24-3/16" + 1/4" added to each fixture length
DFR-24-W	2' x 4'	24-3/16" + 1/4" added to each fixture length
DFR-2024-W	20" x 24"	20-3/16" + 1/4" added to each fixture length
DFR-2048-W	20" x 48"	20-3/16" + 1/4" added to each fixture length
DFR-102-W ³	10" x 2'	10-3/16" + 1/4" added to each fixture length
DFR-104-W ³	10" x 4'	10-3/16" + 1/4" added to each fixture length
DFC-12-W	1' x 2'	12-3/16" + 1/4" added to total fixture length
DFC-14-W	1' x 4'	12-3/16" + 1/4" added to total fixture length
DFC-18-W ¹	1' x 8'	12-3/16" + 1/4" added to total fixture length

NOTES: 1. For use with RCC fixtures only. 2. For use with RCG fixtures only. 3. For use with RWW fixtures only.

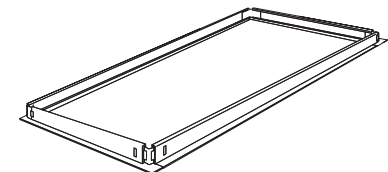

DF Series

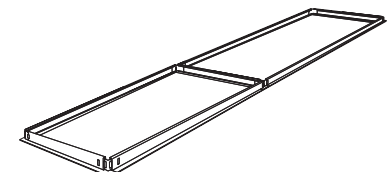

DFR Series

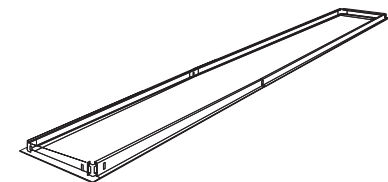



DFC Series

Specifications and dimensions subject to change without notice. Consult your Cooper Lighting Representative or visit www.cooperlighting.com for available options, accessories and ordering information.

STANDARD PRODUCT OPTIONS AND ACCESSORIES

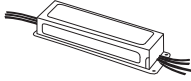
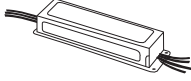
ELECTRICAL

	Designation	Description
 <p>Ballasts</p>		Refer to product spec sheets for ballast options.
 <p>Emergency Lighting</p> <p>(for additional lamp lumen performance refer to Sure-Lites spec sheet)</p>	EL4 (350-500 lumens) Two Foot (2') - Four Foot (4') RS, SL, and Compact	Self-contained, operates one lamp at emergency levels for 90 minutes upon power loss (120V or 277V). For Dry Locations Only
	EL8 (600-700 lumens) Two Foot (2') - Eight Foot (8') RS, SL, HO and Compact	
	EL5 (up to 700 lumens) Two Foot (2') - Four Foot (4') T5	
	EL5HO (up to 600 lumens) Two Foot (2') - Four Foot (4') T5HO	
	EL14 (600 to 1400 lumens) Three Foot (3') - Eight Foot (8') RS, SL and HO; Two Foot (2') - Four Foot (4') T5 and T5HO	
 <p>Fusing (Internal or External)</p>	GL	Single Element (Fast Blow) Fuse
	GM	Double Element (Slow Blow) Fuse
 <p>Radio Interference Suppressor</p>	RIF-1 (Suppressor-Advance)	Inductive capacitor circuit to minimize interference from line radiation or feedback.
<p>Night Lights (Parabolic, Recessed and Surface only)</p>	PL	Compact lamp fluorescent night light (5, 7, 9 or 13 Watt lamp, specify voltage 120V or 277V). Example: PL-13/120V



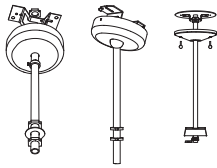
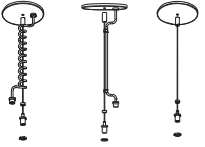

MOUNTING

Suspension Sets	Designation	Ordering Information	
<p>Stem Sets</p>  <p>SCF SCS SCA</p>	SCF-XX-B Fixed Stem Set	<div style="display: flex; justify-content: space-around; align-items: flex-start;"> <div style="border: 1px solid black; padding: 5px; text-align: center;"> <p>CCF</p> <p>Type of Kit CCA=Adjustable Cable Kit CCF=Fixed Length Cable Kit</p> </div> <div style="border: 1px solid black; padding: 5px; text-align: center;"> <p>18</p> <p>Length of Cable <u>Fixed Length</u> 12=12" long 15=15" long 18=18" long 21=21" long 24=24" long 27=27" long 48=48" long <u>Adjustable</u> 120=120" long</p> </div> <div style="border: 1px solid black; padding: 5px; text-align: center;"> <p>NPF</p> <p>Configuration NPF=Non Power Feed PFS=Straight Cord Power PFC=Curly Cord Power Feed</p> </div> </div>	
	SCS-XX-B (Deep Canopy, 3/8" stem, 5/8" Outside Diameter) XX =Length 6", 8", 12", 24", 36", 48", 60", 72"		Swivel Stem Set
	SCA-48-B Field cutable Stem Set (1/4" IPS Stem, 1/2" O.D.)		
	Used with all surface fixtures as stem sets. SCS stems have forty-five degree (45°) swivel, one direction. One set consists of one (1) stem assembly. Minimum of two (2) sets required per fixture. NOTE: Coupler, three-eighths inch (3/8") IPS Pipe Coupler to join lengths. Coupler is standard baked white enamel or special order of black.		
<p>Cable Sets</p>  <p>CCA PFC CCA PFS CCA NPF</p>	CCA-XX-PFC-C CCA=Adjustable Cable (XX=48" or 120")		
	CCA-XX-PFS-U CCF=Fixed Cable (XX=12", 15", 18", 21", 24", or 27")		
	CCA-XX-NPF-U PFC=Power Feed, Coil Power Cord		
	CCF-XX-PFC PFS=Power Feed, Straight Power Cord		
	CCF-XX-PFS NPF=Non-Power Feed		
	CCF-XX-NPF NOTE: Coupler, Three-eighths inch (3/8") IRS Pipe Coupler to join lengths. Coupler is standard baked white enamel or special order of black.		

Specifications and dimensions subject to change without notice. Consult your Cooper Lighting Representative or visit www.cooperlighting.com for available options, accessories and ordering information.

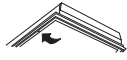
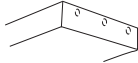
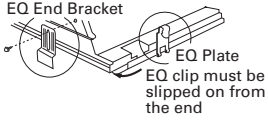
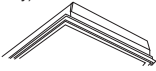
PARABOLIC, RECESSED AND SURFACE

MISCELLANEOUS





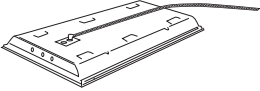
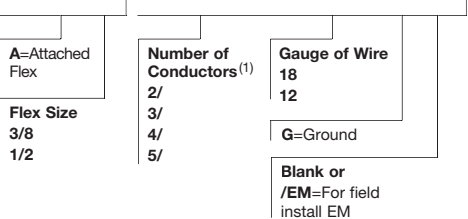
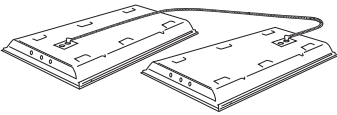
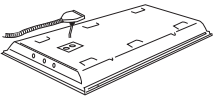

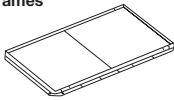
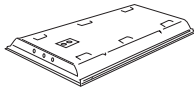

	Designation	Description
Vandal Resistant Door (GC only) 	VRS	Flat doors only. Frame secured with four (4) or six (6/VRS) torx head with center pin head screws. (No latches)
End Knockouts (M, MC and SA Series) 	EKO	7/8" KO's in end of fixture housing. Number of KO's and location varies by fixture type.
T-Bar Safety Clips (U.L. Listed 912Y and E61165)  <p>EQ End Bracket EQ Plate EQ clip must be slipped on from the end</p>	EQ-CLIP-U (Black)	UL approved safety clips used to secure recessed troffers to T-bar. EQ clips used on fixture sides. Order four (4) per fixture
	EQ-CLIP-WH (White)	
	T3A END E.Q. BRACKET PARTS BAG	EQ clips for use on fixture ends. Comes with four (4) screws and four (4) brackets.
Optional Painted And Natural Door Frames (GC only) 	Blank - (White Door Frame) Standard	Baked enamel finish
	BDF - (Black Door Frame)	Baked enamel finish
	FA, RA, FAN, RAN, FAB, RAB	See spec sheets for aluminum door finish
Heat Removal Dampers Note: Parabolic troffers only 	HRD  C=Closed O=Open	Used on heat removal luminaires to adjust or close off air flow through the housings. (See fixture catalog page for series ordering information).
Air Pattern Control Vanes 	AV	Adjustable air pattern control vanes to adjust or direct air flow on Air Supply/Air Return Troffers. (See fixture catalog page for series ordering information)
Lamps, Furnished/Installed		See Troffer Lamp Options Page
Paralux Louver Finishes 	I =Semi-Specular/Low Iridescent	Louver formed of "Low Iridescent" aluminum incorporating an oxide coating which counteracts the iridescent effect/rainbowing
	MI =Specular, Mirrored/Low Iridescent	Louver formed of specular anodized aluminum. Finish is anodic oxide coating. (See fixture catalog pages for additional ordering information)
	P =White	Louver formed from white pre-painted aluminum.

WIRING

	Ordering Information	Description
	SAMPLE NUMBER: A3/8-2/18G  <p>A=Attached Flex Flex Size 3/8 1/2</p> <p>Number of Conductors⁽¹⁾ 2/ 3/ 4/ 5/</p> <p>Gauge of Wire 18 12</p> <p>G=Ground</p> <p>Blank or /EM=For field install EM</p> <p>NOTES: 1. For fixtures with emergencies, extra conductor must be added to accommodate hot lead for EM.</p>	3/8" factory prewired flex wired into fixture access plate. Various wire gauges and number of wires available. Six foot (6') lengths only. The Flex set consists of the following: <ul style="list-style-type: none"> • One wago connector per wire • Six feet (6') of steel flex • Eighteen (18) gauge TFN wire, seven (7') foot leads, exposing six inches (6") out of each end • One ninety degree (90°) flex connector • One straight-in flex connector • One access plate
Master/Satellite 		Labor Saving tandem wiring system. Both installation and energy efficient. (See Master/Satellite Concept page or consult Pre-Sales Technical Support for additional information.)
Modular Wiring Systems 		Component wiring system, provides cost and labor saving alternative to conventional hardwiring. Uses interchangeable modular components. Offers portability and versatility in lighting configurations. (See MWS Section or consult Pre-Sales Technical Support for additional ordering information.)

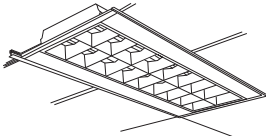
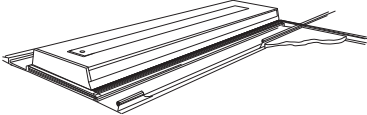
Specifications and dimensions subject to change without notice. Consult your Cooper Lighting Representative or visit www.cooperlighting.com for available options, accessories and ordering information.

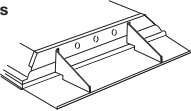
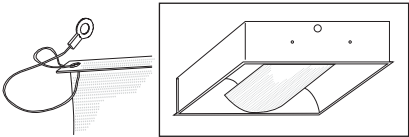
MISCELLANEOUS

	Designation	Description
Plaster Frames 	95-PF-14-U (1x4)	Heavy Gauge Metal Construction for new construction plaster ceiling. Used with Flanged Recessed Fixtures (Intended to serve as a plaster stop only, not to fit into an opening).
	95-PF-22-U (2x2)	
	95-PF-24-U (2x4)	
Rated Construction 	FR Example: 2GC-332A-UNV-EB81-FR-U	Fixture Classification for Fire Rated Ceiling Fixture is FR labeled "SUITABLE FOR INSTALLATION IN FIRE RATED CEILING" when applied in conformance with the designs specified in the "Underwriters Laboratories Fire Resistance Directory".
	IC Example: 2GR8IC-332A-UNV-EB81-U	Fixture Classification for Insulated Ceiling Fixture is IC labeled "SUITABLE FOR DIRECT CONTACT TO INSULATION". Refer to www.cooperlighting.com for available fixtures.
Fixture Gasketing Note: G2 and G3 gasket options are only available on GC fixtures (aluminum) or GC8 fixtures using aluminum frames. Gasketing availability: GC/GC8. No HR, air or louvers. (Lens minimum and maximum = 0.125)	 G1	Neoprene gasket between door frame and fixture housing.
	 G2	G1 gasketing plus vinyl gasketing between lens and door frame.
	 G3	G1 and G2 gasketing plus neoprene gasketing on mounting surface of fixture trim. (Grid or Flange). Field installed.
Side Filler Panel 	SFP-4FT-B 	Heavy gauge side filler panels for 20" x 48" fixture for use in a 2' x 4' ceiling installation. (Baked white finish/two (2) per set).
Spacer 	A-1-B/SPACER-B	Spaces fixture one and one-half inch (1-1/2") to two and one-half inches (2-1/2") from ceiling. (Use with all strips and industrials)
End Fillers 	12-EFS-B (1x2, 1x4)	Six Inch (6") Heavy gauge end fillers. Use two (2) per fixture. End fillers lay on T-bars and are held in place by fixtures but are not attached.
	20-EFS-B (20x48)	
	24-EFS-B (2x2, 2x4)	
End Support Brackets	ESS-B	Heavy gauge end support brackets. Four (4) per fixture are required when fixtures are supported from ends. Must be used with fixture that has a modified end plate (MEP).
Ovation Shield Cable Option 	LSC Center Mount	The lamp shield cable (LSC) is a factory option available for any and all Ovation products. For center mount Ovation models, use the LSC option. For side-mount, use the LSCS option. Ovation products specified with this option ship with a parts bag that contains the safety lanyards, clear rubber "caps" and instruction sheet.
	LSCS Side Mount	
Palletizing	PAL 	Un-cartoned fixtures secured by corrugated end cap protectors and heavy gauge stretch wrap. Fast and efficient handling.
	PALC	Fixtures in cartons secured by heavy gauge stretch wrap. Fast and efficient handling.

Specifications and dimensions subject to change without notice. Consult your Cooper Lighting Representative or visit www.cooperlighting.com for available options, accessories and ordering information.

PRODUCT INFORMATION FOR LAMPS

Brand	Lamp	P5	P4	EP3/HP3	P2/HP2	OPTICA	RDI/A	GC	GC8	GR8	GR5	GCA	RWW	AC	AC2	ALN	
Generic ²	L8730	X	X	X	X	X	X	X	X	X		X	X	X	X	X	
	L8735	X	X	X	X	X	X	X	X	X		X	X	X	X	X	
	L8741	X	X	X	X	X	X	X	X	X		X	X	X	X	X	
	L8830	X	X	X	X	X	X	X	X	X		X	X	X	X	X	
	L8835	X	X	X	X	X	X	X	X	X		X	X	X	X	X	
	L8841	X	X	X	X	X	X	X	X	X		X	X	X	X	X	
	LB30	X	X	X			X						X	X			X
	LB35	X	X	X			X						X	X			X
	LB41	X	X	X			X						X	X			X
	L5830	X	X	X	X	X	X	X	X			X	X	X	X	X	X
	L5835	X	X	X	X	X	X	X	X			X	X	X	X	X	X
	L5841	X	X	X	X	X	X	X	X			X	X	X	X	X	X

NOTES: 1. Add "HL" (High Lumen) to lamp ordering logic to indicate high-lumen lamp; generic HL lamps available for 32T8 or 28T5 only. Add "C" to specify Cover-guard lamps installed. 2. Generic lamp product information also valid for GE, Philips and Sylvania lamp technologies. See product information for specified lamps below.

PRODUCT INFORMATION FOR SPECIFIED LAMPS

T8 SAMPLE NUMBER: LGF28T8 / SPX41M / XL

Lamp	Brand	Wattage	CRI	Kelvin	Type (not for Biax) ³
L	G=GE	BX=40, 50 or 55W Biax (all Biax SPX only) F17=17W F28=28W F32=32W	SP=78 CRI SPX=83+ CRI ³	30M/=3000K 35M/=3500K 41M/=4100K ³ 50M/=5000K ³ WM=Watt-Miser	OC8=Octron T8 or ECO XL=Extended Life SXL=Super Extended Life HL=High Lumen XL CVG=Coverguard
L	W=Philips	FO17T8M/=17W FO28T8M/=28W FO32T8M/=32W	TL7=78 CRI TL8=85 CRI ⁴ ADV=Advantage, High Lumen, Long Life	30=3000K 35=3500K 41=4100K 50=5000K ⁴	Blank=ALTO PLUS=Plus, Long Life EWithLL=Energy Advantage, Long Life
L	S=Sylvania	FO17M/T8=17W FO28M/T8=28W FO32M/T8=32W	7=75+ CRI 8=85 CRI ⁵	30=3000K 35=3500K 41=4100K 50=5000K ⁵	Blank=ECO XP=Extended Performance, ECO3 XP/SS=Super Saver XP XPS=High Lumen, Extended Performance XPXL=Extra Life/Extended Performance

NOTES: 3. XL, SXL and HL lamp CRI values are 81-82 for 4100K or 80 for 5000K. 4. CRI value of 82 for 5000K. 5. XPS and XPXL lamp CRI values are 81 for 5000K.

T5 and T5HO SAMPLE NUMBER: LWF28T5M / 850

Lamp	Brand	Wattage	Other	CRI	Kelvin	Type (not for Biax)
L	G=GE W=Philips S=Sylvania	F14T5=14WT5 F21T5=21WT5 F24T5=24WT5HO F28T5=28WT5 F39T5=39WT5HO F54T5=54WT5HO	47W=47WT5HO (GE only) [Blank]=51WT5HO (GE only)	M/8=85+ CRI	30=3000K 35=3500K 41=4100K 50=5000K	WM=Watt-Miser (GE only) HL=High Lumen XL (T5 only) HOEA49=49W (Philips only) HOEA44=44W (Philips only)

T8 U-LAMP SAMPLE NUMBER: LSF031M / 835XP

Lamp	Brand	Wattage	CRI	Kelvin	Type	
L	G=GE		SP=78 CRI SPX=82+ CRI	30=3000K 35=3500K 41=4100K 50=5000K ⁶	M/OC8U6=32W Six Inch (6") T8 M/U1-5/8=31W One and Five-Eighths Inch (1-5/8") T8	WM=Watt-Miser ⁷
L	W=Philips	F32T8=32W Six Inch (6") T8	M/TL7=75 CRI M/TL8=85 CRI	30=3000K 35=3500K 41=4100K 50=5000K		Blank=ALTO XEW=Energy Advantage (25W 6" U-lamp spacing only)
L	S=Sylvania	FO32M/=Six Inch (6") T8 FO31M/=One and Five-Eighths Inch (1-5/8") T8	7=75 CRI 8=85 CRI	30=3000K 35=3500K 41=4100K 50=5000K ⁸		Blank=ECO XP=Extended Performance XP/SS=Super Saver XP XPS=High Lumen, Extended Performance

NOTES: 6. SPX only. 7. 30W 6" U-Lamp Spacing only. 8. 6" U6T8 75 CRI or 85 CRI XPS only.

Specifications and dimensions subject to change without notice. Consult your Cooper Lighting Representative or visit www.cooperlighting.com for available options, accessories and ordering information.

PARABOLICS AND RECESSED

Brand	Battery	P5	P4	EP3/HP3	P2/HP2	OPTICA	RDI	GC	GC8	GR8/GR5	GCA	AC	AC2	ALN
Generic	EL4 (350-500 lm)	X	X	X	X	X	X	X	X	X	X	X	X	X
	EL5 (up to 700 lm)	X	X	X	X		X	X		X	X	X	X	X
	EL8 (600-700 lm)	X	X	X	X	X	X	X	X	X	X	X	X	X
	EL5HO (up to 600 lm)	X	X	X	X		X	X		X	X	X	X	X
	EL14 (600-1400 lm) ¹	X	X	X	X	X	X	X	X	X	X	X	X	X
Bodine	EL-B100 (350-450 lm)	X	X	X	X	X	X	X	X ⁴	X ⁴	X	X	X	
	EL-B90 (500-600 lm)	X	X	X	X	X	X	X	X ⁴	X ⁴	X	X	X	
	EL-B70A (600-700 lm)	X	X	X	X	X	X	X	X ⁴	X ⁴	X	X	X	
	EL-B60 (600-700 lm)	X	X	X	X	X	X	X	X ⁴	X ⁴	X	X	X	
	EL-B60LPU (600-700lm)	X	X	X	X	X	X	X	X	X	X	X	X	
	EL-B50 (1100-1400 lm) ^{1,2}	X	X	X	X	X	X	X	X ⁴	X ⁴	X	X	X	
	EL-B50ST (1100-1400 lm) ^{1,2}	X	X	X	X	X	X	X	X ⁴	X ⁴	X	X	X	
	EL-B50RCT (1100-1400 lm) ^{1,2}	X	X	X	X	X	X	X	X ⁴	X ⁴	X	X	X	
	EL-LP500 (370-520 lm)			X	X		X	X		X	X	X ⁵		X
	EL-LP550 (390-700 lm)			X	X		X	X		X	X	X ⁵		X
	EL-LP600 (600-1325 lm)			X	X		X	X		X	X	X ⁵		X
Iota	EL-I32 (up to 550 lm)	X	X	X	X	X	X	X	X	X	X	X	X	X
	EL-I40 (up to 700 lm)	X	X	X	X	X	X	X	X	X	X	X	X	X
	EL-I48 (up to 700 lm)	X	X	X	X	X	X	X	X	X	X	X	X	X
	EL-I320 (1300 lm) ^{1,2}	X	X	X	X	X	X	X	X ⁴	X ⁴	X	X	X	
	EL-I880 (2000 lm) ^{1,2}						X		X ⁴	X ⁴		X	X	
	EL-I232 (2 @ 1400 lm) ²	X	X	X	X		X	X	X ⁴	X ⁴	X	X	X	
	EL-ISD80 (1300 lm) ^{1,2}	X	X	X	X	X	X	X	X ⁴	X ⁴	X	X	X	
	EL-ISL28 (up to 500 lm) ³			X	X		X	X		X	X	X ⁵		X
	EL-ISL54 (up to 825 lm)			X	X		X	X		X	X	X ⁵		X
	EL-ISL540 (up to 1300 lm)			X	X		X	X		X	X	X ⁵		X

NOTES: 1. For battery wired for two lamps, specify "/2L" after battery description. 2. Due to size, battery cannot be installed in 2-lamp and 4-lamp 2' x 2's, except RDI. 3. Will not operate two (2) lamps. 4. Due to battery size, a wide ballast cover is used. 5. 2' x 4' only.

PRODUCT INFORMATION FOR SURFACE

Brand	Battery	M/MC	SA	WN	WS	CR	RWW ⁶	CL	BA/BAU	BI/BIU ⁶	BE/BEU ⁶	BC ⁶
Generic	EL4 (350-500 lm)	X	X	X	X	X	X		X	X	X	X
	EL5 (up to 700 lm)	X	X	X	X	X	X		X	X	X	X
	EL8 (600-700 lm)	X	X	X	X	X	X		X	X	X	X
	EL5HO (up to 600 lm)	X	X	X	X	X	X		X	X	X	X
	EL14 (600-1400 lm) ¹	X	X	X	X	X	X		X	X	X	X
Bodine	EL-B100 (350-450 lm)	X	X	X	X	X	X		X ⁴	X	X	X
	EL-B90 (500-600 lm)	X	X	X	X	X	X		X ⁴	X	X	X
	EL-B70A (600-700 lm)	X	X		X	X	X		X ⁴	X	X	X
	EL-B60 (600-700 lm)	X	X	X	X	X	X		X ⁴	X	X	X
	EL-B60LPU (600-700lm)	X	X		X	X	X		X	X	X	X
	EL-B50 (1100-1400 lm) ^{1,2}	X	X		X	X	X		X ⁴	X	X	X
	EL-B50ST (1100-1400 lm) ^{1,2}	X	X		X	X	X		X ⁴	X	X	X
	EL-B50RCT (1100-1400 lm) ^{1,2}	X	X		X	X	X		X ⁴	X	X	X
	EL-LP500 (370-520 lm)						X					
	EL-LP550 (390-700 lm)						X					
	EL-LP600 (600-1325 lm)						X					
Iota	EL-I32 (up to 550 lm)	X	X	X	X	X	X		X	X	X	X
	EL-I40 (up to 700 lm)	X	X	X	X	X	X		X	X	X	X
	EL-I48 (up to 700 lm)	X	X		X	X	X		X	X	X	X
	EL-I320 (1300 lm) ^{1,2}	X	X		X	X	X		X ⁴	X	X	X
	EL-I880 (2000 lm) ^{1,2}	X	X		X	X	X		X ⁴	X	X	X
	EL-I232 (2 @ 1400 lm) ²	X	X		X	X	X		X ⁴	X	X	X
	EL-ISD80 (1300 lm) ^{1,2}	X	X		X	X	X		X ⁴	X	X	X
	EL-ISL28 (up to 500 lm) ³						X					
	EL-ISL54 (up to 825 lm)						X					
	EL-ISL540 (up to 1300 lm)						X					

NOTES: 1. For battery wired for two lamps, specify "/2L" after battery description. 2. Due to size, battery cannot be installed in 2-lamp and 4-lamp 2' x 2's, except RDI. 3. Will not operate 2-lamps. 4. Due to battery size, a wide ballast cover is used. 5. 2' x 4' only. 6. Due to size limitations, battery cannot be installed in two foot (2') units.

PRODUCT INFORMATION FOR STRIP AND INDUSTRIALS

Brand	Battery	RCG ²	SNF ²	SSF ²	SNL ²	SSL ²	SNSM ²	SNRA ²	SMSL ²	DIF/ DMF/ DVMF	IAF/ ICF	VT1	VT2 ²	VT3	VT4	SM/ SML ²	I5/ I8	HBI/ HBG	2HBHD/ 2HBHT/ 2HBG	HBE/ HBL	MBF	ABI
Generic	EL4 (350-500 lm)	X	X	X	X	X	X	X	X	X	X					X	X	X	X	X	X	
	EL5 (up to 700 lm)	X	X	X	X	X	X	X	X	X	X					X	X	X	X	X	X	
	EL8 (600-700 lm)	X	X	X	X	X	X	X	X	X	X					X	X	X	X	X	X	
	EL5HO (up to 600 lm)	X	X	X	X	X	X	X	X	X	X					X	X	X	X	X	X	
	EL14 (600-1400 lm) ¹	X	X	X	X	X	X	X	X	X	X					X	X	X	X	X	X	
Bodine	EL-B100 (350-450 lm)	X	X	X	X	X	X	X	X	X	X					X	X	X		X	X	
	EL-B90 (500-600 lm)	X	X	X	X	X	X	X	X	X	X					X	X	X		X	X	
	EL-B70A (600-700 lm)	X	X	X	X	X	X	X	X	X	X					X	X	X		X	X	
	EL-B60 (600-700 lm)	X	X	X	X	X	X	X	X	X	X					X	X	X		X	X	
	EL-B60LPU (600-700 lm)	X	X	X	X	X	X	X	X	X	X		X ³	X ³	X ³	X	X	X	X ³	X	X	
	EL-B50 (1100-1400 lm) ^{1,2}	X	X	X	X	X	X	X	X	X	X		X ³	X ³	X ³	X	X	X	X ³	X	X	
	EL-B50ST (1100-1400 lm) ^{1,2}	X	X	X	X	X	X	X	X	X	X					X	X	X		X	X	
	EL-B50RCT (1100-1400 lm) ^{1,2}	X	X	X	X	X	X	X	X	X	X					X	X	X		X	X	
	EL-LP500 (370-520 lm)	X	X	X	X	X	X	X	X	X	X					X	X	X		X	X	
	EL-LP550 (390-700 lm)												X	X	X	X	X	X	X	X	X	
	EL-LP600 (600-1325 lm)												X	X	X	X	X	X	X	X	X	
Iota	EL-I32 (up to 550 lm)	X	X	X	X	X	X	X	X	X	X					X	X	X				
	EL-I40 (up to 700 lm)	X	X	X	X	X	X	X	X	X	X					X	X	X				
	EL-I48 (up to 700 lm)	X	X	X	X	X	X	X	X	X	X					X	X	X				
	EL-I320 (1300 lm) ^{1,2}	X	X	X	X	X	X	X	X	X	X					X	X	X				
	EL-I880 (2000 lm) ^{1,2}	X	X	X	X	X	X	X	X	X	X					X	X	X				
	EL-I232 (2 @ 1400 lm) ²	X	X	X	X	X	X	X	X	X	X					X	X	X				
	EL-ISD80 (1300 lm) ^{1,2}	X	X	X	X	X	X	X	X	X	X					X	X	X				
	EL-ISL28 (up to 500 lm) ³			X	X													X	X		X	X
	EL-ISL54 (up to 825 lm)			X	X													X	X		X	X
	EL-ISL540 (up to 1300 lm)			X	X													X	X		X	X
	EL-I40DL (up to 700 lm)												X	X	X					X		
	EL-I48DL (up to 700 lm)												X	X	X					X		
	EL-I80DL (1300 lm)												X	X	X					X		
	EL-I232DL (2 @ 1400 lm)												X	X	X					X		
	EL-ISL28DL (up to 500 lm)												X	X	X					X		
	EL-ISL54DL (up to 825 lm)												X	X	X					X		

NOTES: 1. For battery wired for two lamps, specify "/2L" after battery description. 2. Due to size limitations, battery cannot be installed in two (2) foot units. 3. Order BDLGOU or B50LP for vaportite, hosedown or UL wet listed fixtures.

Specifications and dimensions subject to change without notice. Consult your Cooper Lighting Representative or visit www.cooperlighting.com for available options, accessories and ordering information.

PRODUCT INFORMATION FOR EXTENDED OPTIONS

Nomenclature	Description	P5	P4	EP3/HP3	P3	P2/HP2	OPTICA	GC	GC8	GR8/GR5	GCA	RWW	RDI	AC/AC2	ALN
RIF1	Radio Interference Suppressor	X	X	X		X	X	X	X	X	X	X	X	X	X
2/RIF1	Two (2) Suppressors	X	X	X		X		X	X	X	X	X	X	X	
PL5/120	PL5 Night Light wired 120V	X	X	X		X		X			X	X	X		
PL5/277	PL5 Night Light wired 277V	X	X	X		X		X			X	X	X		
PL7/120	PL7 Night Light wired 120V	X	X	X		X		X			X	X	X		
PL7/277	PL7 Night Light wired 277V	X	X	X		X		X			X	X	X		
PL9/120	PL9 Night Light wired 120V	X	X	X		X		X			X	X	X		
PL9/277	PL9 Night Light wired 277V	X	X	X		X		X			X	X	X		
PL13/120	PL13 Night Light wired 120V	X	X	X		X		X			X	X	X		
PL13/277	PL13 Night Light wired 277V	X	X	X		X		X			X	X	X		
LAP ¹	Less Access Plate	X	X	X		X	X	X	X	X				X	X
LAO ²	Less Access Opening	X	X	X		X	X	X	X	X	X			X	X
FR	Suitable for Install Fire Rated Ceiling	X	X	X		X		X	X	X	X		X	X	X
IC	IC-Rated ⁶			X		X	X	X	X	X			X	X ¹⁰	X
G1	Gasket btw DR Frm and Housing							X	X	X	X				
G2 ³	Gasket btw DR Frm and Housing, btw Lens and DR Frm							X	X ⁵		X				
G3 ³	Gasket btw DR Frm and Hous, btw Lens and DR Frm on Mnt Surf of Trm							X	X ⁵		X				
VRS	Vandal Resistant Screws (2FT - 2; 4FT - Four (4) screws)							X							
6/VRS	Six (6) Vandal Resistant Screws							X							
MEP ⁴	Modified End Plate	X	X	X		X	X	X			X				
REP	Riveted End Plate	X	X	X		X	X	X	X		X	X	X		X
6/LC	Six (6) Lens Clips							X	X						
2BC	Second Ballast Cover		X ⁷	X ⁷		X ⁷		X ⁷	X ⁸	X ⁸	X				
EM/BC	EM Installed in field ⁹ (Wide or standard BC used in fixture)	X	X	X		X	X	X	X	X	X				
1IN/MLAB	One Inch (1") Mark Labeling	X	X	X	X	X		X	X		X	X	X		
2IN/MLAB	Two Inch (2") Mark Labeling	X	X	X	X	X		X	X		X	X	X		
PAF	Painted After Fabrication		X	X		X		X	X		X				X
DS	Debris Shield												X		

NOTES: 1. Option used when housing access plates are shipped ahead for pre-wiring. 2. Required for 2-lamp or 4-lamp 2' x 2' fixture when two (2) ballast or one (1) ballast and emergency are requested. 3. Aluminum door and minimum 0.125" shielding. 4. Installation requires end fillers and may require end support bracket. See accessory page for further details. 5. Aluminum doorframe (FA/RA) only. 6. See product spec sheet for limitations. 7. For 2' x 2' 3L, 2BC is standard. See product spec sheet for additional info. 8. For 2' x 2' 3L Biax or U1-5/8, 2BC is standard; 2U6T8, 3T5 or 3T8, 2BC is optional. 9. Refer to EM table above for fit. 10. AC only.

PACKAGING (REQUIRED)

Nomenclature	Description	P5	P4	EP3/HP3	P3	P2/HP2	OPTICA	GC	GC8	GR8/GR5	GCA	RWW	RDI	AC	AC2	ALN
U	Unit Pack	X	X	X	X	X	X	X	X	X	X	X	X	X	X	X
PAL	Job Pack, out of carton	X	X	X		X	X	X	X		X					
PALC	Job Pack, in carton	X	X	X		X	X	X	X		X	X	X	X	X	X

PRODUCT INFORMATION FOR EXTENDED OPTIONS-SURFACE

Nomenclature	Description	PMX	M/MC	SA	WB	WE	WS	CR	CL	BA ²	BI/BE ²	BC
IB	Socket Position Inboard			X								
OB	Socket Position Outboard			X								
RIF1	Radio Interference Suppressor	X	X		X	X	X		X	X		
2/RIF1	Two (2) Suppressors	X	X		X	X	X		X	X		
3CP	Three Foot (3') Cord and Plug								X			
6CP	Six Foot (6') Cord and Plug								X			
PC /VOLTAGE	Cord and Plug Attached (Specify Voltage)			X	X		X	X				
PI/CPI	Plug-in Wiring											
TILW	Tandem In-Line Wiring			X	X		X	X				
4BB	Four (4) Ballast Bolts	X	X		X					X	X	X
PL5/120	PL5 Night Light wired 120V	X	X	X	X		X			X	X	
PL5/277	PL5 Night Light wired 277V	X	X	X	X		X			X	X	
PL7/120	PL7 Night Light wired 120V	X	X	X	X		X			X	X	
PL7/277	PL7 Night Light wired 277V	X	X	X	X		X			X	X	
PL9/120	PL9 Night Light wired 120V	X	X	X	X		X			X	X	
PL9/277	PL9 Night Light wired 277V	X	X	X	X		X			X	X	
PL13/120	PL13 Night Light wired 120V	X	X	X	X		X			X	X	
PL13/277	PL13 Night Light wired 277V	X	X	X	X		X			X	X	
G1	Gasket btw Door Frame and Housing		X									
G2 ¹	Gasket btw Door Frame and Housing, btw Lens and Door Frame		X									
VRS	Vandal Resistant Screws (4 standard)		X									
6/VRS	Six (6) Vandal Resistant Screws		X									
BH	Matte Black Finish									X	X	
WH	White Finish									X		
CO	Grounded Convenience Outlet								X	X	X	X
PS1	Pull Switch, Single Circuit (120V only)									X	X	X
PS1D	Pull Switch, Wired to Downlight Circuit (120V only)									X	X	X
PS4	Pull Switch, Four-way (120V only)									X	X	X
RS1	Rotary Switch, Single Circuit (120V only)									X	X	X
RS1D	Rotary Switch, Wired to Downlight Circuit (120V only)									X	X	X
RS4	Rotary Switch, Four-way (120V only)									X	X	X
SW	Rocker Switch								X			
EKO	End Knockout	X	X	X								
1/EKO	End Knockout on One End Only	X	X	X								
DEP	Heavy Gauge Steel Decorator End Plate				X							
6/LC	Six (6) Lens Clips		X									
1IN/MLAB	One Inch (1") Mark Labeling	X	X	X	X	X	X	X	X	X	X	X
2IN/MLAB	Two Inch (2") Mark Labeling	X	X	X	X	X	X		X	X		
BT	Black Accent Trim									X		
IH	Almond Housing									X		
NT	No Trim									X		
OF	Opaque Front								X			
OT	Oak Accent Trim									X		
PAF	Painted After Fabrication		X		X	X	X					
SMB	Side Mounted Ballast		X	X								

PACKAGING (REQUIRED)

Nomenclature	Description	PMX	M/MC	SA	WB	WS	WE	CR	CL	BA	BI/BE	BC
U	Unit Packed	X	X	X	X	X	X	X	X	X	X	X

NOTES: 1. Aluminum door and minimum .125 shielding required. 2. Night light options available for 1-Lamp units only.

ACCESSORY REFLECTOR NOMENCLATURE

SAMPLE NUMBER: SNF-ASY-SS-4

SNF	ASY	SS	4
Strip Series SNF=Narrow SSF=Standard	Reflector Style ASY=Asymmetric ⁴ SYM=Symmetric SYM12=Twelve Inches (12") Symmetric ³ REV=Reverse Asymmetric ⁴	Finish Blank=White SS=Specular Steel	Length 18=Eighteen Inches (18") ¹ 2=Two Feet (2') 2T5=Two Feet (2') T5 3=Three Feet (3') 4=Four Feet (4') 4T5=Four Feet (4') T5 8T=Eight (8) Feet ² 8T5=Eight (8) Feet T5

NOTES: 1. For SNF only. 2. Will ship as two (2) four foot (4') reflectors. 3. For SSF only. 4. For T12 or T8 applications only (no T12 Slimline or T12 HO). 5. For Slimline or T8HO two (2) lamp fixture where the reflector will replace the channel cover.

SNF ASY Reflector



White	Specular
SNF-ASY-18IN	SNF-ASY-SS-18IN
SNF-ASY-2	SNF-ASY-SS-2
SNF-ASY-3	SNF-ASY-SS-3
SNF-ASY-4	SNF-ASY-SS-4
SNF-ASY-8T	SNF-ASY-SS-8T-2
SNF-ASY-2T5	SNF-ASY-SS-2T5
SNF-ASY-4T5	SNF-ASY-SS-4T5
SNF-ASY-8T5	SNF-ASY-SS-8T5

SSF ASY Reflector



White	Specular
SSF-ASY-2	SSF-ASY-SS-2
SSF-ASY-3	SSF-ASY-SS-3
SSF-ASY-4	SSF-ASY-SS-4
SSF-ASY-8T	SSF-ASY-SS-8T
SSF-ASY-2T5	SSF-ASY-SS-2T5
SSF-ASY-4T5	SSF-ASY-SS-4T5
SSF-ASY-8T5	SSF-ASY-SS-8T5

SNF REV/ASY Reflector



White	Specular
SNF-REV-2	SNF-REV-SS-2
SNF-REV-3	SNF-REV-SS-3
SNF-REV-4	SNF-REV-SS-4
SNF-REV-8T	SNF-REV-SS-8T
SNF-REV-2T5	SNF-REV-SS-2T5
SNF-REV-4T5	SNF-REV-SS-4T5
SNF-REV-8T5	SNF-REV-SS-8T5

SSF REV/ASY Reflector



White	Specular
SSF-REV-2	SSF-REV-SS-2
SSF-REV-3	SSF-REV-SS-3
SSF-REV-4	SSF-REV-SS-4
SSF-REV-8T	SSF-REV-SS-8T
SSF-REV-2T5	SSF-REV-SS-2T5
SSF-REV-4T5	SSF-REV-SS-4T5
SSF-REV-8T5	SSF-REV-SS-8T5

SNF SYM Reflector



White	Specular
SNF-SYM-18IN	SNF-SYM-SS-18IN
SNF-SYM-2	SNF-SYM-SS-2
SNF-SYM-3	SNF-SYM-SS-3
SNF-SYM-4	SNF-SYM-SS-4
SNF-SYM-8T	SNF-SYM-SS-8T

SSF SYM Reflector



White	Specular
SSF-SYM-2	SSF-SYM-SS-2
SSF-SYM-2T5	SSF-SYM-SS-2T5
SSF-SYM-3	SSF-SYM-SS-3
SSF-SYM-4	SSF-SYM-SS-4
SSF-SYM-4T5	SSF-SYM-SS-4T5
SSF-SYM-8T	SSF-SYM-SS-8T
SSF-SYM-8TT5	SSF-SYM-SS-28TT5
SSF-SYM-4HOR ⁵	SSF-SYM-SS-4HOR ⁵
SSF-SYM-8HOR ⁵	SSF-SYM-SS-8HOR ⁵

SSF SYM Reflector

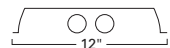

White	Specular
SSF-SYM12-4	SSF-SYM12-SS-4
SSF-SYM12-4HOR ⁵	SSF-SYM12-SS-4HOR ⁵
SSF-SYM12-8	SSF-SYM12-SS-8
SSF-SYM12-8HOR ⁵	SSF-SYM12-SS-8HOR ⁵

Specifications and dimensions subject to change without notice. Consult your Cooper Lighting Representative or visit www.cooperlighting.com for available options, accessories and ordering information.

ACCESSORY REFLECTOR NOMENCLATURE

SAMPLE NUMBER: SNL-REV-SS-2-1

SNL	ASY	SS	4	2
Strip Series SNL=Narrow Staggered SSL=Standard Staggered	Reflector Style ASY=Asymmetric SYM=Symmetric REV=Reverse Asymmetric	Finish Blank=White SS=Specular Steel RP=Round Perf	Length 18=Eighteen Inches (18") 2=Two Feet (2') 3=Three Feet (3') 4=Four Feet (4') 5=Five Feet (5') 8=Eight Feet (8') ¹ 8T=Eight Feet (8') ¹	Number of Lamps 1=One (1) Lamp 2=Two (2) Lamp 4=Three (3) or Four (4) Lamp

NOTES: 1. Will ship as two (2) four foot (4') reflectors.

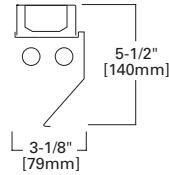

SNL REV/ASY Reflector

White	Specular	Perf
SNL-REV-2-1	SNL-REV-SS-2-1	N/A
SNL-REV-2-2	SNL-REV-SS-2-2	N/A
SNL-REV-3-1	SNL-REV-SS-3-1	N/A
SNL-REV-3-2	SNL-REV-SS-3-2	N/A
SNL-REV-4-1	SNL-REV-SS-4-1	N/A
SNL-REV-4-2	SNL-REV-SS-4-2	N/A
SNL-REV-8T-1	SNL-REV-SS-8T-1	N/A
SNL-REV-8T-2	SNL-REV-SS-8T-2	N/A

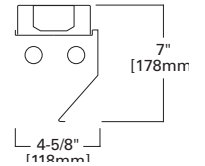

SSL REV/ASY Reflector

White	Specular	Perf
SSL-REV-2-1	SSL-REV-SS-2-1	N/A
SSL-REV-2-2	SSL-REV-SS-2-2	N/A
SSL-REV-3-1	SSL-REV-SS-3-1	N/A
SSL-REV-3-2	SSL-REV-SS-3-2	N/A
SSL-REV-4-1	SSL-REV-SS-4-1	N/A
SSL-REV-4-2	SSL-REV-SS-4-2	N/A
SSL-REV-8T-1	SSL-REV-SS-8T-1	N/A
SSL-REV-8T-2	SSL-REV-SS-8T-2	N/A
SSL-REV-8-1	SSL-REV-SS-8-1	N/A
SSL-REV-8-2	SSL-REV-SS-8-2	N/A

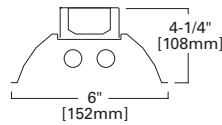

SNL SYM Reflector

White	Specular	Perf
SNL-SYM-2-1	SNL-SYM-SS-2-1	N/A
SNL-SYM-2-2	SNL-SYM-SS-2-2	N/A
SNL-SYM-3-1	SNL-SYM-SS-3-1	N/A
SNL-SYM-3-2	SNL-SYM-SS-3-2	N/A
SNL-SYM-4-1	SNL-SYM-SS-4-1	N/A
SNL-SYM-4-2	SNL-SYM-SS-4-2	N/A
SNL-SYM-8-1	SNL-SYM-SS-8-1	N/A
SNL-SYM-8T-2	SNL-SYM-SS-8T-2	N/A

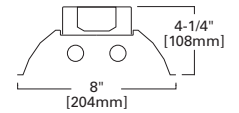

SSL SYM Reflector

White	Specular	Perf
SSL-SYM-2-1	SSL-SYM-SS-2-1	N/A
SSL-SYM-2-2	SSL-SYM-SS-2-2	N/A
SSL-SYM-3-1	SSL-SYM-SS-3-1	N/A
SSL-SYM-3-2	SSL-SYM-SS-3-2	N/A
SSL-SYM-4-1	SSL-SYM-SS-4-1	N/A
SSL-SYM-4-2	SSL-SYM-SS-4-2	N/A
SSL-SYM-8T-1	SSL-SYM-SS-8T-1	N/A
SSL-SYM-8T-2	SSL-SYM-SS-8T-2	N/A
SSL-SYM-8-1	SSL-SYM-SS-8-1	N/A
SSL-SYM-8-2	SSL-SYM-SS-8-2	N/A

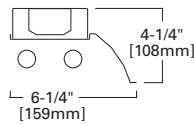

SSL ASY Reflector

White	Specular	Perf
SSL-ASY-2-1	SSL-ASY-SS-2-1	N/A
SSL-ASY-2-2	SSL-ASY-SS-2-2	N/A
SSL-ASY-3-1	SSL-ASY-SS-3-1	N/A
SSL-ASY-3-2	SSL-ASY-SS-3-2	N/A
SSL-ASY-4-1	SSL-ASY-SS-4-1	N/A
SSL-ASY-4-2	SSL-ASY-SS-4-2	N/A
SSL-ASY-8T-1	SSL-ASY-SS-8T-1	N/A
SSL-ASY-8T-2	SSL-ASY-SS-8T-2	N/A
SSL-ASY-8-1	SSL-ASY-SS-8-1	N/A
SSL-ASY-8-2	SSL-ASY-SS-8-2	N/A

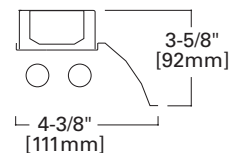

SNL ASY Reflector

White	Specular	Perf
SNL-ASY-2-1	SNL-ASY-SS-2-1	N/A
SNL-ASY-2-2	SNL-ASY-SS-2-2	N/A
SNL-ASY-3-1	SNL-ASY-SS-3-1	N/A
SNL-ASY-3-2	SNL-ASY-SS-3-2	N/A
SNL-ASY-4-1	SNL-ASY-SS-4-1	N/A
SNL-ASY-4-2	SNL-ASY-SS-4-2	N/A
SNL-ASY-8T-1	SNL-ASY-SS-8T-1	N/A
SNL-ASY-8T-2	SNL-ASY-SS-8T-2	N/A

Specifications and dimensions subject to change without notice. Consult your Cooper Lighting Representative or visit www.cooperlighting.com for available options, accessories and ordering information.

ACCESSORY REFLECTOR NOMENCLATURE

SAMPLE NUMBER: SNF-ASY-SS-18IN

SM	ASY	SS	4	1
Strip Series SM=Micro SML=Micro Staggered SMW=Micro Wide	Reflector Style ASY=Asymmetric SYM=Symmetric REV=Reverse Asymmetric	Finish Blank=White SS=Specular RP=Round Perf	Length 18=18 Inches (18") 2=2 Feet (2') 3=3 Feet (3') 4=4 Feet (4') 8=8 Feet (8') 8T=8 Feet (8') ²	Number of Lamps 1=One (1) Lamp 2=Two (2) Lamps 4=(Three) 3 or (Four) 4 Lamps ³

NOTES: 1. For SM, SML and SMW only. 2. Will ship as two (2) four foot (4') reflectors.
 3. For SMW only.

SAMPLE NUMBER: SNSM-ASY-SS-2-2

SNSM	ASY	SS	4	1
Strip Series SNSM=Side Mounted Striplight	Reflector Style ASY=Asymmetric	Finish Blank=White SS=Specular	Length 2=Two Feet (2') 3=Three Feet (3') 4=Four Feet (4')	Number of Lamps 1=One (1) Lamp 2=Two (2) Lamps

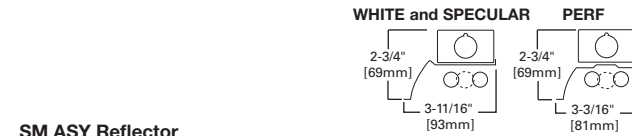

SM ASY Reflector

White	Specular	Perf
SM-ASY-2-2	SM-ASY-SS-2-2	SM-ASY-RP-2-2
SM-ASY-3-2	SM-ASY-SS-3-2	SM-ASY-RP-3-2
SM-ASY-4-2	SM-ASY-SS-4-2	SM-ASY-RP-4-2
SM-ASY-8T-2	SM-ASY-SS-8T-2	SM-ASY-RP-8T-2

SML ASY Reflector

White	Specular	Perf
SML-ASY-3-1	SML-ASY-SS-3-1	SML-ASY-RP-3-1
SML-ASY-3-2	SML-ASY-SS-3-2	SML-ASY-RP-3-2
SML-ASY-4-1	SML-ASY-SS-4-1	SML-ASY-RP-4-1
SML-ASY-4-2	SML-ASY-SS-4-2	SML-ASY-RP-4-2

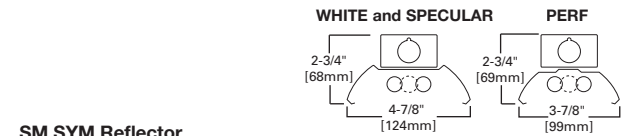
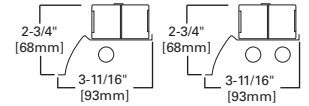

SM SYM Reflector

White	Specular	Perf
SM-SYM-2-2	SM-SYM-SS-2-2	SM-SYM-RP-2-2
SM-SYM-3-2	SM-SYM-SS-3-2	SM-SYM-RP-3-2
SM-SYM-4-2	SM-SYM-SS-4-2	SM-SYM-RP-4-2
SM-SYM-8T-2	SM-SYM-SS-8T-2	SM-SYM-RP-8T-2

SML REV/ASY Reflector

White	Specular	Perf
SML-REV-3-1	SML-REV-SS-3-1	SML-REV-RP-3-1
SML-REV-3-2	SML-REV-SS-3-2	SML-REV-RP-3-2
SML-REV-4-1	SML-REV-SS-4-1	SML-REV-RP-4-1
SML-REV-4-2	SML-REV-SS-4-2	SML-REV-RP-4-2

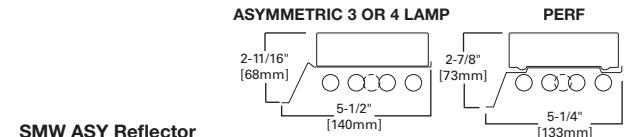
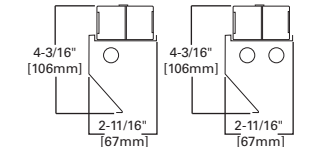

SMW ASY Reflector

White	Specular	Perf
SMW-ASY-2-4	SMW-ASY-SS-2-4	SMW-ASY-RP-2-4
SMW-ASY-3-4	SMW-ASY-SS-3-4	SMW-ASY-RP-3-4
SMW-ASY-4-4	SMW-ASY-SS-4-4	SMW-ASY-RP-4-4
SMW-ASY-8T-4	SMW-ASY-SS-8T-4	SMW-ASY-RP-8T-4

SML SYM Reflector

White	Specular	Perf
SML-SYM-3-1	SML-SYM-SS-3-1	SML-SYM-RP-3-1
SML-SYM-3-2	SML-SYM-SS-3-2	SML-SYM-RP-3-2
SML-SYM-4-1	SML-SYM-SS-4-1	SML-SYM-RP-4-1
SML-SYM-4-2	SML-SYM-SS-4-2	SML-SYM-RP-4-2

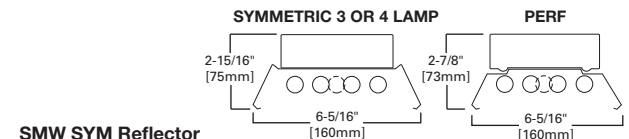
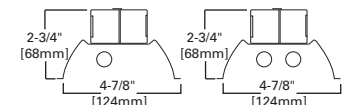

SMW SYM Reflector



White	Specular	Perf
SMW-SYM-2-4	SMW-SYM-SS-2-4	SMW-SYM-RP-2-4
SMW-SYM-3-4	SMW-SYM-SS-3-4	SMW-SYM-RP-3-4
SMW-SYM-4-4	SMW-SYM-SS-4-4	SMW-SYM-RP-4-4
SMW-SYM-8T-4	SMW-SYM-SS-8T-4	SMW-SYM-RP-8T-4

SNSM ASY Reflector

White	Specular	Perf
SNSM-ASY-2-2	SNSM-ASY-SS-2-2	N/A
SNSM-ASY-3-2	SNSM-ASY-SS-3-2	N/A
SNSM-ASY-4-2	SNSM-ASY-SS-4-2	N/A

Specifications and dimensions subject to change without notice. Consult your Cooper Lighting Representative or visit www.cooperlighting.com for available options, accessories and ordering information.

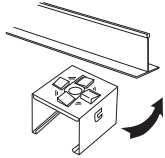
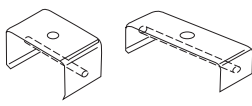
STRIPS AND INDUSTRIALS

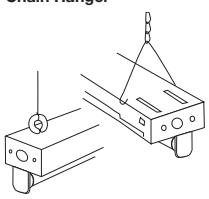
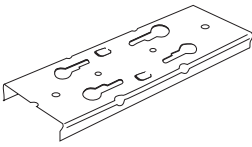
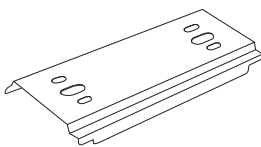
Mounting	Designation	Description
Gripper Hanger 	GRP-SSF-U (Use with SSF, IAF/ICF, SMF, DMF) using 11/16" hole provided.	For mounting on T-bar grid. Use two (2) per fixture. Can also be stem mounted or bolted to surface. Fixture spacing one and one-half inch (1-1/2").
	GRP-SNF-U (Use with SNF)	
Tong Hanger 	ATG-4-U (Use with SMF, DIF, DMF, DVMF, DCIF, DCMF, DCVMF)	Heavy Gauge Channel Tong Hanger. Use two per fixture. Fixture Spacing 1-1/2".
	ATG-SSF-4-U (Use with SSF, IAF/ICF)	
	ATG-SNF-4-U (Use with SNF)	
Spacer 	A-1-B/Spacer-B (Use with all Strips and Industrials)	Spaces fixture 1-1/2" to two and one-half inches (2-1/2") from ceiling.
Chain Hanger 	AYC-CHAIN/SET-U (Use with all strips and industrials except STW)	Sturdy wire hook and thirty-six inch (36") chain set. Use two per fixture. One set of two (2) provided.
	Eye-Chain/Set-B (SNF only)	Eye bolt and thirty-six inch (36") chain. Use two (2) per fixture. One (1) set of two (2) provided.
Channel Connector 	CLC-SSF-B (LA City approved)	Special rigid channel connector designed to give extra support to continuous channel installation (Use with SSF, IAF/ICF). Provision for hanging device. NOTES: 1. Not recommended with wireguard
	CLC-SSF-EXT-B (External Connector SSF) ¹	
	CLC-SNF-EXT-B (External Connector SNF) ¹	
DI Long Connector 	DI2 Long Connector (Use with SMF, DIF, DMF, DVMF, DCIF, DCMF, DCVMF)	Extra support heavy duty channel connector.

Specifications and dimensions subject to change without notice. Consult your Cooper Lighting Representative or visit www.cooperlighting.com for available options, accessories and ordering information.

STRIPS AND INDUSTRIALS

WIRING

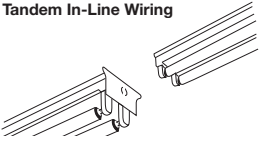
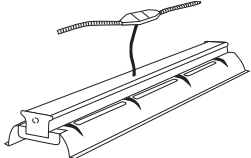
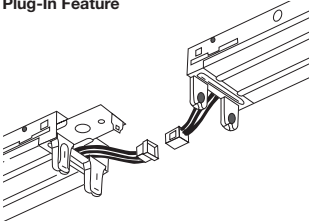



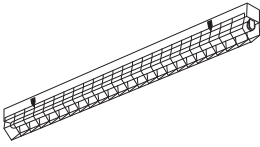
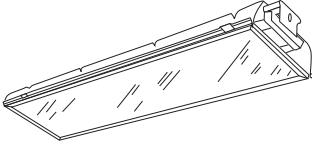
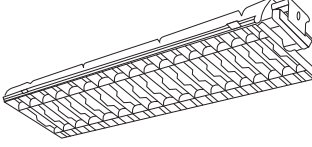
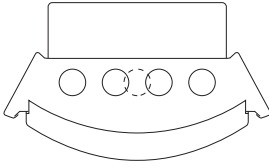

	Designation	Description										
<p>Cord and Plugs</p> 	<p>6-3/18SJT-CandP-515P (120V)</p> <hr/> <p>6-3/18SJT-CandP-715P (277V)</p>	<p>SAMPLE NUMBER: 6-3/18SJT-CandP-515P</p> <table border="1"> <tr> <td>Length 6=Six Feet (6') (standard)</td> <td rowspan="2">Insulation Type SJT (standard)</td> <td rowspan="2">Plug Type [Blank]= Straight Blade L=Twist Lock</td> <td rowspan="2">Amp Rating 15 20</td> </tr> <tr> <td>Conductors 3/ (standard)</td> <td>Cord/Plug C and P</td> </tr> <tr> <td>Wire Gauge 18 (standard)</td> <td></td> <td>Voltage 5=120V 7=277V</td> <td>P=Plug</td> </tr> </table>	Length 6=Six Feet (6') (standard)	Insulation Type SJT (standard)	Plug Type [Blank]= Straight Blade L=Twist Lock	Amp Rating 15 20	Conductors 3/ (standard)	Cord/Plug C and P	Wire Gauge 18 (standard)		Voltage 5=120V 7=277V	P=Plug
Length 6=Six Feet (6') (standard)	Insulation Type SJT (standard)	Plug Type [Blank]= Straight Blade L=Twist Lock	Amp Rating 15 20									
Conductors 3/ (standard)				Cord/Plug C and P								
Wire Gauge 18 (standard)		Voltage 5=120V 7=277V	P=Plug									
<p>Tandem In-Line Wiring</p> 	<p>TILW</p>	<p>Tandem in-line wired strip or industrial fixture sections are applied in pairs (Two (2) four (4') or eight foot (8') sections) See Tandem In-Line Wiring Section or consult the factory for additional ordering information.</p>										
<p>Modular Wiring Systems (MWS)</p> 		<p>Component wiring system, provides cost and labor saving alternative to conventional hardwiring. Uses interchangeable modular components. Offers portability and versatility in lighting configurations. See MWS Section or contact Pre-Sales Technical Support for additional ordering information.</p>										
<p>Plug-In Feature</p> 	<p>PI1</p> <hr/> <p>CPI2</p> <hr/> <p>CPI3</p>	<p>Each fixture assembly is equipped with two factory installed polarized nylon plug-in connectors. Ballast leads and branch circuit wiring are connected to plug-in connectors at factory. Alternating male and female connectors complete circuit from one fixture to another when fixture plug-in connectors are joined. Consult the PI Option Section or contact Pre-Sales Technical Support for additional ordering information.</p>										

Specifications and dimensions subject to change without notice. Consult your Cooper Lighting Representative or visit www.cooperlighting.com for available options, accessories and ordering information.

ACCESSORIES

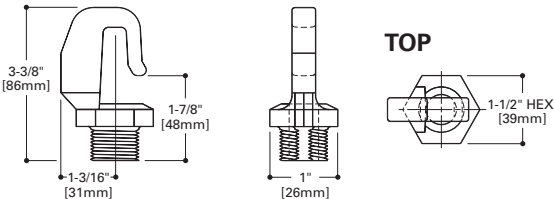
	Designation	Description
Wire Guards 	WG/SNF-4FT-U	Baked white enamel finish. Fourteen (14) gauge wire.
	WG/SSF-4FT-U	
	WG/ICF-4FT-U (IAF, ICF)	
	WG/DIF-4FT-U (DIF, DMF, DVMF)	
	WG/SMF-4FT-U	
	WG/SSL-R-2FT-B	
	WG/SSL-R-3FT-B	
	WG/VT2-4FT-B	
Gym Guards frame 	Gym Guard, GG-DIF (Wire Gym Guard)	Baked white enamel finish. Eleven (11) gauge wire. Steel to support optional sheilding. (Use with DIF, DMF, DVMF)
	WG/PA-4FT (Wire Gym Guard/Acrylic Lens)	
	DI-SL-AWithFRM (use with Slimline and HO lamps)	
	DI-RS-AWithFRM (use with Rapid Start lamps) (Steel Frame/Acrylic Lens)	
Egg Crate Louvers Steel 	MECL-DIF/RS-49-3/4-U	Baked white enamel finish. Sturdy cold rolled construction. Thirty-two degree (32°) parallel shielding. (Use with DI, DIM, DIVM)
	MECL-DIF/RS-99-1/2-U	
	MECL-DIF/SL-48-U	
	MECL-DIF/SL-96-U	
Cricket Micro Baffle 	SM-2-TBW	Cost effective indirect lighting solution. Mounting kit is field installed with standard SM strip with reflector. Variety of mounting options available. Each fixture supported at each end and/or each fixture joining.
	SM-3-TBW	
	SM-4-TBW	
	SM-5-TBW	
	SMW-2-TBW (use for wide reflector)	
	SMW-4-TBW (use for wide reflector)	

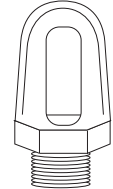
F-BAY MOUNTING ACCESSORIES







Mounting Accessories	Designation	Description
Single Point Mount 	HB-SPM = Galvanized Single Monopoint Hanging Kit with Hub (HBI only, supplied separately) HB-SPM-S = Galvanized Surface Mount Hanging Kit with Hub (HBI only, supplied separately)	Suitable for three-quarter inch (3/4") conduit mounting or for use with fixture hook, loop or safety hook. Use chain or cable set to meet NEC requirements for single point mounting, as well as to prevent cantilevering and rotation of fixture from one central location.
	HBL-SPM = Galvanized Single Monopoint Hanging Kit with Hub (HBE and HBL only, supplied separately) HBL-SPM-S = Galvanized Surface Mount Hanging Kit with Hub (HBE and HBL only, supplied separately)	
	I5/I8-SPM = Galvanized Single Monopoint Hanging Kit with Hub (I5 and I8 only, supplied separately)	
Mounting Methods	Designation	Description
Hook and Safety Hook 	FH-1 = Fixture Hook 	Fixture Hook two and one-half inch (2-1/2") (must be used with TCB, HB-SPM or HBL-SPM)
Loop 	FL-1 = Fixture Loop 	Fixture Loop two and one-half Inch (2-1/2") (must be used with TCB, HB-SPM or HBL-SPM)
Retrofit Hanger 	RH-1 = Retrofit Hanger	Cast Aluminum Hanger with Toggle Nut and Carriage Bolt for quick installation (must be used with TCB, HB-SPM or HBL-SPM)

Fixture Series	AYC	HB/AYC	SPM/RH-1 FH-1 FL-1	Single Toggle	"Y" Toggle	Loop Hanger
HBI		X	X		X	
HBE		X	X		X	
HBL		X	X		X	
I5	X		X	X		X
I8	X		X	X		X
ABI		X	X		X	
MBF	X			X	X ³	
VT1						X
VT4					X	

NOTES: 3. Continuous row mount only between fixtures.



Specifications and dimensions subject to change without notice. Consult your Cooper Lighting Representative or visit www.cooperlighting.com for available options, accessories and ordering information.

F-BAY MOUNTING METHODS

Mounting Methods	Designation	Description
	HBAYC-CHAIN/SET-U= Hook style mounting chain set for HBI, HBE, HBL and ABI	Two (2) Hook style V-hangers, thirty-six Inch (36") Chain Sets with S-hooks
"Y" Toggle 	Y-Toggle-10= Mounting Toggle and Ten Foot (10') Cable	Ten Foot (10'), Y Toggle #2 Cable
	Y-Toggle-25= Mounting Toggle and Twenty-five Foot (25') Cable	Twenty-Five Foot (25'), Y Toggle #2 Cable
Loop Hanger   Single Toggle  	Loop-10	Ten Foot (10') Loop Hanger #2 Cable
	Loop-30	Thirty Foot (30') Loop Hanger #2 Cable
	Toggle-10	Ten Foot (10') Single Toggle #2 Cable
	Toggle-30	Thirty Foot (30') Single Toggle #2 Cable



Specifications and dimensions subject to change without notice. Consult your Cooper Lighting Representative or visit www.cooperlighting.com for available options, accessories and ordering information.

F-BAY OCCUPANCY SENSORS

Aisle and 360° General Coverage (Modular)	Designation	Description
 <p>Aisle and 360° General Coverage (Modular)</p>	<p>MMS= Motion Sensor for Modular Power Supply (120-277V) ¹</p> <p>NOTES: 1. One Motion Sensor per fixture required. 2. When ordering Modular Motion Sensor, the fixture must have a Modular Receptacle (MP) and a Modular Cord or Cord and plug accessory.</p>	<p>Supplied with Mounting Box, Modular Power Supply Receptacle, Motion Sensor with three-hundred sixty degree (360°) Lens Installed, and (3) Cover Limiting Hoods (Aisle, End of Aisle, and Full Coverage).</p>
 <p>Aisle and 360° General Coverage (Installed)</p>	<p>MS= 360° or 180° Occupancy Sensor (120V-347V or 480V)</p> <div style="display: flex; justify-content: space-around;"> <div data-bbox="598 640 1015 976"> <p>360° Top View</p> <p>SideView</p> </div> <div data-bbox="1067 640 1484 976"> <p>Aisle Top View</p> <p>SideView</p> </div> </div>	<p>Passive Infra-red Sensor with 360° Lens Installed, one-hundred eighty degree (180°) Lens included with snap-on feature for in-field install.</p>

Specifications and dimensions subject to change without notice. Consult your Cooper Lighting Representative or visit www.cooperlighting.com for available options, accessories and ordering information.

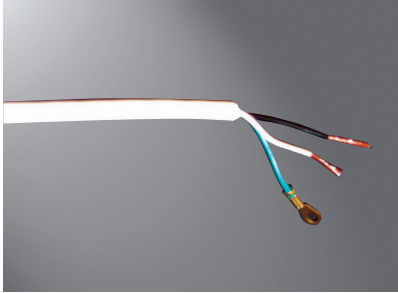
F-BAY POWER CONNECTORS

	Designation	Description
Modular Cord and Plug 	MPC3 = Three Foot (3') Modular Power Cord and Plug (specify voltage for plug)	Connect directly to F-Bay or Modular Motion Sensor with a 3', 6', 9', 12' or 15' long modular cord and plug set with NEMA 15 amp twist lock plug. F-Bay must be ordered with Modular Receptacle (MP) option in catalog logic.
	MPC6 = Six Foot (6') Modular Power Cord and Plug (specify voltage for plug)	
	MPC9 = Nine Foot (9') Modular Power Cord and Plug (specify voltage for plug)	
	MPC12 = Twelve Foot (12') Modular Power Cord and Plug (specify voltage for plug)	
	MPC15 = Fifteen Foot (15') Modular Power Cord and Plug (specify voltage for plug)	
Modular Cord 	MC3 = Three Foot (3') Cord	Connect directly to F-Bay or Modular Motion Sensor with a 3', 6', 9', 12' or 15' long 3/16" standard Modular Power Cord. F-Bay must be ordered with MP option in catalog logic.
	MC6 = Six Foot (6') Cord	
	MC9 = Nine Foot (9') Cord	
	MC12 = Twelve Foot (12') Cord	
	MC15 = Fifteen Foot (15') Cord	
MWS 	MWS = Modular Wiring System	MWS is a simple and cost effective modular wiring system consisting of factory assembled components ready to be snapped together into a complete branch circuit wiring system. With MWS, branch circuit wiring can be installed in minutes instead of hours reducing labor by 80%.
	MDS6 = Six Foot (6') Modular Power Cord with MWS 27DS18/2G06MP.	Connect directly to F-Bay or Modular Motion Sensor with a 6' Long Cord and MWS Connector. F-Bay must be ordered with MP option in catalog logic.

Specifications and dimensions subject to change without notice. Consult your Cooper Lighting Representative or visit www.cooperlighting.com for available options, accessories and ordering information.

F-BAY DOOR FRAMES AND WIREGUARDS

	Designation	Description
<p>Open</p> 	<p>Blank= No Guard</p>	<p>For maximum light output</p>
<p>I5 / I8 Lens</p> <p>Frosted Acrylic Lens</p> 	<p>I5-FRM/LENS= Frosted Acrylic Lens and Frame (use with general distribution reflector, I5 only)</p> <p>I8-FRM/FL PK= Frosted Acrylic Lens and Frame (use with general distribution reflector, I8 only)</p> <p>I5-FRM/CL PK= Clear Acrylic Lens and Frame (use with general distribution reflector, I5 only)</p> <p>I8-FRM/CL PK= Clear Acrylic Lens and Frame (use with general distribution reflector, I8 only)</p>	<p>Lens in white door frame with "Herringbone" patterned end rail</p>
<p>I5/I8 Wireguard</p> <p>Heavy Duty Wireguard</p> 	<p>WG/I5-4FT-B= Four Foot (4') Heavy Duty Wireguard (for I5)</p> <p>WG/I8-4FT-B= Four Foot (4') Heavy Duty Wireguard (for I8)</p>	<p>Finished in White. Can be used alone or in combination with other shielding</p>
<p>I5/I8 Baffle</p> <p>TBW</p> 	<p>90800PPK BAFFLE 4FT I5 WITH HDW (WHITE)= Four Foot (4') Thin Blade White Baffle (for I5)</p> <p>BAFFLE 4FT I8 (WHITE) 11571919= Four Foot (4') Thin Blade White Blade Baffle (for I8)</p>	<p>Thin Blade White Baffle with twenty-three Degree (23°) longitudinal shielding</p>
<p>I5/I8 Louver</p> <p>Asymmetric Louver</p> 	<p>90801P PK= Asymmetric Directional Louver (use with general distribution reflector)</p>	<p>Can be oriented in either direction for flexibility</p>

Specifications and dimensions subject to change without notice. Consult your Cooper Lighting Representative or visit www.cooperlighting.com for available options, accessories and ordering information.

F-BAY HBI, HBL and HBE DOOR FRAMES and WIREGUARDS

HBI Lens and Wireguard		Designation
Prismatic and Clear Acrylic Lens 		HBI-FRM/LENS PK = Prismatic Acrylic Lens and Door Frame for HBI
		HBI-FRM/CL PK = Clear Acrylic Lens and Door Frame for HBI
Wireguard 		HBI-FRM/WG PK = Frame and Wireguard for HBI
		HBI-FRM/LENS/WG PK = Frame and Prismatic Acrylic Lens with Wireguard for HBI
		HBI-FRM/CL/WG PK = Frame and Clear Lens with Wireguard for HBI
Drop Wireguard 		HBI-FRM/DROP/WG PK = Frame and Drop Wireguard for HBI
		HBI-FRM/CL/DROP/WG PK = Drop Wireguard, Clear Acrylic Lens and Door Frame for HBI
Heavy Duty Stock Wireguard 		SWG/HBI-4FT-B = Heavy Duty Wireguard for Field Installation
HBL Wireguard		Designation
Wireguard 		WG/HBL6-4FT-B = Field Installable, Wireguard for HBL 4 and 6 Lamp
		WG/HBL8-4FT-B = Field Installable, Wireguard for HBL 8 and 10 Lamp
HBE Door Frame		Designation
HBE Door Frame 		HBE-___-FRM/LENS WDF PK = Prismatic Acrylic Lens and Extruded Aluminum Door Frame ¹
		HBE-___-FRM/CL WDF PK = Clear Acrylic Lens and Extruded Aluminum Door Frame ¹
		HBE-___-FRM/LENS/WG WDF PK = Four (4) and Six (6) Lamp Frame and Prismatic Lens with Wireguard ¹
		HBE-___-FRM/LENS/WG PK = Eight (8) and Ten (10) Lamp Frame and Prismatic Lens with Wireguard ¹
		HBE-___-FRM/CL/WG PK = Four (4) and Six (6) Lamp Frame and Clear Acrylic Lens with Wireguard ¹
	HBE-___-FRM/CL/WG WDF PK = Eight (8) and Ten (10) Lamp Frame and Clear Acrylic Lens with Wireguard ¹	

NOTES: 1. Specify "4/6LT" or "8/10LT" when ordering HBE Door Frame accessories.

PRODUCT INFORMATION FOR OPTIONS - STRIPS/INDUSTRIALS

Nomenclature	Description	RCG	SNF	SSF	SNL	SSL	SNSM	SNRA	SMSL	DIF/ DMF/ DVMF	IAF/ ICF	VT1	VT2	VT3	VT4	SM/ SML	I5/ I8	HBI	2HBHD/ 2HBHT/ 2HBG	HBE/ HBL	MBF	ABI
RIF1	Radio Interference Suppressor	X	X	X	X	X	X	X	X	X	X		X			X	X	X	X	X	X	
2/RIF1	2 Suppressors	X	X	X	X	X	X	X	X	X	X		X			X	X	X	X	X	X	
PC_Voltage	Cord and Plug Attached (Specify Voltage)		X	X	X		X															
WL	Wet Location Labeled											X	X	X	X							
DD	Deep Diffuser												X									
MF	Metallic Finish																					
UPL	Uplight Apertures																X	X		X		
NUA	No Uplight Apertures																X	X				
PI/CPI	Plug-in Wiring	X	X	X	X	X	X	X	X	X	X					X	X					
TILW	Tandem In-Line Wiring (TILW)	X	X	X	X	X	X	X	X	X	X		X			X	X	X				
SSL	Stainless Steel Latches												X	X								
TEH	Top and End Hubs												X	X								
TH	Top Hub Only												X	X								
IB/OB	Inboard/Outboard (Three (3) Lamp only)									X												
POX	Porlux Reflector Finish									X	X											
PC6	Power Cord Six Foot (6')																X	X		X	X	
PC3	Power Cord Three Foot (3')																X	X		X	X	
MS	Motion Sensor (Aisle Coverage)																X	X	X	X	X	
REP	Riveted End Plate	X	X	X		X	X	X		X	X					X						
1IN/MLAB	One Inch (1") Mark Labels	X	X	X	X	X	X	X	X	X	X		X			X	X	X	X			
2IN/MLAB	Two Inch (2") Mark Labels	X	X	X	X	X	X	X	X	X	X		X			X	X	X	X			
PAF	Painted After Fabrication		X	X	X	X	X	X	X	X	X											
GL or GM	Single or Double Element Fuse	X	X	X	X	X	X	X	X	X	X		X			X	X	X	X	X	X	

NOTES: 1. For HBE/HBL, use HBL-SPM for single mount option.

PACKAGING (REQUIRED)

Nomenclature	Description	RCG	SNF	SSF	SNL	SSL	SNSM	SNRA	SMSL	DIF/ DMF/ DVMF	IAF/ ICF	VT1	VT2	VT3	VT4	SM/ SML	I5/ I8	HBI	2HBHD/ 2HBHT/ 2HBG	HBE/ HBL	MBF	ABI
U	Unit Pack	X	X	X	X	X	X	X	X	X	X		X			X	X	X	X	X	X	
2B	Two (2) Bulk																					
4B	Four (4) Bulk			X						X	X											
6B	Six (6) Bulk		X																			
PAL	Palletized out of carton on a 25" x 48" pallet, shrink wrapped																X	X	X	X	X	
PALC	Palletized in carton on a 25" x 48" pallet, shrink wrapped																X	X	X	X	X	

Specifications and dimensions subject to change without notice. Consult your Cooper Lighting Representative or visit www.cooperlighting.com for available options, accessories and ordering information.

MASTER - SATELLITE WIRING

Description

The Master-Satellite option offered by Metalux is a simple solution for easier installation and energy efficiency. The new ordering nomenclature makes ordering master-satellite fixtures very simple. It is not necessary to specify two part numbers for both master and satellite. Instead, one simple part number provides both the master and the satellite as a combination. The ordering nomenclature is added to the end of the ballast description in fixture part number. Below is the ordering logic showing how Master-Satellite option is specified.

METALUX MASTER - SATELLITE NOMENCLATURE

SAMPLE NUMBER: 2GC-332A-UNV-EB82/MS9L-U

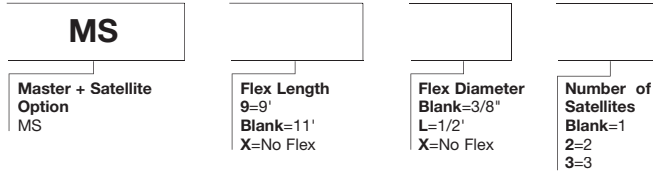

SAMPLE NUMBER: GC-132A-UNV-EB81/MS-U

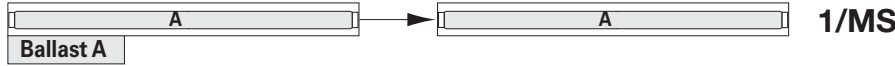

SAMPLE NUMBER: GC-232A-UNV-EB81/MS-U

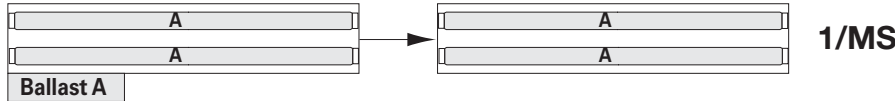

SAMPLE NUMBER: GC-232A-UNV-EB82/MS-U

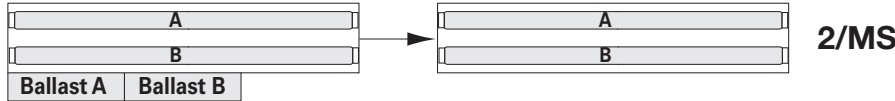

SAMPLE NUMBER: 2GC-332A-UNV-EB82/MS-U

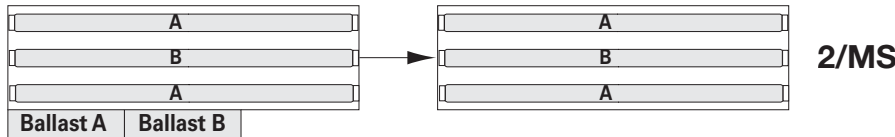

SAMPLE NUMBER: 2GC-332A-UNV-EB83/MS-U

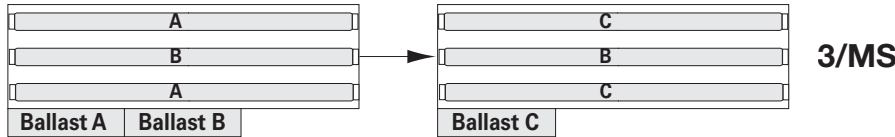

SAMPLE NUMBER: 2GC-332A-UNV-EB83/MS-TILW-U

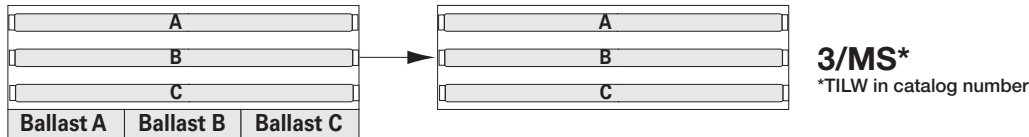

SAMPLE NUMBER: 2GC-432A-UNV-EB82/MS-U

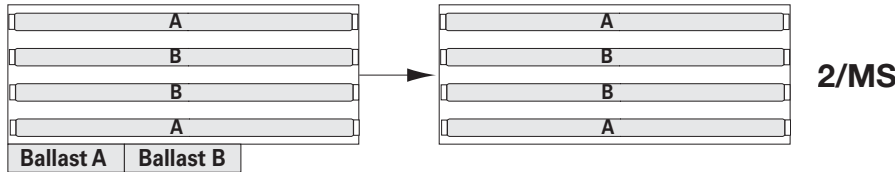

SAMPLE NUMBER: SSF-132-UNV-EB81/MSX2-U



SAMPLE NUMBER: SSF-132-UNV-EB81/MSX3-U

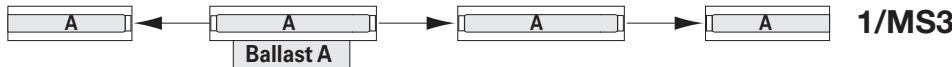

Specifications and dimensions subject to change without notice. Consult your Cooper Lighting Representative or visit www.cooperlighting.com for available options, accessories and ordering information.

WIRING

Flex 3/8" factory prewired Flex installed into fixture access plate. Various wire gauges and number of wires available in six foot (6') lengths.

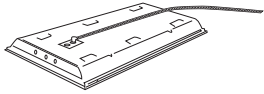

The Flex set consists of the following:

- One wago connector per wire
- Six feet (6') of steel flex
- Eighteen (18) gauge TFN wire, seven foot (7') leads, exposing six inches (6") out of each end
- One ninety degree (90°) flex connector
- One straight-in flex connector
- One access plate

ORDERING INFORMATION

SAMPLE NUMBER: A3/8-2/18G

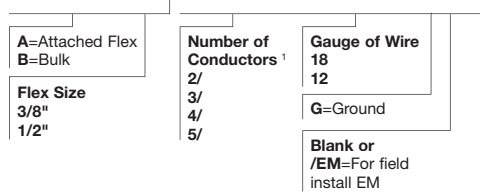

Commonly Used Flex	Number of Wires	Number of Circuits	Gauge of Wire	Wires					
				GREEN (ground)	WHITE (neutral)	BLACK (hot)	RED (hot)	BLUE (hot)	RED/BLACK (hot)
A3/8-2/12G	3	1	12	X	X	X			
A3/8-2/18G	3	1	18	X	X	X			
A3/8-3/12G	4	2	12	X	X	X	X		
A3/8-3/18G/EM	5	2 with EM	18	X	X	X		X	
A3/8-4/18G	5	3	18	X	X	X	X		X
A3/8-4/18G/EM	6	3 with EM	18	X	X	X	X	X	

NOTES: 1. For fixtures with emergencies, extra conductor must be added to accommodate hot lead for EM.

WIRING

Cord and Plug



ORDERING INFORMATION

SAMPLE NUMBER: 6-3/18SJT-CandP-515P

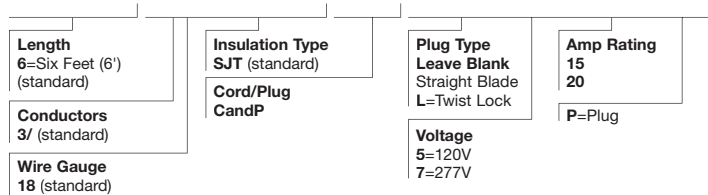

ATTACHED MODULAR WIRING OPTION



Description

MWS (Modular Wiring System) is a component system that provides a low cost and labor saving alternative to conventional hardwiring. The system uses interchangeable modular components, offering portability and versatility in lighting configurations. Metalux offers MWS installed on select fixtures. Below is the ordering instructions for adding MWS installed to Metalux fixtures. MWS offers a complete system of components for all of your wiring for lighting, as well as power. See the MWS section of this catalog (Page 11-1) for additional components.

MWS

COMMERCIAL APPLICATIONS

ORDERING INFORMATION FOR RECESSED LAYIN FIXTURES

SAMPLE NUMBER: 2GC8-232A-120V-EB81-MW12FF2GSL

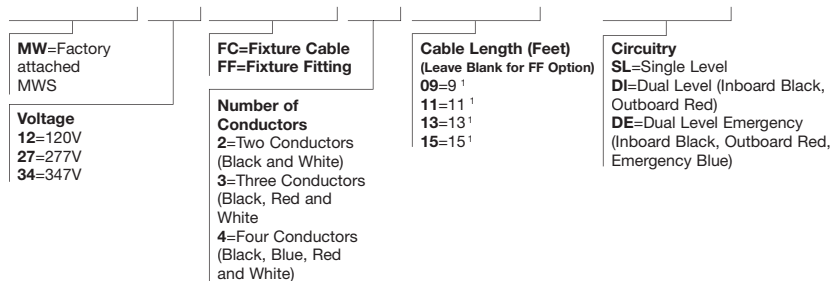

INDUSTRIAL APPLICATIONS

ORDERING INFORMATION FOR INDUSTRIALS AND STRIPS

SAMPLE NUMBER: I5-254T5-120V-EBT1-MW12DS12/2G11

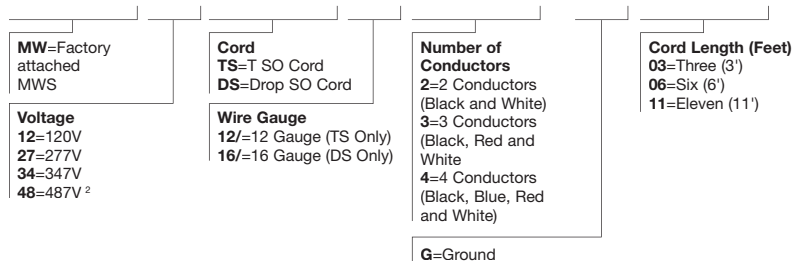

NOTES: 1. For FC option only. 2. Consult factory when specifying 480V.

TANDEM IN-LINE WIRING (TILW) OPTIONS

Description

The Tandem In-Line Wiring option provides factory installed wiring when fixture sections are applied in pairs, and require left/right lamp switching. To explain, ballast receive their power from the circuit, with lamps getting their power from the ballast. TILW is the method of applying power from the ballast to specific lamps. TILW only applies to two (2) or more lamp cross sections. If the luminaire has only one (1) row of lamps, TILW is already present and unnecessary to specify. The TILW option is available on IAF/ICF, DIF/DMF/DVMF, SSF, SSL, SNF, SNSM, SNRA, RCG and I5/I8.

The following ballast configuration does not allow for TILW:

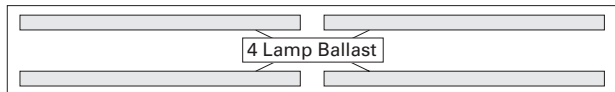

8TSSF-232-xxx-EB81

The following ballast configuration does not allow for TILW:

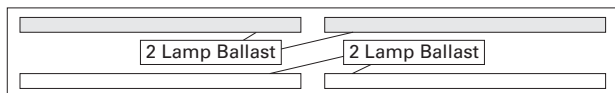

8TSSF-232-xxx-EB82-TILW

The TILW can also be used in applications where Master-Satellite configurations are required. Simply specify the appropriate Master-Satellite description followed by TILW. Standard TILW is provided with push-in connectors (shown below) for fixture wiring connections. Optional PITLW is provided with pre-configured wiring harness for quick and easy installation of Master-Satellite tandem in-line wired fixtures. Shown below is an example of a ballast configuration, along with sample fixture catalog number, including Master-Satellite and TILW.

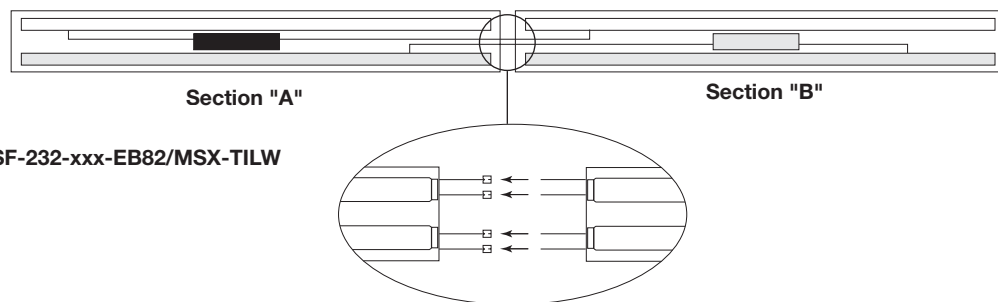

SSF-232-xxx-EB82/MSX-TILW

CROSS-OVER PLUG-IN SYSTEM WITH TWO (2) OR THREE (3) CIRCUIT CAPABILITY (CPI) OPTIONS

Description

The Metalux CPI Option has been designed to provide cross-circuit wiring capability. This versatile design internally routes power to the appropriate fixtures and requires only one luminaire type for the entire installation. It is no longer necessary to specify unique circuit wiring (black, blue, red) for each fixture. The new self-locking plug is designed to fit through a standard 7/8" knock-out to simplify the installation process.

Ordering the CPI Option is now much easier. One wiring harness type is required per row-mounted fixture. There is no need to color code. The black wire is always factory wired to the ballast lead and power routing to appropriate fixtures is achieved through the wiring design.

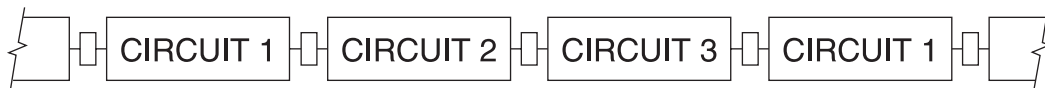

Example: A 3-circuit installation with a quantity of 200 SSF-296-120V-EB81 fixtures with ground wire.

Requires: Qty: 200 Fixture: SSF-296-120V-EB81-CPI3-WG

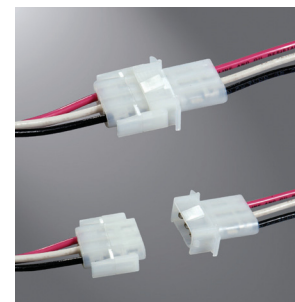

FEATURES

- Installed savings
- Molded nylon polarized plugs
- Two (2) or three (3) circuit capabilities
- No need to color code
- Self-locking plugs
- Branch circuit conductors #12 THHN rated 600V, 90C
- UL Listed.

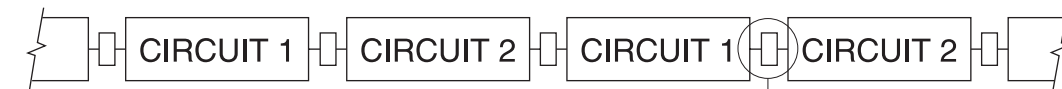

Example: A 2-circuit installation with a quantity of 200 SSF-296-120V-EB81 fixtures with ground wire.

Requires: Qty: 200 Fixture: SSF-296-120V-EB81-CPI2-WG

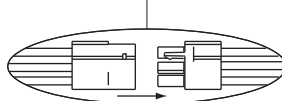

CPI - Cross Over Plug-In

SAMPLE NUMBER: CPI2-WG

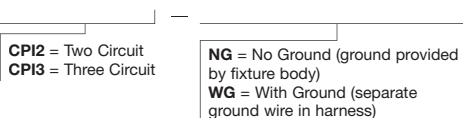

Specifications and dimensions subject to change without notice. Consult your Cooper Lighting Representative or visit www.cooperlighting.com for available options, accessories and ordering information.

PLUG-IN (PI) SYSTEM WITH 1, 2 OR 3 CIRCUIT CAPABILITY

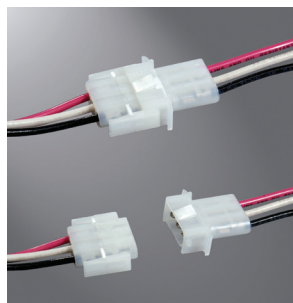

FEATURES

- Advanced plug-in system
- Three circuit capacity
- Installation savings
- Molded nylon polarized plugs
- Self-locking plugs
- Independent neutral available
- Branch circuit conductors #12 THHN rated 600V, 90°C
- UL Listed

PI PLUG-IN

Description

The Plug-In System provides factory installed branch circuit wiring and plug-in connectors when row mounting fixtures. This labor and time saving option is designed to simplify fixture installation and wiring and allows fixtures to be installed quickly and easily. The PI system is available for fixture sections up to 8' in length for continuous row wiring by simply plugging the sections together. Each PI section is factory wired to the ballast leads and is color coded for easy circuit identification. Standard PI system harness contains no separate ground wire, with ground provided by the fixture body. An option to the system provides a separate ground wire in the harness where required.

ORDERING INFORMATION

Catalog Number Suffix	Number of Circuits	Circuit Wired to Ballast
PI 1 BLK	1	Black
PI 2 BLU	2	Blue
PI 2 BLK	2	Black
PI 3 RED	3	Red
PI 3 BLU	3	Blue
PI 3 BLK	3	Black

When ordering the PI2/PI3 System it is necessary to specify the number of fixtures required for each circuit.

Example: 200 (Fixture Quantity) SSF-296-120V-PI2

Requires:

100 (Fixture Quantity) SSF-296-120V-PI2/BLK

100 (Fixture Quantity) SSF-296-120V-PI2/BLU

SSF-296-PI1=Specify wire color of BLK for single circuit PIs since all the ballast leads will be wired to the black and white wires.

SSF-296-PI2BLK=Two (2) circuit PI with ballast leads wired to black and white wires

SSF-296-PI2BLU=Two (2) circuit PI with ballast leads wired to blue and white wires

SSF-296-PI3RED=Three (3) circuit PI with ballast leads wired to red and white wires

The Plug-In System is available on fixtures using Rapid Start, Slimline (430 MA), High Output (800 MA), or Power Groove (1500 MA) lamps up to twenty (20) amps per circuit.

Available on the following fixture series:

Industrials

- IAF/ICF Series
- DIF/DMF /DVMF Series
- I5/I8

Strips

- SNF/SSF Series
- SNSM, SRA Series
- RCG Series
- SM/SML

Wraps are available with PI1 option only. For other fixture series availability consult factory.

PI1 - Single Circuit Plug-In

SAMPLE NUMBER: PI1BLK-WG

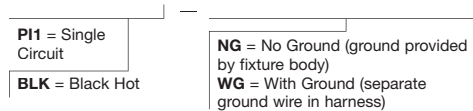

PI2 - Two Circuit Plug-In

SAMPLE NUMBER: PI2BLK-WG

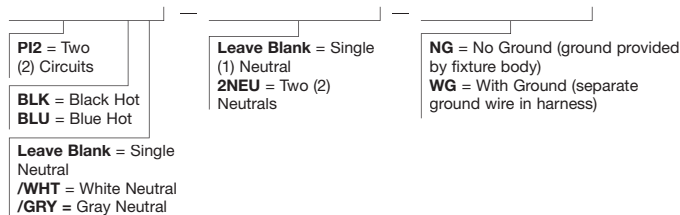

PI3 - Three Circuit Plug-In

SAMPLE NUMBER: PI3BLK-WG

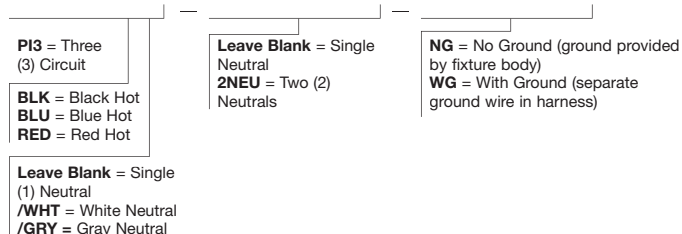

Specifications and dimensions subject to change without notice. Consult your Cooper Lighting Representative or visit www.cooperlighting.com for available options, accessories and ordering information.

TROUBLESHOOTING GUIDE

Fluorescent lighting is a very reliable and efficient source of lighting. Should problems occur use the quick reference guide to address them appropriately.

Symptom	Solution
Lamp(s) will not start or starts slow and erratic	<ol style="list-style-type: none"> 1. Confirm lamps are completely seated into sockets. 2. Confirm fixture is properly grounded (fixture must be grounded for reliable starting). 3. Confirm fixture is properly connected to power supply and check wiring and electrical connections. 4. Confirm fixture is receiving correct voltage. 5. Replace lamps. 6. Replace ballast.
Lamp(s) are flickering, snaking* or very dim	<ol style="list-style-type: none"> 1. Confirm all electrical connections inside fixture. 2. Confirm proper voltage at supply connection. 3. Confirm ambient temperature is above 50°F. Air conditioner or fans should not blow directly on lamps. A ballast rated for cold starting may need to be installed if necessary. 4. Replace ballast.
Electronic interference	<ol style="list-style-type: none"> 1. Electronics should be at least 8' from fluorescent ballast. More distance is recommended if interference persists. 2. Install an electronic interference filter. 3. Improve electronic equipment grounding. 4. Consult qualified electrician.
Repeated cycling (on/off)	<ol style="list-style-type: none"> 1. Confirm correct lamp wattage (check ballast label). 2. Confirm fixture temperature does not exceed rating. 3. Confirm all electrical connections inside fixture. 4. Confirm proper voltage at supply connection. 5. Replace ballast.

*Fluorescent lamps may experience starting problems when ambient temperature is below 50° F.

*New lamp with less than 100 hours of operation may exhibit flicker, strobing or snaking.



Metalux lighting solutions are designed to suit even the most discerning taste. Metalux offers an extensive line of fluorescent and LED lighting products including parabolics, lensed, recessed, surface, strip and industrial fixtures.

Metalux



Heavy-gauge steel construction, durable finishes and high-quality electrical assemblies ensure years of performance integrity for commercial, educational, retail and healthcare settings. Metalux also offers an energy-efficient residential line available in an array of styles and sizes for general, cove, task and undercabinet needs.

SEE PAGE 7-113 FOR NEW PRODUCTS.



ARCHITECTURAL



Accord LED Series
Page 7-5



AC Accord Series
Page 7-6



2ACS Accord Series
Page 7-7



AC2 Accord II Series
Page 7-8



ArcLine Series
Page 7-9



RDIA Ovation Series
Page 7-10



RDI, 2RDI Ovation Series
Page 7-11



RWW Series
Page 7-13

INDUSTRIALS



Cricket SM, SML Series
Page 7-14



F-Bay HBI Series
Page 7-15



F-Bay HBE Series
Page 7-16



F-Bay HBL Series
Page 7-17



F-Bay 2HBG Series
Page 7-18



F-Bay 2HBHD Series
Page 7-19



F-Bay 2HBHT Series
Page 7-20



ABI Arctic Bay Series
Page 7-21



F-Bay I5 Series
Page 7-22



F-Bay I8 Series
Page 7-23



F-Bay MBF Micro-Bay Series
Page 7-24



Vaportite LED Series
Page 7-25



VT4 Series
Page 7-26



VT3 Series
Page 7-27



VT1 Series
Page 7-28



IAF, ICF Series
Page 7-29

PARABOLICS



DIF Series
Page 7-30



DMF Series
Page 7-31



DVMF Series
Page 7-32



OpticaHP Series
Page 7-33



2HP2 Series
Page 7-34



2HP3 Series
Page 7-35



2EP3GAX Series
Page 7-36



2P2GAX Series
Page 7-37

RESIDENTIAL



2PGAX Series
Page 7-38



2P5GAX Series
Page 7-39



P3 Series
Page 7-40



PMX Series
Page 7-41



Shop Light Series
Page 7-42



Circline Decorative Series
Page 7-43



Circline Utility Series
Page 7-43



Decorative Series
Page 7-44



Small Circline Decorative Series
Page 7-45



Wall Bracket, Undercabinet Series
Page 7-46



WP Series
Page 7-47



Wraparound Oak Trim Series
Page 7-48



WSC Series
Page 7-49

SEE PAGE 7-113 FOR NEW PRODUCTS.

RETROFIT



Industrial Retrofit Kit (ECS)
Page 7-50

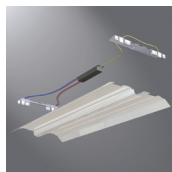

Commercial Retrofit Kit (ART)
Page 7-51

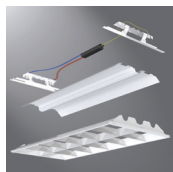

OpticalHP Retrofit Kit (ART)
Page 7-52

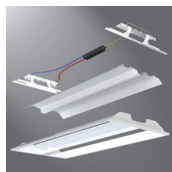

ArcDuo, Cruze Retrofit Kits (ART)
Page 7-53

STRIPS



RCG Series
Page 7-54



SNF Series
Page 7-55



SSF Series
Page 7-57



SMF Series
Page 7-59

SURFACE



SNL, SSL Series
Page 7-60



SNSM, SNRA, SMSL Series
Page 7-61



M Series
Page 7-62



SA Series
Page 7-63

TROFFER



GC Series
Page 7-64



GC8 Series
Page 7-65



GR5 Series
Page 7-66



GR8 Series
Page 7-67

WALL - UNDERCABINET



GCAFA Series
Page 7-68



2GCAML Series
Page 7-69



BA, BAU Series
Page 7-70



BE, BEU Series
Page 7-71



BC Series
Page 7-72



BI, BIU Series
Page 7-73



CL, UC Series
Page 7-74

WRAPS



CR Series
Page 7-75



WN Series
Page 7-76



WS Series
Page 7-77



WSC Series
Page 7-78

OPTIONS AND ACCESSORIES

Commitment Kit (CKIT) Accessory..... 7-79
 Louver and Lens Options..... 7-80
 Ceiling Compatibility..... 7-81
 Drywall Framing Kit (DF) Series Options..... 7-83
 Standard Product Options and Accessories..... 7-84
 Parabolic, Recessed and Surface Options and Accessories..... 7-85
 Lamp Options..... 7-87
 Emergency Options - Parabolics and Recessed..... 7-88
 Emergency Surface Options..... 7-89
 Strips - Industrials Emergency Options..... 7-90
 Extended Options..... 7-91
 Strip Reflector Accessories..... 7-93
 Strips and Industrials Options and Accessories..... 7-96
 F-Bay Mounting Accessories..... 7-99
 F-Bay Mounting Methods..... 7-100
 F-Bay Occupancy Sensors..... 7-101
 F-Bay Power Connections..... 7-102
 F-Bay I5, I8 Door Frames and Wireguards..... 7-103
 F-Bay HBI, HBL, HBE Door Frames and Wireguards..... 7-104
 Strips and Industrials Extended Options..... 7-105
 Strips and Industrials Packaging Options..... 7-106
 Master - Satellite Wiring Options..... 7-107
 Wiring Options..... 7-108
 MWS Wiring Options..... 7-109
 Tandem In-Line Wiring (TILW) Options..... 7-110
 Cross-over Plug-in (CPI) Options..... 7-110
 Plug-In (PI) System Options..... 7-111
 Troubleshooting Guide..... 7-112

SEE PAGE 7-113 FOR NEW PRODUCTS.

COMMERCIAL SPECIFICATION LED TROFFER



FEATURES

- Available in 1' x 4', 2' x 2' and 2' x 4' recessed versions
- Advanced optical control
- High performance efficacy up to 109 lumens per watt
- Over 45% energy savings when compared to fluorescent troffers
- Three CCT options: 3000K, 3500K and 4000K at 85 CRI
- Four stocked lumen packages offered along with multiple MTO options
- Standard 0-10V continuous dimming driver
- L70 at 50,000 hours
- Shallow depth housing (3.25") with tool-less driver access from below

DIMENSIONS

1' x 4', 2' x 2', 2' x 4'

ACCORD LED SERIES

Compliances may not apply to all product configurations. Please consult the product spec sheet for compliance details.

COMPLIANCES: UL/cUL Listed, NOM Certified, IC Rated, LM79 and/or LM80 Tested, City of Chicago Approved



ORDERING INFORMATION

SAMPLE NUMBER: 24AC-LD3-55-UNV-L835-CD1-U

Rating	Series	Type	Lamp Type	LED Lumens Output		
[Blank]=Standard ATW-SW4=Air-Tight Wire Way (Chicago Rated)	22AC=Accord Series (2' x 2') 22ACS=Accord Surface Series (2' x 2') ¹ 24AC=Accord Series (2' x 4') 24ACS=Accord Surface Series (2' x 4') ¹ AC=Accord Series (1' x 4')	[Blank]=Standard A=Air (Vented) ²	LD3=LED 3.0	1' x 4' MTO 19=1900 Lumens ³ 25=2500 Lumens ³ 29=2900 Lumens 35=3500 Lumens 39=3900 Lumens	2' x 2' Stock 23=2300 Lumens ³ 34=3400 Lumens MTO 18=1800 Lumens ³ 27=2700 Lumens 38=3800 Lumens	2' x 4' Stock 48=4800 Lumens 55=5500 Lumens MTO 31=3100 Lumens 36=3600 Lumens 39=3900 Lumens 63=6300 Lumens 68=6800 Lumens 73=7300 Lumens
Shielding	Voltage ⁴	Options ⁵		CCT	Options	
[Blank]=Frosted Acrylic (Standard) RDP=Lens with Round Pattern Insert SQP=Lens with Square Pattern Insert	UNV=Universal Voltage 120-277	Emergency EL=Emergency Installed, 700 Lumens EL14=Emergency Installed, 1400 Lumens		L830=3000K L835=3500K L840=4000K	Flex Flex=Multiple Configurations Available	
Driver Type	Number of Drivers	Packaging		Accessories (Order Separately)		
CD=0-10V Dimming Driver (Standard) 5LTD=Fifth Light (DALI) Driver ⁶	1=1 Driver	PALC=Job Pack, in Carton U=Unit Pack		EQ-CLIP-U=T-BAR Safety Earthquake Clips ⁷ T3A END E.Q. BRACKET PARTS BAG=Earthquake Brackets DF-14-W=1' x 4' Drywall Frame Kit DF-22-W=2' x 2' Drywall Frame Kit DF-24-W=2' x 4' Drywall Frame Kit		

NOTES: 1. Surface mount Accord is not designed for continuous row mount applications. 2. Must specify voltage (120V or 277V) when selecting Air option. Air versions are not designed for continuous row mount applications. 3. Not available with a Fifth Light (DALI) driver. 4. Products also available in non-US voltage and frequencies for international markets. 5. Must specify voltage (120V or 277V) when selecting EL option. 6. For a complete listing of Fifth Light Technology products and other solutions from Cooper Controls, visit www.coopercontrol.com. 7. An EQ Grid Clip is recommended for all 9/16" ceiling systems.

1' x 4' RECESSED

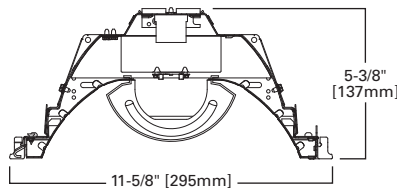

2' x 2', 2' x 4' RECESSED

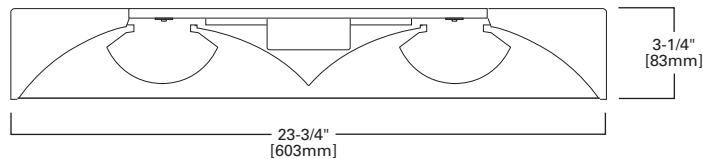

2' x 2' SURFACE

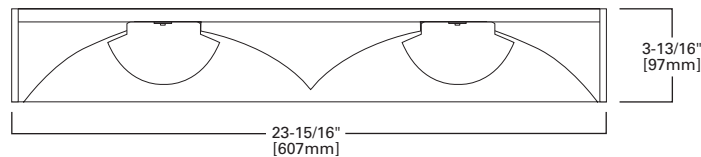

Specifications and dimensions subject to change without notice. Consult your Cooper Lighting Representative or visit www.cooperlighting.com for available options, accessories and ordering information.

FEATURES

- Improved visual perception and increased comfort levels
- Attractive contemporary design
- Significant energy savings
- T5 or T8 lamps
- Shallow depth and structural integrity for quick installation
- Remove refractor for simple lamp maintenance
- Ballast can be removed from below without tools
- Dark spots associated with parabolics eliminated

DIMENSIONS

1' x 4', 2' x 2', 2' x 4'

Compliances may not apply to all product configurations. Please consult the product spec sheet for compliance details.

COMPLIANCES: UL/cUL Listed - Damp Location, NOM Certified, IC Rated, City of Chicago Approved



AC ACCORD SERIES



ORDERING INFORMATION

SAMPLE NUMBER: 2AC-232-UNV-EB82-U

Rating	Width	Series	Type	Number of Lamps (Not Included) ⁵	Wattage (Length)	Shielding	Voltage ⁶
[Blank]=Standard ATW-SW4=Chicago Rated	2=2' Width [Blank]=1' Width ^{1,2}	AC=Accord Series	A=Air (Optional) ³ IC=IC Rated ⁴	1=1 Lamp 2=2 Lamps	14T5=14W T5 (24") 17=17WT8 (24") 24T5=24W T5HO (24") 28T5=28W T5 (48") 32=32W T8 (48") 54T5=54W T5HO Lamps (48") BX40=40W Compact Fluorescent (24")	[Blank]=Frosted Acrylic (Standard) RDP=Lens with Round Pattern Insert SQP=Lens with Square Pattern Insert	024V=24 Volt DC ⁷ 120V=120 Volt 277V=277 Volt 347V=347 Volt UNV=Universal Voltage 120-277 ^{8,9}

Options	Lamps
EL=Emergency Installed (Must Specify Battery Pack, See Options) ⁹ Flex=Flex Installed (Reference Flex Ordering Information) GL=Single Element Fuse GM=Double Element Fuse LVDC10=Low Voltage 10 Foot DC Connector and Cable Assembly LVDC5=Low Voltage 5 Foot DC Connector and Cable Assembly	L5835=T5 Lamp, 3500K L5835HL=T5 Lamp, 28W, 3500K, 2900 Lumens L5841=T5 Lamp, 4100K L5841HL=T5 Lamp, 28W, 4100K, 2900 Lumens L8835=T8 Lamp, 17W and 32W, 3500 K L8835HL=T8 Lamp, 32W, 3500K, 3100 Lumens L8841=T8 Lamp, 17W and 32W, 4100K L8841HL=T8 Lamp, 32W, 4100K, 3100 Lumens

Ballast Type	
<p>Biax Ballasts EB5_=T5 Biax Electronic Instant Start. Total Harmonic Distortion < 20%.</p> <p>T5 Ballasts EBT_=T5 or T5HO Electronic Program Rapid Start. Total Harmonic Distortion < 10%. Standard Ballast Factor=1.0</p> <p>Ballast/Factor Type (T5) EBT_H=T5 Electronic Program Rapid Start. Total Harmonic Distortion < 10%. High Ballast Factor=1.15^{14,15} EBT_HDIM=T5 Electronic Program Rapid Start. Total Harmonic Distortion < 10%. Step Dimming, High Ballast Factor=1.15^{16,17} EBT_N=T5 Electronic Program Rapid Start. Total Harmonic Distortion < 10%. Normal Ballast Factor=.90¹⁵ EBT_NDIM=T5 Electronic Program Rapid Start. Total Harmonic Distortion < 10%. Step Dimming, Normal Ballast Factor=.95-1.0^{18,16,17}</p> <p>Ballast Factor/Type (For 14W T5 Lamp Only) [Blank]=Standard H=High Light Output 1.15 BF¹⁰ HDIM=High 1.15 BF Step Dimming¹⁰ N=Normal Light Output .95 BF¹¹</p>	<p>Ballast Factor/Type (For 24VDC Only) DC5_Dim=T5 24VDC Dimming 0-10V, Ballast Factor=1.0¹² DC8_DIM=T8 24VDC Dimming = 0-10V, Ballast Factor=0.75¹³</p> <p>T8 Ballasts EB8_=T8 Electronic Start. Total Harmonic Distortion < 10% EB8_/PLUS=T8 Electronic Start. Total Harmonic Distortion < 10%. High Ballast Factor > 1.15 ER8_=T8 Electronic Program Rapid Start. Total Harmonic Distortion < 10%</p> <p>High Performance T8 Ballasts HB8_=T8 Electronic Instant Start. Total Harmonic Distortion < 10%. Standard Ballast Factor .86 - .88 HB8_H=T8 Electronic Instant Start. Total Harmonic Distortion < 10%. High Ballast Factor 1.15 - 1.20 HB8_L=T8 Electronic Instant Start. Total Harmonic Distortion < 10%. Low Ballast Factor .77 - .82 HB8_N=T8 Electronic Instant Start. Total Harmonic Distortion < 10%. Normal Ballast Factor 1.0 HR8_=T8 Electronic Program Rapid Start. Total Harmonic Distortion < 10%. Standard Ballast Factor .86 - .88 HR8_DIM=T8 Electronic Program Rapid Start. Total Harmonic Distortion < 10%. Step Dimming, Ballast Factor .88 HR8_H=T8 Electronic Program Rapid Start. Total Harmonic Distortion < 10%. High Ballast Factor 1.15 - 1.20 HR8_L=T8 Electronic Program Rapid Start. Total Harmonic Distortion < 10%. Low Ballast Factor .71 - .79</p>

Number of Ballasts	Packaging	Accessories (Order Separately) ^{19,20}
1=1 Ballast 2=2 Ballasts 3=3 Ballasts	PALC=Job Pack, in Carton U=Unit Pack	T3A END E.Q. BRACKET PARTS BAG=Earthquake Brackets

NOTES: 1. 1' x 4' Accord is not designed for continuous row mount applications. 2. IC Rated option not available. 3. Air option is not available with 1' x 4'. 4. IC version is only available in T5 lamp fixtures. 5. Stem Mounting not available on 3-lamp fixtures. 6. Products also available in non-US voltage and frequencies for international markets. 7. 24VDC version is iMerge Alliance® Registered (available in 2 lamp version only). 8. Not available when specifying emergencies, voltage must be specified. 9. See options section. 10. Step Dimming ballast available for 2 or 3 14WT5 lamps only. 11. .95 ballast factor available for 14WT5 lamps only. 12. For Emerge 2' x 2' T5HO = one lamp ballast only. 13. For Emerge 2' x 4' T8 1.0 Ballast Factor, two ballast must be ordered. 14. 1-Lamp ballast in a High Ballast factor not available. 15. .90 ballast factor available for 2 or 3 28W T5 lamps only. 16. Step Dimming ballast available for 2 or 3 28W T5 lamps only. 17. Step dimming ballast available for 2 or 3 lamp 14WT5 lamps only. 18. 1-Lamp step dimming ballast in a Normal Ballast factor not available. 2-Lamp ballast will not operate 1-Lamp. 19. For complete product data, reference the Fluorescent Specification binder. Specifications and dimensions subject to change without notice. Consult your Cooper Lighting Representative for availability and ordering information. 20. Specifications and dimensions subject to change without notice.

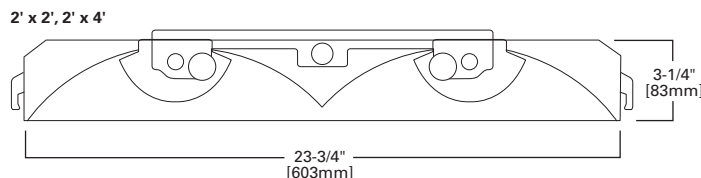
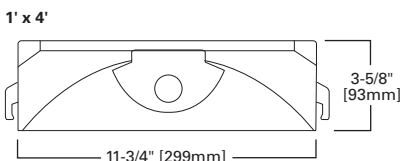

Specifications and dimensions subject to change without notice. Consult your Cooper Lighting Representative or visit www.cooperlighting.com for available options, accessories and ordering information.

SURFACE MOUNT COMMERCIAL SPECIFICATION T5 TROFFER



FEATURES

- Surface mount units designed for non-grid ceiling systems
- Low-profile housing is formed from cold rolled steel
- Class P ballasts are positively secured to housing
- Baked matte-white, polyester powder-enamel finish
- High-reflectant and luminous uniform reflector
- 2" wiring access hole for centered junction box
- Positively retained frosted acrylic profile lenses; three options
- Ballast can be removed from below without tools
- Backplate provided with knockouts and mounting holes for surface mount

DIMENSIONS

2' x 2', 2' x 4'

2ACS ACCORD SERIES

Compliances may not apply to all product configurations. Please consult the product spec sheet for compliance details.

COMPLIANCES: UL/cUL Listed - Damp Location, NOM Certified



ORDERING INFORMATION

SAMPLE NUMBER: 2ACS-228T5-UNV-L5841-EBT1-U

Width	Series	Type	Number of Lamps (Not Included)	Wattage (Length)	Shielding	Voltage ²
2=2' Width	AC=Accord Series	S=Surface Mount ¹	2=2 Lamp	14T5=14W T5 (24") 24T5=24W T5HO (24") 28T5=28W T5 (48") 54T5=54W T5HO (48")	[Blank]=Frosted Acrylic (Standard) RDP=Lens with Round Pattern Insert SQP=Lens with Square Pattern Insert	UNV=Universal Voltage 120-277
Options		Lamps	Ballast Type			
EL=Emergency Battery Installed (Must Specify Battery Pack, See Options) Flex=Flex Installed (Reference Flex Ordering Information) GL=Single Element Fuse GM=Double Element Fuse		L5835=T5 Lamp, 3500K L5835HL=T5 Lamp, 28W, 3500K, 2900 Lumens L5841=T5 Lamp, 4100K L5841HL=T5 Lamp, 28W, 4100K, 2900 Lumens	T5 Ballasts EBT=T5 of T5HO Electronic Program Rapid Start. Total Harmonic Distortion < 10%. Standard Ballast Factor=1.0 Ballast/Factor Type (T5) EBT_H=T5 Electronic Program Rapid Start. Total Harmonic Distortion < 10%. High Ballast Factor=1.15 ³ EBT_HDIM=T5 Electronic Program Rapid Start. Total Harmonic Distortion < 10%. Step Dimming, High Ballast Factor=1.15 ^{4,5} EBT_N=T5 Electronic Program Rapid Start. Total Harmonic Distortion < 10%. Normal Ballast Factor=.90 ^{6,7} EBT_NDIM=T5 Electronic Program Rapid Start. Total Harmonic Distortion < 10%. Step Dimming, Normal Ballast Factor=.95-1.0 ⁸			
Number of Ballasts		Packaging				
1=1 Ballast 2=2 Ballasts		PALC=Job Pack, in Carton U=Unit Pack				

NOTES: 1. Surface mount Accord is not designed for continuous row mount applications. 2. Products also available in non-US voltage and frequencies for international markets. 3. 1-Lamp ballast in a High Ballast factor not available. 4. Step Dimming ballast available for 2 or 3 14WT5 lamps only. 5. Step Dimming ballast available for 2 or 3 28W T5 lamps only. 6. .90 ballast factor available for 2 or 3 28W T5 lamps only. 7. .90 ballast factor available for 2 or 3 14W T5 lamps only. 8. 1-Lamp step dimming ballast in a Normal Ballast factor not available. 2-Lamp ballast will not operate 1-Lamp.

2' x 2', 2' x 4'

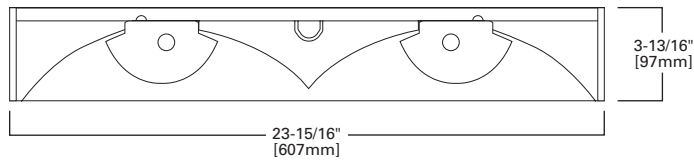

Specifications and dimensions subject to change without notice. Consult your Cooper Lighting Representative or visit www.cooperlighting.com for available options, accessories and ordering information.

FEATURES

- Attractive contemporary design
- T5 or T8 lamps
- Increases comfort levels while providing energy savings
- White or semi-specular baffle
- Shallow depth and tool-less design for quick installation
- Hinged and latched door frame for simple lamp maintenance
- Knockouts for continuous row mounting
- Large access plate for supply connection

DIMENSIONS

2' x 2', 2' x 4'

Compliances may not apply to all product configurations. Please consult the product spec sheet for compliance details.

COMPLIANCES: UL/cUL Listed - Damp Location, NOM Certified, ARRA Compliant



AC2 ACCORD II SERIES



ORDERING INFORMATION

SAMPLE NUMBER: 2AC2-228T5BI-UNV-EBT1-U

Width	Series	Number of Lamps (Not Included)	Wattage (Length)	Shielding	Voltage ¹
2=2' Width	AC2=Accord II Series	2=2 Lamps	14T5=14W T5 (24") 17=17W T8 (24") 24T5=24W T5HO (24") 28T5=28W T5 (48") 32=32W T8 (48") 54T5=54W T5HO (48")	BI=Frosted Lens and Semi-Specular Baffle BP=Frosted Lens and White Baffle	UNV=Universal Voltage 120-277
Options		Ballast Type		Number of Ballasts	Packaging
EL=Emergency Installed (Must Specify Battery Pack, See Options) Flex=Flex Installed (Reference Flex Ordering Information) GL=Single Element Fuse GM=Double Element Fuse Lamps=Lamps Installed (Refer to Lamp Ordering Options)		T5 Ballasts EBT_=T5 or T5HO Electronic Program Rapid Start. Total Harmonic Distortion < 10%. Standard Ballast Factor=1.0 Ballast Factor/Type (For 14W and 28W T5 Lamp Only) H=High Light Output 1.15 BF ² HDIM=High 1.15 BF Step Dimming ³ N=Normal Light Output .95 BF ³ NDIM=Normal .9 BF Step Dimming ⁴ T8 Ballasts EB8_=T8 Electronic Start. Total Harmonic Distortion < 10% EB8_/PLUS=T8 Electronic Start. Total Harmonic Distortion < 10%. High Ballast Factor > 1.15 ER8_=T8 Electronic Program Rapid Start. Total Harmonic Distortion < 10%		1=1 Ballast 2=2 Ballasts	PALC=Job Pack, in Carton U=Unit Pack

NOTES: 1. Products also available in non-US voltage and frequencies for international markets. 2. Step Dimming ballast available for 28WT5 lamps only. 3. Available for 2 or 3 T5 lamps only. 4. 1 Lamp step dimming ballast in normal ballast factor not available. 2-lamp ballast will not operate 1 lamp.

2' x 2', 2' x 4'

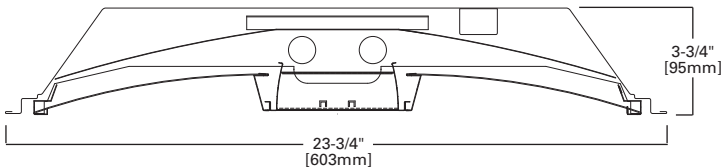

Specifications and dimensions subject to change without notice. Consult your Cooper Lighting Representative or visit www.cooperlighting.com for available options, accessories and ordering information.

COMMERCIAL SPECIFICATION T5 OR T8 TROFFER



FEATURES

- Full array of lamp (T5/T5HO, T8, Biax) and ballast options
- Attractive contemporary design
- Clean modern detailing with uniformly illuminated center panel
- Shallow depth (3-1/4") and structural integrity for ease of install
- Significant energy savings
- Improved visual perception and increased comfort levels
- Even light distribution with optimal uniformity
- One piece enclosure, hinged door and tool-less design

DIMENSIONS

1' x 1', 1' x 4', 2' x 2', 2' x 4'

Compliances may not apply to all product configurations. Please consult the product spec sheet for compliance details.

COMPLIANCES: UL/cUL Listed - Damp Location, NOM Certified, IC Rated, City of Chicago Approved

ARCLINE SERIES



ORDERING INFORMATION

SAMPLE NUMBER: 2ALNG-224T5-UNV-EBT1-U

Rating	Width	Series	Trim Type ¹	Door Frame Standard	Number of Lamps	Wattage (Length)
[Blank]=Standard ATW-SW4=Chicago Rated	2=2' Width [Blank]=1' Width	ALN=ArcLine Series	F=Aluminum Flange G=Grid/Lay-in - Standard ¹³ G=Concealed-T/Slot Grid	[Blank]=Flat White Steel Door	1=1 Lamp (Not Included) ² 2=2 Lamps (Not Included)	14T5=14W T5 (24") 54T5=54W T5 (48") 17=17W T8 (24") BX18=18W Biax PH (12") 24T5=24W T5 (24") BX18 =18W Biax RS (12") 28T5=28W T5 (48") BX40=40W Biax (24") 28T8=28W T8 (48") OC16=16W T8 (12") 32=32W T8 (48") U1-5/8=31W T8 (24")
Shielding	Option - Aluminum Flange Trim ³		Voltage ⁷		Options	
[Blank]=Smooth Frosted Acrylic (Standard) SDL=Smooth Diffused Lens with Insert ¹	[Blank]=Single White Color N=Natural W=White	Type E=End of Row R=In Row S=Single	120V=120 Volt 277V=277 Volt 347V=347 Volt UNV=Universal Voltage 120-277 ⁴		EL=Emergency Installed (Must Specify Battery Pack, See Options) ^{5,6} Flex=Flex Installed (Reference Flex Ordering Information) GL=Single Element Fuse GM=Double Element Fuse Lamps=Lamps Installed (Refer to Lamp Ordering Options)	
Ballast Type					Number of Ballasts	Options
[Blank]=Standard Magnetic (1' x 1' Only)					1=1 Ballast 2=2 Ballasts	FR=Fire Rated Label LAO=Less Access Opening RLS=Rotor Lock Socket (T8 Lamps Only) ¹²
<p>Biax Ballasts TEB5 =T5 Biax Electronic Instant Start. Total Harmonic Distortion < 10%.</p> <p>T5 Ballasts EBT =T5 or T5HO Electronic Program Rapid Start. Total Harmonic Distortion < 10%. Standard Ballast Factor=1.0</p> <p>Ballast/Factor Type (T5) EBT_H=T5 Electronic Program Rapid Start. Total Harmonic Distortion < 10%. High Ballast Factor=1.15⁸ EBT_HDIM=T5 Electronic Program Rapid Start. Total Harmonic Distortion < 10%. Step Dimming, High Ballast Factor=1.15⁹ EBT_N=T5 Electronic Program Rapid Start. Total Harmonic Distortion < 10%. Normal Ballast Factor=.90¹⁰ EBT_NDIM=T5 Electronic Program Rapid Start. Total Harmonic Distortion < 10%. Step Dimming, Normal Ballast Factor=.95-1.0¹¹</p> <p>T8 Ballasts EB8 =T8 Electronic Start. Total Harmonic Distortion < 10%. EB8 /PLUS=T8 Electronic Start. Total Harmonic Distortion < 10%. High Ballast Factor > 1.15 ER8 =T8 Electronic Program Rapid Start, Total Harmonic Distortion < 10%.</p> <p>High Performance T8 Ballasts HB8 =T8 Electronic Instant Start. Total Harmonic Distortion < 10%. Standard Ballast Factor = .86 - .88 HB8_H=T8 Electronic Instant Start. Total Harmonic Distortion < 10%. High Ballast Factor = 1.15 - 1.20 HB8_L=T8 Electronic Instant Start. Total Harmonic Distortion < 10%. Low Ballast Factor = .77 - .82 HB8_N=T8 Electronic Instant Start. Total Harmonic Distortion < 10%. Normal Ballast Factor 1.0 HR8 =T8 Electronic Program Rapid Start. Total Harmonic Distortion < 10%. Standard Ballast Factor .86 - .88 HR8_DIM=T8 Electronic Program Rapid Start. Total Harmonic Distortion < 10%. Step Dimming, Ballast Factor .88 HR8_H=T8 Electronic Program Rapid Start. Total Harmonic Distortion < 10%. High Ballast Factor 1.15 - 1.20 HR8_L=T8 Electronic Program Rapid Start. Total Harmonic Distortion < 10%. Low Ballast Factor .71 - .79</p>						
Packaging		Accessories (Order Separately)				
PALC=Job Pack, in Carton U=Unit Pack		EQ-CLIP-U=T-BAR Safety Earthquake Clips ¹³ F2M-14S-W-U=1' x 4' Field Installed Flange Kit		FCTKA-22W-U=2' x 2' Field Installed Flange Kit FCTKA-24W-U=2' x 4' Field Installed Flange Kit		

NOTES: 1. Only required in ordering information for 2' x 2' and 2' x 4'. 2. 1' x 4' only. 3. Specify row configuration, type in catalog number when ordering complete fixtures. 4. Not available when specifying emergencies, voltage must be specific. 5. Must specify voltage (120V or 277V) when selecting EL option. 6. For 2' x 2' and 2' x 4' low profile emergency unit only, no access plate wire through end plate. Please specify voltage. 7. Products also available in non-US voltage and frequencies for international markets. 8. 1-Lamp ballast in a High Ballast factor not available. 9. Step Dimming ballast available for 2 or 3 14WT5 or 28W T5 lamps only. 10. 90 ballast factor available for 2 or 3 14W T5 or 28W T5 lamps only. 11. 1-Lamp step dimming ballast in a Normal Ballast factor not available. 2-Lamp ballast will not operate 1-Lamp. 12. Standard on 2' x 2' and 2' x 4' fixtures. 13. An EQ Grid Clip is recommended for all 9/16" ceiling systems. Four required per fixture.

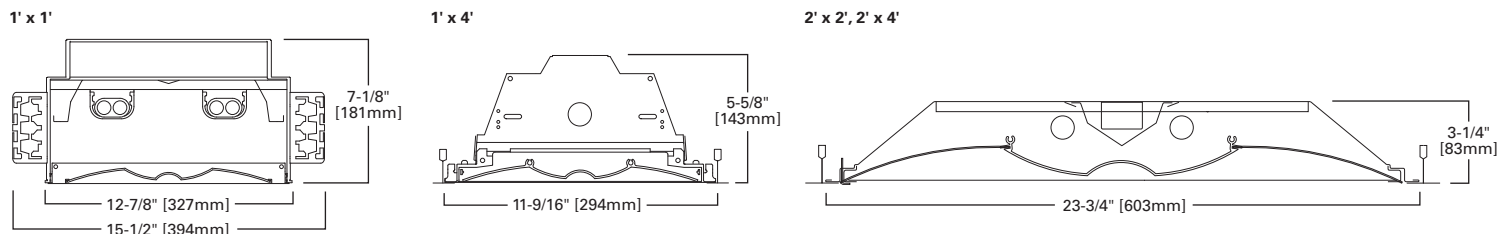

Specifications and dimensions subject to change without notice. Consult your Cooper Lighting Representative or visit www.cooperlighting.com for available options, accessories and ordering information.

FEATURES

- Wide variety of commercial applications
- Air-handling directional air vane
- Direct-Indirect design provides optimum brightness and glare control
- High-reflectance, matte-white finish painted after fabrication
- Ballasts are CBM/ETL Class P
- Heavy-gauge end plates are securely attached for strength and rigidity
- Positively retained direct lamp shield
- Die-formed, code-gauge steel; nominal 6" deep fixture

DIMENSIONS

2' x 2', 2' x 4'

Compliances may not apply to all product configurations. Please consult the product spec sheet for compliance details.

COMPLIANCES: UL/cUL Listed - Damp Location, NOM Certified



RDIA OVATION SERIES



ORDERING INFORMATION

SAMPLE NUMBER: 2RDIA-232RP-UNV-EB81-U

Width	Series	Trim Type	Lamp Position	Air Supply	Number of Lamps (Not Included)	Wattage
2=2' Width	RDIA =Recessed Direct-Indirect with Air Handling	[Blank] =Grid/Lay-in (Standard)	[Blank] =Center Mounted Lamps (Only)	VX =Directional Air Vane	1=1 Lamp 2=2 Lamps 3=3 Lamps	14T5 =14W T5 (24") 17 =17W T8 (24") 24T5 =24W T5HO (24") 28T5 =28W T5 (48") ¹ 32 =32W T8 (48") 54T5 =54W T5HO (48") BX40 =40W Biax (24")
Lamp Shield	Debris Shield ³	Voltage ⁴	Options			
FLS =Frosted Lamp Shield RP =Round Perforated White Steel RP/PLI =RP with Semi-Specular Parabolic Baffle RP/PLMI =RP with Specular Parabolic Baffle RP/TBW =RP White Steel with Thin Blade White Baffle SLS =Split Lamp Shield ² X =Solid Matte White	/DS =Debris Shield	120V =120 Volt 277V =277 Volt 347V =347 Volt UNV =Universal Voltage 120-277 ⁵	EL =Emergency Battery Installed (Must Specify Battery Pack, See Options) ⁶ Flex =Flex Installed (Reference Flex Ordering Information) GL =Single Element Fuse GM =Double Element Fuse Lamps =Lamps Installed			
Options	Ballast Type	Number of Ballasts				
EL =Emergency Battery Installed (Must Specify Battery Pack, See Options) ⁶ Flex =Flex Installed (Reference Flex Ordering Information) GL =Single Element Fuse GM =Double Element Fuse Lamps =Lamps Installed	T5 Ballasts EBT _=T5 or T5HO Electronic Program Rapid Start. Total Harmonic Distortion < 10%. Standard Ballast Factor=1.0 ⁷ Ballast/Factor Type (T5) EBT_H =T5 Electronic Program Rapid Start. Total Harmonic Distortion < 10%. High Ballast Factor=1.15 ⁸ EBT_HDIM =T5 Electronic Program Rapid Start. Total Harmonic Distortion < 10%. Step Dimming, High Ballast Factor=1.15 ^{9, 10} EBT_N =T5 Electronic Program Rapid Start. Total Harmonic Distortion < 10%. Normal Ballast Factor=.90 ¹¹ EBT_NDIM =T5 Electronic Program Rapid Start. Total Harmonic Distortion < 10%. Step Dimming, Normal Ballast Factor=.95-1.0 ¹² T8 Ballasts EB8 _=T8 Electronic Start. Total Harmonic Distortion < 10%. EB8 /PLUS =T8 Electronic Start. Total Harmonic Distortion < 10%. High Ballast Factor > 1.15 ER8 _=T8 Electronic Program Rapid Start. Total Harmonic Distortion < 10% ER8 /PLUS =T8 Electronic Program Rapid Start. Total Harmonic Distortion < 10%. High Ballast Factor > 1.15 High Performance T8 Ballasts HB8 _=T8 Electronic Instant Start. Total Harmonic Distortion < 10%. Standard Ballast Factor .86 - .88 HB8_H =T8 Electronic Instant Start. Total Harmonic Distortion < 10%. High Ballast Factor 1.15 - 1.20 HB8_L =T8 Electronic Instant Start. Total Harmonic Distortion < 10%. Low Ballast Factor .77 - .82 HB8_N =T8 Electronic Instant Start. Total Harmonic Distortion < 10%. Normal Ballast Factor 1.0 HR8 _=T8 Electronic Program Rapid Start. Total Harmonic Distortion < 10%. Standard Ballast Factor .86 - .88 HR8_DIM =T8 Electronic Program Rapid Start. Total Harmonic Distortion < 10%. Step Dimming. Ballast Factor .88 HR8_H =T8 Electronic Program Rapid Start. Total Harmonic Distortion < 10%. High Ballast Factor 1.15 - 1.20 HR8_L =T8 Electronic Program Rapid Start. Total Harmonic Distortion < 10%. Low Ballast Factor .71 - .79	1=1 Ballast 2=2 Ballasts 3=3 Ballasts				
Options ¹³	Packaging	Accessories (Order Separately)				
LSC =Lamp Shield Cable	PALC =Palletized Fixtures in Carton U =Unit Pack	DF-22-W =2' x 2' Drywall Frame Kit DF-24-W =2' x 4' Drywall Frame Kit EQ-CLIP-U =T-BAR Safety Earthquake Clips				

NOTES: 1. .90 ballast factor available for 2 or 3 28W T5 lamps only. 2. 2' x 2' and 2' x 4' Center Lamp Shield models only. 3. Only compatible with X, FLS and RP lamp shields. 4. Products also available in non-US voltage and frequencies for international markets. 5. Not available when specifying emergencies, voltage must be specified. 6. For EM option, single ballast configurations only. 7. .90 ballast factor available for 2 or 3 14W T5 or 28W T5 lamps only. 8. 1-Lamp ballast in a High Ballast factor not available. 9. Step Dimming ballast available for 2 or 3 14WT5 lamps only. 10. Step Dimming ballast available for 2 or 3 28W T5 lamps only. 11. .90 ballast factor available for 2 or 3 14W T5 lamps only. 12. 1-Lamp step dimming ballast in a Normal Ballast factor not available. 2-Lamp ballast will not operate 1-Lamp. 13. See options section.

2' x 2', 2' x 4'

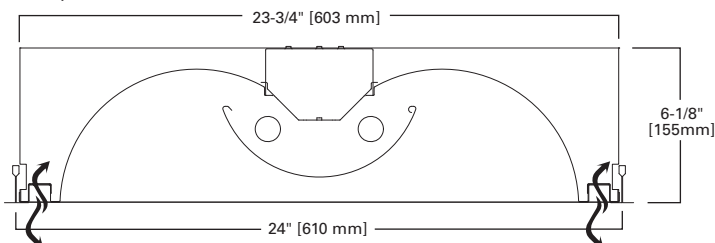

Specifications and dimensions subject to change without notice. Consult your Cooper Lighting Representative or visit www.cooperlighting.com for available options, accessories and ordering information.

COMMERCIAL SPECIFICATION DIRECT-INDIRECT



FEATURES

- Biax, T8 and T5/T5HO lamp sources
- Center-mount and side-mount lamp shield configurations
- High-reflectance, matte-white finish painted after fabrication
- 1, 2, 3 and 4 lamp modules
- Lamps and all hardware are completely shielded from view
- Direct-Indirect design provides optimum brightness and glare control
- Debris shield and lens option available
- Drywall applications in conjunction with drywall frame kit

DIMENSIONS

1' x 2', 1' x 4', 2' x 2', 2' x 4'

Compliances may not apply to all product configurations. Please consult the product spec sheet for compliance details.

COMPLIANCES: UL/cUL Listed - Damp Location, NOM Certified, IC Rated, City of Chicago Approved

RDI, 2RDI
OVATION SERIES



RP, X CENTER MOUNT

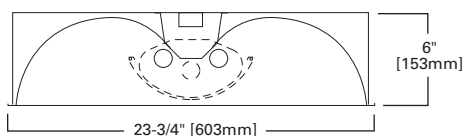

RP/PLI, RP/PLMI 2' x 2', 2' x 4'

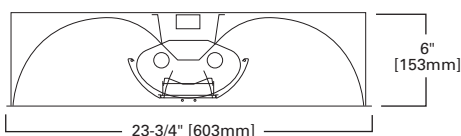

FLS 2' x 2', 2' x 4'

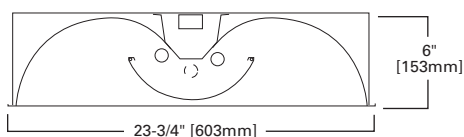

RP/TBW 2' x 2', 2' x 4'

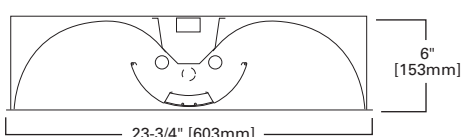

SLS 2' x 2', 2' x 4'

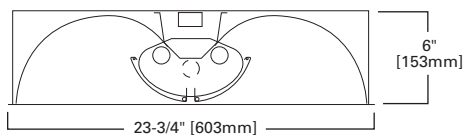

RP, X SIDE MOUNT 2' x 2', 2' x 4'

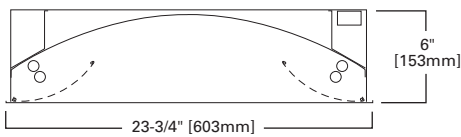

RPD 2' x 2', 2' x 4'

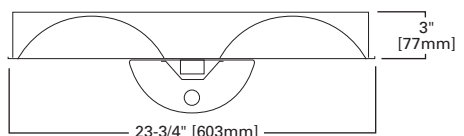

RP, X SIDE MOUNT 1' x 2', 1' x 4'

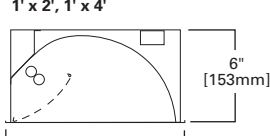

RP, X CENTER MOUNT 1' x 2', 1' x 4'

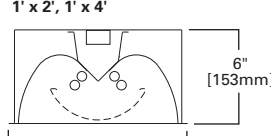

ORDERING INFORMATION

SAMPLE NUMBER: 2RDI-2BX40RP-120V-EB51-U

Rating	Width	Series	Type	Trim Type	Lamp Position
[Blank]=Standard ATW-SW4=Chicago Rated	2=2' Width [Blank]=1' Width	RDI=Recessed Direct-Indirect	IC=IC Rated ¹	[Blank]=Grid/Lay-in (Standard) ²	[Blank]=Center Mounted Lamps (Standard) ASY=Asymmetric S=Side Mounted Lamps (2 or 4 Lamps Only)
Number of Lamps (Not Included) ^{3,4}		Wattage (Length)	Lamp Shield		Voltage ⁷
1=1 Lamp 2=2 Lamps 3=3 Lamps 4=4 Lamps T1=2' x 4' Fixture with One Biax Lamp at Each End T2=2' x 4' Fixture with Two Biax Lamps at Each End T3=2' x 4' Fixture with Three Biax Lamps at Each End		14T5=14W T5 (24") ⁵ 17=17W T8 (24") 24T5=24W T5HO (24") ⁵ 28T5=28W T5 (48") ⁵ 28T8=28W T8 (48") 32=32W T8 (48") 54T5=54W T5HO (48") ⁵ BX40=40W Biax (24") BX50=50W Biax (24") ^{4,5,6} BX55=55W Biax (24") ^{4,5,6}	FLS=Frosted Lamp Shield ⁵ RP=Round Perforated White Steel RP/PLI=RP with Semi-Specular Parabolic Baffle RP/PLMI=RP with Specular Parabolic Baffle RP/TBW=RP White Steel with Thin Blade White Baffle RP/TBWO/020=RP White Steel with Thin Blade White Baffle and Acrylic overlay RPD=Round Perforated Steel Below Ceiling Lamp Shield RPD/TBW=Round Perforated Below Ceiling Lamp Shield with Thin Blade White Baffle SLS=Split Perforated Center Basket X=Solid Matte White		024V=24 Volt DC 120V=120 Volt 277V=277 Volt 347V=347 Volt UNV=Universal Voltage 120-277 ⁸
Options			Ballast Type		
EL=Emergency Battery Installed (Must Specify Battery Pack, See Options) ⁹ Flex=Flex Installed (Reference Flex Ordering Information) GL=Single Element Fuse GM=Double Element Fuse Lamps=Lamps Installed (Refer to Lamp Ordering Options)			<p>Dimming Ballasts DC54_DIM=T5HO 24VDC Dimming= 0-10V, Ballast Factor=.78¹⁰ DC5_DIM=T5 24VDC Dimming 0-10V, Ballast Factor=1.0¹¹ DC8_DIM=T8 24VDC Dimming= 0-10V, Ballast Factor=1.0¹² DCX_DIM=Biax 24VDC Dimming= 0-10V, Ballast Factor=1.0^{13,14}</p> <p>Biax Ballasts EB5_=T5 Biax Electronic Instant Start. Total Harmonic Distortion < 20%.¹⁵ TEB5_=T5 Biax Electronic Instant Start. Total Harmonic Distortion < 10%.¹⁵ ER5_=T5 Biax Electronic Program Rapid Start. Total Harmonic Distortion < 10%.</p> <p>T5 Ballasts EBT_=T5 or T5HO Electronic Program Rapid Start. Total Harmonic Distortion < 10%. Standard Ballast Factor=1.0</p> <p>Ballast/Factor Type (T5) EBT_H=T5 Electronic Program Rapid Start. Total Harmonic Distortion < 10%. High Ballast Factor=1.15¹⁶ EBT_HDIM=T5 Electronic Program Rapid Start. Total Harmonic Distortion < 10%. Step Dimming, High Ballast Factor=1.15^{17,18} EBT_N=T5 Electronic Program Rapid Start. Total Harmonic Distortion < 10%. Normal Ballast Factor=.90¹⁹ EBT_NDIM=T5 Electronic Program Rapid Start. Total Harmonic Distortion < 10%. Step Dimming, Normal Ballast Factor=.95-1.0^{20,16,17,18}</p> <p>T8 Ballasts EB8_=T8 Electronic Start. Total Harmonic Distortion < 10%. EB8_/PLUS=T8 Electronic Start. Total Harmonic Distortion < 10%. High Ballast Factor > 1.15 ER8_=T8 Electronic Program Rapid Start. Total Harmonic Distortion < 10%.</p> <p>High Performance T8 Ballasts HB8_=T8 Electronic Instant Start. Total Harmonic Distortion < 10%. Standard Ballast Factor .86 - .88 HB8_H=T8 Electronic Instant Start. Total Harmonic Distortion < 10%. High Ballast Factor 1.15 - 1.20 HB8_L=T8 Electronic Instant Start. Total Harmonic Distortion < 10%. Low Ballast Factor .77 - .82 HB8_N=T8 Electronic Instant Start. Total Harmonic Distortion < 10%. Normal Ballast Factor 1.0 HR8_=T8 Electronic Program Rapid Start. Total Harmonic Distortion < 10%. Standard Ballast Factor .86 - .88 HR8_DIM=T8 Electronic Program Rapid Start. Total Harmonic Distortion < 10%. Step Dimming, Ballast Factor .88 HR8_H=T8 Electronic Program Rapid Start. Total Harmonic Distortion < 10%. High Ballast Factor 1.15 - 1.20 HR8_L=T8 Electronic Program Rapid Start. Total Harmonic Distortion < 10%. Low Ballast Factor .71 - .79</p>		
Number of Ballasts ²¹	Options	Packaging	Accessories (Order Separately)		
1=1 Ballast 2=2 Ballasts 3=3 Ballasts	LSC=Lamp Shield Cable LVDC10=Low Voltage 10 Foot DC Connector and Cable Assembly Installed LVDC5=Low Voltage 5 Foot DC Connector and Cable Assembly Installed RIF1=Radio Interference Suppressor RLS=Rotor Lock Socket (T8 Lamps Only) ST=Semi-Specular Tannenbaum	PAL=Job Pack Out of Carton PALC=Palletized Fixtures in Carton U=Unit Pack	DF-12-W=1' x 2' Drywall Frame Kit DF-14-W=1' x 4' Drywall Frame Kit DF-22-W=2' x 2' Drywall Frame Kit DF-24-W=2' x 4' Drywall Frame Kit EQ-CLIP-U=T-BAR Safety Earthquake Clips ²²		

NOTES: 1. IC versions only available for select 2' x 2' and 2' x 4' models. 2. Louver is recessed by 5/16" in Concealed T or Slot Grid T. 3. Stem Mounting not available on 3-lamp fixtures. 4. 50W or 55W Biax only available in a 1-lamp option. 5. 2' x 2' and 2' x 4' Center Lamp Shield models only. 6. Biax 50 or 55W only available in tandem 1 lamp option. 7. Products also available in non-US voltage and frequencies for international markets. 8. Not available when specifying emergencies, voltage must be specified. 9. Fixtures equipped with "EL" option may require a 5-1/2" housing depth. If installing in field, must use low profile battery pack. 10. 54T5 is only available in 1-lamp. 11. 24VDC version is EMerge Alliance® Registered. (T5HO 1 lamp ballast only). 12. 24VDC version is Emerge Alliance® Registered (T8 = 2 lamp ballast only). 13. 24VDC version is EMerge Alliance® Registered (Biax = 1 lamp ballast only). 14. BX40 is only available in 1-lamp. 15. Not available in UNV voltage. Must specify voltage. 16. 1-Lamp ballast in a High Ballast factor not available. 17. Step Dimming ballast available for 2 or 3 14WT5 lamps only. 18. Step Dimming ballast available for 28W T5 and 14WT5 lamps only. 19. 90 ballast factor available for 2 or 3 14W T5 or 28W T5 lamps only. 20. 1-Lamp step dimming ballast in a Normal Ballast factor not available. 2-Lamp ballast will not operate 1-Lamp. 21. For Emerge 2' x 4' T8 1.0 Ballast Factor, two ballast must be ordered. 22. An EQ Grid Clip is recommended for all 9/16" ceiling systems. Four required per fixture.

COMMERCIAL SPECIFICATION WALL WASH



FEATURES

- Utilizes efficient fluorescent T8, T5 and Biax lamp sources
- 2' and 4' lengths
- Adjustable end-support mounting brackets
- Optional baffle and lens accessories available
- Easy ballast access from above or below ceiling
- Die-formed housing in code-gauge, cold-rolled steel
- Durable high-reflective finish
- Specular and semi-specular low iridescent anodized-aluminum reflectors
- Can be used in drywall applications using drywall frame kit

DIMENSIONS

1' x 2', 1' x 4'

RWW SERIES

Compliances may not apply to all product configurations. Please consult the product spec sheet for compliance details.

COMPLIANCES: UL Listed - Damp Location, NOM Certified



ORDERING INFORMATION

SAMPLE NUMBER: RWW-232MI-120V-EB81-U

Series	Number of Lamps (Not Included)	Wattage (Length)	Louver/Reflector Finish	Voltage ³	Options ⁵
RWW=Recessed Wall Wash	1=1 Lamp 2=2 Lamps T1=1' x 4' Fixture with One Biax Lamp at Each End	14 T5=14W T5 (24") 17=17W T8 (24") 24 T5=24W T5HO (24") 28T5=28W T5 (48") 32=32W T8 (48") 54 T5=54W T5HO (48") BX40=40W Biax (24") ^{1,2} BX50=50W Biax (24") ^{1,2} BX55=55W Biax (24") ^{1,2}	I=Semi-Specular Low Iridescent MI=Specular Low Iridescent (Standard) W=White	120V=120 Volt 277V=277 Volt 347V=347 Volt UNV=Universal Voltage 120-277 ⁴	EL=Emergency Battery Installed (Must Specify Battery Pack, See Options) GL=Single Element Fuse GM=Double Element Fuse

Ballast Type

Biax Ballasts

EB5 =T5 Biax Electronic Instant Start. Total Harmonic Distortion < 20%.⁶
ER5 =T5 Biax Electronic Program Rapid Start. Total Harmonic Distortion < 10%.
TEB5 =T5 Biax Electronic Instant Start. Total Harmonic Distortion < 10%.⁶

T5 Ballasts

EBT =T5 or T5HO Electronic Program Rapid Start. Total Harmonic Distortion < 10%. Standard Ballast Factor=1.0

Ballast/Factor Type (T5)

EBT_H=T5 Electronic Program Rapid Start. Total Harmonic Distortion < 10%. High Ballast Factor=1.15⁷
EBT_HDIM=T5 Electronic Program Rapid Start. Total Harmonic Distortion < 10%. Step Dimming, High Ballast Factor=1.15⁸
EBT_N=T5 Electronic Program Rapid Start. Total Harmonic Distortion < 10%. Normal Ballast Factor=.90⁹
EBT_NDIM=T5 Electronic Program Rapid Start. Total Harmonic Distortion < 10%. Step Dimming, Normal Ballast Factor=.95-1.0¹⁰

T8 Ballasts

EB8 =T8 Electronic Start. Total Harmonic Distortion < 10%.
EB8_PLUS=T8 Electronic Start. Total Harmonic Distortion < 10%. High Ballast Factor > 1.15.
ER8 =T8 Electronic Program Rapid Start. Total Harmonic Distortion < 10%.

Number of Ballasts	Options	Packaging
1=1 Ballast 2=2 Ballasts 3=3 Ballasts	CAL2=Clear Acrylic Lens (2' Fixture) ¹¹ CAL4=Clear Acrylic Lens (4' Fixture) ¹¹ DF-102-W=2' Version. Drywall Frame Kit (Order Individually as Accessory) DF-104-W=4' Version. Drywall Frame Kit (Order Individually as Accessory) RLS=Rotor Lock Socket (T8 Lamps Only) TBW2=Thin White Baffle Accessory (2' Fixture) TBW4=Thin White Baffle Accessory (4' Fixture)	PALC=Palletized Fixtures in Carton U=Unit Pack

NOTES: 1. Biax only available in 1 lamp cross section. 2. Electronic ballast only. 3. Products also available in non-US voltage and frequencies for international markets. 4. UNV available in T5 and T8 linear only. Not available when specifying emergencies, voltage must be specified. 5. See Options or Accessories. 6. Not available in UNV voltage. Must specify voltage. 7. 1-Lamp ballast in a High Ballast factor not available. 8. Step Dimming ballast available for 2 or 3 14WT5 or 28W T5 lamps only. 9. .90 ballast factor available for 2 or 3 14W T5 or 28W T5 lamps only. 10. 1-Lamp step dimming ballast in a Normal Ballast factor not available. 2-Lamp ballast will not operate 1-Lamp. 11. Field installed accessory ships in separate carton.

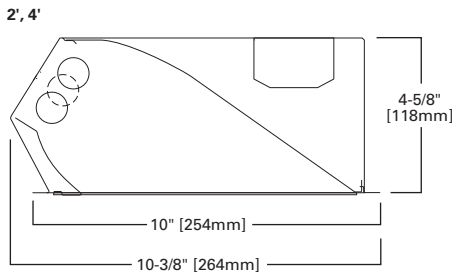

Specifications and dimensions subject to change without notice. Consult your Cooper Lighting Representative or visit www.cooperlighting.com for available options, accessories and ordering information.

FEATURES

- Miniature profile design ideal for architectural lighting solutions
- Equipped with T5 energy-saving electronic ballast
- Die-formed from rolled-steel with baked white enamel finish
- SM can be surface or pendant mount, individual or row mounting
- SML for shadow-free continuous illumination in cove lighting
- Numerous knockouts for easy installation
- Easy wireway access; wireway cover removed without tools
- Lamps not included on SM/SML/SMW striplight series

DIMENSIONS

2', 3', 4', 8'

Compliances may not apply to all product configurations. Please consult the product spec sheet for compliance details.

COMPLIANCES: UL/cUL Listed - Damp Location



CRICKET SM, SML SERIES

ORDERING INFORMATION

SAMPLE NUMBER: SML-228T5-120V-EBT1

Tandem	Series	Number of Lamps (Not Included)	Wattage	Voltage	Options	
8T=8' Length [Blank]=2', 3' or 4' Lengths	SM=T5 Micro Striplight SML=Staggered T5 Micro Striplight	1=1 Lamp 2=2 Lamps 3=3 Lamps 4=4 Lamps	14T5=14W T5 (24") ^{1,2} 21T5=21W T5 (36") ¹ 24T5=24W T5HO (24") ^{1,2} 28T5=28W T5 (48") ¹	35T5=35W T5 (60") ¹ 39T5=39W T5HO (36") ¹ 54T5=54W T5HO (48") ¹	120V=120 Volt 277V=277 Volt 347V=347 Volt UNV=Universal Voltage 120-277 ³	EL=Emergency Installed ⁴ GL=Single Element Fuse GM=Double Element Fuse
Ballast Type			Number of Ballasts	Options		
T5 Ballasts EBT=T5 or T5HO Electronic Program Rapid Start. Total Harmonic Distortion < 10%. Standard Ballast Factor=1.0 ⁵ Ballast/Factor Type (T5) EBT_H=T5 Electronic Program Rapid Start. Total Harmonic Distortion < 10%. High Ballast Factor=1.15 ⁵ EBT_HDIM=T5 Electronic Program Rapid Start. Total Harmonic Distortion < 10%. Step Dimming, High Ballast Factor=1.15 EBT_N=T5 Electronic Program Rapid Start. Total Harmonic Distortion < 10%. Normal Ballast Factor=.90 ⁵ EBT_NDIM=T5 Electronic Program Rapid Start. Total Harmonic Distortion < 10%. Step Dimming, Normal Ballast Factor=.95-1.0 ⁷			1=1 Ballast 2=2 Ballasts	PI/CPI=Plug-In Option RLS=Rotor-Lock Socket (T8 Lamps Only) TILW=Tandem Inline Wiring		
Packaging	Accessories (Order Separately)					
U=Unit Pack	SM-ASY-4=Asymmetrical 4' Reflector SM-ASY-RP-4=Perforated Asymmetrical 4' Reflector SM-SYM-4=Symmetrical 4' Reflector SM-SYM-RP-4=Perforated Symmetrical 4' Reflector		SML-2IN-ASY=Asymmetrical Reflector SML-2IN-ASY/REV=Reverse Asymmetrical Reflector SML-2IN-SYM=Symmetrical Reflector			

NOTES: 1. Nominal dimension. See mounting data for exact measurements. 2. SML 1-lamp not available for these lamp types. 3. Not available when specifying emergencies, voltage must be specified. 4. Available for 4' and 1-lamp 5' units only. 5. .90 ballast factor available for 2 or 3 14W T5 or 28W T5 lamps only. 6. 1-Lamp ballast in a High Ballast factor not available. 7. 1-Lamp step dimming ballast in a Normal Ballast factor not available. 2-Lamp ballast will not operate 1-Lamp.

ORDERING INFORMATION⁴

SAMPLE NUMBER: SML-ASY-SS-4-1 (Accessory Reflector)

Strip Series	Number of Lamps (Not Included)
SML=Micro Staggered SMW=Micro Wide	4=3 or 4 Lamp ¹

NOTES: Δ See accessories page for additional reflectors. 1. For SMW only.

SML 2', 3', 4', 5'

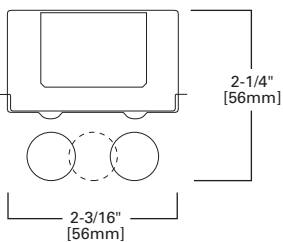

SM 2', 3', 4', 5'

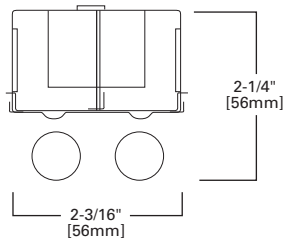

SM 3 AND 4 LAMP

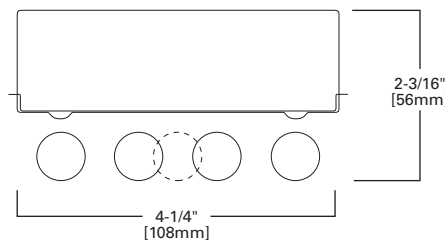

HIGH-BAY INDUSTRIAL



FEATURES

- Full-bodied steel housing for rigidity and strength
- Segmented optical design optimizes performance by three distributions
- Five-year, 55°C or three-year, 65°C ballast warranty
- High-performance polyester powder-coat to protect from corrosion
- Door frame and lens available in clear and prismatic acrylic
- F-Bay modular power supply available for quick power disconnect
- Suspension-mount with optional wire hook and chain set
- Single monopoint-mounting also available with HB-SPM tong hanger

DIMENSIONS

17" x 48"

Compliances may not apply to all product configurations. Please consult the product spec sheet for compliance details.

COMPLIANCES: UL/cUL Listed, UL/cUL Listed - Damp Location

F-BAY HBI SERIES



ORDERING INFORMATION

SAMPLE NUMBER: HBI-654T5-N-UNV-EBT2-U

Series ¹	Number of Lamps (Not Included)	Lamp Type	Distribution	Shielding	Voltage ³
HBI=High Bay Industrial	4=4 Lamps 5=5 Lamps 6=6 Lamps	28T5=28W T5 Lamps (48") 32=32W T8 Lamps (48") 47T5=47W T5HO Lamps (48") ² 49T5=49W T5HO Lamps (48") ² 51T5=51W T5HO Lamps (48") ² 54T5=54W T5HO Lamps (48") ²	M=Medium Beam N=Narrow Beam (Standard) W=Wide Beam	[Blank]=None A=Prismatic Acrylic Lens and Doorframe A/WG=Acrylic Lens, Wireguard and Doorframe CL=Clear Acrylic Lens and Doorframe CL/WG=Clear Lens, Wireguard and Doorframe WG=Wireguard and Doorframe	120V=120 Volt 277V=277 Volt 347V=347 Volt 480V=480 Volt UNC=Universal 347/480 Voltage ⁴ UNV=Universal 120/277 Voltage
Options			Ballast Type		Number of Ballasts
EL=Emergency Battery Installed (Must Specify Battery Pack, See Options) ⁵ GL=Single Element Fuse GM=Double Element Fuse Lamps Installed⁶ HL=Add HL at end of Lamp for High Lumen Lamps, T8 Only L5830=T5 Lamp, 85CRI 3000K L5835=T5 Lamp, 85CRI 3500K L5841=T5 Lamp, 85CRI 4100K L5850=T5 Lamp, 85CRI 5000K L8830=T8 Lamp, 85CRI 3000K L8835=T8 Lamp, 85CRI 3500K L8841=T8 Lamp, 85CRI 4100K L8850=T8 Lamp, 85CRI 5000K			T5 Ballasts EBT_=T5 or T5HO Electronic Program Rapid Start. Total Harmonic Distortion < 10%. Standard Ballast Factor=1.0 ⁷ EHT_=T5HO Linear Electronic Program Rapid Start High Ambient. Total Harmonic Distortion < 10%. ⁸ T8 Ballasts⁹ EB8_=T8 Electronic Start. Total Harmonic Distortion < 10%. EB8_/PLUS=T8 Electronic Start, Total Harmonic Distortion < 10%. High Ballast Factor > 1.15 ER8_=T8 Electronic Program Rapid Start. Total Harmonic Distortion < 10%. ¹⁰ ER8_/PLUS=T8 Electronic Program Rapid Start. Total Harmonic Distortion < 10%. High Ballast Factor > 1.15 ¹⁰		2=2 Ballasts 3=3 Ballasts
Options		Packaging	Accessories (Order Separately)		
G2=Gasketed Door (Requires Selection of Lensed Doorframe) MP=Modular Power Receptacle (Used for All Cord or Cord and Plug Options) ¹¹ MS=360° or 180° motion sensor installed, 120V through 347V, or 480V ¹² MWS=Modular Wiring System ^{13, 14} NUA=No Uplight Apertures In Housing (Cannot be Combined with UPL) SDF=Slotted Doorframe (Requires Selection of Lensed Doorframe) UPL=Uplight Apertures		PAL=Job Pack Out of Carton PALC=Palletized In Carton U=Unit Pack	FH-1=Fixture Hook FL-1=Fixture Loop HB-SPM=Single Monopoint Hanger with Hub HB-SPM-S=Single Monopoint Hanger for Surface Mount HBAYC-CHAIN/SET-U=(2) V-Hook Hangers, 36" Chain Sets with S-Hooks MC3=3' Modular Power Cord MC6=6' Modular Power Cord MDS6=6' Modular Power Cord with MWS 27DS18/2G06MP Connector ¹³ MMS=360° or 180° Aisle Motion Sensor with Modular Power Receptacle (120-277V) MPC3=3' Modular Power Cord and Plug (Specify Voltage) MPC6=6' Modular Power Cord and Plug (Specify Voltage) RH-1=Retrofit Hanger SWG=Heavy Duty Wireguard for Field Installation Y-TOGGLE=Y Mounting Toggle, #2 Cable (Specify 10' or 30', Requires 2 Per Fixture)		

NOTES: 1. Includes V Hangers for rapid installation. 2. EHT standard with T5HO lamps. 3. Voltage must be specified when ordered with plugs or emergency ballasts. For MS option, indicate UNV (for 120V or 277V), 347V or 480V. 4. 2 lamp ballast configurations only for T5 UNC versions. 2/3 lamp ballast configurations in EB8/PLUS only for T8 UNC versions. 5. Voltage must be specified when ordered with plugs or emergency ballasts. 6. Must specify lamps when ordering. 7. EBT ballast systems suitable for operation in ambient environments up to 104°F (40°C) in upright configuration. 8. EHT/HT5/HCT5 ballast systems suitable for ambient environments not to exceed 149°F (65°C) in open upright configurations and less lens option. 9. ER8 and EB8 ballast systems suitable for operation in ambient environments up to 122°F (50°C) in open upright configurations. 10. Recommended when using motion sensor options or accessories. 11. Requires use of MC or MPC cord accessories, specify voltage for plugs. 12. When ordering MS option, specify UNV (for 120 or 277V), 347 or 480V. 13. For MWS with MP, choose MP in fixture logic and then choose MWS accessory such as MDS6. 14. Cannot be combined with Modular Power Receptacle (MP).

4 LAMP

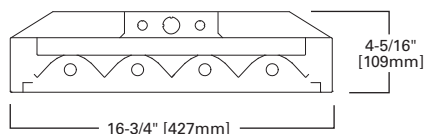

5 LAMP

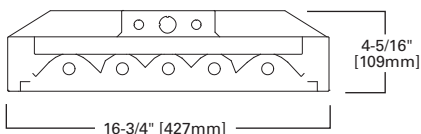

6 LAMP

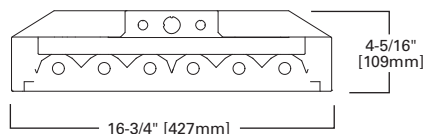

Specifications and dimensions subject to change without notice. Consult your Cooper Lighting Representative or visit www.cooperlighting.com for available options, accessories and ordering information.

FEATURES

- Primary applications include "big box" retail and industrial
- Full-body construction with channel, sides and end plates
- Class P electronic ballast
- Segmented optical design optimizes performance by three distributions
- F-Bay modular power supply available for quick power disconnect
- Suspension-mount with optional wire hook and chain set
- Single monopoint-mounting also available with SPM tong hanger
- Door frame and lens assembly optional for demanding environments

DIMENSIONS

20" x 48", 25" x 48"

Compliances may not apply to all product configurations. Please consult the product spec sheet for compliance details.

COMPLIANCES: UL/cUL Listed, UL/cUL Listed - Damp Location



F-BAY HBE SERIES

ORDERING INFORMATION⁴

SAMPLE NUMBER: HBE-632-N-UNV-L8850-ER82-U

Series	Number of Lamps (Not Included)	Lamp Type	Distribution	Shielding ^{1,2}	Voltage ³
HBE =High Bay Efficiency	4=4 Lamps 6=6 Lamps 8=8 Lamps ¹ 10=10 Lamps ¹	23T5=28W T5 Lamps (48") 32=32W T8 Lamps (48") 47T5=47W T5HO Lamps (48") 49T5=49W T5HO Lamps (48") 51T5=51W T5HO Lamps (48") 54T5=54W T5HO Lamps (48")	M=Medium Beam N=Narrow Beam (Standard) W=Wide Beam	[Blank]=None A=Prismatic Acrylic Lens and Doorframe A/WG=Acrylic Lens, Wireguard and Doorframe CL=Clear Acrylic Lens and Doorframe CL/WG=Clear Lens, Wireguard and Doorframe WG=Wireguard and Doorframe	120V=120 Volt 277V=277 Volt 347V=347 Volt UNC=Universal 347/480 Voltage ⁴ UNV=Universal 120/277 Voltage
Options			Ballast Type		
EL=Emergency Battery Installed (Must Specify Battery Pack, See Options) GL=Single Element Fuse GM=Double Element Fuse Lamps Installed ⁵ HL=Add HL at end of Lamp for High Lumen Lamps, T8 Only L5830=T5 Lamp, 85CRI 3000K L5835=T5 Lamp, 85CRI 3500K L5841=T5 Lamp, 85CRI 4100K L5850=T5 Lamp, 85CRI 5000K L8830=T8 Lamp, 85CRI 3000K L8835=T8 Lamp, 85CRI 3500K L8841=T8 Lamp, 85CRI 4100K L8850=T8 Lamp, 85CRI 5000K			T5 Ballasts EBT=T5 or T5HO Electronic Program Rapid Start. Total Harmonic Distortion < 10%. Standard Ballast Factor=1.0 ⁶ EHT=T5HO Linear Electronic Program Rapid Start High Ambient. Total Harmonic Distortion < 10%. ⁷ T8 Ballasts ⁸ EB8=T8 Electronic Start. Total Harmonic Distortion < 10%. EB8 /PLUS=T8 Electronic Start. Total Harmonic Distortion < 10%. High Ballast Factor > 1.15 ER8=T8 Electronic Program Rapid Start. Total Harmonic Distortion < 10%. ⁹ ER8 /PLUS=T8 Electronic Program Rapid Start. Total Harmonic Distortion < 10%. High Ballast Factor > 1.15 ⁹		
Number of Ballasts	Options	Packaging	Accessories (Order Separately)		
1=1 Ballast 2=2 Ballasts 3=3 Ballasts	[Blank]=Side Rails (Standard) MP=Modular Power Receptacle (Used for All Cord or Cord and Plug Options) ¹⁰ MS=360° or 180° motion sensor installed, 120V through 347V, or 480V ¹¹ MWS=Modular Wiring System ^{12, 13} UPL=Uplight Apertures on Reflector	PAL=Job Pack Out of Carton PALC=Job Pack, in carton U=Unit Pack	FH-1=Fixture Hook FL-1=Fixture Loop HBAYC-CHAIN/SET/U=(2) V-Hook Hangers, 36" Chain Sets with S-Hooks HBL-SPM=Single Monopoint Hanger with Hub HBL-SPM-S=Single Monopoint Surface Mount Hanger MC3=3' Modular Power Cord MC6=6' Modular Power Cord MDS6=6' Modular Power Cord with MWS 27DS18/2G06MP Connector ¹² MMS=360° or 180° Aisle Motion Sensor with Modular Power Receptacle (120-277V) ¹⁰ MPC3=3' Modular Power Cord and Plug (Specify Voltage) MPC6=6' Modular Power Cord and Plug (Specify Voltage) RH-1=Retrofit Hanger WG/HBL6-4FT-B=Field Installable, Wireguard for HBE 4 and 6 Lamp WG/HBL8-4FT-B=Field Installable, Wireguard for HBE 8 and 10 Lamp Y-TOGGLE=Y Mounting Toggle, #2 Cable (Specify 10' or 30')		

NOTES: ¹ Includes V Hangers for rapid installation. ² EHT ballast recommended when using lens option on 8 or 10 lamp configurations. ³ Not recommended in 10 Lamp configurations at ambient temperatures above 120°F (40°C). ⁴ Voltage must be specified when ordered with plugs or emergency ballasts. For MS option, indicate UNV (for 120V or 277V), 347V or 480V. ⁵ 2 lamp ballast configurations only for T5 UNC versions. 2/3 lamp ballast configurations in EB8/PLUS only for T8 UNC versions. ⁶ Must specify lamps when ordering. ⁷ EBT ballast systems suitable for operation in ambient environments up to 104°F (40°C) in upright configuration. ⁸ EHT/HT5/HCT5 ballast systems suitable for ambient environments not to exceed 149°F (65°C) in open upright configurations and less lens option. ⁹ T8 ballast systems suitable for operation in ambient environments up to 131°F (55°C) in open upright configuration. ¹⁰ Recommended when using motion sensor options or accessories. ¹¹ Requires use of MC or MPC cord accessories, specify voltage for plugs. ¹² When ordering MS option, specify UNV (for 120 or 277V), 347 or 480V. ¹³ For MWS with MP, choose MP in fixture logic and then choose MWS accessory such as MDS6. ¹⁴ Cannot be combined with Modular Power Receptacle (MP).

25" x 48", 8 LAMP

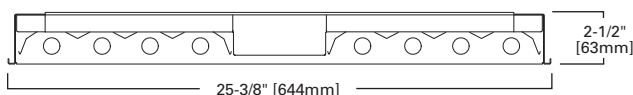

25" x 48", 10 LAMP

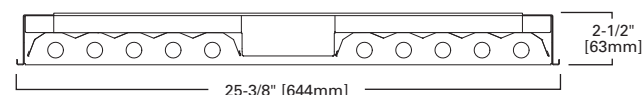

20" x 48", 4 LAMP

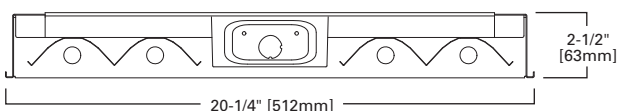

20" x 48", 6 LAMP

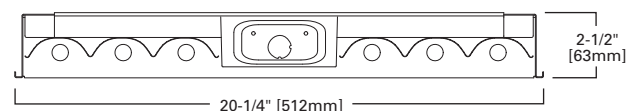
Specifications and dimensions subject to change without notice. Consult your Cooper Lighting Representative or visit www.cooperlighting.com for available options, accessories and ordering information.

HIGH-BAY INDUSTRIAL



FEATURES

- Retail, industrial and warehouse applications
- Channel and end plates constructed of die-formed steel
- Class P electronic ballast and twistlock lampholders
- Segmented optical design optimizes performance by three distributions
- Stiffening brackets add additional strength and rigidity to channel
- Uplight option available to permit ceiling uniformity
- Excellent thermal dissipation without any special components
- Suspension-mount with optional wire hook and chain set
- F-Bay modular power supply available for quick power disconnect

DIMENSIONS

20" x 48", 25" x 48"

F-BAY HBL SERIES

Compliances may not apply to all product configurations. Please consult the product spec sheet for compliance details.

COMPLIANCES: UL/cUL Listed, UL/cUL Listed - Damp Location



ORDERING INFORMATION^A

SAMPLE NUMBER: HBL-632-N-UNV-EB81-UPL-U

Series	Number of Lamps (Not Included)	Lamp Type	Distribution	Voltage ¹
HBL=Linear High Bay	4=4 Lamps 6=6 Lamps 8=8 Lamps 10=10 Lamps	28T5=28W T5 Lamp (48") 32=32WT8 Lamp (48") 47T5=47W T5HO Lamp (48") 49T5=49W T5HO Lamp (48") 51T5=51W T5HO Lamp (48") 54T5=54W T5HO Lamp (48")	M=Medium Beam N=Narrow Beam (Standard) W=Wide Beam	120V=120 Volt 277V=277 Volt 347V=347 Volt UNC=Universal 347/480 Voltage ² UNV=Universal 120/277 Voltage
Options		Ballast Type	Number of Ballasts	
EL=Emergency Battery Installed (Must Specify Battery Pack, See Options) ³ GL=Single Element Fuse GM=Double Element Fuse Lamps Installed ⁴ HL=Add HL at end of Lamp for high lumen Lamps, T8 Only L5830=T5 Lamp, 85GR L5835=T5HO Lamp, 85CRI 3500K L5841=T5HO Lamp, 85CRI 4100K L5850=T5HO Lamp, 85CRI 5000K L8830=T8 Lamp, 85CRI 3000K L8835=T8 Lamp, 85CRI 3500K L8841=T8 Lamp, 85CRI 4100K L8850=T8 Lamp, 85CRI 5000K		T5 Ballasts EBT_=T5 or T5HO Electronic Program Rapid Start. Total Harmonic Distortion < 10%. Standard Ballast Factor=1.0 ⁵ EHT_=T5HO Linear Electronic Program Rapid Start High Ambient. Total Harmonic Distortion < 10% ⁶ T8 Ballasts ⁷ EB8_=T8 Electronic Start. Total Harmonic Distortion < 10%. EB8_/PLUS=T8 Electronic Start. Total Harmonic Distortion < 10%. High Ballast Factor > 1.15 ER8_=T8 Electronic Program Rapid Start. Total Harmonic Distortion < 10%. ⁸ ER8_/PLUS=T8 Electronic Program Rapid Start. Total Harmonic Distortion < 10%. High Ballast Factor > 1.15 ⁸	1=1 Ballast 2=2 Ballasts 3=3 Ballasts	
Options		Packaging	Accessories (Order Separately)	
MP=Modular Power Receptacle (Used for All Cord or Cord and Plug Options) ⁹ MS=360° or 180° Motion Sensor installed (120V through 347V or 480V) ¹⁰ MWS=Modular Wiring System ^{11, 12} UPL=Uplight Apertures on Reflector		PAL=Job Pack Out of Carton PALC=Palletized in Carton U=Unit Pack	FH-1=Fixture Hook FL-1=Fixture Loop HBAYC-CHAIN/SET-U=(2) V-Hook Hanger, 36" Chain Sets with S-Hooks HBL-SPM=Single Monopoint Hanger with Hub HBL-SPM-S=Single Monopoint Surface Mount Hanger MC3=3' Modular Power Cord MDS6=6' Modular Power Cord with MWS 27DS18/2G06MP Connector ¹² MMS=360° or 180° Aisle Motion Sensor with Modular Power Receptacle (120-277V) ⁹ MP6=6' Modular Power Cord MPC3=3' Modular Power Cord and Plug (Specify Voltage) MPC6=6' Modular Power Cord and Plug (Specify Voltage) RH-1=Retrofit Hanger WG/HBL6-4FT-B=Field Installable, Wireguard for HBL 4 and 6 Lamp WG/HBL8-4FT-B=Field Installable, Wireguard for HBL 8 and 10 Lamp Y-TOGGLE=Y Mounting Toggle, #2 Cable (Specify 10' or 30')	

NOTES: Δ Includes V Hangers for rapid installation. 1. Voltage must be specified when ordered with plugs or emergency ballasts. For MS option, indicate UNV (for 120V or 277V), 347V or 480V. 2. 2 lamp ballast configurations only for T5 UNC versions. 2/3 lamp ballast configurations in EB8/PLUS only for T8 UNC versions. 3. Voltage must be specified when ordered with plugs or emergency ballasts. 4. Must specify lamps when ordering. 5. EBT ballast systems suitable for operation in ambient environments up to 104°F (40°C) in upright configuration. 6. EHT/HT5/HCT5 ballast systems suitable for ambient environments not to exceed 149°F (65°C) in open upright configurations and less lens option. 7. T8 ballast systems suitable for operation in ambient environments up to 131°F (55°C) in open upright configuration. 8. Recommended when using motion sensor options or accessories. 9. Requires use of MC or MPC cord accessories, specify voltage for plugs. 10. When ordering MS option, specify UNV (for 120 or 277V). 11. Cannot be combined with Modular Power Receptacle (MP). 12. For MWS with MP, choose MP in fixture logic and then choose MWS accessory such as MDS6.

4 LAMP

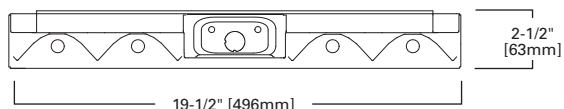

8 LAMP

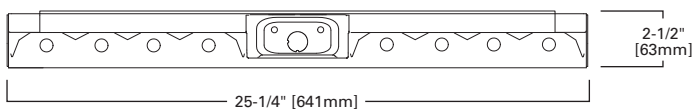

6 LAMP

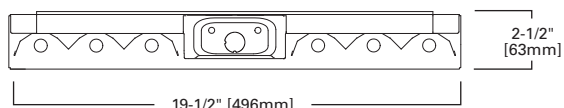

10 LAMP

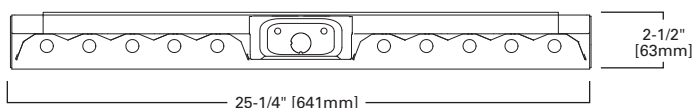

Specifications and dimensions subject to change without notice. Consult your Cooper Lighting Representative or visit www.cooperlighting.com for available options, accessories and ordering information.

FEATURES

- Specular enhanced aluminum standard for medium optical distribution
- Open or lensed option with reinforced aluminum door
- Four auxiliary fixture-end suspension points provided
- End plate grid-lock feature
- Superior lumen maintenance exceeds that of HID
- Instant strike and re-strike ability
- Occupancy sensor instantly turn lights on and off

DIMENSIONS

2' x 2', 2' x 4'

Compliances may not apply to all product configurations. Please consult the product spec sheet for compliance details.

COMPLIANCES: UL/cUL Listed, UL/cUL Listed - Damp Location



F-BAY 2HBG SERIES

ORDERING INFORMATION

SAMPLE NUMBER: 2HBG-654T5A-UNV-EHT2-U

Width	Series	Trim Type	Number of Lamps (Not Included)	Lamp Type	Distribution	Shielding ³
2=24"	HB=High Bay	F=Aluminum Flange Trim ¹ G=Grid/Lay-in (Standard)	4=4 Lamps 6=6 Lamps	28T5=28W T5 Lamps (48") ² 32=32W T8 Lamps (48") 47T5=47W T5HO Lamp (48") 49T5=49W T5HO (48") 51T5=51W T5HO (48") 54T5=54W T5HO Lamps (48")	[Blank]=Medium (Specular Aluminum) G=Wide (High Reflectance White)	[Blank]=Open A=Prismatic Acrylic Lens and Door Frame CL=Clear Acrylic Lens and Doorframe
Optional Aluminum Flange Trim ¹		Voltage ⁴		Options		
[Blank]=SW (Single White) EN=End of Row Natural Finish EW=End of Row White Finish RN=In Row Natural Finish RW=In Row White Finish SN=Single, Natural Finish		120V=120 Volt 277V=277 Volt 347V=347 Volt UNC=Universal 347/480 Voltage ⁵ UNV=Universal 120/277 Voltage ⁴		EL=Emergency Battery Installed (Must Specify Battery Pack, See Options) ⁴ Flex=Flex Installed (Reference Flex Ordering Information) GL=Single Element Fuse GM=Double Element Fuse Lamps Installed HL=Add HL at end of Lamp for High Lumen Lamps, T8 Only L5830=T5 Lamp, 85CRI 3000K L5835=T5 Lamp, 85CRI 3500K L5841=T5 Lamp, 85CRI 4100K L5850=T5 Lamp, 85CRI 5000K L8830=T8 Lamp, 85CRI 3000K L8835=T8 Lamp, 85CRI 3500K L8841=T8 Lamp, 85CRI 4100K L8850=T8 Lamp, 85CRI 5000K		
Ballast Type				Number of Ballasts	Options	Packaging
T5 Ballasts EBT_=T5 or T5HO Linear Electronic Program Start High Ambient. Total Harmonic Distortion < 10%. Standard Ballast Factor=1.0 EHT_=T5HO Linear Electronic Program Rapid Start High Ambient. Total Harmonic Distortion < 10%. T8 Ballasts⁶ EB8_=T8 Electronic Start. Total Harmonic Distortion < 10%. EB8_/PLUS=T8 Electronic Start. Total Harmonic Distortion < 10%. High Ballast Factor > 1.15 ER8_=T8 Electronic Program Rapid Start. Total Harmonic Distortion < 10%. ER8_/PLUS=T8 Electronic Program Rapid Start. Total Harmonic Distortion < 10%. High Ballast Factor > 1.15				1=1 Ballast 2=2 Ballasts 3=3 Ballasts	MWS=Modular Wiring System	PAL=Pallet Pack PALC=Job Pack, in carton U=Unit Pack

NOTES: 1. Specify row configuration, type in catalog number when ordering complete fixtures. 2. 2 ballasts are required when specifying 3 or more 28T5 lamps. 3. Exposed sockets and acrylic lenses may not be suitable for all environments. 4. Voltage must be specified when ordered with plugs or emergency ballasts. 5. 2 lamp ballast configurations only for T5 UNC versions. 2/3 lamp ballast configurations in EB8/PLUS only for T8 UNC versions. 6. ER8 and EB8 ballast systems suitable for operation in ambient environments up to 122°F (50°C) without lens option.

2' x 4', 4 LAMP

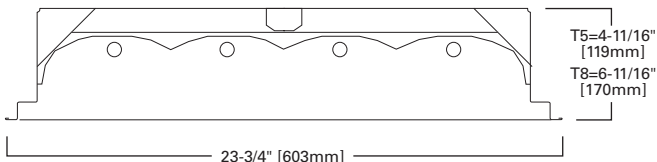

2' x 4', 6 LAMP

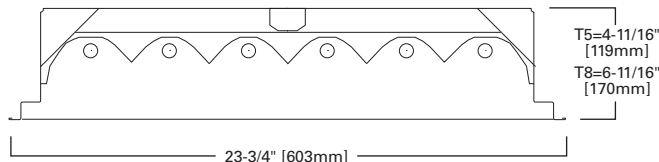

HOSE DOWN HIGH-BAY INDUSTRIAL



FEATURES

- White enamel finish improves efficiency and protects from corrosion
- Enclosed and gasketed hole-free housing
- 200 PSI hose-down rating is standard
- 4- or 6-lamp versions
- Particulock™ gasket system provides 200 PSI hose down rating

DIMENSIONS

2' x 4'

Compliances may not apply to all product configurations. Please consult the product spec sheet for compliance details.

COMPLIANCES: UL Listed - Wet Location, UL/cUL Listed, CSA Listed, CSA Listed - Wet Location, USDA, FDA, NSF, Federal Standard 209E

F-BAY 2HBHD SERIES



ORDERING INFORMATION

SAMPLE NUMBER: 2HBHD-654T5-A-UNV-EBT2-U

Width	Series	Number of Lamps (Not Included)	Lamp Type	Distribution	Shielding	Voltage ¹
2=24"	HBHD=High Bay Hose Down	4=4 Lamps 6=6 Lamps	28T5=28W T5 Lamps (48") 32=32W T8 Lamps (48") 49T5=49W T5HO (48") 51T5=51W T5HO (48") 54T5=54W T5HO Lamps (48")	[Blank]=Medium (Specular Aluminum) G=Wide (High Reflectance White)	A=Prismatic Acrylic Lens and Door Frame CL=Clear Acrylic Lens and Doorframe	120V=120 Volt 277V=277 Volt 347V=347 Volt 480V=480 Volt UNC=Universal 347/480 Voltage ² UNV=Universal 120/277 Voltage
Options		Ballast Type				Number of Ballasts
Emergency =EM Installed ¹ GL =Single Element Fuse GM =Double Element Fuse Lamps Installed HL =Add HL at end of Lamp for High Lumen Lamps, T8 Only L5830 =T5 Lamp, 85CRI 3000K L5835 =T5 Lamp, 85CRI 3500K L5841 =T5 Lamp, 85CRI 4100K L5850 =T5 Lamp, 85CRI 5000K L8830 =T8 Lamp, 85CRI 3000K L8835 =T8 Lamp, 85CRI 3500K L8841 =T8 Lamp, 85CRI 4100K L8850 =T8 Lamp, 85CRI 5000K		T5 Ballasts EBT _=T5 or T5HO Electronic Program Rapid Start. Total Harmonic Distortion < 10%. Standard Ballast Factor=1.0 EHT _=T5HO Linear Electronic Program Rapid Start High Ambient. Total Harmonic Distortion < 10%. T8 Ballasts EB8 _=T8 Electronic Start. Total Harmonic Distortion < 10%. EB8 /PLUS =T8 Electronic Start. Total Harmonic Distortion < 10%. High Ballast Factor > 1.15 ER8 _=T8 Electronic Program Rapid Start. Total Harmonic Distortion < 10%. ER8 /PLUS =T8 Electronic Program Rapid Start. Total Harmonic Distortion < 10%. High Ballast Factor > 1.15				1=1 Ballast 2=2 Ballasts 3=3 Ballasts
Options		Packaging				
C3 =3' Power Cord C6 =6' Power Cord PC3 =3' Power Cord and Plug (Specify Voltage) ¹ PC6 =6' Power Cord and Plug (Specify Voltage) ¹ SHN =Stainless Steel Housing Brushed 304 Finish SSN =Stainless Steel Door/Brushed 304 Finish		PAL =Pallet Pack PALC =Job Pack, in carton U =Unit Pack				

NOTES: 1. Voltage must be specified when ordered with plugs or emergency ballasts. 2. 2 lamp ballast configurations only in UNC versions. 2/3 lamp ballast configurations in EB8/PLUS only for T8 UNC versions.

4 LAMP

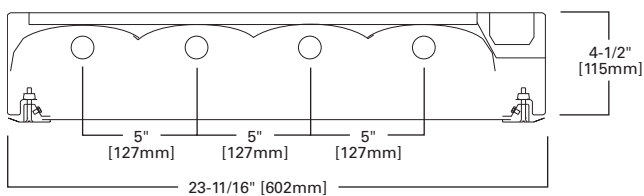

6 LAMP

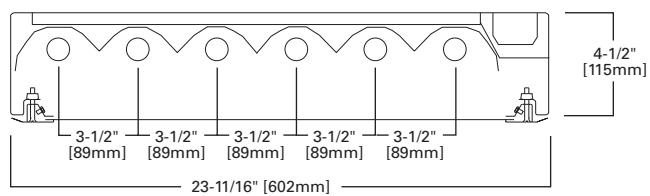

Specifications and dimensions subject to change without notice. Consult your Cooper Lighting Representative or visit www.cooperlighting.com for available options, accessories and ordering information.

FEATURES

- Food processing and demanding areas where cleaning is required
- Powder-coat finish or stainless steel
- Gasketed doorframe and lens seals housing to 800 PSI and IP65 rating
- Articulated top allows for water runoff during cleaning
- One-piece, heavy-gauge lens in clear or prismatic acrylic
- Segmented optical design optimizes performance by two distributions
- Product can be cable- or stem-mounted
- Standard, Class P, CBM/ETL ballast

DIMENSIONS

2' x 4'

Compliances may not apply to all product configurations. Please consult the product spec sheet for compliance details.

COMPLIANCES: UL Listed, CSA Listed - Wet Location, USDA, FDA, NSF, Federal Standard 209E



F-BAY 2HBHT SERIES

ORDERING INFORMATION

SAMPLE NUMBER: 2HBHT-654T5-A-UNV-EBT2-U

Width	Series	Number of Lamps (Not Included)	Lamp Type	Distribution	Shielding
2=24"	HBHT=High Bay Hose Down with Tented Top	4=4 Lamps 6=6 Lamps	28T5=28W T5 Lamps (48") 32=32W T8 Lamps (48") 49T5=49W T5HO Lamps (48") 51T5=51W T5HO Lamps (48") 54T5=54W T5HO Lamps (48")	[Blank]=Medium (Specular Aluminum) G=Wide (High Reflectance White)	93=Prismatic Tempered Glass and Steel Door Frame 94=Clear Tempered Glass and Steel Door Frame A=Prismatic Acrylic Lens and Steel Door Frame CL=Clear Acrylic Lens and Steel Door Frame
Voltage ¹		Options		Ballast Type	
120V=120 Volt 277V=277 Volt 347V=347 Volt UNC=Universal 347/480 Voltage ² UNV=Universal 120/277 Voltage		EL=Emergency Battery Installed (Must Specify Battery Pack, See Options) ¹ GL=Single Element Fuse GM=Double Element Fuse Lamps Installed HL=Add HL at end of Lamp for High Lumen Lamps, T8 Only L5830=T5 Lamp, 85CRI 3000K L5835=T5 Lamp, 85CRI 3500K L5841=T5 Lamp, 85CRI 4100K L5850=T5 Lamp, 85CRI 5000K L8830=T8 Lamp, 85CRI 3000K L8835=T8 Lamp, 85CRI 3500K L8841=T8 Lamp, 85CRI 4100K L8850=T8 Lamp, 85CRI 5000K		T5 Ballasts ² EHT=T5 or T5HO Linear Electronic Program Rapid Start High Ambient. Total Harmonic Distortion < 10%. T8 Ballasts EB8=T8 Electronic Start. Total Harmonic Distortion < 10%. EB8_/PLUS=T8 Electronic Start. Total Harmonic Distortion < 10%. High Ballast Factor > 1.15 ² ER8=T8 Electronic Program Rapid Start. Total Harmonic Distortion < 10%. ER8_/PLUS=T8 Electronic Program Rapid Start. Total Harmonic Distortion < 10%. High Ballast Factor > 1.15	
Number of Ballasts	Options	Packaging	Accessories (Order Separately)		
1=1 Ballast 2=2 Ballasts 3=3 Ballasts	C3=3' Power Cord ³ C6=6' Power Cord ³ PC3=3' Power Cord and Plug (Specify Voltage) ^{1,3} PC6=6' Power Cord and Plug (Specify Voltage) PM=Pendant Mount Stem ⁴ SHN=Brushed Stainless Steel Housing Finish SSN=Brushed Stainless Steel Door Finish	PAL=Pallet Pack PALC=Job Pack, in carton U=Unit Pack	HBHT-Chain/Set=(2) 6 Foot Stainless Steel Chains, (4) Large S-Hooks Y-Hook=(2) Snap Hooks, #2 Cable (Specify 10' or 30'), Order (2) Per Fixture		

NOTES: 1. Voltage must be specified when ordered with plugs, motion sensor or emergency ballasts. 2. 2 lamp ballast configurations only for T5 UNC versions. 2/3 lamp ballast configurations in EB8/PLUS only for T8 UNC versions. 3. Available for chain or cable mount options only. 4. Always supplied with a 6 Foot 3-wire cord as standard through pendant stem hub.

2' x 4', 4 LAMP

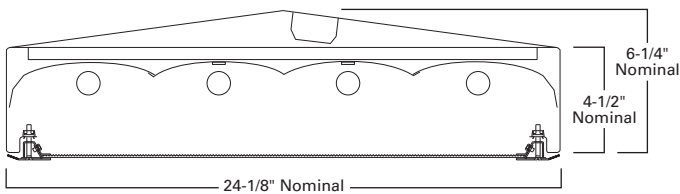

2' x 4', 6 LAMP

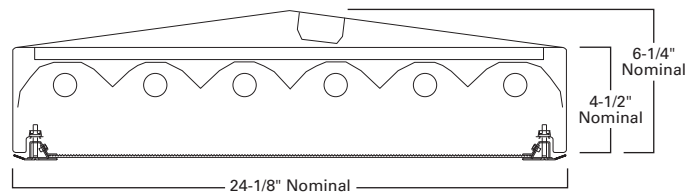

COLD STORAGE HIGH-BAY INDUSTRIAL



FEATURES

- For use in environments with ambient temperatures as low as -20° F
- Die-formed, cold-rolled steel housing, end plates and socket tracks
- Class P ballast, rated for -29°C to 90°C operation
- Finish is preceded by a multi-stage cleaning cycle
- Wide distribution for general open area lighting
- Sealed and gasketed doorframe available with a clear or prismatic lens
- Optical design optimizes performance across three distributions
- Suspension-mount with optional wire hook/chain, HB-SPM or cable mount
- Suited for surface and suspension mounting

DIMENSIONS

17" x 48"

ABI ARCTIC BAY SERIES

Compliances may not apply to all product configurations. Please consult the product spec sheet for compliance details.

COMPLIANCES: UL/cUL Listed, UL/cUL Listed - Damp Location



ORDERING INFORMATION

SAMPLE NUMBER: ABI-654T5-UNV-EBT2-MS/OB-U

Series	Number of Lamps (Not Included)	Lamp Type	Distribution	Shielding	Voltage ¹
ABI=Arctic Bay	4=4 Lamps 5=5 Lamps 6=6 Lamps	49T5=49W T5HO Lamps (48") 51T5=51W T5HO Lamps (48") 54T5=54W T5HO Lamps (48")	M=Medium Beam N=Narrow Beam (Standard) W=Wide Beam	[Blank]=Prismatic Acrylic Lens with Gasketed Door Frame CL=Clear Acrylic Lens with Gasketed Door Frame	120V=120 Volt 277V=277 Volt 347V=347 Volt 480V=480 Volt UNC=Universal 347/480 Voltage ² UNV=Universal 120/277 Voltage
Options			Ballast Type	Number of Ballasts	
EL=Emergency Installed (Must Specify Battery Pack, See Options) GL=Single Element Fuse GM=Double Element Fuse <u>Lamps Installed</u> L5830=T5 Lamp, 85CRI 3000K L5835=T5 Lamp, 85CRI 3500K L5841=T5 Lamp, 85CRI 4100K L5850=T5 Lamp, 85CRI 5000K			T5 Ballasts EBTL=T5 Linear Electronic Program Rapid Start. Total Harmonic Distortion < 10%. Minimum Start Temp. -20°F (-29°C)	1=1 Ballast 2=2 Ballasts 3=3 Ballasts	
Options			Packaging	Accessories (Order Separately)	
C3=3' White Cord Fixture Attached C6=6' White Cord Fixture Attached MS/IB=360° or 180° Motion Sensor Installed, Outside Lamps Constant On ³ MS/OB=360° or 180° Motion Sensor Installed, Inner 2 Lamps Constant On (4L, 5L) ³ PC3-Voltage=3' Cord/Plug Fixture Attached ¹ PC6-Voltage=6' Cord/Plug Fixture Attached ¹			PAL=Job Pack Out of Carton PALC=Job Pack In Carton U=Unit Pack	FH-1=Fixture Hook FL-1=Fixture Loop HB-SPM=Single Monopoint Hanger with Hub HBAYC-CHAIN/SET-U=(2) V-Hook Hangers, 36" Chain Sets with S-Hooks RH-1=Retrofit Hanger Y-TOGGLE=Y Mounting Toggle, #2 Cable (Specify 10' or 30', Requires 2 Per Fixture)	

NOTES: 1. Voltage must be specified when ordered with plugs or emergency ballasts. 2. 2 Lamp ballast configuration only for T5 UNC versions. 3. Specify voltage of ballast as UNV (120V-277V), 347V or 480V.

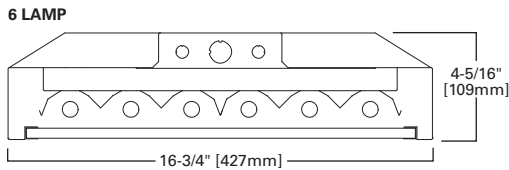
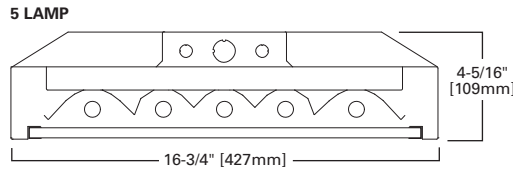
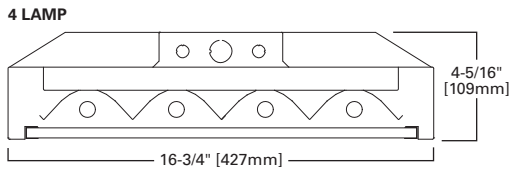

Specifications and dimensions subject to change without notice. Consult your Cooper Lighting Representative or visit www.cooperlighting.com for available options, accessories and ordering information.

T5 LINEAR INDUSTRIAL



F-BAY I5 SERIES

FEATURES

- Specification-grade, full-body housing end plates and socket tracks
- Narrow linear design for applications requiring T5 lamping
- Five-year, 55°C or three-year, 65°C ballast warranty
- Segmented optical design optimizes performance by 2 distributions
- Numerous shielding options available
- Standard 4' or 8' lengths
- Suspension-mount with optional wire hook and chain set
- F-Bay modular power supply available for quick power disconnect

DIMENSIONS

4', 8'

Compliances may not apply to all product configurations. Please consult the product spec sheet for compliance details.

COMPLIANCES: UL/cUL Listed, UL/cUL Listed - Damp Location



ORDERING INFORMATION

SAMPLE NUMBER: I5-354T5-UNV-EBT1-UPL-U

Length	Series	Mounting Arrangement	Number of Lamps (Not Included)	Lamp Type	Distribution Optic
8T=8' Length [Blank]=4' Length	I5=T5 Industrial	[Blank]=Stand Alone R=Continuous Row Mount (2" Row Coupler Included)	2=2 Lamps 3=3 Lamps 4=4 Lamps	28T5=28W T5 Std (4') Lamps 47T5=47W T5 HO (4') Lamps (48') 49T5=49W T5HO (4') Lamps 51T5=51W T5HO (4') Lamps 54T5=54W T5HO (4') Lamps	[Blank]=Medium (Specular Aluminum) G=Wide (High Reflectance White)
Shielding Options	Voltage ²	Options	Ballast Type	Number of Ballasts	
[Blank]=Open ASY=Asymmetric Directional Louver ¹ CL=Clear Acrylic Lens and Door Frame FL=Frosted Acrylic Lens and Frame ¹ TBW=Thin White Baffle WG=Heavy Duty Wireguard	120V=120 Volt 277V=277 Volt 347V=347 Volt 480V=480 Volt UNC=Universal 347/480 Voltage ³ UNV=Universal 120/277 Voltage	EL=Emergency Installed (Must Specify Battery Pack, See Options) GL=Single Element Fuse GM=Double Element Fuse I5 Lamps Installed⁴ L5830=T5 Lamp, 85CRI 3000K L5835=T5 Lamp, 85CRI 3500K L5841=T5 Lamp, 85CRI 4100K L5850=T5 Lamp, 85CRI 5000K	T5 Ballasts EBT=T5 or T5HO Linear Electronic Program Rapid Start Total Harmonic Distortion < 10%. Standard Ballast Factor=1.0 ⁵ EHT=T5HO Linear Electronic Program Rapid Start High Ambient. Total Harmonic Distortion < 10%. ⁶	1=1 Ballast 2=2 Ballasts 3=3 Ballasts	
Options	Packaging	Accessories (Order Separately)			
MP=Modular Power Receptacle (Used for All Cord or Cord and Plug Options) ⁷ MS=360° or 180° motion sensor installed, 120V through 347V, or 480V ⁸ MWS=Modular Wiring System ^{9,10} NUA=No upright apertures in housing. (Cannot be Combined with UPL) PI/CPI=Plug-In (1, 2 or 3) TILW=Tandem Inline Wiring UPL=Uplight Apertures	PAL=Palletized Out of Carton PALC=Palletized In Carton U=Unit Pack	AYC-CHAIN/SET/U=(2) Hooks, 36" Chain Sets with S-Hooks ¹¹ FH-1=Fixture Hook FL-1=Fixture Loop I5/I8-SPM=Single Monopoint Hanger with Hub LOOP=Loop Hanger, #2 Cable (Specify 10' or 30') MC6=6' Modular Power Cord MDS6=6' Modular Power Cord with MWS 27DS18/2G06MP Connector ⁹ MMS=360° or 180° Aisle Motion Sensor with Modular Power Receptacle (120-277V) ⁷ MPC6=6' Modular Power Cord and Plug (Specify Voltage) RH-1=Retrofit Hanger SHK=Hook with Safety Screw TOGGLE=Single Toggle, #2 Cable (Specify 10' or 30') Door Frames (For Field Installation) 90800PPK=Thin White Blade Baffle (I5) 90801PPK=Asymmetrical Directional Louver (I5) I5-FRM/CL PK=Clear Acrylic Lens and Frame (I5) I5-FRM/LENS=Frosted Acrylic Lens and Frame (I5) WG/I5-4FT-B=Heavy Duty Wireguard (I5)			

NOTES: 1. Use with wide distribution optic only. 2. Voltage must be specified when ordered with plugs, motion sensor or emergency ballasts. 3. 2 Lamp ballast configuration only for T5 UNC versions. 4. Must specify lamps when ordering. 5. EBT ballast systems suitable for operation in ambient environments up to 104°F (40°C). 6. EHT ballast systems suitable for ambient environments not to exceed 149°F (65°C) in open up light configurations and less lens option. 7. Requires use of MC or MPC cord accessories, specify voltage for plugs. 8. When ordering MS option, specify UNV (for 120 or 277V), 347 or 480V. 9. For MWS with MP, choose MP in fixture logic and then choose MWS accessory such as MDS6. 10. Cannot be combined with Modular Power Receptacle (MP). 11. Not for use in gymnasiums or similar recreational facilities.

4' or 8', 2 OR 4T LAMPS

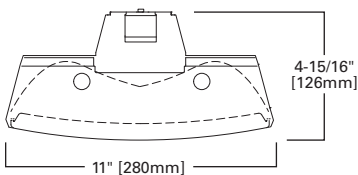

4' or 8', 3 OR 6T LAMPS

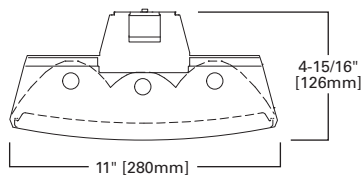

4' or 8', 4 OR 8T LAMPS

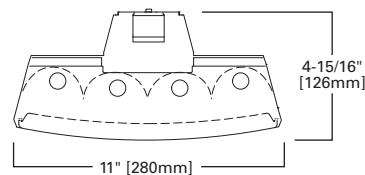

Specifications and dimensions subject to change without notice. Consult your Cooper Lighting Representative or visit www.cooperlighting.com for available options, accessories and ordering information.

T8 LINEAR INDUSTRIAL



FEATURES

- Specification-grade, full-body housing end plates and socket tracks
- Narrow linear design for applications requiring T8 lamping
- Five-year, 55°C or three-year, 65°C ballast warranty
- Segmented optical design optimizes performance by two distributions
- Numerous shielding options available
- Standard 4' or 8' lengths
- Suspension-mount with optional wire hook and chain set
- F-Bay modular power supply available for quick power disconnect

DIMENSIONS

4', 8'

Compliances may not apply to all product configurations. Please consult the product spec sheet for compliance details.

COMPLIANCES: UL/cUL Listed, UL/cUL Listed - Damp Location



F-BAY I8 SERIES

ORDERING INFORMATION

SAMPLE NUMBER: 8T18-432-L8830-UNV-EB81/PLUS-UPL-U

Length	Series	Mounting Arrangement	Number of Lamps (Not Included)	Lamp Type	Distribution Optic	Shielding Options
8T=8' Length [Blank]=4' Length	I8=T8 Industrial	[Blank]=Stand Alone R=Continuous Row Mount (2" Row Coupler Included)	2=2 Lamps 3=3 Lamps 4=4 Lamps	32=32W T8 (4') Lamps	[Blank]=Medium (Specular Aluminum) G=Wide (High Reflectance White)	[Blank]=Open ASY=Asymmetric Directional Louver ¹ CL=Clear Acrylic Lens and Door Frame ¹ FL=Frosted Acrylic Lens and Frame ¹ TBW=Thin White Baffle WG=Heavy Duty Wireguard
Voltage ²	Options	Ballast Type			Number of Ballasts	
120V=120 Volt 277V=277 Volt 347V=347 Volt 480V=480 Volt UNC=Universal 347/480 Voltage ³ UNV=Universal 120/277 Voltage	EL=Emergency Installed (Must Specify Battery Pack, See Options) GL=Single Element Fuse GM=Double Element Fuse I8 Lamps Installed HL=Add HL at end of Lamp for High Lumen Lamps, T8 Only L8830=T8 Lamp, 85CRI 3000K L8835=T8 Lamp, 85CRI 3500K L8841=T8 Lamp, 85CRI 4100K L8850=T8 Lamp, 85CRI 5000K	T8 Ballasts ⁴ EB8 =T8 Electronic Instant Start. Total Harmonic Distortion < 10%. EB8 /PLUS=T8 Electronic Instant Start. Total Harmonic Distortion < 10%. High Ballast Factor > 1.15 ER8 =T8 Electronic Program Rapid Start. Total Harmonic Distortion < 10%. ⁵ ER8 /PLUS=T8 Electronic Program Rapid Start. Total Harmonic Distortion < 10%. High Ballast Factor > 1.15 ⁵			1=1 Ballast 2=2 Ballast 3=3 Ballast	
Options	Packaging	Accessories (Order Separately)				
MP=Modular Power Receptacle (Used for All Cord or Cord and Plug Options) ⁶ MS=360° or 180° Motion Sensor, 120 through 347, or 480V ⁷ MWS=Modular Wiring System ^{8,9} NUA=No Uplight Apertures In Housing (Cannot be Combined with UPL) PI/CPI=Plug-In (1, 2 or 3) TILW=Tandem Inline Wiring UPL=Uplight Apertures	PAL=Palletized Out of Carton PALC=Palletized In Carton U=Unit Pack	AYC-CHAIN/SET/U=(2) Hooks, 36" Chain Sets with S-Hooks ¹⁰ FH-1=Fixture Hook FL-1=Fixture Loop I5/I8-SPM=Single Monopoint Hanger with Hub LOOP=Loop Hanger, #2 Cable (Specify 10' or 30') MC6=6' Modular Power Cord MDS6=6' Modular Power Cord with MWS 27DS18/2G06MP Connector ⁸ MMS=360° or 180° Aisle Motion Sensor with Modular Power Receptacle (120-277V) ⁶ MPC6=6' Modular Power Cord and Plug (Specify Voltage) RH-1=Retrofit Hanger SHK=Hook with Safety Screw TOGGLE=Single Toggle, #2 Cable (Specify 10' or 30') Door Frames (For Field Installation) BAFFLE 4FT I8=Thin White Blade Baffle (I8) I8-FRM/CL PK=Clear Acrylic Lens and Frame (I8) I8-FRM/FL PK=Frosted Acrylic Lens and Frame (I8) WG/I8-4FT-B=Heavy Duty Wireguard (I8)				

NOTES: 1. Use with wide distribution optic only. 2. Voltage must be specified when ordered with plugs, motion sensor or emergency ballasts. 3. 2/3 lamp ballast configuration in EB8/PLUS for T8 UNC version. 4. ER8 and EB8 ballast systems suitable for operation in ambient environments up to 122°F (50°C) in open upright configurations. 5. Recommended when using motion sensor options or accessories. 6. Requires use of MC or MPC cord accessories, specify voltage for plugs. 7. When ordering MS option, specify UNV (for 120 or 277V), 347 or 480V. 8. For MWS with MP, choose MP in fixture logic and then choose MWS accessory such as MDS6. 9. Cannot be combined with Modular Power Receptacle (MP). 10. Not for use in gymnasiums or similar recreational facilities.

4' or 8', 2 LAMPS

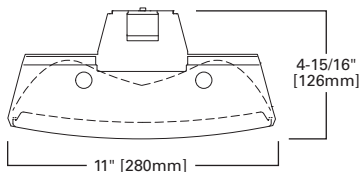

4' or 8', 3 LAMPS

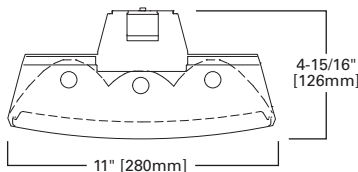

4' or 8', 4 LAMPS

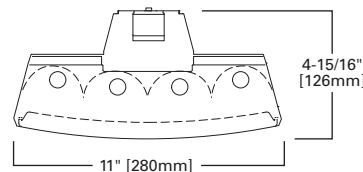

Specifications and dimensions subject to change without notice. Consult your Cooper Lighting Representative or visit www.cooperlighting.com for available options, accessories and ordering information.

FEATURES

- Available in one- or two-lamp version, using T5 or T8 lamps
- Specular Miro® 4 reflectors for precise light control
- Three optical distribution patterns available
- White enamel finish improves efficiency and protects from corrosion
- Easily suspended and adjusted using various cable-mounting methods
- Ideal for continuous row-mounting in narrow-aisle applications
- Occupancy sensor instantly turn lights on and off
- Flip-up socket feature for faster installation out of the box
- Optional pre-wire multiple circuit plug-in connectors



**F-BAY MBF
MICRO-BAY
SERIES**

DIMENSIONS
4', 8'

Compliances may not apply to all product configurations. Please consult the product spec sheet for compliance details.

COMPLIANCES: UL/cUL Listed, UL/cUL Listed - Damp Location



ORDERING INFORMATION

SAMPLE NUMBER: MBF-132-NB-UNV-EB81-U

Tandem	Series	Number of Lamps (Not Included)	Lamp Types	Reflector	Voltage ¹	Options
8T=8' Length [Blank]=4' Length	MBF=Micro-Bay	1=1 Lamp 2=2 Lamps	32=32W T8 (48") 47T5=47W T5HO (48") 49T5=49W T5HO (48") 51T5=51W T5HO (48") 54T5=54W T5HO (48")	FB=Focus Beam NB=Normal Beam TB=Task Beam (Medium-1 Lamp Only)	120V=120 Volt 277V=277 Volt 347V=347 Volt UNC=Universal 347/480 Voltage ² UNV=Universal 120/277 Voltage	EL=Emergency Battery Installed (Must Specify Battery Pack, See Options) GL=Single Element Fuse GM=Double Element Fuse
Ballast Type				Number of Ballasts	Options	
T5 Ballasts EBT =T5 or T5HO Electronic Program Rapid Start. Total Harmonic Distortion < 10%. Standard Ballast Factor=1.0 EHT =T5HO Linear Electronic Program Rapid Start High Ambient. Total Harmonic Distortion < 10%. T8 Ballasts ³ EB8 =T8 Electronic Start. Total Harmonic Distortion < 10%. EB8 /PLUS=T8 Electronic Start. Total Harmonic Distortion < 10%. High Ballast Factor > 1.15 ER8 =T8 Electronic Program Rapid Start. Total Harmonic Distortion < 10%. ER8 /PLUS=T8 Electronic Program Rapid Start. Total Harmonic Distortion < 10%. High Ballast Factor > 1.15 ⁴				1=1 Ballast 2=2 Ballasts	C3=3' Power Cord C6=6' Power Cord PC3=3' Power Cord and Plug (Specify Voltage) ¹ PC6=6' Power Cord and Plug (Specify Voltage) ¹ PI/CPI=Plug-In (1, 2 or 3)	
Packaging		Accessories (Order Separately)				
U=Unit Pack		ATG-SSF-4-U=Tong Hanger AYC-CHAIN/SET/U=(2) Hooks, 36" Chain Sets with S-Hooks MBF-SENSOR-KIT-CTR/MT-U=Aisle Coverage Motion Sensor, Center Mount Hardware, 120/277V ^{1,5} MBF-SENSOR-KIT-END/MT-U=Aisle Coverage Motion Sensor, End Mount Hardware, 120/277V ^{1,5} SSF-EXT-LONG-CONN-KIT-U=Rigid Connector Support for Continuous Channel Installation TOGGLE=Single Toggle, #2 Cable (Specify 10' or 30') Y-TOGGLE=Y Mounting Toggle, #2 Cable (Specify 10' or 30') ⁶				

NOTES: 1. Voltage must be specified when ordered with plugs, motion sensor or emergency ballasts. 2. 2 lamp ballast configurations only for T5 UNC versions. 2/3 lamp ballast configurations in EB8/PLUS only for T8 UNC versions. 3. ER8 and EB8 ballast systems suitable for operation in ambient environments up to 50°C. 4. Recommended when using motion sensor options or accessories. 5. Must ship separately. 6. Use with continuous row mount at fixture joint only.

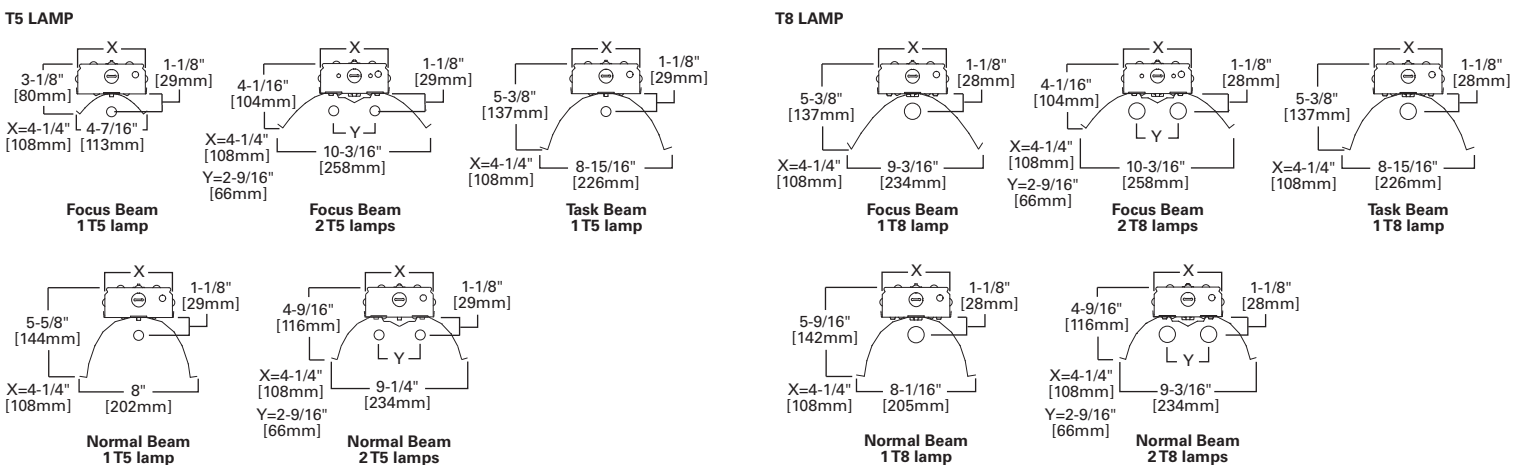

Specifications and dimensions subject to change without notice. Consult your Cooper Lighting Representative or visit www.cooperlighting.com for available options, accessories and ordering information.

VAPORTITE INDUSTRIAL



FEATURES

- Ideal for cold-storage applications
- LEDs available in 3500K or 4000K with 85 CRI
- Wet-location rated
- Narrow and wide distributions
- 2' and 4' housings
- Modular design with quick disconnects
- 0-10V dimming driver is standard

DIMENSIONS

2', 4'

Compliances may not apply to all product configurations. Please consult the product spec sheet for compliance details.

COMPLIANCES: UL Listed, UL Listed - Wet Location, IP65 Rated

VAPORTITE LED SERIES



ORDERING INFORMATION

SAMPLE NUMBER: VT-58DR-UNV-L835-CD2-WL-U

Series	LED Lumens Output	Lens	Distribution	Voltage	Lamps	Driver Type	Number of Drivers
VT=Vaportite	2' Housing 27=2700 Lumens ¹ 30=3000 Lumens 4' Housing 55=5500 Lumens ¹ 58=5800 Lumens	DR =Internal Prismatic Lens/15% DR High Impact Additive (Standard) DR-100% =100% High Impact Additive	[Blank] =Narrow Standard W =Wide Distribution	UNV =Universal Voltage 120-277	L835 =3500K L840 =4000K	CD =0-10V Dimming Driver	1 =1 Driver 2 =2 Drivers
Wet Location		Options	Packaging	Accessories (Order Separately)			
WL =Wet Location Label		SSL =Stainless Steel Latches	U =Unit Pack	VT2-Chain/Set-U =Chain Hanging Set (Order One Kit for Each 2' or 4' Fixture, Two Kits for Each 8' Fixture) VT2-SS-MBK =Stainless Steel Mounting Bracket			

NOTES: 1. Only available in Wide Distribution.

NARROW DISTRIBUTION

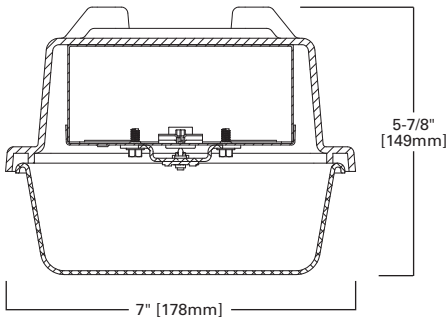

WIDE DISTRIBUTION

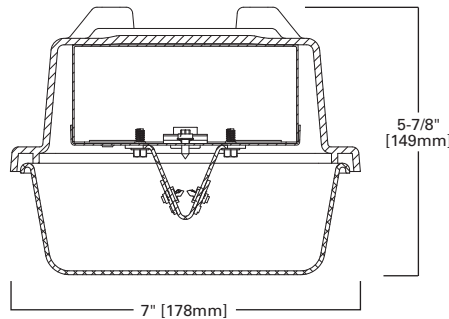

Specifications and dimensions subject to change without notice. Consult your Cooper Lighting Representative or visit www.cooperlighting.com for available options, accessories and ordering information.

FEATURES

- Enclosed Vaportite® high bay for food processing and demanding areas
- Polyester fiberglass housing UL94 and UL746 5VA flammability rated
- Rotolock lampholders and CBM/ETL Class P certified to 70°C
- High-impact, clear acrylic or optional 100% polycarbonate lens
- IP65 and IP67 certified; NSF listed and NEMA 4X rated
- Internal specular aluminum reflector
- Electrical components and fixtures are UL/cUL listed for wet location
- Two stainless mounting bails or optional Y-hook cable mount
- Water-tight hubs for 1/2" conduit entry provided at end of housing

DIMENSIONS

4'

Compliances may not apply to all product configurations. Please consult the product spec sheet for compliance details.
COMPLIANCES: UL/cUL Listed - Wet Location, IP65 Rated, IP67 Rated, NSF Certified, NEMA 4X Rated



VT4 SERIES



ORDERING INFORMATION

SAMPLE NUMBER: VT4-654T5-M-DR-UNC-EHT2-WL-U

Series	Number of Lamps (Not Included)	Wattage (Length)	Distribution	Lens	Voltage ¹
VT4=Vaportite 4 or 6 Lamp	4=4 Lamps 6=6 Lamps	32=32W T8 (48") 47T5=47W T5HO (48") 49T5=49W T5HO Lamps (48") 51T5=51W T5HO Lamps (48") 54T5=54W T5HO (48")	M=Medium Beam W=Wide Beam (White)	DR=Clear Acrylic High Impact (Standard) PC=Polycarbonate, Clear	120V=120 Volt 277V=277 Volt 347V=347 Volt UNC=Universal Voltage 347/480 ² UNV=Universal Voltage 120/277
Options		Ballast Type		Number of Ballasts	
EL=Emergency Installed (Must Specify Battery Pack, See Options) GL=Single Element Fuse GM=Double Element Fuse		T5 Ballasts EHT_=T5HO Linear Electronic Program Rapid Start High Ambient. Total Harmonic Distortion < 10%. ³ T8 Ballasts EB8_=T8 Electronic Instant Start. Total Harmonic Distortion < 10%. EB8_/PLUS=T8 Electronic Instant Start. Total Harmonic Distortion < 10%. High Ballast Factor > 1.15 ER8_=T8 Electronic Program Rapid Start. Total Harmonic Distortion < 10%. ER8_/PLUS=T8 Electronic Program Rapid Start. Total Harmonic Distortion < 10%. High Ballast Factor > 1.15		1=1 Ballast 2=2 Ballasts 3=3 Ballasts	
Label	Options	Packaging	Accessories (Order Separately)		
WL=Wet Label	[Blank]=(2) End Watertite Hubs (All Watertite Hubs have 1/2" Conduit Entry) C3=3' Power Cord C6=6' Power Cord MS=360° or 180° Motion Sensor, Damp Location ^{4,5} MS/WL=180° Motion Sensor, Wet Location ^{6,7} MSO/WL=360° Motion Sensor, Wet Location ^{6,7} PC3=3' Power Cord and Plug (Specify Voltage) ¹ PC6=6' Power Cord and Plug (Specify Voltage) ¹ VRS=Vandal Resistant Screws for Latches	U=Unit Pack	VT4-SS-SM=(2) Stainless Steel Surface Mounting Bracket Y-TOGGLE=Y Mounting Toggle, #2 Cable (Specify 10' or 30')		

NOTES: 1. Voltage must be specified when ordered with plugs or emergency ballasts. 2. 2 lamp ballast configurations only for T5 UNC versions. 2/3 lamp ballast configurations in EB8/PLUS only for T8 UNC versions.
 3. For ambient greater than 40°C (102°F) EHT3 is recommended for 654T5 configuration. 4. When ordering MS option, specify UNV (for 120 or 277V), 347 or 480V. 5. Must specify DL when ordering MS option. 6. Must specify voltage. 7. Must specify WL when ordering MS/WL or MSO/WL.

4', 4 LAMP

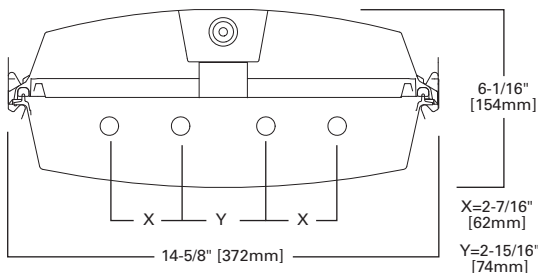

4', 6 LAMP

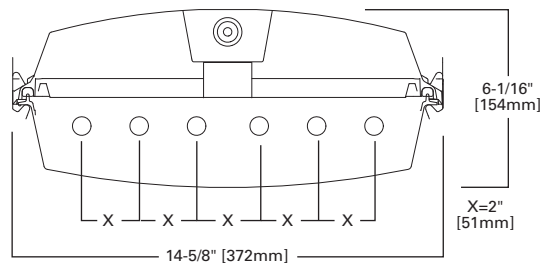

Specifications and dimensions subject to change without notice. Consult your Cooper Lighting Representative or visit www.cooperlighting.com for available options, accessories and ordering information.

VAPORTITE INDUSTRIAL



FEATURES

- Maximum operation in commercial and industrial environments
- Polyester and self-extinguishing (ASTM-D635-74) plastic
- Ballasts are CBM/ETL Class P certified suitable to 70°F
- New contemporary-styled, clear acrylic, impact-resistant lens
- Rotolock electrical components and fixture UL/cUL listed
- IP65 certified and NSF listed, IP67 (4' only) with eight latches
- Optional chain mount hanging set or snap-on brackets
- Surface-mount fixture using two galvanized brackets
- Internal fasteners and tethers provide maximum protection and rigidity

DIMENSIONS

4', 8'

VT3 SERIES

Compliances may not apply to all product configurations. Please consult the product spec sheet for compliance details.

COMPLIANCES: UL/cUL Listed - Wet Location, IP65 Rated, IP67 Rated

ORDERING INFORMATION

SAMPLE NUMBER: VT3-232DR-UNV-EB81-WL-U

Tandem	Series	Number of Lamps (Not Included) ¹	Wattage (Length)	Lens	Voltage ²
8T=8' Length [Blank]=4' Length	VT3=Vaporite (Gasketed Enclosure)	1=1 Lamp 2=2 Lamps 3=3 Lamps (Not Included)	28T5=28W T5 (48") 32=32W T8 (48") 54T5=54W T5HO (48") ¹	DR=Internal Prismatic Lens/15% DR High Impact Additive (Standard) DR-100=100% High Impact Additive (Extreme) DR-50=50% High Impact Additive	120V=120 Volt 277V=277 Volt 347V=347 Volt UNC=Universal 347/480 Voltage ³ UNV=Universal Voltage 120/277V
Options	Ballast Type			Number of Ballasts	Label
EL=Emergency Installed (Must Specify Battery Pack, See Options) GL=Single Element Fuse GM=Double Element Fuse	T5 Ballasts EBT_=T5 or T5HO Electronic Program Rapid Start. Total Harmonic Distortion < 10%. Standard Ballast Factor=1.0 EHT_=T5HO Linear Electronic Program Rapid Start High Ambient. Total Harmonic Distortion < 10%. ⁴ T8 Ballasts EB8_=T8 Electronic Instant Start. Total Harmonic Distortion < 10%. EB8_/PLUS=T8 Electronic Instant Start. Total Harmonic Distortion < 10%. High Ballast Factor > 1.15 ER8_=T8 Electronic Program Rapid Start. Total Harmonic Distortion < 10%. ⁵ ER8_/PLUS=T8 Electronic Program Rapid Start. Total Harmonic Distortion < 10%. High Ballast Factor > 1.15 ⁵			1=1 Ballast 2=2 Ballasts	DL=Damp Location WL=Wet Location Label ⁶
Options	Packaging	Accessories (Order Separately)			
8L=8 Latches (IP67 Rating), (4' Only) BKS=(2) Snap-on Brackets for Chain or Surface Mount M4=Specular Reflector MS=360° or 180° Motion Sensor, Damp Location ^{7,8} MS/WL=180° Motion Sensor, Wet Location ^{9,6} MSO/WL=360° Motion Sensor, Wet Location ^{9,6} SSL=Stainless Steel Latches TEH=(2) Top and (2) End Watertite Hubs (All Watertite Hubs Have 1/2" Conduit Entry) ¹⁰ TH=(2) Top Watertite Hubs ¹⁰ VRS=Vandal Resistant Screws for Latches	PALC=Job Pack, in carton U=Unit Pack	VT2 Stem Bushing=1/2" - 3/8" (Required When Using Stem/Sets, Requires (1) Per (Stem/Set) VT2-Chain/Set-U=Chain Hanging Set Includes 6 Foot of chain, 4 Large S-Hooks and 4 Small S-Hooks. ¹¹ VT2-SS-MBK=Stainless Steel Mounting Brackets. ¹¹ VT3-4FT-M4 PK=4' Specular Interior Reflector Pack for VT3 (Stock Product) VT3-BKS2-PK=(2) Snap-on Brackets for Surface or Chain Mount. Adjustable along length of Fixture.			

NOTES: 1. EHT2 ballasts are recommended for ambient temperatures above 102°F (40°C) 3 Lamp 54W T5HO configuration. 2. Voltage must be specified when ordered with plugs, motion sensor or emergency ballasts. 3. 2 lamp ballast configurations only for T5 UNC versions. 2/3 lamp ballast configurations in EB8/PLUS only for T8 versions. 4. Use EHT1 ballast in ambient temperatures below 0°F (-18°C) on 3 Lamp 54W T5HO configurations. 5. Recommended when using motion sensor options or accessories. 6. Must specify WL when ordering MS/WL or MSO/WL. 7. When ordering MS option, specify UNV (for 120 or 277V), 347 or 480V. 8. Must specify DL when ordering MS option. 9. Must specify voltage. 10. Top Hub required when stem mounting. 11. Order one (1) kit for 4 Foot fixture, or two (2) kits for 8 Foot fixture.

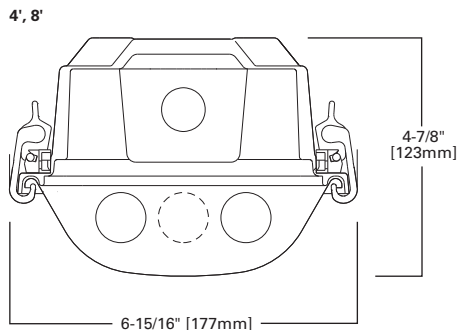
Specifications and dimensions subject to change without notice. Consult your Cooper Lighting Representative or visit www.cooperlighting.com for available options, accessories and ordering information.

FEATURES

- Designed for commercial, institutional and industrial environments
- Fiberglass housing is self-extinguishing (ASTM-D635-74) plastic
- Ballasts are CBM/ETL Class P certified to 70°C
- Optional clear injection-molded internal prism lens
- Full-metal gear tray secured by internal fasteners
- Electrical components and fixtures are IP65 certified and NSF listed
- Two stainless steel brackets with chain-mount bail
- Adjustable brackets along fixture length for variable mounting centers

DIMENSIONS

4'

Compliances may not apply to all product configurations. Please consult the product spec sheet for compliance details.

COMPLIANCES: UL/cUL Listed - Wet Location, IP65 Rated, NSF Certified



VT1 SERIES



ORDERING INFORMATION

SAMPLE NUMBER: VT1-154T5-PCR-UNV-EBT1-WL-U

Series	Number of Lamps (Not Included)	Wattage (Length)	Lens	Voltage ¹	Options
VT1=Vaportite	1=1 Lamp	28T5=28W T5 (48") 32=32W T8 (48") 54T5=54W T5HO Lamps (48")	PCR=Lineal Ribs Polycarbonate (Standard)	120V=120 Volt 277V=277 Volt 347V=347 Volt UNC=Universal Voltage 347/480 UNV=Universal Voltage 120-277	EL=Emergency Installed (Must Specify Battery Pack, See Options) GL=Single Element Fuse GM=Double Element Fuse
Ballast Type			Number of Ballasts	Label	Options
T5 Ballasts EBT_=T5 or T5HO Electronic Program Rapid Start. Total Harmonic Distortion < 10%. Standard Ballast Factor=1.0 EHT_=T5HO Linear Electronic Program Rapid Start High Ambient. Total Harmonic Distortion < 10%. T8 Ballasts EB8_= T8 Electronic Start. Total Harmonic Distortion < 10%. EB8_/PLUS=T8 Electronic Start. Total Harmonic Distortion < 10%. High Ballast Factor > 1.15 ER8_= T8 Electronic Program Rapid Start. Total Harmonic Distortion < 10%. ER8_/PLUS=T8 Electronic Program Rapid Start. Total Harmonic Distortion < 10%. High Ballast Factor > 1.15			1=1 Ballast	WL=Wet Label	[Blank]=(2) End Watertite Hubs (All Watertite Hubs have 1/2" Conduit Entry) C3=3' Power Cord C6=6' Power Cord PC3=3' Power Cord and Plug (Specify Voltage) ¹ PC6=6' Power Cord and Plug (Specify Voltage) ¹ SSL=Stainless Steel Latches VRS=Vandal Resistant Screws for Latches
Packaging		Accessories (Order Separately)			
U=Unit Pack		VT2-CHAIN/SET-U=Chain Hanging Set Includes 6 Foot of Chain, 4 Large S-Hooks and 4 Small S-Hooks. Order One (1) Kit for Each 4' Fixture			

NOTES: 1. Voltage must be specified when ordered with plugs or emergency ballasts.

4', 1 LAMP

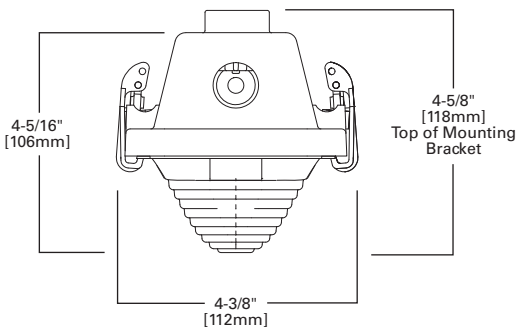

Specifications and dimensions subject to change without notice. Consult your Cooper Lighting Representative or visit www.cooperlighting.com for available options, accessories and ordering information.

INDUSTRIALS T5, T8, T5HO



FEATURES

- Heavy-duty, apertured or closed-top reflector
- Apertured reflector standard with 8% uplight
- Flip-up socket feature for faster installation
- Die-formed channel with baked-white enamel finish
- Pressure lock or spring-loaded lampholders
- Wire guards available for special application
- Silver-lining reflector finish available
- Tandem 8' lengths
- Lamps not included with either IAF or ICF series

DIMENSIONS

4', 8'

IAF, ICF SERIES

Compliances may not apply to all product configurations. Please consult the product spec sheet for compliance details.

COMPLIANCES: UL/cUL Listed - Damp Location



ORDERING INFORMATION

SAMPLE NUMBER: ICF-232-UNV-HB81-U

Tandem	Series	SilverLining	Number of Lamps (Not Included)	Wattage	Voltage ²	
8T=8' Length [Blank]=4' Length	IAF=Apertured Reflector ICF=Closed Top Reflector	[Blank]=White (Standard) SS=Silver-Lining Reflector ⁸	1=1 Lamp 2=2 Lamps 3=3 Lamps	17=17W T8 (24") 28T5=28W T5 (48") 28T8=28W T8 (48") ⁷ 32=32W T8 (48") 40=40W T12 (48")	48HO=60W T12HO (48") 48T8HO=44W T8HO (48") 54T5=54W T5HO (48") 96=59W T8SL (96") 96HO=95/110W T12HO (96") 96T8HO=86W T8HO (96")	120V=120 Volt 277V=277 Volt 347V=347 Volt UNV=Universal Voltage 120-277 ¹
Options ³	Ballast Type			Number of Ballasts		
EL4=Emergency Installed EL5=Emergency Installed EL5HO=Emergency Installed for T5HO EL8=Emergency Installed GL=Single Element Fuse GM=Double Element Fuse	<p>T5 Ballasts EBT_T5 or T5HO Electronic Program Rapid Start. Total Harmonic Distortion < 10%. Standard Ballast Factor=1.0</p> <p>Ballast/Factor Type (T5) EBT_H=T5 Electronic Program Rapid Start. Total Harmonic Distortion < 10%. High Ballast Factor=1.15¹¹ EBT_HDIM=T5 Electronic Program Rapid Start. Total Harmonic Distortion < 10%. Step Dimming, High Ballast Factor=1.15¹² EBT_N=T5 Electronic Program Rapid Start. Total Harmonic Distortion < 10%. Normal Ballast Factor=.90 EBT_NDIM=T5 Electronic Program Rapid Start. Total Harmonic Distortion < 10%. Step Dimming, Normal Ballast Factor=.95-1.0¹³</p> <p>T8 Ballasts EB8_T8 Electronic Start. Total Harmonic Distortion < 10%. EB8_PLUS=T8 Electronic Start. Total Harmonic Distortion < 10%. High Ballast Factor > 1.15 ER8_T8 Electronic Program Rapid Start. Total Harmonic Distortion < 10%. ER8_PLUS=T8 Electronic Program Rapid Start. Total Harmonic Distortion < 10%. High Ballast Factor > 1.15</p> <p>High Performance T8 Ballasts HB8_T8 Electronic Instant Start. Total Harmonic Distortion < 10%. Standard Ballast Factor .86-.88 HB8_H=T8 Electronic Instant Start. Total Harmonic Distortion < 10%. High Ballast Factor 1.15-1.20 HB8_L=T8 Electronic Instant Start. Total Harmonic Distortion < 10%. Low Ballast Factor .77-.82 HB8_N=T8 Electronic Instant Start. Total Harmonic Distortion < 10%. Normal Ballast Factor 1.0 HR8_T8 Electronic Program Rapid Start. Total Harmonic Distortion < 10%. Standard Ballast Factor .86-.88 HR8_DIM=T8 Electronic Program Rapid Start. Total Harmonic Distortion < 10%. Step Dimming, Ballast Factor .88 HR8_H=T8 Electronic Program Rapid Start. Total Harmonic Distortion < 10%. High Ballast Factor 1.15-1.20 HR8_L=T8 Electronic Program Rapid Start. Total Harmonic Distortion < 10%. Low Ballast Factor .71-.79</p> <p>T12 Ballasts EB2_T12 Electronic Rapid Start. Total Harmonic Distortion < 20%.</p>			1=1 Ballast 2=2 Ballasts		
Options	Accessories (Order Separately)					
PI/CPI=Plug-In Option RIF1=Radio Interference Suppressor TILW=Tandem In-Line Wiring Option (Consult TILW Options Catalog Page) ^{3,9} WG/IC-4FT-U (IAF, ICF)=Wireguard for IAF/ICF	<p>A1B/Spacer-U=Spacer 1-1/2" to 2-1/2" From Ceiling (Use 2 Per Fixture) AYC-Chain/Set-U=Chain Hanger Set (Use 1 Set Per Fixture) CLC-SSF=Long Channel Connector SSF GRP-SSF=Gripper Hanger (Use 2 Per Fixture) SCA=Adjustable 48" Stem Set SCF=Fixed Stem Set (Specify Length) SCS=Swivel Stem Set (Specify Length) TOGGLE=Single Toggle Number 2 (Specify Length) WG/ICF-4FT-U=Wire Guard Y-TOGGLE=Y Toggle Number 2 (Specify Length)</p>					

NOTES: 1. Not available when specifying emergencies, voltage must be specified. Exception EL4. 2. Products also available in non-US voltage and frequencies for international markets. 3. See Options or Accessories.
4. 1-Lamp ballast in a High Ballast factor not available. 5. Step Dimming ballast available for 28W T5 and 14WT5 lamps only. 6. 1 Lamp step dimming ballast in normal ballast factor not available. 2-lamp ballast will not operate 1 lamp. 7. HPT8 Ballast required with 28W T8 lamps. 8. Not available with HO lamps. 9. Socket brackets left uninstalled. 10. Not available when specifying emergencies, voltage must be specified. 11. 1-Lamp ballast in a High Ballast factor not available. 12. Step Dimming ballast available for 28W T5 and 14WT5 lamps only. 13. 1-Lamp step dimming ballast in a Normal Ballast factor not available. 2-Lamp ballast will not operate 1-Lamp.

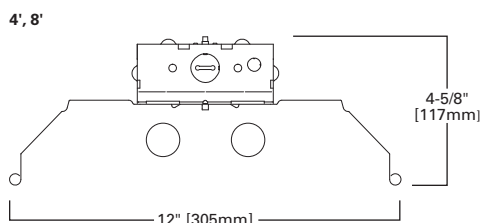

Specifications and dimensions subject to change without notice. Consult your Cooper Lighting Representative or visit www.cooperlighting.com for available options, accessories and ordering information.



DIF SERIES

FEATURES

- Equipped with energy-saving ballasts
- Die-formed channels
- Heavy-duty, apertured or closed-top reflector
- Pressure-lock lampholders (RS), spring loaded lampholders (SL, HO)
- Deep-draw, full-width reflector ribs add rigidity
- Baked white enamel finish
- Apertured reflector standard with 6% uplight
- Porlux and silver-lined finishes
- Also available in tandem 8' lengths

DIMENSIONS

4', 8'

Compliances may not apply to all product configurations. Please consult the product spec sheet for compliance details.

COMPLIANCES: UL/cUL Listed, UL/cUL Listed - Damp Location



ORDERING INFORMATION

SAMPLE NUMBER: DIF-232-UNV-EB81-U

Tandem	Series	Silver Reflector	Number of Lamps (Not Included)	Wattage (Length)	Voltage	Options
8T=8' Length [Blank]=4' Length	DCIF=Closed Top Reflector DIF=Apertured Reflector	SS=SilverLining Reflector ¹	2=2 Lamps	28T5=28W T5 (48") 28T8=28W T8 (48") 32=32W T8 (48") 48HO=44W T8 (48") HO 54T5=54W T5HO (48") 96=59W T8 SL (96") 96HO=86W T8 (96") HO	120V=120 Volt 277V=277 Volt 347V=347 Volt UNV=Universal Voltage 120-277	EL=Emergency Battery Installed (Must Specify Battery Pack, See Options) GL=Single Element Fuse GM=Double Element Fuse

Ballast Type

T5 Ballasts

EBT=T5 or T5HO Linear Electronic Program Rapid Start. Total Harmonic Distortion < 10%.

Ballast/Factor Type (T5)

EBT_H=T5 Electronic Program Rapid Start. Total Harmonic Distortion < 10%. High Ballast Factor 1.15²

EBT_HDIM=T5 Electronic Program Rapid Start. Total Harmonic Distortion < 10%. Step Dimming, High Ballast Factor = 1.15³

EBT_N=T5 Electronic Program Rapid Start. Total Harmonic Distortion < 10%. Normal Ballast Factor .90

EBT_NDIM=T5 Electronic Program Rapid Start. Total Harmonic Distortion < 10%. Step Dimming, Normal Ballast Factor .95-1.0⁴

T8 Ballasts

EB8=T8 Electronic Instant Start, Total Harmonic Distortion < 10%.

EB8/PLUS=T8 Electronic Instant Start, Total Harmonic Distortion < 10%. High Ballast Factor > 1.15

ER8=T8 Electronic Program Rapid Start. Total Harmonic Distortion < 10%.

ER8/PLUS=T8 Electronic Program Rapid Start. Total Harmonic Distortion < 10%. High Ballast Factor > 1.15

High Performance T8 Ballasts

HB8=T8 Electronic Instant Start. Total Harmonic Distortion < 10%. Standard Ballast Factor .86 - .88

HB8_H=T8 Electronic Instant Start. Total Harmonic Distortion < 10%. High Ballast Factor 1.15 - 1.20

HB8_L=T8 Electronic Instant Start. Total Harmonic Distortion < 10%. Low Ballast Factor .77 - .82

HB8_N=T8 Electronic Instant Start. Total Harmonic Distortion < 10%. Normal Ballast Factor 1.0

HR8=T8 Electronic Program Rapid Start. Total Harmonic Distortion < 10%. Standard Ballast Factor .86 - .88

HR8_DIM=T8 Electronic Program Rapid Start. Total Harmonic Distortion < 10%. Step Dimming, Ballast Factor .88

HR8_H=T8 Electronic Program Rapid Start. Total Harmonic Distortion < 10%. High Ballast Factor 1.15 - 1.20

HR8_L=T8 Electronic Program Rapid Start. Total Harmonic Distortion < 10%. Low Ballast Factor .71 - .79

Number of Ballasts	Options	Accessories (Order Separately)
1=1 Ballast 2=2 Ballasts 3=3 Ballasts	6-3/18 SJT-C&P-515P=Cord and Plug (120V) 6-3/18 SJT-C&PL715P=Cord and Plug (277V) PI/CPI=Plug-in Option POX=Porlux Finish RIF1=Radio Interference Suppressor TILW=Tandem in line wiring Option (Consult TILW Option Catalog Page).	A1B/SPACER-U=Spacer 1-1/2" to 2-1/2" from ceiling (Use 2 Per Fixture) ATG-DIF-4-U=Tong Hanger (Use 2 Per Fixture) AYC-CHAIN/SET-U=Chain Hanger Set (Use 1 Set Per Fixture) DIF CLOSED END PLATE=Closed End Plate DIF2 LONG CONN (PREPAINTED)=Long Connector GYM GUARD, GG-DIF=Wire Gym Guard MECL-DIF/SL-48-U=Metal Egg Crate Louver MECL-DIF/SL-96-U=Metal Egg Crate Louver SCA=Adjustable 48" Stem Set SCF=Fixed Stem Set (Specify Length) SCS=Swivel Stem Set (Specify Length) WG/DIF4FT-U=Wire Guard

NOTES: 1. Silver lining not available on fixtures with HO. 2. 1-Lamp ballast in a High Ballast factor not available. 3. Step Dimming ballast available for 28W T5 and 14WT5 lamps only. 4. 1-Lamp step dimming ballast in a Normal Ballast factor not available. 2-Lamp ballast will not operate 1-Lamp.

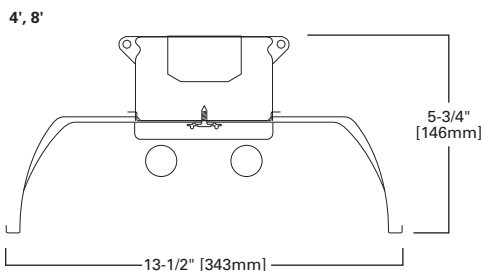

Specifications and dimensions subject to change without notice. Consult your Cooper Lighting Representative or visit www.cooperlighting.com for available options, accessories and ordering information.

T8 INDUSTRIAL



FEATURES

- Equipped with energy-saving ballasts
- Die-formed channels
- Heavy-duty, apertured (DMF) or closed-top (DCMF) reflector
- Deep-draw, full-width reflector ribs add rigidity
- Metal-clad lampholders with spring-loaded sockets
- Apertured reflector standard with uplight
- Baked white enamel finish
- Porlux and silver-lined finishes
- Wire guards, gym guards, lens frames and metal louvers

DIMENSIONS

4', 8'

DMF SERIES

Compliances may not apply to all product configurations. Please consult the product spec sheet for compliance details.

COMPLIANCES: UL/cUL Listed, UL/cUL Listed - Damp Location



ORDERING INFORMATION

SAMPLE NUMBER: DMF-232-UNV-EB81-U

Tandem	Series	Lamp Spacing	Silver Reflector	Number of Lamps (Not Included)	Wattage (Length)	Voltage
[Blank]=4' Length T8=8' Length	DCMF=Closed Top Reflector DMF=Apertured Reflector	[Blank]=Standard Spacing N=Narrow Spacing for 2 Lamps Only (10% uplight)	SS=SilverLining Reflector ¹	2=2 Lamps 3=3 Lamps 4=4 Lamps	28T8=28W T8 (48") 32=32W T8 (48") 48HO=44W T8 (48") HO 96=59W T8 SL (96") 96HO=86W T8 (96") HO	120V=120 Volt 277V=277 Volt 347V=347 Volt UNV=Universal Voltage 120-277
Options		Ballast Type			Number of Ballasts	
EL=Emergency Battery Installed (Must Specify Battery Pack, See Options) GL=Single Element Fuse GM=Double Element Fuse		<p>T8 Ballasts</p> <p>EB8_=T8 Electronic Instant Start. Total Harmonic Distortion < 10%.</p> <p>EB8_/PLUS=T8 Electronic Instant Start. Total Harmonic Distortion < 10%. High Ballast Factor > 1.15</p> <p>ER8_=T8 Electronic Program Rapid Start. Total Harmonic Distortion < 10%.</p> <p>ER8_/PLUS=T8 Electronic Program Rapid Start. Total Harmonic Distortion < 10%. High Ballast Factor > 1.15</p> <p>High Performance T8 Ballasts</p> <p>HB8_=T8 Electronic Instant Start. Total Harmonic Distortion < 10%. Standard Ballast Factor .86 - .88</p> <p>HB8_H=T8 Electronic Instant Start. Total Harmonic Distortion < 10%. High Ballast Factor 1.15 - 1.20</p> <p>HB8_L=T8 Electronic Instant Start. Total Harmonic Distortion < 10%. Low Ballast Factor .77 - .82</p> <p>HB8_N=T8 Electronic Instant Start. Total Harmonic Distortion < 10%. Normal Ballast Factor 1.0</p> <p>HR8_=T8 Electronic Program Rapid Start. Total Harmonic Distortion < 10%. Standard Ballast Factor .86 - .88</p> <p>HR8_DIM=T8 Electronic Program Rapid Start. Total Harmonic Distortion < 10%. Step Dimming. Ballast Factor .88</p> <p>HR8_H=T8 Electronic Program Rapid Start. Total Harmonic Distortion < 10%. High Ballast Factor 1.15 - 1.20</p> <p>HR8_L=T8 Electronic Program Rapid Start. Total Harmonic Distortion < 10%. Low Ballast Factor .71 - .79</p>			<p>1=1 Ballast 2=2 Ballasts 3=3 Ballasts</p>	
Options		Packaging	Accessories (Order Separately)			
6-3/18 SJT-C&P-515P=Cord and Plug (120V) 6-3/18 SJT-C&PL715P=Cord and Plug (277V) PI/CP1=Plug-In Option POX=Porlux Finish RIF1=Radio Interference Suppressor TILW=Tandem In-Line Wiring Option		4B=4 Bulk U=Unit Pack	<p>A-1-B/SPACER-B=Spacer 1-1/2" to 2-1/2" from ceiling (Use 2 Per Fixture)</p> <p>ATG-DIF-4-U=Tong Hanger (Use 2 Per Fixture)</p> <p>AYC-CHAIN/SET-U=(2) V-Hook Hangers, 36" Chain Sets with S Hooks</p> <p>DIF CLOSED END PLATE=Closed End Plate</p> <p>DIF2 LONG CONN (PREPAINTED)=Long Connector</p> <p>GYM GUARD, GG-DIF=Wire Gym Guard</p> <p>MECL-DIF/RS-49-3/4-U=Metal Egg Crate Louver</p> <p>MECL-DIF/RS-99-1/2-U=Metal Egg Crate Louver</p> <p>MECL-DIF/SL-48-U=Metal Egg Crate Louver</p> <p>MECL-DIF/SL-96-U=Metal Egg Crate Louver</p> <p>SCA=Adjustable 48" Stem Set</p> <p>SCF=Fixed Stem Set (Specify Length)</p> <p>SCS=Swivel Stem Set (Specify Length)</p> <p>WG/DIF4FT-U=Wire Guard</p> <p>WG/PA-4FT=Wire Gym Guard with Acrylic Lens</p>			

NOTES: 1. Silver lining not available on fixtures with HO.

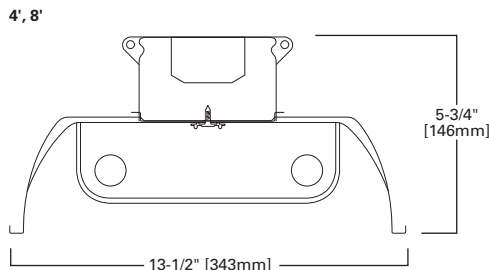

Specifications and dimensions subject to change without notice. Consult your Cooper Lighting Representative or visit www.cooperlighting.com for available options, accessories and ordering information.

FEATURES

- Equipped with energy-saving ballasts
- Die-formed channels
- Heavy-duty, deep-draw, full-width reflector ribs add rigidity
- Baked white enamel finish
- Metal-clad lampholders with spring-loaded sockets
- Porlux and silver-lined finishes
- Apertured or closed-top reflector with Center "V" helps reduce glare
- Wire guards, gym guards, lens frames and metal louvers

DIMENSIONS

4', 8'

Compliances may not apply to all product configurations. Please consult the product spec sheet for compliance details.

COMPLIANCES: UL/cUL Listed - Damp Location



DVMF SERIES



ORDERING INFORMATION

SAMPLE NUMBER: DVMF-232-UNV-EB81-U

Tandem	Series	Silver Reflector	Number of Lamps (Not Included)	Wattage (Length)	Voltage	Options
8T=8' Length [Blank]=4' Length	DCVMF=Closed Top Reflector DVMF=Apertured Reflector	SS=SilverLining Reflector ¹	2=2 Lamps	28T8=28W T8 (48") 32=32W T8 (48") 48HO=48W T8 (48") HO ² 96=59W T8 SL (96") 96=60/75W T12 SL (96") 96HO=86W T8 (96") HO	120V=120 Volt 277V=277 Volt 347V=347 Volt UNV=Universal Voltage 120-277	EL=Emergency Battery Installed (Must Specify Battery Pack, See Options) GL=Single Element Fuse GM=Double Element Fuse
Ballast Type				Number of Ballasts	Options	
T8 Ballasts EB8_=T8 Electronic Instant Start. Total Harmonic Distortion < 10%. EB8_/PLUS=T8 Electronic Instant Start. Total Harmonic Distortion < 10%. High Ballast Factor > 1.15 ER8_=T8 Electronic Program Rapid Start. Total Harmonic Distortion < 10%. ER8_/PLUS=T8 Electronic Program Rapid Start. Total Harmonic Distortion < 10%. High Ballast Factor > 1.15 High Performance T8 Ballasts HB8_=T8 Electronic Instant Start. Total Harmonic Distortion < 10%. Standard Ballast Factor .86 - .88 HB8_H=T8 Electronic Instant Start. Total Harmonic Distortion < 10%. High Ballast Factor 1.15 - 1.20 HB8_L=T8 Electronic Instant Start. Total Harmonic Distortion < 10%. Low Ballast Factor .77 - .82 HB8_N=T8 Electronic Instant Start. Total Harmonic Distortion < 10%. Normal Ballast Factor 1.0 HR8_=T8 Electronic Program Rapid Start. Total Harmonic Distortion < 10%. Standard Ballast Factor .86 - .88 HR8_DIM=T8 Electronic Program Rapid Start. Total Harmonic Distortion < 10%. Step Dimming. Ballast Factor .88 HR8_H=T8 Electronic Program Rapid Start. Total Harmonic Distortion < 10%. High Ballast Factor 1.15 - 1.20 HR8_L=T8 Electronic Program Rapid Start. Total Harmonic Distortion < 10%. Low Ballast Factor .71 - .79				1=1 Ballast 2=2 Ballasts 3=3 Ballasts	6-3/18 SJT-C&P-515P=Cord and Plug (120V) 6-3/18 SJT-C&PL715P=Cord and Plug (277V) PI/CPI=Plug-in Option POX=Porlux Finish RIF1=Radio Interference Suppressor TILW=Tandem In-Line Wiring Option	
Packaging	Accessories (Order Separately)					
4B=4 Bulk U=Unit Pack	A-1-B/SPACER-B=Spacer 1-1/2" to 2-1/2" from ceiling (Use 2 Per Fixture) ATG-DIF-4-U=Tong Hanger (Use 2 Per Fixture) AYC-CHAIN/SET-U=(2) V-Hook Hangers, 36" Chain Sets with S Hooks DIF CLOSED END PLATE=Closed End Plate DIF2 LONG CONN (PREPAINTED)=Long Connector GYM GUARD, GG-DIF=Wire Gym Guard MECL-DIF/RS-49-3/4-U=Metal Egg Crate Louver MECL-DIF/RS-99-1/2-U=Metal Egg Crate Louver MECL-DIF/SL-48-U=Metal Egg Crate Louver MECL-DIF/SL-96-U=Metal Egg Crate Louver			SCA=Adjustable 48" Stem Set SCF=Fixed Stem Set (Specify Length) SCS=Swivel Stem Set (Specify Length) WG/DIF4FT-U=Wire Guard WG/PA-4FT=Wire Gym Guard with Acrylic Lens		

NOTES: 1. Silver lining not available on fixtures with HO. 2. For use with EB2_ Ballasts.

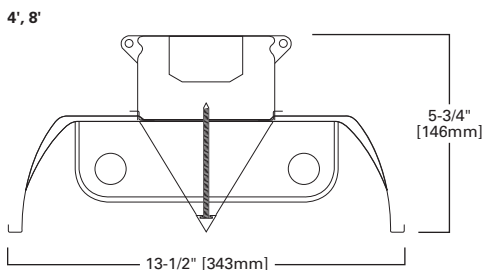

Specifications and dimensions subject to change without notice. Consult your Cooper Lighting Representative or visit www.cooperlighting.com for available options, accessories and ordering information.

OPTICAHP HIGH PERFORMANCE ENERGY SAVINGS T8 PARABOLIC



FEATURES

- High-performance T8 system for maximum energy savings
- Die-formed nominal 4-3/4" deep para-contoured housing
- High-reflectance matte finish maximizes efficiency and performance
- 2" nominal precision-cell, straight-blade faceted, steel louver
- Positive cam latch, safety lock T-hinges allow hinging on either side
- Provided with CEE-listed, energy-saving ballasts
- 97% reflective white optics material available
- Rotor-lock lampholders and end plate grid-lock features
- Commercial, school, hospital or retail merchandising areas

DIMENSIONS

1' x 4', 2' x 2', 2' x 4'

OPTICAHP SERIES

Compliances may not apply to all product configurations. Please consult the product spec sheet for compliance details.

COMPLIANCES: UL/cUL Listed, UL/cUL Listed - Damp Location, IC Rated, City of Chicago Approved



ORDERING INFORMATION

SAMPLE NUMBER: 2OPG-232FB26W-UNV-HB81L-U

Rating	Width	Series	Trim Type	White Optics	Type	Number of Lamps (Not Included)
[Blank]=Standard ATW-SW4=Air-Tight Wire Way (Chicago Rated)	2=2' Width [Blank]=1' Width	OP=Optica HP Series	F=Aluminum Flange Trim ¹ G=Concealed-T/Slot Grid ² G=Grid/Lay-in (Standard) MZ=Modular Trim	WO=97% Reflective White Optics Finish	IC=IC Rated	1=1 Lamp ³ 2=2 Lamps
Wattage (Length)	Cross Blade	Cell Configuration	Louver Finish	Option - Aluminum Flange Trim ¹	Voltage ⁴	
17=17W T8 (24") 28T8=28W T8 (48") 32=32W T8 (48") U1-5/8=31W T8 (24")	FB=Faceted Blade	16=1 Rows of 6, 6 Cell (1' x 4') 23=2 Rows of 3, 6 Cell (2' x 2') 26=2 Rows of 6, 12 Cell (2' x 4')	W=Matte White	[Blank]=SW (Single White) EN=End of Row, Natural Finish EW=End of Row, White Finish RN=In Row, Natural Finish RW=In Row, White Finish SN=Single, Natural Finish	120V=120 Volt 277V=277 Volt 347V=347 Volt UNV=Universal Voltage 120-277 ⁵	
Options		Ballast Type				
EL=Emergency Installed (Must Specify Battery Pack, See Options) ⁶ Flex=Flex Installed (Reference Flex Ordering Information) GL=Single Element Fuse GM=Double Element Fuse Lamps=Lamps Installed (Refer to Lamp Ordering Options)		T8 Ballasts EB8_=T8 Electronic Instant Start. Total Harmonic Distortion < 10%. EB8_/PLUS=T8 Electronic Start. Total Harmonic Distortion < 10%. High Ballast Factor > 1.15 ER8_=T8 Electronic Program Rapid Start. Total Harmonic Distortion < 10%. High Performance T8 Ballasts HB8_=T8 Electronic Instant Start. Total Harmonic Distortion < 10%. Standard Ballast Factor .86-.88 HB8_H=T8 Electronic Instant Start. Total Harmonic Distortion < 10%. High Ballast Factor 1.15-1.20 HB8_L=T8 Electronic Instant Start. Total Harmonic Distortion < 10%. Low Ballast Factor .77-.82 HB8_N=T8 Electronic Instant Start. Total Harmonic Distortion < 10%. Normal Ballast Factor 1.0 HR8_=T8 Electronic Program Rapid Start. Total Harmonic Distortion < 10%. Standard Ballast Factor .86-.88 HR8_DIM=T8 Electronic Program Rapid Start. Total Harmonic Distortion < 10%. Step Dimming. Ballast Factor .88 HR8_H=T8 Electronic Program Rapid Start. Total Harmonic Distortion < 10%. High Ballast Factor 1.15-1.20 HR8_L=T8 Electronic Program Rapid Start. Total Harmonic Distortion < 10%. Low Ballast Factor .71-.79				
Number of Ballasts	Options	Packaging	Accessories (Order Separately)			
1=1 Ballast 2=2 Ballasts	R=Internal Reflector (Not available for U1-5/8 Lamp)	PAL=Job Pack, out of carton PALC=Job Pack, in carton U=Unit Pack	EQ-CLIP-U=T-BAR Safety Earthquake Clips ⁷			

NOTES: 1. Specify row configuration, type in catalog number when ordering complete fixtures. 2. Louver is recessed by 5/16" in Concealed T or Slot Grid T. 3. 1' x 4' only. 4. Products also available in non-US voltage and frequencies for international markets. 5. Not available when specifying emergencies, voltage must be specified. 6. Fixtures equipped with "EL" option may require a 5-1/2" housing depth. If installing in field, must use low profile battery pack. 7. An EQ Grid Clip is recommended for all 9/16" ceiling systems. Four required per fixture.

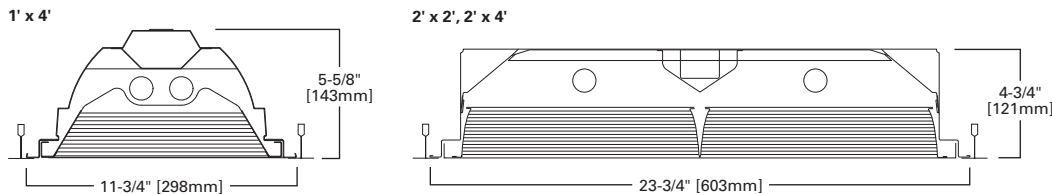

Specifications and dimensions subject to change without notice. Consult your Cooper Lighting Representative or visit www.cooperlighting.com for available options, accessories and ordering information.

FEATURES

- High-performance T8 system for maximum energy savings
- Die-formed nominal 4-3/4" deep para-contoured housing
- Computer-designed, 2" tall precision-cell parabolic louver
- Louvers available in white or silver semi-specular finish
- High-reflectance finish maximizes efficiency and performance
- Positive cam latch, safety lock T-hinges allow hinging on either side
- Positively secured Class P ballast
- 97% reflective white optics material available
- Rotor-lock lampholders, end plate grid-lock and air supply options

DIMENSIONS

2' x 2', 2' x 4'

Compliances may not apply to all product configurations. Please consult the product spec sheet for compliance details.

COMPLIANCES: UL/cUL Listed, UL/cUL Listed - Damp Location, IC Rated, City of Chicago Approved



2HP2 SERIES



ORDERING INFORMATION

SAMPLE NUMBER: 2HP2GX-232W26P-UNV-HB81-U

Rating	Heat Removal ¹	Width	Series	Trim Type ²	Air Supply	White Optics	Type
[Blank]=Standard ATW-SW4=Chicago Rated	HR=Heat Removal ¹	2=2' Width	HP2=High Performance 2" Parallax Louver	F=Aluminum Flange Trim ⁴ G=Concealed-T/Slot Grid ³ G=Grid/Lay-in (Standard) MZ=Modular Trim	AVX=Air Supply Floating Louver with Directional Air Vane AX=Air Supply Floating Louver X=Blank Side/Floating Louver - Non Air Supply	WO=97% Reflective White Optics Finish	IC=IC Rated
Number of Lamps (Not Included)	Wattage	Louver Color	Cell Configuration	Louver Finish	Option - Aluminum Flange Trim ⁴		
2=2 Lamps 3=3 Lamps ⁹	17=17W T8 (24") 28T8=28W T8 (48") 32=32W T8 (48") U1-5/8=31W T8 (24")	S=Silver W=White	23=2 Rows of 3, 6 Cell (2' x 2') 26=2 Rows of 6, 12 Cell (2' x 4') 33=3 Rows of 3, 9 Cell (2' x 2') 36=3 Rows of 6, 18 Cell (2' x 4')	I=Semi-Specular/Haze (Low Iridescent) Standard (Silver Only) P=Painted White (Standard)	[Blank]=SW (Single White) EN=End of Row Natural Finish EW=End of Row, White Finish RN=In Row, Natural Finish RW=In Row, White Finish SN=Single, Natural Finish		
Voltage ⁵	Options	Ballast Type					
120V=120 Volt 277V=277 Volt 347V=347 Volt UNV=Universal Voltage 120-277 ⁶	EL=Emergency Battery Installed (Must Specify Battery Pack, See Options) ⁷ Flex=Flex Installed (Reference Flex Ordering Information) GL=Single Element Fuse GM=Double Element Fuse Lamps=Lamps Installed (Refer to Lamp Ordering) WTR=White Reveal	High Performance T8 Ballasts HB8 =T8 Electronic Instant Start. Total Harmonic Distortion < 10%. Standard Ballast Factor .86 - .88 HB8_H=T8 Electronic Instant Start. Total Harmonic Distortion < 10%. High Ballast Factor 1.15 - 1.20 HB8_L=T8 Electronic Instant Start. Total Harmonic Distortion < 10%. Low Ballast Factor .77 - .82 HB8_N=T8 Electronic Instant Start. Total Harmonic Distortion < 10%. Normal Ballast Factor 1.0 HR8 =T8 Electronic Program Rapid Start. Total Harmonic Distortion < 10%. Standard Ballast Factor .86 - .88 HR8_DIM=T8 Electronic Program Rapid Start. Total Harmonic Distortion < 10%. Step Dimming. Ballast Factor .88 HR8_H=T8 Electronic Program Rapid Start. Total Harmonic Distortion < 10%. High Ballast Factor 1.15 - 1.20 HR8_L=T8 Electronic Program Rapid Start. Total Harmonic Distortion < 10%. Low Ballast Factor .71 - .79					
Options	Packaging	Accessories (Order Separately)					
REP=Riveted End Plates RIF1=Radio Interference Suppressor	PAL=Job Pack, out of carton PALC=Job Pack, in carton U=Unit Pack	EQ-CLIP-U=T-BAR Safety Earthquake Clips ²					

NOTES: 1. Integral End Plate Grid Lock feature not available in Heat Removal. 2. An EQ Grid Clip is recommended for all 9/16" ceiling systems. Four required per fixture. 3. Louver is recessed by 5/16" in Concealed T or Slot Grid T. 4. Specify row configuration, type in catalog number when ordering complete fixtures. 5. Products also available in non-US voltage and frequencies for international markets. 6. Not available when specifying emergencies, voltage must be specified. 7. Fixtures equipped with "EL" option may require a 5-1/2" housing depth. If installing in field, must use low profile battery pack. 8. 2' x 4' only. 9. Standard off-center ballast on 3-lamp fixtures.

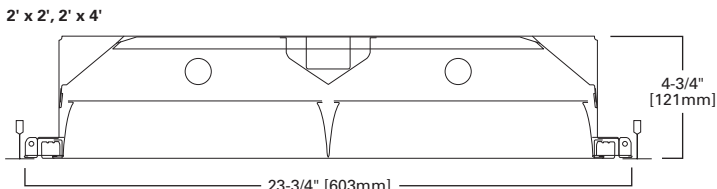

PARALUX III HIGH PERFORMANCE T8 PARABOLIC



FEATURES

- High-performance T8 system for maximum energy savings
- Die-formed nominal 4-3/4" deep para-contoured housing
- Housing features die-formed stiffeners for added rigidity
- Louvers available in white or silver semi-specular finish
- 3" nominal precision-cell, parabolic, high-performance louver
- High-reflectance finish maximizes efficiency and performance
- 97% reflective white optics material available
- Positively secured Class P ballast
- Rotolock lampholders, end plate grid-lock and air supply options

DIMENSIONS

2' x 2', 2' x 4'

2HP3 SERIES

Compliances may not apply to all product configurations. Please consult the product spec sheet for compliance details.

COMPLIANCES: UL/cUL Listed, UL/cUL Listed - Damp Location, IC Rated, City of Chicago Approved



ORDERING INFORMATION

SAMPLE NUMBER: 2HP3GX-332W36P-UNV-HB81-U

Rating	Heat Removal ¹	Width	Series	Trim Type	Air Supply	White Optics	Type	Number of Lamps (Not Included)
[Blank]=Standard ATW-SW4=Chicago Rated	HR=Heat Removal ¹	2=2' Width	HP3=High Performance 3" Parallax Louver	F=Aluminum Flange Trim ² G=Concealed-T/Slot Grid ³ G=Grid/Lay-in (Standard) MZ=Modular Trim	AVX=Air Supply Floating Louver with Directional Air Vane AX=Air Supply Floating Louver X=Blank Side/ Floating Louver - Non Air Supply	WO=97% Reflective White Optics Finish	IC=IC Rated	2=2 Lamps 3=3 Lamps ⁴
Wattage	Louver Color	Cell Configuration	Louver Finish	Option - Aluminum Flange Trim ²	Voltage ⁵			
17=17W T8 (24") 28T8=28W T8 (48") 32=32W T8 (48") U15/8=31W T8 (24")	S=Silver W=White	23=2 Rows of 3, 6 Cell (2' x 2') 26=2 Rows of 6, 12 Cell (2' x 4') 33=3 Rows of 3, 9 Cell (2' x 2', 2024) 36=3 Rows of 6, 18 Cell (2' x 4')	I=Semi-Specular/Haze (Low Iridescent) (Silver Only) P=Painted White (Standard)	[Blank]=SW (Single White) EN=End of Row, Natural Finish EW=End of Row, White Finish RN=In Row, Natural Finish RW=In Row, White Finish SN=Single, Natural Finish	120V=120 Volt 277V=277 Volt 347V=347 Volt UNV=Universal Voltage 120-277 ⁶			
Options				Ballast Type				
EL=Emergency Battery Installed (Must Specify Battery Pack, See Options) ⁷ Flex=Flex Installed (Reference Flex Ordering Information) GL=Single Element Fuse GM=Double Element Fuse Lamps=Lamps Installed (Refer to Lamp Ordering Options) WTR=White Reveal Lamps Installed [Blank]=No Lamps Installed L8835=T8 Lamp, 28W and 32W, 3500K L8835HL=T8 Lamp, 32W 3500K, 3100 Lumens L8841=T8 Lamp, 28W and 32W, 4100K L8841HL=T8 Lamp, 32W 4100K, 3100 Lumens				High Performance T8 Ballasts HB8 =T8 Electronic Instant Start. Total Harmonic Distortion < 10%. Standard Ballast Factor .86 - .88 HB8_H=T8 Electronic Instant Start. Total Harmonic Distortion < 10%. High Ballast Factor 1.15 - 1.20 HB8_L=T8 Electronic Instant Start. Total Harmonic Distortion < 10%. Low Ballast Factor .77 - .82 HB8_N=T8 Electronic Instant Start. Total Harmonic Distortion < 10%. Normal Ballast Factor 1.0 HR8 =T8 Electronic Program Rapid Start. Total Harmonic Distortion < 10%. Standard Ballast Factor .86 - .88 HR8_DIM=T8 Electronic Program Rapid Start. Total Harmonic Distortion < 10%. Step Dimming. Ballast Factor .88 HR8_H=T8 Electronic Program Rapid Start. Total Harmonic Distortion < 10%. High Ballast Factor 1.15 - 1.20 HR8_L=T8 Electronic Program Rapid Start. Total Harmonic Distortion < 10%. Low Ballast Factor .71 - .79				
Number of Ballasts	Options	Packaging	Accessories (Order Separately)					
1=1 Ballast 2=2 Ballasts 3=3 Ballasts ⁸	REP=Riveted End Plates RIF1=Radio Interference Suppressor	PAL=Job Pack, out of carton PALC=Job Pack, in carton U=Unit Pack	EQ-CLIP-U=T-BAR Safety Earthquake Clips ⁹					

NOTES: 1. Integral End Plate Grid Lock feature not available in Heat Removal. 2. Specify row configuration, type in catalog number when ordering complete fixtures. 3. Louver is recessed by 5/16" in Concealed T or Slot Grid T. 4. Standard off-center ballast on 3-lamp fixtures. 5. Products also available in non-US voltage and frequencies for international markets. 6. Not available when specifying emergencies, voltage must be specified. 7. Fixtures equipped with "EL" option may require a 5-1/2" housing depth. If installing in field, must use low profile battery pack. 8. 2' x 4' only. 9. An EQ Grid Clip is recommended for all 9/16" ceiling systems. Four required per fixture.

2' x 2', 2' x 4'

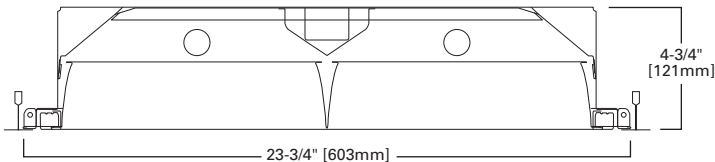

Specifications and dimensions subject to change without notice. Consult your Cooper Lighting Representative or visit www.cooperlighting.com for available options, accessories and ordering information.

FEATURES

- Provided with CEE-listed energy-saving ballasts
- Computer-designed, 3" nominal precision-cell parabolic louver
- Die-formed, para-contoured body with stiffeners for rigidity
- Louvers available in white or silver semi-specular finish
- Positive cam latch, safety lock T-hinges allow hinging on either side
- Floating louver with black reveal
- Efficient air-handling options with or without air control vanes
- Four auxiliary fixture-end suspension points provided
- Unique louver tannenbaum design option



2EP3GAX SERIES

DIMENSIONS

1' x 4', 2' x 2', 2' x 4', 20" x 24", 20" x 48"

Compliances may not apply to all product configurations. Please consult the product spec sheet for compliance details.

COMPLIANCES: UL/cUL Listed, UL/cUL Listed - Damp Location, IC Rated, City of Chicago Approved, NOM Certified



ORDERING INFORMATION

SAMPLE NUMBER: 2EP3GX-332S36I-L8835-UNV-EB81-U

Rating	Hard Metric	Heat Removal ¹	Width	Series	Trim Type	Air Supply	20" Width	Type
[Blank]=Standard ATW-SW4=Air-Tight Wire Way (Chicago Rated)	HM=Hard Metric	HR=Heat Removal	2=2' Width [Blank]=1' Width ²	EP3=Paralux III	F=Aluminum Flange Trim ³ G=Concealed-T/Slot Grid ⁴ G=Grid/Lay-in (Standard) MZ=Modular Trim ⁴	AVX=Air Supply Floating Louver with Directional Air Vane AX=Air Supply Floating Louver X=Blank Side/Floating Louver - Non-Air Supply	2024=20" Width x 24" Length 2048=20" Width x 48" Length	IC=IC Rated

Number of Lamps (Not Included)	Wattage	Louver Color	Cell Configuration	Louver Finish	Distribution	
1=1 Lamp ⁵ 2=2 Lamps 3=3 Lamps ^{6,19} 4=4 Lamps ⁶	14T5=14W T5 (24") 17=17W T8 (24") 24T5=24W T5HO (24") 28T5=28W T5 (48") 28T8=28W T8 (48") 32=32W T8 (48") 54T5=54W T5HO (48") BX40=40W Biax (24") U15/8=31W T8 (24") ⁷ U6T8=32W T8 (24") ^{8,7}	S=Silver ST=Silver Tannenbaum W=White	112=1 Row of 12, 12 Cell (1' x 4') ¹⁰ 16=1 Row of 6, 6 Cells (1' x 4') 18=1 Row of 8, 8 Cells (1' x 4') 212=2 Rows of 12, 24 Cell (1' x 4') ¹⁰ 23=2 Rows of 3, 6 Cell (2' x 2') 26=2 Rows of 6, 12 Cell (2' x 4') 28=2 Rows of 8, 16 Cell (2' x 4') 312=3 Rows of 12, 36 Cell (2' x 4') ¹⁰	33=3 Rows of 3, 9 Cell (2' x 2', 2024) 34=3 Rows of 4, 12 Cell (2' x 2', 2024) 36=3 Rows of 6, 18 Cell (2' x 4', 2048) 36=3 Rows of 6, 18 Cell (2' x 2', ST Only) ⁹ 38=3 Rows of 8, 24 Cell (2' x 4', 2048) 44=4 Rows of 4, 16 Cell (2' x 2', 2024) 46=4 Rows of 6, 24 Cell (2' x 4') 48=4 Rows of 8, 32 Cell (2' x 4', 2048)	I=Semi-Specular/Haze (Low Iridescent) Standard MI=Specular/Mirrored (Low Iridescent) P=Painted	[Blank]=Standard ASY=Asymmetric High Throw Wall Wash ⁵ SYM=Symmetric High Throw Wall Wash ⁵

Option - Aluminum Flange Trim ³	Voltage ¹¹	Options
[Blank]=SW (Single White) EN=End of Row, Natural Finish EW=End of Row, White Finish RN=In Row, Natural Finish	RW=In Row, White Finish SN=Single, Natural Finish SW=Single, White Finish	120V=120 Volt 277V=277 Volt 347V=347 Volt UNV=Universal Voltage 120-277 ¹²

Ballast Type

EB5 =T5 Biax Electronic Instant Start. Total Harmonic Distortion < 20%. ¹⁴ EB8 =T8 Electronic Start. Total Harmonic Distortion < 10%. EB8 /PLUS=T8 Electronic Start. Total Harmonic Distortion < 10%. High Ballast Factor > 1.15 EBT =T5 or T5HO Electronic Program Rapid Start. Total Harmonic Distortion < 10%. ER5 =T5 Biax Electronic Program Rapid Start. Total Harmonic Distortion < 10%. ¹⁴ ER8 =T8 Electronic Program Rapid Start. Total Harmonic Distortion < 10%. TEB5 =T5 Biax Electronic Instant Start. Total Harmonic Distortion < 10%. ¹⁴	High Performance T8 Ballasts HB8 =T8 Electronic Instant Start. Total Harmonic Distortion < 10%. Standard Ballast Factor .86 - .88 HB8_H=T8 Electronic Instant Start. Total Harmonic Distortion < 10%. High Ballast Factor 1.15 - 1.20 HB8_L=T8 Electronic Instant Start. Total Harmonic Distortion < 10%. Low Ballast Factor .77 - .82 HB8_N=T8 Electronic Instant Start. Total Harmonic Distortion < 10%. Normal Ballast Factor 1.0 HR8 =T8 Electronic Program Rapid Start. Total Harmonic Distortion < 10%. Standard Ballast Factor .86 - .88 HR8_DIM=T8 Electronic Program Rapid Start. Total Harmonic Distortion < 10%. Step Dimming. Ballast Factor .88 HR8_H=T8 Electronic Program Rapid Start. Total Harmonic Distortion < 10%. High Ballast Factor 1.15 - 1.20 HR8_L=T8 Electronic Program Rapid Start. Total Harmonic Distortion < 10%. Low Ballast Factor .71 - .79
--	--

Number of Ballasts	Options	Packaging	Accessories (Order Separately)
1=1 Ballast 2=2 Ballasts 3=3 Ballasts (2' x 4')	LAO=Less Access Opening ⁷ PAF=Painted After Fabrication	REP=Riveted End Plates RIF1=Radio Interference Suppressor	EQ-CLIP-U=T-BAR Safety Earthquake Clips ¹⁸

NOTES: 1. Integral End Plate Grid Lock feature not available in Heat Removal. 2. For 20" width, must specify 2024 or 2048 in ordering logic. 3. Specify row configuration, type in catalog number when ordering complete fixtures. 4. Louver is recessed by 5/16" in Concealed T or Slot Grid T. 5. 1' x 4' only. 6. 2' x 2' and 2' x 4' only. 7. 2' x 2' only. 8. 2 lamp 2' x 2' only. 9. These cell configurations are also available in Silver Tannenbaum (ST). 10. 112, 212 and 312 are only available in Silver Tannenbaum (ST). 11. Products also available in non-US voltage and frequencies for international markets. 12. Not available when specifying emergencies, voltage must be specified. 13. Fixtures equipped with "EL" option may require a 5-1/2" housing depth. If installing in field, must use low profile battery pack. 14. Not available in UNV voltage. Must specify voltage. 15. 1-Lamp ballast in a High Ballast factor not available. 16. Step Dimming ballast available for 28W T5 and 14W T5 lamps only. 17. 1-Lamp step dimming ballast in a Normal Ballast factor not available. 2-Lamp ballast will not operate 1-Lamp. 18. Recommended for all 9/16" ceiling systems. Four per fixture. 19. Standard off-center ballast on 3-lamp fixtures.

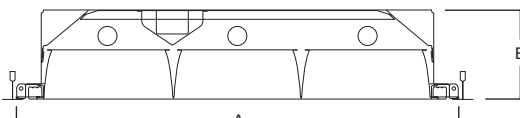

NOMINAL SIZE	A	B
1' x 4'	11-3/4" (298mm)	6-5/8" (168mm)
1' x 4' (OU)	11-3/4" (298mm)	8-1/4" (210mm)
2' x 2'	23-3/4" (603mm)	4-3/4" (121mm)
2' x 4'	23-3/4" (603mm)	4-3/4" (121mm)
20" x 24"	19-3/4" (502mm)	5-5/8" (143mm)
20" x 48"	19-3/4" (502mm)	5-5/8" (143mm)

PRODUCT INFORMATION FOR PARALUX III

Housing Size	Louver Cell Configuration*	Number of Cells
1' x 4'	16, 18, 26, 28	6, 8, 12, 16
2' x 2'	23, 33, 34, 44	6, 9, 12, 16
20" x 24"	23, 24, 33, 34	6, 8, 9, 12
20" x 48"	26, 36, 38	12, 18, 24
2' x 4'	26, 28, 36, 38, 46, 48	12, 16, 18, 24, 24, 32

*example: 36= 3 rows of 6 (18 cells)

PARALUX II RECESSED AIR SUPPLY TROFFER



FEATURES

- Provided with CEE-listed, energy-saving ballasts
- Computer-designed, 2" tall precision-cell parabolic louver
- Die-formed housing with four auxiliary end suspension points
- Positive cam latch, safety lock T-hinges allow hinging on either side
- Rotor-lock lampholders, end plate grid-lock and air supply options
- Efficient air-handling options with or without air control vanes
- Floating louver with black reveal
- Louvers available in white or silver semi-specular finish

DIMENSIONS

1' x 4', 2' x 2', 2' x 4', 20" x 24", 20 x 48"

Compliances may not apply to all product configurations. Please consult the product spec sheet for compliance details.

COMPLIANCES: UL/cUL Listed, UL/cUL Listed - Damp Location, City of Chicago Approved, NOM Certified

2P2GAX SERIES



ORDERING INFORMATION

SAMPLE NUMBER: 2P2GAX-232S511-UNV-EB81-U

Rating	Heat Removal	Width	Series	Trim Type	Air Supply	20" Width	Number of Lamps	Wattage	Louver Color
[Blank]=Standard ATW-SW4=Air-Tight Wire Way (Chicago Rated)	HR=Heat Removal ¹	2=2' Width [Blank]=1' Width ²	P2=Paralux II, 2" Louver Depth	F=Aluminum Flange Trim ³ G=Concealed-T/Slot Grid ⁴ G =Grid/Lay-in (Standard) MZ=Modular Trim ⁴	AVX=Air Supply Floating Louver with Directional Air Vane AX=Air Supply Floating Louver X=Blank Side/ Floating Louver - Non Air Supply	2024=20" Width x 24" Length 2048=20" Width x 48" Length	(Not Included) 1=1 Lamp ⁵ 2=2 Lamps 3=3 Lamps ⁶ 4=4 Lamps	14WT5=14W T5 (24") 17=17W T8 (24") 24WT5=24W T5HO (24") 28T5=28W T5 (48") 28T8=28W T8 (48") 32=32W T8 (48") 54T5=54W T5HO (48") BX40=40W Biax (24") ⁷ U15/8=31W T8 (24") U6T8=32W T8 (24") ^{7,8}	S=Silver W=White
Cell Configuration				Louver Finish	Option - Aluminum Flange Trim ³	Voltage ⁹	Options		
111=1 Row of 11, 11 Cell (1' x 4') 113=1 Row of 13, 13 Cell (1' x 4') 211=2 Rows of 11, 22 Cell (1' x 4') 213=2 Rows of 13, 26 Cell (1' x 4') 22=2 Rows of 2, 4 Cell (2' x 2') 23=2 Rows of 3, 6 Cell (2' x 2') 26=2 Rows of 6, 12 Cell (2' x 4') 28=2 Rows of 8, 16 Cell (2' x 4') 311=3 Rows of 11, 33 Cell (1' x 4', 2' x 4')				I=Semi-Specular/Haze (Low Iridescent) Standard (Silver Only) MI=Specular/Mirrored (Low Iridescent) (Silver Only) P=Painted (White Only)	[Blank]=SW (Single White) EN=End of Row, Natural Finish EW=End of Row, White Finish RN=In Row, Natural Finish RW=In Row, White Finish SN=Single, Natural Finish	120V=120 Volt 277V=277 Volt 347V=347 Volt UNV=Universal Voltage 120-277 ¹⁰	EL=Emergency Installed (Must Specify Battery Pack, See Options) Flex=Flex Installed (Reference Flex Ordering Information) GL=Single Element Fuse GM=Double Element Fuse Lamps=Lamps Installed (Refer to Lamp Ordering Options) WTR=White Reveal		

Ballast Type

EB5=T5 Biax Electronic Instant Start. Total Harmonic Distortion < 20%.¹¹
 EB8=T8 Electronic Start. Total Harmonic Distortion < 10%.
 EB8_/PLUS=T8 Electronic Start. Total Harmonic Distortion < 10%. High Ballast Factor > 1.15.
 EBT=T5 or T5HO Electronic Program Rapid Start. High Ambient. Total Harmonic Distortion < 10%.
 ER5=T5 Biax Electronic Program Rapid Start. Total Harmonic Distortion < 10%.
 ER8=T8 Electronic Program Rapid Start. Total Harmonic Distortion < 10%.
 TEB5=T5 Biax Electronic Instant Start. Total Harmonic Distortion < 10%.¹¹

Ballast/Factor Type (T5)

EBT_H=T5 Electronic Program Rapid Start. Total Harmonic Distortion < 10%. High Ballast Factor=1.15¹²
 EBT_HDIM=T5 Electronic Program Rapid Start. Total Harmonic Distortion < 10%. Step Dimming, High Ballast Factor=1.15¹³
 EBT_N=T5 Electronic Program Rapid Start. Total Harmonic Distortion < 10%. Normal Ballast Factor=.90
 EBT_NDIM=T5 Electronic Program Rapid Start. Total Harmonic Distortion < 10%. Step Dimming, Normal Ballast Factor=.95-1.0¹⁴

High Performance T8 Ballasts

HB8=T8 Electronic Instant Start. Total Harmonic Distortion < 10%. Standard Ballast Factor .86 - .88
 HB8_H=T8 Electronic Instant Start. Total Harmonic Distortion < 10%. High Ballast Factor 1.15 - 1.20
 HB8_L=T8 Electronic Instant Start. Total Harmonic Distortion < 10%. Low Ballast Factor .77 - .82
 HB8_N=T8 Electronic Instant Start. Total Harmonic Distortion < 10%. Normal Ballast Factor 1.0
 HR8=T8 Electronic Program Rapid Start. Total Harmonic Distortion < 10%
 Standard Ballast Factor .86 - .88
 HR8_DIM=T8 Electronic Program Rapid Start. Total Harmonic Distortion < 10%. Step Dimming, Ballast Factor .88
 HR8_H=T8 Electronic Program Rapid Start. Total Harmonic Distortion < 10%. High Ballast Factor 1.15 - 1.20
 HR8_L=T8 Electronic Program Rapid Start. Total Harmonic Distortion < 10%. Low Ballast Factor .71 - .79

Number of Ballast	Options	Packaging	Accessories (Order Separately)
1=1 Ballast 2=2 Ballasts ¹⁵ 3=3 Ballasts ¹⁶	LAO=Less Access Opening ¹⁵ PAF=Painted After Fabrication	REP=Riveted End Plates RIF1=Radio Interference Filter	EQ-CLIP-U=T-BAR Safety Earthquake Clips ¹⁷

NOTES: 1. Integral End Plate Grid Lock feature not available in Heat Removal. 2. For 20" width, must specify 2024 or 2048 in ordering logic. 3. Specify row configuration, type in catalog number when ordering complete fixtures. 4. Louver is recessed by 5/16" in Concealed T or Slot Grid T. 5. 1' x 4' only. 6. Standard off-center ballast on 3-lamp fixtures. 7. 2' x 2' only. 8. 2 lamp only. 9. Products also available in non-US voltage and frequencies for international markets. 10. Not available when specifying emergencies, voltage must be specified. 11. Not available in UNV voltage. Must specify voltage. 12. 1-Lamp ballast in a High Ballast factor not available. 13. Step Dimming ballast available for 28W T5 and 14WT5 lamps only. 14. 1-Lamp step dimming ballast in a Normal Ballast factor not available. 2-Lamp ballast will not operate 1-Lamp. 15. Less Access Opening (LAO) in housing is required for 2' x 2' sizes. 16. 2' x 4' only. 17. An EQ Grid Clip is recommended for all 9/16" ceiling systems. Four required per fixture.

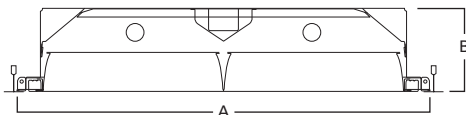

NOMINAL SIZE	A	B
1' x 4'	11-3/4" (298mm)	5-5/8" (143mm)
2' x 2'	23-3/4" (603mm)	4-3/4" (121mm)
2' x 4'	23-3/4" (603mm)	4-3/4" (121mm)
20" x 24"	19-3/4" (502mm)	4-5/8" (117mm)
20" x 48"	19-3/4" (502mm)	4-5/8" (117mm)

PRODUCT INFORMATION FOR PARALUX II

Housing Size	Louver Cell Configuration*	Number of Cells
1' x 4'	111, 113, 211, 213, 311	11, 13, 22, 26, 33
2' x 2'	22, 23, 33, 34, 44, 55	4, 6, 9, 12, 16, 25
20" x 24"	33, 34, 44, 45	9, 12, 16, 20
20" x 48"	36, 38, 48, 411	18, 24, 32, 44
2' x 4'	26, 28, 36, 38, 311, 46, 48, 411	12, 16, 18, 24, 33, 24, 32, 44

*Example: 36= 3 rows of 6 (18 cells)

FEATURES

- Provided with CEE-listed energy-saving ballasts
- Computer-designed, 4" tall precision-cell parabolic louver
- Die-formed, deep para-contoured body with end plate grid-lock feature
- Positive cam latch, safety lock T-hinges allow hinging on either side
- Louvers available in white, specular or silver semi-specular finish
- Efficient air-handling options with or without air control vanes
- Four auxiliary fixture-end suspension points provided
- Floating louver with black reveal
- Hard metric configurations available

DIMENSIONS

1' x 4', 2' x 2', 2' x 4', 20" x 24", 20" x 48"

Compliances may not apply to all product configurations. Please consult the product spec sheet for compliance details.

COMPLIANCES: UL/cUL Listed, UL/cUL Listed - Damp Location, City of Chicago Approved, NOM Certified



2PGAX SERIES



ORDERING INFORMATION

SAMPLE NUMBER: 2PGAX-232S39I-UNV-EB81-U

Rating	Hard Metric	Heat Removal ¹	Width	Series	Trim Type	Air Supply	20" Width	Number of Lamps (Not Included)	Wattage
[Blank]=Standard ATW-SW4=Air-Tight Wire Way (Chicago Rated)	HM=Hard Metric	HR=Heat Removal	2=2' Width [Blank]=1' Width ²	P=Paralux IV	F=Aluminum Flange Trim ³ G=Concealed-T/Slot Grid ⁴ G=Grid/Lay-in (Standard) MZ=Modular Trim	AVX=Air Supply Floating Louver with Directional Air Vane AX=Air Supply Floating Louver X=Blank Side/Floating Louver - Non Air Supply	2024=20" Width x 24" Length 2048=20" Width x 48" Length	1=1 Lamp ⁵ 2=2 Lamps 3=3 Lamps ¹³ 4=4 Lamps ⁶	28T8=28W T8 (48") 32=32W T8 (48") BX40=40W Biax (24") ⁷ U15/8=31W T8 (24") U6T8=32W T8 (24") ^{7,8}
Louver Color	Cell Configuration		Louver Finish	Option - Aluminum Flange Trim ³		Voltage ⁹	Options		
S=Silver W=White	16=1 Row of 6, 6 Cells (1' x 4') 18=1 Row of 8, 8 Cells (1' x 4') 23=2 Rows of 3, 6 Cell (2' x 2', 20" x 24") 26=2 Rows of 6, 12 Cell (1' x 4', 20" x 48", 2' x 4') 28=2 Rows of 8, 16 Cell (1' x 4', 2' x 4') 29=2 Rows of 9, 18 Cell (1' x 4') 33=3 Rows of 3, 9 Cell (2' x 2', 20" x 24") 34=3 Rows of 4, 12 Cell (2' x 2', 20" x 24") 36=3 Rows of 6, 18 Cell (2' x 4', 20" x 48") 38=3 Rows of 8, 24 Cell (2' x 4', 20" x 48") 39=3 Rows of 9, 27 Cell (2' x 4', 20" x 48") 44=4 Rows of 4, 16 Cell (2' x 2') 46=4 Rows of 6, 24 Cell (2' x 4', 20" x 48") 48=4 Rows of 8, 32 Cell (2' x 4', 20" x 48")		I=Specular/Haze (Low Iridescent) Standard MI=Specular/Mirrored (Low Iridescent) P=Painted	[Blank]=SW (Single White) EN=End of Row, Natural Finish EW=End of Row, White Finish RN=In Row, Natural Finish RW=In Row, White Finish SN=Single, Natural Finish		120V=120 Volt 277V=277 Volt 347V=347 Volt UNV=Universal Voltage 120-277 ¹⁰	EL=Emergency Installed (Must Specify Battery Pack, See Options) Flex=Flex Installed (Reference Flex Ordering Information) GL=Single Element Fuse GM=Double Element Fuse Lamps=Lamps Installed (Refer to Lamp Ordering Options) WTR=White Reveal Lamps Installed [Blank]=No Lamps Installed L8835=T8 Lamp, 28W and 32W, 3500K L8835HL=T8 Lamp, 32W 3500K, 3100 Lumens L8841=T8 Lamp, 28W and 32W, 4100K L8841HL=T8 Lamp, 32W 4100K, 3100 Lumens		
Ballast Type									
EB5_=T5 Biax Electronic Instant Start. Total Harmonic Distortion < 20%. ¹¹ EB8_=T8 Electronic Start. Total Harmonic Distortion < 10%. EB8_/PLUS=T8 Electronic Start. Total Harmonic Distortion < 10%. High Ballast Factor > 1.15 ER5_=T5 Biax Electronic Program Rapid Start. Total Harmonic Distortion < 10%. ¹¹ ER8_=T8 Electronic Program Rapid Start. Total Harmonic Distortion < 10%. TEB5_=T5 Biax Electronic Instant Start. Total Harmonic Distortion < 10%. ¹¹					High Performance T8 Ballasts HB8_=T8 Electronic Instant Start. Total Harmonic Distortion < 10%. Standard Ballast Factor .86 - .88 HB8_H=T8 Electronic Instant Start. Total Harmonic Distortion < 10%. High Ballast Factor 1.15 - 1.20 HB8_L=T8 Electronic Instant Start. Total Harmonic Distortion < 10%. Low Ballast Factor .77 - .82 HB8_N=T8 Electronic Instant Start. Total Harmonic Distortion < 10%. Normal Ballast Factor 1.0 HR8_=T8 Electronic Program Rapid Start. Total Harmonic Distortion < 10%. Standard Ballast Factor .86 - .88 HR8_DIM=T8 Electronic Program Rapid Start. Total Harmonic Distortion < 10%. Step Dimming. Ballast Factor .88 HR8_H=T8 Electronic Program Rapid Start. Total Harmonic Distortion < 10%. High Ballast Factor 1.15 - 1.20 HR8_L=T8 Electronic Program Rapid Start. Total Harmonic Distortion < 10%. Low Ballast Factor .71 - .79				
Number of Ballast	Options			Packaging	Accessories (Order Separately)				
1=1 Ballast 2=2 Ballasts 3=3 Ballasts (2' x 4' Only)	PAF=Painted After Fabrication REP=Riveted End Plates RIF1=Radio Interference Suppressor			PAL=Job Pack, out of carton PALC=Job Pack, in carton U=Unit Pack	EQ-CLIP-U=T-BAR Safety Earthquake Clips ¹²				

NOTES: 1. Integral End Plate Grid Lock feature not available in Heat Removal. 2. For 20" width, must specify 2024 or 2048 in ordering logic. 3. Specify row configuration, type in catalog number when ordering complete fixtures. 4. Louver is recessed by 5/16" in Concealed T or Slot Grid T. 5. 1' x 4' only. 6. 2' x 4' and 20" x 48" only. 7. 2' x 2' only. 8. 2 lamps only. 9. Products also available in non-US voltage and frequencies for international markets. 10. Not available when specifying emergencies, voltage must be specified. 11. Not available in UNV voltage. Must specify voltage. 12. An EQ Grid Clip is recommended for all 9/16" ceiling systems. Four required per fixture. 13. Standard off-center ballast on 3-lamp fixtures.

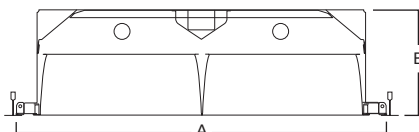

NOMINAL SIZE	A	B
1' x 4'	11-3/4" (298mm)	7-5/8" (194mm)
2' x 2'	23-3/4" (603mm)	6-3/4" (172mm)
2' x 4'	23-3/4" (603mm)	6-3/4" (172mm)
20" x 24"	19-3/4" (502mm)	6-5/8" (168mm)
20" x 48"	19-3/4" (502mm)	6-5/8" (168mm)

PRODUCT INFORMATION FOR PARALUX IV

Housing Size	Louver Cell Configuration*	Number of Cells
1' x 4'	16, 18, 26, 28, 29	6, 8, 12, 16
2' x 2'	23, 33, 34, 44	6, 9, 12, 16
20" x 24"	23, 33, 34	6, 9, 12
20" x 48"	26, 36, 38, 39, 46, 48	12, 18, 24, 27, 24, 32
2' x 4'	26, 28, 36, 38, 39, 46, 48	12, 16, 18, 24, 27, 24, 32

*Example: 36= 3 rows of 6 (18 cells)

PARALUX V RECESSED AIR SUPPLY PRECISION CUT-OFF TROFFER



FEATURES

- Provided with CEE-listed energy-saving ballasts
- Computer-designed, precision-cell parabolic louver
- Louver designed to eliminate glare and control high-angle brightness
- Low-iridescent louver minimizes reflected glare or color
- Die-formed, deep para-contoured body with stiffeners for rigidity
- Efficient air-handling options with or without air control vanes
- Positive cam latch, safety lock T-hinges allow hinging on either side
- Floating louver with black reveal
- Four auxiliary fixture-end suspension points provided

DIMENSIONS

1' x 2', 1' x 4', 2' x 2', 2' x 4', 20" x 24", 20" x 48"

2P5GAX SERIES

Compliances may not apply to all product configurations. Please consult the product spec sheet for compliance details.

COMPLIANCES: UL/cUL Listed, UL/cUL Listed - Damp Location, City of Chicago Approved, NOM Certified



ORDERING INFORMATION

SAMPLE NUMBER: 2P5GAVX-332S39MI-UNV-EB81-U

Rating	Hard Metric	Heat Removal ¹	Width	Series	Trim Type	Air Supply	20" Width	Number of Lamps (Not Included)
[Blank]=Standard ATW-SW4 =Air-Tight Wire Way (Chicago Rated)	HM =Hard Metric	HR =Heat Removal	2-2' Width [Blank]=1' Width ²	P5 =5" Parallax Louver	F =Aluminum Flange Trim ³ G =Concealed-T/Slot Grid ⁴ G =Grid/Lay-in (Standard) MZ =Modular Trim	AVX =Air Supply Floating Louver with Directional Air Vane AX =Air Supply Floating Louver X =Blank Side/Floating Louver - Non Air Supply	2024 =20" Width x 24" Length	1=1 Lamp ⁵ 2=2 Lamps 3=3 Lamps ^{6, 13}
Wattage	Louver Color	Cell Configuration		Louver Finish	Option - Aluminum Flange Trim ³	Voltage ⁹	Options	
28T8 =28W T8 (48") 32 =32W T8 (48") BX40 =40W Biax (24") ⁷ U15/8 =31W T8 (24") ⁸	S =Silver	14=1 Row of 4, 4 Cell (1' x 2') 19=1 Row of 9, 9 Cells (1' x 4') 24=2 Rows of 4, 8 Cell (2' x 2') 24=2 Rows of 4, 8 Cell (20 x 24) 29=2 Rows of 9, 18 Cell (2' x 4') 29=2 Rows of 9, 18 Cell (20 x 48) 34=3 Rows of 4, 12 Cell (2' x 2', 2024) 39=3 Rows of 9, 27 Cell (2' x 4')		MI =Specular/Mirrored (Low Iridescent) VDT =VDT Soft Semi-Specular/Haze	[Blank] =SW (Single White) EN =End of Row, Natural Finish EW =End of Row, White Finish RN =In Row, Natural Finish RW =In Row, White Finish SN =Single, Natural Finish	120V =120 Volt 277V =277 Volt 347V =347 Volt UNV =Universal Voltage 120-277 ¹⁰	EL =Emergency Installed (Must Specify Battery Pack, See Options) Flex =Flex Installed (Reference Flex Ordering Information) GL =Single Element Fuse GM =Double Element Fuse Lamps =Lamps Installed (Refer to Lamp Ordering Options) WTR =White Reveal	

Ballast Type

EB5=T5 Biax Electronic Instant Start. Total Harmonic Distortion < 20%.¹¹
ER5=T5 Biax Electronic Program Rapid Start. Total Harmonic Distortion < 10%.¹¹
TEB5=T5 Biax Electronic Instant Start. Total Harmonic Distortion < 10%.¹¹
EB8=T8 Electronic Start. Total Harmonic Distortion < 10%.
EB8 /PLUS=T8 Electronic Start. Total Harmonic Distortion < 10%. High Ballast Factor > 1.15
ER8=T8 Electronic Program Rapid Start. Total Harmonic Distortion < 10%.

High Performance T8 Ballasts

HB8=T8 Electronic Instant Start. Total Harmonic Distortion < 10%. Standard Ballast Factor .86 - .88
HB8 H=T8 Electronic Instant Start. Total Harmonic Distortion < 10%. High Ballast Factor 1.15 - 1.20
HB8 L=T8 Electronic Instant Start. Total Harmonic Distortion < 10%. Low Ballast Factor .77 - .82
HB8 N=T8 Electronic Instant Start. Total Harmonic Distortion < 10%. Normal Ballast Factor 1.0
HR8=T8 Electronic Program Rapid Start. Total Harmonic Distortion < 10%. Standard Ballast Factor .86 - .88
HR8 DIM=T8 Electronic Program Rapid Start. Total Harmonic Distortion < 10%. Step Dimming. Ballast Factor .88
HR8 H=T8 Electronic Program Rapid Start. Total Harmonic Distortion < 10%. High Ballast Factor 1.15 - 1.20
HR8 L=T8 Electronic Program Rapid Start. Total Harmonic Distortion < 10%. Low Ballast Factor .71 - .79

Number of Ballasts	Options	Packaging	Accessories (Order Separately)
1=1 Ballast 2=2 Ballasts 3=3 Ballasts (2' x 4' Only)	PAF =Painted After Fabrication REP =Riveted End Plates RIF1 =Radio Interference Suppressor	PAL =Job Pack, out of carton PALC =Job Pack, in carton U =Unit Pack	EQ-CLIP-U =T-BAR Safety Earthquake Clips ¹²

NOTES: 1. Integral End Plate Grid Lock feature not available in Heat Removal. 2. For 20" width, must specify 2024 or 2048 in ordering logic. 3. Specify row configuration, type in catalog number when ordering complete fixtures. 4. Louver is recessed by 5/16" in Concealed T or Slot Grid T. 5. 1' x 4' only. 6. 2' x 4' only. 7. 2 lamps only. 8. 2 lamps only. 9. Products also available in non-US voltage and frequencies for international markets. 10. Not available when specifying emergencies, voltage must be specified. 11. Not available in UNV voltage. Must specify voltage. 12. An EQ Grid Clip is recommended for all 9/16" ceiling systems. Four required per fixture. 13. Standard off-center ballast on 3-lamp fixtures.

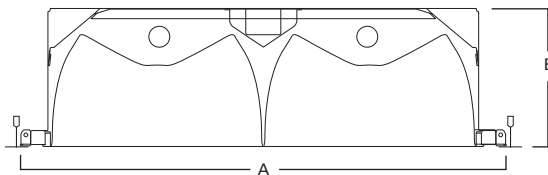

NOMINAL SIZE	A	B
1' x 2'	11-3/4" (298mm)	7" (178mm)
1' x 4'	11-3/4" (298mm)	7" (178mm)
2' x 2'	23-3/4" (603mm)	6-3/4" (172mm)
2' x 4'	23-3/4" (603mm)	6-3/4" (172mm)
20" x 24"	19-3/4" (502mm)	6-1/8" (156mm)
20" x 48"	19-3/4" (502mm)	7-3/8" (187mm)

PRODUCT INFORMATION FOR PARALUX V

Housing Size	Lamp Quantity	Louver Cell Configuration*	Number of Cells
1' x 2'	1 or 2	14	4
1' x 4'	1 or 2	19	9
2' x 2'	2	24	8
	3	34	12
20" x 24"	2	24	8
20" x 48"	2	29	18
2' x 4'	2	29	18
	3	39	27

*Example: 39= 3 rows of 9 (27 cells)

Specifications and dimensions subject to change without notice. Consult your Cooper Lighting Representative or visit www.cooperlighting.com for available options, accessories and ordering information.

FEATURES

- Excellent low-brightness luminaire for accent lighting
- Die-formed nominal 7" deep steel-construction housing
- Ballasts are CBM/ETL Class P and positively secured by mounting bolts
- 3" nominal precision-cell, parabolic louver
- High shielding and low brightness louver for optimal lighting
- Fits into nominal 12" square opening
- Heavy-duty, adjustable mounting brackets

DIMENSIONS

1' x 1'

Compliances may not apply to all product configurations. Please consult the product spec sheet for compliance details.

COMPLIANCES: UL/cUL Listed, UL/cUL Listed - Damp Location



P3 SERIES

ORDERING INFORMATION

SAMPLE NUMBER: P3-2BX18S22I-RS-UNV-EB81-U

Series	Number of Lamps (Not Included)	Wattage	Louver Color	Cell Configuration	Louver Finish	Ballast Start Type
P3=Paralux III	2=2 Lamps 3=3 Lamps	BX18 =18W Biax RS OC16 =16W T8	S =Silver	22 =2 Rows of 2, 4 Cell (1' x 1') 33 =3 Rows of 3, 9 Cell (2' x 2')	I =Semi-Specular/Haze (Low Iridescent) Standard MI =Specular/Mirrored (Low Iridescent)	RS =Rapid Start
Voltage ¹	Options	Ballast Type	Number of Ballasts	Options	Packaging	
120V =120 Volt 277V =277 Volt 347V =347 Volt UNV =Universal Voltage 120-277	GL =Single Element Fuse GM =Double Element Fuse	EB8 =T8 Electronic Instant Start. Total Harmonic Distortion < 10%	1=1 Ballast 2=2 Ballasts	NDF =Natural Aluminum Trim REP =Riveted End Plates RIF1 =Radio Interference Suppressor RLS =Rotor Lock Socket (T8 Lamps Only)	U =Unit Pack	

NOTES: 1. Products also available in non-US voltage and frequencies for international markets.

1' x 1'

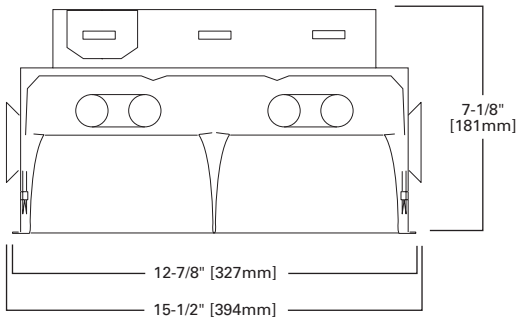

PARALUX III, IV, V SURFACE PARABOLIC



FEATURES

- Provided with CEE-listed, energy-saving ballasts
- Computer-designed, precision-cell parabolic louver
- Die-formed housing
- Full-seam welded corners
- Louvers available in white or silver semi-specular finish
- System complies with RP-1 and meets today's lighting needs
- Self-locking, spring-loaded cam latch with positive latching mechanism

DIMENSIONS

1' x 4', 2' x 2', 2' x 4'

Compliances may not apply to all product configurations. Please consult the product spec sheet for compliance details.

COMPLIANCES: UL/cUL Listed, UL/cUL Listed - Damp Location

PMX SERIES



ORDERING INFORMATION^A

SAMPLE NUMBER: 2EP3MX-332S36I-UNV-EB81-U

Width	Paralux Louver	Louwer Depth	Surface Mount	Number of Lamps (Not Included)	Wattage (Length)	Louwer Color
2=2' Width [Blank]=1' Width	EP=Paralux Louver (III) ¹ P=Paralux Louver	3=Paralux III 5=Paralux V [Blank]=Paralux IV	MX=Surface Mount/ Floating Door	1=1 Lamp ² 2=2 Lamps 3=3 Lamps 4=4 Lamps	17=17W T8 (24") 32=32W T8 (48") BX40=40W Biax T5 (24") ³ U1-5/8=31W T8 (24") U6T8=31W T8 (24") ^{4,3}	S=Silver W=White
Cell Configuration	Louwer Finish	Voltage ⁵		Options		
18=1 Row of 8, 8 Cell (1' x 4') 26=2 Rows of 6, 12 Cell 28=2 Rows of 8, 16 Cell 33=3 Rows of 3, 9 Cell (2' x 2') 34=3 Rows of 4, 12 Cell (2' x 2') 36=3 Rows of 6, 18 Cell 39=3 Row of 9, 27 Cell 44=4 Rows of 4, 16 Cell (2' x 2') 48=4 Rows of 8, 32 Cell (2'x4')	I=Semi-Specular/Haze (Low Iridescent) Standard MI=Specular/Mirrored (Low Iridescent) P=Painted	120V=120 Volt 277V=277 Volt 347V=347 Volt UNV=Universal Voltage 120-277 ⁶		EL=Emergency Installed (Must Specify Battery Pack, See Options) Flex=Flex Installed (Reference Flex Ordering Information) GL=Single Element Fuse GM=Double Element Fuse		
Ballast Type				Number of Ballasts	Options	Packaging
Biax Ballasts EB5=T5 Biax Electronic Instant Start. Total Harmonic Distortion < 20%. ⁷ TEB5=T5 Biax Electronic Instant Start. Total Harmonic Distortion < 10%. ⁷ T8 Ballasts EB8=T8 Electronic Start. Total Harmonic Distortion < 10%. EB8 /PLUS=T8 Electronic Start. Total Harmonic Distortion < 10%. High Ballast Factor > 1.15. ER8=T8 Electronic Program Rapid Start. Total Harmonic Distortion < 10%. High Performance T8 Ballasts HB8=T8 Electronic Instant Start. Total Harmonic Distortion < 10%. Standard Ballast Factor .86-.88 HB8_H=T8 Electronic Instant Start. Total Harmonic Distortion < 10%. High Ballast Factor 1.15-1.20 HB8_L=T8 Electronic Instant Start. Total Harmonic Distortion < 10%. Low Ballast Factor .77-.82 HB8_N=T8 Electronic Instant Start. Total Harmonic Distortion < 10%. Normal Ballast Factor 1.0 HR8=T8 Electronic Program Rapid Start. Total Harmonic Distortion < 10%. Standard Ballast Factor .86-.88 HR8_DIM=T8 Electronic Program Rapid Start. Total Harmonic Distortion < 10%. Step Dimming. Ballast Factor .88 HR8_H=T8 Electronic Program Rapid Start. Total Harmonic Distortion < 10%. High Ballast Factor 1.15-1.20 HR8_L=T8 Electronic Program Rapid Start. Total Harmonic Distortion < 10%. Low Ballast Factor .71-.79				1=1 Ballast 2=2 Ballasts 3=3 Ballasts ¹	EKO=7/8" KOs in End of Fixture Housing ⁶ PI/CPI=Plug-In Option SMB=Side Mounted Ballast For Stem Applications WTR=White Reveal	PAL=Job Pack Out of Carton PALC=Job Pack, in carton U=Unit Pack

NOTES: 1. 2' x 4' only. 2. 1' x 4' only. 3. 2' x 2' only. 4. 2 lamps only. 5. Products also available in non-US voltage and frequencies for international markets. 6. Not available when specifying emergencies, voltage must be specified. 7. Must specify voltage.

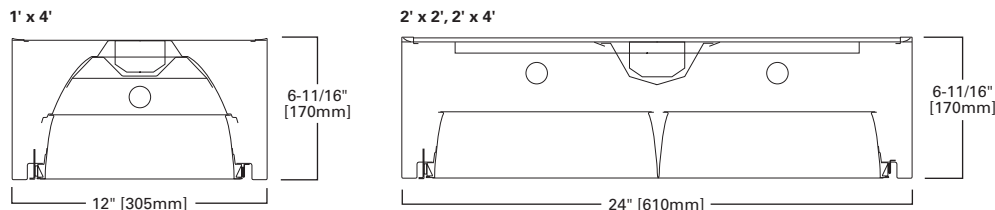

Specifications and dimensions subject to change without notice. Consult your Cooper Lighting Representative or visit www.cooperlighting.com for available options, accessories and ordering information.

RESIDENTIAL T8 SHOP LIGHT



SHOP LIGHT SERIES

FEATURES

- Uses two fluorescent lamps (not included)
- Cold rolled steel with baked white enamel paint
- Cord and plug installed
- Chain included (for chain hanging applications only)
- Easily installed
- Suitable for damp locations
- UL/cUL listed

DIMENSIONS

4'

Compliances may not apply to all product configurations. Please consult the product spec sheet for compliance details.

COMPLIANCES: UL/cUL Listed - Damp Location, ENERGY STAR Qualified



ORDERING INFORMATION

Catalog Number	Description	Lamp	Shipping Weight
SL232R - Utility Shop Light	2 Lamp 48" Shop Light <ul style="list-style-type: none"> • Electronic Ballast, Start Temp 0°F • 4" Reflector • 6 Foot Cord • Pull Chain • (2) S-hook 12" Chains • Pre-assembled 	(2) 32W T8 Lamps (Not Included)	6.42 lbs.
SLNR232R - Medium-grade Shop Light	2 Lamp 48" Shop Light <ul style="list-style-type: none"> • Electronic Ballast, Start Temp 0°F • 7" Reflector • 6 Foot Cord • Pull Chain • (2) S-hook 12" Chains • Pre-assembled 	(2) 32W T8 Lamps (Not Included)	7.9 lbs.
SLWR232R - Heavy-duty Shop Light	2 Lamp 48" Shop Light <ul style="list-style-type: none"> • Electronic Ballast, Start Temp 0°F • 12" Reflector • 6 Foot Cord • Pull Chain • (2) S-hook 12" Chains • Some assembly required 	(2) 32W T8 Lamps (Not Included)	12 lbs.

UTILITY SHOP LIGHT - SL232R

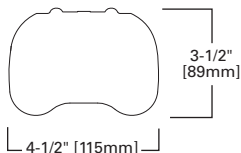

MEDIUM-GRADE SHOP LIGHT - SLNR232R

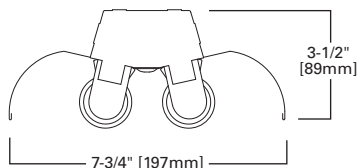

HEAVY-DUTY SHOP LIGHT - SLWR232R

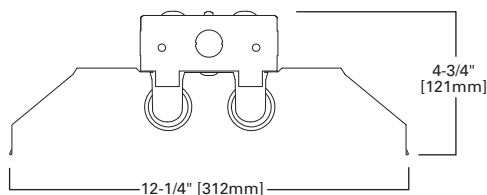

SERIES OPTIONS



SL232R



SLNR232R



SLWR232R

Specifications and dimensions subject to change without notice. Consult your Cooper Lighting Representative or visit www.cooperlighting.com for available options, accessories and ordering information.

CIRCLINE ROUND, SQUARE



FEATURES

- Opal white acrylic diffuser
- Baked white enamel finish with reflective base
- Uses one or two circline lamps (included)
- Diffuser easily removed for lamp replacement or service
- Square or saucer profiles

DIMENSIONS

11', 14', 19'

Compliances may not apply to all product configurations. Please consult the product spec sheet for compliance details.

COMPLIANCES: UL Listed - Damp LocationCIRCLINE
DECORATIVE
SERIES

ORDERING INFORMATION

Catalog Number	Description	Lamp	Shipping Weight
DECORATIVE			
7413	Round Acrylic Saucer, 11" Diameter White Circline	11" Diameter, Single 22W Lamp	4 lbs. (1.8kg)
7013	Square Acrylic Puff, 12" Diameter White Circline	12" Diameter, Single 22W Lamp	5 lbs. (2.3kg)
7033	Square Acrylic Puff, 14" Diameter White Circline	14" Diameter, (1) 22W and (1) 32W Lamp	7 lbs. (3.2kg)

ROUND SERIES

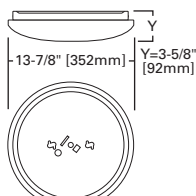
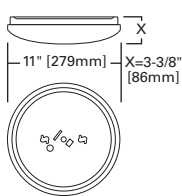

SQUARE SERIES

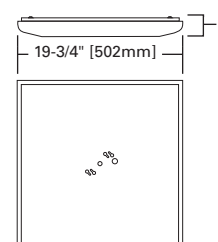
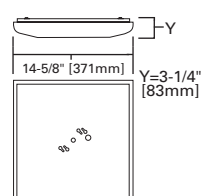
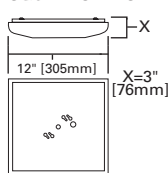

SERIES OPTIONS



Round Acrylic Saucer

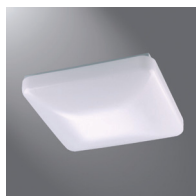

Square Acrylic Puff

CIRCLINE UTILITY



FEATURES

- Uses one or two circline lamps (not included)
- Bare lamp
- Lamps secured by spring lamp clips
- Chrome-plate finish

DIMENSIONS

8"

Compliances may not apply to all product configurations. Please consult the product spec sheet for compliance details.

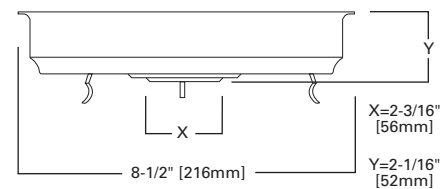
COMPLIANCES: UL/cUL Listed - Damp LocationCIRCLINE UTILITY
SERIES

ORDERING INFORMATION

Catalog Number	Description	Lamp	Shipping Wt.
UTILITY			
7112	Bare Lamp, 8" Diameter Chrome Circline	8" Diameter, Single 22W Lamp	3 lbs. (1.4kg)

Specifications and dimensions subject to change without notice. Consult your Cooper Lighting Representative or visit www.cooperlighting.com for available options, accessories and ordering information.

FEATURES

- Opal white acrylic diffuser with solid wood trims
- Snap-flush mounting for easy installation
- Heavy-gauge steel housing with baked white enamel finish
- Uses two or four fluorescent lamps (not included)

DIMENSIONS

15" x 48", 24" x 24"

Compliances may not apply to all product configurations. Please consult the product spec sheet for compliance details.

COMPLIANCES: UL Listed - Damp Location, ENERGY STAR Qualified**DECORATIVE WOOD TRIMS****DECORATIVE SERIES****ORDERING INFORMATION**

Catalog Number	Product Description	Size	Lamp	Shipping Weight
DT432WR	Wood Trim, 15" x 48", (4) T8/32W Lamps, 120V Resi Ballast, White Finish	15" x 48"	4 - F32T8	27 lbs. (12.2 kg)
DT432OR	Wood Trim, 15" x 48", (4) T8/32W Lamps, 120V Resi Ballast, Natural Oak Finish	15" x 48"	4 - F32T8	27 lbs. (12.2 kg)
DT432UNR	Wood Trim, 15" x 48", (4) T8/32W Lamps, 120V Resi Ballast, Unfinished Finish	15" x 48"	4 - F32T8	27 lbs. (12.2 kg)
DT2U632WR	Wood Trim, 24" x 24", (2) U6T8/32W Lamps, 120V Resi Ballast, White Finish	24" x 24"	2 - FU32T8	20 lbs. (9 kg)
DT2U632OR	Wood Trim, 24" x 24", (2) U6/32W Lamps, 120V Resi Ballast, Natural Oak Finish	24" x 24"	2 - FU32T8	20 lbs. (9 kg)
DT2U632UNR	Wood Trim, 24" x 24", (2) U6T8/32W Lamps, 120V Resi Ballast, Unfinished Finish	24" x 24"	2 - FU32T8	20 lbs. (9 kg)

FINISH OPTIONS

White Finish



Natural Oak Finish



Unfinished Finish

Specifications and dimensions subject to change without notice. Consult your Cooper Lighting Representative or visit www.cooperlighting.com for available options, accessories and ordering information.

CIRCLINE DECORATIVE

**FEATURES**

- Unique decorative trims with matte white lenses
- Residential electronic ballast
- Fully assembled and ready to install (mounting hardware included)
- Uses one 22W or one 32W circline lamp (included)

DIMENSIONS

14"

Compliances may not apply to all product configurations. Please consult the product spec sheet for compliance details.

COMPLIANCES: UL Listed - Damp LocationSMALL CIRCLINE
DECORATIVE
SERIES**ORDERING INFORMATION**

Catalog Number	Description	Shipping Weight
Amber Mission Square 7508	14", 2-Lamp 22/32W, Mission Trim w/Classic Amber Stain	7 lbs. (3.2kg)
Satin Nickel Round 7235-REB1	14", 2-Lamp 26W Compact Fluorescent, Contemporary Satin Nickle Trim	7 lbs. (3.2kg)

TRIM OPTIONS

Satin Nickel Round



Amber Mission Square

Specifications and dimensions subject to change without notice. Consult your Cooper Lighting Representative or visit www.cooperlighting.com for available options, accessories and ordering information.

WALL BRACKET AND WALL CLOUD



WALL BRACKET, UNDERCABINET SERIES

FEATURES

- Uses one or two fluorescent lamps
- Contemporary styling
- Die-formed housing
- Baked white enamel finish
- Extruded, smooth opal, white acrylic refractor
- 180° uniform light distribution
- Decorative opaque injection molded white end plates
- Easy wiring access
- Vertical-wall or horizontal-ceiling-mount applications

DIMENSIONS

2', 3', 4'

Compliances may not apply to all product configurations. Please consult the product spec sheet for compliance details.

COMPLIANCES: UL/cUL Listed - Damp Location



ORDERING INFORMATION

Catalog Number ^{1, 2}	Description	Shipping Weight
(White Ends / 1 Light)		
6212	1 lamp 24", 20W T12	7 lbs. (3.2kg)
6313	1 lamp 36", 30W T12	9 lbs. (4.1kg)
6414	1 lamp 48", 40W T12	12 lbs. (5.4kg)
(White Ends / 2 Light)		
6222	2 lamp 24", 20W T12	7 lbs. (3.2kg)
6424	2 lamp 48", 40W T12	12 lbs. (5.4kg)
(Wall Cloud)		
6232	2 lamp 24", 20W T12	8 lbs. (3.6kg)
6434	2 lamp 48", 40W T12	13 lbs. (5.9kg)
6434E ¹	2 lamp 48", with LE3, 40W T12	13 lbs. (5.9kg)
6434-REB1	2 lamp 48", with LE3, 32W T8	13 lbs. (5.9kg)

NOTES: 1. "E" in catalog number means Electronic Ballast that operates T12 lamps. 2. Commercial Grade Electronic Ballast (EB81) available on a "made to order" basis.

WALL BRACKET SERIES

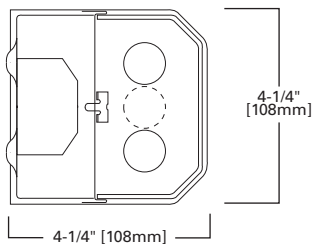

WALL CLOUD SERIES

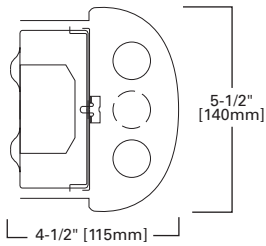

SERIES OPTIONS



Wall Cloud



Wall Bracket

Specifications and dimensions subject to change without notice. Consult your Cooper Lighting Representative or visit www.cooperlighting.com for available options, accessories and ordering information.

SURFACE T8



FEATURES

- Residential application
- High-impact acrylic lens offers superior durability
- 120V residential ballast
- Die-formed housing with high quality paint finish
- Lift-and-shift lens is mechanically retained by end caps
- Lamps not included

DIMENSIONS

2', 4'

Compliances may not apply to all product configurations. Please consult the product spec sheet for compliance details.

COMPLIANCES: UL/cUL Listed - Damp Location, ENERGY STAR Qualified

WP SERIES



ORDERING INFORMATION

SAMPLE NUMBER: WP232R

Series	Number of Lamps (Not Included)	Wattage	Application
WP=Surface Wrap	2=2 Lamps	17=17W T8 (24") 32=32W T8 (48")	R=Residential (120V)

2', 4'

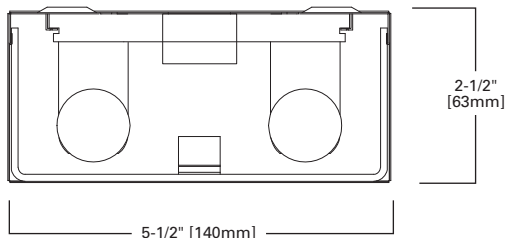

SURFACE WRAPAROUND



WRAPAROUND
OAK TRIM SERIES

FEATURES

- White acrylic diffuser with low brightness
- Low-profile design with light oak wood ends
- Lift-and-shift refractor offers easy re-lamping
- Uses two or four fluorescent lamps (not included)

DIMENSIONS

2', 4'

Compliances may not apply to all product configurations. Please consult the product spec sheet for compliance details.

COMPLIANCES: UL/cUL Listed - Damp Location



ORDERING INFORMATION

Catalog Number	Description	Shipping Weight
W2324-REB1	2 lamp, 4', 32W T8, Light Oak Wood Ends	13 lbs. (5.9kg)
W2344-REB1	4 lamp, 4', 32W T8, Light Oak Wood Ends	20 lbs. (9kg)

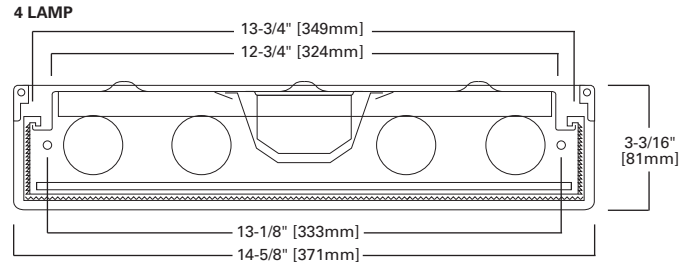
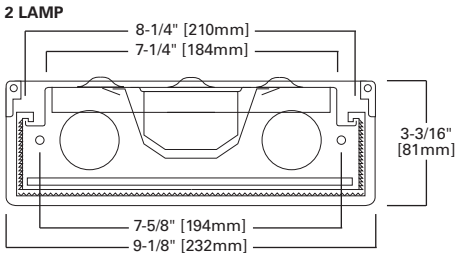

SURFACE T8



FEATURES

- Acrylic lens formulated to protect against lens breakage
- Tuff' R' Puff commercial-grade acrylic lens
- 120V instant-start residential or commercial ballast
- Housing manufactured with die-formed, cold-rolled steel
- Snap-fit for ease of service and re-lamping
- Ideal choice for most residential and commercial applications
- Lamps not included

DIMENSIONS

1' x 4', 1-1/2' x 4'

Compliances may not apply to all product configurations. Please consult the product spec sheet for compliance details.

COMPLIANCES: UL/cUL Listed - Damp Location, ENERGY STAR Qualified

WSC SERIES



ORDERING INFORMATION

SAMPLE NUMBER: WSC232R

Series	Number of Lamps (Not Included)	Wattage (Length)	Application
WSC=Softside Cloud	2=2 Lamps 4=4 Lamps	32=32W T8 (48") U6T8=32W T8 (24") ¹	R=Residential

NOTES: 1. Two lamp only.

1' x 4', 2 LAMP

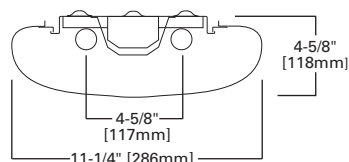

1-1/2' x 4', 4 LAMP

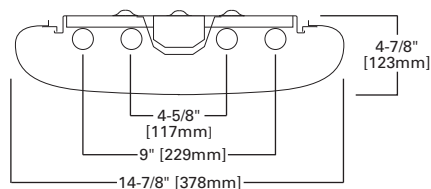

2' x 2', 2 U-LAMPS

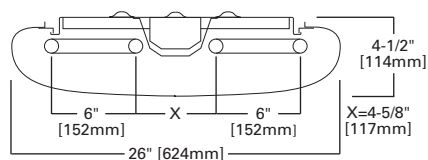

ALTERNATE PRODUCTS



1' x 4'

Specifications and dimensions subject to change without notice. Consult your Cooper Lighting Representative or visit www.cooperlighting.com for available options, accessories and ordering information.

FEATURES

- Energy-saving applications where fixture removal is cost-prohibitive
- Convert standard 4' and 8' T8 or T12 industrial or strips
- Fits industrial or strip channels from 4" to 5-5/8" wide
- Two optical distributions, specular or high-performance white
- Twist-lock sockets; 20-gauge socket tracks; mounting hardware provided
- Bulk-packed kits for easier handling
- Order with or without ballasts
- Pre-wiring options to speed installation
- Quick, safe and efficient installation and maintenance

DIMENSIONS

4', 8'

Compliances may not apply to all product configurations. Please consult the product spec sheet for compliance details.

COMPLIANCES: UL Classified



ORDERING INFORMATION

SAMPLE NUMBER: 8ECS-232-M-NB-EB8-U

Width	Series	Number of Lamps (Not Included)	Lamp Type	Optics	Voltage ¹
8=8' [Blank]=4'	ECS=Ecofit Strip	1=1 Lamp 2=2 Lamps	32=32W T8 Lamps (48") 54=54W T5HO Lamp (48")	BC=Ballast/Channel Cover (Covers from 4" to 5-1/4" Wide) M=Medium (Specular Aluminum) W=Wide (White)	NB=No Ballast UNV=Universal Voltage Ballast Included
Ballast - Socket Type ¹				Number of Ballasts	Order Quantity - Packaging
T5 Ballasts EBT_=T5 or T5HO Electronic Program Start. Total Harmonic Distortion < 10%. Standard Ballast Factor =1.0 T8 Ballasts EB8_=T8 Electronic Instant Start. Total Harmonic Distortion < 10%. EB8_/L=T8 Electronic Instant Start with < 0.80 Ballast Factor. EB8_/PLUS=T8 Electronic Start. Total Harmonic Distortion < 10%. High Ballast Factor > 1.15 ER8_=T8 Electronic Program Rapid Start. Total Harmonic Distortion < 10%. ²				1=1 Ballast 2=2 Ballasts [Blank]=No Ballast (NB Options Only)	U=Unit Qty (Packaging will be Determined by Factory)

NOTES: 1. When using Ecofit Kits without ballasts, indicate ballast type and system to designate shunted or unshunted sockets. Ex: ECS-23 2-M-EB81-10B. 2. Recommended when using retrofits together with motion sensor, daylight harvesting or similar controls.



**INDUSTRIAL
RETROFIT KIT
(ECS)**

4' or 8', 1 or 2 LAMPS

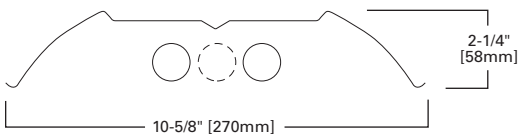

INSTALLATION, 2 LAMP

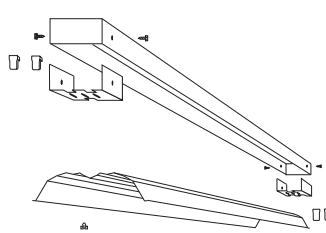

STRIP KIT (WITH REFLECTOR)

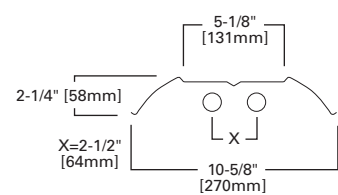

STRIP KIT (NO REFLECTOR)

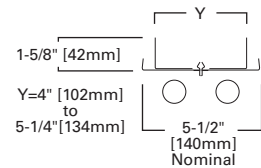

RETROFIT KITS - COMMERCIAL TROFFER OR PARABOLIC

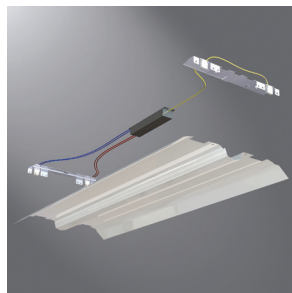

FEATURES

- Save 50% or more in energy over existing 4-lamp T12 luminaires
- Fast and cost-effective solution for saving time and money
- Reuses existing housing and shielding for a below-the-plenum install
- Ready-Set™ captive screws for quick, easy installation
- Installs in less than 10 minutes
- Pre-wired assembly with or without CEE-listed ballast
- One-piece, tool-less reflector eliminates the need for parts bag
- Fits troffers or parabolics as shallow as 3-1/4"
- Optional white optics 97% reflective finish

DIMENSIONS

2' x 2', 2' x 4'

COMMERCIAL RETROFIT KIT (ART)

Compliances may not apply to all product configurations. Please consult the product spec sheet for compliance details.

COMPLIANCES: UL Classified



ORDERING INFORMATION

SAMPLE NUMBER: ART-2CRK-232-W-NB-EB8-10B

Product	Width	Series	Number of Lamps (Not Included)	Wattage (Length)	Distribution
ART=Advanced Retrofit Technology	2=24" Wide	CRK=Commercial Retrofit Kit	2=2 Lamps 3=3 Lamps	14T5=14W T5 (24") 17=17W T8 (24") 24T5=24W T5HO (24") 28T5=28W T5 (48") 32=32W T8 (48") U1-5/8=31W 1-5/8" U-Lamp (24") ¹	W=White (Medium) WO=White Optics (High Reflectance)
Voltage ²	Ballast Type	Number of Ballasts		Packaging	
NB=No Ballast UNV=Universal Voltage ³	<p>T5 Ballasts</p> <p>EBT_=T5 or T5HO Electronic Program Rapid Start. Total Harmonic Distortion < 10%. Standard Ballast Factor=1.0⁴</p> <p>Ballast/Factor Type (T5)</p> <p>EBT_H=T5 Electronic Program Rapid Start. Total Harmonic Distortion < 10%. High Ballast Factor=1.15⁵</p> <p>EBT_N=T5 Electronic Program Rapid Start. Total Harmonic Distortion < 10%. Normal Ballast Factor=.90⁶</p> <p>T8 Ballasts</p> <p>EB8_=T8 Electronic Start. Total Harmonic Distortion < 10%.</p> <p>EB8_/PLUS=T8 Electronic Start. Total Harmonic Distortion < 10%. High Ballast Factor > 1.15</p> <p>ER8_=T8 Electronic Program Rapid Start. Total Harmonic Distortion < 10%.</p> <p>ER8_/PLUS=T8 Electronic Program Rapid Start. Total Harmonic Distortion < 10%. High Ballast Factor > 1.15</p>	1=1 Ballast 2=2 Ballasts ⁴ [Blank]=No Ballast (NB Option Only)	10B=Bulk Pack U=Unit Pack (Consult Factory for Other Packaging Options)		

NOTES: 1. 2 lamp 2' x 2' only. 2. Products also available in non-US voltage and frequencies for international markets. 3. Not available when specifying emergencies, voltage must be specific. 4. 2 ballasts are required when specifying 3 or more 28T5 lamps. 5. 1-Lamp ballast in a High Ballast factor not available. 6. .90 ballast factor available for 2 or 3 14W T5 or 28W T5 lamps only.

COMMERCIAL RETROFIT 2' x 2', 2' x 4'

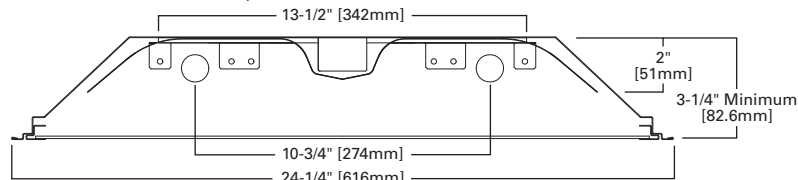

Specifications and dimensions subject to change without notice. Consult your Cooper Lighting Representative or visit www.cooperlighting.com for available options, accessories and ordering information.

FEATURES

- Ideal for commercial, educational and retail merchandising retrofits
- White louver straight-blade cross-members for optimal light efficiency
- Save 50% or more in energy over existing 4-lamp T12 luminaires
- Fits troffers or parabolics as shallow as 3-1/2"
- Pre-assembled and wired to CEE-listed ballast
- Ready-Set™ captive screws for quick, easy installation in 10 minutes
- One-piece, tool-less reflector eliminates the need for parts bag
- Reuse existing housing to lower installation time and removal cost

DIMENSIONS

2' x 2', 2 x 4'

Compliances may not apply to all product configurations. Please consult the product spec sheet for compliance details.

COMPLIANCES: UL Classified

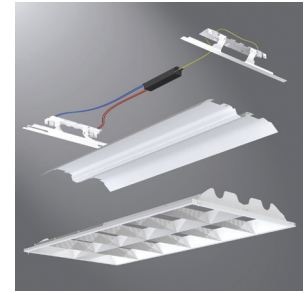

**OPTICAHP
RETROFIT KIT
(ART)**

ORDERING INFORMATION

SAMPLE NUMBER: ART-20P-232-UNV-EB81-10B

Product	Width	Series	Number of Lamps (Not Included)	Wattage (Length)	Distribution	Voltage ²
ART=Advanced Retrofit Technology	2=24" Wide	OP=Optica Retrofit Kit	2=2 Lamps	14T5=14W T5 (24") 17=17W T8 (24") 24T5=24W T5HO (24") 254T5=54W T5HO (48") 28T5=28W T5 (48") 32=32W T8 (48") U1-5/8=31W 1-5/8" U-Lamp (24") ¹	[Blank]=White (Medium) WO=White Optics (High Reflectance)	120V=120 Volt 277V=277 Volt 347V=347 Volt NB=No Ballast UNV=Universal Voltage ³
Emergency Option	Ballast Type				Number of Ballasts	Packaging
EL=Emergency Installed (Consult Factory)	<p>T5 Ballasts EBT_=T5 or T5HO Electronic Program Rapid Start. Total Harmonic Distortion < 10%. Standard Ballast Factor=1.0</p> <p>Ballast/Factor Type (T5) EBT_H=T5 Electronic Program Rapid Start. Total Harmonic Distortion < 10%. High Ballast Factor=1.15⁵ EBT_N=T5 Electronic Program Rapid Start. Total Harmonic Distortion < 10%. Normal Ballast Factor=.90⁶</p> <p>T8 Ballasts EB8_=T8 Electronic Start. Total Harmonic Distortion < 10%. EB8_/PLUS=T8 Electronic Start. Total Harmonic Distortion < 10%. High Ballast Factor > 1.15 ER8_=T8 Electronic Program Rapid Start. Total Harmonic Distortion < 10%.</p> <p>High Performance T8 Ballasts HB8_=T8 Electronic Instant Start. Total Harmonic Distortion < 10%. Standard Ballast Factor .86-.88 HB8_H=T8 Electronic Instant Start. Total Harmonic Distortion < 10%. High Ballast Factor 1.15-1.20 HB8_L=T8 Electronic Instant Start. Total Harmonic Distortion < 10%. Low Ballast Factor .77-.82 HB8_N=T8 Electronic Instant Start. Total Harmonic Distortion < 10%. Normal Ballast Factor 1.0 HR8_DIM=T8 Electronic Program Rapid Start. Total Harmonic Distortion < 10%. Step Dimming. Ballast Factor .88⁴ HR8_H=T8 Electronic Program Rapid Start. Total Harmonic Distortion < 10%. High Ballast Factor 1.15-1.20⁴ HR8_L=T8 Electronic Program Rapid Start. Total Harmonic Distortion < 10%. Low Ballast Factor .71-.79⁴ HR8_T8=T8 Electronic Program Rapid Start. Total Harmonic Distortion < 10%. Standard Ballast Factor .86-.88⁴</p>	1=1 Ballast 2=2 Ballasts [Blank]=No Ballast (NB Option Only)	10B=Bulk Pack U=Unit Pack (Consult Factory for Other Packaging Options)			

NOTES: 1. 2 lamp 2'x2' only. 2. Products also available in non-US voltage and frequencies for international markets. 3. Not available when specifying emergencies, voltage must be specific. 4. Recommended when using retrofits together with motion sensor, daylight harvesting or similar controls. 5. 1-Lamp ballast in a High Ballast factor not available. 6. .90 ballast factor available for 2 or 3 14W T5 or 28W T5 lamps only.

OPTICAHP RETROFIT 2' x 2', 2' x 4'

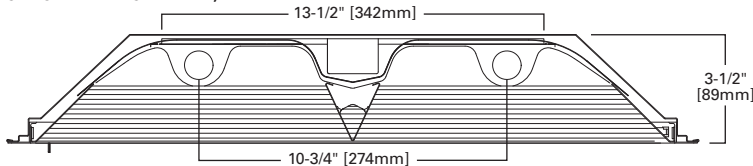

RETROFIT KITS - ARCHITECTURAL



FEATURES

- Ideal for office, government, educational and retail retrofits
- Architectural-inspired center basket or dual-lens design
- Save 50% or more in energy over existing 4-lamp T12 luminaires
- Pre-assembled and wired to CEE-listed ballast
- Ready-Set™ captive screws for quick, easy installation in 10 minutes
- One-piece, tool-less reflector eliminates the need for parts bag
- Fits troffers or parabolics as shallow as 3-1/2" deep
- Reuse existing housing to lower installation time and removal cost

DIMENSIONS

2' x 2', 2' x 4'

Compliances may not apply to all product configurations. Please consult the product spec sheet for compliance details.

COMPLIANCES: UL Classified



ARCDUO, CRUZE
RETROFIT KITS
(ART)

ORDERING INFORMATION

SAMPLE NUMBER: ART-2ARC-232L-UNV-EB81-10B

Product	Width	Series	Number of Lamps (Not Included)	Wattage (Length)	Shielding	Distribution	Voltage ¹
ART=Advanced Retrofit Technology	2=24" Wide	ARC=ArcDuo Retrofit Kit CRZ=Cruze Retrofit Kit	2=2 Lamps	14T5=14W T5 (24") 17=17W T8 (24") 24T5=24W T5HO (24") 28T5=28W T5 (48") 32=32W T8 (48") 54T5=54W T5HO (48")	L=Acrylic Lens Shield (Standard)	[Blank]=White (Medium) WO=White Optics (High Reflectance)	120V=120 Volt 277V=277 Volt 347V=347 Volt NB=No Ballast UNV=Universal Voltage ²
Emergency Option	Ballast Type					Number of Ballasts	Packaging
EL=Emergency Installed (Consult Factory)	<p>T5 Ballasts EBT_T5 or T5HO Electronic Program Rapid Start. Total Harmonic Distortion < 10%. Standard Ballast Factor=1.0</p> <p>Ballast/Factor Type (T5) EBT_H=T5 Electronic Program Rapid Start. Total Harmonic Distortion < 10%. High Ballast Factor=1.15⁴ EBT_N=T5 Electronic Program Rapid Start. Total Harmonic Distortion < 10%. Normal Ballast Factor=.90⁵</p> <p>T8 Ballasts EB8_T8 Electronic Start. Total Harmonic Distortion < 10%. EB8_PLUS=T8 Electronic Start. Total Harmonic Distortion < 10%. High Ballast Factor > 1.15 ER8_T8 Electronic Program Rapid Start. Total Harmonic Distortion < 10%.</p> <p>High Performance T8 Ballasts HB8_T8 Electronic Instant Start. Total Harmonic Distortion < 10%. Standard Ballast Factor .86-.88 HB8_H=T8 Electronic Instant Start. Total Harmonic Distortion < 10%. High Ballast Factor 1.15-1.20 HB8_L=T8 Electronic Instant Start. Total Harmonic Distortion < 10%. Low Ballast Factor .77-.82 HB8_N=T8 Electronic Instant Start. Total Harmonic Distortion < 10%. Normal Ballast Factor 1.0 HR8_DIM=T8 Electronic Program Rapid Start. Total Harmonic Distortion < 10%. Step Dimming. Ballast Factor .88³ HR8_H=T8 Electronic Program Rapid Start. Total Harmonic Distortion < 10%. High Ballast Factor 1.15-1.20³ HR8_L=T8 Electronic Program Rapid Start. Total Harmonic Distortion < 10%. Low Ballast Factor .71-.79³ HR8_T8=T8 Electronic Program Rapid Start. Total Harmonic Distortion < 10%. Standard Ballast Factor .86-.88³</p>					1=1 Ballast 2=2 Ballasts [Blank]=No Ballast (NB Option Only)	10B=Bulk Pack U=Unit Pack (Consult Factory for Other Packaging Options)

NOTES: 1. Products also available in non-US voltage and frequencies for international markets. 2. Not available when specifying emergencies, voltage must be specific. 3. Recommended when using retrofits together with motion sensor, daylight harvesting or similar controls. 4. 1-Lamp ballast in a High Ballast factor not available. 5. .90 ballast factor available for 2 or 3 14W T5 or 28W T5 lamps only.

CRUZE RETROFIT 2' x 2', 2' x 4'

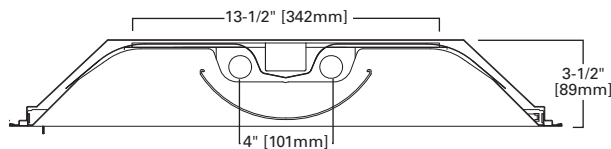

ARCHOS RETROFIT 2' x 2', 2' x 4'

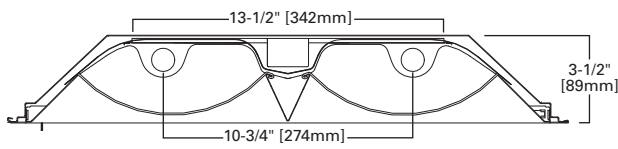

Specifications and dimensions subject to change without notice. Consult your Cooper Lighting Representative or visit www.cooperlighting.com for available options, accessories and ordering information.

FEATURES

- Equipped with energy-saving ballasts
- One-piece, die-formed steel raceway reflector assembly
- Designed to direct 50% more light into the workplace area
- Reflector finish reduces high-angle glare by over 50%
- Optional continuous row mount fixtures available
- Simplified unit or row installation
- Full-access wireway
- Baked white enamel finish
- Optional enhanced recessed silver steel reflector reduces glare

DIMENSIONS

4', 8'

Compliances may not apply to all product configurations. Please consult the product spec sheet for compliance details.

COMPLIANCES: UL/cUL Listed, UL/cUL Listed - Damp Location



RCG SERIES



ORDERING INFORMATION

SAMPLE NUMBER: RCG-A-232-120V-EB81-U

Tandem	Series	Row Configuration	Rails	Number of Lamps (Not Included) ³	Wattage
8T=8' Length [Blank]=4' Length	RC=Recessed Lighting System	C=Continuous Row (In Row) ¹ E=Continuous Row End (End of Row) ¹ G=Single Fixture ²	[Blank]=Open, No Lens/Rail A=Factory Installed Lens and Rail	1=1 Lamp 2=2 Lamps 3=3 Lamps	32=32W T8 (48") 40=40W T12 (48") 48=40W T12 SL (48") 48HO=60W T12HO (48") 48T8HO=44W T8HO (48") 72=55W T12SL (72") 72HO=85W T12HO (72") 72T8HO=65W T8HO (72") 96=75W T12SL (72") ⁴ 96HO=110W T12HO (96") ⁴ 96T8=59W T8SL (96") 96T8HO=86W T8HO (96")
SilverLining	Voltage ⁶	Options	Ballast Type		
[Blank]=White (Standard) ⁵	120V=120 Volt 277V=277 Volt 347V=347 Volt UNV=Universal Voltage 120-277 ⁷	EL=Emergency Installed (Must Specify Battery Pack, See Options) GL=Single Element Fuse GM=Double Element Fuse	[Blank]=Standard Magnetic Ballast T8 Ballasts EB8 =T8 Electronic Start. Total Harmonic Distortion < 10%. EB8 /PLUS=T8 Electronic Start. Total Harmonic Distortion < 10%. High Ballast Factor > 1.15 ER8 =T8 Electronic Program Rapid Start. Total Harmonic Distortion < 10%. T12 Ballasts EB2 =T12 Electronic Rapid Start		
Number of Ballasts	Options	Packaging	Accessories (Order Separately)		
1=1 Ballast 2=2 Ballasts 3=3 Ballasts	FR=Fire Rated Label PI/CPI=Plug-In Option RIF1=Radio Interference Suppressor RLS=Rotor Lock Socket (T8 Lamps Only) TILW=Tandem In-Line Wiring Option	U=Unit Pack	RCG-A-4FT-FRM-U=4' Lens Rail Kit ⁶ RCG-A-4FT-LENS-B=4' Prismatic Acrylic Lens ⁶ RCG-A-6FT-FRM-U=6' Lens Rail Kit ⁶ RCG-A-6FT-LENS-B=6' Prismatic Acrylic Lens ⁶ RCG-A-8FT-FRM-U=8' Lens Rail Kit ⁶ RCG-A-8FT-LENS-B=8' Prismatic Acrylic Lens ⁶ T3 End EQ Bracket=Earthquake Bracket		

NOTES: 1. RCC and RCE fixtures do not require cross tees. 2. RCG fixture requires cross tees. 3. 3-lamp fixture available with T8 lamps only. 4. 296 and 296HO with LE3 only available in 120V. 5. Not available on fixtures using HO lamps. 6. Products also available in non-US voltage and frequencies for international markets. 7. Not available when specifying emergencies, voltage must be specified.

4' or 8', 1 LAMP

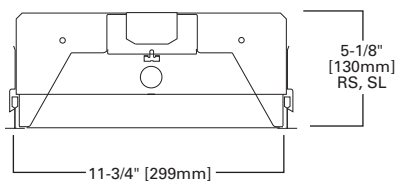

4' or 8', 2 LAMP

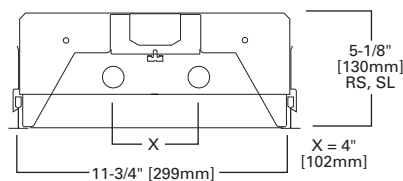

4' or 8', 3 LAMP

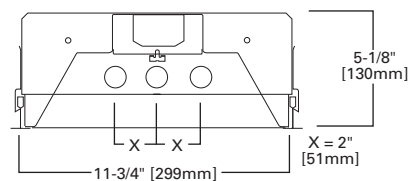

NARROW STRIPLIGHTS



FEATURES

- Flip-up socket feature for faster installation
- Commercial or residential ballast types available
- Heavy-duty, die-formed, cold-rolled steel channel includes knockouts
- Tong hanger groove offered for easy mounting
- Pre-painted material standard; PAF optional
- Tandem 8' lengths
- Optional reflectors in specular or white finishes
- Storage and utility, display case, cove, task and general applications
- Lamps are not included

DIMENSIONS

2', 3', 4', 8'

SNF SERIES

Compliances may not apply to all product configurations. Please consult the product spec sheet for compliance details.

COMPLIANCES: UL/cUL Listed - Damp Location



T5 LAMPS

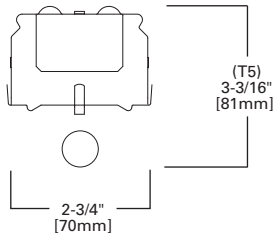

2', 4'
1 lamp T5

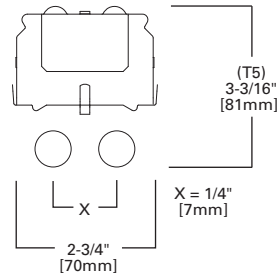

2', 4'
2 lamp T5

T8 LAMPS

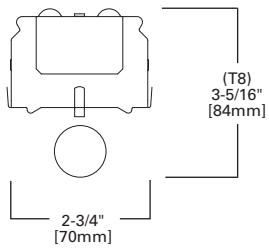

2', 4'
1 lamp T8

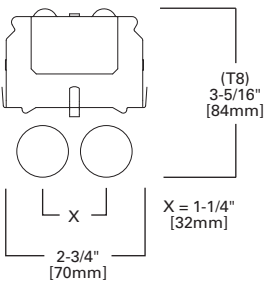

2', 4'
2 lamp T8

T12 LAMPS

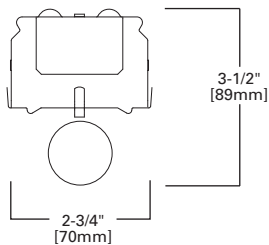

2', 3'
1 lamp T12

ORDERING INFORMATION

SAMPLE NUMBER: SNF-232-UNV-EB81-U

Tandem	Series	Number of Lamps (Not Included)	Wattage	Voltage ^{1,3}	Options
8T=8' Length [Blank]= 2', 3' or 4' Length	SNF=Commercial Narrow Striplight	1=1 Lamp 2=2 Lamp	14T5=14W T5 (24") 17=17W T8 (24") 24T5=24W T5HO (24") 25=25W T8 (36") 28T5=28W T5 (48") 28T8=28W T8 (48") 32=32W T8 (48") 54T5=54W T5HO (48")	120V=120 Volt 277V=277 Volt 347V=347 Volt UNV=Universal Voltage 120-277	EL=Emergency Installed (Must Specify Battery Pack, See Options) EL4LP=Low Profile Emergency Installed ^{2,3} EL5HOLP=Emergency Installed for T5HO EL5LP=Emergency Installed ² GL=Single Element Fuse GM=Double Element Fuse

Ballast Type³

T5 Ballasts

EBT_=T5 or T5HO Electronic Program Rapid Start. Total Harmonic Distortion < 10%.
Standard Ballast Factor=1.0

Ballast Factor/Type (For 28WT5 and 14WT5 Lamps Only)

H=High Light Output 1.15 BF⁴

HDIM=High 1.15 BF Step Dimming⁵

N=Normal Light Output .95 BF

NDIM=Normal .95-1.0 BF Step Dimming⁶

T8 Ballasts

EB8_=T8 Electronic Instant Start. Total Harmonic Distortion < 10%.

EB8_/PLUS=T8 Electronic Start. Total Harmonic Distortion < 10%. High Ballast Factor > 1.15

ER8_=T8 Electronic Program Rapid Start. Total Harmonic Distortion < 10%.

High Performance T8 Ballasts

HB8_=T8 Electronic Instant Start. Total Harmonic Distortion < 10%.
Standard Ballast Factor .86 - .88

HB8_H=T8 Electronic Instant Start. Total Harmonic Distortion < 10%.
High Ballast Factor 1.15 - 1.20

HB8_L=T8 Electronic Instant Start. Total Harmonic Distortion < 10%. Low Ballast Factor .77 - .82

HB8_N=T8 Electronic Instant Start. Total Harmonic Distortion < 10%. Normal Ballast Factor 1.0

HR8_=T8 Electronic Program Rapid Start. Total Harmonic Distortion < 10%.

Standard Ballast Factor .86 - .88

HR8_DIM=T8 Electronic Program Rapid Start. Total Harmonic Distortion < 10%.

Step Dimming. Ballast Factor .88

HR8_H=T8 Electronic Program Rapid Start. Total Harmonic Distortion < 10%.

High Ballast Factor 1.15 - 1.20

HR8_L=T8 Electronic Program Rapid Start. Total Harmonic Distortion < 10%.

Low Ballast Factor .71 - .79

T12 Ballasts

EB2_=T12 Electronic Rapid Start. Total Harmonic Distortion < 20% (30 Watt Only)

LE3=T12 Magnetic Energy Saving

Number of Ballasts	Options	Packaging	Accessories (Order Separately)
1=1 Ballast 2=2 Ballasts	6-3/18 SJT-C&P 515P=Locking Cord and Plug (120V) (15 AMP) ⁷ 6-3/18 SJT-C&P-L715P=Locking Cord and Plug (277V) (15 AMP) ⁷ PI/CPI=Plug-In Option ⁷ RIF1=Radio Interference Suppressor	4B=4 Bulk Packing (48" and 96") U=Unit Pack	A1B/Spacer-U=Spacer 1-1/2" to 2-1/2" from ceiling (Use 2 Per Fixture) AYC-Chain/Set=36" Chain Hanger (Use 1 Set Per Fixture) EYE-CHAIN/SET-B=Eye Bolt Chain (Use 1 Set Per Fixture) SCA=Adjustable 48" Stem Set SCF=Fixed Stem Set (Specify Length) SCS=Swivel Stem Set (Specify Length) SNF-ASY-3=3" Asymmetric Reflector (Specify 18", 2', or 3') ⁸ SNF-ASY-4=3" Asymmetric Reflector (Specify 2', 3', or 4') ⁸ SNF-ASY-4T5=3" Asymmetric Reflector (Specify 2' or 4') ⁸ SNF-REV-3=Reverse Asymmetric Reflector (Specify 18", 2', or 3') ⁸ SNF-REV-4=Reverse Asymmetric Reflector (Specify 2', 3', or 4') ⁸ SNF-REV-4T5=Reverse Asymmetric Reflector (Specify 2' or 4') ⁸ SNF-SYM-3=6" Symmetric Reflector (Specify 18", 2', or 3') ⁸ SNF-SYM-4=6" Symmetric Reflector (Specify 2', 3', or 4') ⁸ SNF-SYM-4T5=6" Symmetric Reflector (Specify 2' or 4') ⁸ TOGGLE=Single Toggle Number 2 (Specify Length) WG/SNF-2FT=2' Wire Guard WG/SNF-3FT=3' Wire Guard WG/SNF-4FT=4' Wire Guard WG/SNFT5-4FT=4' Wire Guard Y-TOGGLE=Y Toggle Number 2 (Specify Length)

NOTES: 1. Products also available in non-US voltage and frequencies for international markets. 2. Not available for 2' units. 3. Maximum width clearance for ballast in channel is 2-7/32". 4. 1-Lamp ballast in a High Ballast factor not available. 5. Step Dimming ballast available for 28W T5 and 14WT5 lamps only. 6. 1 Lamp step dimming ballast in normal ballast factor not available. 2-lamp ballast will not operate 1 lamp. 7. Socket brackets left uninstalled. 8. For SilverLining reflector add SS in Catalog Number, Example: SNF-ASY-SS-4.

WIDE VERSION STRIPLIGHT



FEATURES

- Flip-up socket feature for faster installation out of the box
- Die-formed cold-rolled steel channel construction with numerous KOs
- Pressure lock lampholders (RS), spring loaded lampholders (SL)
- Easy wireway access/wireway cover removed without tools
- Pre-painted material standard; PAF optional
- Tandem 8' lengths
- Optional reflectors in silver-lined reflector finish
- Storage or utility area, cove or display case application
- Lamp not included

DIMENSIONS

2', 3', 4', 8'

SSF SERIES

Compliances may not apply to all product configurations. Please consult the product spec sheet for compliance details.

COMPLIANCES: UL/cUL Listed - Damp Location

T5/T5HO LAMPS

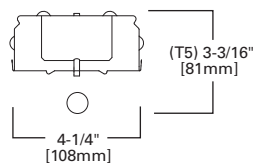
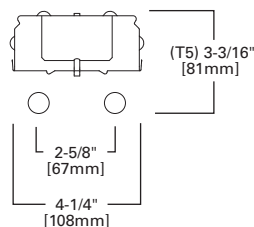
2', 4'
T5 or T5HO 1 lamp2', 4'
T5 or T5HO 2 lamp

T8/SLIMLINE LAMPS

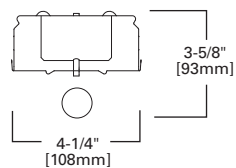
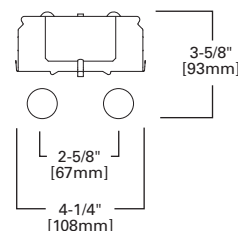
2', 3', 4'
T8 or Slimline 1 lamp2', 3', 4'
T8 or Slimline 2 lamp

T12 LAMPS

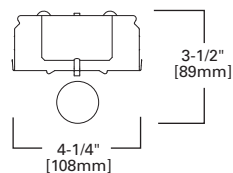
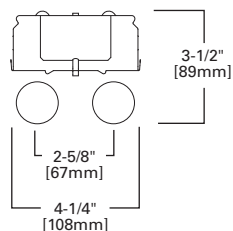
2', 3'
T12 1 lamp2', 3'
T12 2 lamp

SLIMLINE/T12HO LAMPS

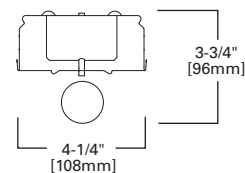
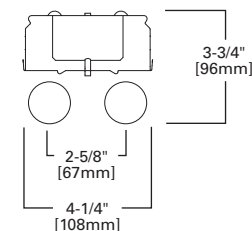
4', 8'
Slimline or T12HO 1 lamp4', 8'
Slimline or T12HO 2 lamp

ORDERING INFORMATION

SAMPLE NUMBER: SSF-232-UNV-EB81-U

Tandem	Series ¹	Number of Lamps (Not Included) ²	Wattage		Ballast Start Type
8T=8' Lengths [Blank]=2', 3' or 4' Length	SSF=Wide Version Striplight	1=1 Lamp 2=2 Lamps 3=3 Lamps ³ 4=4 Lamps	14T5=14W T5 (24") 17=17W T8 (24") 20=20W T12 (24") 21T5=21W T5 (36") 24T5=24W T5HO (24") ⁴ 25=25W T8 (36") 28T5=28W T5 (48") 28T8=28W T8 (48") ⁵ 30=30W T12 (36")	32=32W T8 (48") 40=40W T12 (48") 48HO=60W T12HO (48") 48T8HO=44W T8HO (48") 54T5=54W T5HO (48") ⁴ 96=75W T12 SL (96") 96HO=110W T12HO (96") 96T8=59W T8SL (96") 96T8HO=86W T8HO (96")	HRS=High Rapid Start (30W Only) (120V Only) HTS=High Trigger Start (20W Only) LRS=Low Rapid Start (30W Only) (120V Only) LTS=Low Trigger Start (20W Only) (120V Only)
Voltage ⁶		Options ⁶	Ballast Type		
120V=120 Volt 277V=277 Volt 347V=347 Volt UNV=Universal Voltage 120-277 ⁷		EL=Emergency Battery Installed (Must Specify Battery Pack, See Options) ^{8,9} EL4=Emergency Installed ^{9,10} EL5=Emergency Installed EL5HO=Emergency Installed for T5HO EL8=Emergency Installed ¹¹ GL=Single Element Fuse GM=Double Element Fuse	T5 Ballasts EBT_=T5 or T5HO Electronic Program Rapid Start. Total Harmonic Distortion < 10%. Standard Ballast Factor=1.0 Ballast/Factor Type (T5) EBT_H=T5 Electronic Program Rapid Start. Total Harmonic Distortion < 10%. High Ballast Factor=1.15 ¹² EBT_HDIM=T5 Electronic Program Rapid Start. Total Harmonic Distortion < 10%. Step Dimming, High Ballast Factor=1.15 ¹³ EBT_N=T5 Electronic Program Rapid Start. Total Harmonic Distortion < 10%. Normal Ballast Factor=.90 ¹⁴ EBT_NDIM=T5 Electronic Program Rapid Start. Total Harmonic Distortion < 10%. Step Dimming, Normal Ballast Factor=.95-1.0 ¹⁵ T8 Ballasts EB8_=T8 Electronic Start. Total Harmonic Distortion < 10%. EB8_/PLUS=T8 Electronic Start. Total Harmonic Distortion < 10%. High Ballast Factor > 1.15 ER8_=T8 Electronic Program Rapid Start. Total Harmonic Distortion < 10%. High Performance T8 Ballasts HB8_=T8 Electronic Instant Start. Total Harmonic Distortion < 10%. Standard Ballast Factor .86-.88 HB8_H=T8 Electronic Instant Start. Total Harmonic Distortion < 10%. High Ballast Factor 1.15-1.20 HB8_L=T8 Electronic Instant Start. Total Harmonic Distortion < 10%. Low Ballast Factor .77-.82 HB8_N=T8 Electronic Instant Start. Total Harmonic Distortion < 10%. Normal Ballast Factor 1.0 HR8_=T8 Electronic Program Rapid Start. Total Harmonic Distortion < 10%. Standard Ballast Factor .86-.88 HR8_DIM=T8 Electronic Program Rapid Start. Total Harmonic Distortion < 10%. Step Dimming, Ballast Factor .88 HR8_H=T8 Electronic Program Rapid Start. Total Harmonic Distortion < 10%. High Ballast Factor 1.15-1.20 HR8_L=T8 Electronic Program Rapid Start. Total Harmonic Distortion < 10%. Low Ballast Factor .71-.79 T12 Ballasts EB2_=T12 Electronic Rapid Start. Total Harmonic Distortion < 20% LE3=T12 Magnetic Energy Saving		
Number of Ballasts	Options	Packaging	Accessories (Order Separately)		
1=1 Ballast 2=2 Ballasts	6-3/18 SJT-C&P 515P=Locking Cord and Plug (120V) (15 AMP) ¹⁵ 6-3/18 SJT-C&P-L715P=Locking Cord and Plug (277V) (15 AMP) ¹⁶ PI/CPI=Plug-In Option ¹⁶ RIF1=Radio Interference Suppressor TILW=Tandem Inline Wiring	4B=4 Bulk Packing (48" and 96") U=Unit Pack	A1B/Spacer-U=Spacer 1-1/2" to 2-1/2" from ceiling (Use 2 Per Fixture) AYC-Chain/Set=36" Chain Hanger (Use 1 Set Per Fixture) CLC-SSF=Long Channel Connector SSF GRP-SSF=Gripper Hanger (Use 2 Per Fixture) ICF-4FT-REFL=12" Symmetric Reflector SCA=Adjustable 48" Stem Set SCF=Fixed Stem Set (Specify Length) SCS=Swivel Stem Set (Specify Length) SSF-ASY-3=3" Asymmetric Reflector (Specify 2' or 3') ¹⁷ SSF-ASY-4=3" Asymmetric Reflector (Specify 2', 3', or 4') ¹⁷ SSF-ASY-4T5=3" Asymmetric Reflector (Specify 2' or 4') ¹⁷ SSF-REV-3=3" Asymmetric Reverse Reflector (Specify 2' or 3') ¹⁷ SSF-REV-4=3" Asymmetric Reverse Reflector (Specify 2', 3', or 4') ¹⁷ SSF-REV-4T5=3" Asymmetric Reverse Reflector (Specify 2' or 4') ¹⁷ SSF-SYM-3=6" Symmetric Reflector Specify (2' or 3') ¹⁷ SSF-SYM-4=6" Symmetric Reflector Specify (2', 3' or 4') ¹⁷ SSF-SYM-4HO=6" Symmetric Reflector (2-Lamp Only), Specify (4' or 8') ¹⁷ SSF-SYM-4T5=6" Symmetric Reflector Specify (2' or 4') ¹⁷ SSF-SYM12-4HO=12" Symmetric Reflector (2-Lamp Only), Specify (4' or 8') ¹⁷ TOGGLE=Single Toggle Number 2 (Specify Length) WG/SSF-2FT=2' Wire Guard WG/SSF-3FT=3' Wire Guard WG/SSF-4FT=4' Wire Guard Y-TOGGLE=Y Toggle Number 2 (Specify Length)		

NOTES: 1. Steel endplates with 7/8" KO standard for continuous row mounting. 2. 2 point suspension recommended (up to 4'). 3. Available in 28T8 and 32 watt. Requires two ballasts for tandem option. 4. Not for temperatures that exceed 40°C (102°F). 5. HPT8 Ballast required with 28W T8 lamps. 6. Products also available in non-US voltage and frequencies for international markets. 7. Not available when specifying emergencies, voltage must be specified. 8. Not available for 2' units. 9. For other emergency options specify manufacturer part number and consult the factory for availability (example: EL-180). 10. Not available for 2' units. 11. For other emergency options specify manufacturer part number and consult the factory for availability (example: EL-180). 12. 1-Lamp ballast in a High Ballast factor not available. 13. Step Dimming ballast available for 28W T5 and 14WT5 lamps only. 14. .90 ballast factor available for 2 28W T5 lamps only. 15. 1-Lamp step dimming ballast in a Normal Ballast factor not available. 2-Lamp ballast will not operate 1-Lamp. 16. Socket brackets left uninstalled. 17. For SilverLining reflector add SS in Catalog Number, Example: SSF-ASY-SS-4.

HEAVY DUTY STRIPLIGHT



FEATURES

- Die-formed channel with white enamel finish
- Spring-loaded or rotor lampholders available
- Easy wireway access/wireway cover removed without tools
- Numerous knockouts for easy installation
- Also available in tandem 8' lengths

DIMENSIONS

4', 8'

Compliances may not apply to all product configurations. Please consult the product spec sheet for compliance details.

COMPLIANCES: UL/cUL Listed - Damp Location

SMF SERIES



ORDERING INFORMATION

SAMPLE NUMBER: SMF-232-120V-EB81-U

Tandem	Series ¹	Number of Lamps (Not Included)	Wattage (Length)	Voltage ²	Options
8T=8' Length [Blank]=4' Length	SMF=Commercial Heavy Duty Striplight	2=2 Lamps 3=3 Lamps 4=4 Lamps	32=32W T8 (48") 48T8HO=44W T8HO (48") 96=59W T8SL (96") 96HO=86W T8HO (96")	120V=120 Volt 277V=277 Volt 347V=347 Volt UNV=Universal Voltage 120-277	EL=Emergency Installed (Must Specify Battery Pack, See Options) GL=Single Element Fuse GM=Double Element Fuse
Ballast Type		Number of Ballasts	Options		Packaging
T8 Ballasts EB8=T8 Electronic Start. Total Harmonic Distortion < 10%. EB8_/PLUS=T8 Electronic Start. Total Harmonic Distortion < 10%. High Ballast Factor > 1.15 ER8=T8 Electronic Program Rapid Start. Total Harmonic Distortion < 10%.		1=1 Ballast 2=2 Ballasts 3=3 Ballasts	PI/CPI=Plug-In Option RIF1=Radio Interference Suppressor RLS=Rotor-Lock Socket (T8 Lamps Only) TILW=Tandem In-Line Wiring Option (Consult TILW Option Catalog Page).		U=Unit Pack

NOTES: 1. For SilverLining reflector add SS in Catalog Number, Example: STM-SS-SYM-6. 2. Products also available in non-US voltage and frequencies for international markets.

4', 6' or 8', 2 LAMP

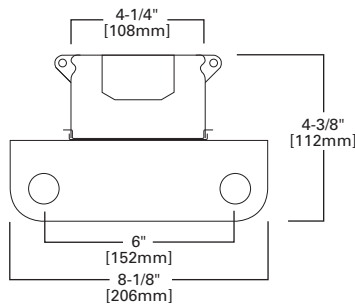

4', 6' or 8', 3 LAMP

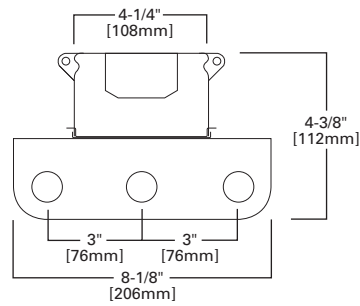

4', 6' or 8', 4 LAMP

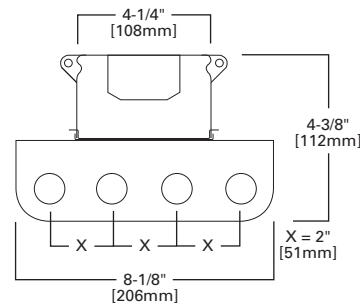

FEATURES

- For shadow-free continuous illumination in cove lighting applications
- Die-formed channel with baked white enamel finish
- Numerous knockouts for easy installation
- Easy wireway access/wireway cover removed without tools
- Surface- or pendant-mounted, individually or in rows

DIMENSIONS

2', 3', 4', 8'

Compliances may not apply to all product configurations. Please consult the product spec sheet for compliance details.

COMPLIANCES: UL/cUL Listed - Damp Location



SNL, SSL SERIES

ORDERING INFORMATION⁴

SAMPLE NUMBER: SSL-232-120V-EB81-U

Tandem	Series	Number of Lamps	Wattage	Voltage ²	Options ⁴
8T=8' Lengths [Blank]=2', 3' or 4' Lengths	SNL=Narrow Staggered Striplight SSL=Wide Staggered Striplight	1=1 Lamp 2=2 Lamps	17=17W T8 (24") 25=25W T8 (36") 32=32W T8 (48") 96T8=59W T8SL (96") ¹ 96T8HO=86W T8HO (96") ¹	120V=120 Volt 277V=277 Volt 347V=347 Volt UNV=Universal Voltage 120-277 ³	EL=Emergency Installed (Must Specify Battery Pack, See Options) GL=Single Element Fuse GM=Double Element Fuse
Ballast Type			Number of Ballasts	Options	Packaging
T8 Ballasts EB8 =T8 Electronic Start. Total Harmonic Distortion < 10%. EB8 /PLUS=T8 Electronic Start. Total Harmonic Distortion < 10%. High Ballast Factor > 1.15 ER8 =T8 Electronic Program Rapid Start. Total Harmonic Distortion < 10%.			1=1 Ballast 2=2 Ballasts 3=3 Ballasts	(See Options and Accessories) PI/CPI=Plug-In (1, 2 or 3) TILW=Tandem Inline Wiring	U=Unit Pack

NOTES: Δ For complete product data, reference the Fluorescent Specification binder. Specifications and dimensions subject to change without notice. Consult your Cooper Lighting Representative for availability and ordering information. 1. 96" High Output available in T8 only. 2. Products also available in non-US voltage and frequencies for international markets. 3. Not available when specifying emergencies, voltage must be specified. 4. Sufficient starter kits are provided with each fixture for multiple fixture rows. If rows consist of only one fixture, an additional row starter kit must also be ordered.

ORDERING INFORMATION⁴

SAMPLE NUMBER: SNL-2 (Additional Starter Kits)

Series	Number of Lamps	Type
SNL=Narrow Staggered Striplight SSL=Staggered Striplight	1=1 Lamp 2=2 Lamps	[Blank]=Bipin Rapid Start Lamp SL=Slimline or HO Lamp

NOTES: Δ Sufficient starter kits are provided with each fixture for multiple fixture rows. If rows consist of only one fixture, an additional row starter kit must also be ordered.

SNL 2', 3' or 4'

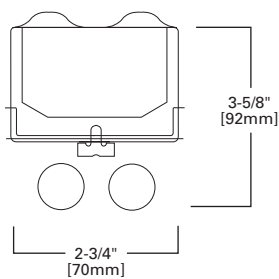

SSL 2', 3', 4' or 8'

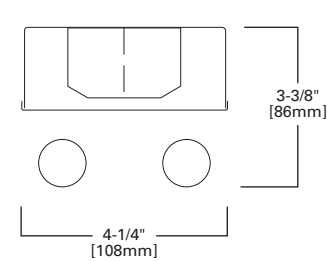

LAMP ORIENTATION

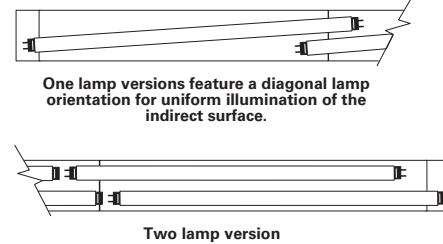

SIDE MOUNTED, RIGHT ANGLE, STAGGERED STRIPLIGHT

**FEATURES**

- Die-formed channel with numerous knockouts for easy installation
- Pressure lock lampholders ensure lamps are secure
- Easy wireway access/wireway cover removed without tools
- Lamps not included
- For shadow-free continuous illumination in cove lighting applications
- Ideal for cove, specialty showcase, signage and display lighting

DIMENSIONS

2', 3', 4', 8'

Compliances may not apply to all product configurations. Please consult the product spec sheet for compliance details.

COMPLIANCES: UL/cUL Listed - Damp LocationSNSM, SNRA,
SMSL SERIES**ORDERING INFORMATION**

SAMPLE NUMBER: SMSL-232-UNV-EB81-U

Tandem	Series	Number of Lamps (Not Included) ¹	Wattage	Ballast Start Type	Voltage ²
8T=8' Length [Blank]=2', 3' or 4' Lengths	SMSL=Side Mounted Staggered Striplight SNRA=Right Angle Striplight SNSM=Side Mounted Striplight	1=1 Lamps 2=2 Lamps 3=3 Lamps (SNRA Only)	17=17W T8 (24") 20=20W T12 (24") ² 25=25W T8 (36") 30=30W T12 (36") ² 32=32W T8 (48") 40=40W T12 (48")	HRS=High Rapid Start (3' or 4') (T12 Only) HTS=High Trigger Start (20W Only) LRS=Low Rapid Start (3' or 4') (T12 Only) (120V Only) LTS=Low Trigger Start (20W Only) (120V Only)	120V=120 Volt 277V=277 Volt 347V=347 Volt UNV=Universal Voltage 120-277 ³
Options	Ballast Type	Number of Ballasts		Options	
EL=Emergency Installed (Must Specify Battery Pack, See Options) GL=Single Element Fuse GM=Double Element Fuse	[Blank]=Standard Magnetic Ballast T8 Ballasts EB8=T8 Electronic Start. Total Harmonic Distortion < 10%. EB8_/PLUS=T8 Electronic Start. Total Harmonic Distortion < 10%. High Ballast Factor > 1.15 ER8=T8 Electronic Program Rapid Start. Total Harmonic Distortion < 10%. T12 Ballasts EB2=T12 Electronic Rapid Start	1=1 Ballast 2=2 Ballasts		FR=Fire Rated Label PAF=Painted After Fabrication RIF1=Radio Interference Suppressor RLS=Rotor Lock Socket (T8 Lamps Only)	
Packaging	Accessories (Order Separately)				
U=Unit Pack	EQ-CLIP-U=T-BAR Safety Earthquake Clips				

NOTES: 1. Lamps not included. 2. Products also available in non-US voltage and frequencies for international markets. 3. Not available when specifying emergencies, voltage must be specified.

SMSL 2', 3' or 4'

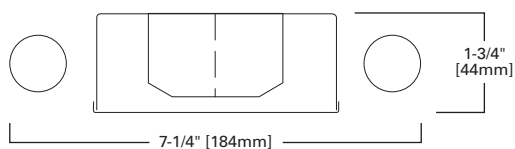

SNRA 2', 3' or 4'

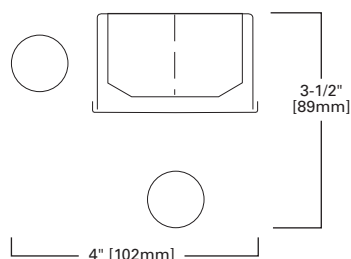

SNSM 2', 3' or 4'

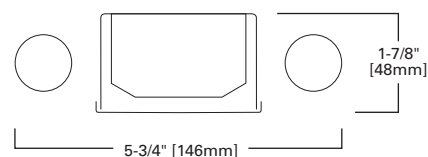

Specifications and dimensions subject to change without notice. Consult your Cooper Lighting Representative or visit www.cooperlighting.com for available options, accessories and ordering information.

FEATURES

- Equipped with energy-saving ballasts
- Low-profile modular look
- Die-formed housing
- Surface- or stem-mount in single or continuous row
- End and side panels secured with interlocking tabs
- Full-seam welded corners
- Dihedral recessed-top design for cooler operation
- Reinforced quadra-sealed, flat-white, steel door and mitered corners
- Spring-loaded cam latch and T-hinge

DIMENSIONS

1' x 4', 2' x 2', 2' x 4'

Compliances may not apply to all product configurations. Please consult the product spec sheet for compliance details.

COMPLIANCES: UL/cUL Listed - Damp Location



M SERIES



ORDERING INFORMATION⁴

SAMPLE NUMBER: 2M-314T5A-UNV-EBT2-U

Width	Series ^{1,2}	Door Frame	Number of Lamps (Not Included) ³	Wattage
2=2' Width [Blank]=1' Width	M=1' Width (3 Lamp), 2' Width MC=1' Width (2 Lamp)	[Blank]=Flat White Steel Door (Standard) FA=Flush White Extruded Aluminum c/w Spring Latch FAB=Flush Black Extruded Aluminum FAN=Flush Natural Anodized Extruded Aluminum RA=Regressed White Extruded Aluminum (3/8") RAB=Regressed Black Extruded Aluminum (3/8") RAN=Regressed Natural Anodized Extruded Aluminum (3/8")	1=1 Lamp ⁴ 2=2 Lamps 3=3 Lamps 4=4 Lamps	14T5=14W T5 (24") 17=17W T8 (24") 24T5=24W T5O (24") 28T5=28W T5 (48") 32=32W T8 (48") 54T5=54W T5HO (48") BX40=40W Biax (24") ⁵ U15/8=31W T8 (24") ⁵ U6T8=31W T8 (24") ^{5, 6}
Lens		Voltage ⁷	Options	
A=#12 Acrylic Pattern A125=#12 Pattern Acrylic (.125" Thickness) A19/156=#19 Pattern Acrylic (.156" Thickness) PB1S=Silver Parabolic Louver (1/2" x 1/2" x 1/2")		120V=120 Volt 277V=277 Volt 347V=347 Volt UNV=Universal Voltage 120-277 ⁸	EL=Emergency Installed (Must Specify Battery Pack, See Options) GL=Single Element Fuse GM=Double Element Fuse	
Ballast Type				
Biax Ballasts EB5=T5 Biax Electronic Instant Start. Total Harmonic Distortion < 20%. ⁹ TEB5=T5 Biax Electronic Instant Start. Total Harmonic Distortion < 10%. ⁹		T8 Ballasts EB8=T8 Electronic Start. Total Harmonic Distortion < 10%. EB8_/PLUS=T8 Electronic Instant Start. Total Harmonic Distortion < 10%. High Ballast Factor > 1.15 ER8=T8 Electronic Program Rapid Start. Total Harmonic Distortion < 10%.		
T5 Ballasts EBT=T5 or T5HO Electronic Program Rapid Start. Total Harmonic Distortion < 10%. Standard Ballast Factor=1.0				
Ballast/Factor Type (T5) EBT_H=T5 Electronic Program Rapid Start. Total Harmonic Distortion < 10%. High Ballast Factor=1.15 ¹⁰ EBT_HDIM=T5 Electronic Program Rapid Start. Total Harmonic Distortion < 10%. Step Dimming, High Ballast Factor=1.15 ¹¹ EBT_N=T5 Electronic Program Rapid Start. Total Harmonic Distortion < 10%. Normal Ballast Factor=.90 ¹² EBT_NDIM=T5 Electronic Program Rapid Start. Total Harmonic Distortion < 10%. Step Dimming, Normal Ballast Factor=.95-1.0 ¹³				
Number of Ballasts ¹⁴	Options	Packaging	Accessories (Order Separately)	
1=1 Ballast 2=2 Ballasts	BE=Black Exterior EKO=End plate with 7/8" KO (Required for Continuous Row Mounting) RIF1=Radio Interference Suppressor RLS=Rotor Lock Socket (T8 Lamps Only) SMB=Side Mount Ballast VRS=Vandal Resistant Screws ¹⁵	U=Unit Pack	SCA=Adjustable 48" Stem Set SCF=Fixed Stem Set (Specify Length) SCS=Swivel Stem Set (Specify Length)	

NOTES: 1. Full seam welded corners on 1'x4', 2'x2', 2'x4' fixtures. 2. 2'x2', 2'x4' require 4-point suspension, side mounted ballast recommended. 3. 1'x4' 3-lamp, 2'x4' 3 and 4-lamp have side mounted ballasts covers. 4. 1'x4' only. 5. 2' x 2' only. 6. 2 lamps only. 7. Products also available in non-US voltage and frequencies for international markets. 8. Not available when specifying emergencies, voltage must be specified. 9. Not available in UNV voltage. Must specify voltage. 10. 1 lamp ballast in high ballast factor not available. 11. Step Dimming ballast available for 2 or 3 T5 lamps only. 12. .90 ballast factor available for 2 or 3 T5 lamps. 13. 1-lamp step dimming ballast in normal ballast factor not available. 2-lamp ballast will not operate 1-lamp. 14. For 3 and 4 lamp T5/T5HO configurations, minimum (2) ballasts required. 15. Available on flat doors only.

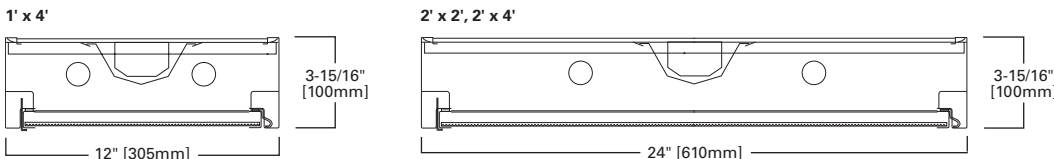

SURFACE MODULAR WRAP



FEATURES

- Provided with CEE-listed, energy-saving ballasts
- Seam-welded corners for a clean, finished exterior
- Architectural low-profile design with full luminous refractor sides
- Micro-base prisms for excellent lamp image control
- Square, conical prisms in IMA lens for precision light control
- Unique refractor design conceals lamp image and controls brightness
- Sonically welded, injection-molded refractor end caps
- Secure, positive lens attachment with hinge feature
- Smooth sides permit flush-mount continuous row installation

DIMENSIONS

4', 8'

SA SERIES

Compliances may not apply to all product configurations. Please consult the product spec sheet for compliance details.

COMPLIANCES: UL/cUL Listed, UL/cUL Listed - Damp Location, CSA Listed



ORDERING INFORMATION

SAMPLE NUMBER: SA-432IMA-UNV-EB81-U

Tandem	Series	Width	Number of Lamps (Not Included)	Wattage	Lens	Voltage ⁵
8T=8' Length (Uses 4' Door Frame Sections) ¹ [Blank]=4' Length	SA=Series	[Blank]=Standard A=Wide Body for 2 Lamps ^{2,3}	2=2 Lamps 3=3 Lamps ⁴ 4=4 Lamps	28T8=28W T8 (48") 32=32W T8 (48")	A=Acrylic Refractor Lens IMA=Injection Molded Acrylic Lens	120V=120 Volt 277V=277 Volt 347V=347 Volt UNV=Universal Voltage 120-277 ⁶
Options	Ballast Type	Number of Ballasts		Options	Packaging	
EL=Emergency Installed (Must Specify Battery Pack, See Options) GL=Single Element Fuse GM=Double Element Fuse	T8 Ballasts EB8 =T8 Electronic Start. Total Harmonic Distortion < 10%. EB8_/PLUS=T8 Electronic Start. Total Harmonic Distortion < 10%. High Ballast Factor > 1.15. ER8 =T8 Electronic Program Rapid Start. Total Harmonic Distortion < 10%.	1=1 Ballast 2=2 Ballasts 3=3 Ballasts		EKO=End Plate with 7/8" KO (Required for Continuous Row Mounting) PI/CPI=Plug-In Option	U=Unit Pack	

NOTES: 1. 8T available in 2-lamp only. 2. Wide body available in 4' units only. 3. Must specify lamp spacing by adding IB or OB as a suffix: IB (Inboard)=5 1/2" lamp spacing; OB (Outboard)=11" lamp spacing. 4. Stem Mounting not available on 3-lamp fixtures. 5. Products also available in non-US voltage and frequencies for international markets. 6. Not available when specifying emergencies, voltage must be specified.

4', 2 LAMP (IMA)

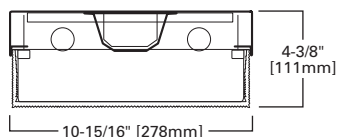

4', 3 LAMP (IMA)

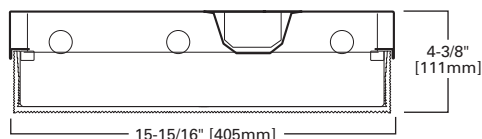

4', 4 LAMP (IMA)

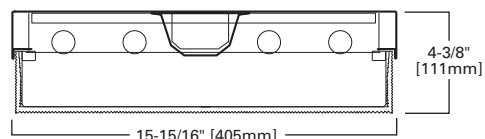

4', 2 LAMP (A)

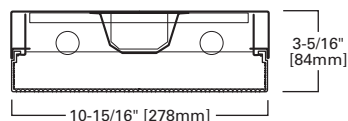

4', 3 LAMP (A)

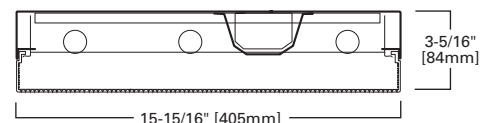

4', 4 LAMP (A)

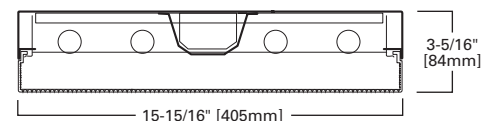
Specifications and dimensions subject to change without notice. Consult your Cooper Lighting Representative or visit www.cooperlighting.com for available options, accessories and ordering information.

FEATURES

- Equipped with energy-saving ballasts
- Reinforced quadra-sealed, flat-white, steel door and mitered corners
- Self-locking spring loaded latches/T-hinges
- Deep "V" raceway/ballast cover distributes light uniformly across lens
- Lamp-to-lens spacing produces high-comfort photometrics
- Four auxiliary fixture-end suspension points provided
- End plate grid-lock feature

DIMENSIONS

1' x 4', 2' x 2', 2' x 4', 20" x 48"

Compliances may not apply to all product configurations. Please consult the product spec sheet for compliance details.

COMPLIANCES: UL/cUL Listed - Damp Location, NOM Certified, City of Chicago Approved



GC SERIES

ORDERING INFORMATION

SAMPLE NUMBER: 2GC-228T5A-UNV-EBT1-U

Rating	Width	Trim Type	Series	Doorframes	Width ⁹
[Blank]=Standard ATW-SW4=Chicago Rated	2=2' Width [Blank]=1' Width	F=Aluminum Flange Trim ¹⁷ G=Concealed-T/Slot Grid ¹⁸ G=Grid/Lay-in (Standard)	C=Specification Deep Troffer	[Blank]=Flat White Steel Door (Standard) FA=Flush White Extruded Aluminum c/w Spring Latch FAB=Flush Black Extruded Aluminum FAN=Flush Natural Anodized Extruded Aluminum RA=Regressed White Extruded Aluminum (3/8") RAB=Regressed Black Extruded Aluminum (3/8") RAN=Regressed Natural Anodized Extruded Aluminum (3/8")	2024=20" Width x 24" Length 2048=20" Width x 48" Length
White Optics	Number of Lamps (Not Included)	Wattage (Length)		Shielding	Voltage ⁷
WO=97% Reflective White Optics Finish	1=1 Lamp 2=2 Lamps 3=3 Lamps ⁴ 4=4 Lamps	14T5=14W T5 (24") 17=17W T8 (24") 24T5=24W T5HO (24") 28T5=28W T5 (48") 28T8=28W T8 (48")	32=32W T8 (48") 54T5=54W T5HO (48") BX40=40W Biax (24") U15/8=31W T8 (24") ⁵ U6T8=32W T8 (24") ⁶	A=#12 Pattern Acrylic A125=#12 Pattern Acrylic (.125" Thickness) A19/156=#19 Pattern Acrylic (.156" Thickness) DA=Dropped Dish Matte White Acrylic IMA48=Injection Molded Acrylic (.150" Thickness) PB1S=1/2"x1/2"x1/2" Silver Parabolic Louver (Styrene)	120V=120 Volt 277V=277 Volt 347V=347 Volt UNV=Universal Voltage 120-277 ⁸
Options		Ballast Type			
EL=Emergency Battery Installed (Must Specify Battery Pack, See Options) ⁹ Flex=Flex Installed (Reference Flex Ordering Information) GL=Single Element Fuse GM=Double Element Fuse Lamps=Lamps Installed (Refer to Lamp Ordering Options)		Biax Ballasts EB5_=T5 Biax Electronic Instant Start. Total Harmonic Distortion < 20%. TEB5_=T5 Biax Electronic Instant Start. Total Harmonic Distortion < 10%. T5 Ballasts EBT_=T5 or T5HO Electronic Program Rapid Start. Total Harmonic Distortion < 10%. Standard Ballast Factor=1.0 ¹¹ Ballast/ Factor Type (T5) EBT_H=T5 Electronic Program Rapid Start. Total Harmonic Distortion < 10%. High Ballast Factor=1.15 ¹² EBT_HDIM=T5 Electronic Program Rapid Start. Total Harmonic Distortion < 10%. Step Dimming, High Ballast Factor=1.15 ¹³ EBT_N=T5 Electronic Program Rapid Start. Total Harmonic Distortion < 10%. Normal Ballast Factor=.90 ¹¹ EBT_NDIM=T5 Electronic Program Rapid Start. Total Harmonic Distortion < 10%. Step Dimming, Normal Ballast Factor=.95-1.0 ¹⁴ T8 Ballasts EB8_=T8 Electronic Start. Total Harmonic Distortion < 10%. EB8_/PLUS=T8 Electronic Start. Total Harmonic Distortion < 10%. High Ballast Factor > 1.15 ER8_=T8 Electronic Program Rapid Start. Total Harmonic Distortion < 10%. High Performance T8 Ballasts HB8_=T8 Electronic Instant Start. Total Harmonic Distortion < 10%. Standard Ballast Factor .86 - .88 HB8_H=T8 Electronic Instant Start. Total Harmonic Distortion < 10%. High Ballast Factor 1.15 - 1.20 HB8_L=T8 Electronic Instant Start. Total Harmonic Distortion < 10%. Low Ballast Factor .77 - .82 HB8_N=T8 Electronic Instant Start. Total Harmonic Distortion < 10%. Normal Ballast Factor 1.0 HR8_=T8 Electronic Program Rapid Start. Total Harmonic Distortion < 10%. Standard Ballast Factor .86 - .88 HR8_DIM=T8 Electronic Program Rapid Start. Total Harmonic Distortion < 10%. Step Dimming, Ballast Factor .88 HR8_H=T8 Electronic Program Rapid Start. Total Harmonic Distortion < 10%. High Ballast Factor 1.15 - 1.20 HR8_L=T8 Electronic Program Rapid Start. Total Harmonic Distortion < 10%. Low Ballast Factor .71 - .79			
Number of Ballasts	Options ¹⁵	Packaging	Accessories (Order Separately)		
1=1 Ballast 2=2 Ballasts	LAO=Less Access Opening PAF=Painted After Fabrication RLS=Rotor-Lock Socket (T8 Lamps Only - Standard on T5)	PAL=Job Pack, out of carton PALC=Job Pack, in carton U=Unit Pack	EQ-CLIP-U=T-BAR Safety Earthquake Clips ¹⁶		

NOTES: 1. Specify row configuration, type in catalog number when ordering complete fixtures. 2. Louver is recessed by 5/16" in Concealed T or Slot Grid T. 3. White optics not available for 2024 and 2048. 4. Standard off-center ballast on 3-lamp fixtures. 5. 3 Lamps maximum for U1-5/8. 6. 2 Lamps maximum for U6T8. 7. Products also available in non-US voltage and frequencies for international markets. 8. Not available when specifying emergencies, voltage must be specified. 9. Fixtures equipped with "EL" option may require a 5-1/2" housing depth. If installing in field, must use low profile battery pack. 10. HPT8 Ballast required with 28W T8 lamps. 11. .90 ballast factor available for 2 or 3 14W T5 or 28W T5 lamps only. 12. 1-Lamp ballast in high ballast factor is not available. 13. Step Dimming ballast available for 2 or 3 14WT5 or 28W T5 lamps only. 14. 1-Lamp step dimming ballast in a Normal Ballast factor not available. 2-Lamp ballast will not operate 1-Lamp. 15. See Options or Accessories. 16. An EQ Grid Clip is recommended for all 9/16" ceiling systems. Four required per fixture. 17. Specify row configuration, type in catalog number when ordering complete fixtures. 18. Louver is recessed by 5/16" in Concealed T or Slot Grid T.

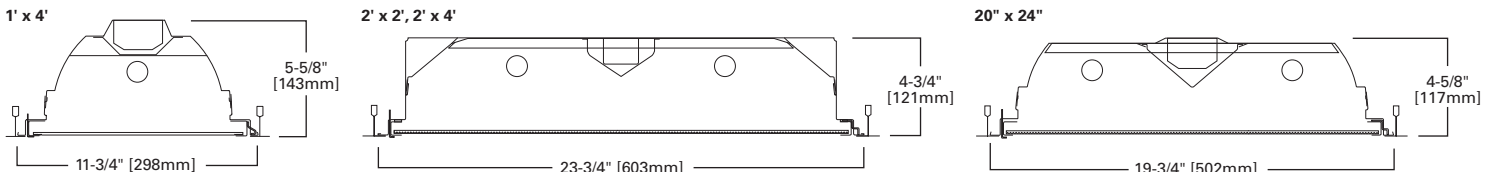

Specifications and dimensions subject to change without notice. Consult your Cooper Lighting Representative or visit www.cooperlighting.com for available options, accessories and ordering information.

COMMERCIAL GRADE T8 TROFFER



FEATURES

- Optimized for T8 lamps
- Equipped with energy-saving ballasts
- Superior lens brightness uniformity
- Reinforced flat steel door or regressed aluminum door available
- Positive spring-loaded steel latches and safety lock T-hinges
- 90% reflective white enamel finish for superior performance
- Micro ballast cover reduces ballast shadow and has tool-less access
- Features full-length, die-formed stiffeners and unibody endplate
- Ample knockouts provided for continuous row wiring

DIMENSIONS

1' x 4', 2' x 2', 2' x 4'

GC8 SERIES

Compliances may not apply to all product configurations. Please consult the product spec sheet for compliance details.

COMPLIANCES: UL/cUL Listed - Damp Location, NOM Certified, IC Rated, City of Chicago Approved

ORDERING INFORMATION

SAMPLE NUMBER: 2GC8-332A-UNV-EB81-U

Rating	Width	Trim Type	Series	Type	Doorframes	Number of Lamps (Not Included)
[Blank]=Standard ATW-SW4=Chicago Rated	2=2' Width [Blank]=1' Width	F=Aluminum Flange Trim ⁹ G=Concealed-T/Slot Grid ¹⁰ G=Grid/Lay-in (Standard)	C8=Commercial T8 Troffer	IC=IC Rated	[Blank]=Flat White Steel Door (Standard) FA=Flush White Extruded Aluminum c/w Spring Latch FAB=Flush Black Extruded Aluminum FAN=Flush Natural Anodized Extruded Aluminum RA=Regressed White Extruded Aluminum (3/8") RAB=Regressed Black Extruded Aluminum (3/8") RAN=Regressed Natural Anodized Extruded Aluminum (3/8")	2=2 Lamps 3=3 Lamps ² 4=4 Lamps ³
Wattage (Length)	Shielding	Option - Aluminum Flange Trim ¹		Voltage ⁴	Options	
17=17W T8 (24") 28T8=28W T8 (48") 32=32W T8 (48") BX40=40W Biax (24") U15/8=31W T8 (24") U6T8=32W T8 (24")	A=#12 Pattern Acrylic A125=#12 Pattern Acrylic (.125" Thickness) A19/156=#19 Pattern Acrylic (.156" Thickness) DA=Dropped Dish Matte White Acrylic IMA48=Injection Molded Acrylic (.150" Thickness) PB1S=1/2" x 1/2" x 1/2" Silver Parabolic Louver (Styrene)	[Blank]=SW (Single White) EN=End of Row Natural EW=End of Row White RN=In Row Natural RW=In Row White SN=Single Natural SW=Single White	120V=120 Volt 277V=277 Volt 347V=347 Volt UNV=Universal Voltage 120-277 ⁵	EL=Emergency Battery Installed (Must Specify Battery Pack, See Options) Flex=Flex Installed (Reference Flex Ordering Information) GL=Single Element Fuse GM=Double Element Fuse Lamps=Lamps Installed (Refer to Lamp Ordering Options)		
Ballast Type						
Biax Ballasts EB5 =T5 Biax Electronic Instant Start. Total Harmonic Distortion < 20%. ⁶ ER5 =T5 Biax Electronic Program Rapid Start. Total Harmonic Distortion < 10%. TEB5 =T5 Biax Electronic Instant Start. Total Harmonic Distortion < 10%. ⁶			High Performance T8 Ballasts HB8 =T8 Electronic Instant Start. Total Harmonic Distortion < 10%. Standard Ballast Factor .86 - .88 HB8_H=T8 Electronic Instant Start. Total Harmonic Distortion < 10%. High Ballast Factor 1.15 - 1.20 HB8_L=T8 Electronic Instant Start. Total Harmonic Distortion < 10%. Low Ballast Factor .77 - .82 HB8_N=T8 Electronic Instant Start. Total Harmonic Distortion < 10%. Normal Ballast Factor 1.0 HR8 =T8 Electronic Program Rapid Start. Total Harmonic Distortion < 10%. Standard Ballast Factor .86 - .88 HR8_DIM=T8 Electronic Program Rapid Start. Total Harmonic Distortion < 10%. Step Dimming, Ballast Factor .88 HR8_H=T8 Electronic Program Rapid Start. Total Harmonic Distortion < 10%. High Ballast Factor 1.15 - 1.20 HR8_L=T8 Electronic Program Rapid Start. Total Harmonic Distortion < 10%. Low Ballast Factor .71 - .79			
T8 Ballasts EB8 =T8 Electronic Start. Total Harmonic Distortion < 10%. EB8_/PLUS=T8 Electronic Start. Total Harmonic Distortion < 10%. High Ballast Factor > 1.15 ER8 =T8 Electronic Program Rapid Start. Total Harmonic Distortion < 10%.						
Number of Ballasts	Options ⁷	Packaging	Accessories (Order Separately)			
1=1 Ballast 2=2 Ballasts	FR=Fire Rated Label PAF=Painted After Fabrication	PAL=Job Pack, out of carton PALC=Job Pack, in carton U=Unit Pack	EQ-CLIP-U=T-BAR Safety Earthquake Clips ⁸ FCS-14W-U=1' x 4' Field Installed Flange Kit FCTKA-22W-U=2' x 2' Field Installed Flange Kit FCTKA-24W-U=2' x 4' Field Installed Flange Kit			

NOTES: 1. Specify row configuration, type in catalog number when ordering complete fixtures. 2. Standard off-center ballast on 3-lamp fixtures. 3. Not available for 1'x4'. 4. Products also available in non-US voltage and frequencies for international markets. 5. Not available when specifying emergencies, voltage must be specified. 6. Not available in UNV voltage. Must specify voltage. 7. See Options or Accessories. 8. Recommended for all 9/16" ceiling systems. Four per fixture. 9. Specify row configuration, type in catalog number when ordering complete fixtures. 10. Louver is recessed by 5/16" in Concealed T or Slot Grid T.

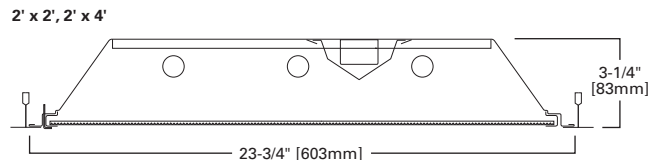
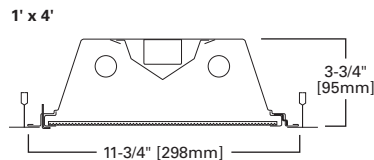
Specifications and dimensions subject to change without notice. Consult your Cooper Lighting Representative or visit www.cooperlighting.com for available options, accessories and ordering information.

FEATURES

- Shallow, low-profile housing
- Spring-loaded steel latches and safety lock T-hinges
- Rotolock T5 lampholders
- Ballast cover easily removed without tools
- Full-length mechanical light-traps and positive end light seals
- Die-formed housing with full-length stiffeners
- End plate grid-lock feature
- Four auxiliary fixture-end suspension points provided
- Field-installation flange kit available, for drywall applications,

DIMENSIONS

1' x 4', 2' x 2', 2' x 4'

Compliances may not apply to all product configurations. Please consult the product spec sheet for compliance details.

COMPLIANCES: UL/cUL Listed - Damp Location, NOM Certified, City of Chicago Approved



GR5 SERIES



ORDERING INFORMATION

SAMPLE NUMBER: 2GR5-228T5A-UNV-EBT1-U

Rating	Width	Trim Type	Series	Number of Lamps (Not Included) ²	Wattage	Shielding
[Blank]=Standard ATW-SW4=Chicago Rated	2=2' Width [Blank]=1' Width	F=Aluminum Flange Trim ¹⁶ G=Concealed-T/Slot Grid ¹⁷ G=Grid/Lay-in (Standard)	R5=General Purpose T5 Commercial Troffer ¹	1=1 Lamp 2=2 Lamps 3=3 Lamps 4=4 Lamps ³	14T5=14W T5 (24") 24T5=24W T5HO (24") 28T5=28W T5 (48") 54T5=54W T5HO (48")	A=#12 Acrylic Pattern A125=#12 Pattern Acrylic(.125" Thick) A19/156=#19 Pattern Acrylic (.156" Thick) PB1S=Silver Parabolic Louver (1/2" x 1/2" x 1/2")
Voltage ⁴	Options		Ballast Type ⁷			
120V=120 Volt 277V=277 Volt 347V=347 Volt UNV=Universal Voltage 120-277 ⁵	EL=Emergency Installed (Must Specify Battery Pack, See Options) Flex=Flex Installed (Reference Flex Ordering Information) GL=Single Element Fuse GM=Double Element Fuse Lamps=Lamps Installed (Refer to Lamp Ordering Options) ⁶		T5 Ballasts EBT_ _{T5} =T5 or T5HO Electronic Program Rapid Start. Total Harmonic Distortion < 10%. Standard Ballast Factor=1.0 Ballast/ Factor Type (T5) EBT_H=T5 Electronic Program Rapid Start. Total Harmonic Distortion < 10%. High Ballast Factor=1.15 ⁸ EBT_HDIM=T5 Electronic Program Rapid Start. Total Harmonic Distortion < 10%. Step Dimming, High Ballast Factor=1.15 ^{9, 10} EBT_N=T5 Electronic Program Rapid Start. Total Harmonic Distortion < 10%. Normal Ballast Factor=.90 ¹¹ EBT_NDIM=T5 Electronic Program Rapid Start. Total Harmonic Distortion < 10%. Step Dimming, Normal Ballast Factor=.95-1.0 ¹²			
Number of Ballasts	Options		Packaging	Accessories (Order Separately)		
1=1 Ballast 2=2 Ballasts 3=3 Ballasts	FR=Can be installed in a Fire Rated Ceiling		U=Unit Pack	EQ-CLIP-U=T-BAR Safety Earthquake Clips FCS-14W-U=1' x 4' Field Installed Flange Kit ⁶ FCTKA-22W-U=2' x 2' Field Installed Flange Kit ⁶ FCTKA-24W-U=2' x 4' Field Installed Flange Kit ⁶		

NOTES: 1. An EQ Grid Clip is recommended for all 9/16" ceiling systems. Four required per fixture. 2. Standard off-center ballast compartment on 3-lamp fixtures. 3. Available with lens only. 4. Products also available in non-US voltage and frequencies for international markets. 5. Not available when specifying emergencies, voltage must be specific. 6. See Options or Accessories. 7. Minimum 2 ballast required for 4 lamp T5HO configurations. 8. 1-Lamp ballast in a High Ballast factor not available. 9. Step Dimming ballast available for 2 28W T5 lamps only. 10. Step Dimming ballast available for 2 14W T5 lamps only. 11. .90 ballast factor available for 2 lamps only. 12. 1-Lamp step dimming ballast in a Normal Ballast factor not available. 2-Lamp ballast will not operate 1-Lamp. 13. Step Dimming ballast available for 2 or 3 28W T5 lamps only. 14. 2 lamps only. 15. Step Dimming ballast available for 2 or 3 14W T5 lamps only. 16. Specify row configuration, type in catalog number when ordering complete fixtures. 17. Louver is recessed by 5/16" in Concealed T or Slot Grid T.

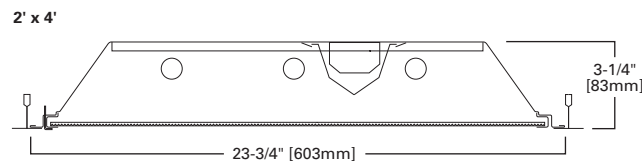
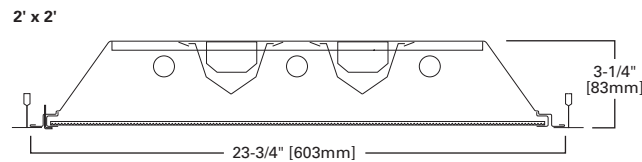
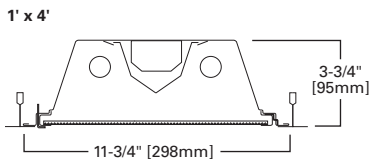

COMMERCIAL GRADE T8 TROFFER



FEATURES

- Optimized for T8 lamps
- Shallow, low-profile housing
- Ballast cover easily removed without tools
- Positive spring-loaded steel latches and safety lock T-hinges
- Full-length stiffeners and unibody end plate for added strength
- Reinforced flat white, steel door and reinforced mitered corners
- Full-width mechanical light traps
- Ample knockouts provided for continuous row wiring

DIMENSIONS

1' x 4', 2' x 2', 2' x 4'

GR8 SERIES

Compliances may not apply to all product configurations. Please consult the product spec sheet for compliance details.

COMPLIANCES: UL/cUL Listed - Damp Location, NOM Certified, IC Rated, City of Chicago Approved



ORDERING INFORMATION

SAMPLE NUMBER: 2GR8-332A-UNV-EB81-U

Rating	Width	Trim Type	Series	Type	Number of Lamps (Not Included) ¹	Wattage (Length)
[Blank]=Standard ATW-SW4=Chicago Rated	2=2' Width [Blank]=1' Width	F=Aluminum Flange Trim ⁹ G=Concealed-T/Slot Grid ¹⁰ G=Grid/Lay-in (Standard)	R8=General Purpose T8 Commercial Troffer	IC=IC Rated	2=2 Lamps 3=3 Lamps 4=4 Lamps	17=17W T8 (24") 28T8=28W T8 (48") 32=32W T8 (48") BX40=40W Biax (24") U1-5/8=31W T8 (24") ² U6T8=32W T8 (24") ²
Shielding		Voltage ³	Options			Lamps Installed
A=#12 Acrylic Pattern A125=#12 Pattern Acrylic (.125" Thickness) A19/156=#19 Pattern Acrylic (.156" Thickness) PB1S=Silver Parabolic Louver (1/2" x 1/2" x 1/2")		120V=120 Volt 277V=277 Volt 347V=347 Volt UNV=Universal Voltage 120-277 ⁴	EL=Emergency Installed (Must Specify Battery Pack, See Options) Flex=Flex Installed (Reference Flex Ordering Information) GL=Single Element Fuse GM=Double Element Fuse Lamps=Lamps Installed (Refer to Lamp Ordering Options) ⁵			Blank=No Lamps Installed (Refer to Lamp Ordering Options) L8835=T8 Lamp, 28W and 32W, 3500K L8835HL=T8 Lamp, 28W and 32W, 3500K, 3100 Lumens L8841=T8 Lamp, 28W and 32W, 4100K L8841HL=T8 Lamp, 32W, 4100K, 3100 Lumens
Ballast Type						
Biax Ballasts EB5 =T5 Biax Electronic Instant Start. Total Harmonic Distortion < 20%. ^{6,7} ER5 =T5 Biax Electronic Program Rapid Start. Total Harmonic Distortion < 10%. TEB5 =T5 Biax Electronic Instant Start. Total Harmonic Distortion < 10%. ^{6,7} T8 Ballasts EB8 =T8 Electronic Start. Total Harmonic Distortion < 10%. EB8_/PLUS=T8 Electronic Start. Total Harmonic Distortion < 10%. High Ballast Factor > 1.15 ER8 =T8 Electronic Program Rapid Start. Total Harmonic Distortion < 10%.			High Performance T8 Ballasts HB8 =T8 Electronic Instant Start. Total Harmonic Distortion < 10%. Standard Ballast Factor .86 - .88 HB8_H=T8 Electronic Instant Start. Total Harmonic Distortion < 10%. High Ballast Factor 1.15 - 1.20 HB8_L=T8 Electronic Instant Start. Total Harmonic Distortion < 10%. Low Ballast Factor .77 - .82 HB8_N=T8 Electronic Instant Start. Total Harmonic Distortion < 10%. Normal Ballast Factor 1.0 HR8 =T8 Electronic Program Rapid Start. Total Harmonic Distortion < 10%. Standard Ballast Factor .86 - .88 HR8_DIM=T8 Electronic Program Rapid Start. Total Harmonic Distortion < 10%. Step Dimming. Ballast Factor .88 HR8_H=T8 Electronic Program Rapid Start. Total Harmonic Distortion < 10%. High Ballast Factor 1.15 - 1.20 HR8_L=T8 Electronic Program Rapid Start. Total Harmonic Distortion < 10%. Low Ballast Factor .71 - .79			
Number of Ballasts		Options			Packaging	
1=1 Ballast 2=2 Ballasts 3=3 Ballasts		FR=Can be installed in a Fire Rated Ceiling			U=Unit Pack	

NOTES: 1. Standard off-center ballast on 3-lamp fixtures. 2. 2 Lamps maximum for U6T8. 3. Products also available in non-US voltage and frequencies for international markets. 4. Not available when specifying emergencies, voltage must be specified. 5. See Options or Accessories. 6. Not available in UNV voltage. Must specify voltage. 7. 4-lamp configuration only available in 17W. 8. An EQ Grid Clip is recommended for all 9/16" ceiling systems. Four required per fixture. 9. Specify row configuration, type in catalog number when ordering complete fixtures. 10. Louver is recessed by 5/16" in Concealed T or Slot Grid T.

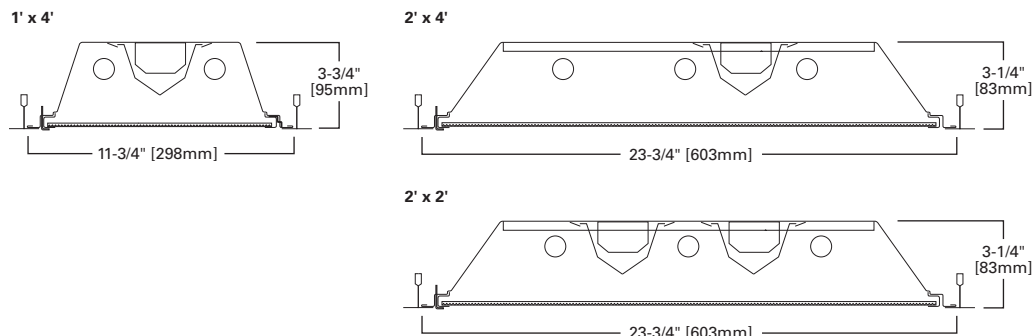

Specifications and dimensions subject to change without notice. Consult your Cooper Lighting Representative or visit www.cooperlighting.com for available options, accessories and ordering information.

FEATURES

- Equipped with energy-saving ballasts
- Efficient air-handling options
- Die-embossed para-contoured housing
- Deep "V" raceway/ballast cover (removes easily without tools)
- High reflectance and optimum lamp-to-lens spacing
- Self-locking, spring-loaded cam latch/T-hinges
- Floating extruded aluminum door
- End plate grid-lock feature
- Four auxiliary fixture-end suspension points provided

DIMENSIONS

1' x 4', 2' x 2', 2' x 4', 20" x 48"

Compliances may not apply to all product configurations. Please consult the product spec sheet for compliance details.

COMPLIANCES: UL/cUL Listed - Damp Location, NOM Certified, City of Chicago Approved



GCAFA SERIES



ORDERING INFORMATION

SAMPLE NUMBER: 2GCAFA-232A-UNV-EB81-U

Rating	Width	Trim Type	Series	Air Supply	Doorframes
[Blank]=Standard ATW-SW4=Chicago Rated	2=2' Width [Blank]=1' Width	F=Aluminum Flange Trim ⁷ G=Concealed-T/Slot Grid ⁸ G=Grid/Lay-in (Standard)	C=Specification Deep Troffer	[Blank]=No Vane A=Air Handling Floating Door, Black Reveal AV=Air Handling with Directional Vanes B=Non-Air Handling Floating Door, Black Reveal	FA=Flush White Extruded Aluminum c/w Spring Latch FAB=Flush Black Extruded Aluminum FAN=Flush Natural Anodized Extruded Aluminum RA=Regressed White Extruded Aluminum (3/8") RAB=Regressed Black Extruded Aluminum RAN=Regressed Natural Anodized Extruded Aluminum
Optional Width/Length	Number of Lamps (Not Included)	Wattage (Length)	Shielding ⁴	Option-Aluminum Flange Trim ¹	
2048=20" Width x 48' Length	1=1 Lamp 2=2 Lamps 3=3 Lamps ² 4=4 Lamps	17=17W T8 (24") 28T8=28W T8 (48") ³ 32=32W T8 (48") BX40=40W Biax (24") U15/8=31W T8 (24") U6T8=32W T8 ("24")	A=#12 Acrylic Pattern A125=#12 Pattern Acrylic (.125" Thick) A19/156=#19 Pattern Acrylic (.156" Thick) DA=Dropped Dish Matte White Acrylic IMA 48=Injection Molded Acrylic (.150" Thick) PB1S=1/2" x 1/2" x 1/2" Silver Parabolic Louver (Styrene)	[Blank]=SW (Single White) ¹ EN=End of Row, Natural Finish EW=End of Row, White Finish RN=In Row, Natural Finish RW=In Row, White Finish SN=Single, Natural Finish	
Voltage ⁵	Options	Lamps Installed			
120V=120 Volt 277V=277 Volt 347V=347 Volt UNV=Universal Voltage 120-277 ⁶	EL=Emergency Installed Flex=Flex Installed (Reference Flex Ordering Guide) GL=Single Element Fuse GM=Double Element Fuse Lamps=Lamps Installed (Refer to Lamp Ordering Options) WTR=White Reveal	[Blank]=No Lamps Installed (Refer to Lamp Ordering Options) L8835=T8 Lamp, 28W and 32W, 3500K L8835HL=T8 Lamp 32W, 3500K, 3100 Lumens L8841=T8 Lamp, 28W and 32W, 4100K L8841HL=T8 Lamp, 32W, 4100K, 3100 Lumens			
Ballast Type					
Biax Ballasts EB5 =T5 Biax Electronic Instant Start. Total Harmonic Distortion < 20%. TEB5 =T5 Biax Electronic Instant Start. Total Harmonic Distortion < 10%. T8 Ballasts EB8 =T8 Electronic Start. Total Harmonic Distortion < 10%. EB8 /PLUS=T8 Electronic Start. Total Harmonic Distortion < 10%. High Ballast Factor > 1.15 ER8 =T8 Electronic Program Rapid Start. Total Harmonic Distortion < 10%.		High Performance T8 Ballasts HB8 =T8 Electronic Instant Start. Total Harmonic Distortion < 10%. Standard Ballast Factor .86 - .88 HB8_H=T8 Electronic Instant Start. Total Harmonic Distortion < 10%. High Ballast Factor 1.15 - 1.20 HB8_L=T8 Electronic Instant Start. Total Harmonic Distortion < 10%. Low Ballast Factor .77 - .82 HB8_N=T8 Electronic Instant Start. Total Harmonic Distortion < 10%. Normal Ballast Factor 1.0 HR8 =T8 Electronic Program Rapid Start. Total Harmonic Distortion < 10%. Standard Ballast Factor .86 - .88 HR8_DIM=T8 Electronic Program Rapid Start. Total Harmonic Distortion < 10%. Step Dimming. Ballast Factor .88 HR8_H=T8 Electronic Program Rapid Start. Total Harmonic Distortion < 10%. High Ballast Factor 1.15 - 1.20 HR8_L=T8 Electronic Program Rapid Start. Total Harmonic Distortion < 10%. Low Ballast Factor .71 - .79			
Number of Ballasts	Options ⁴	Packaging	Accessories (Order Separately)		
1=1 Ballast 2=2 Ballasts 3=3 Ballasts	PAF=Painted After Fabrication RLS=Rotor-Lock Socket (T8 Lamps Only)	PAL=Job Pack Out of Carton PALC=Job Pack, in carton U=Unit Pack	EQ-CLIP-U=T-BAR Safety Earthquake Clips		

NOTES: 1. Specify row configuration, type in catalog number when ordering complete fixtures. 2. Standard off-center ballast on 3-lamp fixtures. 3. HPT8 Ballast required with 28W T8 lamps. 4. See Options or Accessories. 5. Products also available in non-US voltage and frequencies for international markets. 6. Not available when specifying emergencies, voltage must be specified. 7. Specify row configuration, type in catalog number when ordering complete fixtures. 8. Louver is recessed by 5/16" in Concealed T or Slot Grid T.

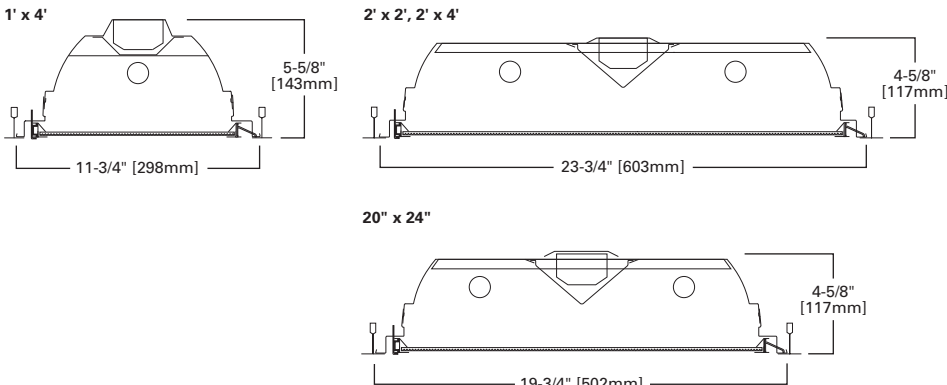

Specifications and dimensions subject to change without notice. Consult your Cooper Lighting Representative or visit www.cooperlighting.com for available options, accessories and ordering information.

AIR SUPPLY MULTI-CELL METAL OR PLASTIC LOUVER TROFFER



FEATURES

- Equipped with energy-saving ballasts
- Concealed frame, multi-cell, 1"-deep injection-molded parabolic louver
- Deep "V" raceway/ballast cover (removes without tools)
- Self-locking, spring-loaded, cam latches / T-hinges
- Multi-cell 3/4" or 1-1/2" deep parabolic aluminum louver
- One-piece para-contoured housing
- Various louver finishes
- High reflectance and optimum lamp-to-lens spacing
- Frameless, full-floating-effect louver assembly

DIMENSIONS

2' x 2', 2' x 4'

2GCAML SERIES

Compliances may not apply to all product configurations. Please consult the product spec sheet for compliance details.

COMPLIANCES: UL/cUL Listed - Damp Location, NOM Certified, City of Chicago Approved

ORDERING INFORMATION

SAMPLE NUMBER: 2GCAML-232S6131-UNV-EB81-U

Rating	Width	Trim Type	Series	Air Supply	Door Frame	Number of Lamps ² (Not Included)
[Blank]=Standard ATW-SW4=Chicago Rated	2=2' Width	F=Aluminum Flange Trim ⁹ G=Concealed-T/Slot Grid ¹⁰ G=Grid/Lay-in (Standard)	C=Specification Deep Troffer	[Blank]=No Vane A=Air Handling Floating Door, Black Reveal AV=Air Handling with Directional Vanes B=Non-Air Handling Floating Door, Black Reveal	ML=Frameless Metal Parabolic (Standard)	2=2 Lamps 3=3 Lamps 4=4 Lamps ³
Wattage	Louver	Cell Configuration	Louver Finish		Option-Aluminum Flange Trim	Voltage ⁵
17=17W T8 (24") 28T8=28W T8 (48") ⁴ 32=32W T8 (48") BX40=40W Biax (24") U15/8=31W T8 (24") U6T8=31WT8 (24")	S=Silver W=White	1313=13 Rows of 13, 169 Cell (2' x 2') 1329=13 Rows of 29, 377 Cell (2' x 4') 613=6 Rows of 13, 78 Cell (2' x 4') 66=6 Rows of 6, 36 Cell (2' x 2') 77=7 Rows of 7, 49 Cell (2' x 2')	I=Semi-Specular/Haze MI=Specular/Mirrored (Low Iridescent) P=White Finish		EN=End of Row, Natural Finish EW=End of Row, White Finish RN=In Row, Natural Finish RW=In Row, White Finish SN=Single, Natural Finish	120V=120 Volt 277V=277 Volt 347V=347 Volt UNV=Universal Voltage 120-277 ⁶

Ballast Type

[Blank]=Standard Magnetic Ballast (Biax and 20W)

Biax Ballasts

EB5=T5 Biax Electronic Instant Start. Total Harmonic Distortion < 20%.

TEB5=T5 Biax Electronic Instant Start. Total Harmonic Distortion < 10%.

T8 Ballasts

EB8=T8 Electronic Start. Total Harmonic Distortion < 10%.

EB8_/PLUS=T8 Electronic Start. Total Harmonic Distortion < 10%.
High Ballast Factor > 1.15

ER8=T8 Electronic Program Rapid Start. Total Harmonic Distortion < 10%.

High Performance T8 Ballasts

HB8=T8 Electronic Instant Start. Total Harmonic Distortion < 10%. Standard Ballast Factor .86 - .88

HB8_H=T8 Electronic Instant Start. Total Harmonic Distortion < 10%. High Ballast Factor 1.15 - 1.20

HB8_L=T8 Electronic Instant Start. Total Harmonic Distortion < 10%. Low Ballast Factor .77 - .82

HB8_N=T8 Electronic Instant Start. Total Harmonic Distortion < 10%. Normal Ballast Factor 1.0

HR8=T8 Electronic Program Rapid Start. Total Harmonic Distortion < 10%. Standard Ballast Factor .86 - .88

HR8_DIM=T8 Electronic Program Rapid Start. Total Harmonic Distortion < 10%. Step Dimming. Ballast Factor .88

HR8_H=T8 Electronic Program Rapid Start. Total Harmonic Distortion < 10%. High Ballast Factor 1.15 - 1.20

HR8_L=T8 Electronic Program Rapid Start. Total Harmonic Distortion < 10%. Low Ballast Factor .71 - .79

Number of Ballasts	Options ⁷	Lamps Installed ⁷	Accessories (Order Separately)
1=1 Ballast 2=2 Ballasts 3=3 Ballasts	EL=Emergency Battery Installed (Must Specify Battery Pack, See Options) Flex=Flex Installed (Reference Flex Ordering Information) GL=Single Element Fuse GM=Double Element Fuse PAF=Painted After Fabrication RIF1=Radio Interference Suppressor RLS=Rotor-Lock Socket (T8 Lamps Only - Standard on T5)	[Blank]=No Lamps Installed (Refer to Lamp Ordering Options) L8730=F32T8 3000K L8735=F32T8 3500K L8741=F32T8 4100K L8835=T8 Lamp, 28W and 32 W, 3500K ⁴ L8835HL=T8 Lamp, 32W, 3500K, 3100 Lumens L8841=T8 Lamp, 28W and 32W, 4100K ⁴ L8841HL=T8 Lamp, 32W, 4100K, 3100 Lumens	EQ-Clip-U=T-BAR Safety Earthquake Clips ⁸

NOTES: 1. Specify row configuration, type in catalog number when ordering complete fixtures. 2. Standard off-center ballast on 3-lamp fixtures. 3. 2' x 4' only. 4. HPT8 Ballast required with 28W T8 lamps. 5. Products also available in non-US voltage and frequencies for international markets. 6. Not available when specifying emergencies, voltage must be specified. 7. See Options or Accessories. 8. An EQ Grid Clip is recommended for all 9/16" ceiling systems. Four required per fixture. 9. Specify row configuration, type in catalog number when ordering complete fixtures. 10. Louver is recessed by 5/16" in Concealed T or Slot Grid T.

GCAML 2' x 2', 2' x 4'

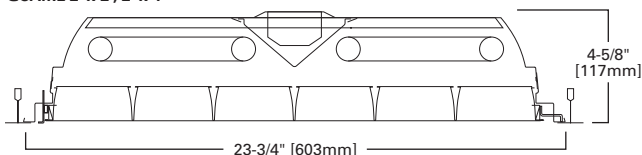

GCAPL 2' x 2', 2' x 4'

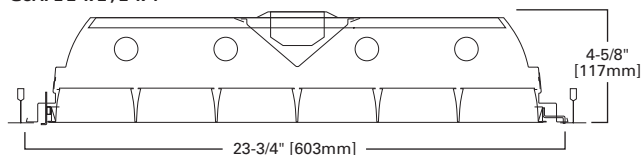
Specifications and dimensions subject to change without notice. Consult your Cooper Lighting Representative or visit www.cooperlighting.com for available options, accessories and ordering information.

FEATURES

- Provided with CEE-listed, energy-saving ballasts
- Lens and housing incorporate contemporary extruded aluminum styling
- Housing has brushed-aluminum finish with matching end plates
- Optional housing finishes include white, matte black and almond
- Die-formed internal steel channell with baked white enamel finish
- Walnut trim stripe, oak or matte black finishes
- Down-only or up-and-down light distribution
- Convenience outlet and multi-level switching available

DIMENSIONS

2', 3', 4'

Compliances may not apply to all product configurations. Please consult the product spec sheet for compliance details.

COMPLIANCES: UL/cUL Listed, UL/cUL Listed - Damp Location



BA, BAU SERIES



ORDERING INFORMATION

SAMPLE NUMBER: BAUB-232-UNV-EB81-WH-BT-U

Series	Number of Lamps (Not Included)	Wattage	Voltage ²	Options
BA =Wall Bracket Downlight Only BAU =Wall Bracket (Up and Down Light) BAUB =Wall Bracket (Up, Down or Combination Light) ¹	1 =1 Lamp 2 =2 Lamps	14T5 =14W T5 (24") 17 =17W T8 (24") 21T5 =21W T5 (36") 25 =25W T8 (36") 28T5 =28W T5 (48") 32 =32W T8 (48")	120V =120 Volt 277V =277 Volt 347V =347 Volt UNV =Universal Voltage 120-277 ³	EL =Emergency Battery Installed (Must Specify Battery Pack, See Options) ⁴ GL =Single Element Fuse GM =Double Element Fuse

Ballast Type

T5 Ballasts

EBT=T5 or T5HO Electronic Program Rapid Start. Total Harmonic Distortion < 10%. Standard Ballast Factor=1.0

Ballast/Factor Type (T5)

EBT_H=T5 Electronic Program Rapid Start. Total Harmonic Distortion < 10%. High Ballast Factor=1.15⁵

EBT_HDIM=T5 Electronic Program Rapid Start. Total Harmonic Distortion < 10%. Step Dimming, High Ballast Factor=1.15⁷

EBT_N=T5 Electronic Program Rapid Start. Total Harmonic Distortion < 10%. Normal Ballast Factor=0.9

EBT_NDIM=T5 Electronic Program Rapid Start. Total Harmonic Distortion < 10%. Step Dimming, Normal Ballast Factor=.95-1.0⁶

T8 Ballasts

EB8=T8 Electronic Start. Total Harmonic Distortion < 10%.

EB8 /PLUS=T8 Electronic Start. Total Harmonic Distortion < 10%. High Ballast Factor > 1.15

ER8=T8 Electronic Program Rapid Start. Total Harmonic Distortion < 10%.

Number of Ballasts	Options	Finishes	Packaging
1 =1 Ballast 2 =2 Ballasts 3 =3 Ballasts	2/1 LB =(2) One-Lamp Ballasts (When RS4 or PS4 Option is Used) BT =Black Accent Trim CO =Convenience Outlet (120V Only) OT =Oak Accent Trim PL5 or PL7 =Fluorescent Night Light (5 or 7 Watt) Only Available in Fixtures Without a Baffle PS1 =Pull Switch (1 Circuit) PS1D =Pull Switch, Wired to the Downlight Circuit on a Two Circuit Fixture (120V Only) PS4 =Four-way pull switch, for Two Circuit, Two Lamp Fixture (120V Only) RLS =Rotor-Lock Socket (T8 Lamp Only) RS1 =Rotary Switch (1 Circuit, 120V Only) RS1D =Rotary Switch, Wired to Downlight Circuit on a Two Circuit Fixture (120V Only) RS4 =Four-way rotary switch, for Two Circuit, Two Lamp Fixture, (120V Only) ²	BH =Matte Black Finish (Lens Housing) IH =Almond Finish (Lens Housing) WH =White Finish (Lens Housing)	U =Unit Pack

NOTES: 1. BAUB series requires two ballast and switch for independent switching. 2. Products also available in non-US voltage and frequencies for international markets. 3. Not available when specifying emergencies, voltage must be specified. 4. Not available for 2' units. 5. 2 lamps only. 6. 1-Lamp step dimming ballast in a Normal Ballast factor not available. 2-Lamp ballast will not operate 1-Lamp. 7. Step Dimming ballast available for 2 14W T5 or 28W T5 lamps only.

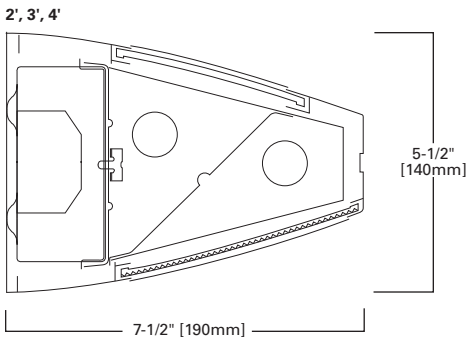

Specifications and dimensions subject to change without notice. Consult your Cooper Lighting Representative or visit www.cooperlighting.com for available options, accessories and ordering information.

COMMERCIAL STEEL WALL BRACKET - FULL END



FEATURES

- Provided with CEE-listed, energy-saving ballasts
- Low-profile design
- Die-formed steel housing
- Baked white enamel finish
- Downlight, uplight or combination uplight and downlight illumination
- Refractor slides forward for easy installation and maintenance
- Easy wiring access
- Low-brightness, extruded-acrylic diffuser
- Injection-molded end plates

DIMENSIONS

7-1/2" Width x 2', 3', 4'

BE, BEU SERIES

Compliances may not apply to all product configurations. Please consult the product spec sheet for compliance details.

COMPLIANCES: UL/cUL Listed, UL/cUL Listed - Damp Location



ORDERING INFORMATION

SAMPLE NUMBER: BE-232-UNV-EB81-U

Series	Number of Lamps (Not Included)	Wattage	Voltage ¹	Options
BE=Steel Wall Bracket Downlight Only	1=1 Lamp	14T5=14W T5 (24")	120V=120 Volt	EL=Emergency Battery Installed (Must Specify Battery Pack, See Options) GL=Single Element Fuse GM=Double Element Fuse
BEU=Steel Wall Bracket (Up and Down Light)	2=2 Lamps	17=17W T8 (24") 21T5=21W T5 (36")	25=25W T8 (36") 28T5=28W T5 (48") 32=32W T8 (48") 277V=277 Volt 347V=347 Volt UNV=Universal Voltage 120-277 ²	

Ballast Type

T5 Ballasts

EBT_{T5}=T5 or T5HO Electronic Program Rapid Start. Total Harmonic Distortion < 10%. Standard Ballast Factor=1.0

Ballast/Factor Type (T5)

EBT_H=T5 Electronic Program Rapid Start. Total Harmonic Distortion < 10%. High Ballast Factor=1.15³

EBT_{HDIM}=T5 Electronic Program Rapid Start. Total Harmonic Distortion < 10%. Step Dimming, High Ballast Factor=1.15⁴

EBT_N=T5 Electronic Program Rapid Start. Total Harmonic Distortion < 10%. Normal Ballast Factor=.90

EBT_{NDIM}=T5 Electronic Program Rapid Start. Total Harmonic Distortion < 10%. Step Dimming, Normal Ballast Factor=.95-1.0⁵

T8 Ballasts

EB8_{T8}=T8 Electronic Start. Total Harmonic Distortion < 10%.

EB8_{/PLUS}=T8 Electronic Start. Total Harmonic Distortion < 10%. High Ballast Factor > 1.15

ER8_{T8}=T8 Electronic Program Rapid Start. Total Harmonic Distortion < 10%.

Number of Ballasts	Options	Packaging
1=1 Ballast 2=2 Ballasts	2/1LB=(2) One-Lamp Ballasts (When RS4 or PS4 Option is Used) BH=Matte Black Finish (Lens Housing) CO=Convenience Outlet (120V Only) PL5 or PL7=Fluorescent Night Light (5 or 7 Watt) Only Available in Fixtures Without a Baffle PS1=Pull Switch (1 Circuit) PS1D=Pull Switch, Wired to Downlight Circuit on a Two Circuit Fixture (120V Only) PS4=Four-way pull switch, for Two Circuit 2 Lamp Fixture (120V Only) RLS=Rotor Lock Socket (T8 Lamps Only) RS1=Rotary Switch (1 Circuit, 120V Only) RS1D=Rotary Switch Wired to Downlight Circuit on a Two Circuit Fixture (120V Only) RS4=Four-way rotary switch, for Two Circuit, Two Lamp Fixture (120V Only)	U=Unit Pack

NOTES: 1. Products also available in non-US voltage and frequencies for international markets. 2. Not available when specifying emergencies, voltage must be specified. 3. 1-Lamp ballast in a High Ballast factor not available. 4. Step Dimming ballast available for 2 or 3 14WT5 or 28W T5 lamps only. 5. 1-Lamp step dimming ballast in a Normal Ballast factor not available. 2-Lamp ballast will not operate 1-Lamp.

2', 3', 4'

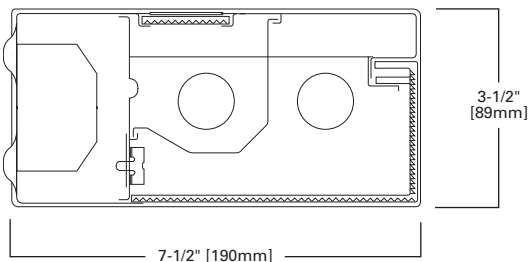

Specifications and dimensions subject to change without notice. Consult your Cooper Lighting Representative or visit www.cooperlighting.com for available options, accessories and ordering information.

ALL PURPOSE WALL BRACKET



BC SERIES

FEATURES

- Provided with CEE-listed, energy-saving ballasts
- Ideal for high vertical illumination areas
- 180° uniform light distribution
- Extruded, smooth opal, white, acrylic refractor
- Decorative, opaque, injection-molded white end caps
- Die-formed housing in a baked white enamel finish
- Vertical-wall- or horizontal-ceiling-mount applications
- Easy maintenance design
- Mounted vertically or horizontally

DIMENSIONS

2', 3', 4'

Compliances may not apply to all product configurations. Please consult the product spec sheet for compliance details.

COMPLIANCES: UL/cUL Listed, UL/cUL Listed - Damp Location



ORDERING INFORMATION

SAMPLE NUMBER: BC-228T5-UNV-EBT1-U

Series	Number of Lamps	Wattage	Voltage ¹	Options	
BC=All Purpose Wall Bracket	1=1 Lamp 2=2 Lamps	14T5=14W T5 (24") 25=25W T8 (36") 17=17W T8 (24") 28T5=28W T5 (48") 21T5=21W T5 (36") 32=32W T8 (48")	120V=120 Volt 277V=277 Volt 347V=347 Volt UNV=Universal Voltage 120-277 ²	EL=Emergency Battery Installed (Must Specify Battery Pack, See Options) GL=Single Element Fuse GM=Double Element Fuse	
Ballast Type			Number of Ballasts	Options	Packaging
T5 Ballasts EBT_=T5 or T5HO Electronic Program Rapid Start. Total Harmonic Distortion < 10%. Standard Ballast Factor=1.0 Ballast/Factor Type (T5) EBT_H=T5 Electronic Program Rapid Start. Total Harmonic Distortion < 10%. High Ballast Factor=1.15 ³ EBT_HDIM=T5 Electronic Program Rapid Start. Total Harmonic Distortion < 10%. Step Dimming, High Ballast Factor=1.15 ⁴ EBT_N=T5 Electronic Program Rapid Start. Total Harmonic Distortion < 10%. Normal Ballast Factor=.90 EBT_NDIM=T5 Electronic Program Rapid Start. Total Harmonic Distortion < 10%. Step Dimming, Normal Ballast Factor=.95-1.0 ⁵ T8 Ballasts EB8_=T8 Electronic Start. Total Harmonic Distortion < 10%. EB8_/PLUS=T8 Electronic Start. Total Harmonic Distortion < 10%. High Ballast Factor > 1.15 ER8_=T8 Electronic Program Rapid Start. Total Harmonic Distortion < 10%.			1=1 Ballast 2=2 Ballasts	CO=Convenience Outlet (120V Only) PS1=Pull Switch (1 Circuit) RLS=Rotor Lock Socket (T8 Lamps Only) RS1=Rotary Switch (1 Circuit, 120V Only)	U=Unit Pack

NOTES: 1. Products also available in non-US voltage and frequencies for international markets. 2. Not available when specifying emergencies, voltage must be specified. 3. 1-Lamp ballast in a High Ballast factor not available. 4. Step Dimming ballast available for 2 or 3 14WT5 or 28W T5 lamps only. 5. 1-Lamp step dimming ballast in a Normal Ballast factor not available. 2-Lamp ballast will not operate 1-Lamp.

2', 3', 4'

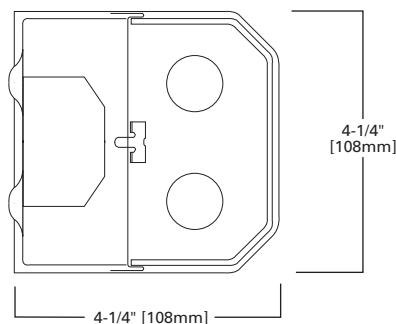

STEEL WALL BRACKET



FEATURES

- Provided with CEE-listed, energy-saving ballasts
- Low-profile design
- Die-formed steel housing
- Baked white enamel finish
- Downlight, uplight or combination uplight and downlight illumination
- Injection-molded diffuser and end plates
- Refractor slides forward for easy installation and maintenance
- Easy wiring access
- Convenience outlet and switching options available

DIMENSIONS

7-1/2" wide x 2', 3', 4'

BI, BIU SERIES

Compliances may not apply to all product configurations. Please consult the product spec sheet for compliance details.

COMPLIANCES: UL/cUL Listed, UL/cUL Listed - Damp Location

ORDERING INFORMATION

SAMPLE NUMBER: BIU-232-120V-EB82-PS4-U

Series	Number of Lamps (Not Included)	Wattage	Voltage ¹	Options
BI=Steel Wall Bracket Downlight Only	1=1 Lamp	14T5=14W T5 (24")	120V=120 Volt	EL=Emergency Battery Installed
BIU=Steel Wall Bracket (Up and Down Light)	2=2 Lamps	17=17W T8 (24")	277V=277 Volt	(Must Specify Battery Pack, See Options)
		21T5=21W T5 (36")	347V=347 Volt	GL=Single Element Fuse
		25=25W T8 (36")	UNV=Universal Voltage 120-277 ²	GM=Double Element Fuse
		28T5=28W T5 (48")		
		32=32W T8 (48")		

Ballast Type

T5 Ballasts

EBT_T5 or T5HO Electronic Program Rapid Start. Total Harmonic Distortion < 10%. Standard Ballast Factor=1.0

Ballast/Factor Type (T5)

EBT_H=T5 Electronic Program Rapid Start. Total Harmonic Distortion < 10%. High Ballast Factor=1.15³EBT_HDIM=T5 Electronic Program Rapid Start. Total Harmonic Distortion < 10%. Step Dimming, High Ballast Factor=1.15⁴

EBT_N=T5 Electronic Program Rapid Start. Total Harmonic Distortion < 10%. Normal Ballast Factor=.90

EBT_NDIM=T5 Electronic Program Rapid Start. Total Harmonic Distortion < 10%. Step Dimming, Normal Ballast Factor=.95-1.0⁵

T8 Ballasts

EB8_T8 Electronic Start. Total Harmonic Distortion < 10%.

EB8_PLUS=T8 Electronic Start. Total Harmonic Distortion < 10%. High Ballast Factor > 1.15

ER8_T8 Electronic Program Rapid Start. Total Harmonic Distortion < 10%.

Number of Ballasts	Options	Packaging
1=1 Ballast 2=2 Ballasts	2/1LB=(2) One-Lamp Ballasts (When RS4 or PS4 Option is Used) BH=Matte Black Finish (Lens Housing) CO=Convenience Outlet (120V Only) PL5 or PL7=Fluorescent Night Light (5 or 7 Watt) Only Available in Fixtures Without a Baffle PS1=Pull Switch (1 Circuit) PS1D=Pull Switch, Wired to Downlight Circuit on a Two Circuit Fixture (120V Only) PS4=Four-way pull switch, for Two Circuit 2 Lamp Fixture (120V Only) RLS=Rotor Lock Socket (T8 Lamps Only) RS1=Rotary Switch (1 Circuit, 120V Only) RS1D=Rotary Switch Wired to Downlight Circuit on a Two Circuit Fixture (120V Only) RS4=Four-way rotary switch, for Two Circuit, Two Lamp Fixture (120V Only)	U=Unit Pack

NOTES: 1. Products also available in non-US voltage and frequencies for international markets. 2. Not available when specifying emergencies, voltage must be specified. 3. 1-Lamp ballast in a High Ballast factor not available. 4. Step Dimming ballast available for 2 or 3 14WT5 or 28W T5 lamps only. 5. 1-Lamp step dimming ballast in a Normal Ballast factor not available. 2-Lamp ballast will not operate 1-Lamp.

2', 3', 4'

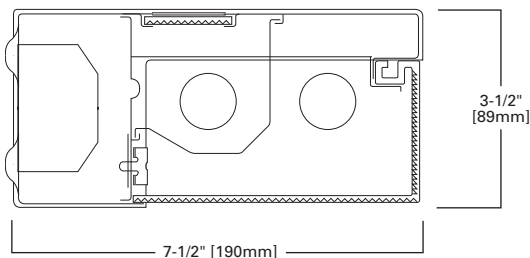

T8 OR T5 UNDERCABINET



CL, UC SERIES

FEATURES

- Post-painted housings and 100% acrylic non-yellowing lenses
- Thin profile housing constructed of heavy-gauge, cold-rolled steel
- Rocker switch (included) can be field-installed (UC series only)
- All fixtures shipped as direct wired
- Easy re-lamping and maintenance
- Various lengths available

DIMENSIONS

12", 18", 21", 24", 33", 36", 42", 48"

Compliances may not apply to all product configurations. Please consult the product spec sheet for compliance details.

COMPLIANCES: UL/cUL Listed - Damp Location



ORDERING INFORMATION

SAMPLE NUMBER: CL-117-120V-EB81-U

Housing Design	Series	Number of Lamps (Not Included)	Wattage (Length)	Starting Type	Voltage ¹	
[Blank]=Lensed Front (Standard) OF=Opaque Front	CL=Series	1=1 Lamp Only	15=15W T8 (18") 17=17W T8 (24") 25=25W T8 (36") 32=32W T8 (48")	HTS=High Trigger Start (15W Only) LTS=Low Trigger Start (15W Only) (120V Only)	120V=120 Volt 277V=277 Volt 347V=347 Volt UNV=Universal Voltage 120-277 ²	
Options	Ballast Type			Number of Ballast	Options	Packaging
GL=Single Element Fuse GM=Double Element Fuse	[Blank]=Standard Magnetic Ballast (15W Only) T8 Ballasts EB8=T8 Electronic Start. Total Harmonic Distortion < 10%. EB8_/PLUS=T8 Electronic Start. Total Harmonic Distortion < 10%. High Ballast Factor > 1.15. ER8=T8 Electronic Program Rapid Start. Total Harmonic Distortion < 10%.			1=1 Ballast 2=2 Ballasts 3=3 Ballasts	6CP=6' White 3-Wire Fuse CO=Convenience Outlet RLS=Rotor Lock Socket (T8 Lamp Only) SW=Rocker Switch ³	U=Unit Pack

NOTES: 1. Products also available in non-US voltage and frequencies for international markets. 2. Not available when specifying emergencies, voltage must be specified. 3. Must specify voltage.

ORDERING INFORMATION

SAMPLE NUMBER: CL-113T5-EB-120V-U

Housing Design	Series	Number of Lamps (Not Included)	Wattage (Length)	Ballast Type	Voltage	Options	Packaging
[Blank]=Lensed Front (Standard) OF=Opaque Front SF=Solid Metal Front	CL=Series	1=1 Lamp Only (12", 21", 33" Fixture) 2=24", 42" Fixture	0813T5=8W and 13W T5 (33") 08T5=8W T5 (12", 24") 13T5=13W T5 (21", 42")	EB=Electronic Ballast PH=Pre-Heat Ballast	120V=120 Volt	6CP=6' White 3-Wire Fuse CO=Convenience Outlet SW=Rocker Switch	U=Unit Pack

ORDERING INFORMATION RESIDENTIAL

Catalog Number	Description	Length	Width	Depth
UC12T518	12", 1 lamp T5, 8W, 120V, electronic ballast, lamp included	12-1/4"	5"	1-3/8"
UC21T5113	21", 1 lamp T5, 13W, 120V, electronic ballast, lamp included	21-1/4"	5"	1-3/8"
UC24T528	24", 2 lamp T5, 2/8W, 120V, electronic ballast, lamps included	24-1/2"	5"	1-3/8"
UC33T51813	33", 2 lamp T5, 8 +13W, 120V, electronic ballast, lamps included	33-3/8"	5"	1-3/8"
UC42T5213	42", 2 lamp T5, (2) 13W, 120V, electronic ballast, lamps included	42-1/2"	5"	1-3/8"
UC18T8115	18", 1 lamp T8, 15W, 120V, electronic ballast, lamp included	18-1/4"	3-7/8"	1-5/8"
UC24T8117	24", 1 lamp T8, 17W, 120V, electronic ballast, lamp included	24-1/4"	3-7/8"	1-5/8"
UC36T8125	36", 1 lamp T8, 25W, 120V, electronic ballast, lamp included	36-1/8"	3-7/8"	1-5/8"
UC48T8132	48", 1 lamp T8, 32W, 120V, electronic ballast, lamp included	48-1/6"	3-7/8"	1-5/8"

CL - 18", 24", 36", 48", 1 T8 LAMP

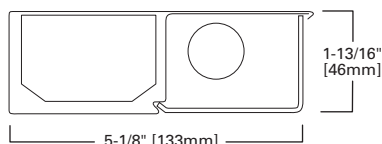

UC - T8

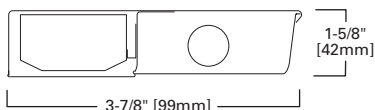

UC DIMENSIONS

Catalog Number	Length
UC12T518	12-1/4"
UC21T5113	21-1/4"
UC24T528	24-1/2"
UC33T51813	33-3/8"
UC42T5213	42-1/2"
UC18T8115	18-1/4"
UC24T8117	24-1/4"
UC36T8125	36-1/8"
UC48T8132	48-1/6"

CL - 2", 21", 24", 33", 42", 1 or 2 T5 LAMPS

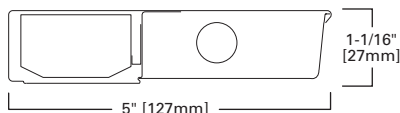

UC - T5

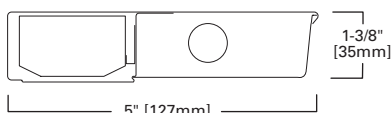

Specifications and dimensions subject to change without notice. Consult your Cooper Lighting Representative or visit www.cooperlighting.com for available options, accessories and ordering information.

SURFACE CORRIDOR MOUNT



FEATURES

- Provided with CEE-listed, energy-saving ballasts
- Die-formed channel and end plates with embossed light seal
- Extruded-acrylic refractor optimizes efficiency and brightness control
- Baked white enamel finish
- Lift-and-shift refractor offers easy re-lamping
- Wireway cover easily removed without tools
- Surface- or stem-mount in single or continuous row
- Tandem 8' lengths
- Optional wall-mount bracket

DIMENSIONS

6-1/8" x 2', 4', 8'

CR SERIES

Compliances may not apply to all product configurations. Please consult the product spec sheet for compliance details.

COMPLIANCES: UL/cUL Listed, UL/cUL Listed - Damp Location

ORDERING INFORMATION

SAMPLE NUMBER: CR-232A-120V-EB81-U

Tandem ¹	Series	Number of Lamps (Not Included)	Wattage	Lens	Voltage ²
8T=8' Length [Blank]=2' or 4' Length	CR=Corridor Lite	1=1 Lamp 2=2 Lamps	14T5=14W T5 (24") 17=17W T8 (24") 28T5=28W T5 (48") 32=32W T8 (48") 96T8=59W T8 SL (96")	A=Acrylic Refractor Lens	120V=120 Volt 277V=277 Volt 347V=347 Volt UNV=Universal Voltage 120-277 ³

Ballast Type

T5 Ballasts

EBT_=T5 or T5HO Electronic Program Rapid Start. Total Harmonic Distortion < 10%. Standard Ballast Factor=1.0

Ballast/Factor Type (T5)

EBT_H=T5 Electronic Program Rapid Start. Total Harmonic Distortion < 10%. High Ballast Factor=1.15⁴

EBT_HDIM=T5 Electronic Program Rapid Start. Total Harmonic Distortion < 10%. Step Dimming, High Ballast Factor=1.15

EBT_N=T5 Electronic Program Rapid Start. Total Harmonic Distortion < 10%. Normal Ballast Factor=.90⁵EBT_NDIM=T5 Electronic Program Rapid Start. Total Harmonic Distortion < 10%. Step Dimming, Normal Ballast Factor=.95-1.0⁶

T8 Ballasts

EB8_=T8 Electronic Start. Total Harmonic Distortion < 10%.

EB8_/PLUS=T8 Electronic Start. Total Harmonic Distortion < 10%. High Ballast Factor > 1.15

ER8_=T8 Electronic Program Rapid Start. Total Harmonic Distortion < 10%.

High Performance T8 Ballasts

HB8_=T8 Electronic Instant Start. Total Harmonic Distortion < 10%. Standard Ballast Factor .86 - .88

HB8_H=T8 Electronic Instant Start. Total Harmonic Distortion < 10%. High Ballast Factor 1.15 - 1.20

HB8_L=T8 Electronic Instant Start. Total Harmonic Distortion < 10%. Low Ballast Factor .77 - .82

HB8_N=T8 Electronic Instant Start. Total Harmonic Distortion < 10%. Normal Ballast Factor 1.0

HR8_=T8 Electronic Program Rapid Start. Total Harmonic Distortion < 10%. Standard Ballast Factor .86 - .88

HR8_DIM=T8 Electronic Program Rapid Start. Total Harmonic Distortion < 10%. Step Dimming, Ballast Factor .88

HR8_H=T8 Electronic Program Rapid Start. Total Harmonic Distortion < 10%. High Ballast Factor 1.15 - 1.20

HR8_L=T8 Electronic Program Rapid Start. Total Harmonic Distortion < 10%. Low Ballast Factor .71 - .79

Number of Ballasts	Options	Packaging	Accessories (Order Separately)
1=1 Ballast 2=2 Ballasts	RLS=Rotor-Lock Socket (T8 Lamps Only - Standard on T5)	U=Unit Pack	A1B/Spacer-U=Spacer 1-1/2" to 2-1/2" from ceiling (Use 2 Per Fixture) AYC/Chain/Set-U=Chain Hanger (Use 2 Per Fixture) CR-WALLKIT=Wall Mount Accessory GRP-SS-U=Gripper Hanger (1-1/2" Spacing) (Use 2 Per Fixture) SCA=Adjustable 48" Stem Set SCF=Fixed Stem Set (Specify Length) SCS=Swivel Stem Set (Specify Length)

NOTES: 1. Length of fixture (2' or 4') determined by lamp wattage chosen. 2. Products also available in non-US voltage and frequencies for international markets. 3. Not available when specifying emergencies, voltage must be specified. 4. 1-Lamp ballast in a High Ballast factor not available. 5. .90 ballast factor available for 2 or 3 14W T5 or 28W T5 lamps only. 6. 1-Lamp step dimming ballast in a Normal Ballast factor not available. 2-Lamp ballast will not operate 1-Lamp.

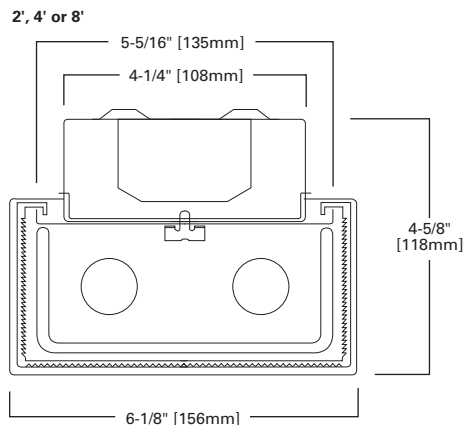
Specifications and dimensions subject to change without notice. Consult your Cooper Lighting Representative or visit www.cooperlighting.com for available options, accessories and ordering information.

FEATURES

- 100% clear acrylic prismatic lens provide excellent illumination
- Lift-and-shift lens offers easy re-lamping
- Ends formed with housing for strength and row alignment
- Commercial or residential electronic ballast
- Rotorlock lampholders enable easy lamp engagement
- Embossed steel end plates with 7/8" knockout
- Ideal for commercial and residential applications

DIMENSIONS

2', 4', 8'

Compliances may not apply to all product configurations. Please consult the product spec sheet for compliance details.

COMPLIANCES: UL/cUL Listed - Damp Location, ENERGY STAR Qualified



WN SERIES



ORDERING INFORMATION

SAMPLE NUMBER: WN-332A-UNV-EB81-U

Length	Series ¹	Number of Lamps(Not Included) ^{2,3}	Wattage	Lens	Voltage ⁵	Options	
8T=8' (Tandem) [Blank]=2' or 4' Length	WN=Commercial Surface Wraparound	2=2 Lamps 3=3 Lamps 4=4 Lamps	14T5=14W T5 (24") 17=17W T8 (24") 24T5=24W T5HO (24")	28T5=28W T5 (48") 28T8=28W T8 (48") ⁴ 32=32W T8 (48") (24") 54T5=54W T5HO (48")	A=Acrylic Refractor Lens	120V=120 Volt 277V=277 Volt 347V=347 Volt UNV=Universal Voltage 120-277 ⁶	EL=Emergency Installed (Must Specify Battery Pack, See Options) GL=Single Element Fuse GM=Double Element Fuse PI/CPI=Plug-In Option TILW=Tandem Inline Wiring

Ballast Type⁷

T5 Ballasts

EBT=T5 or T5HO Electronic Program Rapid Start. Total Harmonic Distortion < 10%.
Standard Ballast Factor=1.0

Ballast/Factor Type (T5)

EBT_H=T5 Electronic Program Rapid Start. Total Harmonic Distortion < 10%.
High Ballast Factor=1.15¹⁰

EBT_HDIM=T5 Electronic Program Rapid Start. Total Harmonic Distortion < 10%.
Step Dimming, High Ballast Factor = 1.15

EBT_N=T5 Electronic Program Rapid Start. Total Harmonic Distortion < 10%.
Normal Ballast Factor=.90¹¹

EBT_NDIM=T5 Electronic Program Rapid Start. Total Harmonic Distortion < 10%.
Step Dimming, Normal Ballast Factor=.95-1.0¹²

Ballast/Factor Type (For 14W T5 and 28W T5 Lamp Only)

[Blank]=Standard T5HO Ballast

H=High Light Output 1.15 BF

HDIM=High 1.15 BF Step Dimming⁸

N=Normal Light Output .95 BF

NDIM=Normal .95-1.0 BF Step Dimming⁹

T8 Ballasts

EB8=T8 Electronic Start. Total Harmonic Distortion < 10%.

EB8_PLUS=T8 Electronic Start. Total Harmonic Distortion < 10%.
High Ballast Factor > 1.15.

ER8=T8 Electronic Program Rapid Start. Total Harmonic Distortion < 10%.

REB1=T8 Electronic Instant Start Residential Ballast

High Performance T8 Ballasts

HB8=T8 Electronic Instant Start. Total Harmonic Distortion < 10%. Standard Ballast Factor .86-.88

HB8_H=T8 Electronic Instant Start. Total Harmonic Distortion < 10%. High Ballast Factor 1.15-1.20

HB8_L=T8 Electronic Instant Start. Total Harmonic Distortion < 10%. Low Ballast Factor .77-.82

HB8_N=T8 Electronic Instant Start. Total Harmonic Distortion < 10%. Normal Ballast Factor 1.0

HR8=T8 Electronic Program Rapid Start. Total Harmonic Distortion < 10%. Standard Ballast Factor .86-.88

HR8_DIM=T8 Electronic Program Rapid Start. Total Harmonic Distortion < 10%. Step Dimming. Ballast Factor .88

HR8_H=T8 Electronic Program Rapid Start. Total Harmonic Distortion < 10%. High Ballast Factor 1.15-1.20

HR8_L=T8 Electronic Program Rapid Start. Total Harmonic Distortion < 10%. Low Ballast Factor .71-.79

Number of Ballasts	Options	Packaging	Accessories (Order Separately)
1=1 Ballast 2=2 Ballasts	CRA=Continuous Row Aligner DEC=Decorative End Cap	4B=4 Bulk Packing (48" and 96") U=Unit Pack	SCA=Adjustable 48" Stem Set SCF=Fixed Stem Set (Specify Length) SCS=Swivel Stem Set (Specify Length) WN-2LT-DEC-ENDS=Decorative End Caps - 2 Lamps (2 Pieces) WN-4LT-DEC-ENDS=Decorative End Caps - 3 or 4 Lamps (2 Pieces) WN-CRA=Continuous Row Aligner (24 Pieces)

NOTES: 1. Steel endplates with 7/8" KO standard for continuous row mounting. 2. 2 point suspension recommended for 2 and 4 lamp models. 3 point suspension recommended for 8 foot tandems. 3. Suspension mounting not recommended for 3 lamp models. 4. HPT8 Ballast required with 28W T8 lamps. 5. Products also available in non-US voltage and frequencies for international markets. 6. Not available when specifying emergencies, voltage must be specified. 7. 2 ballasts are required when specifying 3 or more 28T5 lamps. 8. 1-Lamp ballast in high ballast factor is not available. 9. 1 Lamp step dimming ballast in normal ballast factor not available. 2-lamp ballast will not operate 1 lamp. 10. 1-Lamp ballast in a High Ballast factor not available. 11. .90 ballast factor available for 2 or 3 14W T5 or 28W T5 lamps only. 12. 1-Lamp step dimming ballast in a Normal Ballast factor not available. 2-Lamp ballast will not operate 1-Lamp.

2', 4' or 8', 2 LAMP

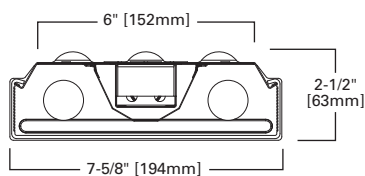

4', 3 LAMP

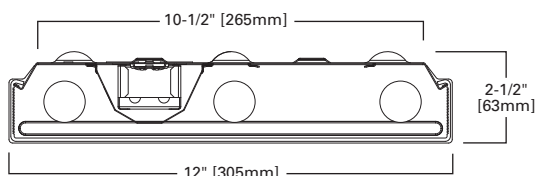

4', 4 LAMP

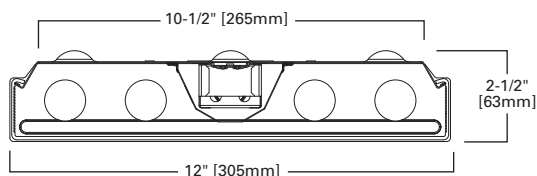

Specifications and dimensions subject to change without notice. Consult your Cooper Lighting Representative or visit www.cooperlighting.com for available options, accessories and ordering information.

SURFACE WRAPAROUND SPECIFICATION GRADE



FEATURES

- Specification wraparound for commercial, school and dormitory spaces
- Steel end plates with 7/8" knockout and light seal embossment
- Ballasts are CBM/ETL Class P and are positively secured to housing
- Multi-stage, iron phosphate pretreatment ensures maximum bonding
- Pressure lock lamp holders, UL and cUL listed
- 100% clear, full-thickness virgin acrylic prismatic refractor
- Internal side linear and bottom pyramidal prisms in lens
- Ballast cover easily removed without tools
- Lens can be hinged from either side in a lift

DIMENSIONS

2', 4', 8'

WS SERIES

Compliances may not apply to all product configurations. Please consult the product spec sheet for compliance details.

COMPLIANCES: UL/cUL Listed, UL/cUL Listed - Damp Location



ORDERING INFORMATION

SAMPLE NUMBER: WS-332A-120V-EB81-U

Tandem	Series ¹	Width	Number of Lamps (Not Included)	Wattage	Lens	Voltage ⁵
8T=8' Length [Blank]=4' Length	WS=Specification Surface Wrap	[Blank]=Standard A=Wide Body for 2 Lamps	2=2 Lamps ² 3=3 Lamps ³ 4=4 Lamps ²	14T5=14W T5 (24") 17=17W T8 (24") 24T5=24W T5HO (24") ⁴ 28T5=28W T5 (48") 32=32W T8 (48") 54T5=54W T5HO (48") ⁴	A=Acrylic Refractor Lens	120V=120 Volt 277V=277 Volt 347V=347 Volt UNV=Universal Voltage 120-277 ⁶
Options		Ballast Type			Number of Ballasts	
EL=Emergency Installed ⁷ GL=Single Element Fuse GM=Double Element Fuse		T5 Ballasts EBT=T5 or T5HO Electronic Program Rapid Start. Total Harmonic Distortion < 10%. Standard Ballast Factor=1.0 Ballast/Factor Type (T5) EBT_H=T5 Electronic Program Rapid Start. Total Harmonic Distortion < 10%. High Ballast Factor=1.15 ⁹ EBT_HDIM=T5 Electronic Program Rapid Start. Total Harmonic Distortion < 10%. Step Dimming, High Ballast Factor = 1.15 ¹⁰ EBT_N=T5 Electronic Program Rapid Start. Total Harmonic Distortion < 10%. Normal Ballast Factor=.90 ⁹ EBT_NDIM=T5 Electronic Program Rapid Start. Total Harmonic Distortion < 10%. Step Dimming, Normal Ballast Factor=.95-1.0 ¹¹ T8 Ballasts EB8=T8 Electronic Start. Total Harmonic Distortion < 10%. EB8_/PLUS=T8 Electronic Start. Total Harmonic Distortion < 10%. High Ballast Factor > 1.15. ER8=T8 Electronic Program Rapid Start. Total Harmonic Distortion < 10%. High Performance T8 Ballasts HB8=T8 Electronic Instant Start. Total Harmonic Distortion < 10%. Standard Ballast Factor .86-.88 HB8_H=T8 Electronic Instant Start. Total Harmonic Distortion < 10%. High Ballast Factor 1.15-1.20 HB8_L=T8 Electronic Instant Start. Total Harmonic Distortion < 10%. Low Ballast Factor .77-.82 HB8_N=T8 Electronic Instant Start. Total Harmonic Distortion < 10%. Normal Ballast Factor 1.0 HR8=T8 Electronic Program Rapid Start. Total Harmonic Distortion < 10%. Standard Ballast Factor .86-.88 HR8_DIM=T8 Electronic Program Rapid Start. Total Harmonic Distortion < 10%. Step Dimming. Ballast Factor .88 HR8_H=T8 Electronic Program Rapid Start. Total Harmonic Distortion < 10%. High Ballast Factor 1.15-1.20 HR8_L=T8 Electronic Program Rapid Start. Total Harmonic Distortion < 10%. Low Ballast Factor .71-.79			1=1 Ballast 2=2 Ballasts 3=3 Ballasts	
Options		Packaging	Accessories (Order Separately)			
PI/CPI=Plug-In Option RIF1=Radio Interference Suppressor RLS=Rotor-Lock Socket (T8 Lamps Only) TILW=Tandem Inline Wiring		U=Unit Pack	A1B/Spacer-U=Spacer 1-1/2" to 2-1/2" from ceiling (Use 2 Per Fixture) SCA=Adjustable 48" Stem Set SCF=Fixed Stem Set (Specify Length) SCS=Swivel Stem Set (Specify Length)			

NOTES: 1. Steel endplates with 7/8" KO standard for continuous row mounting. 2. 2 point suspension recommended for 2 and 4 lamp fixtures. 3. Stem Mounting not available on 3-lamp fixtures. 4. Not for temperatures that exceed 40°C (102°F). 5. Products also available in non-US voltage and frequencies for international markets. 6. Not available when specifying emergencies, voltage must be specified. 7. Not available for 2' version. 8. .90 ballast factor available for 2 or 3 14W T5 or 28W T5 lamps only. 9. 1-Lamp ballast in a High Ballast factor not available. 10. Step Dimming ballast available for 2 or 3 14WT5 or 28W T5 lamps only. 11. 1-Lamp step dimming ballast in a Normal Ballast factor not available. 2-Lamp ballast will not operate 1-Lamp.

2', 4' or 8', 2 LAMP

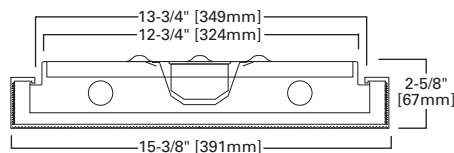

4' or 8', 3 LAMP

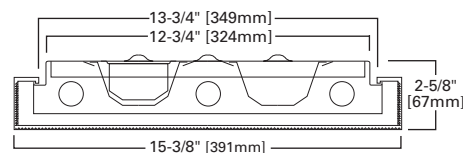

2', 4' or 8', 4 LAMP

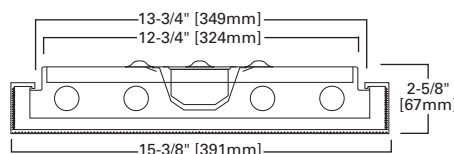

2', 4' or 8', 2 LAMP LTS or HTS

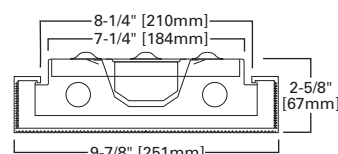

Specifications and dimensions subject to change without notice. Consult your Cooper Lighting Representative or visit www.cooperlighting.com for available options, accessories and ordering information.

FEATURES

- Acrylic lens formulated to protect against lens breakage
- Tuff'R'Puff commercial-grade acrylic lens
- 120V instant-start residential or commercial ballast
- Housing manufactured with die-formed, cold-rolled steel
- Snap-fit for ease of service and re-lamping
- Ideal choice for most residential and commercial applications
- Lamps not included

DIMENSIONS

1' x 4', 1-1/2' x 4'

Compliances may not apply to all product configurations. Please consult the product spec sheet for compliance details.

COMPLIANCES: UL/cUL Listed - Damp Location, ENERGY STAR Qualified



WSC SERIES



ORDERING INFORMATION

SAMPLE NUMBER: WSC-232-D-W-UNV-EB81-U

Series	Number of Lamps	Wattage (Length)	Diffuser/Lens	Frame Finish	Voltage ¹	Options	
WSC=Softside Cloud	2=2 Lamps 4=4 Lamps	32=32W T8 (48") U6T8=32W T8 ("24")	D=Dropped	W=White	120V=120 Volt 277V=277 Volt 347V=347 Volt UNV=Universal Voltage 120-277 ²	EL=Emergency Installed ^{3,4} GL=Single Element Fuse GM=Double Element Fuse	
Ballast Type					Number of Ballast	Options	Packaging
T8 Ballasts EB8_=T8 Electronic Start. Total Harmonic Distortion < 10%. EB8_/PLUS=T8 Electronic Start. Total Harmonic Distortion < 10%. High Ballast Factor > 1.15 ER8_=T8 Electronic Program Rapid Start. Total Harmonic Distortion < 10%. High Performance T8 Ballasts HB8_=T8 Electronic Instant Start. Total Harmonic Distortion < 10%. Standard Ballast Factor = .86 - .88 HB8_H=T8 Electronic Instant Start. Total Harmonic Distortion < 10%. Normal Ballast Factor = 1.15 - 1.20 HB8_L=T8 Electronic Instant Start. Total Harmonic Distortion < 10%. Low Ballast Factor = .77 - .82 HB8_N=T8 Electronic Instant Start. Total Harmonic Distortion < 10%. Normal Ballast Factor = 1.0 HR8_=T8 Electronic Program Rapid Start. Total Harmonic Distortion < 10%. Standard Ballast Factor = .86 - .88 HR8_DIM=T8 Electronic Program Rapid Start. Total Harmonic Distortion < 10%. Step Dimming. Ballast Factor = .88 HR8_H=T8 Electronic Program Rapid Start. Total Harmonic Distortion < 10%. High Ballast Factor = 1.15 - 1.20 HR8_L=T8 Electronic Program Rapid Start. Total Harmonic Distortion < 10%. Low Ballast Factor = .71 - .79					1=1 Ballast 2=2 Ballasts	See Options Section	U=Unit Pack

NOTES: 1. Products also available in non-US voltage and frequencies for international markets. 2. Not available when specifying emergencies, voltage must be specified. 3. Not available for 2' units. 4. A low profile battery pack is required for installation with standard ballast cover (consult Cooper Lighting).

1' x 4', 2 LAMP

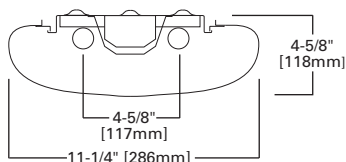

1-1/2' x 4', 4 LAMP

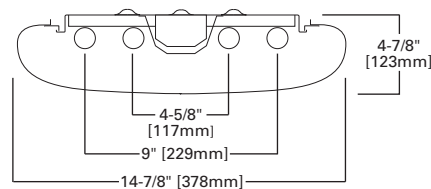

2' x 2', 2 U-LAMPS

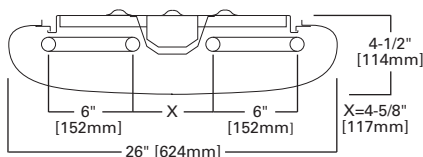

COMMITMENT KIT (CKIT) ACCESSORY



Description

The Contractor Commitment Kit is a supplementary offering intended as an aid for installation and maintenance of Metalux fluorescent fixtures. The kit is comprised of several common lighting accessories to provide the contractor with increased value and convenience. Kit contents include fluorescent lampholders, lamp clips, screws, fasteners and disconnects.

CKIT

KIT CONTENTS

Component Type	Description	Quantity
Access Plate	ACCESS PLATE WITH GRD SCREW	5
Clip	ALIGNER CLIP FOR DIM2/DMF	50
Clip	ALIGNER CLIP FOR IA/IC OR IAF/ICF	50
Clip	LENS FRAME CLIP	50
Disconnect	QUICK DISC 1 CIRCUIT / 2 PORT	25
Fastener	1/4 TURN FASTENER (PLATED)	50
Fastener	SSF/SNF 1/4 TURN FASTNER (PLATED)	100
Hardware	#6 X 3/4 PHILIPS FLAT HEAD, TYPE AB	100
Hardware	#6 X 3/8 PHILIPS FLAT HEAD, TYPE A	100
Hardware	#8 X 1/4 HEX HEAD SLOTTED, TYPE B	100
Hardware	#8-18 X 3/8 SLOTTED HEX HEAD WITH WASHER, TYPE AB, WHITE	100
Hardware	#8-32 X 1/4 SLOT HEAD FOR BALLAST	50
Hardware	#8-32 X 7/16 PHILIPS ROUND HEAD	100
LampHolder	SOCKET RAPID START T5 FEMALE, T8 BASE	10
LampHolder	SOCKET RAPID START T5 MALE, T8 BASE	10
LampHolder	SOCKET RAPID START T5 SHORT WITH NIB	20
LampHolder	SOCKET RAPID START T5 TALL, PIN BASE, SNAP-IN	16
LampHolder	SOCKET T8 INSTANT START FOR HBI, ROTO-LOCK WITH NIB	10
LampHolder	SOCKET T8 INSTANT START MED. ROTO-LOCK WITH NIB	10
LampHolder	SOCKET T8 RAPID START ROTO-LOCK SHORT WITH NIB	10
LampHolder	SOCKET T8 RAPID START MED. ROTO-LOCK WITH NIB	10
L-Clip	LAMP CLIP FOR HORIZONTAL BIAX/PL-L	15
L-Clip	LAMP CLIP FOR VERTICAL BIAX/PL-L LAMP	15
L-Clip	T8 U-LAMP CLIP - STRAIGHT	20
L-Clip	U LAMP CLAMP (LONG) ADJUSTABLE	15

ORDERING INFORMATION

SAMPLE NUMBER: COMMITMENT KIT

COMMITMENT KIT

Customer Commitment Kit

PRODUCT INFORMATION FOR LOUVERS

Brand	Catalog Logic	Size	Description	GC	GC8	GC8FA/RA	GR8/GR5	GCAFA/RA	M/MC ²
Generic	PB1S	1/2" x 1/2" x 1/2" ¹	Small Cell Parabolic, Silver, Styrene	X	X	X	X	X	X
	PB1SA	1/2" x 1/2" x 1/2" ¹	Small Cell Parabolic, Silver, Acrylic	X	X	X	X	X	X
	PB2S	1-1/2" x 1-1/2" x 1"	Medium Cell Parabolic, Silver, Styrene	X	X	X		X	X
	PB2SA	1-1/2" x 1-1/2" x 1"	Medium Cell Parabolic, Silver, Acrylic	X	X	X		X	X
	PB3S	3/4" x 3/4" x 1/2"	Enhanced Efficiency Parabolic, Silver, Styrene	X	X	X		X	X
	PB3SA	3/4" x 3/4" x 1/2"	Enhanced Efficiency Parabolic, Silver, Acrylic	X	X	X		X	X
	PB4S	3" x 3" x 1-1/2"	Large Cell Parabolic, Silver, Styrene	X	X	X		X	X
	PB4SA	3" x 3" x 1-1/2"	Large Cell Parabolic, Silver, Acrylic	X	X	X		X	X
	PB5S	3/4" x 3/4" x 3/8"	High Efficiency Controlled Louver, Silver, Styrene	X	X	X		X	X
	PB5SA	3/4" x 3/4" x 3/8"	High Efficiency Controlled Louver, Silver, Acrylic	X	X	X		X	X
	PL	1/2" x 1/2" x 1/2"	Straight Blade White Louver, Styrene	X	X	X		X	X
	PLA	1/2" x 1/2" x 1/2"	Straight Blade White Louver, Acrylic	X	X	X		X	X
	AL	1/2" x 1/2" x 1/2"	Straight Blade, Mill Finish, Aluminum Louver	X		X		X	X
	ALW	1/2" x 1/2" x 1/2"	Straight Blade, White, Aluminum Louver	X		X		X	X

NOTES: 1. Dimensions are nominal size. 2. For 3-lamp or SMB housing, 1/2" or less shielding thickness only.

PRODUCT INFORMATION FOR LENS³

Brand	Lens	Thickness	GC	GC8	GC8FA/RA	GR8/GR5	GCAFA/RA	M/MC
Generic	A	0.095	X	X	X	X	X	X
	A125	0.125	X	X	X	X	X	X
	AT125	0.125	X	X	X	X	X	X
	A125MIN	.125 min	X	X	X	X	X	X
	AT125MIN	.125 min	X	X	X	X	X	X
	A125/RFI	0.125	X	X	X	X	X	X
	A19/156	0.156	X	X	X	X	X	X
	A19T/156	0.156	X	X	X	X	X	X
	A19/156RFI	0.156	X	X	X	X	X	X
	A12/170	0.170	X				X	X
	A19/187	0.187	X				X	X
	A12/187	0.187	X				X	X
	DA	0.080	X	X	X			X
	DA125	0.125	X	X	X			X
	K12/125	0.125	X	X	X		X	X
	K12/125MIN	.125 min	X	X	X		X	X
	POLY12/125	0.125	X	X	X		X	X
	POLY12/187	0.187	X				X	X
KSH	ACTF140	0.140	X	X	X		X	X
	ACTF187	0.187	X				X	X
	FGW080	0.080	X	X	X		X	X
	FGW125	0.125	X	X	X		X	X
	K12/125	0.125	X	X	X		X	X
	K12/125MIN	.125 min	X	X	X		X	X
	K12/125RFI	0.125	X	X	X		X	X
	A15	0.200	X				X	X
	A19/156	0.156	X	X	X	X	X	X
	A19T/156	0.156	X	X	X		X	X
	A19/156RFI	0.156	X	X	X		X	X
	K12/187	0.187	X				X	X
	A19/187	0.187	X				X	X
	KSH20/140	0.140	X	X	X		X	X
	KSH23/125	0.125	X	X	X		X	X
	KSH3E	0.150	X	X	X		X	X
KSH32	0.130	X	X	X		X	X	
PSI	PSA4/RFI	variable	X				X	X
	P35	0.170	X				X	X

NOTES: Inverted Lens - For inverted lens add "INV" to lens description. (Not available for GR8/GR5). 3. For additional lens options consult factory.

Specifications and dimensions subject to change without notice. Consult your Cooper Lighting Representative or visit www.cooperlighting.com for available options, accessories and ordering information.

GR8, GC8, GC SERIES - NON-FLOATING DOOR ASSEMBLIES

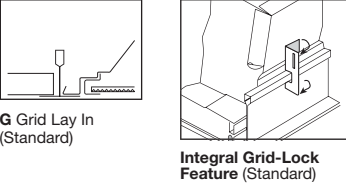
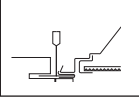
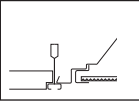
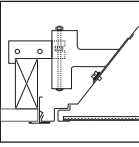
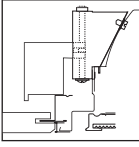
Type "G" Fixture																													
<p>(Exposed Grid)</p>  <p>G Grid Lay In (Standard)</p> <p>Integral Grid-Lock Feature (Standard)</p>	<p>A Recessed Luminaire with Narrow Flanges designed to rest on exposed 15/16" or 9/16" wide Inverted Grid Tees.</p> <ul style="list-style-type: none"> • Fixture Example: 2GR8-432-UNV-EB81-U 																												
<p>(Concealed T)</p>  <p>G Concealed T</p>	<p>A Recessed Luminaire with Narrow Flanges designed to rest on 15/16" wide Concealed Inverted Grid Tees</p> <ul style="list-style-type: none"> • Fixture Example 2EP3GAX-332S36I • Optional Aluminum TK Trim Kit Available – Available TK Trim Finishes: Natural Anodized Aluminum (N) Standard and Baked White Enamel (W) <table border="1" data-bbox="1223 430 1510 556"> <thead> <tr> <th colspan="2">TK TRIM KIT</th> </tr> </thead> <tbody> <tr> <td>TK-14N-U</td> <td>1' x 4'</td> </tr> <tr> <td>TK-22N-U</td> <td>2' x 2'</td> </tr> <tr> <td>TK-24N-U</td> <td>2' x 4'</td> </tr> </tbody> </table>	TK TRIM KIT		TK-14N-U	1' x 4'	TK-22N-U	2' x 2'	TK-24N-U	2' x 4'																				
TK TRIM KIT																													
TK-14N-U	1' x 4'																												
TK-22N-U	2' x 2'																												
TK-24N-U	2' x 4'																												
<p>(Slot Grid)</p>  <p>G Slot Grid</p>	<p>A Recessed Luminaire designed to rest on 9/16" Slot T Grid</p> <ul style="list-style-type: none"> • Fixture Example: 2GR8-432 • T-Bar Safety Clips Required 																												
Type "F" Fixture																													
<p>(Flange Trim)</p>  <p>F Flange Trim</p>	<p>For factory installed flange, replace "G" in fixture trim description with "F". Factory installed flange available on GC8 and GC only, field installed kits are available for all other models and are listed below.</p> <p>A Recessed Luminaire with Horizontal Steel or Aluminum (A) Flanges which conceal the edges of the ceiling opening</p> <ul style="list-style-type: none"> • Fixture example 2FC8-332 • Adjustable Swing Gates for mounting • Optional Flange Kit available – Field Convertible, Converts Grid Fixture (G) to Flange Fixture (F) – Standard Flange Trim Finish: Baked White Enamel (W) • Typical fixture ceiling opening requirements: Single – (Width) One-quarter Inch (1/4") plus nominal width, (Length) 1/4" plus nominal length. • Rows - fixture quantity times fixture length plus 1/4". • Plaster Frames available, see options and accessories section <p>FLANGE KITS (Field Installed)</p> <table border="1" data-bbox="564 1207 1510 1449"> <thead> <tr> <th>Fixture</th> <th>Fixture Size</th> <th>Flange Kit</th> <th>Ceiling Opening Size</th> </tr> </thead> <tbody> <tr> <td>GR8/GC8/GR5</td> <td>1' x 4'</td> <td>FCS-14W-U (Steel)</td> <td>12-1/4" x 48-1/4"</td> </tr> <tr> <td>GC</td> <td>1' x 4'</td> <td>F2-14W-U (Steel)</td> <td>12-1/4" x 48-1/4"</td> </tr> <tr> <td>GC</td> <td>20" x 24"</td> <td>F2-2024W-U (Steel)</td> <td>20-1/4" x 24-1/4"</td> </tr> <tr> <td>GR8/GC8/GR5</td> <td>2' x 2'</td> <td>FCTKA-22W-U</td> <td>24-1/4" x 24-1/4"</td> </tr> <tr> <td>GC</td> <td>20" x 48"</td> <td>F2-28W-U (Steel)</td> <td>20-1/4" x 48-1/4"</td> </tr> <tr> <td>GR8/GC8/GR5</td> <td>2' x 4'</td> <td>FCTKA-24W-U</td> <td>24-1/4" x 48-1/4"</td> </tr> </tbody> </table>	Fixture	Fixture Size	Flange Kit	Ceiling Opening Size	GR8/GC8/GR5	1' x 4'	FCS-14W-U (Steel)	12-1/4" x 48-1/4"	GC	1' x 4'	F2-14W-U (Steel)	12-1/4" x 48-1/4"	GC	20" x 24"	F2-2024W-U (Steel)	20-1/4" x 24-1/4"	GR8/GC8/GR5	2' x 2'	FCTKA-22W-U	24-1/4" x 24-1/4"	GC	20" x 48"	F2-28W-U (Steel)	20-1/4" x 48-1/4"	GR8/GC8/GR5	2' x 4'	FCTKA-24W-U	24-1/4" x 48-1/4"
Fixture	Fixture Size	Flange Kit	Ceiling Opening Size																										
GR8/GC8/GR5	1' x 4'	FCS-14W-U (Steel)	12-1/4" x 48-1/4"																										
GC	1' x 4'	F2-14W-U (Steel)	12-1/4" x 48-1/4"																										
GC	20" x 24"	F2-2024W-U (Steel)	20-1/4" x 24-1/4"																										
GR8/GC8/GR5	2' x 2'	FCTKA-22W-U	24-1/4" x 24-1/4"																										
GC	20" x 48"	F2-28W-U (Steel)	20-1/4" x 48-1/4"																										
GR8/GC8/GR5	2' x 4'	FCTKA-24W-U	24-1/4" x 48-1/4"																										
Type "MZ" Fixture (GC Only)																													
<p>(Modular Trim / Aluminum)</p>  <p>MZ Modular Trim / Aluminum</p> <p>Concealed "T" Metal Pan and Concealed "Z" Spline Application</p>	<p>A Recessed Luminaire Trimmed to a Modular / Concealed Finished Dimension</p> <ul style="list-style-type: none"> • Fixture example: 2MZC-332 (complete fixture / factory installed trim) • On complete ordered fixture, Modular MZ Trim matches door frame assembly unless otherwise specified • Adjustable Swing Gates for mounting • Optional Aluminum Modular (MZ) Trim Kit available – Field Convertible, converts Grid Fixture (G) to Modular Fixture (MZ) – Available Aluminum Trim Finishes: Baked White Enamel (W) and Natural Anodized Aluminum (N) • For Concealed "T" and Concealed "Z" the main ceiling carries must be on the sides of the Luminaire. The weight of the Luminaire exists on the Swing-Gates and must be supported by main carriers, not cross members. At each end of the luminaire, an Angle Spline must be used, Cross or Main T's cannot be used. <table border="1" data-bbox="1223 1543 1510 1732"> <thead> <tr> <th colspan="2">MODULAR / MZ TRIM KIT / ALUMINUM</th> </tr> </thead> <tbody> <tr> <td>F2MZ/E-14W-U</td> <td>1' x 4'</td> </tr> <tr> <td>F2MZ/E-22W-U</td> <td>2' x 2'</td> </tr> <tr> <td>F2MZ/E-24W-U</td> <td>2' x 4'</td> </tr> <tr> <td>F2MZ/E-28W-U</td> <td>20" x 48"</td> </tr> </tbody> </table>	MODULAR / MZ TRIM KIT / ALUMINUM		F2MZ/E-14W-U	1' x 4'	F2MZ/E-22W-U	2' x 2'	F2MZ/E-24W-U	2' x 4'	F2MZ/E-28W-U	20" x 48"																		
MODULAR / MZ TRIM KIT / ALUMINUM																													
F2MZ/E-14W-U	1' x 4'																												
F2MZ/E-22W-U	2' x 2'																												
F2MZ/E-24W-U	2' x 4'																												
F2MZ/E-28W-U	20" x 48"																												

Specifications and dimensions subject to change without notice. Consult your Cooper Lighting Representative or visit www.cooperlighting.com for available options, accessories and ordering information.

PARALUX II, III, IV, V SERIES – FLOATING LOUVER ASSEMBLIES

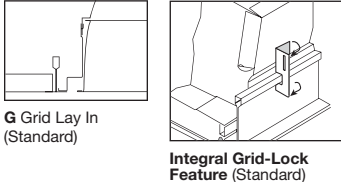
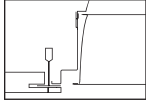
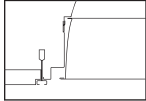
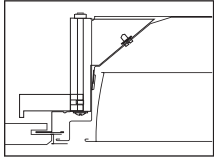
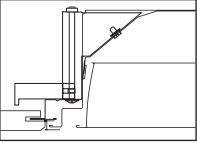
Type "G" Fixture																																																	
<p>(Exposed Grid)</p>  <p>G Grid Lay In (Standard)</p> <p>Integral Grid-Lock Feature (Standard)</p>	<p>A Recessed Luminaire with Narrow Flanges designed to rest on exposed 15/16" or 9/16" wide Inverted Grid Tees.</p> <ul style="list-style-type: none"> • Fixture example: 2P2GX-332S36I 																																																
<p>(Concealed T)</p>  <p>T Concealed T</p>	<p>A Recessed Luminaire with Narrow Flanges designed to rest on 15/16" wide Concealed Inverted Grid Tees</p> <ul style="list-style-type: none"> • Fixture Example 2EP3GX-332S36I • Optional TK Trim Kit available – Available TK trim finishes: Natural Anodized Aluminum (N) standard and Baked White Enamel (W) <table border="1" style="float: right; margin-top: 10px;"> <thead> <tr> <th colspan="2" style="text-align: left;">TK TRIM KIT</th> </tr> </thead> <tbody> <tr> <td>TK-14N-U</td> <td>1' x 4'</td> </tr> <tr> <td>TK-22N-U</td> <td>2' x 2'</td> </tr> <tr> <td>TK-24N-U</td> <td>2' x 4'</td> </tr> </tbody> </table>	TK TRIM KIT		TK-14N-U	1' x 4'	TK-22N-U	2' x 2'	TK-24N-U	2' x 4'																																								
TK TRIM KIT																																																	
TK-14N-U	1' x 4'																																																
TK-22N-U	2' x 2'																																																
TK-24N-U	2' x 4'																																																
<p>(Slot Grid)</p>  <p>G Slot Grid</p>	<p>A Recessed Luminaire designed to rest on 9/16" Slot-T Grid</p> <ul style="list-style-type: none"> • Fixture example: 2EP3GAX-332S36I • T-Bar Safety Clips required • Face of luminaire/door assembly is recessed about 5/16" into ceiling 																																																
Type "F" Fixture																																																	
<p>(Flange)</p>  <p>F Aluminum Flange Trim with Supporting Swing Gates</p>	<p>A Recessed Luminaire with Horizontal Steel or Mitered Aluminum (M) Flanges which conceal the edges of the ceiling opening</p> <ul style="list-style-type: none"> • Complete fixture / factory installed trim. Fixture example: 2EP3FX-332S36I • Adjustable Swing Gates for mounting • Field installed Flange Kit available – Field Convertible, Converts Grid Fixture (G) to Flange Fixture (F) – Standard Flange Trim finish: Baked White Enamel (W) • Typical fixture ceiling opening requirements: Single – (Width) One-quarter Inch (1/4") plus nominal width, (length) 1/4" plus nominal length. • Rows - fixture quantity times fixture length plus 1/4". • Plaster frames available, see options and accessories section <p style="text-align: center;">FLANGE KITS (Steel) (Field Installed)</p> <table border="1" style="width: 100%; border-collapse: collapse;"> <thead> <tr> <th style="background-color: #0070C0; color: white;">Fixture</th> <th style="background-color: #0070C0; color: white;">Fixture Size</th> <th style="background-color: #0070C0; color: white;">Flange Kit</th> <th style="background-color: #0070C0; color: white;">Ceiling Opening Size</th> </tr> </thead> <tbody> <tr> <td>EP3, P4, P5</td> <td>1' x 2'</td> <td>F3/4-12W-U (steel)</td> <td>12-1/4" x 24-1/4"</td> </tr> <tr> <td>EP3, P4, P5</td> <td>1' x 4'</td> <td>F3/4M-14W-U</td> <td>12-1/4" x 48-1/4"</td> </tr> <tr> <td>P2</td> <td>1' x 4'</td> <td>F2M-14S-W-U</td> <td>12-1/4" x 48-1/4"</td> </tr> <tr> <td>EP3, P4, P5</td> <td>20" x 24"</td> <td>F3/4-2024W-U (steel)</td> <td>20-1/4" x 24-1/4"</td> </tr> <tr> <td>P2</td> <td>20" x 24"</td> <td>F2-2024W-U (steel)</td> <td>20-1/4" x 24-1/4"</td> </tr> <tr> <td>P4, P5</td> <td>2' x 2'</td> <td>F4/5M-22S-W-U</td> <td>24-1/4" x 24-1/4"</td> </tr> <tr> <td>P2, EP3</td> <td>2' x 2'</td> <td>F2/3M-22S-W-U</td> <td>24-1/4" x 24-1/4"</td> </tr> <tr> <td>EP3, P4, P5</td> <td>20" x 48"</td> <td>F3/4-28W-U (steel)</td> <td>20-1/4" x 48-1/4"</td> </tr> <tr> <td>P2</td> <td>20" x 48"</td> <td>F2-28W-U (steel)</td> <td>20-1/4" x 48-1/4"</td> </tr> <tr> <td>P4, P5</td> <td>2' x 4'</td> <td>F4/5M-24S-W-U</td> <td>24-1/4" x 48-1/4"</td> </tr> <tr> <td>P2, EP3</td> <td>2' x 4'</td> <td>F2/3M-24S-W-U</td> <td>24-1/4" x 48-1/4"</td> </tr> </tbody> </table>	Fixture	Fixture Size	Flange Kit	Ceiling Opening Size	EP3, P4, P5	1' x 2'	F3/4-12W-U (steel)	12-1/4" x 24-1/4"	EP3, P4, P5	1' x 4'	F3/4M-14W-U	12-1/4" x 48-1/4"	P2	1' x 4'	F2M-14S-W-U	12-1/4" x 48-1/4"	EP3, P4, P5	20" x 24"	F3/4-2024W-U (steel)	20-1/4" x 24-1/4"	P2	20" x 24"	F2-2024W-U (steel)	20-1/4" x 24-1/4"	P4, P5	2' x 2'	F4/5M-22S-W-U	24-1/4" x 24-1/4"	P2, EP3	2' x 2'	F2/3M-22S-W-U	24-1/4" x 24-1/4"	EP3, P4, P5	20" x 48"	F3/4-28W-U (steel)	20-1/4" x 48-1/4"	P2	20" x 48"	F2-28W-U (steel)	20-1/4" x 48-1/4"	P4, P5	2' x 4'	F4/5M-24S-W-U	24-1/4" x 48-1/4"	P2, EP3	2' x 4'	F2/3M-24S-W-U	24-1/4" x 48-1/4"
Fixture	Fixture Size	Flange Kit	Ceiling Opening Size																																														
EP3, P4, P5	1' x 2'	F3/4-12W-U (steel)	12-1/4" x 24-1/4"																																														
EP3, P4, P5	1' x 4'	F3/4M-14W-U	12-1/4" x 48-1/4"																																														
P2	1' x 4'	F2M-14S-W-U	12-1/4" x 48-1/4"																																														
EP3, P4, P5	20" x 24"	F3/4-2024W-U (steel)	20-1/4" x 24-1/4"																																														
P2	20" x 24"	F2-2024W-U (steel)	20-1/4" x 24-1/4"																																														
P4, P5	2' x 2'	F4/5M-22S-W-U	24-1/4" x 24-1/4"																																														
P2, EP3	2' x 2'	F2/3M-22S-W-U	24-1/4" x 24-1/4"																																														
EP3, P4, P5	20" x 48"	F3/4-28W-U (steel)	20-1/4" x 48-1/4"																																														
P2	20" x 48"	F2-28W-U (steel)	20-1/4" x 48-1/4"																																														
P4, P5	2' x 4'	F4/5M-24S-W-U	24-1/4" x 48-1/4"																																														
P2, EP3	2' x 4'	F2/3M-24S-W-U	24-1/4" x 48-1/4"																																														
Type "MZ" (Fixture 2", 3", 4", 5" Parabolics)																																																	
<p>(Modular Trim / Aluminum)</p>  <p>MZ Modular Trim with Supporting Swing Gates</p> <p>Concealed "T" Metal Pan and Concealed "Z" Spline Application</p>	<p>A Recessed Luminaire trimmed to a Modular / Concealed finished dimension</p> <ul style="list-style-type: none"> • Complete fixture / factory installed trim Fixture example: 2MZC-332S38I • On complete ordered fixture, Modular MZ Trim matches door frame assembly unless otherwise specified • Adjustable Swing Gates for mounting • Optional Aluminum Modular (MZ) Trim Kit available – Field Convertible, Converts Grid Fixture (G) to Modular Fixture (MZ) – Available Aluminum Trim Finishes: Baked White Enamel (W) and Natural Anodized Aluminum (N) • For Concealed "T" and Concealed "Z" the main ceiling carries must be on the sides of the Luminaire. The weight of the luminaire exists on the Swing-Gates and must be supported by main carriers, not cross members. At each end of the luminaire, an Angle Spline must be used, Cross or Main T's cannot be used. <table border="1" style="float: right; margin-top: 10px;"> <thead> <tr> <th colspan="3" style="text-align: left;">MODULAR / MZ TRIM KIT / ALUMINUM</th> </tr> <tr> <th style="background-color: #0070C0; color: white;">Fixture</th> <th style="background-color: #0070C0; color: white;">Flange Kit</th> <th style="background-color: #0070C0; color: white;">Fixture Size</th> </tr> </thead> <tbody> <tr> <td>EP3, P4, P5</td> <td>F3/4MZ-14W-U</td> <td>1' x 4'</td> </tr> <tr> <td>P2</td> <td>F2MZ-14-W-U</td> <td>1' x 4'</td> </tr> <tr> <td>P4, P5</td> <td>F4/5MZ/E-22W-U</td> <td>2' x 2'</td> </tr> <tr> <td>EP3, P2</td> <td>F2/3MZ/E-22W-U</td> <td>2' x 2'</td> </tr> <tr> <td>P4, P5</td> <td>F4/5MZ/E-24W-U</td> <td>2' x 4'</td> </tr> <tr> <td>EP3, P2</td> <td>F2/3MZ/E-24W-U</td> <td>2' x 4'</td> </tr> </tbody> </table>	MODULAR / MZ TRIM KIT / ALUMINUM			Fixture	Flange Kit	Fixture Size	EP3, P4, P5	F3/4MZ-14W-U	1' x 4'	P2	F2MZ-14-W-U	1' x 4'	P4, P5	F4/5MZ/E-22W-U	2' x 2'	EP3, P2	F2/3MZ/E-22W-U	2' x 2'	P4, P5	F4/5MZ/E-24W-U	2' x 4'	EP3, P2	F2/3MZ/E-24W-U	2' x 4'																								
MODULAR / MZ TRIM KIT / ALUMINUM																																																	
Fixture	Flange Kit	Fixture Size																																															
EP3, P4, P5	F3/4MZ-14W-U	1' x 4'																																															
P2	F2MZ-14-W-U	1' x 4'																																															
P4, P5	F4/5MZ/E-22W-U	2' x 2'																																															
EP3, P2	F2/3MZ/E-22W-U	2' x 2'																																															
P4, P5	F4/5MZ/E-24W-U	2' x 4'																																															
EP3, P2	F2/3MZ/E-24W-U	2' x 4'																																															

Specifications and dimensions subject to change without notice. Consult your Cooper Lighting Representative or visit www.cooperlighting.com for available options, accessories and ordering information.

DRYWALL FRAMING KIT (DF) SERIES



FEATURES

- Individual modular frame unit
- Nominal 1-1/2" frame depth
- Side and end rails of extruded aluminum
- Offset toleranced corner fasteners
- Painted after fabrication
- Available in satin anodized or baked white enamel finish
- Individual row mount with center mullion support (DFR Series)
- Uninterrupted continuous row (DFC Series). Available for RCC fixtures only
- DF, DFC and DFR Series add 3/16" to nominal width of fixture used. Add 1/4" to nominal length of each fixture used for DF and DFR, add 1/4" to total length of all fixtures for DFC.

DF SERIES

Description

The **DF Drywall Frame Kit Series** features a modular framing unit that will trim out an opening in a drywall ceiling. This opening will resemble a modular grid ceiling when installed. The kits are field assembled and installed into the drywall ceiling independent of the luminaire. The Drywall Frame Kit enables the contractor or end user to frame out a modular opening and install a choice of any standard modular recessed luminaire. The ease of installation feature makes the Framing Kit a good choice for the commercial, residential and architectural market.

The **DF Series** is available in all popular modular sizes to fit any lay-in fixture to include: 1' x 2', 2' x 4', 2' x 2', 1' x 4', 1' x 8', 20" x 24", 20" x 48", 10" x 2' and 10" x 4'.

The **DFR Series** is a modular framing unit for row mounting luminaires with a center mullion support for trimming out an opening in drywall ceilings. The DFR Series is available in all popular modular sizes to fit any lay-in fixture to include: 1' x 2', 2' x 4', 2' x 2', 1' x 4', 1' x 8', 20" x 24", 20" x 48", 10" x 2' and 10" x 4'.

The **DFC Series** is a continuous row uninterrupted modular framing unit with no Cross T supports. It is used for trimming out an opening in drywall ceilings to install continuous row luminaires. The DFC Series is available in Twelve Inch (12") widths. For continuous row RCC luminaires only.

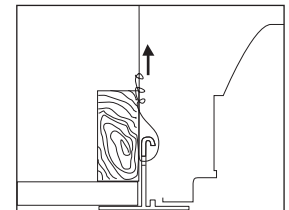

ORDERING INFORMATION

SAMPLE NUMBER: DF-102-W

<p>Series DF=Framing Kit DFR=Framing Kit Support/Center Mullion DFC=Framing Kit Continuous ¹</p>	<p>Application (Leave Blank For DF Series) E=End of Row R=Middle of Row</p>	<p>Width 10=Ten Inch (10") (Not Available on DFC Series) 1=One Foot (1') 20=Twenty Inches (20") (Not Available on DFC Series) 2=Two Feet (2') (Not Available on DFC Series) 4=Four Feet (4') (Not Available on DFC Series)</p>	<p>Length 2=Two Feet (2' Nominal) 4=Four Feet (4' Nominal) 6=Six Feet (6' Nominal) 8=Eight Feet (8' Nominal)</p>	<p>Finish N=Satin Anodized Aluminum W=Baked White Enamel</p>
--	---	---	---	---

PRODUCT INFORMATION

Catalog Number	Nominal Luminaire Size (Inches)	Ceiling Opening Size (Inches) (Width x Length)
DF-12-W	1' x 2'	12-3/16" x 24-1/4"
DF-14-W	1' x 4'	12-3/16" x 48-1/4"
DF-18-W ²	1' x 8'	12-3/16" x 96-1/4"
DF-22-W	2' x 2'	24-3/16" x 24-1/4"
DF-24-W	2' x 4'	24-3/16" x 48-1/4"
DF-2024-W	20" x 24"	20-3/16" x 24-1/4"
DF-2048-W	20" x 48"	20-3/16" x 48-1/4"
DF-102-W ³	10" x 2'	10-3/16" x 24-1/4"
DF-104-W ³	10" x 4'	10-3/16" x 48-1/4"
DFR-12-W	1' x 2'	12-3/16" + 1/4" added to each fixture length
DFR-14-W	1' x 4'	12-3/16" + 1/4" added to each fixture length
DFR-18-W ²	1' x 8'	12-3/16" + 1/4" added to each fixture length
DFR-22-W	2' x 2'	24-3/16" + 1/4" added to each fixture length
DFR-24-W	2' x 4'	24-3/16" + 1/4" added to each fixture length
DFR-2024-W	20" x 24"	20-3/16" + 1/4" added to each fixture length
DFR-2048-W	20" x 48"	20-3/16" + 1/4" added to each fixture length
DFR-102-W ³	10" x 2'	10-3/16" + 1/4" added to each fixture length
DFR-104-W ³	10" x 4'	10-3/16" + 1/4" added to each fixture length
DFC-12-W	1' x 2'	12-3/16" + 1/4" added to total fixture length
DFC-14-W	1' x 4'	12-3/16" + 1/4" added to total fixture length
DFC-18-W ¹	1' x 8'	12-3/16" + 1/4" added to total fixture length

NOTES: 1. For use with RCC fixtures only. 2. For use with RCG fixtures only. 3. For use with RWW fixtures only.

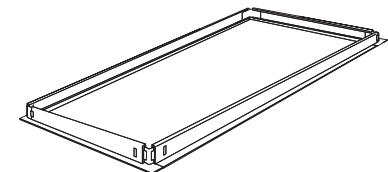

DF Series

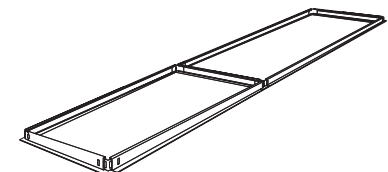

DFR Series

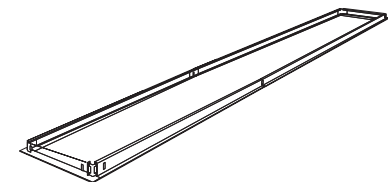



DFC Series

Specifications and dimensions subject to change without notice. Consult your Cooper Lighting Representative or visit www.cooperlighting.com for available options, accessories and ordering information.

STANDARD PRODUCT OPTIONS AND ACCESSORIES

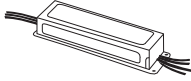
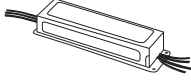
ELECTRICAL

	Designation	Description
 <p>Ballasts</p>		Refer to product spec sheets for ballast options.
 <p>Emergency Lighting</p> <p>(for additional lamp lumen performance refer to Sure-Lites spec sheet)</p>	EL4 (350-500 lumens) Two Foot (2') - Four Foot (4') RS, SL, and Compact	Self-contained, operates one lamp at emergency levels for 90 minutes upon power loss (120V or 277V). For Dry Locations Only
	EL8 (600-700 lumens) Two Foot (2') - Eight Foot (8') RS, SL, HO and Compact	
	EL5 (up to 700 lumens) Two Foot (2') - Four Foot (4') T5	
	EL5HO (up to 600 lumens) Two Foot (2') - Four Foot (4') T5HO	
	EL14 (600 to 1400 lumens) Three Foot (3') - Eight Foot (8') RS, SL and HO; Two Foot (2') - Four Foot (4') T5 and T5HO	
 <p>Fusing (Internal or External)</p>	GL	Single Element (Fast Blow) Fuse
	GM	Double Element (Slow Blow) Fuse
 <p>Radio Interference Suppressor</p>	RIF-1 (Suppressor-Advance)	Inductive capacitor circuit to minimize interference from line radiation or feedback.
<p>Night Lights (Parabolic, Recessed and Surface only)</p>	PL	Compact lamp fluorescent night light (5, 7, 9 or 13 Watt lamp, specify voltage 120V or 277V). Example: PL-13/120V



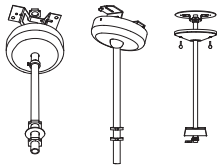
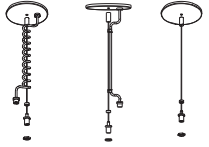

MOUNTING

Suspension Sets	Designation	Ordering Information	
<p>Stem Sets</p>  <p>SCF SCS SCA</p>	SCF-XX-B Fixed Stem Set	<div style="display: flex; justify-content: space-around; align-items: flex-start;"> <div style="border: 1px solid black; padding: 5px; text-align: center;"> <p>CCF</p> <p>Type of Kit CCA=Adjustable Cable Kit CCF=Fixed Length Cable Kit</p> </div> <div style="border: 1px solid black; padding: 5px; text-align: center;"> <p>18</p> <p>Length of Cable <u>Fixed Length</u> 12=12" long 15=15" long 18=18" long 21=21" long 24=24" long 27=27" long 48=48" long <u>Adjustable</u> 120=120" long</p> </div> <div style="border: 1px solid black; padding: 5px; text-align: center;"> <p>NPF</p> <p>Configuration NPF=Non Power Feed PFS=Straight Cord Power PFC=Curly Cord Power Feed</p> </div> </div>	
	SCS-XX-B (Deep Canopy, 3/8" stem, 5/8" Outside Diameter) XX =Length 6", 8", 12", 24", 36", 48", 60", 72"		Swivel Stem Set
	SCA-48-B		Field cutable Stem Set (1/4" IPS Stem, 1/2" O.D.)
	Used with all surface fixtures as stem sets. SCS stems have forty-five degree (45°) swivel, one direction. One set consists of one (1) stem assembly. Minimum of two (2) sets required per fixture. NOTE: Coupler, three-eighths inch (3/8") IPS Pipe Coupler to join lengths. Coupler is standard baked white enamel or special order of black.		
<p>Cable Sets</p>  <p>CCA PFC CCA PFS CCA NPF</p>	CCA-XX-PFC-C CCA=Adjustable Cable (XX=48" or 120")		
	CCA-XX-PFS-U		CCF=Fixed Cable (XX=12", 15", 18", 21", 24", or 27")
	CCA-XX-NPF-U		PFC=Power Feed, Coil Power Cord
	CCF-XX-PFC		PFS=Power Feed, Straight Power Cord
	CCF-XX-PFS		NPF=Non-Power Feed
	CCF-XX-NPF		NOTE: Coupler, Three-eighths inch (3/8") IPS Pipe Coupler to join lengths. Coupler is standard baked white enamel or special order of black.

Specifications and dimensions subject to change without notice. Consult your Cooper Lighting Representative or visit www.cooperlighting.com for available options, accessories and ordering information.

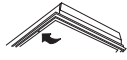
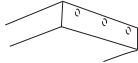
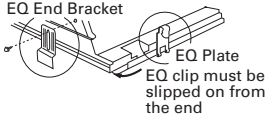
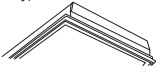
PARABOLIC, RECESSED AND SURFACE

MISCELLANEOUS





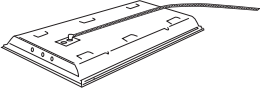
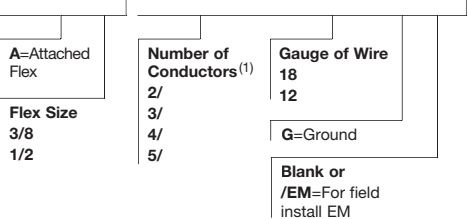
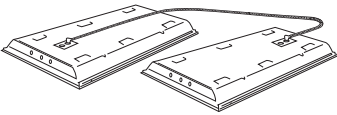
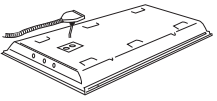

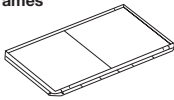
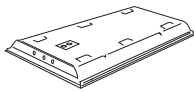

	Designation	Description
Vandal Resistant Door (GC only) 	VRS	Flat doors only. Frame secured with four (4) or six (6/VRS) torx head with center pin head screws. (No latches)
End Knockouts (M, MC and SA Series) 	EKO	7/8" KO's in end of fixture housing. Number of KO's and location varies by fixture type.
T-Bar Safety Clips (U.L. Listed 912Y and E61165)  <p>EQ End Bracket EQ Plate EQ clip must be slipped on from the end</p>	EQ-CLIP-U (Black)	UL approved safety clips used to secure recessed troffers to T-bar. EQ clips used on fixture sides. Order four (4) per fixture
	EQ-CLIP-WH (White)	
	T3A END E.Q. BRACKET PARTS BAG	EQ clips for use on fixture ends. Comes with four (4) screws and four (4) brackets.
Optional Painted And Natural Door Frames (GC only) 	Blank - (White Door Frame) Standard	Baked enamel finish
	BDF - (Black Door Frame)	Baked enamel finish
	FA, RA, FAN, RAN, FAB, RAB	See spec sheets for aluminum door finish
Heat Removal Dampers Note: Parabolic troffers only 	HRD  C=Closed O=Open	Used on heat removal luminaires to adjust or close off air flow through the housings. (See fixture catalog page for series ordering information).
Air Pattern Control Vanes 	AV	Adjustable air pattern control vanes to adjust or direct air flow on Air Supply/Air Return Troffers. (See fixture catalog page for series ordering information)
Lamps, Furnished/Installed		See Troffer Lamp Options Page
Paralux Louver Finishes 	I =Semi-Specular/Low Iridescent	Louver formed of "Low Iridescent" aluminum incorporating an oxide coating which counteracts the iridescent effect/rainbowing
	MI =Specular, Mirrored/Low Iridescent	Louver formed of specular anodized aluminum. Finish is anodic oxide coating. (See fixture catalog pages for additional ordering information)
	P =White	Louver formed from white pre-painted aluminum.

WIRING

	Ordering Information	Description
	SAMPLE NUMBER: A3/8-2/18G  <p> A=Attached Flex Flex Size 3/8 1/2 Number of Conductors⁽¹⁾ 2/ 3/ 4/ 5/ Gauge of Wire 18 12 G=Ground Blank or /EM=For field install EM </p> <p>NOTES: 1. For fixtures with emergencies, extra conductor must be added to accommodate hot lead for EM.</p>	3/8" factory prewired flex wired into fixture access plate. Various wire gauges and number of wires available. Six foot (6') lengths only. The Flex set consists of the following: <ul style="list-style-type: none"> • One wago connector per wire • Six feet (6') of steel flex • Eighteen (18) gauge TFN wire, seven (7') foot leads, exposing six inches (6") out of each end • One ninety degree (90°) flex connector • One straight-in flex connector • One access plate
Master/Satellite 		Labor Saving tandem wiring system. Both installation and energy efficient. (See Master/Satellite Concept page or consult Pre-Sales Technical Support for additional information.)
Modular Wiring Systems 		Component wiring system, provides cost and labor saving alternative to conventional hardwiring. Uses interchangeable modular components. Offers portability and versatility in lighting configurations. (See MWS Section or consult Pre-Sales Technical Support for additional ordering information.)

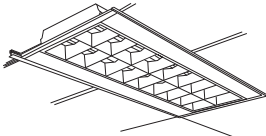
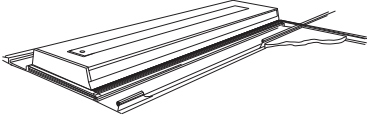
Specifications and dimensions subject to change without notice. Consult your Cooper Lighting Representative or visit www.cooperlighting.com for available options, accessories and ordering information.

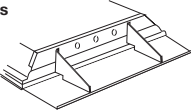
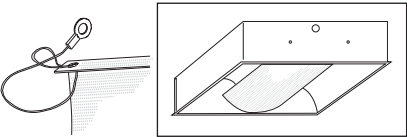
MISCELLANEOUS

	Designation	Description
Plaster Frames 	95-PF-14-U (1x4)	Heavy Gauge Metal Construction for new construction plaster ceiling. Used with Flanged Recessed Fixtures (Intended to serve as a plaster stop only, not to fit into an opening).
	95-PF-22-U (2x2)	
	95-PF-24-U (2x4)	
Rated Construction 	FR Example: 2GC-332A-UNV-EB81-FR-U	Fixture Classification for Fire Rated Ceiling Fixture is FR labeled "SUITABLE FOR INSTALLATION IN FIRE RATED CEILINGS" when applied in conformance with the designs specified in the "Underwriters Laboratories Fire Resistance Directory".
	IC Example: 2GR8IC-332A-UNV-EB81-U	Fixture Classification for Insulated Ceiling Fixture is IC labeled "SUITABLE FOR DIRECT CONTACT TO INSULATION". Refer to www.cooperlighting.com for available fixtures.
Fixture Gasketing    <p>Note: G2 and G3 gasket options are only available on GC fixtures (aluminum) or GC8 fixtures using aluminum frames.</p> <p>Gasketing availability: GC/GC8. No HR, air or louvers. (Lens minimum and maximum = 0.125)</p>	G1	Neoprene gasket between door frame and fixture housing.
	G2	G1 gasketing plus vinyl gasketing between lens and door frame.
	G3	G1 and G2 gasketing plus neoprene gasketing on mounting surface of fixture trim. (Grid or Flange). Field installed.
Side Filler Panel 	SFP-4FT-B 	Heavy gauge side filler panels for 20" x 48" fixture for use in a 2' x 4' ceiling installation. (Baked white finish/two (2) per set).
Spacer 	A-1-B/SPACER-B	Spaces fixture one and one-half inch (1-1/2") to two and one-half inches (2-1/2") from ceiling. (Use with all strips and industrials)
End Fillers 	12-EFS-B (1x2, 1x4)	Six Inch (6") Heavy gauge end fillers. Use two (2) per fixture. End fillers lay on T-bars and are held in place by fixtures but are not attached.
	20-EFS-B (20x48)	
	24-EFS-B (2x2, 2x4)	
End Support Brackets	ESS-B	Heavy gauge end support brackets. Four (4) per fixture are required when fixtures are supported from ends. Must be used with fixture that has a modified end plate (MEP).
Ovation Shield Cable Option  <p>Example: (Center Mount) 2RDI-2BX40RP-120V-EB51-LSC (Side Mount) 2RDI-2BX40RP-120V-EB51-LSCS</p>	LSC Center Mount	The lamp shield cable (LSC) is a factory option available for any and all Ovation products. For center mount Ovation models, use the LSC option. For side-mount, use the LSCS option. Ovation products specified with this option ship with a parts bag that contains the safety lanyards, clear rubber "caps" and instruction sheet.
	LSCS Side Mount	
Palletizing 	PAL	Un-cartoned fixtures secured by corrugated end cap protectors and heavy gauge stretch wrap. Fast and efficient handling.
	PALC	Fixtures in cartons secured by heavy gauge stretch wrap. Fast and efficient handling.

Specifications and dimensions subject to change without notice. Consult your Cooper Lighting Representative or visit www.cooperlighting.com for available options, accessories and ordering information.

PRODUCT INFORMATION FOR LAMPS

Brand	Lamp	P5	P4	EP3/HP3	P2/HP2	OPTICA	RDI/A	GC	GC8	GR8	GR5	GCA	RWW	AC	AC2	ALN	
Generic ²	L8730	X	X	X	X	X	X	X	X	X		X	X	X	X	X	
	L8735	X	X	X	X	X	X	X	X	X		X	X	X	X	X	
	L8741	X	X	X	X	X	X	X	X	X		X	X	X	X	X	
	L8830	X	X	X	X	X	X	X	X	X		X	X	X	X	X	
	L8835	X	X	X	X	X	X	X	X	X		X	X	X	X	X	
	L8841	X	X	X	X	X	X	X	X	X		X	X	X	X	X	
	LB30	X	X	X			X						X	X			
	LB35	X	X	X			X						X	X			
	LB41	X	X	X			X						X	X			
	L5830	X	X	X	X	X	X	X	X			X	X	X	X	X	X
	L5835	X	X	X	X	X	X	X	X			X	X	X	X	X	X
	L5841	X	X	X	X	X	X	X	X			X	X	X	X	X	X

NOTES: 1. Add "HL" (High Lumen) to lamp ordering logic to indicate high-lumen lamp; generic HL lamps available for 32T8 or 28T5 only. Add "C" to specify Cover-guard lamps installed. 2. Generic lamp product information also valid for GE, Philips and Sylvania lamp technologies. See product information for specified lamps below.

PRODUCT INFORMATION FOR SPECIFIED LAMPS

T8 SAMPLE NUMBER: LGF28T8 / SPX41M / XL

Lamp	Brand	Wattage	CRI	Kelvin	Type (not for Biax) ³
L	G=GE	BX=40, 50 or 55W Biax (all Biax SPX only) F17=17W F28=28W F32=32W	SP=78 CRI SPX=83+ CRI ³	30M/=3000K 35M/=3500K 41M/=4100K ³ 50M/=5000K ³ WM=Watt-Miser	OC8=Octron T8 or ECO XL=Extended Life SXL=Super Extended Life HL=High Lumen XL CVG=Coverguard
L	W=Philips	FO17T8M/=17W FO28T8M/=28W FO32T8M/=32W	TL7=78 CRI TL8=85 CRI ⁴ ADV=Advantage, High Lumen, Long Life	30=3000K 35=3500K 41=4100K 50=5000K ⁴	Blank=ALTO PLUS=Plus, Long Life EWithLL=Energy Advantage, Long Life
L	S=Sylvania	FO17M/T8=17W FO28M/T8=28W FO32M/T8=32W	7=75+ CRI 8=85 CRI ⁵	30=3000K 35=3500K 41=4100K 50=5000K ⁵	Blank=ECO XP=Extended Performance, ECO3 XP/SS=Super Saver XP XPS=High Lumen, Extended Performance XPXL=Extra Life/Extended Performance

NOTES: 3. XL, SXL and HL lamp CRI values are 81-82 for 4100K or 80 for 5000K. 4. CRI value of 82 for 5000K. 5. XPS and XPXL lamp CRI values are 81 for 5000K.

T5 and T5HO SAMPLE NUMBER: LWF28T5M / 850

Lamp	Brand	Wattage	Other	CRI	Kelvin	Type (not for Biax)
L	G=GE W=Philips S=Sylvania	F14T5=14WT5 F21T5=21WT5 F24T5=24WT5HO F28T5=28WT5 F39T5=39WT5HO F54T5=54WT5HO	47W=47WT5HO (GE only) [Blank]=51WT5HO (GE only)	M/8=85+ CRI	30=3000K 35=3500K 41=4100K 50=5000K	WM=Watt-Miser (GE only) HL=High Lumen XL (T5 only) HOEA49=49W (Philips only) HOEA44=44W (Philips only)

T8 U-LAMP SAMPLE NUMBER: LSF031M / 835XP

Lamp	Brand	Wattage	CRI	Kelvin	Type	
L	G=GE		SP=78 CRI SPX=82+ CRI	30=3000K 35=3500K 41=4100K 50=5000K ⁶	M/OC8U6=32W Six Inch (6") T8 M/U1-5/8=31W One and Five-Eighths Inch (1-5/8") T8	WM=Watt-Miser ⁷
L	W=Philips	F32T8=32W Six Inch (6") T8	M/TL7=75 CRI M/TL8=85 CRI	30=3000K 35=3500K 41=4100K 50=5000K		Blank=ALTO XEW=Energy Advantage (25W 6" U-lamp spacing only)
L	S=Sylvania	FO32M/=Six Inch (6") T8 FO31M/=One and Five-Eighths Inch (1-5/8") T8	7=75 CRI 8=85 CRI	30=3000K 35=3500K 41=4100K 50=5000K ⁸		Blank=ECO XP=Extended Performance XP/SS=Super Saver XP XPS=High Lumen, Extended Performance

NOTES: 6. SPX only. 7. 30W 6" U-Lamp Spacing only. 8. 6" U6T8 75 CRI or 85 CRI XPS only.

Specifications and dimensions subject to change without notice. Consult your Cooper Lighting Representative or visit www.cooperlighting.com for available options, accessories and ordering information.

PARABOLICS AND RECESSED

Brand	Battery	P5	P4	EP3/HP3	P2/HP2	OPTICA	RDI	GC	GC8	GR8/GR5	GCA	AC	AC2	ALN
Generic	EL4 (350-500 lm)	X	X	X	X	X	X	X	X	X	X	X	X	X
	EL5 (up to 700 lm)	X	X	X	X		X	X		X	X	X	X	X
	EL8 (600-700 lm)	X	X	X	X	X	X	X	X	X	X	X	X	X
	EL5HO (up to 600 lm)	X	X	X	X		X	X		X	X	X	X	X
	EL14 (600-1400 lm) ¹	X	X	X	X	X	X	X	X	X	X	X	X	X
Bodine	EL-B100 (350-450 lm)	X	X	X	X	X	X	X	X ⁴	X ⁴	X	X	X	
	EL-B90 (500-600 lm)	X	X	X	X	X	X	X	X ⁴	X ⁴	X	X	X	
	EL-B70A (600-700 lm)	X	X	X	X	X	X	X	X ⁴	X ⁴	X	X	X	
	EL-B60 (600-700 lm)	X	X	X	X	X	X	X	X ⁴	X ⁴	X	X	X	
	EL-B60LPU (600-700lm)	X	X	X	X	X	X	X	X	X	X	X	X	
	EL-B50 (1100-1400 lm) ^{1,2}	X	X	X	X	X	X	X	X ⁴	X ⁴	X	X	X	
	EL-B50ST (1100-1400 lm) ^{1,2}	X	X	X	X	X	X	X	X ⁴	X ⁴	X	X	X	
	EL-B50RCT (1100-1400 lm) ^{1,2}	X	X	X	X	X	X	X	X ⁴	X ⁴	X	X	X	
	EL-LP500 (370-520 lm)			X	X		X	X		X	X	X ⁵		X
	EL-LP550 (390-700 lm)			X	X		X	X		X	X	X ⁵		X
	EL-LP600 (600-1325 lm)			X	X		X	X		X	X	X ⁵		X
Iota	EL-I32 (up to 550 lm)	X	X	X	X	X	X	X	X	X	X	X	X	X
	EL-I40 (up to 700 lm)	X	X	X	X	X	X	X	X	X	X	X	X	X
	EL-I48 (up to 700 lm)	X	X	X	X	X	X	X	X	X	X	X	X	X
	EL-I320 (1300 lm) ^{1,2}	X	X	X	X	X	X	X	X ⁴	X ⁴	X	X	X	
	EL-I880 (2000 lm) ^{1,2}						X		X ⁴	X ⁴		X	X	
	EL-I232 (2 @ 1400 lm) ²	X	X	X	X		X	X	X ⁴	X ⁴	X	X	X	
	EL-ISD80 (1300 lm) ^{1,2}	X	X	X	X	X	X	X	X ⁴	X ⁴	X	X	X	
	EL-ISL28 (up to 500 lm) ³			X	X		X	X		X	X	X ⁵		X
	EL-ISL54 (up to 825 lm)			X	X		X	X		X	X	X ⁵		X
	EL-ISL540 (up to 1300 lm)			X	X		X	X		X	X	X ⁵		X

NOTES: 1. For battery wired for two lamps, specify "/2L" after battery description. 2. Due to size, battery cannot be installed in 2-lamp and 4-lamp 2' x 2's, except RDI. 3. Will not operate two (2) lamps. 4. Due to battery size, a wide ballast cover is used. 5. 2' x 4' only.

PRODUCT INFORMATION FOR SURFACE

Brand	Battery	M/MC	SA	WN	WS	CR	RWW ⁶	CL	BA/BAU	BI/BIU ⁶	BE/BEU ⁶	BC ⁶
Generic	EL4 (350-500 lm)	X	X	X	X	X	X		X	X	X	X
	EL5 (up to 700 lm)	X	X	X	X	X	X		X	X	X	X
	EL8 (600-700 lm)	X	X	X	X	X	X		X	X	X	X
	EL5HO (up to 600 lm)	X	X	X	X	X	X		X	X	X	X
	EL14 (600-1400 lm) ¹	X	X	X	X	X	X		X	X	X	X
Bodine	EL-B100 (350-450 lm)	X	X	X	X	X	X		X ⁴	X	X	X
	EL-B90 (500-600 lm)	X	X	X	X	X	X		X ⁴	X	X	X
	EL-B70A (600-700 lm)	X	X		X	X	X		X ⁴	X	X	X
	EL-B60 (600-700 lm)	X	X	X	X	X	X		X ⁴	X	X	X
	EL-B60LPU (600-700lm)	X	X		X	X	X		X	X	X	X
	EL-B50 (1100-1400 lm) ^{1,2}	X	X		X	X	X		X ⁴	X	X	X
	EL-B50ST (1100-1400 lm) ^{1,2}	X	X		X	X	X		X ⁴	X	X	X
	EL-B50RCT (1100-1400 lm) ^{1,2}	X	X		X	X	X		X ⁴	X	X	X
	EL-LP500 (370-520 lm)						X					
	EL-LP550 (390-700 lm)						X					
	EL-LP600 (600-1325 lm)						X					
Iota	EL-I32 (up to 550 lm)	X	X	X	X	X	X		X	X	X	X
	EL-I40 (up to 700 lm)	X	X	X	X	X	X		X	X	X	X
	EL-I48 (up to 700 lm)	X	X		X	X	X		X	X	X	X
	EL-I320 (1300 lm) ^{1,2}	X	X		X	X	X		X ⁴	X	X	X
	EL-I880 (2000 lm) ^{1,2}	X	X		X	X	X		X ⁴	X	X	X
	EL-I232 (2 @ 1400 lm) ²	X	X		X	X	X		X ⁴	X	X	X
	EL-ISD80 (1300 lm) ^{1,2}	X	X		X	X	X		X ⁴	X	X	X
	EL-ISL28 (up to 500 lm) ³						X					
	EL-ISL54 (up to 825 lm)						X					
	EL-ISL540 (up to 1300 lm)						X					

NOTES: 1. For battery wired for two lamps, specify "/2L" after battery description. 2. Due to size, battery cannot be installed in 2-lamp and 4-lamp 2' x 2's, except RDI. 3. Will not operate 2-lamps. 4. Due to battery size, a wide ballast cover is used. 5. 2' x 4' only. 6. Due to size limitations, battery cannot be installed in two foot (2') units.

PRODUCT INFORMATION FOR STRIP AND INDUSTRIALS

Brand	Battery	RCG ²	SNF ²	SSF ²	SNL ²	SSL ²	SNSM ²	SNRA ²	SMSL ²	DIF/ DMF/ DVMF	IAF/ ICF	VT1	VT2 ²	VT3	VT4	SM/ SML ²	I5/ I8	HBI/ HBG	2HBHD/ 2HBHT/ 2HBG	HBE/ HBL	MBF	ABI
Generic	EL4 (350-500 lm)	X	X	X	X	X	X	X	X	X	X					X	X	X	X	X	X	
	EL5 (up to 700 lm)	X	X	X	X	X	X	X	X	X	X					X	X	X	X	X	X	
	EL8 (600-700 lm)	X	X	X	X	X	X	X	X	X	X					X	X	X	X	X	X	
	EL5HO (up to 600 lm)	X	X	X	X	X	X	X	X	X	X					X	X	X	X	X	X	
	EL14 (600-1400 lm) ¹	X	X	X	X	X	X	X	X	X	X					X	X	X	X	X	X	
Bodine	EL-B100 (350-450 lm)	X	X	X	X	X	X	X	X	X	X					X	X	X		X	X	
	EL-B90 (500-600 lm)	X	X	X	X	X	X	X	X	X	X					X	X	X		X	X	
	EL-B70A (600-700 lm)	X	X	X	X	X	X	X	X	X	X					X	X	X		X	X	
	EL-B60 (600-700 lm)	X	X	X	X	X	X	X	X	X	X					X	X	X		X	X	
	EL-B60LPU (600-700 lm)	X	X	X	X	X	X	X	X	X	X		X ³	X ³	X ³	X	X	X	X ³	X	X	
	EL-B50 (1100-1400 lm) ^{1,2}	X	X	X	X	X	X	X	X	X	X		X ³	X ³	X ³	X	X	X	X ³	X	X	
	EL-B50ST (1100-1400 lm) ^{1,2}	X	X	X	X	X	X	X	X	X	X					X	X	X		X	X	
	EL-B50RCT (1100-1400 lm) ^{1,2}	X	X	X	X	X	X	X	X	X	X					X	X	X		X	X	
	EL-LP500 (370-520 lm)	X	X	X	X	X	X	X	X	X	X					X	X	X		X	X	
	EL-LP550 (390-700 lm)												X	X	X	X	X	X	X	X	X	
	EL-LP600 (600-1325 lm)												X	X	X	X	X	X	X	X	X	
Iota	EL-I32 (up to 550 lm)	X	X	X	X	X	X	X	X	X	X					X	X	X				
	EL-I40 (up to 700 lm)	X	X	X	X	X	X	X	X	X	X					X	X	X				
	EL-I48 (up to 700 lm)	X	X	X	X	X	X	X	X	X	X					X	X	X				
	EL-I320 (1300 lm) ^{1,2}	X	X	X	X	X	X	X	X	X	X					X	X	X				
	EL-I880 (2000 lm) ^{1,2}	X	X	X	X	X	X	X	X	X	X					X	X	X				
	EL-I232 (2 @ 1400 lm) ²	X	X	X	X	X	X	X	X	X	X					X	X	X				
	EL-ISD80 (1300 lm) ^{1,2}	X	X	X	X	X	X	X	X	X	X					X	X	X				
	EL-ISL28 (up to 500 lm) ³			X	X													X	X		X	X
	EL-ISL54 (up to 825 lm)			X	X													X	X		X	X
	EL-ISL540 (up to 1300 lm)			X	X													X	X		X	X
	EL-I40DL (up to 700 lm)												X	X	X					X		
	EL-I48DL (up to 700 lm)												X	X	X					X		
	EL-I80DL (1300 lm)												X	X	X					X		
	EL-I232DL (2 @ 1400 lm)												X	X	X					X		
	EL-ISL28DL (up to 500 lm)												X	X	X					X		
	EL-ISL54DL (up to 825 lm)												X	X	X					X		

NOTES: 1. For battery wired for two lamps, specify "/2L" after battery description. 2. Due to size limitations, battery cannot be installed in two (2) foot units. 3. Order BDLGOU or B50LP for vaportite, hosedown or UL wet listed fixtures.

Specifications and dimensions subject to change without notice. Consult your Cooper Lighting Representative or visit www.cooperlighting.com for available options, accessories and ordering information.

PRODUCT INFORMATION FOR EXTENDED OPTIONS

Nomenclature	Description	P5	P4	EP3/HP3	P3	P2/HP2	OPTICA	GC	GC8	GR8/GR5	GCA	RWW	RDI	AC/AC2	ALN
RIF1	Radio Interference Suppressor	X	X	X		X	X	X	X	X	X	X	X	X	X
2/RIF1	Two (2) Suppressors	X	X	X		X		X	X	X	X	X	X	X	
PL5/120	PL5 Night Light wired 120V	X	X	X		X		X			X	X	X		
PL5/277	PL5 Night Light wired 277V	X	X	X		X		X			X	X	X		
PL7/120	PL7 Night Light wired 120V	X	X	X		X		X			X	X	X		
PL7/277	PL7 Night Light wired 277V	X	X	X		X		X			X	X	X		
PL9/120	PL9 Night Light wired 120V	X	X	X		X		X			X	X	X		
PL9/277	PL9 Night Light wired 277V	X	X	X		X		X			X	X	X		
PL13/120	PL13 Night Light wired 120V	X	X	X		X		X			X	X	X		
PL13/277	PL13 Night Light wired 277V	X	X	X		X		X			X	X	X		
LAP ¹	Less Access Plate	X	X	X		X	X	X	X	X				X	X
LAO ²	Less Access Opening	X	X	X		X	X	X	X	X	X			X	X
FR	Suitable for Install Fire Rated Ceiling	X	X	X		X		X	X	X	X		X	X	X
IC	IC-Rated ⁶			X		X	X	X	X	X			X	X ¹⁰	X
G1	Gasket btw DR Frm and Housing							X	X	X	X				
G2 ³	Gasket btw DR Frm and Housing, btw Lens and DR Frm							X	X ⁵		X				
G3 ³	Gasket btw DR Frm and Hous, btw Lens and DR Frm on Mnt Surf of Trm							X	X ⁵		X				
VRS	Vandal Resistant Screws (2FT - 2; 4FT - Four (4) screws)							X							
6/VRS	Six (6) Vandal Resistant Screws							X							
MEP ⁴	Modified End Plate	X	X	X		X	X	X			X				
REP	Riveted End Plate	X	X	X		X	X	X	X		X	X	X		X
6/LC	Six (6) Lens Clips							X	X						
2BC	Second Ballast Cover		X ⁷	X ⁷		X ⁷		X ⁷	X ⁸	X ⁸	X				
EM/BC	EM Installed in field ⁹ (Wide or standard BC used in fixture)	X	X	X		X	X	X	X	X	X				
1IN/MLAB	One Inch (1") Mark Labeling	X	X	X	X	X		X	X		X	X	X		
2IN/MLAB	Two Inch (2") Mark Labeling	X	X	X	X	X		X	X		X	X	X		
PAF	Painted After Fabrication		X	X		X		X	X		X				X
DS	Debris Shield												X		

NOTES: 1. Option used when housing access plates are shipped ahead for pre-wiring. 2. Required for 2-lamp or 4-lamp 2' x 2' fixture when two (2) ballast or one (1) ballast and emergency are requested. 3. Aluminum door and minimum 0.125" shielding. 4. Installation requires end fillers and may require end support bracket. See accessory page for further details. 5. Aluminum doorframe (FA/RA) only. 6. See product spec sheet for limitations. 7. For 2' x 2' 3L, 2BC is standard. See product spec sheet for additional info. 8. For 2' x 2' 3L Biax or U1-5/8, 2BC is standard; 2U6T8, 3T5 or 3T8, 2BC is optional. 9. Refer to EM table above for fit. 10. AC only.

PACKAGING (REQUIRED)

Nomenclature	Description	P5	P4	EP3/HP3	P3	P2/HP2	OPTICA	GC	GC8	GR8/GR5	GCA	RWW	RDI	AC	AC2	ALN
U	Unit Pack	X	X	X	X	X	X	X	X	X	X	X	X	X	X	X
PAL	Job Pack, out of carton	X	X	X		X	X	X	X		X					
PALC	Job Pack, in carton	X	X	X		X	X	X	X		X	X	X	X	X	X

PRODUCT INFORMATION FOR EXTENDED OPTIONS-SURFACE

Nomenclature	Description	PMX	M/MC	SA	WB	WE	WS	CR	CL	BA ²	BI/BE ²	BC
IB	Socket Position Inboard			X								
OB	Socket Position Outboard			X								
RIF1	Radio Interference Suppressor	X	X		X	X	X		X	X		
2/RIF1	Two (2) Suppressors	X	X		X	X	X		X	X		
3CP	Three Foot (3') Cord and Plug								X			
6CP	Six Foot (6') Cord and Plug								X			
PC /VOLTAGE	Cord and Plug Attached (Specify Voltage)			X	X		X	X				
PI/CPI	Plug-in Wiring											
TILW	Tandem In-Line Wiring			X	X		X	X				
4BB	Four (4) Ballast Bolts	X	X		X					X	X	X
PL5/120	PL5 Night Light wired 120V	X	X	X	X		X			X	X	
PL5/277	PL5 Night Light wired 277V	X	X	X	X		X			X	X	
PL7/120	PL7 Night Light wired 120V	X	X	X	X		X			X	X	
PL7/277	PL7 Night Light wired 277V	X	X	X	X		X			X	X	
PL9/120	PL9 Night Light wired 120V	X	X	X	X		X			X	X	
PL9/277	PL9 Night Light wired 277V	X	X	X	X		X			X	X	
PL13/120	PL13 Night Light wired 120V	X	X	X	X		X			X	X	
PL13/277	PL13 Night Light wired 277V	X	X	X	X		X			X	X	
G1	Gasket btw Door Frame and Housing		X									
G2 ¹	Gasket btw Door Frame and Housing, btw Lens and Door Frame		X									
VRS	Vandal Resistant Screws (4 standard)		X									
6/VRS	Six (6) Vandal Resistant Screws		X									
BH	Matte Black Finish									X	X	
WH	White Finish									X		
CO	Grounded Convenience Outlet								X	X	X	X
PS1	Pull Switch, Single Circuit (120V only)									X	X	X
PS1D	Pull Switch, Wired to Downlight Circuit (120V only)									X	X	X
PS4	Pull Switch, Four-way (120V only)									X	X	X
RS1	Rotary Switch, Single Circuit (120V only)									X	X	X
RS1D	Rotary Switch, Wired to Downlight Circuit (120V only)									X	X	X
RS4	Rotary Switch, Four-way (120V only)									X	X	X
SW	Rocker Switch								X			
EKO	End Knockout	X	X	X								
1/EKO	End Knockout on One End Only	X	X	X								
DEP	Heavy Gauge Steel Decorator End Plate				X							
6/LC	Six (6) Lens Clips		X									
1IN/MLAB	One Inch (1") Mark Labeling	X	X	X	X	X	X	X	X	X	X	X
2IN/MLAB	Two Inch (2") Mark Labeling	X	X	X	X	X	X		X	X		
BT	Black Accent Trim									X		
IH	Almond Housing									X		
NT	No Trim									X		
OF	Opaque Front								X			
OT	Oak Accent Trim									X		
PAF	Painted After Fabrication		X		X	X	X					
SMB	Side Mounted Ballast		X	X								

PACKAGING (REQUIRED)

Nomenclature	Description	PMX	M/MC	SA	WB	WS	WE	CR	CL	BA	BI/BE	BC
U	Unit Packed	X	X	X	X	X	X	X	X	X	X	X

NOTES: 1. Aluminum door and minimum .125 shielding required. 2. Night light options available for 1-Lamp units only.

ACCESSORY REFLECTOR NOMENCLATURE

SAMPLE NUMBER: SNF-ASY-SS-4

SNF	ASY	SS	4
Strip Series SNF=Narrow SSF=Standard	Reflector Style ASY=Asymmetric ⁴ SYM=Symmetric SYM12=Twelve Inches (12") Symmetric ³ REV=Reverse Asymmetric ⁴	Finish Blank=White SS=Specular Steel	Length 18=Eighteen Inches (18") ¹ 2=Two Feet (2') 2T5=Two Feet (2') T5 3=Three Feet (3') 4=Four Feet (4') 4T5=Four Feet (4') T5 8T=Eight (8) Feet ² 8T5=Eight (8) Feet T5

NOTES: 1. For SNF only. 2. Will ship as two (2) four foot (4') reflectors. 3. For SSF only. 4. For T12 or T8 applications only (no T12 Slimline or T12 HO). 5. For Slimline or T8HO two (2) lamp fixture where the reflector will replace the channel cover.

SNF ASY Reflector



White	Specular
SNF-ASY-18IN	SNF-ASY-SS-18IN
SNF-ASY-2	SNF-ASY-SS-2
SNF-ASY-3	SNF-ASY-SS-3
SNF-ASY-4	SNF-ASY-SS-4
SNF-ASY-8T	SNF-ASY-SS-8T-2
SNF-ASY-2T5	SNF-ASY-SS-2T5
SNF-ASY-4T5	SNF-ASY-SS-4T5
SNF-ASY-8T5	SNF-ASY-SS-8T5

SSF ASY Reflector



White	Specular
SSF-ASY-2	SSF-ASY-SS-2
SSF-ASY-3	SSF-ASY-SS-3
SSF-ASY-4	SSF-ASY-SS-4
SSF-ASY-8T	SSF-ASY-SS-8T
SSF-ASY-2T5	SSF-ASY-SS-2T5
SSF-ASY-4T5	SSF-ASY-SS-4T5
SSF-ASY-8T5	SSF-ASY-SS-8T5

SNF REV/ASY Reflector



White	Specular
SNF-REV-2	SNF-REV-SS-2
SNF-REV-3	SNF-REV-SS-3
SNF-REV-4	SNF-REV-SS-4
SNF-REV-8T	SNF-REV-SS-8T
SNF-REV-2T5	SNF-REV-SS-2T5
SNF-REV-4T5	SNF-REV-SS-4T5
SNF-REV-8T5	SNF-REV-SS-8T5

SSF REV/ASY Reflector



White	Specular
SSF-REV-2	SSF-REV-SS-2
SSF-REV-3	SSF-REV-SS-3
SSF-REV-4	SSF-REV-SS-4
SSF-REV-8T	SSF-REV-SS-8T
SSF-REV-2T5	SSF-REV-SS-2T5
SSF-REV-4T5	SSF-REV-SS-4T5
SSF-REV-8T5	SSF-REV-SS-8T5

SNF SYM Reflector



White	Specular
SNF-SYM-18IN	SNF-SYM-SS-18IN
SNF-SYM-2	SNF-SYM-SS-2
SNF-SYM-3	SNF-SYM-SS-3
SNF-SYM-4	SNF-SYM-SS-4
SNF-SYM-8T	SNF-SYM-SS-8T

SSF SYM Reflector



White	Specular
SSF-SYM-2	SSF-SYM-SS-2
SSF-SYM-2T5	SSF-SYM-SS-2T5
SSF-SYM-3	SSF-SYM-SS-3
SSF-SYM-4	SSF-SYM-SS-4
SSF-SYM-4T5	SSF-SYM-SS-4T5
SSF-SYM-8T	SSF-SYM-SS-8T
SSF-SYM-8TT5	SSF-SYM-SS-28TT5
SSF-SYM-4HOR ⁵	SSF-SYM-SS-4HOR ⁵
SSF-SYM-8HOR ⁵	SSF-SYM-SS-8HOR ⁵

SSF SYM Reflector

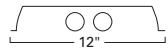

White	Specular
SSF-SYM12-4	SSF-SYM12-SS-4
SSF-SYM12-4HOR ⁵	SSF-SYM12-SS-4HOR ⁵
SSF-SYM12-8	SSF-SYM12-SS-8
SSF-SYM12-8HOR ⁵	SSF-SYM12-SS-8HOR ⁵

Specifications and dimensions subject to change without notice. Consult your Cooper Lighting Representative or visit www.cooperlighting.com for available options, accessories and ordering information.

ACCESSORY REFLECTOR NOMENCLATURE

SAMPLE NUMBER: SNL-REV-SS-2-1

SNL	ASY	SS	4	2
Strip Series SNL=Narrow Staggered SSL=Standard Staggered	Reflector Style ASY=Asymmetric SYM=Symmetric REV=Reverse Asymmetric	Finish Blank=White SS=Specular Steel RP=Round Perf	Length 18=Eighteen Inches (18") 2=Two Feet (2') 3=Three Feet (3') 4=Four Feet (4') 5=Five Feet (5') 8=Eight Feet (8') ¹ 8T=Eight Feet (8') ¹	Number of Lamps 1=One (1) Lamp 2=Two (2) Lamp 4=Three (3) or Four (4) Lamp

NOTES: 1. Will ship as two (2) four foot (4') reflectors.

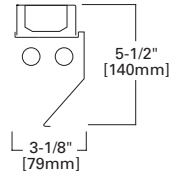

SNL REV/ASY Reflector

White	Specular	Perf
SNL-REV-2-1	SNL-REV-SS-2-1	N/A
SNL-REV-2-2	SNL-REV-SS-2-2	N/A
SNL-REV-3-1	SNL-REV-SS-3-1	N/A
SNL-REV-3-2	SNL-REV-SS-3-2	N/A
SNL-REV-4-1	SNL-REV-SS-4-1	N/A
SNL-REV-4-2	SNL-REV-SS-4-2	N/A
SNL-REV-8T-1	SNL-REV-SS-8T-1	N/A
SNL-REV-8T-2	SNL-REV-SS-8T-2	N/A

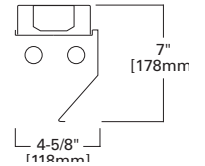

SSL REV/ASY Reflector

White	Specular	Perf
SSL-REV-2-1	SSL-REV-SS-2-1	N/A
SSL-REV-2-2	SSL-REV-SS-2-2	N/A
SSL-REV-3-1	SSL-REV-SS-3-1	N/A
SSL-REV-3-2	SSL-REV-SS-3-2	N/A
SSL-REV-4-1	SSL-REV-SS-4-1	N/A
SSL-REV-4-2	SSL-REV-SS-4-2	N/A
SSL-REV-8T-1	SSL-REV-SS-8T-1	N/A
SSL-REV-8T-2	SSL-REV-SS-8T-2	N/A
SSL-REV-8-1	SSL-REV-SS-8-1	N/A
SSL-REV-8-2	SSL-REV-SS-8-2	N/A

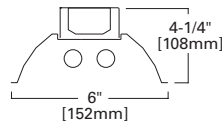

SNL SYM Reflector

White	Specular	Perf
SNL-SYM-2-1	SNL-SYM-SS-2-1	N/A
SNL-SYM-2-2	SNL-SYM-SS-2-2	N/A
SNL-SYM-3-1	SNL-SYM-SS-3-1	N/A
SNL-SYM-3-2	SNL-SYM-SS-3-2	N/A
SNL-SYM-4-1	SNL-SYM-SS-4-1	N/A
SNL-SYM-4-2	SNL-SYM-SS-4-2	N/A
SNL-SYM-8-1	SNL-SYM-SS-8-1	N/A
SNL-SYM-8T-2	SNL-SYM-SS-8T-2	N/A

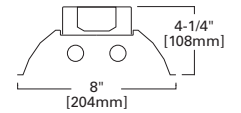

SSL SYM Reflector

White	Specular	Perf
SSL-SYM-2-1	SSL-SYM-SS-2-1	N/A
SSL-SYM-2-2	SSL-SYM-SS-2-2	N/A
SSL-SYM-3-1	SSL-SYM-SS-3-1	N/A
SSL-SYM-3-2	SSL-SYM-SS-3-2	N/A
SSL-SYM-4-1	SSL-SYM-SS-4-1	N/A
SSL-SYM-4-2	SSL-SYM-SS-4-2	N/A
SSL-SYM-8T-1	SSL-SYM-SS-8T-1	N/A
SSL-SYM-8T-2	SSL-SYM-SS-8T-2	N/A
SSL-SYM-8-1	SSL-SYM-SS-8-1	N/A
SSL-SYM-8-2	SSL-SYM-SS-8-2	N/A

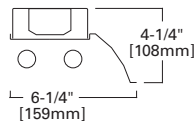

SSL ASY Reflector

White	Specular	Perf
SSL-ASY-2-1	SSL-ASY-SS-2-1	N/A
SSL-ASY-2-2	SSL-ASY-SS-2-2	N/A
SSL-ASY-3-1	SSL-ASY-SS-3-1	N/A
SSL-ASY-3-2	SSL-ASY-SS-3-2	N/A
SSL-ASY-4-1	SSL-ASY-SS-4-1	N/A
SSL-ASY-4-2	SSL-ASY-SS-4-2	N/A
SSL-ASY-8T-1	SSL-ASY-SS-8T-1	N/A
SSL-ASY-8T-2	SSL-ASY-SS-8T-2	N/A
SSL-ASY-8-1	SSL-ASY-SS-8-1	N/A
SSL-ASY-8-2	SSL-ASY-SS-8-2	N/A

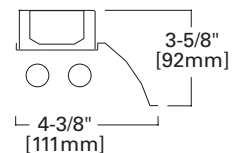

SNL ASY Reflector

White	Specular	Perf
SNL-ASY-2-1	SNL-ASY-SS-2-1	N/A
SNL-ASY-2-2	SNL-ASY-SS-2-2	N/A
SNL-ASY-3-1	SNL-ASY-SS-3-1	N/A
SNL-ASY-3-2	SNL-ASY-SS-3-2	N/A
SNL-ASY-4-1	SNL-ASY-SS-4-1	N/A
SNL-ASY-4-2	SNL-ASY-SS-4-2	N/A
SNL-ASY-8T-1	SNL-ASY-SS-8T-1	N/A
SNL-ASY-8T-2	SNL-ASY-SS-8T-2	N/A

Specifications and dimensions subject to change without notice. Consult your Cooper Lighting Representative or visit www.cooperlighting.com for available options, accessories and ordering information.

ACCESSORY REFLECTOR NOMENCLATURE

SAMPLE NUMBER: SNF-ASY-SS-18IN

SM	ASY	SS	4	1
Strip Series SM=Micro SML=Micro Staggered SMW=Micro Wide	Reflector Style ASY=Asymmetric SYM=Symmetric REV=Reverse Asymmetric	Finish Blank=White SS=Specular RP=Round Perf	Length 18=18 Inches (18") 2=2 Feet (2') 3=3 Feet (3') 4=4 Feet (4') 8=8 Feet (8') 8T=8 Feet (8') ²	Number of Lamps 1=One (1) Lamp 2=Two (2) Lamps 4=(Three) 3 or (Four) 4 Lamps ³

NOTES: 1. For SM, SML and SMW only. 2. Will ship as two (2) four foot (4') reflectors.
 3. For SMW only.

SAMPLE NUMBER: SNSM-ASY-SS-2-2

SNSM	ASY	SS	4	1
Strip Series SNSM=Side Mounted Striplight	Reflector Style ASY=Asymmetric	Finish Blank=White SS=Specular	Length 2=Two Feet (2') 3=Three Feet (3') 4=Four Feet (4')	Number of Lamps 1=One (1) Lamp 2=Two (2) Lamps

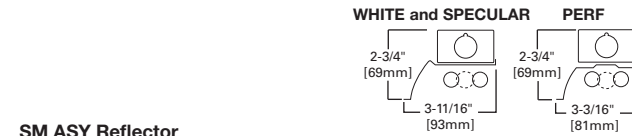

SM ASY Reflector

White	Specular	Perf
SM-ASY-2-2	SM-ASY-SS-2-2	SM-ASY-RP-2-2
SM-ASY-3-2	SM-ASY-SS-3-2	SM-ASY-RP-3-2
SM-ASY-4-2	SM-ASY-SS-4-2	SM-ASY-RP-4-2
SM-ASY-8T-2	SM-ASY-SS-8T-2	SM-ASY-RP-8T-2

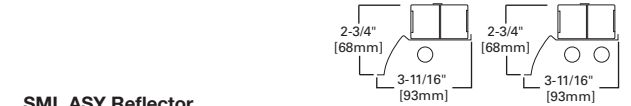

SML ASY Reflector

White	Specular	Perf
SML-ASY-3-1	SML-ASY-SS-3-1	SML-ASY-RP-3-1
SML-ASY-3-2	SML-ASY-SS-3-2	SML-ASY-RP-3-2
SML-ASY-4-1	SML-ASY-SS-4-1	SML-ASY-RP-4-1
SML-ASY-4-2	SML-ASY-SS-4-2	SML-ASY-RP-4-2

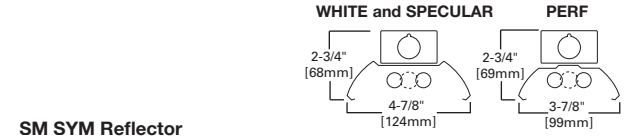

SM SYM Reflector

White	Specular	Perf
SM-SYM-2-2	SM-SYM-SS-2-2	SM-SYM-RP-2-2
SM-SYM-3-2	SM-SYM-SS-3-2	SM-SYM-RP-3-2
SM-SYM-4-2	SM-SYM-SS-4-2	SM-SYM-RP-4-2
SM-SYM-8T-2	SM-SYM-SS-8T-2	SM-SYM-RP-8T-2

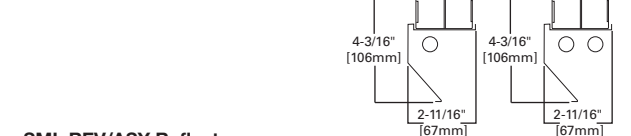

SML REV/ASY Reflector

White	Specular	Perf
SML-REV-3-1	SML-REV-SS-3-1	SML-REV-RP-3-1
SML-REV-3-2	SML-REV-SS-3-2	SML-REV-RP-3-2
SML-REV-4-1	SML-REV-SS-4-1	SML-REV-RP-4-1
SML-REV-4-2	SML-REV-SS-4-2	SML-REV-RP-4-2

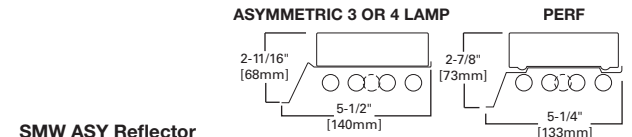

SMW ASY Reflector

White	Specular	Perf
SMW-ASY-2-4	SMW-ASY-SS-2-4	SMW-ASY-RP-2-4
SMW-ASY-3-4	SMW-ASY-SS-3-4	SMW-ASY-RP-3-4
SMW-ASY-4-4	SMW-ASY-SS-4-4	SMW-ASY-RP-4-4
SMW-ASY-8T-4	SMW-ASY-SS-8T-4	SMW-ASY-RP-8T-4

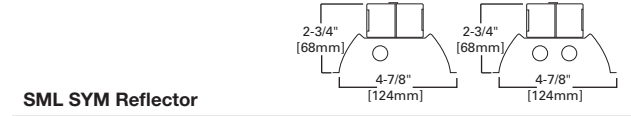

SML SYM Reflector

White	Specular	Perf
SML-SYM-3-1	SML-SYM-SS-3-1	SML-SYM-RP-3-1
SML-SYM-3-2	SML-SYM-SS-3-2	SML-SYM-RP-3-2
SML-SYM-4-1	SML-SYM-SS-4-1	SML-SYM-RP-4-1
SML-SYM-4-2	SML-SYM-SS-4-2	SML-SYM-RP-4-2

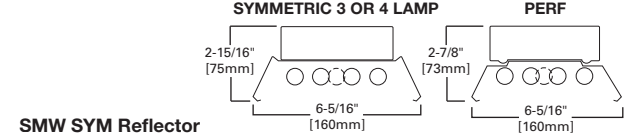

SMW SYM Reflector



White	Specular	Perf
SMW-SYM-2-4	SMW-SYM-SS-2-4	SMW-SYM-RP-2-4
SMW-SYM-3-4	SMW-SYM-SS-3-4	SMW-SYM-RP-3-4
SMW-SYM-4-4	SMW-SYM-SS-4-4	SMW-SYM-RP-4-4
SMW-SYM-8T-4	SMW-SYM-SS-8T-4	SMW-SYM-RP-8T-4

SNSM ASY Reflector

White	Specular	Perf
SNSM-ASY-2-2	SNSM-ASY-SS-2-2	N/A
SNSM-ASY-3-2	SNSM-ASY-SS-3-2	N/A
SNSM-ASY-4-2	SNSM-ASY-SS-4-2	N/A

Specifications and dimensions subject to change without notice. Consult your Cooper Lighting Representative or visit www.cooperlighting.com for available options, accessories and ordering information.

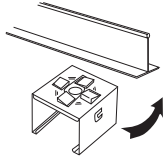
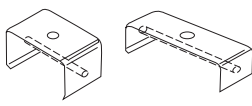
STRIPS AND INDUSTRIALS

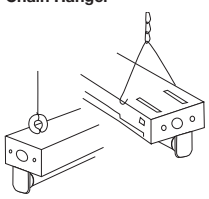
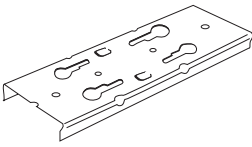
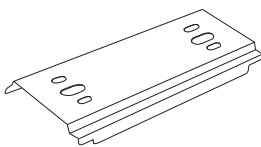
Mounting	Designation	Description
Gripper Hanger 	GRP-SSF-U (Use with SSF, IAF/ICF, SMF, DMF) using 11/16" hole provided.	For mounting on T-bar grid. Use two (2) per fixture. Can also be stem mounted or bolted to surface. Fixture spacing one and one-half inch (1-1/2").
	GRP-SNF-U (Use with SNF)	
Tong Hanger 	ATG-4-U (Use with SMF, DIF, DMF, DVMF, DCIF, DCMF, DCVMF)	Heavy Gauge Channel Tong Hanger. Use two per fixture. Fixture Spacing 1-1/2".
	ATG-SSF-4-U (Use with SSF, IAF/ICF)	
	ATG-SNF-4-U (Use with SNF)	
Spacer 	A-1-B/Spacer-B (Use with all Strips and Industrials)	Spaces fixture 1-1/2" to two and one-half inches (2-1/2") from ceiling.
Chain Hanger 	AYC-CHAIN/SET-U (Use with all strips and industrials except STW)	Sturdy wire hook and thirty-six inch (36") chain set. Use two per fixture. One set of two (2) provided.
	Eye-Chain/Set-B (SNF only)	Eye bolt and thirty-six inch (36") chain. Use two (2) per fixture. One (1) set of two (2) provided.
Channel Connector 	CLC-SSF-B (LA City approved)	Special rigid channel connector designed to give extra support to continuous channel installation (Use with SSF, IAF/ICF). Provision for hanging device. NOTES: 1. Not recommended with wireguard
	CLC-SSF-EXT-B (External Connector SSF) ¹	
	CLC-SNF-EXT-B (External Connector SNF) ¹	
DI Long Connector 	DI2 Long Connector (Use with SMF, DIF, DMF, DVMF, DCIF, DCMF, DCVMF)	Extra support heavy duty channel connector.

Specifications and dimensions subject to change without notice. Consult your Cooper Lighting Representative or visit www.cooperlighting.com for available options, accessories and ordering information.

STRIPS AND INDUSTRIALS

WIRING

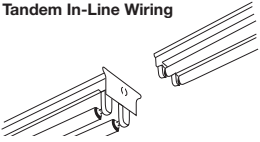
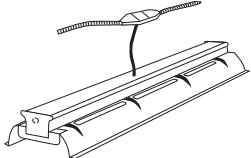
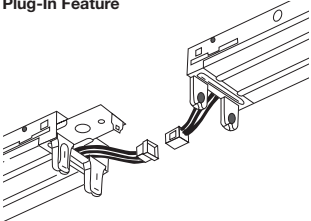



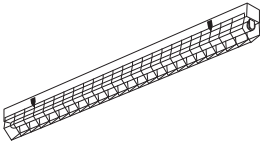
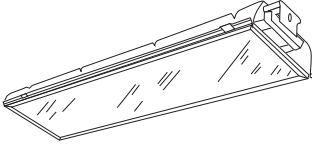
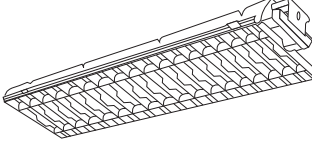
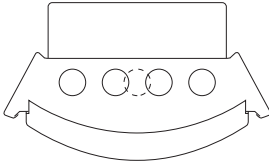

	Designation	Description										
<p>Cord and Plugs</p> 	<p>6-3/18SJT-CandP-515P (120V)</p> <hr/> <p>6-3/18SJT-CandP-715P (277V)</p>	<p>SAMPLE NUMBER: 6-3/18SJT-CandP-515P</p> <table border="1"> <tr> <td>Length 6=Six Feet (6') (standard)</td> <td rowspan="2">Insulation Type SJT (standard)</td> <td rowspan="2">Plug Type [Blank]= Straight Blade L=Twist Lock</td> <td rowspan="2">Amp Rating 15 20</td> </tr> <tr> <td>Conductors 3/ (standard)</td> <td>Cord/Plug C and P</td> </tr> <tr> <td>Wire Gauge 18 (standard)</td> <td></td> <td>Voltage 5=120V 7=277V</td> <td>P=Plug</td> </tr> </table>	Length 6=Six Feet (6') (standard)	Insulation Type SJT (standard)	Plug Type [Blank]= Straight Blade L=Twist Lock	Amp Rating 15 20	Conductors 3/ (standard)	Cord/Plug C and P	Wire Gauge 18 (standard)		Voltage 5=120V 7=277V	P=Plug
Length 6=Six Feet (6') (standard)	Insulation Type SJT (standard)	Plug Type [Blank]= Straight Blade L=Twist Lock	Amp Rating 15 20									
Conductors 3/ (standard)				Cord/Plug C and P								
Wire Gauge 18 (standard)		Voltage 5=120V 7=277V	P=Plug									
<p>Tandem In-Line Wiring</p> 	<p>TILW</p>	<p>Tandem in-line wired strip or industrial fixture sections are applied in pairs (Two (2) four (4') or eight foot (8') sections) See Tandem In-Line Wiring Section or consult the factory for additional ordering information.</p>										
<p>Modular Wiring Systems (MWS)</p> 		<p>Component wiring system, provides cost and labor saving alternative to conventional hardwiring. Uses interchangeable modular components. Offers portability and versatility in lighting configurations. See MWS Section or contact Pre-Sales Technical Support for additional ordering information.</p>										
<p>Plug-In Feature</p> 	<p>PI1</p> <hr/> <p>CPI2</p> <hr/> <p>CPI3</p>	<p>Each fixture assembly is equipped with two factory installed polarized nylon plug-in connectors. Ballast leads and branch circuit wiring are connected to plug-in connectors at factory. Alternating male and female connectors complete circuit from one fixture to another when fixture plug-in connectors are joined. Consult the PI Option Section or contact Pre-Sales Technical Support for additional ordering information.</p>										

Specifications and dimensions subject to change without notice. Consult your Cooper Lighting Representative or visit www.cooperlighting.com for available options, accessories and ordering information.

ACCESSORIES

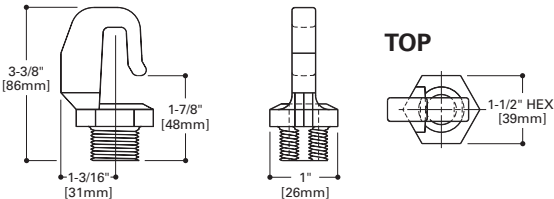
	Designation	Description
Wire Guards 	WG/SNF-4FT-U	Baked white enamel finish. Fourteen (14) gauge wire.
	WG/SSF-4FT-U	
	WG/ICF-4FT-U (IAF, ICF)	
	WG/DIF-4FT-U (DIF, DMF, DVMF)	
	WG/SMF-4FT-U	
	WG/SSL-R-2FT-B	
	WG/SSL-R-3FT-B	
	WG/SSL-R-4FT-B	
Gym Guards frame 	Gym Guard, GG-DIF (Wire Gym Guard)	Baked white enamel finish. Eleven (11) gauge wire. Steel to support optional sheilding. (Use with DIF, DMF, DVMF)
	WG/PA-4FT (Wire Gym Guard/Acrylic Lens)	
	DI-SL-AWithFRM (use with Slimline and HO lamps)	
	DI-RS-AWithFRM (use with Rapid Start lamps) (Steel Frame/Acrylic Lens)	
Egg Crate Louvers Steel 	MECL-DIF/RS-49-3/4-U	Baked white enamel finish. Sturdy cold rolled construction. Thirty-two degree (32°) parallel shielding. (Use with DI, DIM, DIVM)
	MECL-DIF/RS-99-1/2-U	
	MECL-DIF/SL-48-U	
	MECL-DIF/SL-96-U	
Cricket Micro Baffle 	SM-2-TBW	Cost effective indirect lighting solution. Mounting kit is field installed with standard SM strip with reflector. Variety of mounting options available. Each fixture supported at each end and/or each fixture joining.
	SM-3-TBW	
	SM-4-TBW	
	SM-5-TBW	
	SMW-2-TBW (use for wide reflector)	
	SMW-4-TBW (use for wide reflector)	

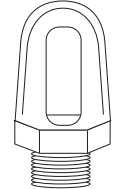
F-BAY MOUNTING ACCESSORIES







Mounting Accessories	Designation	Description
Single Point Mount 	HB-SPM = Galvanized Single Monopoint Hanging Kit with Hub (HBI only, supplied separately) HB-SPM-S = Galvanized Surface Mount Hanging Kit with Hub (HBI only, supplied separately)	Suitable for three-quarter inch (3/4") conduit mounting or for use with fixture hook, loop or safety hook. Use chain or cable set to meet NEC requirements for single point mounting, as well as to prevent cantilevering and rotation of fixture from one central location.
	HBL-SPM = Galvanized Single Monopoint Hanging Kit with Hub (HBE and HBL only, supplied separately) HBL-SPM-S = Galvanized Surface Mount Hanging Kit with Hub (HBE and HBL only, supplied separately)	
	I5/I8-SPM = Galvanized Single Monopoint Hanging Kit with Hub (I5 and I8 only, supplied separately)	
Mounting Methods	Designation	Description
Hook and Safety Hook 	FH-1 = Fixture Hook 	Fixture Hook two and one-half inch (2-1/2") (must be used with TCB, HB-SPM or HBL-SPM)
Loop 	FL-1 = Fixture Loop 	Fixture Loop two and one-half Inch (2-1/2") (must be used with TCB, HB-SPM or HBL-SPM)
Retrofit Hanger 	RH-1 = Retrofit Hanger	Cast Aluminum Hanger with Toggle Nut and Carriage Bolt for quick installation (must be used with TCB, HB-SPM or HBL-SPM)

Fixture Series	AYC	HB/AYC	SPM/RH-1 FH-1 FL-1	Single Toggle	"Y" Toggle	Loop Hanger
HBI		X	X		X	
HBE		X	X		X	
HBL		X	X		X	
I5	X		X	X		X
I8	X		X	X		X
ABI		X	X		X	
MBF	X			X	X ³	
VT1						X
VT4					X	

NOTES: 3. Continuous row mount only between fixtures.



Specifications and dimensions subject to change without notice. Consult your Cooper Lighting Representative or visit www.cooperlighting.com for available options, accessories and ordering information.

F-BAY MOUNTING METHODS

Mounting Methods	Designation	Description
	HBAYC-CHAIN/SET-U= Hook style mounting chain set for HBI, HBE, HBL and ABI	Two (2) Hook style V-hangers, thirty-six Inch (36") Chain Sets with S-hooks
"Y" Toggle 	Y-Toggle-10= Mounting Toggle and Ten Foot (10') Cable	Ten Foot (10'), Y Toggle #2 Cable
	Y-Toggle-25= Mounting Toggle and Twenty-five Foot (25') Cable	Twenty-Five Foot (25'), Y Toggle #2 Cable
Loop Hanger  	Loop-10	Ten Foot (10') Loop Hanger #2 Cable
	Loop-30	Thirty Foot (30') Loop Hanger #2 Cable
Single Toggle  	Toggle-10	Ten Foot (10') Single Toggle #2 Cable
	Toggle-30	Thirty Foot (30') Single Toggle #2 Cable



Specifications and dimensions subject to change without notice. Consult your Cooper Lighting Representative or visit www.cooperlighting.com for available options, accessories and ordering information.

F-BAY OCCUPANCY SENSORS

Aisle and 360° General Coverage (Modular)	Designation	Description
 <p>Aisle and 360° General Coverage (Modular)</p>	<p>MMS= Motion Sensor for Modular Power Supply (120-277V) ¹</p> <p>NOTES: 1. One Motion Sensor per fixture required. 2. When ordering Modular Motion Sensor, the fixture must have a Modular Receptacle (MP) and a Modular Cord or Cord and plug accessory.</p>	<p>Supplied with Mounting Box, Modular Power Supply Receptacle, Motion Sensor with three-hundred sixty degree (360°) Lens Installed, and (3) Cover Limiting Hoods (Aisle, End of Aisle, and Full Coverage).</p>
 <p>Aisle and 360° General Coverage (Installed)</p>	<p>MS= 360° or 180° Occupancy Sensor (120V-347V or 480V)</p> <div style="display: flex; justify-content: space-around;"> <div data-bbox="598 640 1015 976"> <p>360° Top View</p> <p>SideView</p> </div> <div data-bbox="1067 640 1484 976"> <p>Aisle Top View</p> <p>SideView</p> </div> </div>	<p>Passive Infra-red Sensor with 360° Lens Installed, one-hundred eighty degree (180°) Lens included with snap-on feature for in-field install.</p>

Specifications and dimensions subject to change without notice. Consult your Cooper Lighting Representative or visit www.cooperlighting.com for available options, accessories and ordering information.

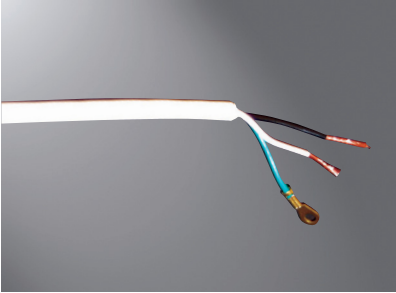
F-BAY POWER CONNECTORS

	Designation	Description
Modular Cord and Plug 	MPC3 = Three Foot (3') Modular Power Cord and Plug (specify voltage for plug)	Connect directly to F-Bay or Modular Motion Sensor with a 3', 6', 9', 12' or 15' long modular cord and plug set with NEMA 15 amp twist lock plug. F-Bay must be ordered with Modular Receptacle (MP) option in catalog logic.
	MPC6 = Six Foot (6') Modular Power Cord and Plug (specify voltage for plug)	
	MPC9 = Nine Foot (9') Modular Power Cord and Plug (specify voltage for plug)	
	MPC12 = Twelve Foot (12') Modular Power Cord and Plug (specify voltage for plug)	
	MPC15 = Fifteen Foot (15') Modular Power Cord and Plug (specify voltage for plug)	
Modular Cord 	MC3 = Three Foot (3') Cord	Connect directly to F-Bay or Modular Motion Sensor with a 3', 6', 9', 12' or 15' long 3/16" standard Modular Power Cord. F-Bay must be ordered with MP option in catalog logic.
	MC6 = Six Foot (6') Cord	
	MC9 = Nine Foot (9') Cord	
	MC12 = Twelve Foot (12') Cord	
	MC15 = Fifteen Foot (15') Cord	
MWS 	MWS = Modular Wiring System	MWS is a simple and cost effective modular wiring system consisting of factory assembled components ready to be snapped together into a complete branch circuit wiring system. With MWS, branch circuit wiring can be installed in minutes instead of hours reducing labor by 80%.
	MDS6 = Six Foot (6') Modular Power Cord with MWS 27DS18/2G06MP.	Connect directly to F-Bay or Modular Motion Sensor with a 6' Long Cord and MWS Connector. F-Bay must be ordered with MP option in catalog logic.

Specifications and dimensions subject to change without notice. Consult your Cooper Lighting Representative or visit www.cooperlighting.com for available options, accessories and ordering information.

F-BAY DOOR FRAMES AND WIREGUARDS

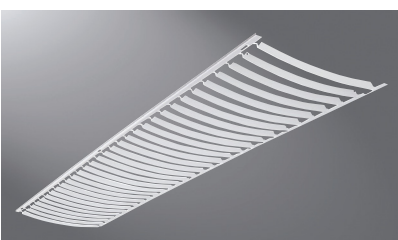
	Designation	Description
<p>Open</p> 	<p>Blank= No Guard</p>	<p>For maximum light output</p>
<p>I5 / I8 Lens</p> <p>Frosted Acrylic Lens</p> 	<p>I5-FRM/LENS= Frosted Acrylic Lens and Frame (use with general distribution reflector, I5 only)</p> <p>I8-FRM/FL PK= Frosted Acrylic Lens and Frame (use with general distribution reflector, I8 only)</p> <p>I5-FRM/CL PK= Clear Acrylic Lens and Frame (use with general distribution reflector, I5 only)</p> <p>I8-FRM/CL PK= Clear Acrylic Lens and Frame (use with general distribution reflector, I8 only)</p>	<p>Lens in white door frame with "Herringbone" patterned end rail</p>
<p>I5/I8 Wireguard</p> <p>Heavy Duty Wireguard</p> 	<p>WG/I5-4FT-B= Four Foot (4') Heavy Duty Wireguard (for I5)</p> <p>WG/I8-4FT-B= Four Foot (4') Heavy Duty Wireguard (for I8)</p>	<p>Finished in White. Can be used alone or in combination with other shielding</p>
<p>I5/I8 Baffle</p> <p>TBW</p> 	<p>90800PPK BAFFLE 4FT I5 WITH HDW (WHITE)= Four Foot (4') Thin Blade White Baffle (for I5)</p> <p>BAFFLE 4FT I8 (WHITE) 11571919= Four Foot (4') Thin Blade White Blade Baffle (for I8)</p>	<p>Thin Blade White Baffle with twenty-three Degree (23°) longitudinal shielding</p>
<p>I5/I8 Louver</p> <p>Asymmetric Louver</p> 	<p>90801P PK= Asymmetric Directional Louver (use with general distribution reflector)</p>	<p>Can be oriented in either direction for flexibility</p>

Specifications and dimensions subject to change without notice. Consult your Cooper Lighting Representative or visit www.cooperlighting.com for available options, accessories and ordering information.

F-BAY HBI, HBL and HBE DOOR FRAMES and WIREGUARDS

HBI Lens and Wireguard		Designation
Prismatic and Clear Acrylic Lens 		HBI-FRM/LENS PK = Prismatic Acrylic Lens and Door Frame for HBI
		HBI-FRM/CL PK = Clear Acrylic Lens and Door Frame for HBI
Wireguard 		HBI-FRM/WG PK = Frame and Wireguard for HBI
		HBI-FRM/LENS/WG PK = Frame and Prismatic Acrylic Lens with Wireguard for HBI
		HBI-FRM/CL/WG PK = Frame and Clear Lens with Wireguard for HBI
Drop Wireguard 		HBI-FRM/DROP/WG PK = Frame and Drop Wireguard for HBI
		HBI-FRM/CL/DROP/WG PK = Drop Wireguard, Clear Acrylic Lens and Door Frame for HBI
Heavy Duty Stock Wireguard 		SWG/HBI-4FT-B = Heavy Duty Wireguard for Field Installation
HBL Wireguard		Designation
Wireguard 		WG/HBL6-4FT-B = Field Installable, Wireguard for HBL 4 and 6 Lamp
		WG/HBL8-4FT-B = Field Installable, Wireguard for HBL 8 and 10 Lamp
HBE Door Frame		Designation
HBE Door Frame 		HBE-___-FRM/LENS WDF PK = Prismatic Acrylic Lens and Extruded Aluminum Door Frame ¹
		HBE-___-FRM/CL WDF PK = Clear Acrylic Lens and Extruded Aluminum Door Frame ¹
		HBE-___-FRM/LENS/WG WDF PK = Four (4) and Six (6) Lamp Frame and Prismatic Lens with Wireguard ¹
		HBE-___-FRM/LENS/WG PK = Eight (8) and Ten (10) Lamp Frame and Prismatic Lens with Wireguard ¹
		HBE-___-FRM/CL/WG PK = Four (4) and Six (6) Lamp Frame and Clear Acrylic Lens with Wireguard ¹
	HBE-___-FRM/CL/WG WDF PK = Eight (8) and Ten (10) Lamp Frame and Clear Acrylic Lens with Wireguard ¹	

NOTES: 1. Specify "4/6LT" or "8/10LT" when ordering HBE Door Frame accessories.

PRODUCT INFORMATION FOR OPTIONS - STRIPS/INDUSTRIALS

Nomenclature	Description	RCG	SNF	SSF	SNL	SSL	SNSM	SNRA	SMSL	DIF/ DMF/ DVMF	IAF/ ICF	VT1	VT2	VT3	VT4	SM/ SML	I5/ I8	HBI	2HBHD/ 2HBHT/ 2HBG	HBE/ HBL	MBF	ABI
RIF1	Radio Interference Suppressor	X	X	X	X	X	X	X	X	X	X		X			X	X	X	X	X	X	
2/RIF1	2 Suppressors	X	X	X	X	X	X	X	X	X	X		X			X	X	X	X	X	X	
PC_Voltage	Cord and Plug Attached (Specify Voltage)		X	X	X		X															
WL	Wet Location Labeled											X	X	X	X							
DD	Deep Diffuser												X									
MF	Metallic Finish																					
UPL	Uplight Apertures																X	X		X		
NUA	No Uplight Apertures																X	X				
PI/CPI	Plug-in Wiring	X	X	X	X	X	X	X	X	X	X					X	X					
TILW	Tandem In-Line Wiring (TILW)	X	X	X	X	X	X	X	X	X	X		X			X	X	X				
SSL	Stainless Steel Latches												X	X								
TEH	Top and End Hubs												X	X								
TH	Top Hub Only												X	X								
IB/OB	Inboard/Outboard (Three (3) Lamp only)									X												
POX	Porlux Reflector Finish									X	X											
PC6	Power Cord Six Foot (6')																X	X		X	X	
PC3	Power Cord Three Foot (3')																X	X		X	X	
MS	Motion Sensor (Aisle Coverage)																X	X	X	X	X	
REP	Riveted End Plate	X	X	X		X	X	X		X	X					X						
1IN/MLAB	One Inch (1") Mark Labels	X	X	X	X	X	X	X	X	X	X		X			X	X	X	X			
2IN/MLAB	Two Inch (2") Mark Labels	X	X	X	X	X	X	X	X	X	X		X			X	X	X	X			
PAF	Painted After Fabrication		X	X	X	X	X	X	X	X	X											
GL or GM	Single or Double Element Fuse	X	X	X	X	X	X	X	X	X	X		X			X	X	X	X	X	X	

NOTES: 1. For HBE/HBL, use HBL-SPM for single mount option.

PACKAGING (REQUIRED)

Nomenclature	Description	RCG	SNF	SSF	SNL	SSL	SNSM	SNRA	SMSL	DIF/ DMF/ DVMF	IAF/ ICF	VT1	VT2	VT3	VT4	SM/ SML	I5/ I8	HBI	2HBHD/ 2HBHT/ 2HBG	HBE/ HBL	MBF	ABI
U	Unit Pack	X	X	X	X	X	X	X	X	X	X		X			X	X	X	X	X	X	
2B	Two (2) Bulk																					
4B	Four (4) Bulk			X						X	X											
6B	Six (6) Bulk		X																			
PAL	Palletized out of carton on a 25" x 48" pallet, shrink wrapped																X	X	X	X	X	
PALC	Palletized in carton on a 25" x 48" pallet, shrink wrapped																X	X	X	X	X	

Specifications and dimensions subject to change without notice. Consult your Cooper Lighting Representative or visit www.cooperlighting.com for available options, accessories and ordering information.

MASTER - SATELLITE WIRING

Description

The Master-Satellite option offered by Metalux is a simple solution for easier installation and energy efficiency. The new ordering nomenclature makes ordering master-satellite fixtures very simple. It is not necessary to specify two part numbers for both master and satellite. Instead, one simple part number provides both the master and the satellite as a combination. The ordering nomenclature is added to the end of the ballast description in fixture part number. Below is the ordering logic showing how Master-Satellite option is specified.

METALUX MASTER - SATELLITE NOMENCLATURE

SAMPLE NUMBER: 2GC-332A-UNV-EB82/MS9L-U

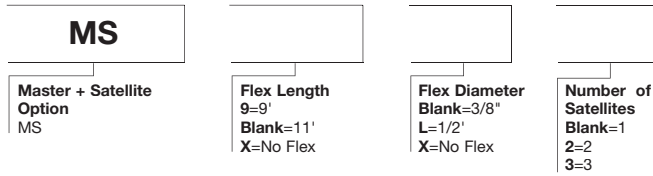

SAMPLE NUMBER: GC-132A-UNV-EB81/MS-U

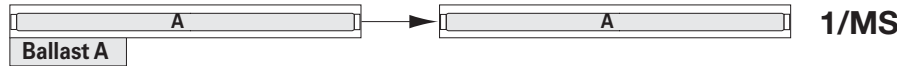

SAMPLE NUMBER: GC-232A-UNV-EB81/MS-U

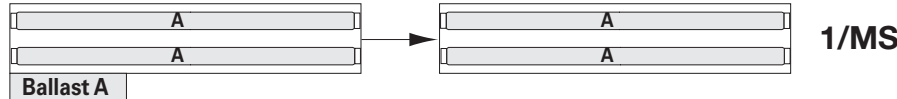

SAMPLE NUMBER: GC-232A-UNV-EB82/MS-U

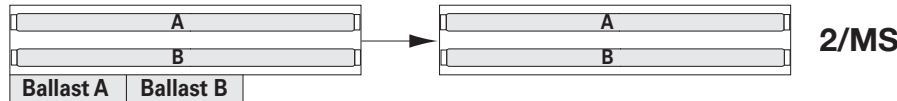

SAMPLE NUMBER: 2GC-332A-UNV-EB82/MS-U

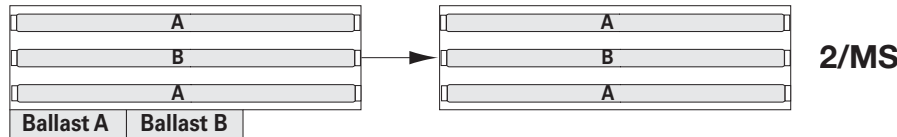

SAMPLE NUMBER: 2GC-332A-UNV-EB83/MS-U

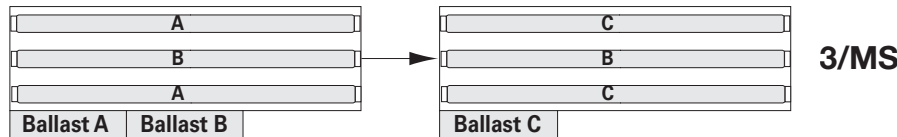

SAMPLE NUMBER: 2GC-332A-UNV-EB83/MS-TILW-U

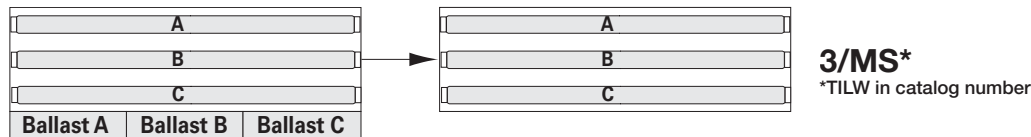

SAMPLE NUMBER: 2GC-432A-UNV-EB82/MS-U

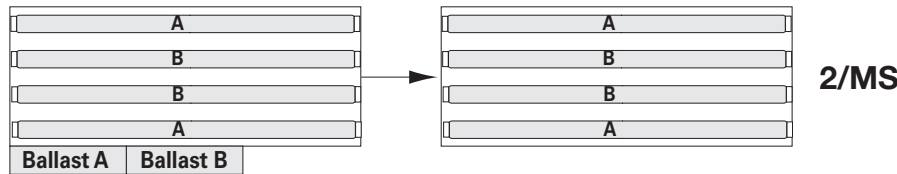

SAMPLE NUMBER: SSF-132-UNV-EB81/MSX2-U



SAMPLE NUMBER: SSF-132-UNV-EB81/MSX3-U

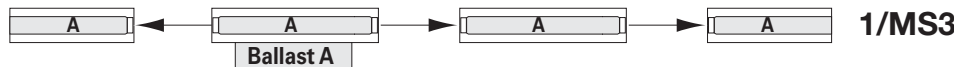

Specifications and dimensions subject to change without notice. Consult your Cooper Lighting Representative or visit www.cooperlighting.com for available options, accessories and ordering information.

WIRING

Flex 3/8" factory prewired Flex installed into fixture access plate. Various wire gauges and number of wires available in six foot (6') lengths.

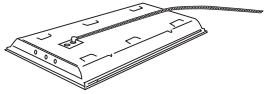

The Flex set consists of the following:

- One wago connector per wire
- Six feet (6') of steel flex
- Eighteen (18) gauge TFN wire, seven foot (7') leads, exposing six inches (6") out of each end
- One ninety degree (90°) flex connector
- One straight-in flex connector
- One access plate

ORDERING INFORMATION

SAMPLE NUMBER: A3/8-2/18G

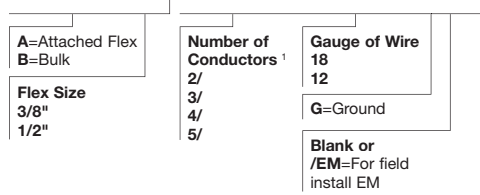

Commonly Used Flex	Number of Wires	Number of Circuits	Gauge of Wire	Wires					
				GREEN (ground)	WHITE (neutral)	BLACK (hot)	RED (hot)	BLUE (hot)	RED/BLACK (hot)
A3/8-2/12G	3	1	12	X	X	X			
A3/8-2/18G	3	1	18	X	X	X			
A3/8-3/12G	4	2	12	X	X	X	X		
A3/8-3/18G/EM	5	2 with EM	18	X	X	X		X	
A3/8-4/18G	5	3	18	X	X	X	X		X
A3/8-4/18G/EM	6	3 with EM	18	X	X	X	X	X	

NOTES: 1. For fixtures with emergencies, extra conductor must be added to accommodate hot lead for EM.

WIRING

Cord and Plug



ORDERING INFORMATION

SAMPLE NUMBER: 6-3/18SJT-CandP-515P

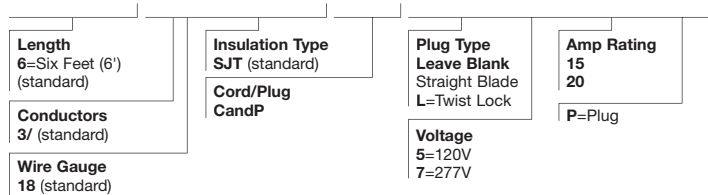

ATTACHED MODULAR WIRING OPTION

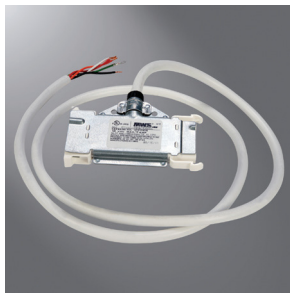

Description

MWS (Modular Wiring System) is a component system that provides a low cost and labor saving alternative to conventional hardwiring. The system uses interchangeable modular components, offering portability and versatility in lighting configurations. Metalux offers MWS installed on select fixtures. Below is the ordering instructions for adding MWS installed to Metalux fixtures. MWS offers a complete system of components for all of your wiring for lighting, as well as power. See the MWS section of this catalog (Page 11-1) for additional components.

MWS

COMMERCIAL APPLICATIONS

ORDERING INFORMATION FOR RECESSED LAYIN FIXTURES

SAMPLE NUMBER: 2GC8-232A-120V-EB81-MW12FF2GSL

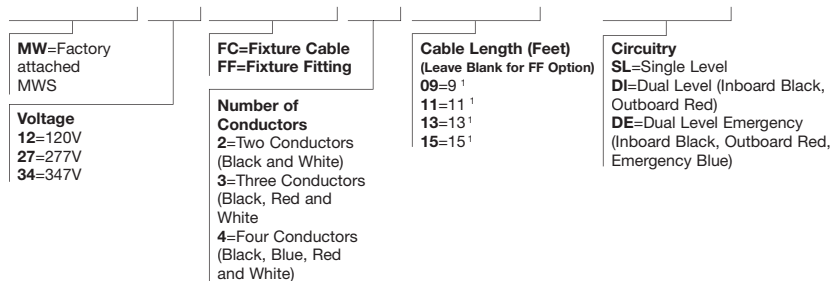

INDUSTRIAL APPLICATIONS

ORDERING INFORMATION FOR INDUSTRIALS AND STRIPS

SAMPLE NUMBER: I5-254T5-120V-EBT1-MW12DS12/2G11

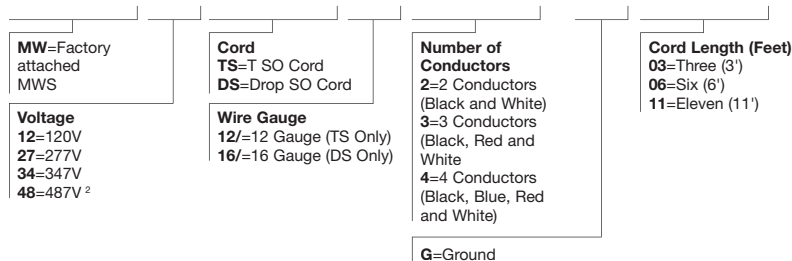

NOTES: 1. For FC option only. 2. Consult factory when specifying 480V.

TANDEM IN-LINE WIRING (TILW) OPTIONS

Description

The Tandem In-Line Wiring option provides factory installed wiring when fixture sections are applied in pairs, and require left/right lamp switching. To explain, ballast receive their power from the circuit, with lamps getting their power from the ballast. TILW is the method of applying power from the ballast to specific lamps. TILW only applies to two (2) or more lamp cross sections. If the luminaire has only one (1) row of lamps, TILW is already present and unnecessary to specify. The TILW option is available on IAF/ICF, DIF/DMF/ DVMF, SSF, SSL, SNF, SNSM, SNRA, RCG and I5/I8.

The following ballast configuration does not allow for TILW:

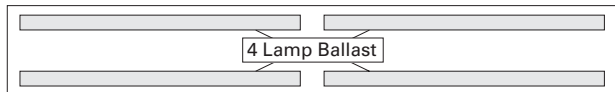

8TSSF-232-xxx-EB81

The following ballast configuration does not allow for TILW:

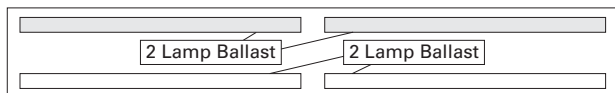

8TSSF-232-xxx-EB82-TILW

The TILW can also be used in applications where Master-Satellite configurations are required. Simply specify the appropriate Master-Satellite description followed by TILW. Standard TILW is provided with push-in connectors (shown below) for fixture wiring connections. Optional PITLW is provided with pre-configured wiring harness for quick and easy installation of Master-Satellite tandem in-line wired fixtures. Shown below is an example of a ballast configuration, along with sample fixture catalog number, including Master-Satellite and TILW.

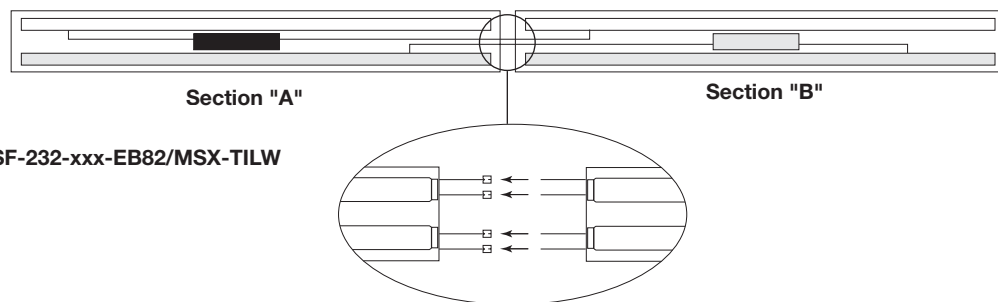

SSF-232-xxx-EB82/MSX-TILW

CROSS-OVER PLUG-IN SYSTEM WITH TWO (2) OR THREE (3) CIRCUIT CAPABILITY (CPI) OPTIONS

Description

The Metalux CPI Option has been designed to provide cross-circuit wiring capability. This versatile design internally routes power to the appropriate fixtures and requires only one luminaire type for the entire installation. It is no longer necessary to specify unique circuit wiring (black, blue, red) for each fixture. The new self-locking plug is designed to fit through a standard 7/8" knock-out to simplify the installation process.

Ordering the CPI Option is now much easier. One wiring harness type is required per row-mounted fixture. There is no need to color code. The black wire is always factory wired to the ballast lead and power routing to appropriate fixtures is achieved through the wiring design.

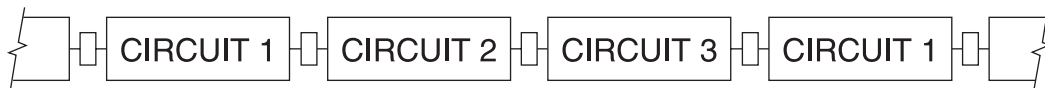

Example: A 3-circuit installation with a quantity of 200 SSF-296-120V-EB81 fixtures with ground wire.

Requires: Qty: 200 Fixture: SSF-296-120V-EB81-CPI3-WG

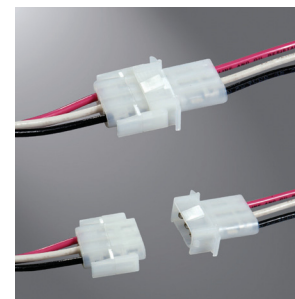

FEATURES

- Installed savings
- Molded nylon polarized plugs
- Two (2) or three (3) circuit capabilities
- No need to color code
- Self-locking plugs
- Branch circuit conductors #12 THHN rated 600V, 90C
- UL Listed.

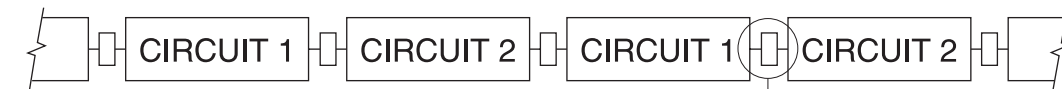

Example: A 2-circuit installation with a quantity of 200 SSF-296-120V-EB81 fixtures with ground wire.

Requires: Qty: 200 Fixture: SSF-296-120V-EB81-CPI2-WG

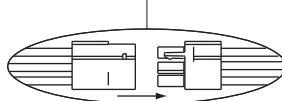

CPI - Cross Over Plug-In

SAMPLE NUMBER: CPI2-WG

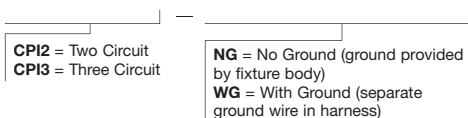

Specifications and dimensions subject to change without notice. Consult your Cooper Lighting Representative or visit www.cooperlighting.com for available options, accessories and ordering information.

PLUG-IN (PI) SYSTEM WITH 1, 2 OR 3 CIRCUIT CAPABILITY

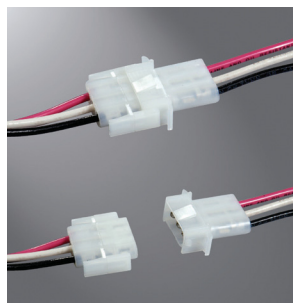

FEATURES

- Advanced plug-in system
- Three circuit capacity
- Installation savings
- Molded nylon polarized plugs
- Self-locking plugs
- Independent neutral available
- Branch circuit conductors #12 THHN rated 600V, 90°C
- UL Listed

PI PLUG-IN

Description

The Plug-In System provides factory installed branch circuit wiring and plug-in connectors when row mounting fixtures. This labor and time saving option is designed to simplify fixture installation and wiring and allows fixtures to be installed quickly and easily. The PI system is available for fixture sections up to 8' in length for continuous row wiring by simply plugging the sections together. Each PI section is factory wired to the ballast leads and is color coded for easy circuit identification. Standard PI system harness contains no separate ground wire, with ground provided by the fixture body. An option to the system provides a separate ground wire in the harness where required.

ORDERING INFORMATION

Catalog Number Suffix	Number of Circuits	Circuit Wired to Ballast
PI 1 BLK	1	Black
PI 2 BLU	2	Blue
PI 2 BLK	2	Black
PI 3 RED	3	Red
PI 3 BLU	3	Blue
PI 3 BLK	3	Black

When ordering the PI2/PI3 System it is necessary to specify the number of fixtures required for each circuit.

Example: 200 (Fixture Quantity) SSF-296-120V-PI2

Requires:

100 (Fixture Quantity) SSF-296-120V-PI2/BLK

100 (Fixture Quantity) SSF-296-120V-PI2/BLU

SSF-296-PI1=Specify wire color of BLK for single circuit PIs since all the ballast leads will be wired to the black and white wires.

SSF-296-PI2BLK=Two (2) circuit PI with ballast leads wired to black and white wires

SSF-296-PI2BLU=Two (2) circuit PI with ballast leads wired to blue and white wires

SSF-296-PI3RED=Three (3) circuit PI with ballast leads wired to red and white wires

The Plug-In System is available on fixtures using Rapid Start, Slimline (430 MA), High Output (800 MA), or Power Groove (1500 MA) lamps up to twenty (20) amps per circuit.

Available on the following fixture series:

Industrials

- IAF/ICF Series
- DIF/DMF /DVMF Series
- I5/I8

Strips

- SNF/SSF Series
- SNSM, SRA Series
- RCG Series
- SM/SML

Wraps are available with PI1 option only. For other fixture series availability consult factory.

PI1 - Single Circuit Plug-In

SAMPLE NUMBER: PI1BLK-WG

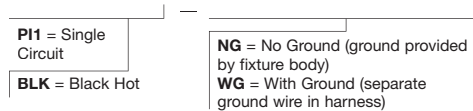

PI2 - Two Circuit Plug-In

SAMPLE NUMBER: PI2BLK-WG

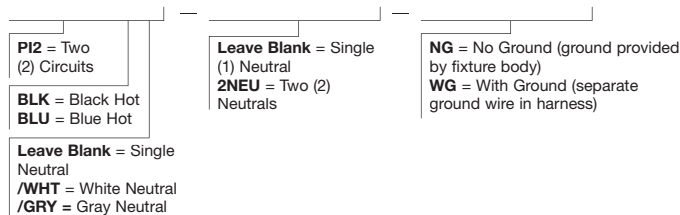

PI3 - Three Circuit Plug-In

SAMPLE NUMBER: PI3BLK-WG

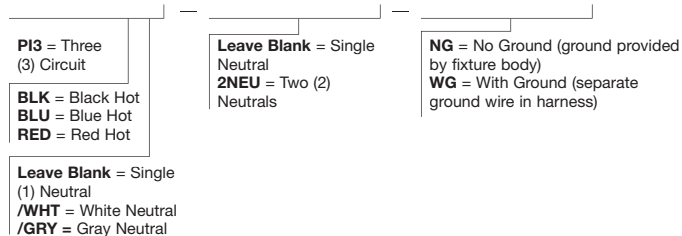

Specifications and dimensions subject to change without notice. Consult your Cooper Lighting Representative or visit www.cooperlighting.com for available options, accessories and ordering information.

TROUBLESHOOTING GUIDE

Fluorescent lighting is a very reliable and efficient source of lighting. Should problems occur use the quick reference guide to address them appropriately.

Symptom	Solution
Lamp(s) will not start or starts slow and erratic	<ol style="list-style-type: none"> 1. Confirm lamps are completely seated into sockets. 2. Confirm fixture is properly grounded (fixture must be grounded for reliable starting). 3. Confirm fixture is properly connected to power supply and check wiring and electrical connections. 4. Confirm fixture is receiving correct voltage. 5. Replace lamps. 6. Replace ballast.
Lamp(s) are flickering, snaking* or very dim	<ol style="list-style-type: none"> 1. Confirm all electrical connections inside fixture. 2. Confirm proper voltage at supply connection. 3. Confirm ambient temperature is above 50°F. Air conditioner or fans should not blow directly on lamps. A ballast rated for cold starting may need to be installed if necessary. 4. Replace ballast.
Electronic interference	<ol style="list-style-type: none"> 1. Electronics should be at least 8' from fluorescent ballast. More distance is recommended if interference persists. 2. Install an electronic interference filter. 3. Improve electronic equipment grounding. 4. Consult qualified electrician.
Repeated cycling (on/off)	<ol style="list-style-type: none"> 1. Confirm correct lamp wattage (check ballast label). 2. Confirm fixture temperature does not exceed rating. 3. Confirm all electrical connections inside fixture. 4. Confirm proper voltage at supply connection. 5. Replace ballast.

*Fluorescent lamps may experience starting problems when ambient temperature is below 50° F.

*New lamp with less than 100 hours of operation may exhibit flicker, strobing or snaking.