

Commercial grade straight blade duplex receptacles

Project Name:	Prepared By:
Project Number:	Date:
Catalog Number:	Type:

Description

2-Pole, 3-Wire Grounding
 15A 125V/AC; 15A 250V/AC
 20A 125V/AC; 20A 250V/AC
 NEMA 5-15, 5-20, 6-15, 6-20



5-15R



5-20R



6-15R



6-20R



BR15



CR20



1877

Design features

- Galvanized steel, wrap-around yoke mounting strap for superior assembly security; extra length/width helps reach large panel cutouts for Code Compliance
- Automatic grounding system eliminates need for bonding jumper in grounded metal enclosure, provides redundant measure of ground continuity where jumper used
- Screw-Catch feature on duplex devices speeds mounting of wallplates
- Tamper Resistant receptacles provide compliance with 2014 NEC® Article 406.12 that states that all 15A & 20A, 125V receptacles installed in dwelling units must be tamper resistant

Table 1. Commercial Grade Receptacles

Catalog No.	Description	Amps	Volts	Color Suffix
<input type="checkbox"/> BR15__	NEMA 5-15R Duplex Receptacle, Back & Side Wire	15	125	A, B, BK, GY, LA, V, W
<input type="checkbox"/> CR15__	NEMA 5-15R Duplex Receptacle, Side Wire	15	125	A, B, BK, GY, LA, V, W
<input type="checkbox"/> 817__	NEMA 5-15R Single Receptacle, Side Wire	15	125	B, BK, LA, V, W
<input type="checkbox"/> BR20__	NEMA 5-20R Duplex Receptacle, Back & Side Wire	20	125	A, B, BK, GY, LA, RD, V, W
<input type="checkbox"/> CR20__	NEMA 5-20R Duplex Receptacle, Side Wire	20	125	A, B, BK, GY, LA, V, W
<input type="checkbox"/> 1877__	NEMA 5-20R Single Receptacle, Side Wire	20	125	A, B, BK, LA, V, W
<input type="checkbox"/> 826__	NEMA 6-15R Duplex Receptacle, Side Wire	15	250	B, V, W
<input type="checkbox"/> 816__	NEMA 6-15R Single Receptacle, Side Wire	15	250	B, V, W
<input type="checkbox"/> 815__	NEMA 6-20R Duplex Receptacle, Side Wire	20	250	B, V, W
<input type="checkbox"/> 1876__	NEMA 6-20R Single Receptacle, Side Wire	20	250	A, B, BK, LA, V, W

Compliances, specifications and availability are subject to change without notice.



Powering Business Worldwide

Project Name:	Prepared By:
Project Number:	Date:
Catalog Number:	Type:



TR817

Table 2. Dual Voltage Commercial Grade Receptacles, Side Wire

Catalog No.	Description	Amps	Volts	Color
□ 829V	NEMA 5-15R/6-15R Dual Voltage Duplex Receptacle, Side Wire	15	125/ 250	V

Table 3. Commercial Grade Tamper Resistant Receptacles

Catalog No.	Description	Amps	Volts	Color Suffix
□ TRBR15__	NEMA 5-15R Tamper Resistant Duplex Receptacle, Back & Side Wire	15	125	A, B, BK, GY, LA, V, W
□ TRCR15__	NEMA 5-15R Tamper Resistant Duplex Receptacle, Side Wire	15	125	A, B, BK, GY, LA, V, W
□ TR817__	NEMA 5-15R Single Receptacle, Side Wire	15	125	A, B, BK, LA, V, W
□ TRBR20__	NEMA 5-20R Tamper Resistant Duplex Receptacle, Back & Side Wire	20	125	A, B, BK, GY, LA, RD, V, W
□ TRCR20__	NEMA 5-20R Tamper Resistant Duplex Receptacle, Side Wire	20	125	A, B, BK, GY, LA, V, W
□ TR1877__	NEMA 5-20 Single Receptacle, Side Wire	20	125	A, B, BK, LA, V, W

Project Name:	Prepared By:
Project Number:	Date:
Catalog Number:	Type:

Applications

Commercial grade duplex receptacles are challenged on a daily basis to provide a consistent, reliable means of connectivity in a wide variety of environments. The applications vary greatly by environment, and provide challenges from impact and chemical resistance to environmental extremes such as heat and moisture. The breadth of the Arrow Hart Straight Blade Receptacle line provides solutions for all environments and applications.

Table 4. Specifications

Catalog No.	BR15, BR20, Series	CR15, CR20 Series	815, 826 Series
Device Type	Straight Blade Duplex Receptacles, BR Series	Straight Blade Duplex Receptacles, CR Series	Straight Blade Duplex Receptacles
Wiring Type	Back & side wire	Side wire	Side wire
Testing & Code Compliance	<ul style="list-style-type: none"> cULus Listed to UL 498, file no. E15058 CSA Certified to C22.2, no. 42, file no. 6914, class 6233-01 UL verified to Federal Spec. WC-596G NOM certified 	<ul style="list-style-type: none"> cULus Listed to UL 498, file no. E15058 UL verified to Federal Spec. WC-596G NOM certified 	<ul style="list-style-type: none"> cULus Listed to UL 498, file no. E15058 UL verified to Federal Spec. WC-596G NOM certified
Environmental Specifications	Flammability: Meets UL 94 requirements; V2 rated Temperature Rating: -20°C to 60°C (-4°F to 140°F)	Flammability: Meets UL 94 requirements; V2 rated Temperature Rating: -20°C to 60°C (-4°F to 140°F)	Flammability: Meets UL 94 requirements; V2 rated Temperature Rating: -20°C to 60°C (-4°F to 140°F)
Electrical Specifications	Dielectric Voltage: Withstands 2000V per UL 498 Current Interrupting: Yes, at full-rated current Temperature Rise: Max. 30°C (86°F) after 100 cycles of overload @ 150% of rated current (DC)	Dielectric Voltage: Withstands 2000V per UL 498 Current Interrupting: Yes, at full-rated current Temperature Rise: Max. 30°C (86°F) after 100 cycles of overload @ 150% of rated current (DC)	Dielectric Voltage: Withstands 2000V per UL 498 Current Interrupting: Yes, at full-rated current Temperature Rise: Max. 30°C (86°F) after 100 cycles of overload VVV@ 150% of rated current (DC)
Mechanical Specifications	Terminal Accommodation: #14 - 10 AWG Voltage Ratings: Permanently marked on device	Terminal Accommodation: #14 - 10 AWG Voltage Ratings: Permanently marked on device	Terminal Accommodation: #14 - 10 AWG Voltage Ratings: Permanently marked on device

Table 5. Materials

Catalog No.	BR15, BR20, Series	CR15, CR20 Series	815, 826 Series
Top Housing	Nylon	PVC	PC
Bottom Housing	PVC	PVC	PC
Strap	0.046" thick galvanized steel	0.040" thick galvanized steel	0.040" thick galvanized steel
Ground Contact	0.030" thick brass	0.030" thick brass	0.030" thick brass
Auto Ground	Phosphor bronze staple	Phosphor bronze staple	Phosphor bronze staple
Line Contacts	.030" thick 3-leaf brass	.030" thick 3-leaf neutral/2-leaf hot brass	.030" thick 3-leaf brass
Terminal Screws	#8-32 Steel brass plated hot	#8-32 Steel brass plated hot	#8-32 Steel brass plated hot
Ground Screw	#8-32 Steel (Green)	#8-32 Steel (Green)	#8-32 Steel (Green)
Tamper Resistant Shutters	N/A	N/A	N/A

Project Name:	Prepared By:
Project Number:	Date:
Catalog Number:	Type:

Table 6. Specifications

Catalog No.	829 Series	817, 1877 Series	816, 1876 Series
Device Type	Straight Blade Dual Voltage Duplex Receptacles	Straight Blade Single Receptacles	Straight Blade Single Receptacles
Wiring Type	Side wire	Side wire	Side wire
Testing & Code Compliance	<ul style="list-style-type: none"> UL Listed to UL 498, file no. E15058 CSA Certified to C22.2, no. 42, file no. 6914, class 6233-01 NOM certified 	<ul style="list-style-type: none"> UL Listed to UL 498, file no. E15058 CSA Certified to C22.2, no. 42, file no. 6914, class 6233-01 NOM certified 	<ul style="list-style-type: none"> cULus Listed to UL 498, file no. E15058 NOM certified
Environmental Specifications	Flammability: Meets UL 94 requirements; V2 rated Temperature Rating: -20°C to 60°C (-4°F to 140°F)	Flammability: Meets UL 94 requirements; V2 rated Temperature Rating: -20°C to 60°C (-4°F to 140°F)	Flammability: Meets UL 94 requirements; V2 rated Temperature Rating: -20°C to 60°C (-4°F to 140°F)
Electrical Specifications	Dielectric Voltage: Withstands 2000V per UL 498 Current Interrupting: Yes, at full-rated current Temperature Rise: Max. 30°C (86°F) after 100 cycles of overload @ 150% of rated current (DC)	Dielectric Voltage: Withstands 2000V per UL 498 Current Interrupting: Yes, at full-rated current Temperature Rise: Max. 30°C (86°F) after 100 cycles of overload @ 150% of rated current (DC)	Dielectric Voltage: Withstands 2000V per UL 498 Current Interrupting: Yes, at full-rated current Temperature Rise: Max. 30°C (86°F) after 100 cycles of overload WW@ 150% of rated current (DC)
Mechanical Specifications	Terminal Accommodation: #14 - 10 AWG Voltage Ratings: Permanently marked on device	Terminal Accommodation: #14 - 10 AWG Voltage Ratings: Permanently marked on device	Terminal Accommodation: #14 - 10 AWG Voltage Ratings: Permanently marked on device

Table 7. Materials

Catalog No.	829 Series	817, 1877 Series	816, 1876 Series
Top Housing	PC	PVC	Nylon
Bottom Housing	PC	PVC	PVC
Strap	0.040" thick galvanized steel	0.040" thick galvanized steel	0.040" thick galvanized steel
Ground Contact	0.030" thick brass	0.030" thick brass	0.030" thick brass
Auto Ground	Phosphor bronze staple	N/A	N/A
Line Contacts	.030" thick 3-leaf neutral/2-leaf hot brass	.030" thick 3-leaf brass	.030" thick 3-leaf brass
Terminal Screws	#8-32 Steel brass plated hot	#8-32 Steel brass plated hot	#8-32 Steel brass plated hot
Ground Screw	#8-32 Steel (Green)	#8-32 Steel (Green)	#8-32 Steel (Green)
Tamper Resistant Shutters	N/A	N/A	N/A

Project Name:	Prepared By:
Project Number:	Date:
Catalog Number:	Type:

Table 8. Specifications

Catalog No.	TRBR15, TRCR15, TRBR20, TRCR20 Series	TR817, TR1877 Series
Device Type	Tamper Resistant Straight Blade Duplex Receptacles	Tamper Resistant Straight Blade Single Receptacles
Wiring Type	Back & side wire (TRCR side wire only)	Side wire
Testing & Code Compliance	<ul style="list-style-type: none"> • cULus Listed to UL 498, file no. E15058 • UL verified to Federal Spec. WVC-596G (TRBR only) • NOM certified 	<ul style="list-style-type: none"> • cULus Listed to UL 498, file no. E15058 • NOM certified
Environmental Specifications	Flammability: Meets UL 94 requirements; V2 rated Temperature Rating: -20°C to 60°C (-4°F to 140°F)	Flammability: Meets UL 94 requirements; V2 rated Temperature Rating: -20°C to 60°C (-4°F to 140°F)
Electrical Specifications	Dielectric Voltage: Withstands 2000V per UL 498 Current Interrupting: Yes, at full-rated current Temperature Rise: Max. 30°C (86°F) after 100 cycles of overload @ 150% of rated current (DC)	Dielectric Voltage: Withstands 2000V per UL 498 Current Interrupting: Yes, at full-rated current Temperature Rise: Max. 30°C (86°F) after 100 cycles of overload @ 150% of rated current (DC)
Mechanical Specifications	Terminal Accommodation: #14 - 10 AWG Voltage Ratings: Permanently marked on device	Terminal Accommodation: #14 - 10 AWG Voltage Ratings: Permanently marked on device

Table 9. Materials

Catalog No.	TRBR15, TRCR15, TRBR20, TRCR20 Series	TR817, TR1877 Series
Top Housing	PVC	PVC
Bottom Housing	PVC	PVC
Strap	0.040" thick galvanized steel	0.040" thick galvanized steel
Ground Contact	0.030" thick brass	0.030" thick brass
Auto Ground	Phosphor bronze staple	Phosphor bronze staple
Line Contacts	.030" thick 3-leaf neutral/2-leaf hot brass	.030" thick 3-leaf brass
Terminal Screws	#8-32 Steel brass plated hot	#8-32 Steel brass plated hot
Ground Screw	#8-32 Steel (Green)	#8-32 Steel (Green)
Tamper Resistant Shutters	Reliable Delrin® shutter assembly	Reliable Delrin® shutter assembly

Table 10. Color Ordering Information

For ordering devices, include Cat. No. followed by the color code: A (Almond), B (Brown), BK (Black), GY (Gray) LA (Light Almond), RD (Red), V (Ivory), W (White)

A	B	BK	GY	LA	RD	V	W
Almond	Brown	Black	Gray	Lt. Almond	Red	Ivory	White

Project Name:	Prepared By:
Project Number:	Date:
Catalog Number:	Type:

Product Dimensions

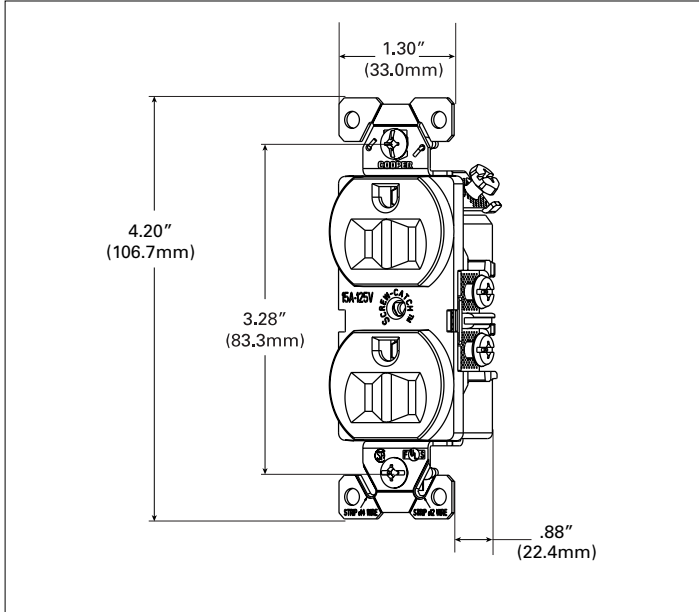

Figure 1. BR15 Line Art with Dimensions

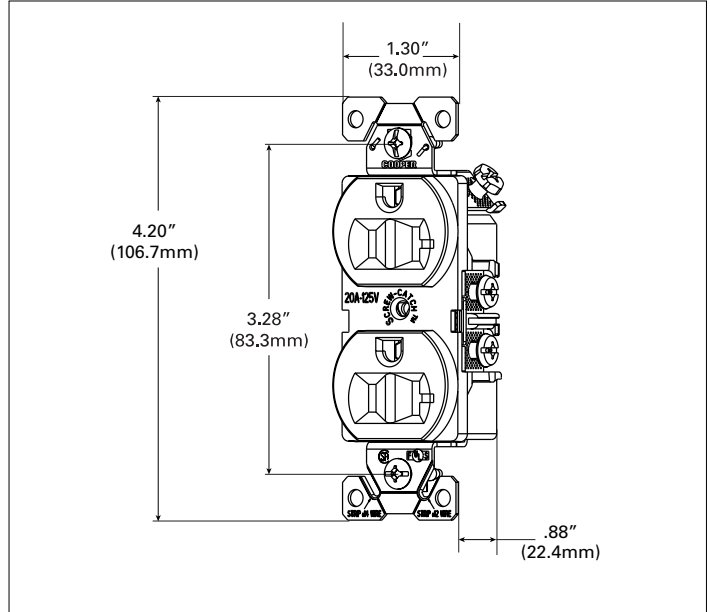

Figure 2. BR20 Line Art with Dimensions

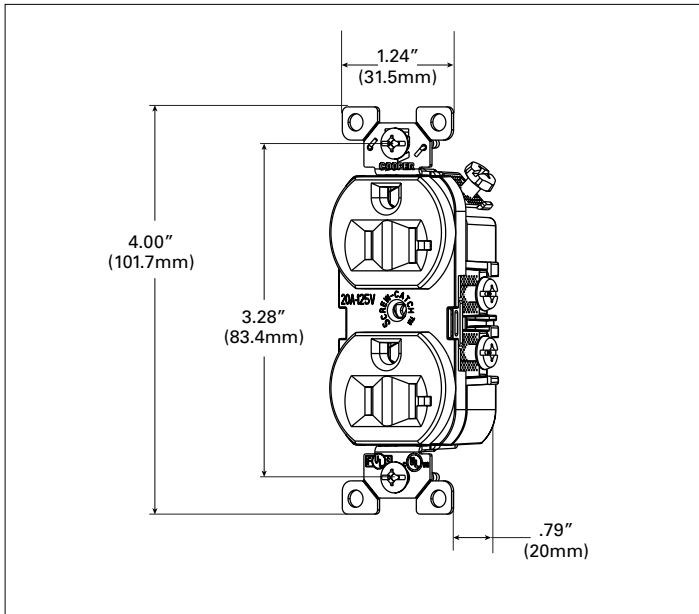

Figure 3. CR20 Line Art with Dimensions

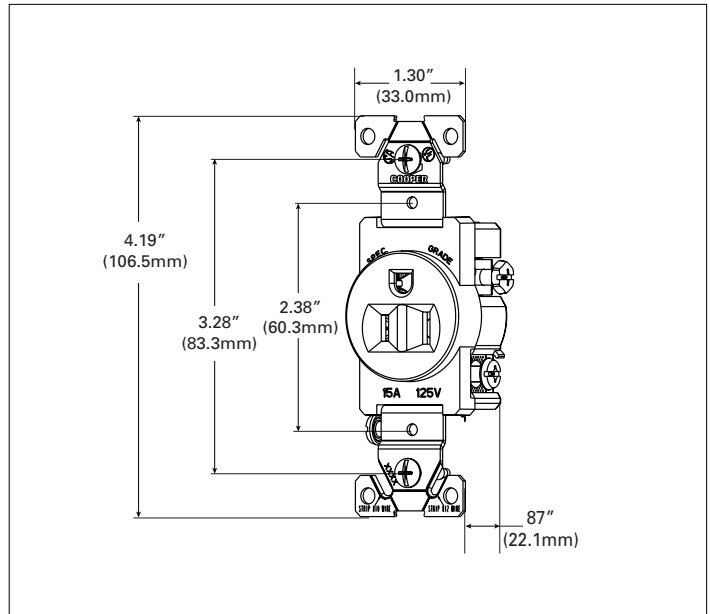

Figure 4. 817 Line Art with Dimensions

Project Name:	Prepared By:
Project Number:	Date:
Catalog Number:	Type:

Product Dimensions

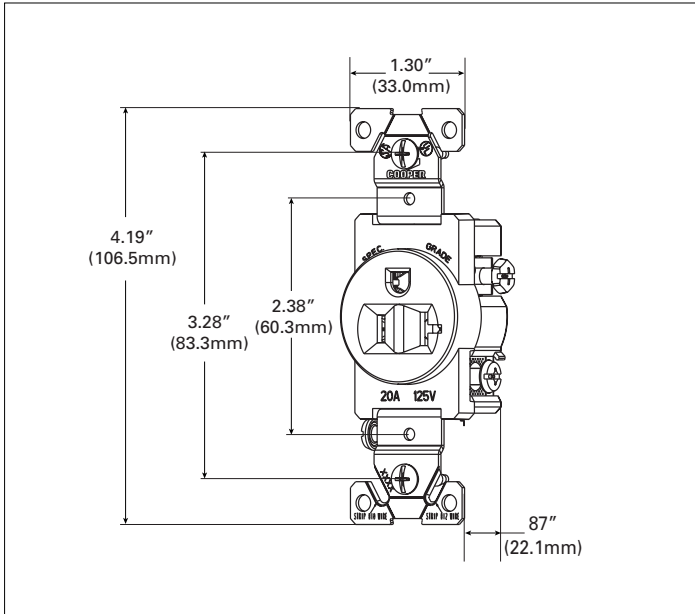

Figure 5. 1877 Line Art with Dimensions

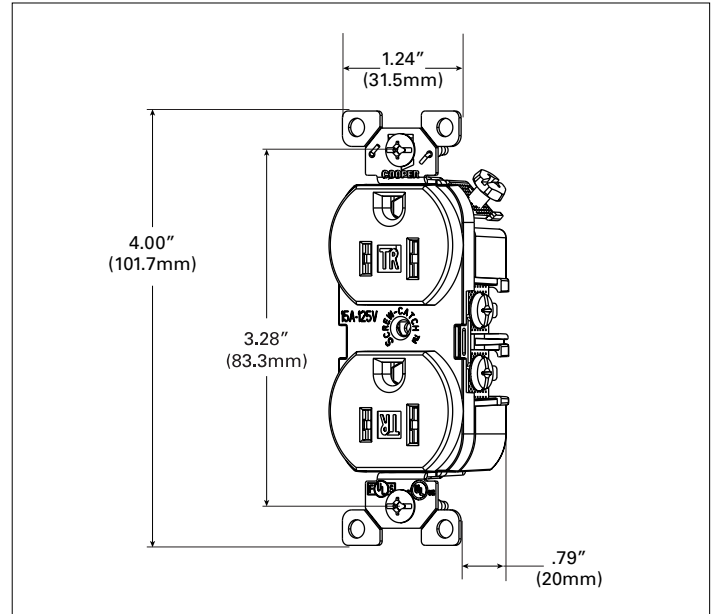

Figure 6. TRBR15 Line Art with Dimensions

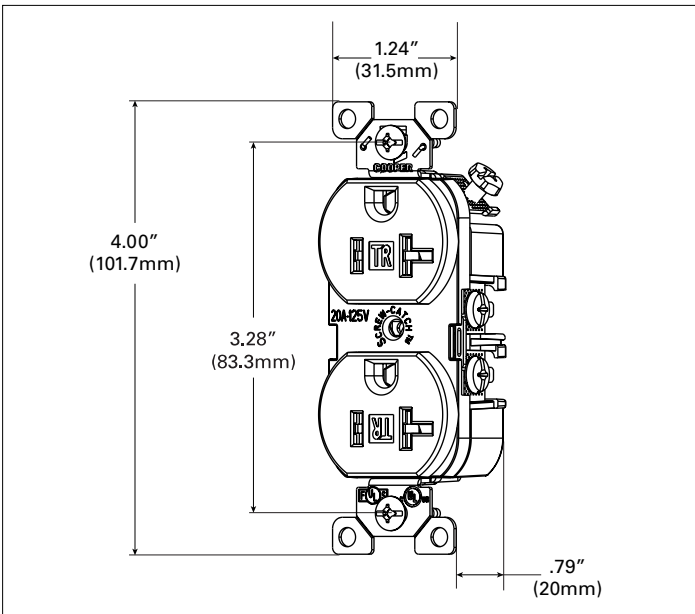

Figure 7. TRBR20 Line Art with Dimensions

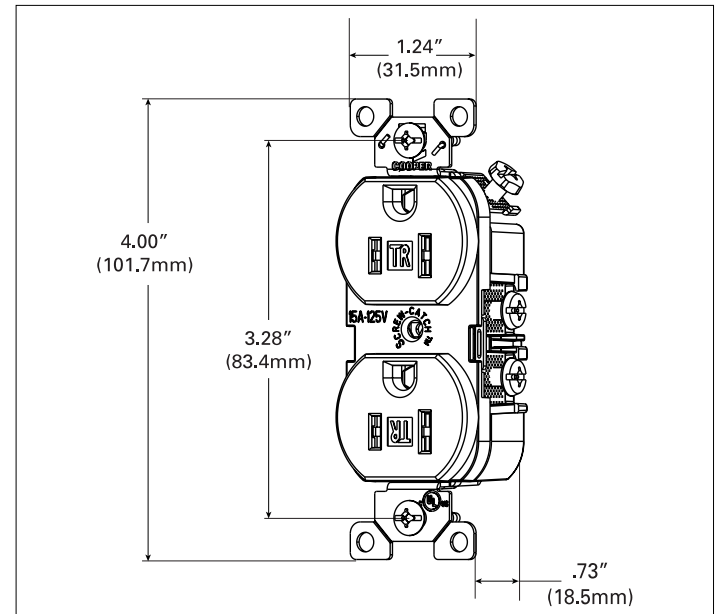

Figure 8. TRCR15 Line Art with Dimensions

Project Name:	Prepared By:
Project Number:	Date:
Catalog Number:	Type:

Product Dimensions

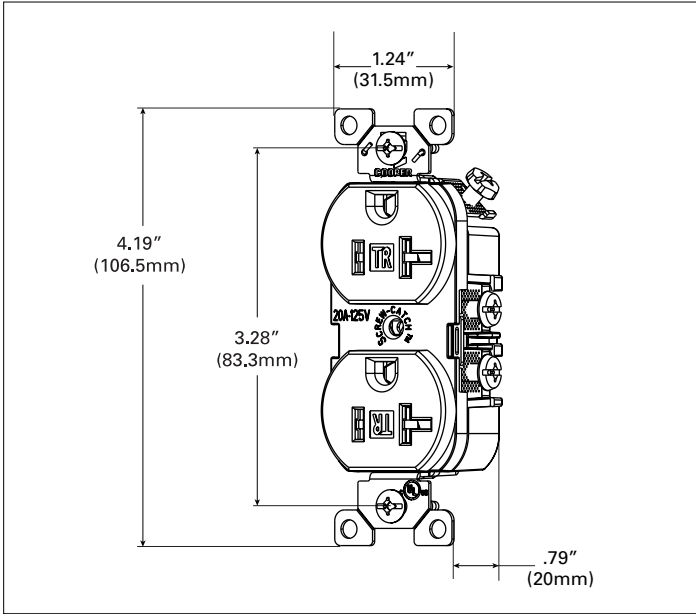

Figure 9. TRCR20 Line Art with Dimensions

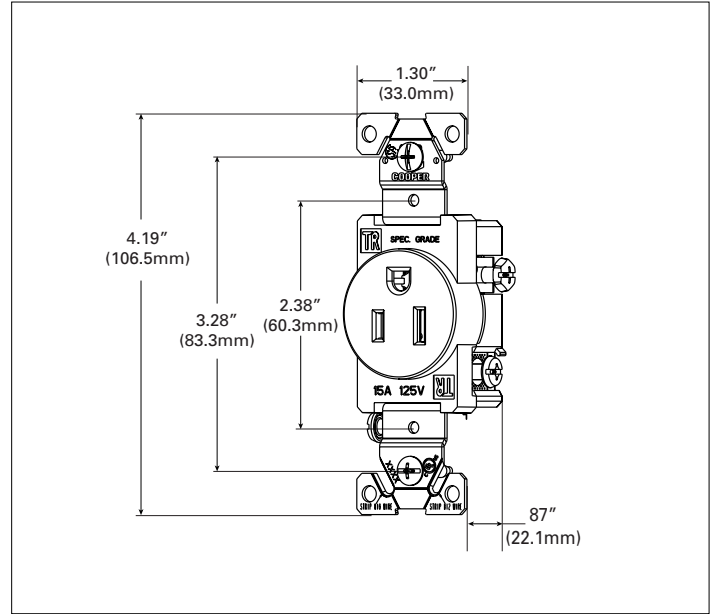

Figure 10. TR817 Line Art with Dimensions

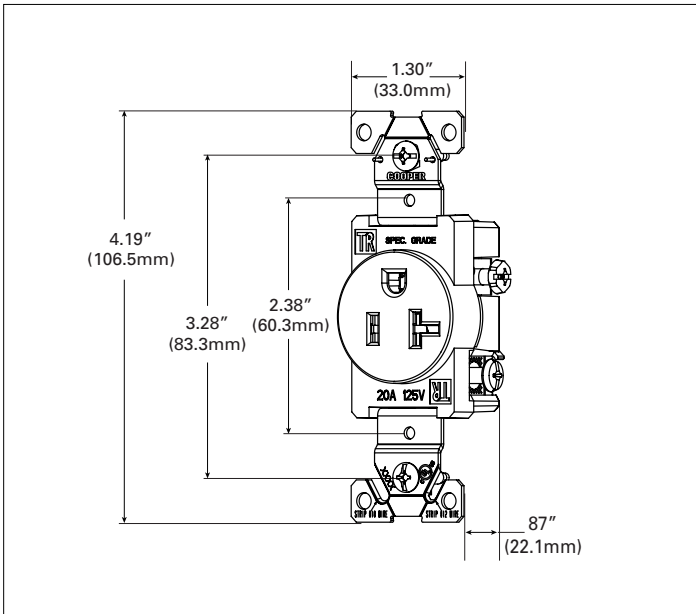











Figure 11. TR1877 Line Art with Dimensions

Project Name:	Prepared By:
Project Number:	Date:
Catalog Number:	Type:

Certifications & compliances

Catalog No.									
BR15	•	•	•	•	•	•	•	•	•
CR15	•		•			•		•	•
817		•		•	•	•		•	•
BR20	•	•	•	•	•	•	•	•	•
CR20	•		•			•		•	•
1877		•		•	•	•		•	•
826	•		•			•		•	•
816	•		•			•		•	•
815	•	•	•		•	•		•	•
1876	•		•			•		•	•
829		•	•		•	•		•	•
TRBR15	•		•			•	•	•	•
TRCR15	•					•		•	•
TR817	•		•			•		•	•
TRBR20	•		•			•	•	•	•
TRCR20	•					•		•	•
TR1877	•					•		•	•

KEY:  cULus  UL  Fed Spec  NAFTA  CSA
 NOM  Arrowlink  Build-To-Spec  ROHS

 Parts are manufactured and designed in accordance with article 4 of the European Union's RoHS2 directive 2011/65/EU

 Build-To-Spec Customizable Devices

Compliances, specifications and availability are subject to change without notice.

Electrical Sector
203 Cooper Circle
Peachtree City, GA 30269
United States
Eaton.com
Eaton.com/arrowhart

Electrical Sector
Canada Operations
5925 McLaughlin Road
Mississauga, Ontario, L5R 1B8
Canada
EatonCanada.ca
Eaton.com/arrowhart

Electrical Sector
Mexico Operations
Carr. Tlalnepantla -
Cuautitlan Km 17.8 s/n
Col. Villa Jardin esq.
Cerrada 8 de Mayo
Cuautitlan, Mexico CP 54800
Mexico
Eaton.mx
Eaton.com/arrowhart

Commercial grade straight blade duplex receptacles

Project Name:	Prepared By:
Project Number:	Date:
Catalog Number:	Type:

Description

2-Pole, 3-Wire Grounding
 15A 125V/AC; 15A 250V/AC
 20A 125V/AC; 20A 250V/AC
 NEMA 5-15, 5-20, 6-15, 6-20



5-15R



5-20R



6-15R



6-20R



BR15



CR20



1877

Design features

- Galvanized steel, wrap-around yoke mounting strap for superior assembly security; extra length/width helps reach large panel cutouts for Code Compliance
- Automatic grounding system eliminates need for bonding jumper in grounded metal enclosure, provides redundant measure of ground continuity where jumper used
- Screw-Catch feature on duplex devices speeds mounting of wallplates
- Tamper Resistant receptacles provide compliance with 2014 NEC® Article 406.12 that states that all 15A & 20A, 125V receptacles installed in dwelling units must be tamper resistant

Table 1. Commercial Grade Receptacles

Catalog No.	Description	Amps	Volts	Color Suffix
<input type="checkbox"/> BR15__	NEMA 5-15R Duplex Receptacle, Back & Side Wire	15	125	A, B, BK, GY, LA, V, W
<input type="checkbox"/> CR15__	NEMA 5-15R Duplex Receptacle, Side Wire	15	125	A, B, BK, GY, LA, V, W
<input type="checkbox"/> 817__	NEMA 5-15R Single Receptacle, Side Wire	15	125	B, BK, LA, V, W
<input type="checkbox"/> BR20__	NEMA 5-20R Duplex Receptacle, Back & Side Wire	20	125	A, B, BK, GY, LA, RD, V, W
<input type="checkbox"/> CR20__	NEMA 5-20R Duplex Receptacle, Side Wire	20	125	A, B, BK, GY, LA, V, W
<input type="checkbox"/> 1877__	NEMA 5-20R Single Receptacle, Side Wire	20	125	A, B, BK, LA, V, W
<input type="checkbox"/> 826__	NEMA 6-15R Duplex Receptacle, Side Wire	15	250	B, V, W
<input type="checkbox"/> 816__	NEMA 6-15R Single Receptacle, Side Wire	15	250	B, V, W
<input type="checkbox"/> 815__	NEMA 6-20R Duplex Receptacle, Side Wire	20	250	B, V, W
<input type="checkbox"/> 1876__	NEMA 6-20R Single Receptacle, Side Wire	20	250	A, B, BK, LA, V, W

Compliances, specifications and availability are subject to change without notice.



Powering Business Worldwide

Project Name:	Prepared By:
Project Number:	Date:
Catalog Number:	Type:



TR817

Table 2. Dual Voltage Commercial Grade Receptacles, Side Wire

Catalog No.	Description	Amps	Volts	Color
□ 829V	NEMA 5-15R/6-15R Dual Voltage Duplex Receptacle, Side Wire	15	125/ 250	V

Table 3. Commercial Grade Tamper Resistant Receptacles

Catalog No.	Description	Amps	Volts	Color Suffix
□ TRBR15__	NEMA 5-15R Tamper Resistant Duplex Receptacle, Back & Side Wire	15	125	A, B, BK, GY, LA, V, W
□ TRCR15__	NEMA 5-15R Tamper Resistant Duplex Receptacle, Side Wire	15	125	A, B, BK, GY, LA, V, W
□ TR817__	NEMA 5-15R Single Receptacle, Side Wire	15	125	A, B, BK, LA, V, W
□ TRBR20__	NEMA 5-20R Tamper Resistant Duplex Receptacle, Back & Side Wire	20	125	A, B, BK, GY, LA, RD, V, W
□ TRCR20__	NEMA 5-20R Tamper Resistant Duplex Receptacle, Side Wire	20	125	A, B, BK, GY, LA, V, W
□ TR1877__	NEMA 5-20 Single Receptacle, Side Wire	20	125	A, B, BK, LA, V, W

Project Name:	Prepared By:
Project Number:	Date:
Catalog Number:	Type:

Applications

Commercial grade duplex receptacles are challenged on a daily basis to provide a consistent, reliable means of connectivity in a wide variety of environments. The applications vary greatly by environment, and provide challenges from impact and chemical resistance to environmental extremes such as heat and moisture. The breadth of the Arrow Hart Straight Blade Receptacle line provides solutions for all environments and applications.

Table 4. Specifications

Catalog No.	BR15, BR20, Series	CR15, CR20 Series	815, 826 Series
Device Type	Straight Blade Duplex Receptacles, BR Series	Straight Blade Duplex Receptacles, CR Series	Straight Blade Duplex Receptacles
Wiring Type	Back & side wire	Side wire	Side wire
Testing & Code Compliance	<ul style="list-style-type: none"> cULus Listed to UL 498, file no. E15058 CSA Certified to C22.2, no. 42, file no. 6914, class 6233-01 UL verified to Federal Spec. WC-596G NOM certified 	<ul style="list-style-type: none"> cULus Listed to UL 498, file no. E15058 UL verified to Federal Spec. WC-596G NOM certified 	<ul style="list-style-type: none"> cULus Listed to UL 498, file no. E15058 UL verified to Federal Spec. WC-596G NOM certified
Environmental Specifications	Flammability: Meets UL 94 requirements; V2 rated Temperature Rating: -20°C to 60°C (-4°F to 140°F)	Flammability: Meets UL 94 requirements; V2 rated Temperature Rating: -20°C to 60°C (-4°F to 140°F)	Flammability: Meets UL 94 requirements; V2 rated Temperature Rating: -20°C to 60°C (-4°F to 140°F)
Electrical Specifications	Dielectric Voltage: Withstands 2000V per UL 498 Current Interrupting: Yes, at full-rated current Temperature Rise: Max. 30°C (86°F) after 100 cycles of overload @ 150% of rated current (DC)	Dielectric Voltage: Withstands 2000V per UL 498 Current Interrupting: Yes, at full-rated current Temperature Rise: Max. 30°C (86°F) after 100 cycles of overload @ 150% of rated current (DC)	Dielectric Voltage: Withstands 2000V per UL 498 Current Interrupting: Yes, at full-rated current Temperature Rise: Max. 30°C (86°F) after 100 cycles of overload VVV@ 150% of rated current (DC)
Mechanical Specifications	Terminal Accommodation: #14 - 10 AWG Voltage Ratings: Permanently marked on device	Terminal Accommodation: #14 - 10 AWG Voltage Ratings: Permanently marked on device	Terminal Accommodation: #14 - 10 AWG Voltage Ratings: Permanently marked on device

Table 5. Materials

Catalog No.	BR15, BR20, Series	CR15, CR20 Series	815, 826 Series
Top Housing	Nylon	PVC	PC
Bottom Housing	PVC	PVC	PC
Strap	0.046" thick galvanized steel	0.040" thick galvanized steel	0.040" thick galvanized steel
Ground Contact	0.030" thick brass	0.030" thick brass	0.030" thick brass
Auto Ground	Phosphor bronze staple	Phosphor bronze staple	Phosphor bronze staple
Line Contacts	.030" thick 3-leaf brass	.030" thick 3-leaf neutral/2-leaf hot brass	.030" thick 3-leaf brass
Terminal Screws	#8-32 Steel brass plated hot	#8-32 Steel brass plated hot	#8-32 Steel brass plated hot
Ground Screw	#8-32 Steel (Green)	#8-32 Steel (Green)	#8-32 Steel (Green)
Tamper Resistant Shutters	N/A	N/A	N/A

Project Name:	Prepared By:
Project Number:	Date:
Catalog Number:	Type:

Table 6. Specifications

Catalog No.	829 Series	817, 1877 Series	816, 1876 Series
Device Type	Straight Blade Dual Voltage Duplex Receptacles	Straight Blade Single Receptacles	Straight Blade Single Receptacles
Wiring Type	Side wire	Side wire	Side wire
Testing & Code Compliance	<ul style="list-style-type: none"> UL Listed to UL 498, file no. E15058 CSA Certified to C22.2, no. 42, file no. 6914, class 6233-01 NOM certified 	<ul style="list-style-type: none"> UL Listed to UL 498, file no. E15058 CSA Certified to C22.2, no. 42, file no. 6914, class 6233-01 NOM certified 	<ul style="list-style-type: none"> cULus Listed to UL 498, file no. E15058 NOM certified
Environmental Specifications	Flammability: Meets UL 94 requirements; V2 rated Temperature Rating: -20°C to 60°C (-4°F to 140°F)	Flammability: Meets UL 94 requirements; V2 rated Temperature Rating: -20°C to 60°C (-4°F to 140°F)	Flammability: Meets UL 94 requirements; V2 rated Temperature Rating: -20°C to 60°C (-4°F to 140°F)
Electrical Specifications	Dielectric Voltage: Withstands 2000V per UL 498 Current Interrupting: Yes, at full-rated current Temperature Rise: Max. 30°C (86°F) after 100 cycles of overload @ 150% of rated current (DC)	Dielectric Voltage: Withstands 2000V per UL 498 Current Interrupting: Yes, at full-rated current Temperature Rise: Max. 30°C (86°F) after 100 cycles of overload @ 150% of rated current (DC)	Dielectric Voltage: Withstands 2000V per UL 498 Current Interrupting: Yes, at full-rated current Temperature Rise: Max. 30°C (86°F) after 100 cycles of overload WW@ 150% of rated current (DC)
Mechanical Specifications	Terminal Accommodation: #14 - 10 AWG Voltage Ratings: Permanently marked on device	Terminal Accommodation: #14 - 10 AWG Voltage Ratings: Permanently marked on device	Terminal Accommodation: #14 - 10 AWG Voltage Ratings: Permanently marked on device

Table 7. Materials

Catalog No.	829 Series	817, 1877 Series	816, 1876 Series
Top Housing	PC	PVC	Nylon
Bottom Housing	PC	PVC	PVC
Strap	0.040" thick galvanized steel	0.040" thick galvanized steel	0.040" thick galvanized steel
Ground Contact	0.030" thick brass	0.030" thick brass	0.030" thick brass
Auto Ground	Phosphor bronze staple	N/A	N/A
Line Contacts	.030" thick 3-leaf neutral/2-leaf hot brass	.030" thick 3-leaf brass	.030" thick 3-leaf brass
Terminal Screws	#8-32 Steel brass plated hot	#8-32 Steel brass plated hot	#8-32 Steel brass plated hot
Ground Screw	#8-32 Steel (Green)	#8-32 Steel (Green)	#8-32 Steel (Green)
Tamper Resistant Shutters	N/A	N/A	N/A

Project Name:	Prepared By:
Project Number:	Date:
Catalog Number:	Type:

Table 8. Specifications

Catalog No.	TRBR15, TRCR15, TRBR20, TRCR20 Series	TR817, TR1877 Series
Device Type	Tamper Resistant Straight Blade Duplex Receptacles	Tamper Resistant Straight Blade Single Receptacles
Wiring Type	Back & side wire (TRCR side wire only)	Side wire
Testing & Code Compliance	<ul style="list-style-type: none"> cULus Listed to UL 498, file no. E15058 UL verified to Federal Spec. WVC-596G (TRBR only) NOM certified 	<ul style="list-style-type: none"> cULus Listed to UL 498, file no. E15058 NOM certified
Environmental Specifications	Flammability: Meets UL 94 requirements; V2 rated Temperature Rating: -20°C to 60°C (-4°F to 140°F)	Flammability: Meets UL 94 requirements; V2 rated Temperature Rating: -20°C to 60°C (-4°F to 140°F)
Electrical Specifications	Dielectric Voltage: Withstands 2000V per UL 498 Current Interrupting: Yes, at full-rated current Temperature Rise: Max. 30°C (86°F) after 100 cycles of overload @ 150% of rated current (DC)	Dielectric Voltage: Withstands 2000V per UL 498 Current Interrupting: Yes, at full-rated current Temperature Rise: Max. 30°C (86°F) after 100 cycles of overload @ 150% of rated current (DC)
Mechanical Specifications	Terminal Accommodation: #14 - 10 AWG Voltage Ratings: Permanently marked on device	Terminal Accommodation: #14 - 10 AWG Voltage Ratings: Permanently marked on device

Table 9. Materials

Catalog No.	TRBR15, TRCR15, TRBR20, TRCR20 Series	TR817, TR1877 Series
Top Housing	PVC	PVC
Bottom Housing	PVC	PVC
Strap	0.040" thick galvanized steel	0.040" thick galvanized steel
Ground Contact	0.030" thick brass	0.030" thick brass
Auto Ground	Phosphor bronze staple	Phosphor bronze staple
Line Contacts	.030" thick 3-leaf neutral/2-leaf hot brass	.030" thick 3-leaf brass
Terminal Screws	#8-32 Steel brass plated hot	#8-32 Steel brass plated hot
Ground Screw	#8-32 Steel (Green)	#8-32 Steel (Green)
Tamper Resistant Shutters	Reliable Delrin® shutter assembly	Reliable Delrin® shutter assembly

Table 10. Color Ordering Information

For ordering devices, include Cat. No. followed by the color code: A (Almond), B (Brown), BK (Black), GY (Gray) LA (Light Almond), RD (Red), V (Ivory), W (White)

A	B	BK	GY	LA	RD	V	W
Almond	Brown	Black	Gray	Lt. Almond	Red	Ivory	White

Project Name:	Prepared By:
Project Number:	Date:
Catalog Number:	Type:

Product Dimensions

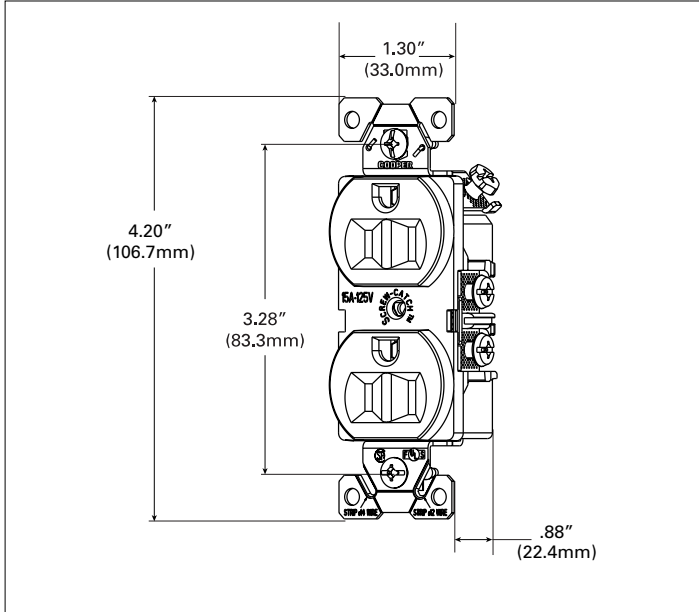

Figure 1. BR15 Line Art with Dimensions

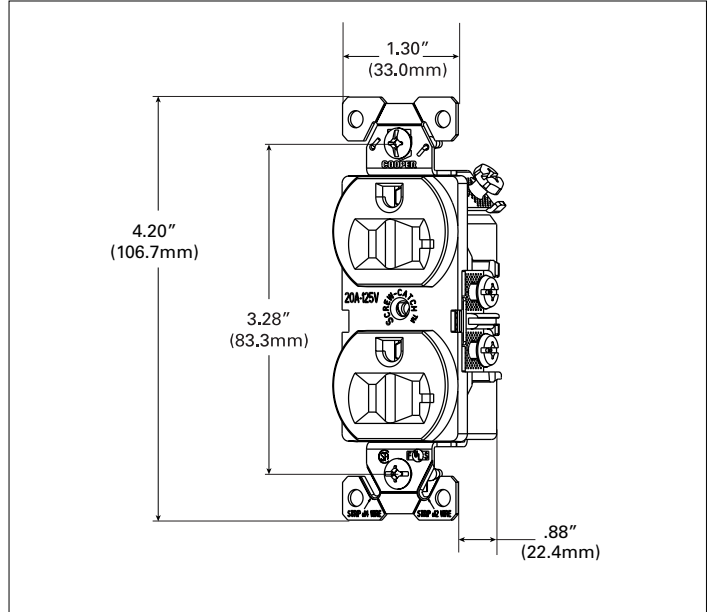

Figure 2. BR20 Line Art with Dimensions

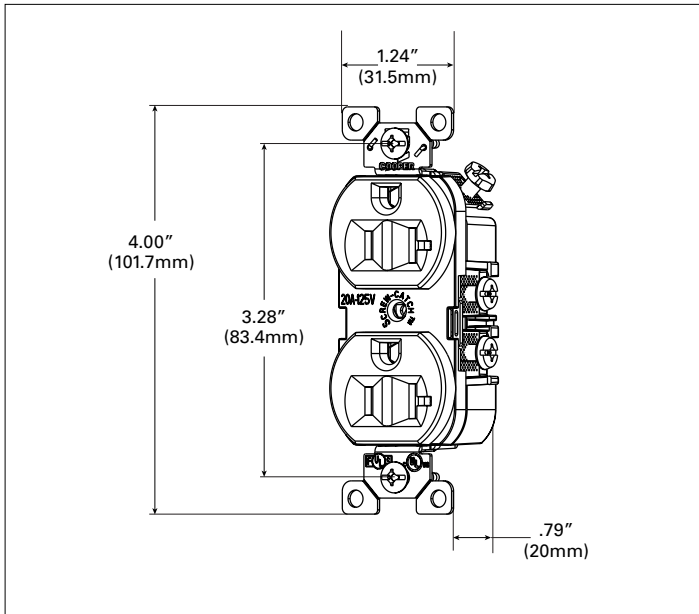

Figure 3. CR20 Line Art with Dimensions

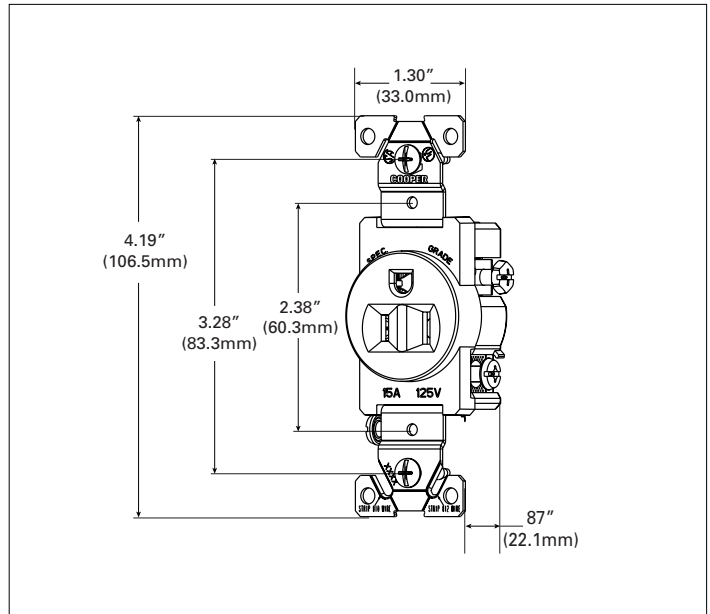

Figure 4. 817 Line Art with Dimensions

Project Name:	Prepared By:
Project Number:	Date:
Catalog Number:	Type:

Product Dimensions

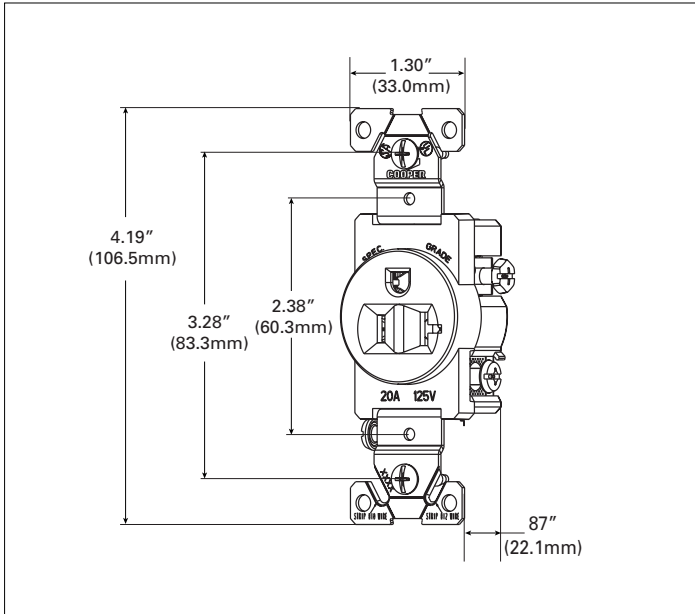

Figure 5. 1877 Line Art with Dimensions

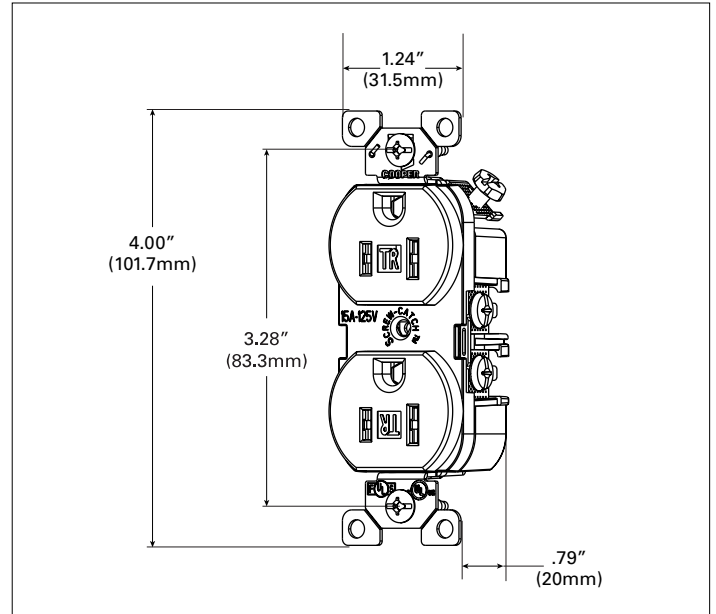

Figure 6. TRBR15 Line Art with Dimensions

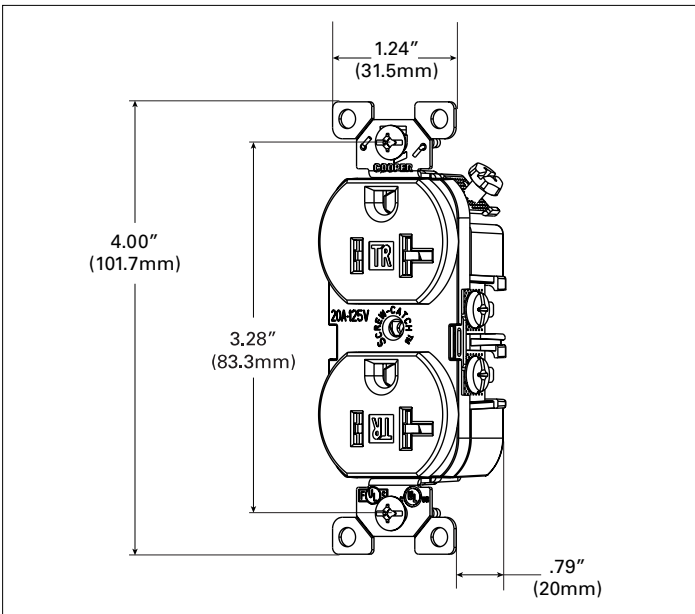

Figure 7. TRBR20 Line Art with Dimensions

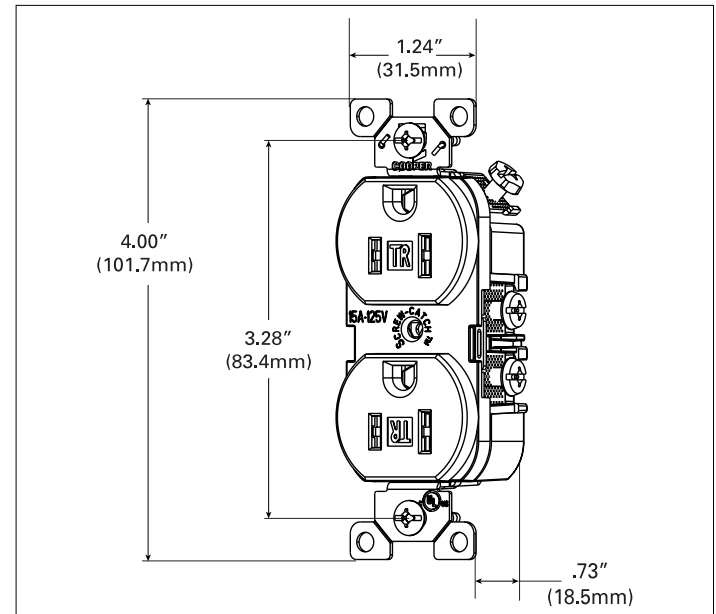

Figure 8. TRCR15 Line Art with Dimensions

Project Name:	Prepared By:
Project Number:	Date:
Catalog Number:	Type:

Product Dimensions

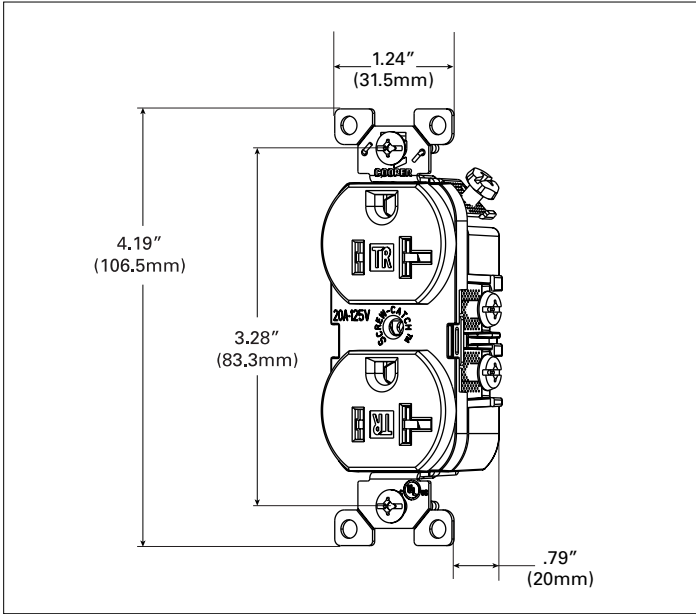

Figure 9. TRCR20 Line Art with Dimensions

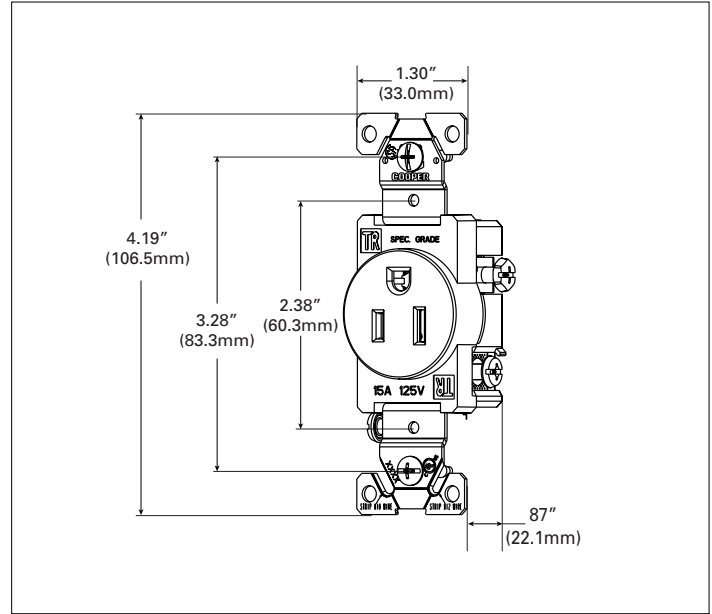

Figure 10. TR817 Line Art with Dimensions

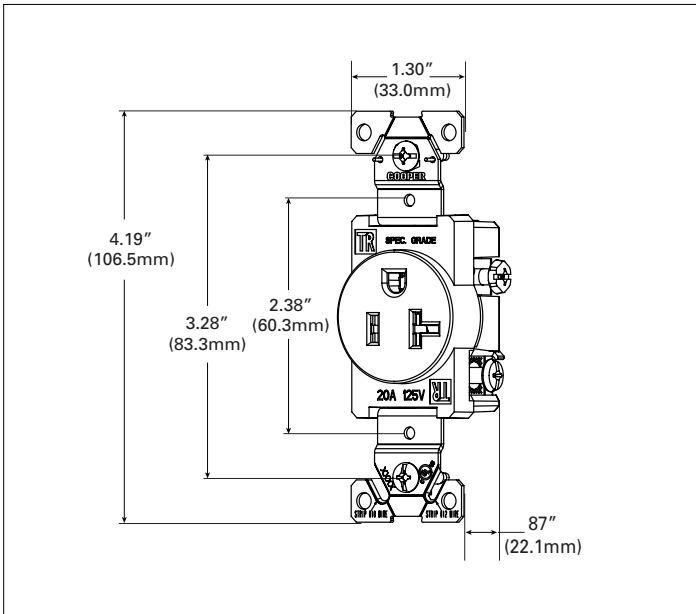











Figure 11. TR1877 Line Art with Dimensions

Project Name:	Prepared By:
Project Number:	Date:
Catalog Number:	Type:

Certifications & compliances

Catalog No.									
BR15	•	•	•	•	•	•	•	•	•
CR15	•		•			•		•	•
817		•		•	•	•		•	•
BR20	•	•	•	•	•	•	•	•	•
CR20	•		•			•		•	•
1877		•		•	•	•		•	•
826	•		•			•		•	•
816	•		•			•		•	•
815	•	•	•		•	•		•	•
1876	•		•			•		•	•
829		•	•		•	•		•	•
TRBR15	•		•			•	•	•	•
TRCR15	•					•		•	•
TR817	•		•			•		•	•
TRBR20	•		•			•	•	•	•
TRCR20	•					•		•	•
TR1877	•					•		•	•

KEY:  cULus  UL  Fed Spec  NAFTA  CSA
 NOM  Arrowlink  Build-To-Spec  ROHS

 Parts are manufactured and designed in accordance with article 4 of the European Union's RoHS2 directive 2011/65/EU

 Build-To-Spec Customizable Devices

Compliances, specifications and availability are subject to change without notice.

Electrical Sector
203 Cooper Circle
Peachtree City, GA 30269
United States
Eaton.com
Eaton.com/arrowhart

Electrical Sector
Canada Operations
5925 McLaughlin Road
Mississauga, Ontario, L5R 1B8
Canada
EatonCanada.ca
Eaton.com/arrowhart

Electrical Sector
Mexico Operations
Carr. Tlalnepantla -
Cuautitlan Km 17.8 s/n
Col. Villa Jardin esq.
Cerrada 8 de Mayo
Cuautitlan, Mexico CP 54800
Mexico
Eaton.mx
Eaton.com/arrowhart