

BROAN[®]

BROAN VENTILATION SOLUTIONS.
BETTER AIR. BETTER LIFE.



VENTILATION FANS

WHEN YOUR HOME BREATHES,



WHY INDOOR AIR QUALITY IS IMPORTANT TO YOU.

Consider this, according to the EPA (epa.gov), indoor air quality is five times worse than outdoor air quality. Most homeowners know that indoor air quality is important, but not all recognize what contributes to poor indoor air quality, the potential effects and harm, and how to address these problems. Broan is here to help. For more than 80 years, Broan has led the industry with residential ventilation solutions that improve indoor air quality and provide healthier home environments.

Moisture that is not properly ventilated can cause mildew and mold formation, which can potentially lead to structural problems and health problems. Exhaust ventilation solutions from Broan remove humidity at the source to help maintain the optimal humidity balance of 40 to 60 percent.

Off-gassing from construction materials, carpeting, adhesives and synthetic materials—as well as solvents from common household cleaners—can accumulate in tightly built homes. Look to Broan for continuous ventilation solutions that meet ASHRAE 62.2.

Particulates from dust, allergens, pet dander, and more can contribute to poor indoor air quality up to 100 times dirtier than outside air. With a properly ventilated home, you create a more enjoyable, comfortable and healthier environment.

Cooking effluents from food preparation can infiltrate the whole house in minutes. Grease, oils and aromas settle permanently into carpets, furniture, clothing and other surfaces. Kitchen ventilation solutions help eliminate cooking effluents for a cleaner, more comfortable and healthier environment.

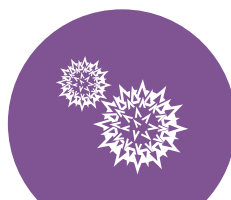

YOU BREATHE EASIER TOO.

BROAN CAN IMPROVE INDOOR AIR QUALITY IN EVERY ROOM OF THE HOME.

From clearing humidity in the bathroom to removing heat, steam and airborne effluents in the kitchen. From whole-house HEPA air filtration and balanced fresh air exchange solutions to attic ventilation. From the family room to the master bedroom and in every room in between, no company knows residential and light commercial ventilation like Broan-NuTone. After more than 80 years, countless innovations and a commitment to indoor air quality, trust Broan to clear up every concern.



EXHAUST VENTILATION

removes excess moisture and odor from any room in the home, and can also provide continuous, whole-house ventilation.

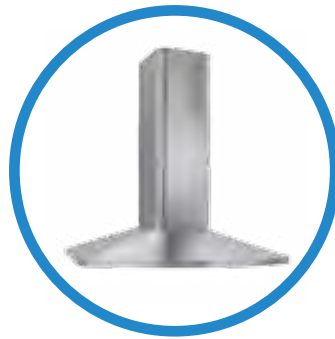

KITCHEN VENTILATION

expels cooking effluents from food preparation to eliminate airborne pollutants from spreading through the entire house.



FRESH AIR SYSTEMS

efficiently exchanges inside air with fresh outside air, and removes airborne particulate with HEPA filtration.

DID YOU KNOW?*

Knowing the facts goes a long way toward a healthier indoor environment:

Just **46%** recognize not having a bathroom fan has a negative impact on indoor air quality—only 42% recognize that a lack of a range hood also has a negative impact.

60% have a fan in each bathroom but only one in five let it run for 10 minutes after showering.

Some homeowners don't recognize the causes of poor indoor air quality:

Only **42%** are concerned about moisture that causes mold or mildew.

Only **33%** know food aromas after preparation is an indicator of poor IAQ.

81% don't know that a foggy mirror means poor IAQ.

Most homeowners are tuned in to residential Indoor Air Quality concerns:

60% know that indoor air quality has a greater impact on their health than outdoor air quality.

90% realize poor indoor air quality contributes to certain health issues and that healthy air helps prevent illness.

INDOOR AIR QUALITY IS IMPORTANT IN EVERY ROOM OF THE HOME, NOT JUST THE BATHROOM.

2-9 INTRODUCTION

10-15 ULTRA™ SERIES

16-19 QT SERIES

20-21 SENSING FANS

22-23 SMARTSENSE SERIES

24-27 INVENT™ SERIES

28-29 LOPROFILE™

30-31 CLASSIC VENTILATION

32-35 ARCHITECTURAL FAN/LIGHTS

36-41 SPECIALTY

42-45 HEATER/FAN/LIGHTS

46-49 ATTIC VENTILATORS

50-53 WALL CONTROLS

54-55 DUCTING ACCESSORIES

56-57 FAQs

58-59 INSTALLATION NOTES

60-63 SPECIFICATIONS

64-73 LIGHT COMMERCIAL

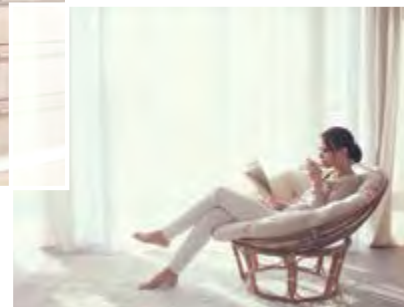

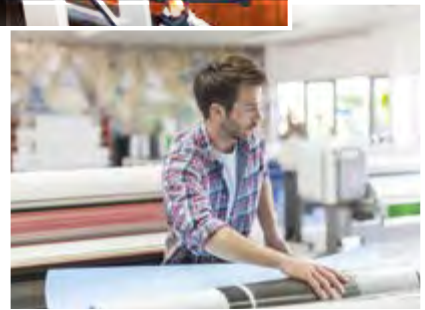
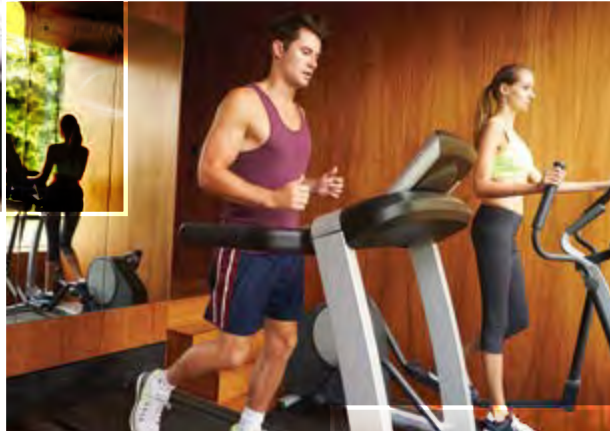



The original
1932 Motordor

THE UNDISPUTED LEADER IN
INDOOR AIR QUALITY SINCE 1932.

INDUSTRY LEADERSHIP ISN'T A CLAIM. IT'S EARNED THROUGH INNOVATION.

In southeastern Wisconsin some eight decades ago, an engineer named Henry Broan had a revelation: Wouldn't a built-in mechanical ventilation solution help to provide better indoor air quality in the kitchen? And so, Motordor was conceived—the first kitchen ventilator—and a company was born. Once Mr. Broan had invented a new category, other applications were the natural next step. The bath ventilation fan soon followed, as the passion for improving indoor air quality continued.

Leadership is built on standards, all to help ensure the professionalism of an industry. So in 1957, Broan was among five companies that founded the Home Ventilating Institute (HVI). To this day the HVI mark ensures what's stated on the package is tested and certified for your confidence. Because Mr. Broan believed that if you paid good money for something, you deserved to get what was promised.

Throughout the years, countless innovations followed, including some of the first certified ventilation fans and range hoods with efficient motors and lighting that reduced energy consumption by as much as 70%. And as homes were built tighter, Broan was on the leading edge of whole-house ventilation solutions with HEPA filtration and energy recovery capabilities. Today, Broan continues to lead the industry with efficient and quiet ventilation solutions that are easier than ever to install.

You see, leadership isn't about entering a market, offering a handful of products, and staking a claim. Leadership is earned and proven through a passion and commitment to finding novel solutions to real problems time and time again. This is exactly why Broan has taken the job of improving air quality in our homes very seriously for more than 80 years.

WE INVENTED THE CATEGORY IN 1932. WE HAVE NO INTENTION OF STOPPING.

1933: Kitchen ventilator:
Motordor is sold



1955: Founder of the
Home Ventilating Institute



1956: The bath fan

1959: The fan/light

1965:
Introduced the first
heater fan light



1993: The
first humidity
sensing
fan hits the
shelves



DID YOU KNOW?

Professional **contractors** recognize the Broan ventilation brand above all others.

Broan-NuTone is the **only** company in North America with an HVI Certified on-site sound testing facility.

Twenty-four* of the top 25 builders specify the Broan brand. More builders use Broan ventilation products than any other brand.

*2015 Hanley Wood Builder Brand Use Study

Broan is a **three-time** winner of the International Service Excellence award. The Customer Service Institute of America recognizes organizations for customer service professionalism.

ENERGY STAR A partner since 2005, Broan has one of the largest ENERGY STAR offerings in the industry, including many ENERGY STAR Most Efficient products. energystar.gov

Broan was a **founding member** of the Home Ventilating Institute®, an independent organization that certifies airflow and sound performance of ventilation products. hvi.org

About 80% of Broan products are manufactured in our state-of-the-art manufacturing facilities in Hartford, Wisconsin.



2004:
The quiet fan
<0.3 sones

2004: The first recessed fan light



2005: The ENERGY STAR® certified fan



2012: The first fan enabling easy room-side installation



2014:
The first fan with Soft Surround™ LED lighting technology



2015:
The wireless speaker fan



BROAN KNOWS TODAY'S STRINGENT VENTILATION CODES AND STANDARDS.

Because today's homes are built tighter than ever before, what gets in stays in, unless mechanically ventilated out. Premium ventilation solutions from Broan dramatically reduce moisture as well as airborne pollutants from off-gassing building materials, adhesives and household cleaners. They also help eliminate allergens, dust, pet dander and cooking effluents—everything that contributes to poor indoor air quality.

Both spot and whole-house ventilation are important.

Spot ventilation products remove pollutants at the source when they occur—think bathroom fans and kitchen range hoods—quickly eliminating humidity, odor and cooking effluents.

Whole-house ventilation, also known as continuous or dwelling unit ventilation (DUV), continually removes what's not captured by spot ventilation for a more healthy and comfortable home.

Understanding today's ventilation requirements.

The American Society of Heating, Refrigeration and Air Conditioning Engineers (ASHRAE) set the industry standard for ventilation and acceptable indoor air quality for low-rise residential buildings with ASHRAE 62.2. It sets the minimum standard for spot or local ventilation of individual bathrooms of 50 Cubic Feet per Minute (CFM) delivered airflow at 3.0 sones or less. It also specifies the requirements for whole-house ventilation of an entire dwelling at the maximum sound rating of 1.0 sone for ventilation fans.

Code adoption growing rapidly.

California was a leader in this area with their Title 24 Code. Other state and city governments are quickly adopting similar codes such as the International Energy Conservation Code (IECC) to improve energy efficiency as well as indoor air quality.

Above-code green building programs such as ENERGY STAR® for Homes, ENERGY STAR® Indoor Air Plus, the Leadership in Energy and Environment Design (LEED) Certification Building Program and the National Association of Home Builders (NAHB) Green Building Standard are certified green building programs that promote human health and conserve natural resources. Let Broan help you meet the goals of these programs.

You've come to the right place for product solutions.

With Broan's extensive product line-up, including exhaust and balanced ventilation options such as Heat Recovery Ventilators (HRVs) and Energy Recovery Ventilators (ERVs), you're sure to find the ideal solution to meet your needs.

SELECTING THE PROPER WHOLE HOUSE RESIDENTIAL VENTILATION SOLUTION.

Sizing your solution is a factor of square footage and the number of bedrooms in the dwelling to meet requirements. These charts are based on ASHRAE 62.2. Note that the 2010 and 2013 versions are different. Most states still operate under 62.2-2010 rates. Before specifying, check local building codes to ensure it meets requirements.

ASHRAE 62.2—2010 Required Continuous Ventilation Rate (CFM)

Floor Area Sq. Ft.	0-1 BR	2-3 BR	4-5 BR	6-7 BR	>7 BR
<1500	30	45	60	75	90
1501-3000	45	60	75	90	105
3001-4500	60	75	90	105	120
4501-6000	75	90	105	120	135
6001-7500	90	105	120	135	150
>7500	105	120	135	150	165

ASHRAE 62.2—2013 Required Continuous Ventilation Rate (CFM)

Floor Area Sq. Ft.	0-1 BR	2-3 BR	4-5 BR	6-7 BR	>7 BR
<500	30	40	45	55	60
500-1000	45	55	60	70	75
1001-1500	60	70	70	85	90
1501-2000	75	85	90	100	105
2001-2500	90	100	105	115	120
2501-3000	105	115	120	130	135
3001-3500	120	130	135	145	150
>3501	135	145	150	160	165

AN ALTERNATIVE FORMULA APPROACH TO THE TABLES GIVEN ABOVE.

An alternative formula approach to the tables given above also exists and typically results in a lower, more precise CFM requirement. Under the more common 62.2-2010 version, continuous CFM requirements can be calculated using a formula as follows.
 $CFM = .01 \times \text{floor area (in square feet)} + 7.5 \times (\text{number of bedrooms} + 1)$.

Example: A 3,500 square foot home with 4 bedrooms would require 73 CFM
 $.01 \times 3,500 = 35$
 $7.5 \times (4+1) = 38$
 Add together for a total of 73 CFM
 (as compared to the 90 from the above table).

The 62.2-2013 version increases the multiplier for floor area from .01 to .03. Note however that infiltration credits can be taken if blower door testing is conducted.

Whole-house Ventilation Options

Fan Series	Model	CFM	0.25" CFM	Sones	Motor Type	Sensing	Duct Size	Page No.
ULTRA Green™ Multi Speed	ZB80	80	80	<0.3*	DC	—	6" or 4"	12-13
	ZB80M	80	80	<0.3*	DC	Motion	6" or 4"	12-13
	ZB110	110	110	<0.3	DC	—	6"	12-13
	ZB110H	110	110	<0.3	DC	Humidity	6"	12-13
	ZB110M	110	110	<0.3	DC	Motion	6"	12-13
ULTRA Green™ Single Speed	XB50	50	50	<0.3	DC	—	6" or 4"	12-13
	XB80	80	80	<0.3*	DC	—	6" or 4"	12-13
	XB110	110	110	<0.3	DC	—	6"	12-13
	XB110H	110	110	<0.3	DC	Humidity	6"	12-13
ULTRA Pro	RB80	80	60	<0.3	PSC	—	4"	15
	RB110	110	91	0.6	PSC	—	4"	15
QTXE SmartSense**	QTXE080	80	56	0.3	PSC	—	6"	18
	QTXE110	110	86	0.7	PSC	—	6"	18
	SSQTXE080	80	56	0.7	PSC	—	6"	22-23
	SSQTXE110	110	86	0.7	PSC	—	6"	22-23
LoProfile	LP80	80	55	1.0	PSC	—	4"	29
InVent	AE80	80	60	0.8	PSC	—	4"	26
	AE50	50	92	0.5	PSC	—	4"	26

ENERGY STAR® fans use 70% less energy, on average, than standard models and may qualify for local utility rebates

*With 6" duct (0.3 sones with 4" duct)

**SmartSense Models: SSQTXE080 and SSQTXE110 (see pages 22 and 23)



Fan/Light Series	Model	CFM	0.25" CFM	Sones	Motor Type	Sensing	Duct Size	Page No.
ULTRA Green™ Multi Speed	ZB80L	80	80	<0.3*	DC	—	6" or 4"	12-13
	ZB80ML	80	80	<0.3*	DC	Motion	6" or 4"	12-13
	ZB110L	110	110	<0.3	DC	—	6"	12-13
	ZB110HL	110	110	<0.3	DC	Humidity	6"	12-13
	ZB110ML	110	110	<0.3	DC	Motion	6"	12-13
ULTRA Green™ Single Speed	XB50L	50	50	<0.3	DC	—	6" or 4"	12-13
	XB80L	80	80	<0.3*	DC	—	6" or 4"	12-13
	XB110L	110	110	<0.3	DC	—	6"	12-13
	XB110HL	110	110	<0.3	DC	Humidity	6"	12-13
ULTRA Pro	RB80L	80	60	<0.3	PSC	—	4"	15
	RB110L	110	91	0.8	PSC	—	4"	15
QTXE	QTXE080FLT	80	56	0.3	PSC	—	6"	18
	QTXE110FLT	110	86	0.7	PSC	—	6"	18
InVent	AE80L	80	60	0.8	PSC	—	4"	26
	A80L	80	92	1.0	PSC	—	4"	26

ENERGY STAR® fans use 70% less energy, on average, than standard models and may qualify for local utility rebates

Note that in addition to exhaust solutions to meet DUV requirements, we also offer a full line of balanced ventilation models (HRVs and ERVs).



BROAN CODE KEY

The exclusive online tool that ensures compliant ventilation selection.

Specifying a dwelling unit ventilation (DUV) system for residences can be complicated. Code Key from Broan is the only online resource that helps you select the right product in minutes. Choose the dwelling's state, home size facts and user preferences to receive a list of recommended ventilation products. Change parameters to instantly see a range of options. Code Key requires no software and works on mobile devices. It's another way Broan—the pioneer in ventilation for more than 80 years—leads the ventilation industry with forward-thinking products and customer service.

[Broan.com/tools-landing-page/codekey](https://broan.com/tools-landing-page/codekey)



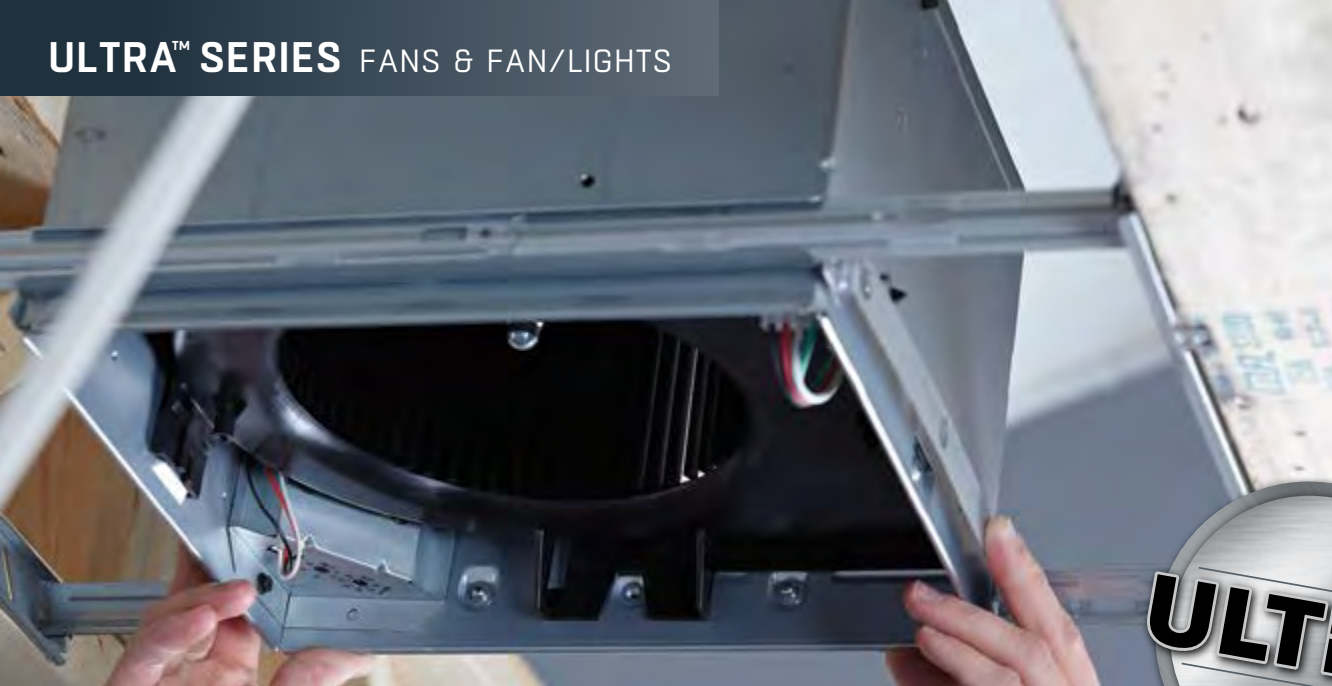

A REVOLUTION IN
VENTILATION FAN TECHNOLOGY
***ENGINEERED TO SIMPLIFY
INSTALLATION.***

WE DIDN'T JUST CHANGE ONE THING TO MAKE INSTALLATIONS FASTER, WE CHANGED EVERYTHING. From a unique telescoping mounting frame that installs room-side on retro-fits to an easy-to-insert housing and blower that snap into place, we designed the ULTRA™ Series to be the fastest, easiest, most universal installation in new construction or retro-fit. No matter what's behind the drywall on your next retro-fit job, you'll never have another difficult installation. And just as important, the ULTRA™ Series meets whole-house mechanical ventilation codes and green building program requirements. It's a revolutionary way to install and a revolutionary way to ventilate.





SOUND TECHNOLOGY

Reduce sound levels and improve sound quality in real-world installations. The innovative, patent-pending QStream™ technology utilizes airflow-smoothing baffles that reduce turbulence which means the blower can turn more slowly and quietly—without airflow loss.*

*Not available on 110 CFM ULTRA Green™ Models

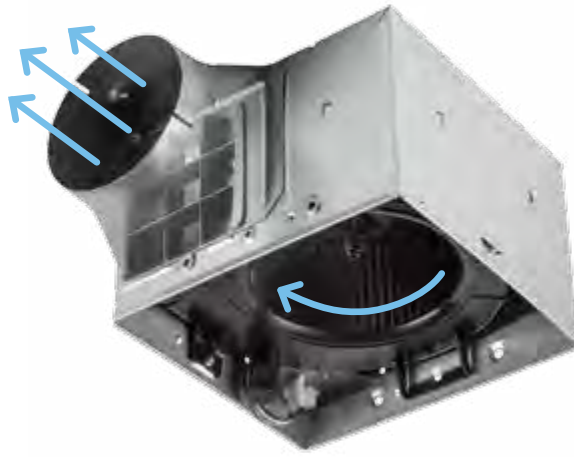

Inside/outside wiring capability provides flexible new or retrofit installation

Pre-installed screws in the mounting frame enable quick installation

Vertical positioning tabs ensure the housing is in the right place

The expandable mounting frame adjusts from 14"–24" and fits any type of joist, I-joist or truss construction

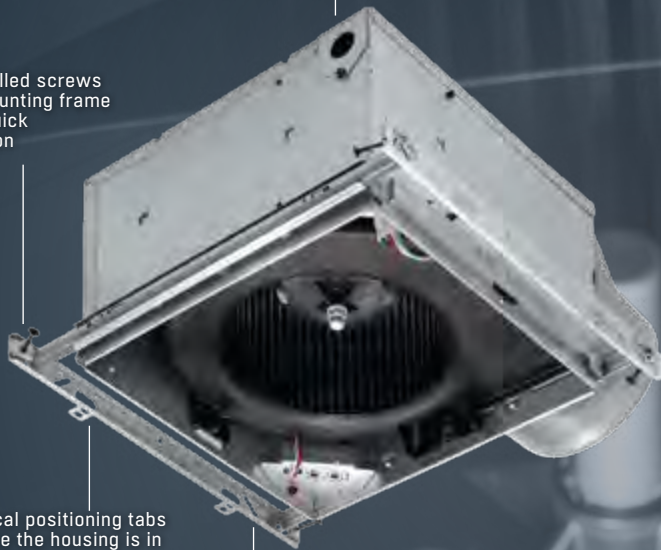

ULTRAQUICK™ INSTALLATION TECHNOLOGY

ULTRA™ Series Ventilation Fans are engineered to be the fastest, easiest, most universal installation in remodel, retrofit and new construction—in any type of joist or truss system. Exclusive features simplify room-side installation to save valuable time and money.

For energy saving options see ULTRA GREEN on page 12

RDFU PREMIUM RADIATION DAMPER FOR ULTRA GREEN™ AND ULTRA PRO™ FANS.

When the air temperature passing through the damper exceeds 165°F the fusible link melts, triggering the thermal fabric to automatically close across the damper. Airflow is interrupted by a flame and heat barrier, preventing the rapid spread of fire to other areas.

- Motor serviceable without disturbing drywall
- Galvanized steel frame
- High temperature, non-asbestos, reinforced fiber thermal fabric
- Stainless steel closure springs
- 165°F fusible link
- Use the same grille provided with the ULTRA™ Series fan
- Use Model RDFU with RDJUMPU for ULTRA Green™ and ULTRA Pro™ models with lighting and/or sensing
- UL Standard 555C Classified



THE PERFECT SOLUTION TO MEET TODAY'S CONTINUOUS VENTILATION REQUIREMENTS.

Built for easy installation in either new construction or retrofit applications, the ULTRA Green™ Series makes it simple to ventilate any room in the house. In today's tightly built homes, unhealthy pollutants and excess humidity stay trapped inside unless they are mechanically vented away. Exclusive ULTRA Smart™ DC Motor and Control Technology enables fans to maintain their powerful operation—even at high static pressures—and provide required air movement levels for whole-house ventilation, all while meeting spot ventilation needs on demand. Continuous CFM levels can be precisely adjusted to meet the specific needs of each home.

- HVI certified at <0.3 Sones, ULTRA Silent™ Sound Technology provides the quietest sound rating obtainable
- 50, 80 or 110 CFM
- Intermittent and continuous ventilation
- ULTRA Smart™ DC Motor and Control Technology monitors performance and adjusts motor speed to ensure rated air movement
- ENERGY STAR® certified
- ULTRA Quick™ Installation Technology saves time with the fastest, easiest, most universal installation
- XB and ZB models feature 6" ducting—50 and 80 CFM models include an optional 6" to 4" duct reducer
- Bright, energy efficient 36 watt fluorescent lighting
- UL Listed for use over bathtub or shower when connected to a GFCI protected branch circuit
- Type IC
- Fits 2" x 8" ceiling construction
- Optional RDFU Premium Radiation Dampener Kit available for all XB and ZB models.
- Models XB50, XB80, ZB50 and ZB80 feature QStream Technology



**XB50 | XB80 | XB110 | ZB80 | ZB110
FANS**

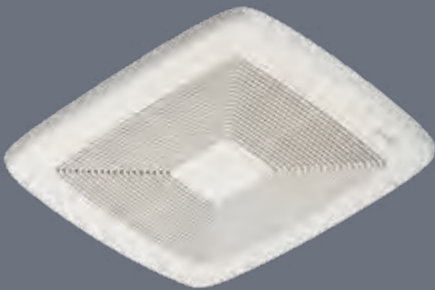

**XB110H | ZB110H
HUMIDITY SENSING FANS**

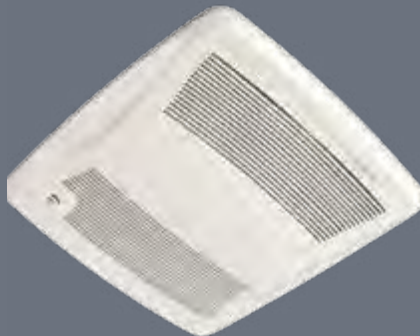

**ZB80M | ZB110M
MOTION SENSING FANS**

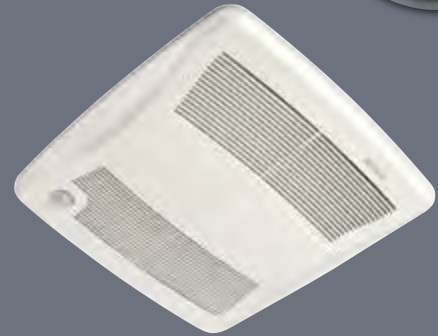

**XB50L | XB80L | XB110L | ZB80L | ZB110L
FAN/LIGHTS**

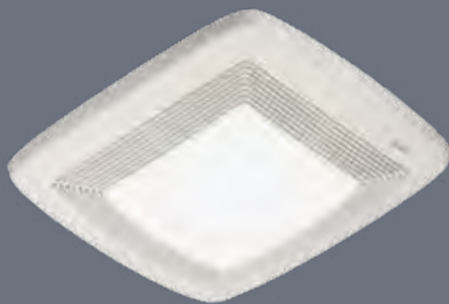

**XB110HL | ZB110HL
HUMIDITY SENSING FAN/LIGHTS**



**ZB80ML | ZB110ML
MOTION SENSING FAN/LIGHTS**

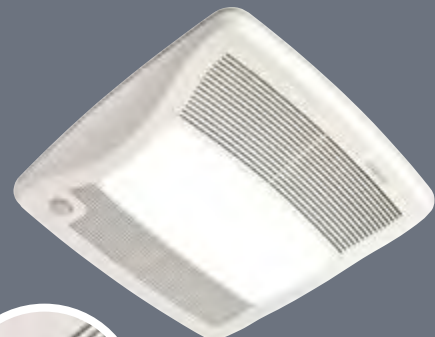

Humidity Sensing



Motion Sensing

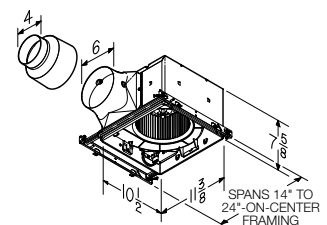

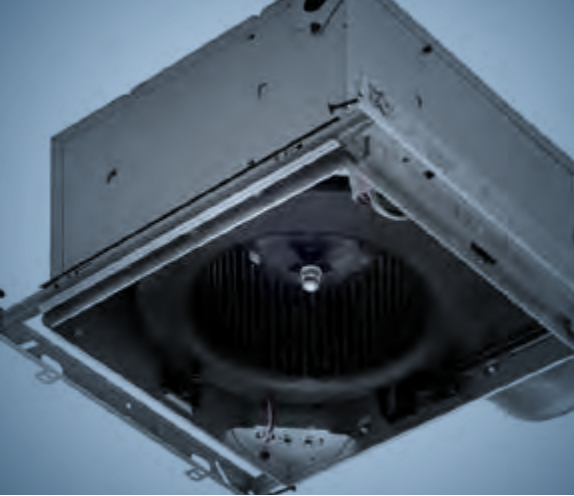

ULTRASMART™ DC MOTOR AND CONTROL TECHNOLOGY

To virtually ensure full-rated performance—regardless of the ducting situation—ULTRA Green™ Series fans automatically monitor and adjust CFM output. For continuous ventilation needs, multi-speed models may be precisely set as low as 30 CFM to avoid costly over-ventilating. A second dial controls runtime at maximum CFM. Our DC motor is the most efficient in our line—80 CFM models use only 5.8 watts.

POWERFUL MOTION & SENSING TECHNOLOGIES

ULTRA Fans with Sensaire humidity sensing technology detect the rapid rise in humidity at the ceiling level. This means that they will react to shower humidity much faster than competitive fans or wall controls. Multi-speed models turn the fan speed up from the lower continuous CFM level. Single-speed models turn the fan on automatically.

ULTRA Fans with motion sensing and multi-speed capability automatically turn the fan up to maximum speed from the lower continuous setting when motion is detected which is ideal for family members who forget to turn the fan on.

ULTRASILENT™ SOUND TECHNOLOGY

ULTRA Green™ Series Ventilation Fans are HVI certified at a remarkable <0.3 Sones; the quietest sound rating obtainable. A dynamically balanced DC motor mounted behind the wheel, a state-of-the-art blower that reduces turbulence, and a free-flowing 6" duct outlet opening that won't inhibit airflow make it possible. There's no quieter fan available.

ULTRA GREEN™ SERIES FANS SAVE UP TO 10 HERS POINTS AND UP TO \$200 PER YEAR IN OPERATING COST.*

Model	CFM	Sones	Light/Night Light	Humidity Sensing	Motion Sensing	Ducting	Grill Dimensions (in)		ENERGY STAR®
							L	W	
Single-speed Fans									
XB50	50	<0.3	—	—	—	6" to 4" reducer	13	13¾	Yes
	50	<0.3							
XB80	80	<0.3	—	—	—	6" to 4" reducer	13	13¾	Yes
	80	0.3							
XB110	110	<0.3	—	—	—	6"	13	13¾	Yes
XB110H	110	<0.3	—	Yes	—	6"	13¾	14	Yes
Single-speed Fan/Lights									
XB50L	50	<0.3	2- 18W GU24 / 4W	—	—	6" to 4" reducer	13	13¾	Yes
	50	<0.3							
XB80L	80	<0.3	2- 18W GU24 / 4W	—	—	6" to 4" reducer	13	13¾	Yes
	80	0.3							
XB110L	110	<0.3	2- 18W GU24 / 4W	—	—	6"	13	13¾	Yes
XB110HL	110	<0.3	2- 18W GU24 / 4W	Yes	—	6"	13¾	14	Yes
Multi-speed Fans									
ZB80	80	<0.3	—	—	—	6" to 4" reducer	13	13¾	Yes
	80	0.3							
ZB80M	80	<0.3	—	—	Yes	6" to 4" reducer	13¾	14	Yes
	80	0.3							
ZB110	110	<0.3	—	—	—	6"	13	13¾	Yes
ZB110H	110	<0.3	—	Yes	—	6"	13¾	14	Yes
ZB110M	110	<0.3	—	—	Yes	6"	13¾	14	Yes
Multi-speed Fan/Lights									
ZB80L	80	<0.3	2- 18W GU24 / 4W	—	—	6" to 4" reducer	13	13¾	Yes
	80	0.3							
ZB80ML	80	<0.3	2- 18W GU24 / 4W	—	Yes	6" to 4" reducer	13¾	14	Yes
	80	0.3							
ZB110L	110	<0.3	2- 18W GU24 / 4W	—	—	6"	13	13¾	Yes
ZB110HL	110	<0.3	2- 18W GU24 / 4W	Yes	—	6"	13¾	14	Yes
ZB110ML	110	<0.3	2- 18W GU24 / 4W	—	Yes	6"	13¾	14	Yes

ENERGY STAR® fans use 70% less energy, on average, than standard models and may qualify for local utility rebates



* Compared to a central fan-integrated system when used for continuous ventilation; based on software calculations and analysis conducted by Broan-NuTone.

QFLOW™ TECHNOLOGY MEANS SMOOTHER AIRFLOW AND OPTIMAL BACKDRAFT SEALING.

QFlow™ Damper Technology. Patent-pending QFlow technology helps achieve desired building airtightness scores when the fan is off. It also removes the duct damper flap from the airstream path, reducing static pressure and noise when the fan is on.

FAN OFF

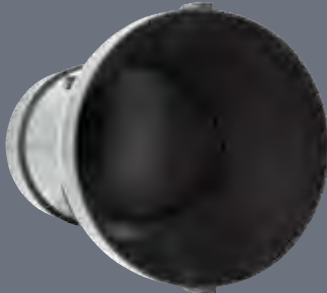

Without QFlow, outdoor air can intrude past the damper edges.

With QFlow, outdoor air intrusion is blocked with its edge-to-edge design.

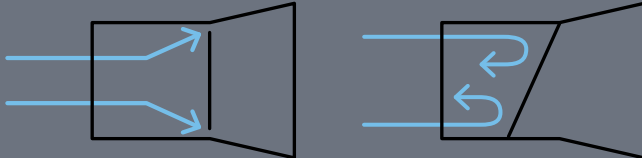

FAN ON

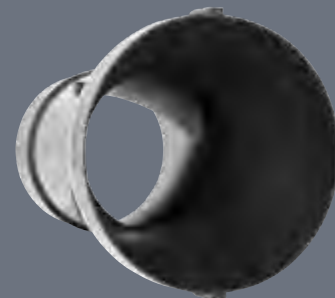

Pre-installed screws in the mounting frame enable quick installation

Without QFlow, the flap impedes airflow which increases static pressure, turbulence and noise.

With QFlow, the flap lifts out of the way, minimizing turbulence for more quiet operation.

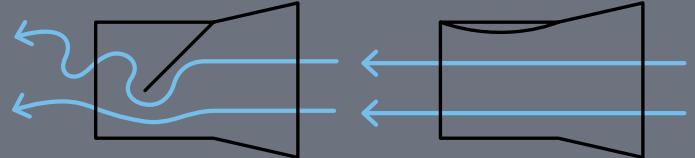

REDUCE SOUND LEVELS AND IMPROVE SOUND QUALITY IN REAL-WORLD INSTALLATIONS.

QSTREAM™ SOUND TECHNOLOGY

The innovative, patent-pending QStream™ technology utilizes airflow-smoothing baffles that reduce turbulence which means the blower can turn more slowly and quietly—without airflow loss.*

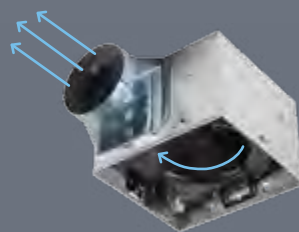

With QStream™ Technology

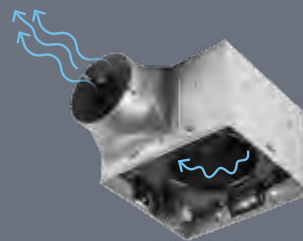

Without QStream™ Technology

ULTRAQUICK™ INSTALLATION TECHNOLOGY

ULTRA™ Series Ventilation Fans are engineered to be the fastest, easiest, most universal installation in remodel, retrofit or new construction—in any type of joist or truss system. Exclusive features simplify room-side installation to save valuable time and money.

Inside/outside wiring capability provides flexible new or retrofit installation

Pre-installed screws in the mounting frame enable quick installation

Vertical positioning tabs ensure the housing is in the right place

The expandable mounting frame adjusts from 14"-24" and fits any type of joist, I-joist or truss construction

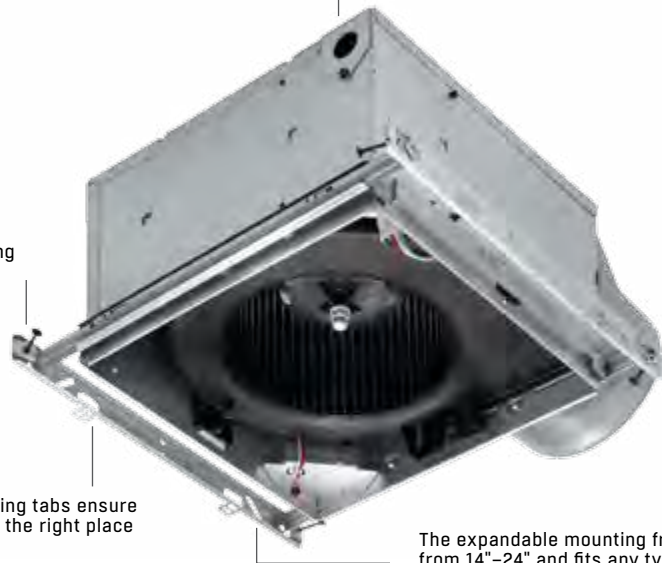

ULTRA PRO FEATURES

- Provide your customers extremely quiet operation with innovative sound reduction technologies.
- QStream™ technology features airflow-smoothing baffles to reduce turbulence.
- Optional RDFU Premium Radiation Damper Kit available for RB models.

The preferred install choice for professionals to deliver quiet performance



RB80 | RB110

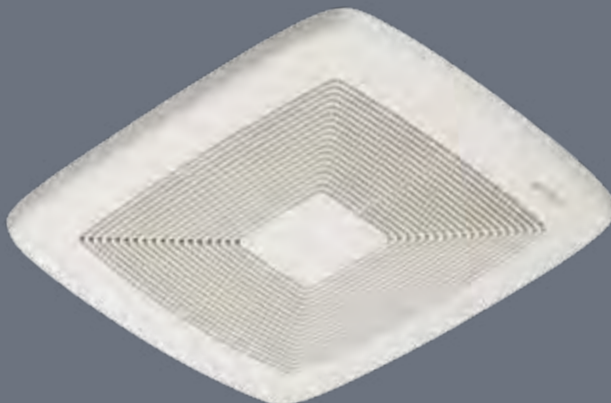

RB80L | RB110L

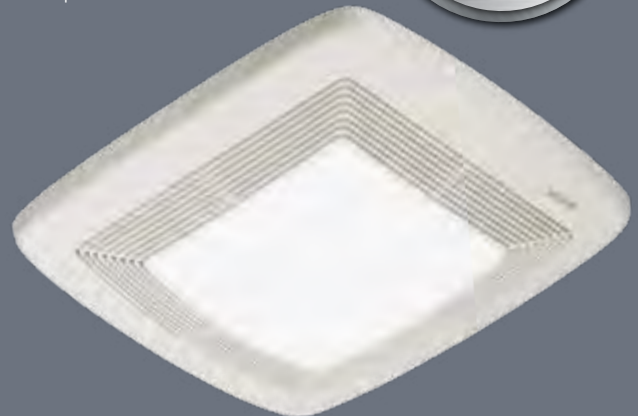

Ultra Pro Series

Model	Duct Size	CFM	Sones	Light/Night Light	Housing Dims (in)			Grille Dims (in)		Grille Finish	UL Listed for Tub/Shower Use	ENERGY STAR®
					W	L	H	L	W			
Single-Speed Fans												
RB80	4"	80	<0.3	—	11 ³ / ₈	10 ¹ / ₂	7 ⁵ / ₈	13	14	White Polymeric	Yes	Yes
RB110	4"	110	0.6	—	11 ³ / ₈	10 ¹ / ₂	7 ⁵ / ₈	13	14	White Polymeric	Yes	Yes
Single-Speed Fan/Lights												
RB80L	4"	80	<0.3	2- 18W GU24 / 4W	11 ³ / ₈	10 ¹ / ₂	7 ⁵ / ₈	13	13 ³ / ₄	White Polymeric	Yes	Yes
RB110L	4"	110	0.8	2- 18W GU24 / 4W	11 ³ / ₈	10 ¹ / ₂	7 ⁵ / ₈	13	13 ³ / ₄	White Polymeric	Yes	Yes

ENERGY STAR® fans use 70% less energy, on average, than standard models and may qualify for local utility rebates





BROAN QT SERIES

SO QUIET, YOU MIGHT EASILY FORGET





IT'S ON.

PEACEFUL MOMENTS CAN BE ENJOYED EVEN MORE WITH VENTILATION FROM A QUIET, QT SERIES FAN.

The very quiet Broan QT Series is the ideal solution for any room that benefits from ventilation. Most QT models operate at less than one sone—the sound of a quiet running refrigerator. But quiet operation doesn't mean less power. Installed properly, the QT Series maintains full-rated airflow in real-world installations. So choose a QT Series bath fan, fan/light or heater/fan/light for your application. Broan has the perfect solution for every room.

QTXE FAN FEATURES

- Very quiet operation 0.3 to 1.4 sones
- 80 CFM to 150 CFM
- QTXE features 6" ducting for superior performance
- QTXE models are ENERGY STAR® certified
- HVI Certified
- QTXE includes hanger bar system for fast, flexible installation for all types of construction
- Motor engineered for continuous operation
- UL Listed for use over bathtub or shower when connected to a GFCI protected branch circuit
- Fits 2" x 8" ceiling construction
- Radiation damper available separately, see page 19

QTXE

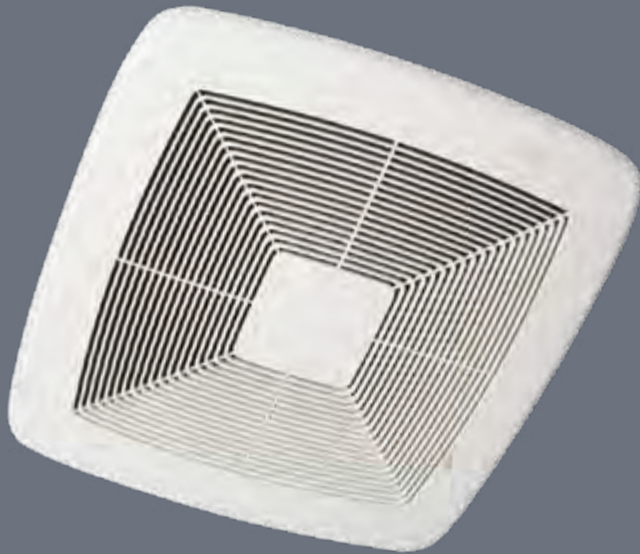

QTXE150

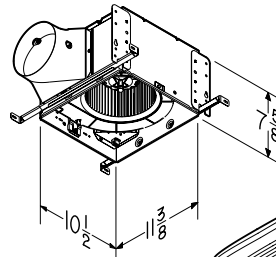

QTXE080, QTXE110

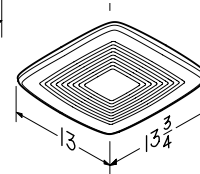
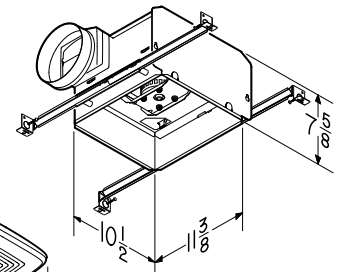

Broan QT Series™ Bath Fans. A bath fan needn't call attention to itself, especially when you don't want it to overpower the design of your bath or powder room. More important, it shouldn't call attention to itself when it's working. So we developed the QT Series™ to provide very relaxing ventilation. With an energy efficient option, it simply does its job quietly, in every sense of the word.

Model	CFM	Sones	Lighting	Bath Sq. Ft.	Ducting	ENERGY STAR®
QTXE080	80	0.3		75	6"▲	Yes
QTXE110	110	0.7		100	6"▲	Yes
QTXE150	150	1.4		140	6"▲	Yes
QTXE080FLT	80	0.3	36W♦ / 4W*	75	6"▲	Yes
QTXE110FLT	110	0.7	36W♦ / 4W*	100	6"▲	Yes
QTXE150FLT	150	1.4	36W♦ / 4W*	135	6"▲	Yes

ENERGY STAR® fans use 70% less energy, on average, than standard models and may qualify for local utility rebates

▲ See page 54 for 6" ducting (DT6W) product specifications

♦ 2, 18 watt GU24 based fluorescent bulbs included

* Night-light bulbs not included



QTXE FAN/LIGHT FEATURES

- Very quiet operation 0.3 to 1.4 sones
- 80 CFM to 150 CFM
- QTXE models feature 6" ducting for superior performance
- QTXE models are ENERGY STAR® certified
- Bright, energy efficient 36 watt fluorescent lighting (2, 18 watt GU24 based bulbs) included with non-sensing QTXE and QTRE models
- QTXE includes hanger bar system for fast and flexible installation for all types of construction
- 4 watt night light on all models (bulb not included)
- Motor engineered for continuous operation
- UL Listed for use over bathtub or shower when connected to a GFCI protected branch circuit
- HVI Certified

- Type IC
- Fits 2" x 8" ceiling construction
- Radiation damper available separately, see below

QTXE

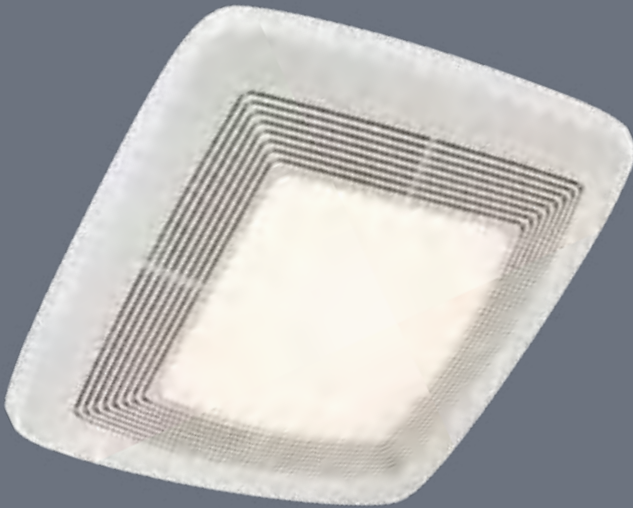

QTXE150FLT

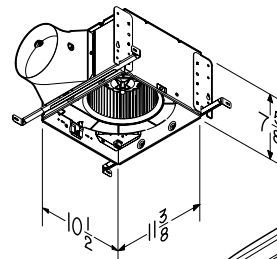

QTXE080FLT, QTXE110FLT

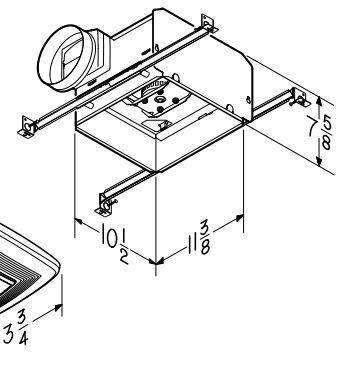

Broan QT Series™ Fan/Lights. The QT Series™ is the ultimate bath fan solution for today's homes. Select a QT Series™ fan/light to bring simple elegance to any bath or powder room. By sight or by sound, you'll barely notice a QT Series™ fan. Except, of course, when you need just the right amount of ventilation and light at the touch of a switch.

PREMIUM RADIATION DAMPERS FEATURES

- Motor serviceable without disturbing drywall
- Galvanized steel frame
- High temperature, non-asbestos, reinforced fiber thermal fabric
- UL Standard 555C Classified
- Stainless steel closure springs
- 165°F fusible link
- Use the same grille provided with the QT Series™ fan

Premium Radiation Dampers. When the air temperature passing through the damper exceeds 165°F the fusible link melts, triggering the thermal fabric to automatically close across the damper. Airflow is interrupted by a flame and heat barrier, preventing the rapid spread of fire to other areas.

RDFQF | RDFQL



Radiation Dampers	Description
RDFQF	For QTXE080 & QTXE110
RDFQL	For QTXE080FLT & QTXE110FLT
RDFQL plus RDJUMPQ	For QTXE110S

Humidity Sensing Fans with Sensaire® Technology.

Broan Sensaire® technology is a hands-free solution to fighting excess humidity and possible mold problems. It detects rapid increases in moisture levels at the ceiling, where steam and humidity naturally rise, and automatically turns the fan on.

With fans this quiet, we included automatic shutoff to save worry, and money. Broan Sensaire® technology is a perfect solution for high traffic bathrooms, the kids' bathroom, or for anyone who leaves the house before humidity is properly vented.

QTXE110S

INVENT AE80S | AE110S

INVENT AE80SL | AE110SL

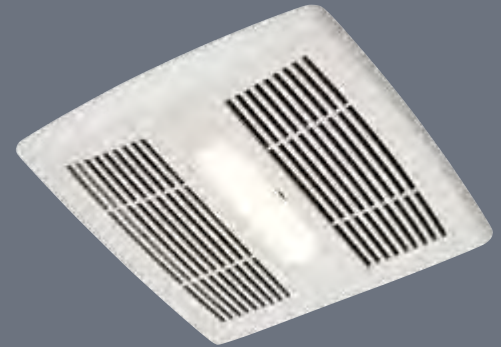
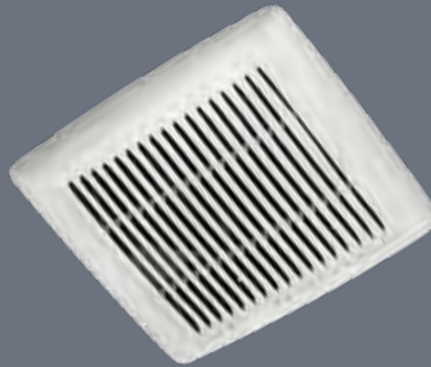
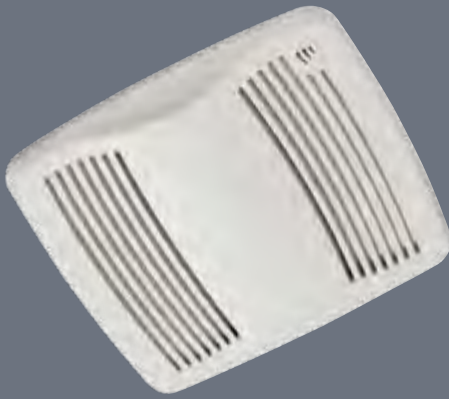

QTXE11S

AE80S, AE110S

AE80SL, AE110SL

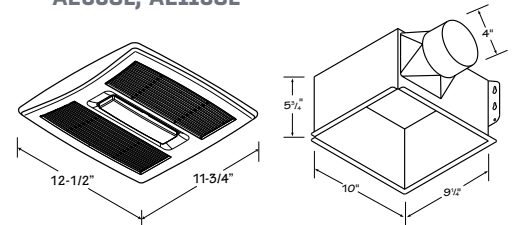
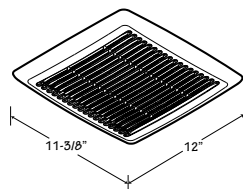
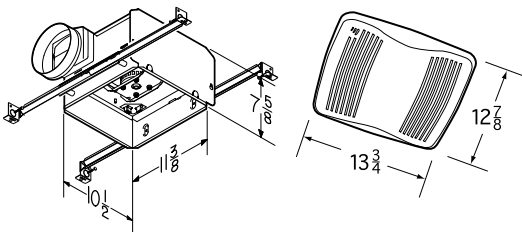

SENSAIRE® HUMIDITY SENSING FEATURES

- Detects a rapid rise in humidity
- User adjustable sensitivity control
- Easy to set shut off timer ranges from 5–60 minutes
- UL listed for use over bathtub and shower when connected to a GFCI protected branch circuit
- Energy Star Certified
- HVI Certified RDM1 radiation damper accessory for InVent Series

QTXE HUMIDITY SENSING FAN FEATURES

- Grille mounted humidity sensor for faster reaction time
- Fits 2" X 8" ceiling construction
- RDFQF radiation damper with RDJUMP accessory
- Includes hanger bar system for fast and flexible installation for all types of construction

INVENT HUMIDITY SENSING FAN AND FAN/LIGHT FEATURES

- FoldAway™ mounting ears for a 100% room side installation
- Efficient LED Lighting
- Fits 2" X 6" construction

Model	CFM	Sones	Bath Sq. Ft.	Lighting	Ducting	ENERGY STAR®
QTXE110S	110	0.7	100	—	6"▲	Yes
AE80S	80	0.8	75	—	4"	Yes
AE110S	110	1.0	100	—	4"	Yes
AE80SL	80	0.8	75	11 watt LED	4"	Yes
AE110SL	110	1.0	100	11 watt LED	4"	Yes

ENERGY STAR® fans use 70% less energy, on average, than standard models and may qualify for local utility rebates

▲ See page 54 for 6" ducting (DT6W) product specifications



INVENT SENSING FAN PROJECT PACKS

A000HFS PROJECT PACK



Simplify Installation with Project Packs.

Project Packs are available with four fan housings. When drywall work and painting is finished, the fan components needed to complete the job are available in a finish pack kit under a separate model number which includes the motor plate, motor, wheel and grille. See the matrix below for Project Pack order information.

Project Pack	Kit number	For model
Four-pack of FAN housings only:	A000HFS	
Four-pack finish kits for FAN models:	AE80F	AE80S
	AE110F	AE110S

AE80F | AE110F FINISH KITS



SMARTSENSE® VENTILATION SYSTEM

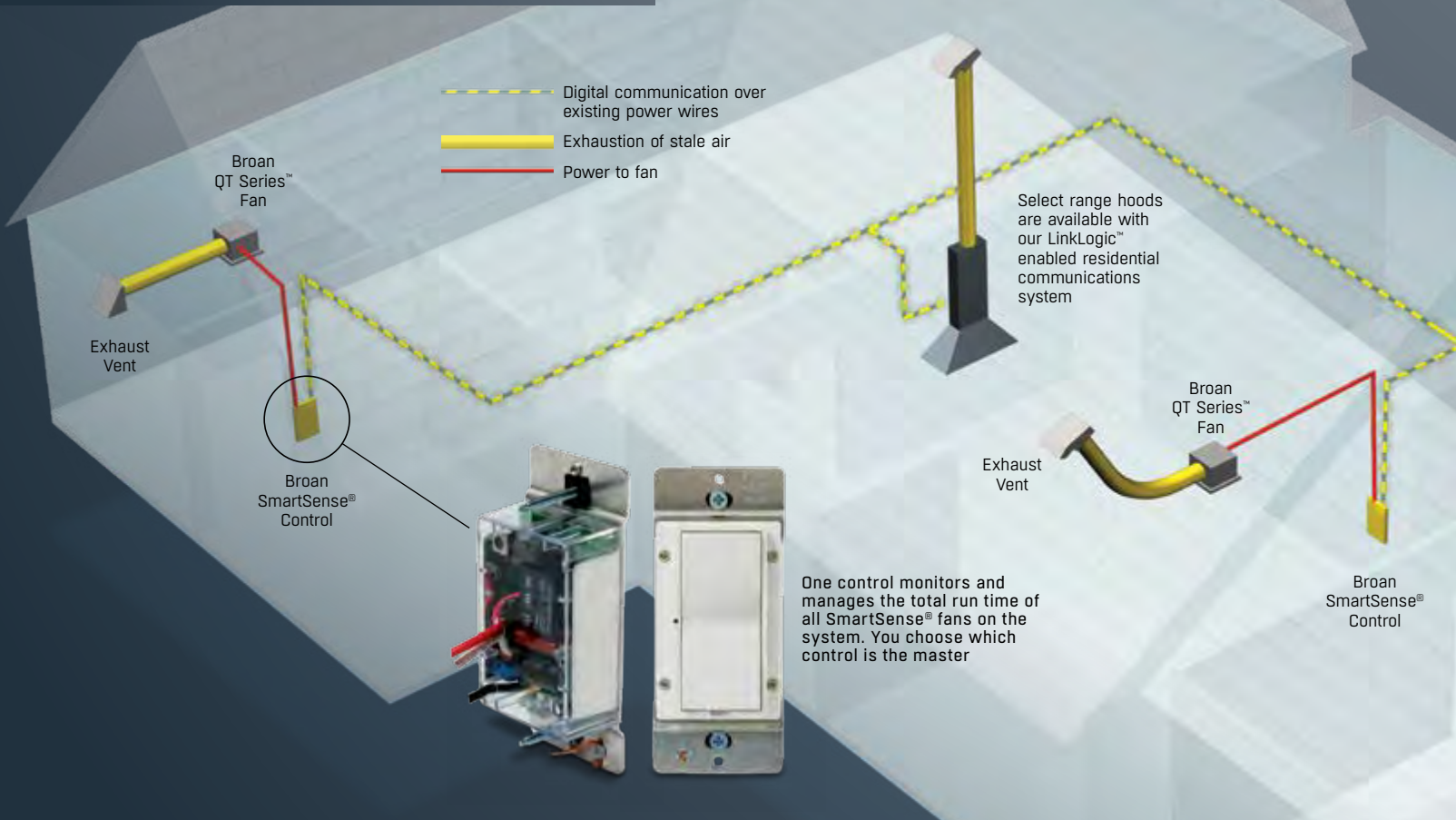

BROAN SMARTSENSE® AUTOMATICALLY COORDINATE YOUR BATH FANS

RDFQF



RDFQF PREMIUM RADIATION DAMPER FEATURES.

When the air temperature passing through the damper exceeds 165°F the fusible link melts, triggering the thermal fabric to automatically close across the damper. Airflow is interrupted by a flame and heat barrier, preventing the rapid spread of fire to other areas.

A SMART, ECONOMICAL OPTION TO MEET ASHRAE STANDARD 62.2.

Since most homes have several ventilation fans, Broan SmartSense® automatically operates your fans to ventilate your home around the clock. It's one solution for continuous and spot ventilation requirements.

A SmartSense® system coordinates ventilation fans in various locations to introduce fresher, healthier air. It may be programmed to ventilate based on the home's size, automatically cycling different fans based in the dwelling based on square footage and the number of bedrooms. LinkLogic control is at the heart of the system and requires no separate control wiring. SmartSense® is cost effective as it does not require integration with the home's air handler, and with only one fan running at a time, it uses less than 40 watts during ventilation cycles.

Model	CFM	Dimension
SSQTXE080	80	11 ³ / ₈ x 10 ¹ / ₂ x 7 ⁵ / ₈
SSQTXE110	110	11 ³ / ₈ x 10 ¹ / ₂ x 7 ⁵ / ₈

LinkLogic™

Wireless home control technology powered by INSTEON™.

- New timed-off and delayed-off features with new firmware
- Automatically operates the SMD series Make-Up Air Damper for installations requiring make-up air
- Interfaces with other LinkLogic® enabled products by Broan® or BEST®

AND RANGE HOOD TO VENTILATE YOUR HOME.

A BROAN AUTOMATIC MAKE-UP AIR DAMPER INTELLIGENTLY BRINGS FRESH AIR INSIDE.

The damper communicates with SSQTXE080 and SSQTXE110 fans as well as select BEST® and Broan range hoods to form a complete balanced ventilation system that ensures fresh air is available while ventilation is in process. This ensures balanced indoor air pressure while preventing unwanted air infiltration and wasted energy. SmartSense™ automatically operates the Make-Up Air Damper for installations requiring make-up air.

Easy Installation

- Located in a 6-inch or 8-inch duct running between an exterior wall fresh air inlet (641FA or 643FA) to an interior location such as a cold-air return or supply duct
- Locally powered by a 24 VAC transformer
- Communicates over existing home electrical wiring

Broan Make-Up Air Damper features:

- Heavy-duty galvanized steel construction
- 24 VAC transformer
- 6-inch round (SMD6), 8-inch round (SMD8)
- Use with any single fan or combination of SSQTXE080 or SSQTXE110 fans



FLEXIBILITY FOR



NEW CONSTRUCTION AND

INVENT SERIES FANS WITH TRUESEAL™ DAMPER TECHNOLOGY CAN SAVE UP TO 1 HERS POINT AND UP TO \$9 PER YEAR IN OPERATING COSTS*.

FoldAway™ Mounting Ears are precisely positioned for new construction and fold flat for room-side retrofits. Every installation can be handled more efficiently.

With our TrueSeal™ Damper Technology, InVent fans reduce air leakage by up to 50% compared to competitive models¹; resulting in better home performance via blower door tests.

EzDuct™ Connector enables room-side installation without attic access. Attach the housing, pull the duct through, attach the EzDuct™ Connector and reset it with one screw.



*Compared to competitive fans; based on software calculations and analysis conducted by Broan-NuTone. Testing reflects total fan housing air tightness.

¹See Broan.com/InVent for details.



ROOM-SIDE RETROFIT FROM ONE FAN.

VERSATILE INSTALLATION. AIRTIGHT PERFORMANCE. LED LIGHTING.

InVent Series gives professionals smart options for new construction or room-side retrofits in one, hard-working product line. InVent is about innovations such as FoldAway™ mounting ears and TrueSeal™ Damper Technology that improves building airtightness like never before. With fresh grille designs and a full range of operating points, there's an InVent Series solution for every installation.

InVent™ SERIES

LED Lighting offers greater energy efficiency and longevity, and adds a unique design detail to this hard-working fan. 11 watt, 800 Lumens integrated LED module lasts up to 25,000 hours.



INVENT FAN & FAN/LIGHT FEATURES

AE50, AE80, AE110, AE80B, A80, A80HD, A110

- FoldAway™ mounting ears allow for easy installation in both new construction and room-side replacement
- New TrueSeal™ damper technology forms a tighter seal to reduce backdrafts

- EzDuct™ Connector allows room-side installation with no attic access required
- Effective ventilation clears humidity and odors
- Attractive grille styling

AE80L, AE80BL, AE110L

- LED Fan/Light with 11 watt, 800 Lumens, 3000K, 80 CRI integrated module
- LED lasts up to 25,000 hours for maintenance-free convenience

A50L, A70L, A80L, A110L

- Incandescent Fan/Light with A19 Base (bulb not included)

AE50 | A80 | AE80 | AE80B | A110 | AE110

AE80L | AE80BL | AE110L

A50L | A70L | A80L | A110L

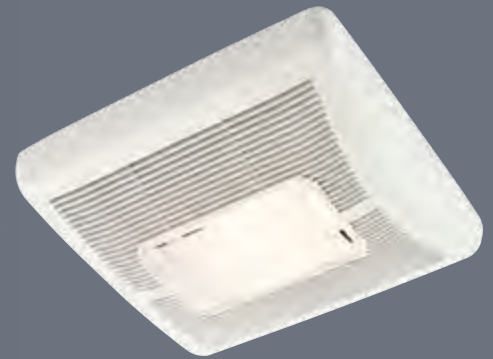

AE50, A80, AE80, AE80B, A110, AE110

AE80L, AE80BL, AE110L

A50L, A70L, A80L, A110L

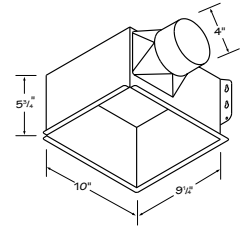
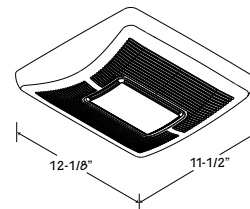
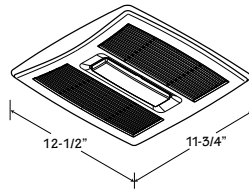
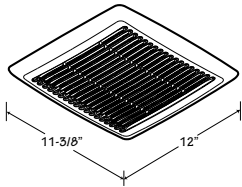

INVENT Fan Models

Model	CFM	Sones	ENERGY STAR®
A80	80	2.0	No
A80HD*	80	2.0	No
A110	110	3.0	No
AE50	50	0.5	Yes
AE80	80	0.8	Yes
AE80B	80	1.5	Yes
AE110	110	1.3	Yes

ENERGY STAR® fans use 70% less energy, on average, than standard models and may qualify for local utility rebates



*Metal Grille

INVENT Fan/Light Models

Model	CFM	Sones	Lighting	ENERGY STAR®
A50L	50	1.5	A19 Base**	No
A70L	70	2.0	A19 Base**	No
A80L	80	1.0	A19 Base**	No
A110L	110	1.3	A19 Base**	No
AE80BL	80	1.5	LED	Yes
AE80L	80	0.8	LED	Yes
AE110L	110	1.3	LED	Yes

ENERGY STAR® fans use 70% less energy, on average, than standard models and may qualify for local utility rebates



**Bulb Not Included

INVENT™ SERIES ACCESSORIES

A range of accessories ensures a custom fit in any application. Choose optional duct connectors, a radiation damper and a metal grille for commercial installations, and hanger bars for exact positioning.

With our QFlow™ Duct Connector (MODEL MQF4), InVent fans reduce air leakage by up to 65% compared to competitive models¹, offering an extremely tight seal when closed and completely open airflow when open.

RDM1 RADIATION DAMPER for fans and ENERGY STAR fan/lights only

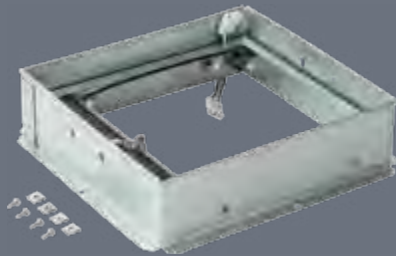

MQF4 DUCT CONNECTOR



MMG METAL GRILL

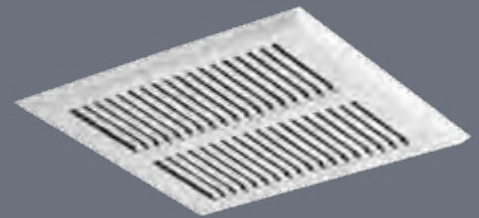

MHB4 HANGER BARS

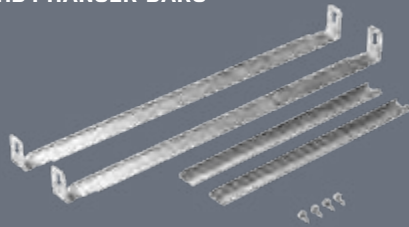

MMD4 METAL DUCT CONNECTOR



Broan InVent™ Series Project Packs. Keep your job on schedule and your inventory safe. Even if the final fan or fan/light product has not been selected, a project pack enables you to install a fan or fan/light housing now and choose the right-sized finish pack later. You won't have an open box on the job site with a motor and grille that could be lost or damaged.

INVENT Fan Finish Packs

Model	CFM	Sones	ENERGY STAR®
A80F	80	2.0	No
A80HDF*	80	2.0	No
A110F	110	3.0	No
AE50F	50	0.5	Yes
AE80BF	80	1.5	Yes
AE80F	80	0.8	Yes
AE110F	110	1.3	Yes

ENERGY STAR® fans use 70% less energy, on average, than standard models and may qualify for local utility rebates



*Metal Grille

INVENT Fan/Light Finish Packs

Model	CFM	Sones	Lighting	ENERGY STAR®
A70LF	70	2.0	A19 Base**	No
AE80BLF	80	1.5	LED	Yes
AE80LF	80	0.8	LED	Yes
AE110LF	100	1.3	LED	Yes

ENERGY STAR® fans use 70% less energy, on average, than standard models and may qualify for local utility rebates



**Bulb Not Included

INVENT Housing Packs

Model	Description
A000HF	Fan Housing
A000HL	Fan/Light Housing

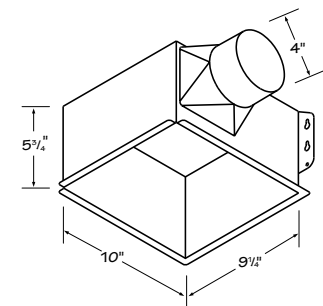

¹Testing reflects total fan housing air tightness. See Broan.com/InVent for details.



A WELL VENTILATED ROOM IS A

HEALTHIER



LOOK TO BROAN, THE VENTILATION EXPERTS, TO KEEP EVERY ROOM OF YOUR HOUSE FRESH.

Broan engineers the right product to fit every application, room size and need. Select from a variety of features that best meet your spot ventilation needs. Begin by assessing how powerful the fan should be or whether you could use additional lighting in your space. Think about what product style, finish or shape would look best. Rest assured, if you're concerned about saving money and energy, Broan bath fans that feature ENERGY STAR® can reduce energy consumption by as much as 70%. Broan has the perfect product designed around your needs.



Wall or ceiling mount, LoProfile is the right fan for a tight fit. The new Broan LoProfile™ Fan is our latest solution for installations where conventional ventilation simply won't fit. Where multi-family applications require it, the LoProfile™ fan is narrow enough to be installed in a wall between 2x4 studs. When plumbing or electrical obstructions are found behind the drywall in ceiling remodel applications our LoProfile™ fan can still fit without having to move anything. And that means most any room with space constraints can have powerful, quiet, efficient ventilation.

ROOM.



LP80

The oval connector accepts standard 4" duct, or 3" duct with the supplied adapter

Electrical connections can be made through the top or the side of the housing

LOPROFILE™

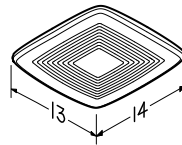
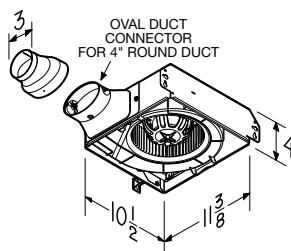

Model	CFM	Sones	ENERGY STAR®
LP80	80	1.0	Yes

ENERGY STAR® fans use 70% less energy, on average, than standard models and may qualify for local utility rebates



FEATURES

- Fits in 2x4 ceiling or wall construction
- 80 CFM with 4" duct ensures ample air movement; 70 CFM with 3" duct reducer
- >50 CFM at 0.25" static pressure meets ASHRAE 62.2 local ventilation requirements (with 4" oval duct or 3" round duct)
- Only 1.0 sones for quiet operation (4" duct)
- 4" oval or 3" round duct connection for installation flexibility
- Efficient operation lowers utility bills
- Ideal for multi-family applications
- Compatible with RDF1 Premium Radiation Damper
- Project Packs available

RDF1

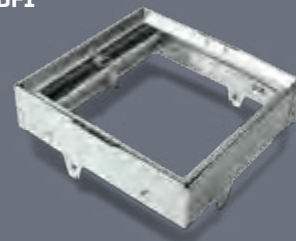

FAN/LIGHT FEATURES

657, 696

- Powerful centrifugal blower
- White polymeric grille complements virtually any décor
- A19 base lighting (bulb not included)
- Ceiling mount

750, 751

- Powerful centrifugal blower
- Round design eliminates squaring with walls
- Model 751 is the same as Model 750, but without a night light
- A19 base lighting (bulb not included)
- Ceiling mount

678, HD80L

- White polymeric grille complements virtually any décor
- Ceiling mount
- Project Packs available
- HD80L designed for continuous operation

CEILING & WALL MOUNT FEATURES

670, 671, 688, 689

- Compact housing fits between ceiling joists or wall studs
- Metal grille kits (available separately)
- Project Packs available for most models

657 | 696

750 | 751

678 | HD80L

670 | 671 | 688 | 689

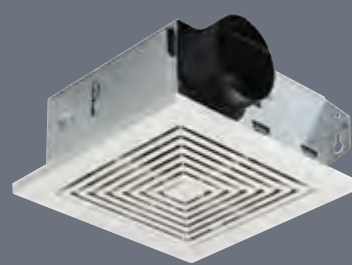

657, 696

750, 751

678, HD80L

670, 671, 688, 689

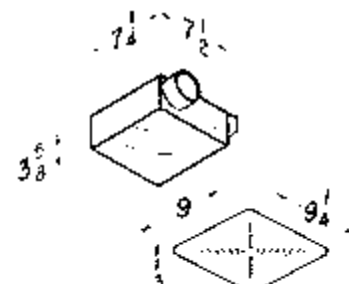
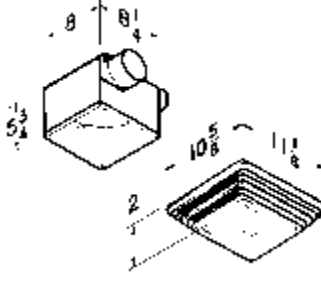
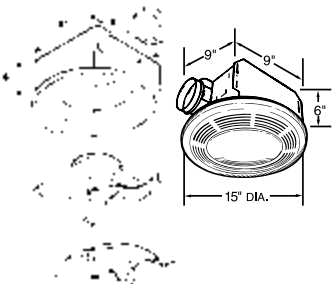
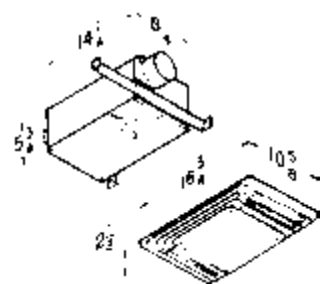

Model	CFM	Sones	Light/Night Light	Ducting
657	70	4.0	A19 Base	4"
696	100	4.5	A19 Base	4"
750	100	3.5	A19 Base / 7W	4"
751	100	3.5	A19 Base	4"
678	50	2.5	A19 Base	4"
HD80L	80	2.5	A19 Base	4"

Model	CFM	Sones	Ducting	Mounts
670	50	3.5	3"	Wall / Ceiling
671	70	6.0	3"	Wall / Ceiling
688	50	4.0	3"	Wall / Ceiling
689	60	5.5	3"	Wall / Ceiling

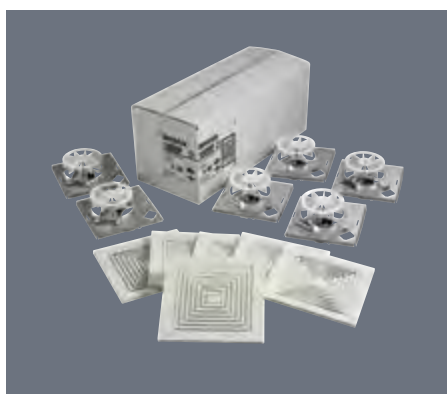

Project Packs. Convenient options for today's contractor. Broan "H" Packs include rough-in housings only, making multi-unit installation more convenient. "F" Packs allow motor/blower and grille assemblies to be ordered separately, nearer project completion, to help avoid losing, damaging or having to store components.

690 BATH FAN UPGRADE KIT

The Broan bath fan upgrade kit lets you convert your old bath fan to a brand new unit in just 10 minutes. Improve performance, reduce the sound level, and upgrade the appearance of your economy fan in minutes.

- Cut sound levels up to 50%
- Boost air movement up to 20%
- 10 minute installation
- 60 CFM, 3.0 Sones
- Modern white grille
- No special tools needed

690

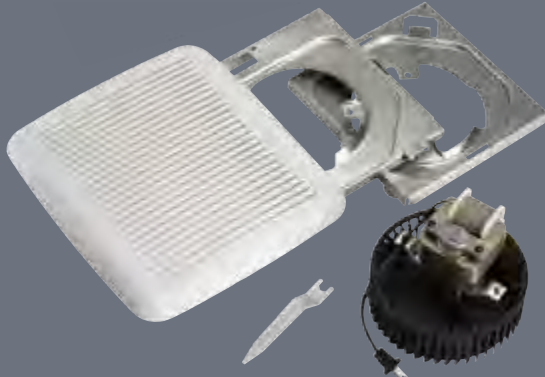

Included: Grille; two motor plates, depending on your fan model; wrench; quieter plug-in fan motor



1. Remove old grille

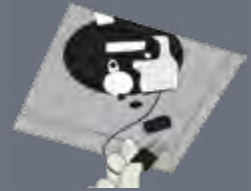

3. Attach new fan and new motor plate. Install into existing housing





2. Remove old fan assembly





4. Install new grille

Measure your existing fan housing to ensure proper fit

For use only with these bath fan models.*		Measurements	Yes	No
	NuTone 693, 695, 696N	7½" x 7¼"	•	
		8" x 7¼"	•	
	Broan 670, 671, 688, 689	7½" x 7¼"	•	
		8" x 8¼"		•
	Nautilus N671, N688	7½" x 7¼"	•	
		8" x 8¼"		•

*No other usage has been tested or authorized by Broan-NuTone LLC.

Broan 690 Upgrade Kit replaces the models below

If your grille looks like this:	The fan is very likely one of these models:	Housing dimensions:
	NuTone 693, 695, 696N	7½" x 7¼" or 8" x 7¼"
	Broan 670, 671, 688, 689 Nautilus N671, N688	7½" x 7¼" Not compatible with 8" x 8¼"

682 DUCT FREE FAN

- Patented, fast snap-in metal housing installation
- Fan circulates air past replaceable activated charcoal filter
- Fits 2" x 4" ceiling or wall construction

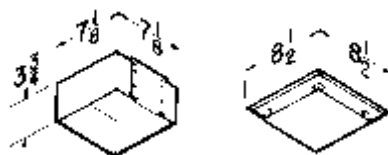

682

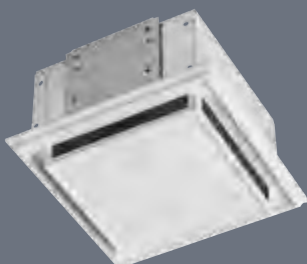

Model	CFM	Sones	Lighting	Notes
682	—	—	—	Duct-free Circulation
S97009563	—	—	—	Replacement filter

Duct-free. This easy-to-install solution is ideal where air circulation is needed but ducting is impossible or impractical. Use it as a solution for half baths or rooms where humidity isn't a concern.

QUALITY VENTILATION THAT COMPLEMENTS YOUR DÉCOR.

Every room needs ventilation, from closets to bedrooms to baths. But adding a fan/light combination that complements or enhances the room décor has been challenging. That's why the Broan Architectural products are perfect. Imagine a fan/light combination fixture that unobtrusively blends into the ceiling. Or a statement fan/light with a stunning LED perimeter glow that showcases your unique décor. The Architectural series helps you meet your decorating challenges without compromising your style.

VENTILATION THAT MOVES IN RATHER

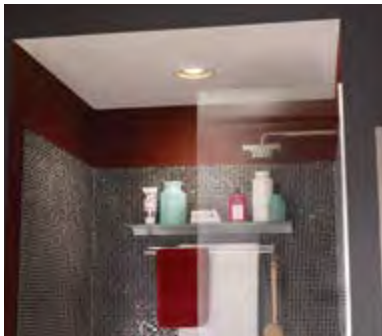



THE AIR, MOVING WAYS.

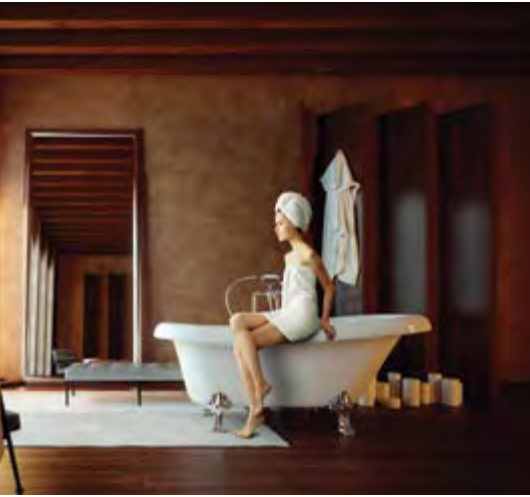

744 SERIES RECESSED FAN/LIGHT FEATURES

- High efficiency centrifugal fan
- 70 CFM at 1.5 sones
- Trim matched to designs of major recessed light manufacturers
- Put multiple units in larger rooms
- Model 744 uses a standard A19 base, 75 watt maximum (R30 or BR30 for standard applications)
- Models 744FL and 744SFL include a 16 watt, GU24 based, R30 shaped CFL bulb (included)
- Model 744LED includes a 10 watt, GU24 based LED bulb (included)
- All models UL Listed for use over bathtub or shower when connected to a GFCI protected branch circuit. Model 744 requires a PAR30L or PAR30LN type bulb (not included)
- 6 $\frac{7}{8}$ " high housing appropriate for new construction and 2" x 8" ceiling joists
- 4" round duct connector
- Optional wall control switches available
- Type IC, sealed housing
- Not for use over cooking surfaces

Humidity Sensing Model 744SFL Features

- SensAire® technology detects the rapid rise in humidity and automatically turns the fan on and off
- Humidity is sensed at the ceiling level
- Easily accessible sensitivity adjustment
- Easy-to-set 5–60 minute shut-off timer

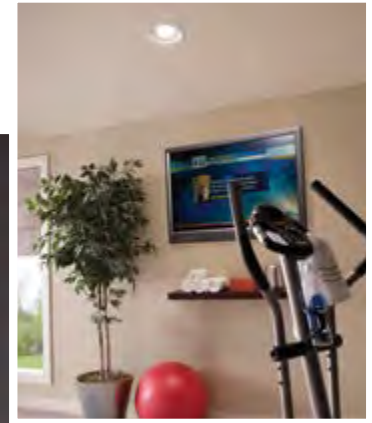
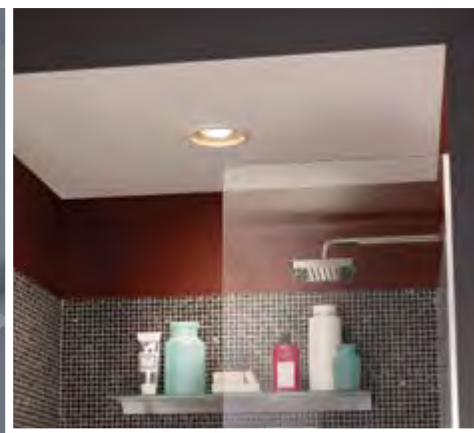

SensAire® technology behind the trim detects changes in humidity and automatically turns the fan on and off

**YOU'D NEVER KNOW
IT'S A FAN, AND THAT'S THE POINT**

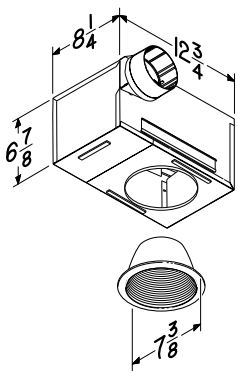

Model	CFM	Sones	Lighting	Humidity Sensing	Ducting	ENERGY STAR®
744	70	1.5	75W MAX	—	4"	—
744FL	70	1.5	16W Fluor.	—	4"	Yes
744LED	70	1.5	10W LED	—	4"	Yes
744SFL	70	1.5	16W Fluor.	Yes	4"	Yes

ENERGY STAR® fans use 70% less energy, on average, than standard models and may qualify for local utility rebates



Broan took recessed lighting a step further by incorporating powerful, quiet ventilation in the same design. These fan/lights disappear into the ceiling and match perfectly with other recessed lights. Models 744, 744FL and 744LED are practical ventilation solutions for any room in the house, such as the utility room, kitchen or high-traffic family room—any space you wish to keep fresh and comfortable. In the bath, Model 744SFL starts automatically when a rapid rise in humidity is detected. You'll never forget to turn the fan on again.

DECORATIVE FAN/LIGHT FIXTURE FEATURES

- 70 or 80 CFM at 2.5 or 3.5 Sones
- Corrosion-resistant finishes
- Beautifully styled glass globes
- Use two 60-watt incandescent candelabra bulbs (not included)
- Plug-in lighting fixture and permanently lubricated motor
- Polymeric blower wheel
- Not UL approved for use over bathtubs or showers
- Sturdy, keyed mounting brackets for quick, accurate installation
- Fits 2" x 6" ceiling construction
- Tapered, polymeric 4" round duct fitting for easy, positive duct connection and no metallic clatter
- Type IC

FAN WITH SOFT SURROUND™ TECHNOLOGY FEATURES

- LED lasts up to 25,000 hours, nearly eliminating the hassle of bulb replacement
- 9 watt lighting for extreme energy efficiency
- Bright 800 lumen integrated LED light engine for energy efficiency
- 3000K color temperature provides bright, soft light ideal for bathrooms
- Minimum 80 Color Rendering Index (CRI) which meets ENERGY STAR® requirements
- Fits in 2" x 6" ceiling construction
- 110 CFM for strong air movement
- 1.5 sones for quiet operation
- ENERGY STAR® certified
- 4" duct connector balances powerful, quiet operation with easy installation
- UL listed for use over bathtubs and showers when connected to a GFCI protected branch circuit
- Type IC for use in direct contact with thermal insulation

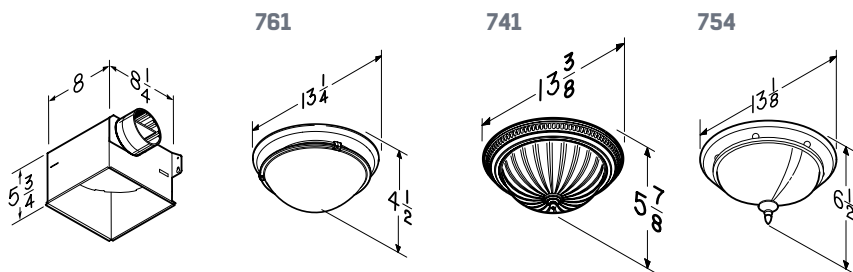

Model	CFM	Sones	Lighting	Bulb Type	Finish	Glass
761BN	80	2.5	2-60W	Candelabra	Brushed Nickel	White Opal
761RB	80	2.5	2-60W	Candelabra	Oil-Rubbed Bronze	Ivory Alabaster
761WHA	80	2.5	2-60W	Candelabra	White	White Alabaster
741SN	70	3.5	2-60W	Standard	Satin Nickel	Frosted
754RB	70	3.5	2-60W	Candelabra	Oil-Rubbed Bronze	White Alabaster

A beautiful balance of elegance and performance.

Now you can ventilate while adding quiet elegance and exceptional design to any room in your home with beautifully styled glass globe lighting. These fan/lights are available in corrosion-resistant decorator finishes.

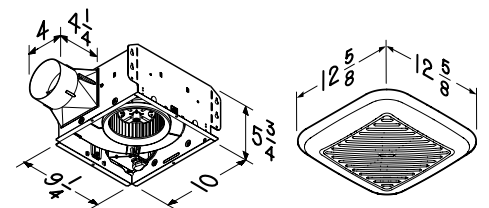

Model	CFM	Sones	Lighting	HVI	Ducting	ENERGY STAR®
791LEDM	110	1.5	9W LED	Yes	4"	Yes

ENERGY STAR® fans use 70% less energy, on average, than standard models and may qualify for local utility rebates





EVERY ROOM CAN BE MORE

COMFORTABLE

WITH A LITTLE VEN



THERE'S A BROAN VENTILATION SOLUTION FOR EVERY ROOM IN YOUR HOME.

Without doubt, every room needs ventilation. That's why our specialty lines deliver clean, fresh air where you need it most—including your bathrooms, laundry room, recreation room, workshop or nursery. Look to our room-to-room, wall/ceiling mount, through-wall or vertical discharge utility fans for powerful spot ventilation. Or, install our remote mounted in-line ventilation system for a quiet whole-house solution. Our recessed fan/lights perfectly match other recessed fixtures, including humidity sensing options that start automatically when a rapid rise in humidity is detected. Elegant, simple, practical and powerful. Exactly what you've come to expect from Broan.

VENTILATION FOR THE *MUSIC FAN*

Quiet Ventilation Fan with Quality Wireless Speakers.

It's your music—out of sight. Unlike wireless speakers that require counter space, Sensonic™ speakers with *Bluetooth®* wireless technology fill your room with rich sound from above. From hard rock to news talk, play any audio through the dual high-fidelity speakers and enjoy entertainment and privacy at the touch of a button.



TILATION.



Speaker also available as an accessory. Quickly and easily add a high-fidelity Sensonic™ speaker to most Broan or NuTone QT Series Ventilation Fans

SENSONIC FEATURES

- Dual High-Fidelity Sensonic™ Speakers
- Brilliant audio performance concealed behind your fan grille
- Play any audio through most *Bluetooth®*-enabled devices
- Effective, extremely quiet ventilation clears humidity and odors quickly
- ENERGY STAR® certified
- UL Listed for use over bathtub or shower when installed with a GFCI protected branch circuit
- Type IC for use in direct contact with thermal insulation
- Fits 2"x 8" ceiling construction
- Includes unique spacer for easy I-joist mounting
- Mounts between joists with optional QTHB1 Hanger Bar Kit (sold separately)

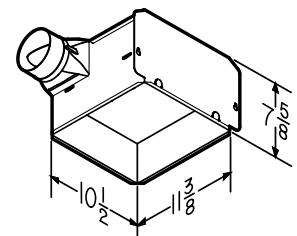

Model	Description	CFM	Sones	Ducting
SPK110	Fan with Speaker	110	1.0	4"
SPKACC	Speaker Accessory	—	—	—



The *Bluetooth®* word mark and logos are registered trademarks owned by Bluetooth SIG, Inc. and any use of such marks by Broan-NuTone LLC is under license.



THROUGH-WALL FANS

- Housing adjusts to fit walls from 4½"-9½" thick
- Specially designed polymeric fan blade
- Built-in damper minimizes backdrafts for energy efficiency
- Paintable polymeric grilles
- Accessorize with wall switch or variable speed wall control
- Louvered exterior wall cap with built-in bird screen
- 6" diameter flexible aluminum duct included

508 (10"), **509/509S** (8")
 • 509S: features an integral ON/OFF rotary switch-no wall switch to wire

512M
 • 6" Through-Wall

12C MOTORDOR®

- 10" Through-Wall
- Separate motor opens and closes the vent door automatically

WALL/CEILING-MOUNT, SIDE DISCHARGE FANS

502, 503

- Installs easily between ceiling joists or wall studs
- Built-in damper prevents backdrafts
- Fits 3¼" x 10" duct

508 | 509 | 509S

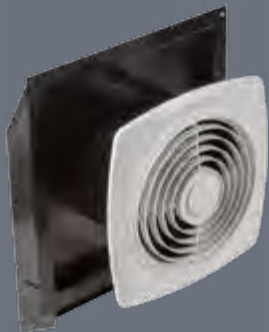

512M



12C MOTORDOR®

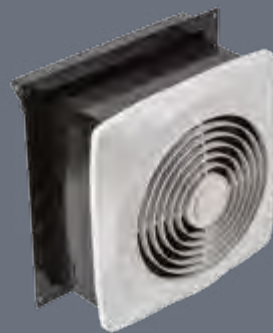

502 | 503

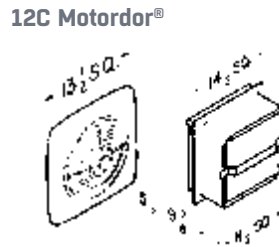
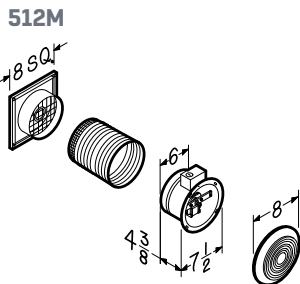
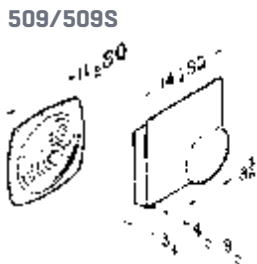
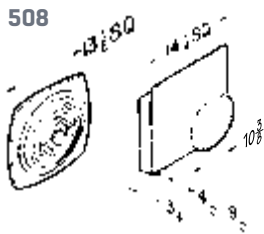
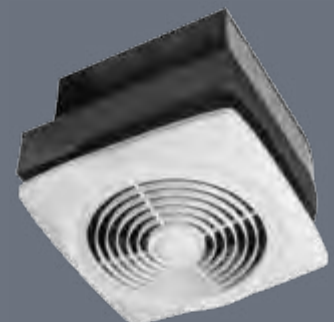

Model	CFM	Sones	Diameter	Sizing Specifications
506	470	8.0	10"	Fits 4½"-9½" thick walls
507	250	7.0	8"	Fits 4½"-9½" thick walls
510	380	6.5	10"	Fits 3"-5½" thick walls
511	180	4.5	8"	Fits 3"-5½" thick walls
502	270	8.0	10"	Fits 3¼" x 10" duct
503	160	5.0	8"	Fits 3¼" x 10" duct
508	270	6.0	10"	Fits 4½"-9½" thick walls
509/509S	180	6.5	8"	Fits 4½"-9½" thick walls 509S Integral ON/OFF Rotary Switch
512	90	3.5	6"	Fits up to 5½" thick walls
512M	70	3.5	6"	Fits up to 5¼"-10" thick walls
12C Motordor®	360	8.0	10"	Fits 5½"-97/8" thick walls
504	350	6.5	10"	Fits 10" round duct
505	180	6.5	8"	Fits 8" round duct
673	60	4.5	6"	Fits 6" round duct

VERTICAL DISCHARGE

- Galvanized steel housing installs easily between ceiling joists
- Steel mounting brackets with keyhole slots for fast installation

504

- 10" vertical discharge
- Fits 10" round duct-use Model 472 transition/damper (available separately) for 8" round duct (performance will be reduced)

505

- 8" vertical discharge with built-in damper
- 8" fan, 8 $\frac{1}{4}$ " diameter housing

673

- 6" vertical discharge with built-in damper
- 6" paintable fan, spin-on, white polymeric grille

CHAIN-OPERATED UTILITY FANS

- Pull-chain opens the door and starts fan
- Housing adjusts to fit walls from 4 $\frac{1}{2}$ "-9 $\frac{1}{2}$ " thick
- Specially designed polymeric fan blade
- Housing features foam-insulated door for energy efficiency

506

- 10" fan (10 $\frac{3}{8}$ " diameter sleeve)

507

- 8" fan (8 $\frac{3}{8}$ " diameter sleeve)

504 | 505

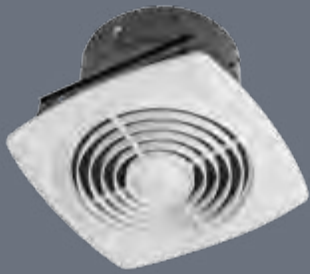

673



506 | 507

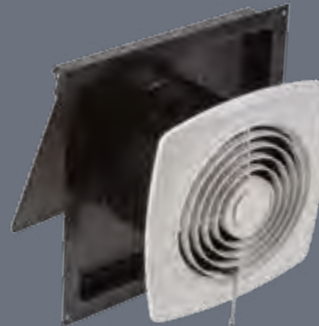

504

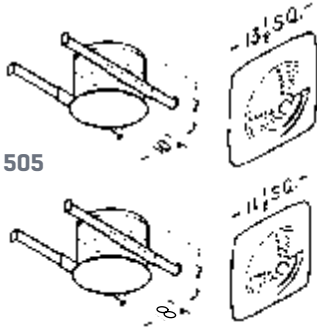

505

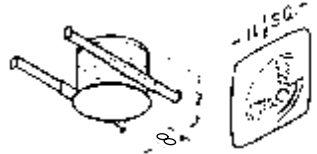

673

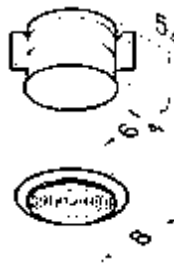

506

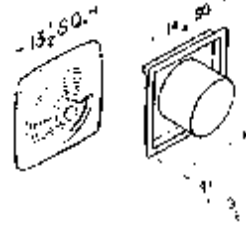

507

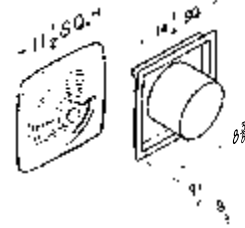

ROOM-TO-ROOM FANS

Room-to-Room ventilators provide quick solutions where more ventilation is needed—without installing new ductwork.

- Built-in variable speed control
- Easy installation through wall 3"-5 $\frac{1}{2}$ " thick
- Permanently lubricated motor
- Paintable white polymeric grilles
- Not for use in kitchens

510, 10"; **511**, 8"

510, 511

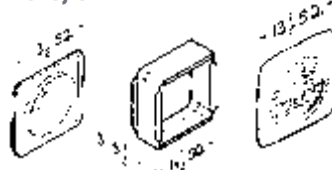

512

- 6" Room-to-Room
- Use 57W or 57V variable speed control separately

512



512

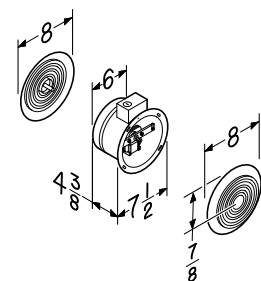

510 | 511

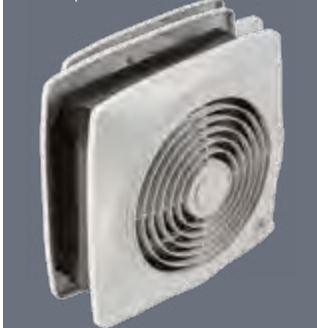

MULTI- AND SINGLE-PORT IN-LINE VENTILATORS FEATURES

- Energy-efficient, permanently lubricated motors
- High pressure centrifugal blowers easily accommodate long duct runs
- Designed for quick, easy installation
- HVI certified and AMCA licensed
- Suitable for intermittent or continuous ventilation applications
- Removable panels offer easy access to the motor without disturbing ductwork
- Plug-in blower simplifies wiring

Multi-Port In-Line Ventilators

- Ventilate multiple bathrooms or other rooms simultaneously
- Great solution for large, open spaces
- Install in virtually any orientation
- 6" round outlet; 4" round inlets (two inlet duct covers included)
- Use 2, 3 or all 4 inlet ports

Single-Port In-Line Ventilators

- Ventilate any room in virtual silence
- 6" round outlet and inlet for easy duct connections

MP100 | MP140 | MP200

MP280

SP100 | SP140 | SP200

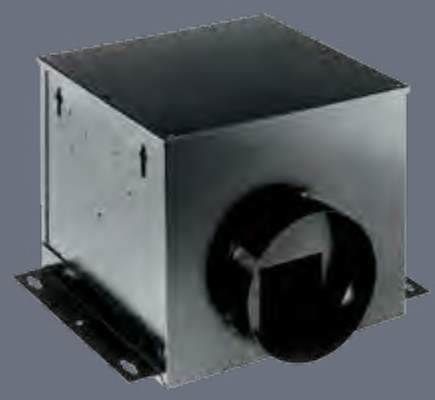

MP100, MP140, MP200

MP280

SP100, SP140, SP200

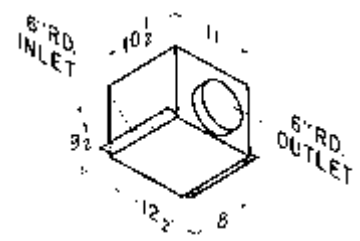
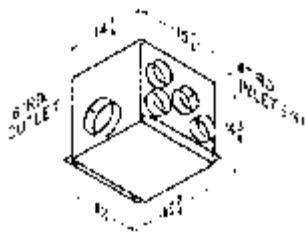
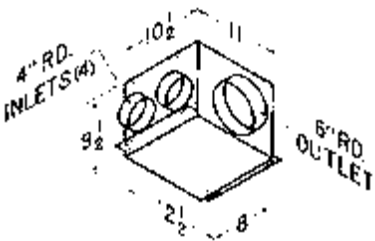

Multi-Port	CFM	Sones	Notes
MP100	110	1.0	Four inlets
MP140	150	1.5	Four inlets
MP200	210	2.0	Four inlets
MP280	290	3.0	Four inlets
SP100	110	1.0	One inlet only
SP140	150	1.5	One inlet only
SP200	210	2.0	One inlet only

HVI rated air flow at 0.2" static pressure. Sound test procedures are similar to HVI tests for other exhaust fans.

Remote Mounted In-Line Ventilation Fans.

Quiet and efficient residential solutions. The concept is simple: mount a high-performance ventilator in an out-of-the-way spot and you get the power with virtually no sound. Install the housing in the attic or the basement, wherever it's most convenient and discrete.

WITH A MULTI-PORT, IN-LINE VENTILATION SOLUTION

the blower is mounted away from the living area for virtually silent operation. Multi-port installations allow ventilation of up to four rooms, or use multiple inlet ports to clear the air in larger rooms. Single-port, In-line ventilators provide the same noise reduction benefits.

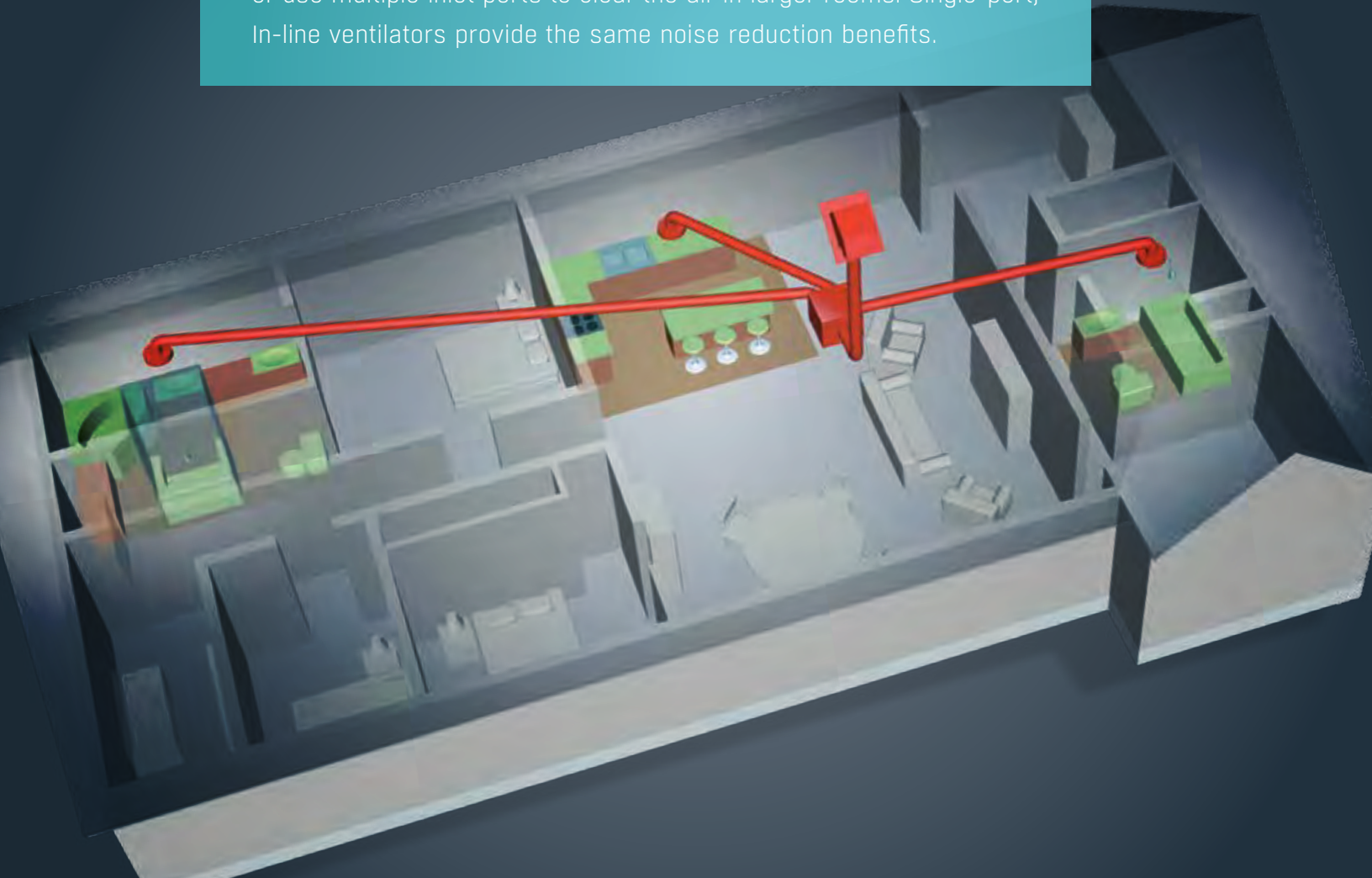

CVG4 | CVG6



Room Inlets

- Models available for 6" (CVG6) or 4" (CVG4) round duct
- Install in ceiling or wall
- Paint to match room décor
- Available in six packs only

Accessories

Model	Description	Ducting/Size	Notes
CVG4	Grille Intake	4"	Round Grille
CVG6	Grille Intake	6"	Round Grille
CVLD4	Sleeve	4"	Sleeve with damper
CVLD6	Sleeve	6"	Sleeve with damper
CVL4	Sleeve	4"	Sleeve without damper
CVL6	Sleeve	6"	Sleeve without damper
FY6	Y Adapter Only	6" x 6" x 6"	



INSTANT HEAT, RIGHT WHEN YOU NEED IT AND ONLY WHERE YOU NEED IT

POWERFUL HEATING, LIGHT AND VENTILATION AT THE TOUCH OF A SWITCH.

No matter where you live your house can become chilled. Maybe it's early fall before the furnace is on, or maybe the cool desert nights mean colder rooms. And there's certainly one room you never want to be chilly—the bathroom. Whether it's taking a morning shower, or relaxing in a whirlpool at the end of a long day, your family appreciates a warm, comfortable bathroom. Broan heater/fan/lights are the perfect solution. You have instant heat to quickly warm up the room, a quiet ventilation fan to remove excess humidity and a convenient light—all in one fixture. Each one can be operated separately, or they can be used simultaneously when needed, no furnace required.



ED IT.
WANT IT.

QT SERIES FEATURES

- Efficient PowerHeat™ heater design
- Choice of standard A19 base (2, 60 watt) lighting (bulbs not included) or energy-efficient 36 watt GU24 fluorescent (bulbs included)
- Fan motor is engineered for continuous operation
- HVI Certified
- Type IC
- Requires a dedicated 20 amp circuit
- Switches sold separately
- 7 watt night-light bulb not included

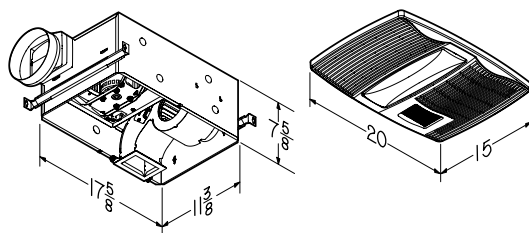
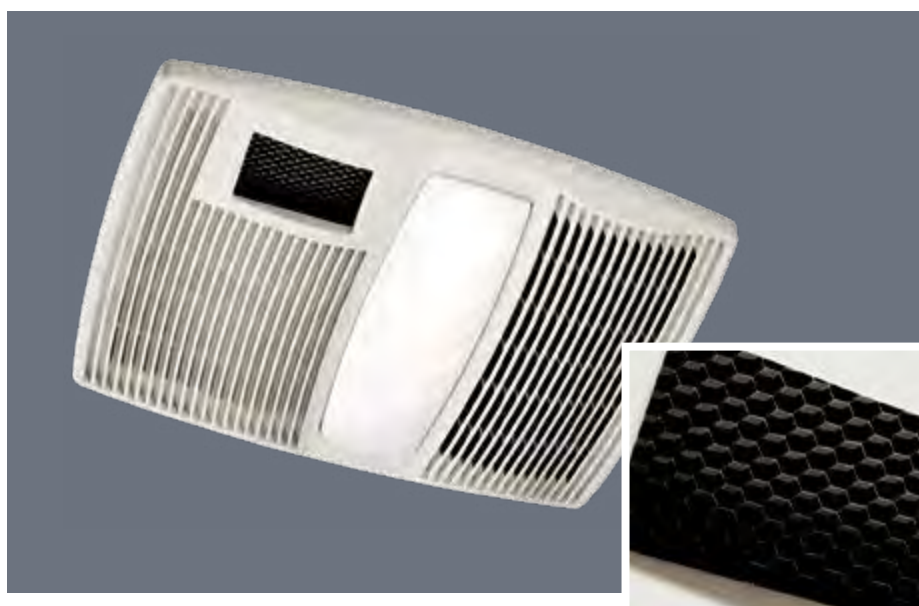

PowerHeat™ is a Broan design that maximizes heat output per watt. With the heater element close to the forced air exit grille, the internal components are not heated. Heat is delivered into the room and does not escape into the ceiling or attic space.

Heater/Fan/Light

Model	CFM	Sones	Bath Sq Ft.	Lighting/ Night Light	Heater Watts	Ducting
QTX110HL	110	0.9	100	Std. A19 Base (2- 60W)** / 7W**	1500	6"
QTX110HFLT	110	0.9	100	36W Fluorescent (2- 18W)* / 7W**	1500	6"

*Bulbs included
**Bulbs not included



DIRECTIONALLY ADJUSTABLE HEATER/FAN LIGHT FEATURES

- Heater/Fan/Light brings convenient, comforting warmth to your bathroom
- Quiet, high-output heater with exclusive directionally adjustable design (see below)
- 4" ducting for new construction or retrofit
- Multi-function wall switches sold separately
- Choice of Standard A19 base or energy-efficient 27 watt GU24 (bulb included) fluorescent lighting
- Fan motor is engineered for continuous operation
- HVI Certified
- Type IC
- Requires a dedicated 20 amp circuit
- Fits 2" x 6" ceiling construction

100HL | 100HFL

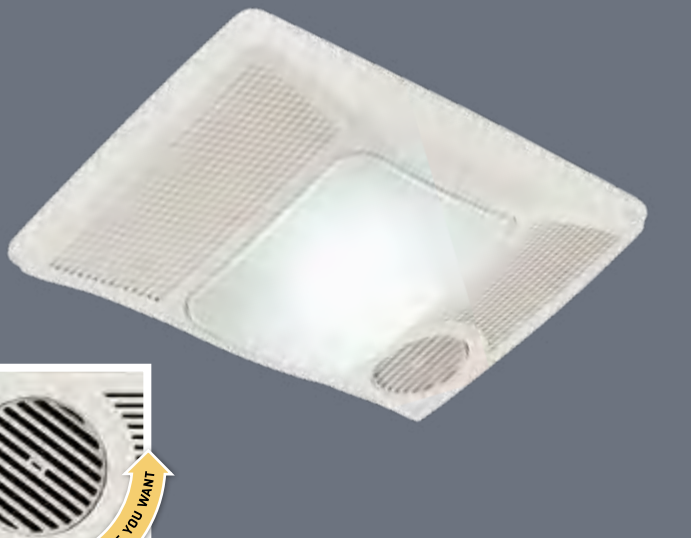

100HL, 100HFL

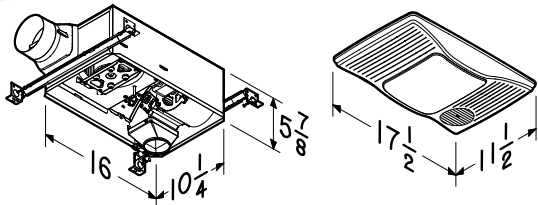

Heater/Fan/Lights

Model	CFM	Sones	Bath Sq Ft.	Lighting	Heater Watts	Ducting
100HL	100	2.0	90	Std A19 Base	1500	4"
100HFL	100	2.0	90	27W GU24 Fluorescent	1500	4"

HEATER/FAN & HEATER/FAN/LIGHT FEATURES

- Designer white polymeric grilles complement virtually any décor
- 1300 watt heaters
- Fan, light and heater function independently or together
- Type IC
- Fits 2" x 6" ceiling construction
- Two- or three-function wall controls are available separately
- **655:** 20-amp circuit required
- **659:** 15-amp circuit required
- **656:** Heater/Light Only, 15-amp circuit required
- **658:** Heater/Fan, 15-amp circuit acceptable

655 | 656 | 659

658



655, 656, 659 Grille

658 Grille

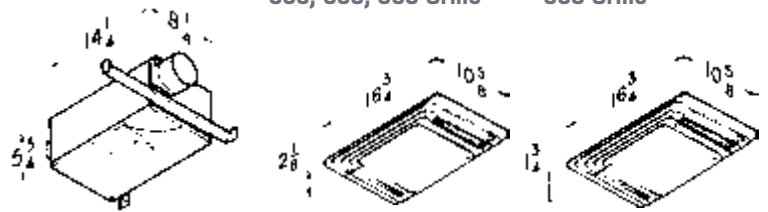

Heaters & Heater Fans

Model	CFM	Sones	Lighting	Ducting	Heater
655	70	4.0	Std A19 Base	4"	1300W
656	—	—	Std A19 Base	—	1300W
658	70	4.0	No Light	4"	1300W
659	50	2.5	Std A19 Base	4"	1300W

Broan Directionally-adjustable Heater/Fan/Lights.

With our 360° directionally-adjustable heat outlet, you're assured the heat will end up exactly where you need it.



BULB HEATER/FAN FEATURES

- Quiet, highly efficient polymeric blower wheels
- Polymeric dampers prevent backdrafts and eliminate mechanical noise
- Polymeric 4" round duct connectors with tapered sleeves simplify ducting
- Operate fan and heater independently or together
- Attractive white polymeric grilles
- Compact steel housings with adjustable mounting brackets with keyhole slots that span up to 24"
- 250 watt R40 or BR40 size infrared bulbs (not included)
- Type IC, UL Listed for 60°C wiring (retrofits)
- **162:** One-Bulb Heater/Fan
- **164:** Two-Bulb Heater/Fan, Two-function control (available separately)

ONE OR TWO-BULB HEATERS—NO FAN

- Infrared bulbs deliver energy-saving warmth
- Get instant comfort in the bathroom without turning up the central thermostat
- 250 watt R40/BR40 size infrared bulbs (not included)
- Attractive, white polymeric grilles
- Compact steel housings
- Adjustable mounting brackets with keyhole slots span up to 24"
- **161:** One-Bulb Heater, UL Listed for 75°C wiring
- **163:** Two-Bulb Heater, Type IC

162

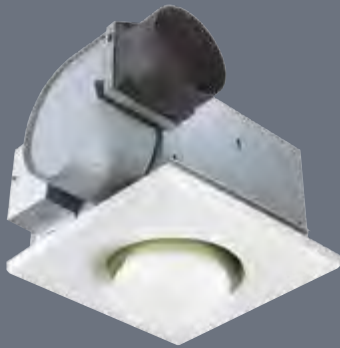

164

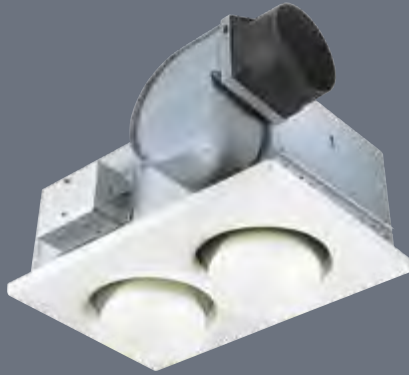

161



163



162

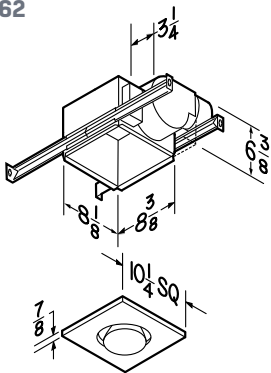

164

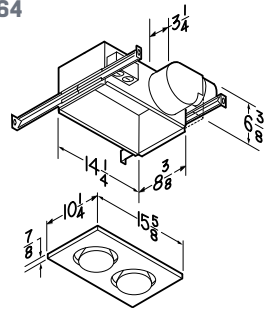

161

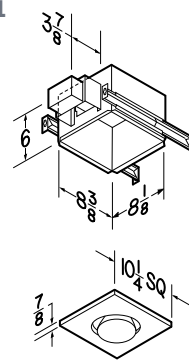

163

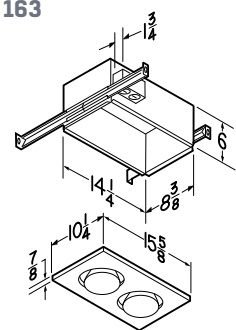

Bulb Heater Fans. Silent warmth and superior ventilation. Trust Broan Bulb Heater/Fans and Bulb Heaters for energy-saving warmth and instant comfort without ever having to touch your central thermostat. These units deliver superior performance and excellent ventilation in a compact package.

Bulb Heater/Fan & Bulb Heaters

Model	CFM	Sones	Bulb Watts
162 ¹	70	4.0	250
164 ¹	70	4.0	500
161 *	—	—	250
163	—	—	500

*NOT IC RATED
¹ HVI certified

PULL THE HEAT OUT OF YOUR ATTIC. PUT MONEY BACK IN YOUR WALLET.

Prevent heat and moisture build-up. In summer, attics can reach 150°F or more, warming your living area, increasing the air-conditioning load, and adding to your energy bill. In winter, ice dams can result, and moist air can condense causing mildew, rotting wood and wet insulation. Year-round attic ventilation ensures a cooler, drier attic that can extend roof life by preventing rot, premature aging and shingle distortion. A cooler attic extends the life of your air conditioner and lowers air conditioning expense.



How Much Ventilation Do You Need? Effective ventilation requires air to exit at or near the peak of the roof with replacement air drawn through soffit venting and louvers. The Home Ventilating Institute (HVI) recommends at least 10 air changes hourly to equalize temperature. Determine your attic ventilation needs below, or try the [Attic Ventilation Calculator at broan.com](http://broan.com).

DETERMINE YOUR VENTILATION NEEDS

1. Calculate the volume of your attic, in cubic feet, depending on the style of your home's roof.

 **Attic Volume for Gable Roof:**
Volume = Length x Width x Height x 1/2

 **Attic Volume for Hip Roof:**
Volume = Length x Width x Height x 1/3

2. Attic Volume x 10 Air Changes per Hour = Total Cubic Feet per Hour of ventilation recommended.

3. Total Cubic Feet per Hour 60 Minutes/Hour = Cubic Feet Per Minute (CFM) of Ventilation Recommended.

Example: Average Gable Attic Volume = $58\frac{3}{4}' \times 29' \times 7\frac{1}{4}' \times \frac{1}{2} = 6,176$ Cubic Feet
6,176 Cubic Feet x 10 Air Changes/Hour = 61,760 Cubic Feet/Hour ÷ 60 Min./Hour = 1,029 CFM

4. Replacement air is drawn through vents in your soffit. To determine the minimum soffit vent area required (in square inches) multiply the total CFM of your powered ventilator(s) by 0.48. This number is the total square inches of soffit venting required by your powered ventilator(s).

Example: 1,029 CFM x 0.48 = 494 Square Inches of soffit vent area recommended

ACCESSORIES

433



For use with Broan Models 353, 35316, 34560BK or 34560WW.

433 Automatic Shutter for Gable Mount Attic Ventilators

- Feature counter-balanced aluminum vanes that automatically open and close when the ventilator turns on and off
- Better air flow than stationary attic louvers
- Extruded aluminum frame fits flush with outside wall
- Weather-tight closure
- Easy to install

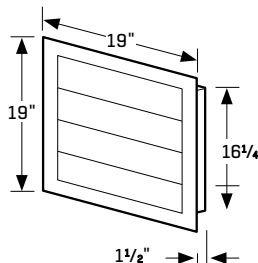

DH100W Humidistat

- Sold separately for use with all Broan powered attic ventilators. Humidistats automatically turn on the fan when moisture in the attic is detected



Model 73

- High Temperature Cut-off sold separately for use with all Broan powered attic ventilators. High temperature controls automatically turn off the ventilator at 204°F



• For additional switches see page 52-53

ROOF MOUNT, POWERED ATTIC VENTILATION

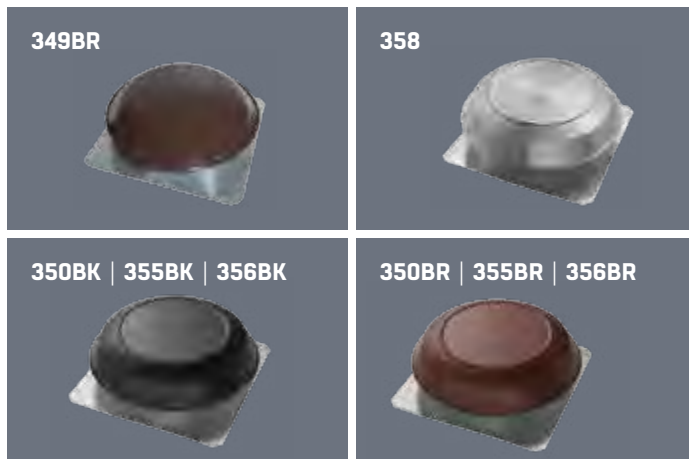

GABLE MOUNT, POWERED ATTIC VENTILATION

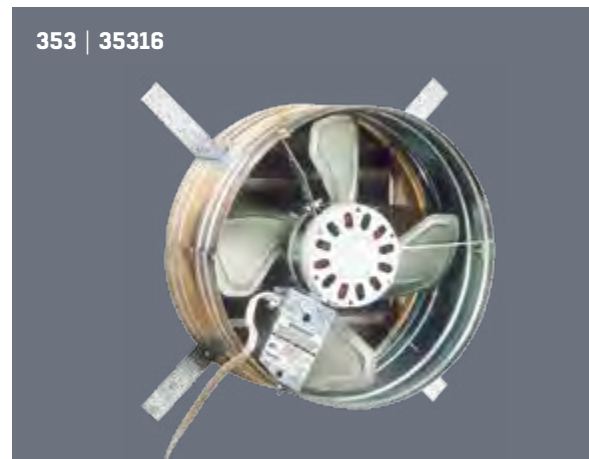

Powered Attic Ventilation Specifications

Model	Attic Sq Ft	AMPS	CFM*	RPM	Height	Diameter	Dome Material	Color
Roof Mount								
349BR	Up to 1400	4	1000	1050	9"	24½"	Painted Steel	Dark Brown
350BR 350BK	Up to 1500	3.6	1050	1000	8"	23¼"	PVC	Brown/Black
355BR 355BK	Up to 1715	4.3	1200	1050	8"	23¼"	PVC	Brown/Black
356BR 356BK	Up to 2285	8.0	1600	1500	8"	23¼"	PVC	Brown/Black
358	Up to 1715	4.3	1200	1050	8"	23¼"	Aluminum	Silver
Gable Mount								
353†	Up to 1460	3.4	1020 / 760**	1030	—	—	—	—
35316†	Up to 2285	3.9	1600 / 1160**	1420	—	—	—	—



DETERMINING THE CFM* REQUIREMENTS FOR YOUR ATTIC

Gable Mount Ventilators

Roof Pitch	8/12 or Less		9/12		12/12		15/12	
	Standard Louver	433 Louver	Standard Louver	433 Louver	Standard Louver	433 Louver	Standard Louver	433 Louver
Light Colored Roof Square Footage								
353	1085	1460	1015	1360	570	765	355	385
35316	1658	2285	1549	2135	870	200	559	770
Dark Colored Roof Square Footage								
353	950	1275	880	1185	500	670	315	425
35316	1442	1985	1347	1855	757	1055	486	670

Numbers in charts are attic square footage that fan can ventilate.

Roof Mount Ventilators

Roof Pitch	CFM	8/12 or Less	9/12	12/12	15/12
Light Colored Roof Square Footage					
349BR	1000	1490	1180	782	501
350BR, 350BK	1050	1500	1399	790	508
355BR, 355BK	1200	1715	1600	900	575
356BR, 356BK	1600	2285	2135	1200	770
358	1200	1715	1600	900	575
Dark Colored Roof Square Footage					
349BR	1000	1290	1200	684	427
350BR, 350BK	1050	1304	1219	694	430
355BR, 355BK	1200	1495	1390	790	505
356BR, 356BK	1600	1985	1855	1055	670
358	1200	1495	1390	790	505

† Model 433 Automatic Shutter Accessory sold separately. See page 46.

*Exhaust capacity HVI certified @ .03" static pressure.

**Higher CFM with Model 433 shutter. Lower CFM with standard wood louvre. The Home Ventilating Institute (HVI) recommends 1 sq. ft. of open air inlet per 300 CFM of fan capacity. The best location for these air intake vents is under the eaves with direct access to the attic. Vents for gable installations should be placed at the end of the house opposite the installed ventilator. Failure to provide these intakes could cause natural-draft gas appliances to backdraft.

VENTILATE YOUR ATTIC WITH THE POWER OF THE SUN.



Surface Mount—345SOBK and 345SOWW

For most roofs, our one piece SPAV is the perfect solution. Because our solar cells are highly efficient at capturing the sun's energy, there is no need for unsightly raised panels or tracking systems. Instead, what you see is a low profile ventilator in a contoured design that integrates well with the roof.

Curb Mount—345CSOBK and 345CSOWW

Identical in design to the Surface Mount unit but with an added lip for flat, tiled, or unusually steep roof installations. A Curb Mount installation requires the fabrication of a simple curb box frame made from treated 2x4s to create a solid platform and better manage water runoff.

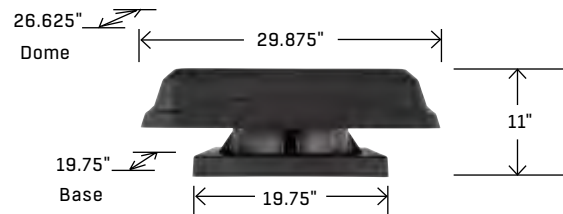
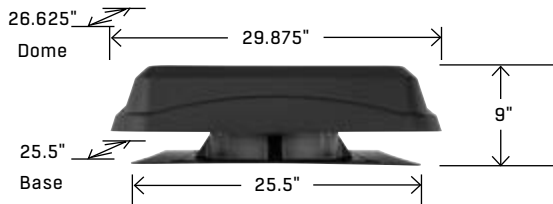

Solar Panel Integrated, low profile, 28 watt Solar Panel efficiently captures sunlight from dawn to dusk without the unsightly props or pivoting stands used by some manufacturers. Rugged, tempered glass withstands large hail and resists delaminating.

Housing Attractive, low profile, molded design, of UV-stabilized, color-dyed, rugged ABS plastic withstands impact from hail and resists fading. May also be painted to match roof color for installation flexibility.

Motor Direct-current, variable speed 17 volt motor is dynamically balanced for superior performance and silent operation.

Fan 12" Diameter, one-piece aluminum 5-blade, fan pitched for maximum air flow.

Hardware Stainless steel fasteners secure galvanized steel brackets and aluminum, heavy gauge screen for durability and corrosion resistance. Screen keeps out insects, animals, and birds without impeding airflow.

Optional Thermostat—Model CWT45 Easy to install, this optional accessory disables the motor below 50° for climates where cold-weather condensation isn't a concern and to extend motor life. The thermostat activates the motor at temperatures above 61° to vent air from dawn through dusk.

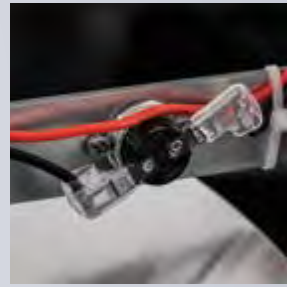

Visit broan.com for more information.

Remote Mount, 345RSOBK and 345RSOWW

In some cases, installing the ventilator in a location that is either less visible, more convenient to reach from the roof-side, or more accessible from the attic-side, is desirable. Remote mount enables the ventilator to be installed independent of the solar panel, up to 50' away (15' of wire included). Locate the remote, flat panel to receive the best sunlight exposure and hide the ventilator from view.

Gable Mount, 345GOBK & 345GOWW

If roof mounting is not possible or desired, gable installation provides the benefits of the SPAV with a remote-mounted, flat solar panel positioned to best capture the sun's energy, up to 50' away (15' of wire included). Finish the outside with a Broan model 433 gable shutter.

345RSOBK (BLACK) | 345RSOWW (WEATHERED WOOD)

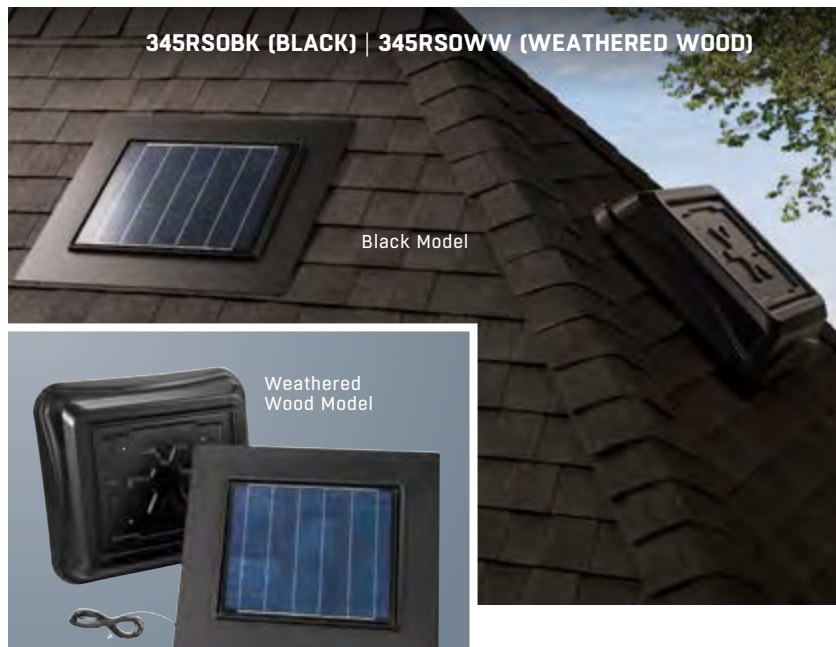

345GOBK (BLACK) | 345GOWW (WEATHERED WOOD)

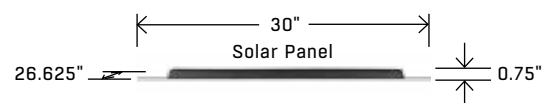
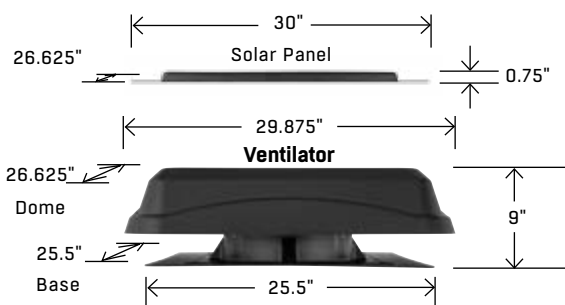

THE PERFECT CONTROL SOLUTION FOR EVERY ROOM AND NEED.



INDICATOR LIGHT CONTROL FOR CONVENIENCE

INDICATOR LIGHT CONTROLS

Model 69W*

- Single-Function Controls
- Ideal for use with quiet models, or Remote In-Line Ventilators
- 120V, 15 amps



Model 269WL, 269VL

- Two-Function Controls
- For use especially with quiet models and an auxiliary light source
- Lighted fan control 120V, 20 amps; unlighted 120/240/277V, 15 amps
- Fits two-gang box
- Controls available in White (W) or Ivory (V)



Model 685WL, 685VL

- Three-Function Controls
- For use especially with quiet models
- Lighted fan control 120V, 20 amps; two additional on/off rocker switches 120V, 15 amps each (20 amps total)
- Fits two-gang box
- Blister packs (P685WL, P685VL)
- Controls available in White (W) or Ivory (V)



THERMOSTAT AND HUMIDITY CONTROLS

Model 82W

- SensAire® technology responds to humidity up to 70% faster than competitive models; setpoint mode satisfies CA requirements
- Continuous ventilation mode helps to meet ASHRAE 62.2
- Compatible with any existing fan within electrical ratings
- Available in white; faceplate not included
- 120V, 4 amp



Model 70TW

- Thermostat for any fan
- 120, 250, 277 VAC,
- 22 amp capacity
- Fits single-gang box only



Model DH100W*

- Dehumidistat
- Dual voltage (24V/120V)
- Variable setting from 20–80% relative humidity
- Usage guide included
- Fits single-gang box only



MULTI-FUNCTION CONTROLS

Model 66W, 66V, 67W

- Three-Function Controls
- Three independent, 120V, 15 amp rocker switches (20 amps total)
- Fits single-gang opening
- Blister packs available (P66W, P66V, P67W)
- Controls available in White (W) or Ivory (V)
- Wall plates available in: White (66W) or Ivory (66V); Polished chrome finish (67W)



Model 68W, 68V

- Two-Function Controls
- Two independent, 120V, 15 amp rocker switches (20 amps total)
- Fits single-gang box
- Blister packs available (P68W, P68V)
- Controls available in White (W) or Ivory (V)



Model 77DW, 77DV

- Four-Function Controls
- Single switch provides three settings for fan sensor (On-Auto-Off) on Sensing models
- Remaining switches for light/night light
- Works with QTX110HL heater/fan/light/night light
- Controls available in White (W) or Ivory (V)
- Fits single-gang opening
- Blister packs available (P77DW)





MULTI-FUNCTION CONTROL TO SUIT EVERY NEED



SPEED CONTROL FOR QUIETER OPERATION OR FULL POWER



HUMIDITY SENSING TO HELP PREVENT FOGGY MIRRORS

SPEED CONTROLS

Model 57W, 57V (3-amp)

- 120V, 3 amps
- Fits single-gang box
- Positive on/off action—dial for variable selection of air speeds and sound levels
- Built-in radio noise suppressor
- Controls available in White (W) or Ivory (V)
- Blister packs available (P57W)



Model 72W, 72V (6-amp)

- 120V, 6 amps—Models 72W, 72V
- Fits single-gang box only
- Positive on/off action—dial for variable selection of air speeds and sound levels
- Built-in radio noise suppressor
- Controls available in White (W) or Ivory (V)



Model 78W, 78V

- 4-speed “no-hum” ceiling fan speed control
- Decorator wall plate
- Screws included
- 120V AC 1.5 amp
- Controls available in White (W) or Ivory (V)



TIMER AND OFF-DELAY CONTROLS

Model 59W, 59V, 71V*

- Model 59W, 59V—up to 60 minutes
- Model 71V—up to 12 hours
- Fits single-gang box
- 120V, 20 amps; 240V, 10 amps
- Operate continuously or for any set period
- Controls available in White (W) or Ivory (V)
- Blister packs available (P59W, P59V)



Model 61W, 61V

- Operate for any set period up to 15 minutes (no “continuous on” position)
- Fits single-gang box
- 120V, 20 amps; 240V, 10 amps
- Controls available in White (W) or Ivory (V)



Model 62W

- 60 Minute
- Two separate 120V, 15 amp on/off rocker switches (20 amps total)
- 120V, 20 amps or 240V, 10 amp timer
- Timer operates continuously or for any set period up to 60 minutes
- Fits two-gang box
- Controls available in White (W)



Model 63W, 63V

- 60 Minute
- Separate 120V, 15 amp on/off rocker switch
- Timer operates continuously or for any set period up to 60 minutes
- Fits two-gang box only
- Controls available in White (W) or Ivory (V)



Model 64W, 64V

- Fan/Light Control with Off-Delay
- Fan and light operate together when control is turned on
- Fan continues to operate for a user adjustable time period 5–60 minutes after light is turned off
- Center position bypasses timer and turns fan and light off immediately
- Fits single-gang box only
- 120V, 4 amps (fan), 4 amps (light)
- Requires hot and neutral wires in the switch box
- Controls available in White (W) or Ivory (V)



*Also for use with Powered Attic Ventilators—see pages 46–47

SELECTION GUIDE

		57W 57V	59W	61W 61V	62W	63W 63V	64W 64V	66W 66V	67W	68W 68V	69W 69V	70TW	71V	72W 72V	73	77DW 77DV	78W 78V	269WL 269VL	685WL	82W, DH100W	
Utility Fans	12C		•	•			•				•	•	•	•			•			•	
	502	•	•	•			•				•	•	•	•			•			•	
	503	•	•	•			•				•	•	•	•			•			•	
	504	•	•	•			•				•	•	•	•			•			•	
	505	•	•	•			•				•	•	•	•			•			•	
	506 & 507																				
	508	•	•	•			•				•	•	•	•			•			•	
	509	•	•	•							•	•		•			•			•	
	509S ¹		•	•			•					•	•				•			•	
	510 ²		•	•			•					•	•				•			•	
	511 ²											•					•				
	512 & 512M	•	•	•								•	•	•	•			•			•
673		•	•			•					•	•	•				•			•	
Ventilation Fans	670	•	•	•			•				•	•	•	•			•			•	
	671	•	•	•			•				•	•	•	•			•			•	
	682	•	•	•			•				•	•	•	•			•			•	
	688	•	•	•			•				•	•	•	•			•			•	
	689	•	•	•			•				•	•	•	•			•			•	
	690	•	•	•			•				•	•	•	•			•			•	
	LP80	•	•	•			•				•	•	•	•			•			•	
	QTXE080 QTXE110, QTXE150		•	•		•	•			•	•	•	•				•	•		•	
	QTXE110S									•	•										
	XB50										•							•		•	
	XB80										•							•		•	
	XB110										•							•		•	
	XB110H									•	•							•		•	
	ZB80									•								•	•	•	
	ZB80M									•	•							•		•	
	ZB110									•								•	•	•	
	ZB110H									•	•							•		•	
	ZB110M									•	•							•		•	
	RB80, RB110		•	•							•										•
	A80HD	•	•	•							•										•
AE50, A80, AE80, AE80B, AE80S, A110, AE110, AE110S	•	•	•							•										•	
Ventilation Fan/Lights	657	•	•	•		•	•			•		•	•	•						•	
	678	•	•	•		•	•			•		•	•	•						•	
	696	•	•	•		•	•			•		•	•	•						•	
	741SN	•	•	•		•	•			•		•	•	•						•	
	744					•				•		•								•	
	744FL					•				•		•								•	
	744LED					•				•		•								•	
	744SFL					•		•	•	•		•								•	
	750	•	•	•	•		•	•	•	•		•	•	•				•	•	•	
	751	•	•	•		•	•			•		•	•	•				•		•	
	754SN	•	•	•		•	•			•		•	•	•				•		•	
	761BN, 761RB, 761WHA	•	•	•		•	•			•		•	•	•						•	
	791LEDM	•	•				•			•		•							•		
	RB80L, RB110L					•	•			•									•	•	
	AE80L, AE80BL, AE80SL, AE110L, AE110SL	•				•	•			•									•		•
	A50L, A70L, A80L A110L	•				•	•			•									•		•

¹Built-in on/off switch. ²Built-in on/off variable switch

		57W 57V	59W	61W 61V	62W	63W 63V	64W 64V	66W 66V	67W	68W 68V	69WL 69VL	70TW	71V	72W 72V	73	77DW 77DV	78W 78V	269WL 269VL	685WL	82W, DH100W	
Ventilation Fan/Lights Continued	HD80L	•	•	•		•	•			•		•	•	•					•	•	
	QTXE080FLT, QTXE110FLT, QTXE150FLT		•	•	•	•	•	•				•	•							•	•
	XB50L							•	•											•	•
	XB80L							•	•											•	•
	XB110L							•	•											•	•
	XB110HL							•	•								•				•
	ZB80L																	•			•
	ZB80ML																	•			•
	ZB110L																	•			•
	ZB110HL							•	•									•			•
	ZB110ML																	•			•
Heater/Fan/ Lights	100HL	•	•	•	•			•	•			•	•	•							•
	100HFL	•	•	•	•			•	•			•	•	•							•
	161		•	•			•				•										•
	162	•	•	•		•	•			•		•	•	•					•		•
	163		•	•		•					•										•
	164	•	•	•	•	•		•	•	•		•	•	•					•	•	•
	655	•	•	•	•			•	•			•	•	•					•	•	•
	656		•	•		•						•	•								•
	658	•	•	•		•				•		•	•	•					•		•
	659	•	•	•	•			•	•			•	•	•					•	•	•
	QTX110HL		•	•	•			•	•			•	•				•				•
	QTX110HFL		•	•	•			•	•			•	•				•				•
In-Line	MP100, MP140 MP200	•	•	•							•	•	•	•							•
	MP280	•	•	•							•	•	•	•							•
	SP100, SP140, SP200	•	•	•							•	•	•	•							•
Attic Ventilation	349BR		•	•							•	•	•	•	•						•
	350BK		•	•							•	•	•	•	•						•
	350BR		•	•							•	•	•	•	•						•
	353		•	•							•	•	•	•	•						•
	35316		•	•							•	•	•	•	•						•
	355BK		•	•							•	•	•	•	•						•
	355BR		•	•							•	•	•	•	•						•
	356BK		•	•							•	•	•		•						•
	356BR		•	•							•	•	•		•						•
	358		•	•							•	•	•	•	•						•

¹Built-in on/off switch. ²Built-in on/off variable switch

ADAPTERS

Model FY6

- 6" x 6" x 6" Y adapter

Model FY86

- 8" x 6" x 6" Y adapter

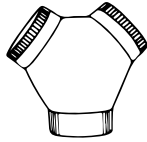

DAMPERS

Model 97 Damper

- 7" spring-loaded, in-line damper

Model BP87 Damper

- 7" vertical discharge damper

DUCTING

Model 406 Round Duct

- 6" round duct
- 2' galvanized section

Model 407 Round Duct

- 7" round duct
- 2' galvanized section

Model 410 Round Duct

- 10" round duct
- 2' galvanized section

Model 889 Duct

- 3 3/4" x 10" duct
- 2' galvanized sections

Models DT4C & DT6C Non-Insulated Flexible Duct

- 4" (DT4C) or 6" (DT6C) round
- DT4C is a 4-pack
- 25' standard length

Models DT4W, DT6W & 804DU Insulated Flexible Duct

- 4" (DT4W & 804DU) or 6" (DT6W) round
- 25' standard length

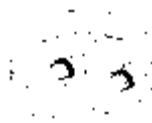
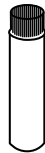

DUCTING KITS

Model RVK1A*

Flexible Roof Ducting Kit

- Includes Model 636 Roof Cap
- 4" diameter metal duct connector
- 2 duct clamps
- 4" to 3" reducer
- 8' of 4" flexible aluminum ducting



Model WVK2A*

Flexible Wall Ducting Kit

- Includes white polymeric wall cap
- 4" diameter metal duct connector
- 2 duct clamps
- 4" to 3" reducer
- 5' of 4" flexible aluminum ducting



ELBOWS

Model 415 Adjustable Elbow

- Fits 7" round duct



Model 418 Adjustable Elbow

- Fits 10" round duct

Model 419 Adjustable Elbow

- Fits 6" round duct

Model 428 Vertical Elbow

- Fits 3 3/4" x 10" duct



Model 429 Horizontal Elbow

- Fits 3 3/4" x 10" duct



Model 430 Short Eave Elbow

- For 3 3/4" x 10" duct
- Includes backdraft damper and grille (black)
- Only recommended for fans with more than 160 CFM



Model 431 Long Eave Elbow

- For 3 3/4" x 10" duct
- Includes backdraft damper and grille (black)
- Only recommended for fans with more than 160 CFM

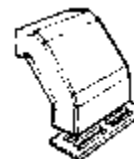

Model 839 Elbow

- 90° turn
- For use with 3 3/4" x 10" duct

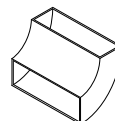

FILTERS

Model 834 Filter

- For 8" fans

Model 854 Filter

- Aluminum mesh grease filter
- For 10" fans

Model 99010042 Aluminum Filter

- Fits Utility Ventilator Models 503, 503MG, 505, 505MG, 509, 509MG, 509S and 509SMG



Model 99010271 Aluminum Filter

- Fits Utility Ventilator Models 12C, 12CMG, 502, 502MG, 504, 504MG, 508, 508MG, 510, 510MG, 511 and 511MG

METAL GRILLE KIT

Model 97011308

- Steel baked white enamel finish
- Fits fan Models 670, 671, 676, 684, 688 and 689
- Grille size is 10 3/4" square

ROOF CAPS

Model 437* 10" Round

- High-capacity design up to 1200 CFM
- Backdraft damper and built-in bird screen
- Steel housing, black electrically bonded epoxy finish



Model 611 Roof Cap*

- For flat roof installation
- Aluminum natural finish
- For up to 8" round duct



Model 611CM Roof Cap*

- For curb mount installation
- Other features same as Model 611

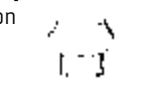

Model 612 Roof Cap*

- For flat roof installation
- Aluminum natural finish
- For up to 12" round duct



Model 612CM Roof Cap*

- For curb mount installation
- Other features same as Model 612

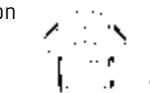

Model 634 Roof Cap*

- For 3 3/4" x 10" or up to 8" round duct
- Black
- Backdraft damper and birdscreen



ROOF CAPS CONTINUED

Model 634M Roof Cap*

- Same as Model 634 except for 6" round duct

Model 636 Roof Cap*

- For 3" or 4" round duct
- Built-in backdraft damper and bird screen
- Steel baked black enamel finish



Model 636AL Roof Cap*

- Same as Model 636, except aluminum natural finish

Model 644 Roof Cap*

- Same as Model 634, except for aluminum natural finish

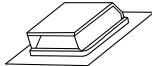

SLEEVES

Model CVLD4

- 4" sleeve with damper

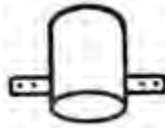

Model CVLD6

- 6" sleeve with damper

TRANSITIONS

Model 886 Transition

- Converts 7" round to 3 3/4" x 10" duct

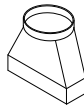

Model 475 Transition

- Converts 6" round duct to 4" round duct reducer
- Available in 6 Pack (475B)

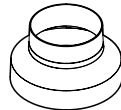

Model 413 Transition

- Converts 3 3/4" x 10" duct to 8" round duct



WALL CAPS

Model 613 Wall Cap*

- For 12" round duct
- Built-in backdraft damper and bird screen
- Aluminum natural finish



Model 639 Wall Cap*

- For 3 3/4" x 10" duct
- Spring-loaded backdraft damper
- Built-in bird screen
- Steel baked black enamel finish



Model 649 Wall Cap*

- Same as Model 639, except aluminum natural finish

Model 641 Wall Cap*

- For 6" round duct
- Built-in backdraft damper and bird screen
- Aluminum natural finish
- Model 647 for 7" Round duct



Model 647 Wall Cap*

- For 7" round duct
- Other features same as Model 641



Model 649 Wall Cap*

- Same as Model 639, except aluminum natural finish



Model 843BL Wall Cap*

- For 6" round duct
- Built-in backdraft damper and bird screen
- Black finish

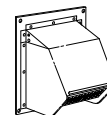

WALL CAPS CONTINUED

Models 885AL and 885BL Wall Cap*

- For 3" or 4" round duct
- 4" to 3" transition included
- Aluminum natural finish (885AL) and steel black enamel finish (885BL)
- Standard package—6 to a carton
- Built-in bird screen and damper

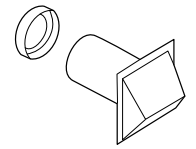

Model 642

- For 4" round duct
- Aluminum natural finish
- 4 to a carton

Model 643 Wall Cap*

- For 8" round duct
- Aluminum natural finish
- Backdraft damper, no birdscreen



Model 646 Louvered Wall* Cap for 6" Round Duct

- Single pack
- White polymeric

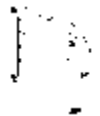

Model WC650 Wall Cap*

- For 4" round duct
- White polymeric
- 4 to a carton



TECHNICAL

What is a sone, and how is it measured? A sone is a measurement of sound of how sound is sensed. The lower the sone value, the quieter the listening environment. One sone is the equivalent of a quiet refrigerator. Broan fans feature the quietest rating possible at <0.3 sones as tested for HVI certification.

What does “HVI certified” mean? The Home Ventilating Institute (HVI) is an independent organization that certifies the airflow and sound performance of Broan products. For more information visit www.hvi.org.

What is ENERGY STAR®? Refer to the product matrix for specific Broan fans that meet ENERGY STAR® requirements. Many of these Broan products use high efficiency motors and lighting to reduce energy consumption by as much as 70%. Learn more about ENERGY STAR® at www.energystar.gov.

What does CFM mean? Cubic Feet per Minute (CFM) is the measure of air volume moved by the fan blower. Choose a fan with a CFM rating appropriate for your room size to ensure adequate ventilation.

What does “static pressure” mean? Static pressure is the measurement of airflow resistance as it is pushed through ductwork which reduces the effectiveness of the fan. Learn more on the Home Ventilating Institute website www.hvi.org.

What is whole-house ventilation? Whole-house ventilation provides today’s airtight homes with a relatively constant and controlled lower level of ventilation. Broan offers many virtually silent continuous ventilation solutions for ASHRAE 62.2 and programs such as LEED, ENERGY STAR® for Homes and CA Title 24.

OPERATION

How do I size a fan properly for my room size and the duct run? See the sizing guidelines on page 59 for details on proper sizing. This section provides an explanation and examples to help you make the right decision.

How long should a bath fan run after a shower is used? The Home Ventilating Institute recommends that a fan should be left on for 20 minutes more to clear humidity adequately and to ensure moisture and condensation is minimized.

How does Sensing Technology operate? Broan has unique sensing technology that detects humidity or motion. Multi-speed models automatically turn the fan speed up when someone enters the room or there is a rapid rise in the humidity level from the lower continuous CFM level. Single-speed models turn the fan on automatically.

How does the delay-off timer operate? Delay-off timers automatically shut the fan off after a time interval set by the user.

Why do the windows and mirrors fog even when the fan is running? If windows and mirrors are very cold, condensation can still form on these surfaces. And if your bathroom is sealed tightly, replacement air may not be entering the room fast enough to displace the moist air. Fan placement can also be a factor. Your fan should be located far from the replacement air source to ensure the moist air is drawn out first. Finally, make sure your ductwork is as short and straight as it can be in order to ensure proper air outflow.

Why is water dripping from the grille of the fan? Dripping water is either condensation (usually due to cold ductwork or improper duct installation), or a problem with the seal on a wall or roof vent. Insulated ductwork can help solve condensation problems, and running the fan longer will ensure moisture is completely removed from the duct.

Will Broan fans work in wall-mount applications? Refer to the product matrix for specific Broan bath and utility fans that may be wall mounted.

What type of exhaust fan is best for a sauna or hot tub area? High CFM-rated devices are normally recommended for this type of application.

Can I use a fan in a steam shower? No. Since these are normally sealed chambers, a vacuum will be created.

INSTALLATION

Can I mount Broan fans above my tub and shower? Most Broan fans are rated for use over a shower or bathtub with a GFCI (Ground Fault Circuit Interrupter).

Can my bath fan be surrounded by insulation? Yes. Broan bath fans are designed to provide adequate cooling for motors and lighting, as well as products with integral heaters.

Can I vent more than one bath fan out of a roof or wall cap? No. Always follow the manufacturer's recommended ventilation requirements.

What is the Broan Ventilation fan warranty? Go to <http://www.broan.com/warranty> for this information.

Do I need attic access to install a fan in a retrofit situation? Refer to the product matrix for specific Broan fans that may be installed without access from above with features such as telescoping mounting frames, snap-in housings, bendable mounting ears, drywall-mounting tabs and inside-out mounting duct connectors. Room-side retrofit installations are now a reality.

Can I install a heater over the bathtub or in a shower?

No. Heaters are not UL Listed (Underwriter's Laboratory) for installation over a bathtub or in a shower.

Can I use an inline or multi-port fan in one large bathroom? Yes, this works the best for large rooms because you can install the ports over the areas where the ventilation is needed the most (source control). The size of the multi-port would be determined by the size of the room.

Can larger diameter ducting be used with my bath fan? Yes, larger diameters will result in improved performance.

Can I use a smaller diameter duct than what the fan is designed for? This is not recommended. It will cause the fan to run harder, greatly reducing the CFM performance of the fan and create excess noise.

What type of duct is recommended, rigid or flexible? It is recommended, where possible, to use rigid duct. It has less resistance to air flow and allows the fan to operate much more efficiently. If flexible duct is used, be sure the duct is as straight as possible.

Can I exhaust my fan into my attic instead of out the roof or wall? Never exhaust air into spaces within walls, ceilings, attics, crawl spaces or garages. Humidity may damage the structure and insulation.

Where should the exhaust fan be located? Exhaust fans should be located in or near the shower or tub, and in an enclosed water closet. Keep exhaust points opposite the supply air source to ensure that the fresh air is drawn through the room. Bathroom doors should not be sealed too tightly at the bottom in order to allow "makeup air" to enter the room when the door is closed.

In what direction should I orient the exhaust outlet? The exhaust outlet is the point where air is discharged through the body of the fan housing into the ductwork. During installation, orient your fan with the exhaust outlet pointing toward the exit vent on your roof or wall to minimize turns in ductwork that impede airflow.

Will a bath fan or wall-mount utility fan serve as a range hood? No. Range hoods are specifically designed to handle grease and high temperature environments. Broan bath fans supplement odor and moisture removal in the kitchen, but are not intended for use as a range hood.

Can I use CFL or LED bulbs in fan/lights with A19 screw-base sockets? Yes, if key guidelines are followed. Go to broan.com FAQs for details.

PROPER INSTALLATION MAKES ALL THE DIFFERENCE.

Tape or caulk around the seam where the fan housing meets the sheetrock on the ceiling

If possible, use smooth, rigid ductwork as large as the exit opening on the body of the fan housing

Whenever possible, ductwork should slope down and away from the fan housing to direct any condensation toward the vent

Whether rigid or flexduct, the turning radius for the duct should be as large as possible

Pre-installed screws, keyhole slots and alignment tabs facilitate installation, taking the guesswork out of proper mounting.

Elbows, turns, long ducts and ductwork smaller than the fan's exit outlet will reduce performance.

Use wide aluminum foil or duct tape to join smooth metal ductwork seams.

Do not let flexible ductwork sag as this impedes airflow.

During installation, orient the bath fan outlet in the direction of the home's exit point to minimize duct turns.

Before adding an elbow or bend, allow 24" to 36" of straight run from the fan outlet point.

Duct-wrap insulation (R-5 or above) will help minimize condensation in cold climates, especially on long duct runs.

Quick guideline: For bathrooms up to 100 square feet, the HVI recommends ventilation of at least 1 CFM per square foot (about eight air changes per hour). For bathrooms over 100 square feet, add up the needs of each fixture to determine the total ventilation rate:

- Toilet 50 CFM
- Shower 50 CFM
- Bathtub 50 CFM
- Jetted tub 100 CFM

Exit vents should have backdraft flaps to help keep cold air from entering the duct

EASY STEPS FOR CHOOSING AND SIZING THE RIGHT VENTILATION FAN FOR YOUR HOME.

Determine which rooms could use ventilation, and how much is needed. **Spot ventilation** is used in localized areas to remove moisture, odor and airborne pollutants quickly. Most commonly used in the bath or powder room, spot ventilation can also be used in a laundry room, exercise area, closet, or bedroom, wherever air should be changed frequently. Decorative and recessed models can be ideal solutions for these situations. According to the Home Ventilating Institute (HVI), Air Changes per Hour (ACH) for comfortable and healthy living should be as follows: Bathrooms: 8 changes, Kitchens: 15 changes, Living/Bedrooms: 6 changes. Broan bath fans, utility fans and high capacity fans can meet these needs.

Calculate the air movement necessary for proper ventilation. Air movement is measured in Cubic Feet per Minute (CFM). To determine CFM requirements, first determine the size of your room. Measure and multiply the length, width and ceiling height of your room to determine cubic footage. Then use the multiplication factor of .13 and round up to the next "ten." See the three examples that follow.

Example 1:

Bathroom with 8' ceiling:
7' wide x 9' long x 8' high x .13 = 66. Select a bath fan with at least 70 CFM

Example 2:

Bathroom with 9' ceiling: 10' wide x 9' long x 9' high x .13 = 105. Select a bath fan with at least 110 CFM

Example 3:

For a bathroom with a vaulted ceiling, use the average ceiling height at the wall and the peak: 8' wide x 12' long x ((8' at wall + 12' at peak) / 2 = 10') average height x .13 = 125. Select a fan(s) with at least 130 CFM

Account for long duct runs and ductwork that turns before it reaches the exterior vent. When airflow is restricted in any way it slows down. Just as a car must slow down for a sharp corner, air decelerates when going through a turn in a duct run. Whenever possible, create a straight duct run with large radius turns, if they're necessary at all. Rigid ductwork is optimal because airflow restriction is minimized. Flexible tubing may be convenient to install, but resistance is created as air is moved over the spiral metal frame of the tubing. With long duct runs or ducts with multiple turns the fan works harder, noise increases and fan performance (CFM) is compromised. Select a fan model with an even greater CFM rating to compensate.

6" ducting overcomes most performance-related installation issues. Broan's ULTRA and QTX Green Series fans deliver high performance in virtually any real-world installation. They are engineered with a 6" duct connector for peak air movement and extremely quiet operation, even when the duct run is not short and straight.

INVENT Fans and Fan/Lights

Model	Page	CFM	Sones, HVI-Certified	Baths up to () Sq Ft	Lighting Watts Main/ Night Light	ENERGY STAR®	Fluorescent Lighting	Duct Size"	Housing Dims			Grille Dims		Grille Finish	Amps
								L"	W"	H"	L"	W"			
AE80	26	80	0.8	75	—	Yes	—	4	9 ³ / ₄	10	5 ³ / ₄	11 ³ / ₈	12	White Polymeric	0.3
AE110	26	110	1.3	105	—	Yes	—	4	9 ³ / ₄	10	5 ³ / ₄	11 ³ / ₈	12	White Polymeric	0.3
AE80B	26	80	1.5	75	—	Yes	—	4	9 ³ / ₄	10	5 ³ / ₄	11 ³ / ₈	12	White Polymeric	0.3
AE50	26	50	0.5	45	—	Yes	—	4	9 ³ / ₄	10	5 ³ / ₄	11 ³ / ₈	12	White Polymeric	0.2
A80HD*	26	80	2.0	75	—	No	—	4	9 ³ / ₄	10	5 ³ / ₄	11	12	White Painted Metal	0.37
A80	26	80	2.0	75	—	No	—	4	9 ³ / ₄	10	5 ³ / ₄	11 ³ / ₈	12	White Polymeric	0.37
AE80S	20	80	0.8	75	—	Yes	—	4	9 ³ / ₄	10	5 ³ / ₄	11 ³ / ₈	12	White Polymeric	0.3
A110	26	110	3.0	105	—	No	—	4	9 ³ / ₄	10	5 ³ / ₄	11 ³ / ₈	12	White Polymeric	0.4
AE110S	20	110	1.0	100	—	Yes	—	4	9 ³ / ₄	10	5 ³ / ₄	11 ³ / ₈	12	White Polymeric	0.3
A80L**	26	80	1.0	75	A19 Base	No	—	4	9 ³ / ₄	10	5 ³ / ₄	11 ¹ / ₂	12 ¹ / ₈	White Polymeric	1.2
A110L**	26	110	1.3	105	A19 Base	No	—	4	9 ³ / ₄	10	5 ³ / ₄	11 ¹ / ₂	12 ¹ / ₈	White Polymeric	1.2
A50L**	26	50	1.5	45	A19 Base	No	—	4	9 ³ / ₄	10	5 ³ / ₄	11 ¹ / ₂	12 ¹ / ₈	White Polymeric	1.0
A70L**	26	70	2.0	65	A19 Base	No	—	4	9 ³ / ₄	10	5 ³ / ₄	11 ¹ / ₂	12 ¹ / ₈	White Polymeric	1.2
AE80BL	26	80	1.5	75	11W LED	Yes	LED	4	9 ³ / ₄	10	5 ³ / ₄	11 ³ / ₄	12 ¹ / ₂	White Polymeric	0.3
AE80L	26	80	0.8	75	11W LED	Yes	LED	4	9 ³ / ₄	10	5 ³ / ₄	11 ³ / ₄	12 ¹ / ₂	White Polymeric	0.3
AE80SL	20	80	0.8	75	11W LED	Yes	LED	4	9 ³ / ₄	10	5 ³ / ₄	11 ³ / ₄	12 ¹ / ₂	White Polymeric	1.2
AE110L	26	110	1.3	105	11W LED	Yes	LED	4	9 ³ / ₄	10	5 ³ / ₄	11 ³ / ₄	12 ¹ / ₂	White Polymeric	0.3
AE110SL	20	110	1.0	100	11W LED	Yes	LED	4	9 ³ / ₄	10	5 ³ / ₄	11 ³ / ₄	12 ¹ / ₂	White Polymeric	1.2

*Metal grille. **Bulb not included.

Fans

Model	Page	CFM	Sones, HVI-Certified	Baths up to () Sq Ft	ENERGY STAR®	Duct Size"	L"	W"	H"	Grille Dims		Grille Finish	Amps
										L"	W"		
670	30	50	3.5	45	—	3	7 ¹ / ₄	7 ¹ / ₂	3 ⁵ / ₈	9	9 ³ / ₄	White Polymeric	0.8
671	30	70	6.0	65	—	3	7 ¹ / ₄	7 ¹ / ₂	3 ⁵ / ₈	9	9 ³ / ₄	White Polymeric	1.2
682	31	—	—	—	—	Duct-free	7 ¹ / ₈	7 ¹ / ₈	3 ³ / ₄	8 ¹ / ₂	8 ¹ / ₂	White Polymeric	1.0
688	30	50	4.0	45	—	3	7 ¹ / ₄	7 ¹ / ₂	3 ⁵ / ₈	9	9 ³ / ₄	White Polymeric	0.9
689	30	60	5.5	55	—	3	7 ¹ / ₄	7 ¹ / ₂	3 ⁵ / ₈	9	9 ³ / ₄	White Polymeric	1.5
690**	31	60	3.0	55	—	—	—	—	—	9 ⁵ / ₈	11 ¹ / ₈	White Polymeric	1.5
LP80	29	80	1.0	75	Yes	4 / 3	11 ³ / ₈	10 ¹ / ₂	4	13	13 ³ / ₄	White Polymeric	0.3
SPK110	37	110	1.0	75	Yes	4	11 ³ / ₈	10 ¹ / ₂	7 ³ / ₄	13	14	White Polymeric	0.9
SSQTXE080	23	80	—	—	Yes	—	11 ³ / ₈	10 ¹ / ₂	7 ³ / ₄	—	—	—	—
SSQTXE110	23	110	—	—	Yes	—	11 ³ / ₈	10 ¹ / ₂	7 ³ / ₄	—	—	—	—
QTXE080	18	80	0.3	75	Yes	6	11 ³ / ₈	10 ¹ / ₂	7 ⁵ / ₈	13	14	White Polymeric	0.4
QTXE110	18	110	0.7	100	Yes	6	11 ³ / ₈	10 ¹ / ₂	7 ⁵ / ₈	13	14	White Polymeric	0.3
QTXE110S	20	110	0.7	100	Yes	6	11 ³ / ₈	10 ¹ / ₂	7 ⁵ / ₈	12 ⁷ / ₈	13 ³ / ₄	White Polymeric	0.3
QTXE150	18	150	1.4	140	Yes	6	11 ³ / ₈	10 ¹ / ₂	7 ⁵ / ₈	13	14	White Polymeric	0.5
RB80	15	80	<0.3	75	Yes	4	11 ³ / ₈	10 ¹ / ₂	7 ⁵ / ₈	13	13 ³ / ₄	White Polymeric	0.3
RB110	15	110	0.6	100	Yes	4	11 ³ / ₈	10 ¹ / ₂	7 ⁵ / ₈	13	13 ³ / ₄	White Polymeric	0.3
XB50	13	50	<0.3	45	Yes	6 / 4	10 ¹ / ₂	11 ³ / ₈	7 ⁵ / ₈	13	13 ³ / ₄	White Polymeric	0.1
XB80	13	80	<0.3*	75	Yes	6 / 4	10 ¹ / ₂	11 ³ / ₈	7 ⁵ / ₈	13	13 ³ / ₄	White Polymeric	0.1
XB110	13	110	<0.3	100	Yes	6	10 ¹ / ₂	11 ³ / ₈	7 ⁵ / ₈	13	13 ³ / ₄	White Polymeric	0.2
XB110H	13	110	<0.3	100	Yes	6	10 ¹ / ₂	11 ³ / ₈	7 ⁵ / ₈	13 ¹ / ₈	14	White Polymeric	0.2
ZB80	13	80	<0.3*	75	Yes	6 / 4	10 ¹ / ₂	11 ³ / ₈	7 ⁵ / ₈	13	13 ³ / ₄	White Polymeric	0.1
ZB80M	13	80	<0.3*	75	Yes	6 / 4	10 ¹ / ₂	11 ³ / ₈	7 ⁵ / ₈	13 ¹ / ₈	14	White Polymeric	0.1
ZB110	13	110	<0.3	100	Yes	6	10 ¹ / ₂	11 ³ / ₈	7 ⁵ / ₈	13	13 ³ / ₄	White Polymeric	0.2
ZB110H	13	110	<0.3	100	Yes	6	10 ¹ / ₂	11 ³ / ₈	7 ⁵ / ₈	13 ¹ / ₈	14	White Polymeric	0.2
ZB110M	13	110	<0.3	100	Yes	6	10 ¹ / ₂	11 ³ / ₈	7 ⁵ / ₈	13 ¹ / ₈	14	White Polymeric	0.2

Radiation Dampers can be found on page 11, 19, 22, 27, 29 and 72

*With 6" duct (with 4" duct 0.3)

**Replacement grille and motor kit

Fan/Lights

Model	Page	CFM	Sones, HVI-Certified	Baths up to () Sq Ft	Lighting Watts Main/ Night Light	ENERGY STAR®	Fluorescent Lighting	Duct Size"	Housing Dims			Grille Dims		Grille Finish	Amps
									L"	W"	H"	L"	W"		
657	30	70	4.0	65	100	—	—	4	14 ¹ / ₄	8 ³ / ₄	5 ³ / ₄	16 ³ / ₄	10 ⁵ / ₈	White Polymeric	2.0
678	30	50	2.5	45	100	—	—	4	8 ³ / ₄	8	5 ³ / ₄	11 ¹ / ₈	10 ⁵ / ₈	White Polymeric	1.6
696	30	100	4.5	90	100	—	—	4	14 ¹ / ₄	8 ³ / ₄	5 ³ / ₄	16 ³ / ₄	10 ⁵ / ₈	White Polymeric	2.0
741SN	35	70	3.5	65	120 (2-60W)	—	—	4	8 ³ / ₄	8	5 ³ / ₄	13 ³ / ₈ Dia	—	Satin Nickel	2.2
754SN	35	70	3.5	65	120 (2-60W)	—	—	4	8 ³ / ₄	8	5 ³ / ₄	13 ³ / ₈ Dia	—	Nickel	2.2
761BN	35	80	2.5	75	120 (2-60W)	—	—	4	8 ³ / ₄	8	5 ³ / ₄	13 ³ / ₈ Dia	—	Brushed Nickel	1.6
761RB	35	80	2.5	75	120 (2-60W)	—	—	4	8 ³ / ₄	8	5 ³ / ₄	13 ³ / ₈ Dia	—	Oil-rubbed Bronze	1.6
761WHA	35	80	2.5	75	120 (2-60W)	—	—	4	8 ³ / ₄	8	5 ³ / ₄	13 ³ / ₈ Dia	—	White	1.6
744	34	70	1.5	65	75	—	—	4	8 ³ / ₄	12 ³ / ₄	6 ³ / ₄	7 ³ / ₈ Dia	—	Matte White	1.2
744FL	34	70	1.5	65	14	Yes	Yes	4	8 ³ / ₄	12 ³ / ₄	6 ³ / ₄	7 ³ / ₈ Dia	—	Matte White	0.7
744LED	34	70	1.5	65	10W LED	Yes	—	4	8 ³ / ₄	12 ³ / ₄	6 ³ / ₄	7 ³ / ₈ Dia	—	Matte White	0.55
744SFL	34	70	1.5	65	14	Yes	Yes	4	8 ³ / ₄	12 ³ / ₄	6 ³ / ₄	7 ³ / ₈ Dia	—	Matte White	0.7
750	30	100	3.5	90	100 / 7	—	—	4	9	9	6	15 Dia	—	White Polymeric	1.9
751	30	100	3.5	90	100	—	—	4	9	9	6	15 Dia	—	White Polymeric	1.9
791LEDM	35	100	1.5	100	9W LED	Yes	LED	4	9 ¹ / ₄	10	5 ³ / ₄	12 ⁵ / ₈	12 ⁵ / ₈	White	0.5
HD80L	30	80	2.5	75	100	—	—	4	8 ³ / ₄	8	5 ³ / ₄	11 ¹ / ₈	10 ⁵ / ₈	White Polymeric	1.6
QTXE080FLT	18	80	0.3	75	2- 18W fluor/4	Yes	Yes	6	11 ³ / ₈	10 ¹ / ₂	7 ³ / ₈	13 ³ / ₈	14 ¹ / ₄	White Polymeric	1.0
QTXE150FLT	18	150	1.4	140	2- 18W fluor/4	Yes	Yes	6	11 ³ / ₈	10 ¹ / ₂	7 ³ / ₈	13 ³ / ₈	14 ¹ / ₄	White Polymeric	1.2
RB80L	15	80	<0.3	75	2- 18W fluor/4	Yes	Yes	4	11 ³ / ₈	10 ¹ / ₂	7 ³ / ₈	13	13 ³ / ₄	White Polymeric	1.0
RB110L	15	110	0.8	100	2- 18W fluor/4	Yes	Yes	4	11 ³ / ₈	10 ¹ / ₂	7 ³ / ₈	13	13 ³ / ₄	White Polymeric	1.0
XB50L	13	50	<0.3	45	2- 18W fluor/4	Yes	Yes	6 / 4	10 ¹ / ₂	11 ³ / ₈	7 ³ / ₈	13	13 ³ / ₄	White Polymeric	0.7
XB80L	13	80	<0.3*	75	2- 18W fluor/4	Yes	Yes	6 / 4	10 ¹ / ₂	11 ³ / ₈	7 ³ / ₈	13	13 ³ / ₄	White Polymeric	0.7
XB110L	13	110	<0.3	100	2- 18W fluor/4	Yes	Yes	6	10 ¹ / ₂	11 ³ / ₈	7 ³ / ₈	13	13 ³ / ₄	White Polymeric	0.9
XB110HL	13	110	<0.3	100	2- 18W fluor/4	Yes	Yes	6	10 ¹ / ₂	11 ³ / ₈	7 ³ / ₈	13 ³ / ₈	14	White Polymeric	0.9
ZB80L	13	80	<0.3*	75	2- 18W fluor/4	Yes	Yes	6 / 4	10 ¹ / ₂	11 ³ / ₈	7 ³ / ₈	13	13 ³ / ₄	White Polymeric	0.8
ZB80ML	13	80	<0.3*	75	2- 18W fluor/4	Yes	Yes	6 / 4	10 ¹ / ₂	11 ³ / ₈	7 ³ / ₈	13 ³ / ₈	14	White Polymeric	0.8
ZB110L	13	110	<0.3	100	2- 18W fluor/4	Yes	Yes	6	10 ¹ / ₂	11 ³ / ₈	7 ³ / ₈	13	13 ³ / ₄	White Polymeric	0.9
ZB110HL	13	110	<0.3	100	2- 18W fluor/4	Yes	Yes	6	10 ¹ / ₂	11 ³ / ₈	7 ³ / ₈	13 ³ / ₈	14	White Polymeric	0.9
ZB110ML	13	110	<0.3	100	2- 18W fluor/4	Yes	Yes	6	10 ¹ / ₂	11 ³ / ₈	7 ³ / ₈	13 ³ / ₈	14	White Polymeric	0.9

*With 6" duct (with 4" duct 0.3)

Heater/Fan/Lights

Model	Page	CFM	Sones, HVI-Certified	Lighting Watts Main/ Night Light	Housing Dimensions			Grille Dimensions		Grille Finish	Duct Size"	Amps	Total Connected		
					L"	W"	H"	L"	W"				Load In Watts	Heater Wattage	BTU
100HL	44	100	2.0	100W	16	10 ¹ / ₄	5 ⁷ / ₈	17 ¹ / ₂	11 ¹ / ₂	White Polymeric	4	14.5	1830	1500	5120
100HFL	44	100	2.0	27W Fluor. (Incl.)	16	10 ¹ / ₄	5 ⁷ / ₈	17 ¹ / ₂	11 ¹ / ₂	White Polymeric	4	14.0	1760	1500	5120
162*	45	70	4.0	*250W (1)	8 ¹ / ₈	8 ³ / ₈	6 ³ / ₈	10 ¹ / ₄	10 ¹ / ₄	White Polymeric	4	2.5	300	250*	853
164*	45	70	4.0	*250W (2)	14 ¹ / ₄	8 ³ / ₈	6 ³ / ₈	15 ⁵ / ₈	10 ¹ / ₄	White Polymeric	4	4.5	545	500*	1707
655	44	70	4.0	100W	14 ¹ / ₄	8 ³ / ₄	5 ³ / ₄	16 ³ / ₄	10 ⁵ / ₈	White Polymeric	4	12.8	1536	1300	4437
656	44	—	—	100W	14 ¹ / ₄	8 ³ / ₄	5 ³ / ₄	16 ³ / ₄	10 ⁵ / ₈	White Polymeric	—	11.9	1428	1300	4437
658	44	70	4.0	n/a	14 ¹ / ₄	8 ³ / ₄	5 ³ / ₄	16 ³ / ₄	10 ⁵ / ₈	White Polymeric	4	11.9	1428	1300	4437
659	44	50	2.5	100W	14 ¹ / ₄	8 ³ / ₄	5 ³ / ₄	16 ³ / ₄	10 ⁵ / ₈	White Polymeric	4	12.0	1440	1300	4437
QTX110HL	43	110	0.9	120W/7W	17 ⁵ / ₈	11 ³ / ₈	7 ⁵ / ₈	20	15	White Polymeric	6	14.6	1710	1500	5120
QTX110HFLT	43	110	0.9	36W Fluor. (GU24 Incl.)/7W	17 ⁵ / ₈	11 ³ / ₈	7 ⁵ / ₈	20	15	White Polymeric	6	13.9	1626	1500	5120

*Ventilation Fan/Bulb Heater versions

Bulb Heater (no fan)

Model	Page	CFM	Sones, HVI-Certified	Lighting Watts Main/ Night Light	Housing Dimensions			Grille Dimensions		Grille Finish	Duct Size"	Total Connected			
					L"	W"	H"	L"	W"			Amps	Load In Watts	Heater Wattage	BTU
161	45			n/a	8 ¹ / ₈	8 ³ / ₈	6 ³ / ₈	10 ¹ / ₄	10 ¹ / ₄	White Polymeric		2.1		250	853
163	45			n/a	8 ¹ / ₈	14 ¹ / ₄	6 ³ / ₈	15 ⁵ / ₈	10 ¹ / ₄	White Polymeric		4.3		500	1707

See models 162 and 164 above for Ventilation Fan/Bulb Heater versions

Utility Fans

Model	Page	CFM	Sones	Housing Dimensions			Grille Dimensions		Amps	Duct Size
				L"	W"	H"	L"	W"		
12C	38	360	8.0	—	11 ¹ / ₂ Sq	—	13 ¹ / ₂ Sq	1.7	Direct Discharge	
502	38	270	8.0	16 ³ / ₄	13 ⁷ / ₈	3 ¹ / ₄	13 ¹ / ₂ Sq	1.7	3 ¹ / ₄ " x 10"	
503	38	160	5.0	14	12	3 ¹ / ₄	11 ¹ / ₂ Sq	1.5	3 ¹ / ₄ " x 10"	
504	38	350	6.5	—	10 ³ / ₄ Rd	7	13 ¹ / ₂ Sq	1.7	10"	
505	38	180	6.5	—	8 ¹ / ₄ Rd	7	11 ¹ / ₂ Sq	1.5	8"	
506	38	470	8.0	—	10 ³ / ₈ Rd	—	13 ¹ / ₂ Sq	1.7	Direct Discharge	
507	38	250	7.0	—	8 ³ / ₈ Rd	—	11 ¹ / ₂ Sq	1.5	Direct Discharge	
508	38	270	6.0	—	10 ³ / ₈ Rd	—	13 ¹ / ₂ Sq	1.7	Direct Discharge	
509	38	180	6.5	—	8 ³ / ₈ Rd	—	13 ¹ / ₂ Sq	1.5	Direct Discharge	
509S	38	180	6.5	—	8 ³ / ₈ Rd	—	13 ¹ / ₂ Sq	1.5	Direct Discharge	
510	38	380	6.5	—	11 ¹ / ₂ Sq	—	13 ¹ / ₂ Sq	1.7	Room to room wall fan	
511	38	180	4.5	—	11 ¹ / ₂ Sq	—	13 ¹ / ₂ Sq	0.9	Room to room wall fan	
512	38	90	3.5	—	6 Rd	—	8 Dia	0.7	Room to room wall fan	
512M	38	70	3.5	—	6 Rd	—	8 Dia	0.7	Direct Discharge	
673	38	60	4.5	—	6 ¹ / ₄ Rd	5 ¹ / ₄	8 Dia	1.0	6"	

In-Line Ventilators

Model	Page	CFM	0.2" Ps Sones	Housing Dimensions			Amps	Duct Size
				L"	W"	H"		
MP100	40	110	1.0	11	10 ¹ / ₂	9 ¹ / ₂	0.5	4- 4" Rd Inlets, 6" Rd Outlet
MP140	40	150	1.5	11	10 ¹ / ₂	9 ¹ / ₂	0.8	4- 4" Rd Inlets, 6" Rd Outlet
MP200	40	210	2.0	11	10 ¹ / ₂	9 ¹ / ₂	1.3	4- 4" Rd Inlets, 6" Rd Outlet
MP280	40	290	3.0	15 ¹ / ₄	14 ¹ / ₄	14 ³ / ₄	2.5	4- 4" Rd Inlets, 6" Rd Outlet
SP100	40	110	1.0	11	10 ¹ / ₂	9 ¹ / ₂	0.5	6" Rd Inlet and Outlet
SP140	40	150	1.5	11	10 ¹ / ₂	9 ¹ / ₂	0.8	6" Rd Inlet and Outlet
SP200	40	210	2.0	11	10 ¹ / ₂	9 ¹ / ₂	1.3	6" Rd Inlet and Outlet

Powered Attic Ventilators—Gable and Roof Mount

Model	Page	Description	Housing Dimensions			CFM	Sones	Amps	Dome Color	Dome Material
			L"	W"	H"					
349BR	47	PAV—Roof Mount	25 Sq	24 ¹ / ₂ Dia Dome	9	1000	n/a	4.0	Dark Brown	Metal
350BK	47	PAV—Roof Mount	22 ¹ / ₄ Sq	23 ¹ / ₄ Dia Dome	8	1050	n/a	3.6	Black	PVC
350BR	47	PAV—Roof Mount	22 ¹ / ₄ Sq	23 ¹ / ₄ Dia Dome	8	1050	n/a	3.6	Brown	PVC
353	47	PAV—Gable Mount	15 Dia	—	8	1020	n/a	3.4	—	—
35316	47	PAV—Gable Mount	15 Dia	—	8	1600	n/a	3.9	—	—
355BK	47	PAV—Roof Mount	22 ¹ / ₄ Sq	23 ¹ / ₄ Dia Dome	8	1200	n/a	4.3	Black	PVC
355BR	47	PAV—Roof Mount	22 ¹ / ₄ Sq	23 ¹ / ₄ Dia Dome	8	1200	n/a	4.3	Brown	PVC
356BK	47	PAV—Roof Mount	22 ¹ / ₄ Sq	23 ¹ / ₄ Dia Dome	8	1600	n/a	8.0	Black	PVC
356BR	47	PAV—Roof Mount	22 ¹ / ₄ Sq	23 ¹ / ₄ Dia Dome	8	1600	n/a	8.0	Brown	PVC
358	47	PAV—Roof Mount	22 ¹ / ₄ Sq	23 ¹ / ₄ Dia Dome	8	1200	n/a	4.3	Silver	Metal

Solar-Powered Attic Ventilators—Surface, Curb, Remote and Gable

Model*	Page	Mount	Color	Housing Material*	Solar Panel Power Output	Pieces	Dome/Panel Dimensions (inches)		
							Height"	Width"	Length"
345CS0BK	48	Curb	Black	ABS Plastic	28 Watts	1 pc	11	29 ⁷ / ₈	26 ⁵ / ₈
345CS0WW	48	Curb	Weathered Wood	ABS Plastic	28 Watts	1 pc	11	29 ⁷ / ₈	26 ⁵ / ₈
345G0BK	49	Gable	Black	ABS Plastic	28 Watts	2 pcs	3 ³ / ₄ / 11	30 / 19 ³ / ₄	26 ⁵ / ₈ / 19 ³ / ₄
345G0WW	49	Gable	Weathered Wood	ABS Plastic	28 Watts	2 pcs	3 ³ / ₄ / 11	30 / 19 ³ / ₄	26 ⁵ / ₈ / 19 ³ / ₄
345RS0BK	49	Remote	Black	ABS Plastic	28 Watts	2 pcs	3 ³ / ₄ / 9	30 / 29 ⁷ / ₈	26 ⁵ / ₈ / 26 ⁵ / ₈
345RS0WW	49	Remote	Weathered Wood	ABS Plastic	28 Watts	2 pcs	3 ³ / ₄ / 9	30 / 29 ⁷ / ₈	26 ⁵ / ₈ / 26 ⁵ / ₈
345S0BK	48	Surface	Black	ABS Plastic	28 Watts	1 pc	9	29 ⁷ / ₈	26 ⁵ / ₈
345S0WW	48	Surface	Weathered Wood	ABS Plastic	28 Watts	1 pc	9	29 ⁷ / ₈	26 ⁵ / ₈

*All UV-enhanced ABS plastic housings may be painted to match roof color



HIGH
NEED HIGH





-TRAFFIC ENVIRONMENTS PERFORMANCE VENTILATION.

LOOKING FOR AN EXCEPTIONALLY QUIET SOLUTION TO LIGHT COMMERCIAL VENTILATION?

With their heavy-duty motors, Broan High Capacity Ventilation Fans are the perfect answer for ventilating conference rooms, dining areas, public restrooms and other heavily-trafficked spaces. Low-vibration and low-profile, these discrete products work quietly and powerfully behind the scenes to remove odor, humidity and air-borne particulates that affect indoor air quality.



100/150 CFM FEATURES

- 6" round metal duct connector
- Single, impact-resistant centrifugal blower wheel housing
- 20 gauge galvanized steel housing
- Duct horizontally, vertically, or in-line with a separate adapter
- Low profile, white polymeric or painted white enamel metal grille
- Models L100L and L150L are UL Listed for use over bathtubs or showers when connected to a GFCI branch circuit
- Model 80L Variable Speed Control adjusts blower speed and sound level (available separately)

200/250/300 CFM FEATURES

- 8" round metal duct connector
- Single, impact-resistant centrifugal blower wheel (Model L300KMG has a metal wheel)
- 20 gauge galvanized steel housing
- Duct horizontally, vertically, or in-line with a separate adapter
- Models L200L, L250L and L300L are UL Listed for use over bathtubs or showers when connected to a GFCI branch circuit
- Model 80L Variable Speed Control adjusts blower speed and sound level (available separately)

SPECIAL FEATURES FOR

Model L300KMG

- Removable access panel; Suitable for kitchen use

Models L100L, L150L

- Removable access panel, no insulation
- Two 6" round duct connectors
- No grille

Models L200L, L250L, L300L

- Suitable for kitchen installations
- Removable access panel, no insulation
- Two 8" round duct connectors

L100 | L150 | L200 | L250 | L300
POLYMERIC GRILL



L100MG | L150MG | L200MG | L250MG, L300MG | L300KMG
METAL GRILL

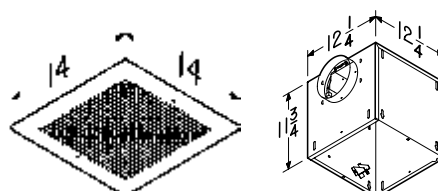
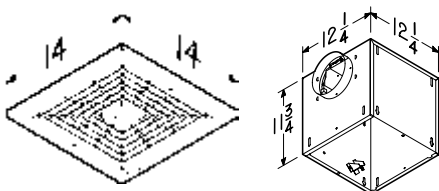
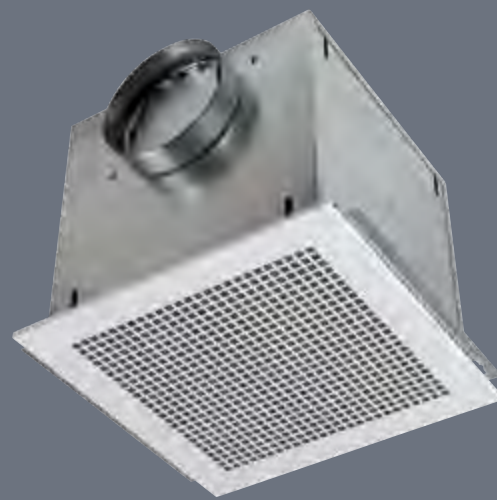

Metal grilles are not acceptable for use over tub or shower.

100–300 CFM Specifications

Model	CFM	Sones	Amps	Sound Insulation	Notes
White Polymeric Grill					
L100	109	0.9	1.1	Yes	
L150	157	1.5	1.3	Yes	
L200	210	1.7	1.8	Yes	
L250	259	2.2	2.1	Yes	
L300	308	2.9	2.6	Yes	
White Metal Grill					
L100MG	115	0.9	1.1	Yes	
L150MG	161	1.4	1.3	Yes	
L200MG	215	1.9	1.8	No	
L250MG	265	2.5	2.1	No	
L300MG	316	3.0	2.6	No	
L300KMG	277	3.1	2.6	No	
In-line Ventilator					
L100L	106	0.7	1.1	No	No Grille
L150L	147	1.1	1.3	No	No Grille
L200L	195	1.9	1.8	No	No Grille
L250L	245	2.3	2.1	No	No Grille
L300L	293	3.1	2.6	No	No Grille

See page 71 for CFM details.

FOR EVERY
VENTILATION NEED



L100L | L150L | L200L | L250L | L300L IN-LINE VENTILATORS

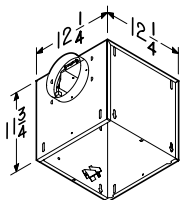
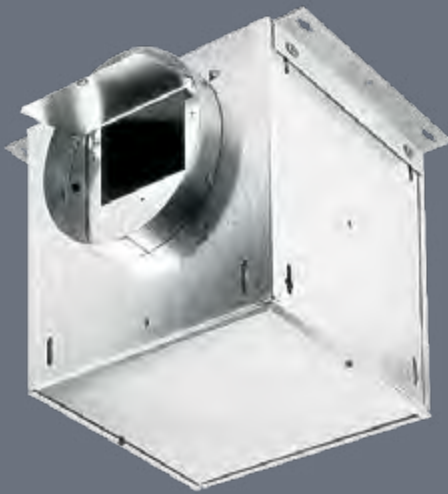

MODEL 80L

- Adjust ventilation easily in any room
- Variable Speed Control mounts inside the fan housing and allows blower speed adjustment
- For Broan High Capacity Fans L100–L900
- Speed control with metal housing
- Fan insulation is perforated for easy installation
- 120V, 3 amps, 60 Hz

80L VARIABLE SPEED CONTROL



400/500/700 CFM FEATURES

- 4 $\frac{1}{2}$ " x 18 $\frac{1}{2}$ " duct connector
- Two impact-resistant centrifugal blower wheels
- Duct horizontally or vertically—In-line available with separate adapter
- Quiet automatic backdraft dampers
- Variable Speed Control adjusts blower speed and sound level (available separately)
- Models with "K" suffix suitable for kitchens
- Not for use over tub or shower

Models L400L, L500L, L700L

- Removable access panel; no insulation

Model L400K

- Suitable for kitchens
- Two metal centrifugal blower wheels
- Order Aluminum Filter LAF2

Model L500K

- Two metal centrifugal blower wheels
- Order Aluminum Filter LAF2
- Suitable for kitchens

L400* | L400K | L500* | L500K | L700*
METAL GRILLE



L400L | L500L | L700L
IN-LINE VENTILATORS

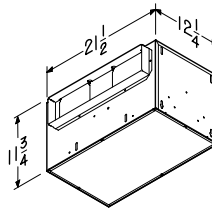
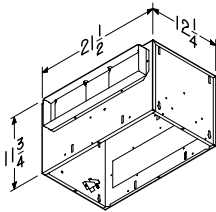
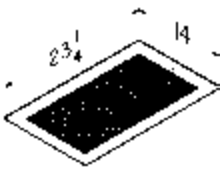

400-700 CFM Specifications

Model	CFM	Sones	Amps	Sound Insulation	Notes
L400	434	2.3	1.4	Yes	Metal grille
L400K	406	3.3	1.4	No	Suitable for kitchens
L500	514	3.3	2.2	Yes	Metal grille
L500K	481	4.4	2.2	No	Suitable for kitchens
L700	701	4.7	2.9	Yes	Metal grille
L400L	406	1.6	1.4	No	No grille
L500L	519	3.4	2.2	No	No grille
L700L	681	3.7	2.9	No	No grille

*See page 71 for CFM details.

Metal grilles are not acceptable for use over tub or shower.

900/1500/2000 CFM FEATURES

- 8" x 12" duct
- Painted white enamel metal grille
- Single, impact-resistant centrifugal blower wheel
- Ducted horizontally or vertically, or in-line with separate adapter
- Model 80L Variable Speed Control adjusts blower speed and sound level (available separately)
- Not for use over tub or shower

Models L900, L1500 (shown)

- L900 can use the 80L variable speed blower control (sold separately)

Models L900L, L1500L

- Removable access panel; no insulation
- Can use the 80L variable speed blower control (sold separately)

Model L2000L

- 38"L x 14⁵/₈"W x 14⁵/₈"H
- Fits 7³/₄" x 33³/₄" duct
- Optional metal grille (Model G102) and damper kit (Model D100)

L900 | L1500*
METAL GRILLE

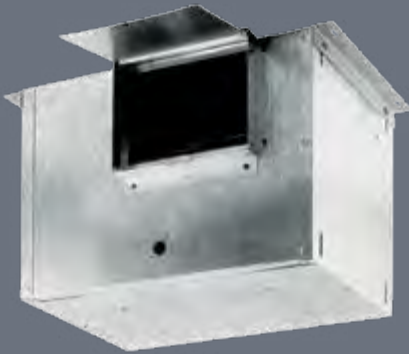

L900L | L1500L
IN-LINE VENTILATORS

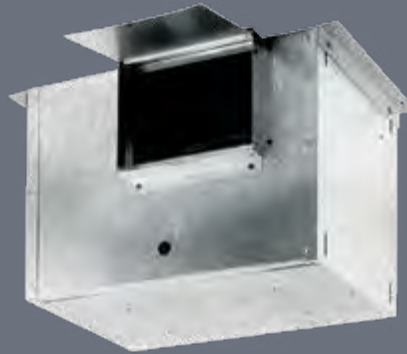

L2000L
IN-LINE VENTILATORS



Shown with optional metal grille (Model G102) and damper kit (Model D100).

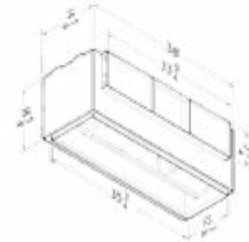
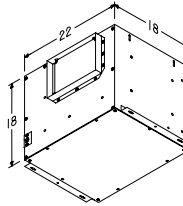
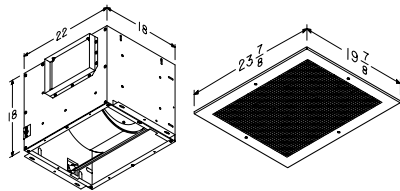

80L
VARIABLE SPEED CONTROL



900–2000 CFM Specifications

Model	CFM	Sones	Amps	Notes
L900	901	4.1	3.0	Painted white enamel metal grille
L1500	1513	8.4	5.0	Painted white enamel metal grille
L900L	894	3.8	3.0	In-line
L1500L	1214	6.7	5.0	In-line
L2000L	1791	9.4	5.8	In-line

See page 71 for CFM details.

Metal grilles are not acceptable for use over tub or shower.

MODEL 80L

- Adjust ventilation easily in any room
- Variable Speed Control mounts inside the fan housing and allows blower speed adjustment
- For Broan High Capacity Fans L100–L900L
- Speed control with metal housing
- Fan insulation is perforated for easy installation
- 120V, 3 amps, 60 Hz

PERFORMANCE DATA INVENT

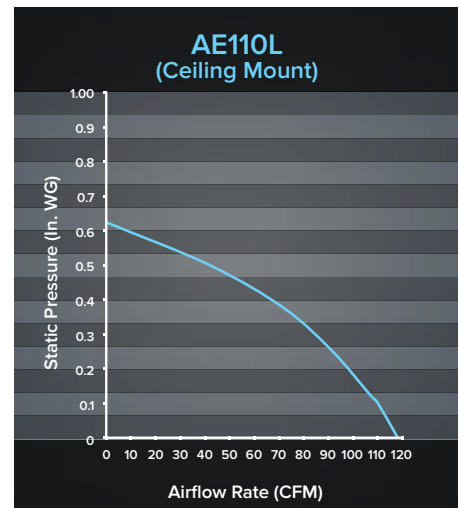
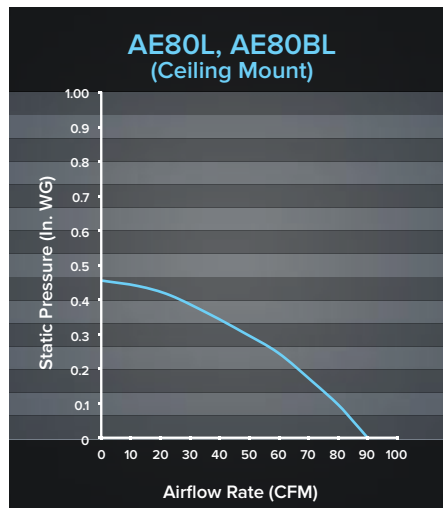
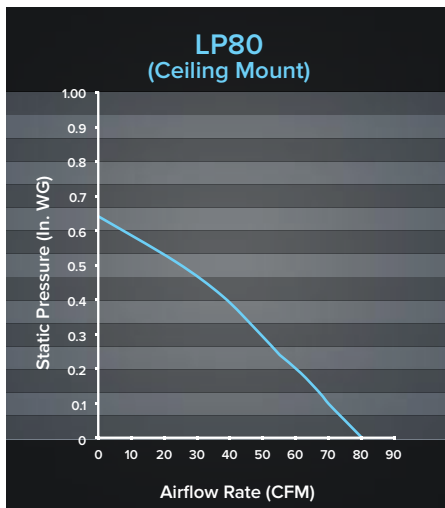
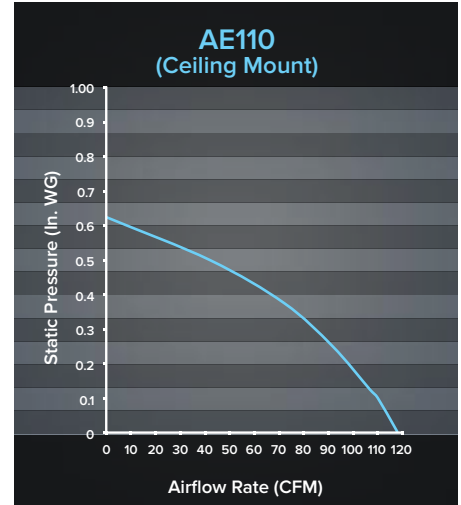
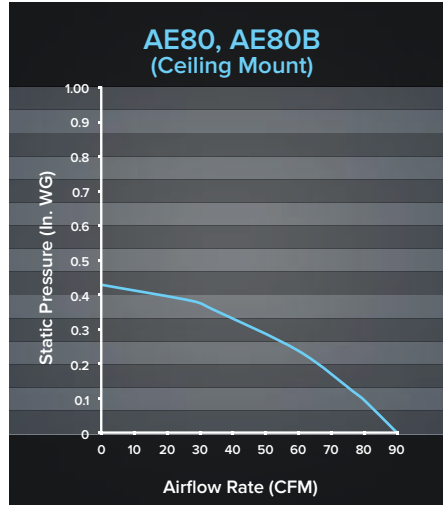
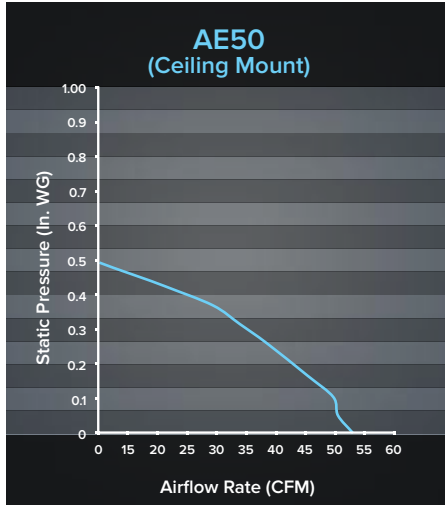

PERFORMANCE DATA LIGHT COMMERCIAL

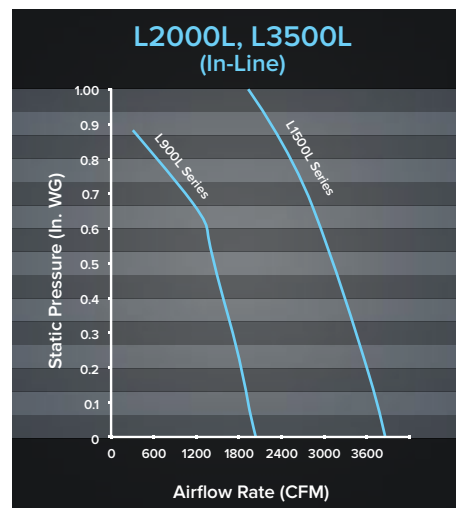
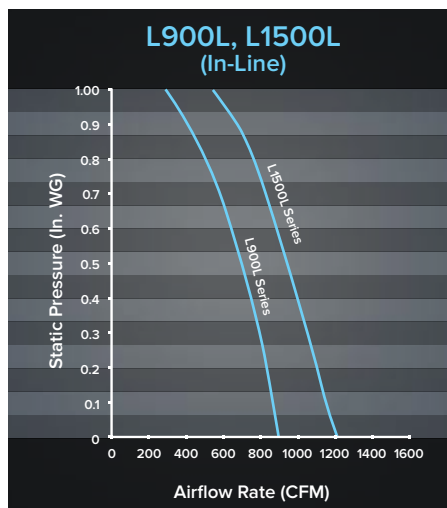
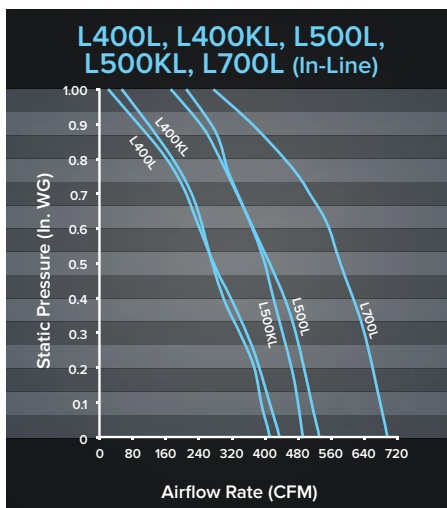
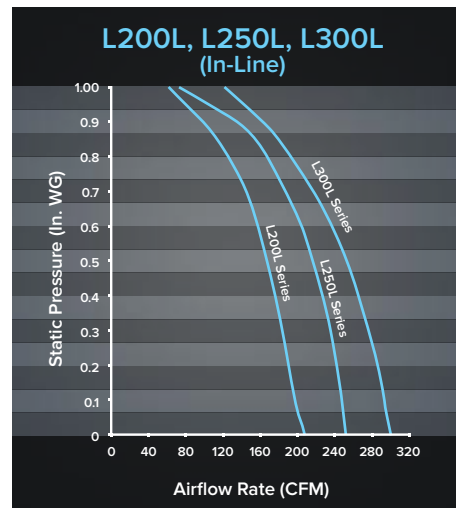
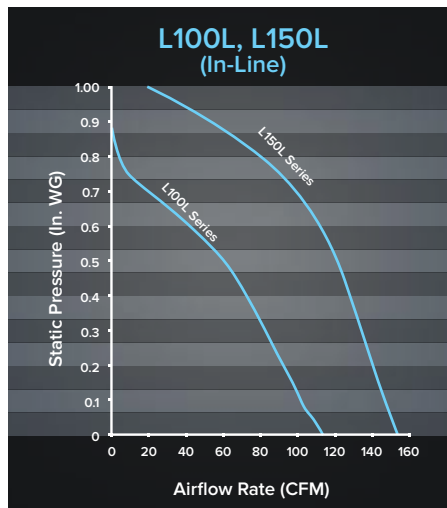
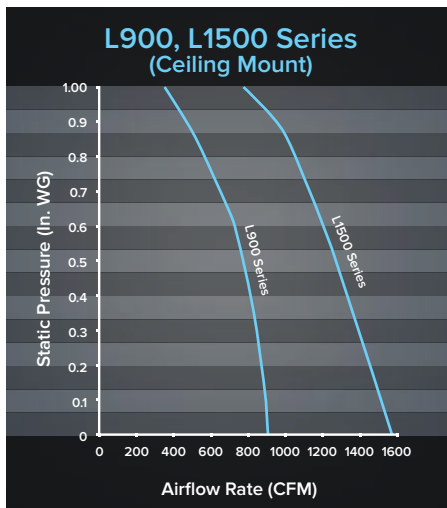
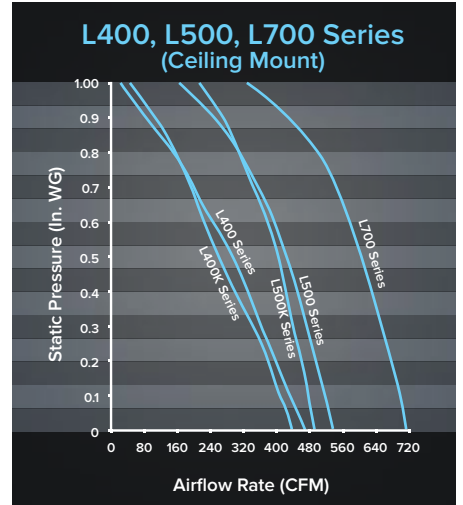
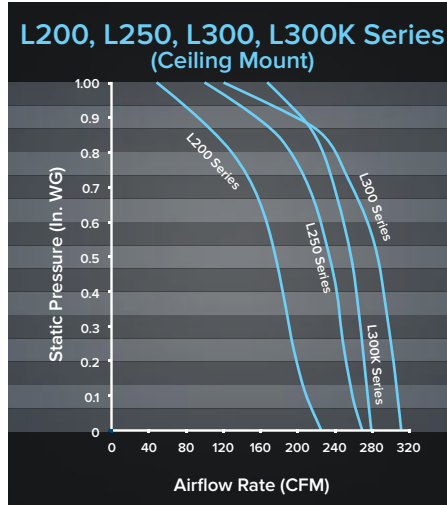
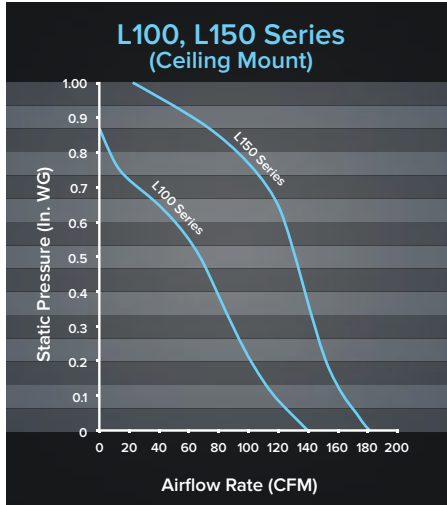

For In-line models, performance listed is for straight-through ducting at .125" static pressure. For complete Sonnes and CFM at other static pressures, see our Web site at www.Broan.com.

ROOF CAPS

Model 437

- High-capacity design up to 1200 CFM
- Built-in bird screen
- Steel housing, black electrically bonded epoxy finish



Model 611

- For flat roof installation
- Aluminum natural finish
- For up to 8" round duct



Model 611CM

- For curb mount installation
- Other features same as Model 611



Model 612

- For flat roof installation
- Aluminum natural finish
- For up to 12" round duct

Model 612CM

- For curb mount installation
- Other features same as Model 612

Model 634

- For 3 $\frac{1}{4}$ " x 10" or up to 8" round duct
- Built-in backdraft damper and bird screen
- Steel housing, black electrically bonded epoxy finish



Model 634M

- Same as Model 634, except for 6" round duct

Model 644

- Same as Model 634, except aluminum natural finish

GREASE FILTERS

Models LAF1 & LAF2

- Aluminum mesh filter traps grease and protects motor
- Dishwasher safe
- LAF1 (12" x 12") for L100/150/200/250/300 Series
- LAF1 for use with metal grilles
- LAF2 (12" x 21 $\frac{1}{4}$ ") for L400/500 Series

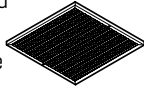

WALL CAPS

Model 441

- For 10" round duct
- Steel with aluminum louvers



Model 613

- For 12" round duct
- Built-in backdraft damper and bird screen
- Aluminum natural finish

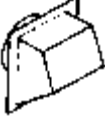

Model 641

- Same as Model 613, except for 6" round duct

Model 643

- For 8" round duct
- Built-in backdraft damper
- Aluminum natural finish



Model 843BL

- For 6" round duct
- Built-in backdraft damper and bird screen
- Black finish



IN-LINE ADAPTERS

Model 961L

- For L100/L150 Series
- Galvanized steel
- 6" round duct intake

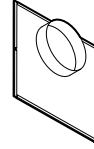

Model 981L

- For L200/L250/L300 Series
- Galvanized steel
- 8" round duct intake

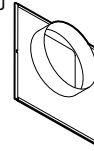

Model 982L

- For L400/L500/L700 Series
- Galvanized steel
- 4 $\frac{1}{2}$ " x 18 $\frac{1}{2}$ " duct intake

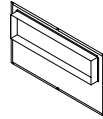

Model 983L

- For L900/L1500 Series
- Galvanized steel
- 8" x 12" duct intake

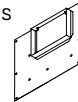

DUCT TRANSITIONS

Models 423 & T81212

- Galvanized steel
- 423: (4 $\frac{1}{2}$ " x 18 $\frac{1}{2}$ " to 10" round)
- T81212: (8" x 12" to 12" round)

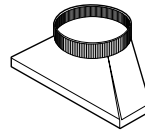

VIBRATION DAMPENING HANGERS

Model V104 (not shown)

- For Model L2000L
- Heavy gauge steel construction
- Neoprene vibration dampening cushion
- Maximum load 75 lbs (each)
- For $\frac{3}{8}$ " diameter threaded rod (available separately from others)
- Set of four required for each ventilator

METAL GRILLE KIT

Model MG1

- For L100/150/200/250/300 Series
- White enamel painted steel
- Mounting screws included

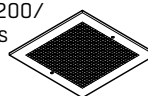

RADIATION DAMPERS

When excessive heat is detected, the breakaway fusible link triggers the closing of the radiation damper's fire resistant screen to prevent smoke and fire from traveling through ductwork.

Features

- 165° fusible link
- Galvanized steel frame
- Stainless steel negator-type closure spring



High Capacity Models RD1, RD2, RD3 (not shown)

- UL rated 3-hour ceiling radiation dampers
- High temperature, non-asbestos, reinforced fiber thermal fabric
- RD1 (12 $\frac{1}{2}$ " x 12 $\frac{1}{2}$ ") for L100/150/200/250/300 Series
- RD2 (21 $\frac{3}{4}$ " x 12 $\frac{1}{2}$ ") for L400/500/700 Series
- RD3 (22 $\frac{1}{4}$ " x 18 $\frac{1}{4}$ ") for L900/1500 Series

WALL CONTROLS

REMOTE IN-LINE VENTILATOR ACCESSORIES

Model DH100W

- Dehumidistat
- Dual voltage (24V/120V)
- Variable setting from 20–80% relative humidity
- Usage guide included



Model 70TW

- Thermostat for any fan 120, 250, 277 VAC, 22 amp capacity



DECORATOR WALL CONTROLS

Model 69W

- Single-Function Controls
- 120V, 15 amps



SPEED CONTROLS

Model 57W, 57V 3-Amp

- 120V, 3 amps
- Fits single-gang box
- Positive on/off action—dial for variable selection of air speeds and sound levels
- Built-in radio noise suppressor
- Blister packs available (P57W)



Model 72W, 72V 6-Amp

- 120V, 6 amps—Models 72W, 72V
- Same features as 57W/57V



TIMER & OFF-DELAY CONTROLS

Model 64W, 64V

- Fan/Light Control with Off-Delay
- Fan and light operate together when control is turned on
- Fan continues to operate for a user adjustable time period 5-60 minutes after light is turned off
- Center position bypasses timer and turns fan and light off immediately
- Fits single-gang box
- 120V, 4 amps (fan), 4 amps (light)
- Requires hot and neutral wires in the switch box

Model 80L

- For Broan High Capacity Fans L100–L900L
- Speed control with metal housing
- Fan insulation is perforated for easy installation
- 120V, 3 amps, 60 Hz
- cUL Listed

TWO-FUNCTION CONTROLS

Model 68W, 68V

- Two-Function Controls
- Two independent, 120V, 15 amp rocker switches (20 amps total)
- Fits single-gang box
- Blister packs available (P68W, P68V)



TIMER & OFF-DELAY CONTROLS

Model 59W, 59V, 71V

- Model 59W, 59V—up to 60 minutes
- Model 71V—up to 12 hours
- Fits single-gang box
- 120V, 20 amps; 240V, 10 amps
- Blister packs available (P59W, P59V)
- Operate continuously or for any set period



Model 61W, 61V

- Operate for any set period up to 15 minutes (no “continuous on” position)
- Other features same as 59W/59V



Specifications

Model	CFM/Sones .125" Ps (AMCA)		Housing Dimensions			Grille Dimensions		Amps at 60 Hz	Duct"	Watts	Volts
	CFM	Sones	L"	W"	H"	L"	W"				
L100	109	0.9	12 ³ / ₄	12 ³ / ₄	11 ³ / ₄	14	14	1.1	6	87	120
L100L	106	0.7	12 ³ / ₄	12 ³ / ₄	11 ³ / ₄	—	—	1.1	6	87	120
L100MG	115	0.9	12 ³ / ₄	12 ³ / ₄	11 ³ / ₄	14	14	1.1	6	87	120
L150	157	1.5	12 ³ / ₄	12 ³ / ₄	11 ³ / ₄	14	14	1.3	6	100	120
L150L	147	1.1	12 ³ / ₄	12 ³ / ₄	11 ³ / ₄	—	—	1.3	6	100	120
L150MG	161	1.4	12 ³ / ₄	12 ³ / ₄	11 ³ / ₄	14	14	1.3	6	100	120
L200	210	1.7	12 ³ / ₄	12 ³ / ₄	11 ³ / ₄	14	14	1.8	8	127	120
L200L	195	1.9	12 ³ / ₄	12 ³ / ₄	11 ³ / ₄	—	—	1.8	8	127	120
L200MG	215	1.9	12 ³ / ₄	12 ³ / ₄	11 ³ / ₄	14	14	1.8	8	127	120
L250	259	2.2	12 ³ / ₄	12 ³ / ₄	11 ³ / ₄	14	14	2.1	8	166	120
L250L	245	2.3	12 ³ / ₄	12 ³ / ₄	11 ³ / ₄	—	—	2.1	8	166	120
L250MG	265	2.5	12 ³ / ₄	12 ³ / ₄	11 ³ / ₄	14	14	2.1	8	166	120
L300	308	2.9	12 ³ / ₄	12 ³ / ₄	11 ³ / ₄	14	14	2.6	8	212	120
L300KMG	277	3.1	12 ³ / ₄	12 ³ / ₄	11 ³ / ₄	14	14	2.6	8	212	120
L300L	293	3.1	12 ³ / ₄	12 ³ / ₄	11 ³ / ₄	—	—	2.6	8	212	120
L300MG	316	3.0	12 ³ / ₄	12 ³ / ₄	11 ³ / ₄	14	14	2.6	8	212	120
L400	434	2.3	21 ¹ / ₂	12 ³ / ₄	11 ³ / ₄	23 ³ / ₄	14	1.4	4 ¹ / ₂ x 18 ¹ / ₂	146	120
L400K	406	3.3	21 ¹ / ₂	12 ³ / ₄	11 ³ / ₄	23 ³ / ₄	14	1.4	4 ¹ / ₂ x 18 ¹ / ₂	146	120
L400L	406	1.6	21 ¹ / ₂	12 ³ / ₄	11 ³ / ₄	—	—	1.4	4 ¹ / ₂ x 18 ¹ / ₂	146	120
L500	514	3.3	21 ¹ / ₂	12 ³ / ₄	11 ³ / ₄	23 ³ / ₄	14	2.2	4 ¹ / ₂ x 18 ¹ / ₂	232	120
L500K	481	4.4	21 ¹ / ₂	12 ³ / ₄	11 ³ / ₄	23 ³ / ₄	14	2.2	4 ¹ / ₂ x 18 ¹ / ₂	232	120
L500L	519	3.4	21 ¹ / ₂	12 ³ / ₄	11 ³ / ₄	—	—	2.2	4 ¹ / ₂ x 18 ¹ / ₂	232	120
L700	701	4.7	21 ¹ / ₂	12 ³ / ₄	11 ³ / ₄	23 ³ / ₄	14	2.9	4 ¹ / ₂ x 18 ¹ / ₂	313	120
L700L	681	3.7	21 ¹ / ₂	12 ³ / ₄	11 ³ / ₄	—	—	2.9	4 ¹ / ₂ x 18 ¹ / ₂	313	120
L900	901	4.1	22	18	18	23 ⁷ / ₈	19 ⁷ / ₈	3.0	8 x 12	306	120
L900L	894	3.8	22	18	18	—	—	3.0	8 x 12	306	120
L1500	1513	8.4	22	18	18	23 ⁷ / ₈	19 ⁷ / ₈	5.0	8 x 12	468	120
L1500L	1214	6.7	22	18	18	—	—	5.0	8 x 12	468	120
L2000L	1791	9.4	38	14 ⁵ / ₈	14 ⁵ / ₈	—	—	5.8	7 ³ / ₄ x 33 ³ / ₄	590	120

Sones and CFM listed for ceiling mount models are for horizontal ducting at .125" static pressure

Wall Controls

Model	L100– L700 Series	L900 Series	L1500 Series	L2000L Series	HD50L HD80L
57W 57V	•				
59W 59V	•	•	•	•	
61W 61V	•	•	•	•	
64W 64V	•	•			
68W 68V					•
69W	•	•	•	•	
70TW	•	•	•	•	
71V	•	•	•	•	
72W 72V	•	•	•	•	
80L	•	•			
DH 100W	•	•	•	•	

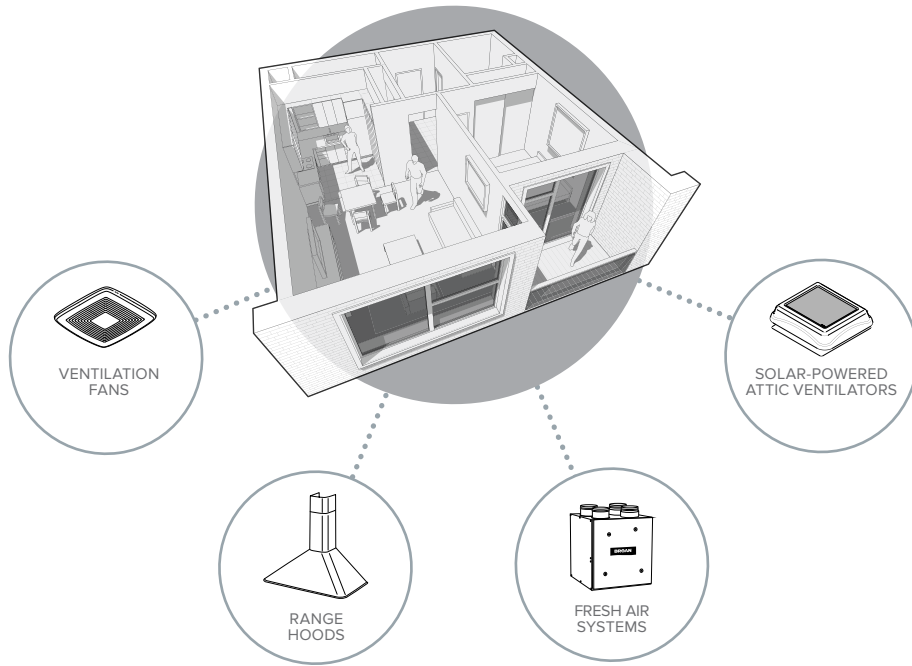

THE LEADER IN RESIDENTIAL INDOOR AIR QUALITY.
WELCOME TO A BROAN HOME.

Broan® is America's leading brand of residential ventilation products including range hoods, ventilation fans, heater/fan/light combination units, fresh air systems, whole-house fans and electric and solar-powered attic ventilators.



Broan.com

Broan-NuTone LLC, 926 W. State Street
Hartford, WI 53027 **800-558-1711**
In Canada call **877-896-1119**

America's Choice For Green Builders® Proud to be ENERGY STAR® partners.



0 26715 24032 6

BROAN[®]

BROAN VENTILATION SOLUTIONS.
BETTER AIR. BETTER LIFE.



VENTILATION FANS

WHEN YOUR HOME BREATHES,



WHY INDOOR AIR QUALITY IS IMPORTANT TO YOU.

Consider this, according to the EPA (epa.gov), indoor air quality is five times worse than outdoor air quality. Most homeowners know that indoor air quality is important, but not all recognize what contributes to poor indoor air quality, the potential effects and harm, and how to address these problems. Broan is here to help. For more than 80 years, Broan has led the industry with residential ventilation solutions that improve indoor air quality and provide healthier home environments.

Moisture that is not properly ventilated can cause mildew and mold formation, which can potentially lead to structural problems and health problems. Exhaust ventilation solutions from Broan remove humidity at the source to help maintain the optimal humidity balance of 40 to 60 percent.

Off-gassing from construction materials, carpeting, adhesives and synthetic materials—as well as solvents from common household cleaners—can accumulate in tightly built homes. Look to Broan for continuous ventilation solutions that meet ASHRAE 62.2.

Particulates from dust, allergens, pet dander, and more can contribute to poor indoor air quality up to 100 times dirtier than outside air. With a properly ventilated home, you create a more enjoyable, comfortable and healthier environment.

Cooking effluents from food preparation can infiltrate the whole house in minutes. Grease, oils and aromas settle permanently into carpets, furniture, clothing and other surfaces. Kitchen ventilation solutions help eliminate cooking effluents for a cleaner, more comfortable and healthier environment.

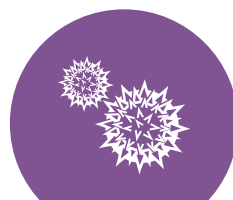

YOU BREATHE EASIER TOO.

BROAN CAN IMPROVE INDOOR AIR QUALITY IN EVERY ROOM OF THE HOME.

From clearing humidity in the bathroom to removing heat, steam and airborne effluents in the kitchen. From whole-house HEPA air filtration and balanced fresh air exchange solutions to attic ventilation. From the family room to the master bedroom and in every room in between, no company knows residential and light commercial ventilation like Broan-NuTone. After more than 80 years, countless innovations and a commitment to indoor air quality, trust Broan to clear up every concern.



EXHAUST VENTILATION

removes excess moisture and odor from any room in the home, and can also provide continuous, whole-house ventilation.

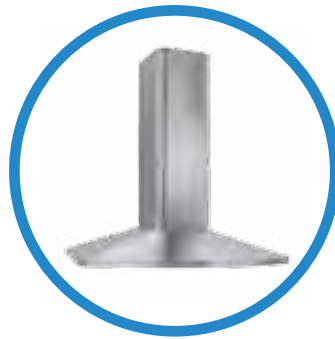

KITCHEN VENTILATION

expels cooking effluents from food preparation to eliminate airborne pollutants from spreading through the entire house.



FRESH AIR SYSTEMS

efficiently exchanges inside air with fresh outside air, and removes airborne particulate with HEPA filtration.

DID YOU KNOW?*

Knowing the facts goes a long way toward a healthier indoor environment:

Just **46%** recognize not having a bathroom fan has a negative impact on indoor air quality—only 42% recognize that a lack of a range hood also has a negative impact.

60% have a fan in each bathroom but only one in five let it run for 10 minutes after showering.

Some homeowners don't recognize the causes of poor indoor air quality:

Only **42%** are concerned about moisture that causes mold or mildew.

Only **33%** know food aromas after preparation is an indicator of poor IAQ.

81% don't know that a foggy mirror means poor IAQ.

Most homeowners are tuned in to residential Indoor Air Quality concerns:

60% know that indoor air quality has a greater impact on their health than outdoor air quality.

90% realize poor indoor air quality contributes to certain health issues and that healthy air helps prevent illness.

INDOOR AIR QUALITY IS IMPORTANT IN EVERY ROOM OF THE HOME, NOT JUST THE BATHROOM.

2-9 INTRODUCTION

10-15 ULTRA™ SERIES

16-19 QT SERIES

20-21 SENSING FANS

22-23 SMARTSENSE SERIES

24-27 INVENT™ SERIES

28-29 LOPROFILE™

30-31 CLASSIC VENTILATION

32-35 ARCHITECTURAL FAN/LIGHTS

36-41 SPECIALTY

42-45 HEATER/FAN/LIGHTS

46-49 ATTIC VENTILATORS

50-53 WALL CONTROLS

54-55 DUCTING ACCESSORIES

56-57 FAQs

58-59 INSTALLATION NOTES

60-63 SPECIFICATIONS

64-73 LIGHT COMMERCIAL



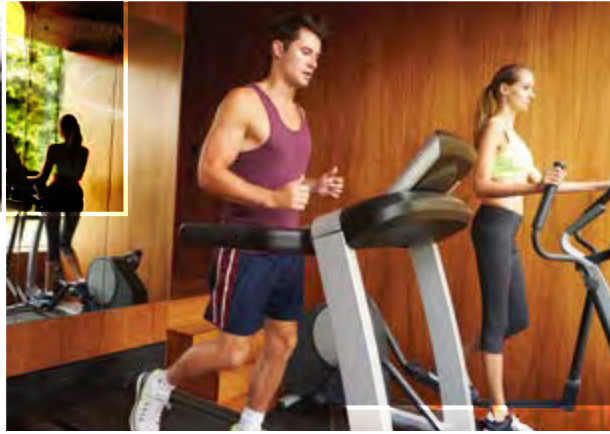



The original
1932 Motordor

THE UNDISPUTED LEADER IN
INDOOR AIR QUALITY SINCE 1932.

INDUSTRY LEADERSHIP ISN'T A CLAIM. IT'S EARNED THROUGH INNOVATION.

In southeastern Wisconsin some eight decades ago, an engineer named Henry Broan had a revelation: Wouldn't a built-in mechanical ventilation solution help to provide better indoor air quality in the kitchen? And so, Motordor was conceived—the first kitchen ventilator—and a company was born. Once Mr. Broan had invented a new category, other applications were the natural next step. The bath ventilation fan soon followed, as the passion for improving indoor air quality continued.

Leadership is built on standards, all to help ensure the professionalism of an industry. So in 1957, Broan was among five companies that founded the Home Ventilating Institute (HVI). To this day the HVI mark ensures what's stated on the package is tested and certified for your confidence. Because Mr. Broan believed that if you paid good money for something, you deserved to get what was promised.

Throughout the years, countless innovations followed, including some of the first certified ventilation fans and range hoods with efficient motors and lighting that reduced energy consumption by as much as 70%. And as homes were built tighter, Broan was on the leading edge of whole-house ventilation solutions with HEPA filtration and energy recovery capabilities. Today, Broan continues to lead the industry with efficient and quiet ventilation solutions that are easier than ever to install.

You see, leadership isn't about entering a market, offering a handful of products, and staking a claim. Leadership is earned and proven through a passion and commitment to finding novel solutions to real problems time and time again. This is exactly why Broan has taken the job of improving air quality in our homes very seriously for more than 80 years.

WE INVENTED THE CATEGORY IN 1932. WE HAVE NO INTENTION OF STOPPING.

1933: Kitchen ventilator:
Motordor is sold



1955: Founder of the
Home Ventilating Institute



1956: The bath fan

1959: The fan/light

1965:
Introduced the first
heater fan light



1993: The
first humidity
sensing
fan hits the
shelves



DID YOU KNOW?

Professional **contractors** recognize the Broan ventilation brand above all others.

Broan-NuTone is the **only** company in North America with an HVI Certified on-site sound testing facility.

Twenty-four* of the top 25 builders specify the Broan brand. More builders use Broan ventilation products than any other brand.

*2015 Hanley Wood Builder Brand Use Study

Broan is a **three-time** winner of the International Service Excellence award. The Customer Service Institute of America recognizes organizations for customer service professionalism.

ENERGY STAR A partner since 2005, Broan has one of the largest ENERGY STAR offerings in the industry, including many ENERGY STAR Most Efficient products. **energystar.gov**

Broan was a **founding member** of the Home Ventilating Institute®, an independent organization that certifies airflow and sound performance of ventilation products. **hvi.org**

About 80% of Broan products are manufactured in our state-of-the-art manufacturing facilities in Hartford, Wisconsin.



2004:
The quiet fan
<0.3 sones

2004: The first recessed fan light



2005: The ENERGY STAR® certified fan



2012: The first fan enabling easy room-side installation



2014:
The first fan with Soft Surround™ LED lighting technology



2015:
The wireless speaker fan



BROAN KNOWS TODAY'S STRINGENT VENTILATION CODES AND STANDARDS.

Because today's homes are built tighter than ever before, what gets in stays in, unless mechanically ventilated out. Premium ventilation solutions from Broan dramatically reduce moisture as well as airborne pollutants from off-gassing building materials, adhesives and household cleaners. They also help eliminate allergens, dust, pet dander and cooking effluents—everything that contributes to poor indoor air quality.

Both spot and whole-house ventilation are important.

Spot ventilation products remove pollutants at the source when they occur—think bathroom fans and kitchen range hoods—quickly eliminating humidity, odor and cooking effluents.

Whole-house ventilation, also known as continuous or dwelling unit ventilation (DUV), continually removes what's not captured by spot ventilation for a more healthy and comfortable home.

Understanding today's ventilation requirements.

The American Society of Heating, Refrigeration and Air Conditioning Engineers (ASHRAE) set the industry standard for ventilation and acceptable indoor air quality for low-rise residential buildings with ASHRAE 62.2. It sets the minimum standard for spot or local ventilation of individual bathrooms of 50 Cubic Feet per Minute (CFM) delivered airflow at 3.0 sones or less. It also specifies the requirements for whole-house ventilation of an entire dwelling at the maximum sound rating of 1.0 sone for ventilation fans.

Code adoption growing rapidly.

California was a leader in this area with their Title 24 Code. Other state and city governments are quickly adopting similar codes such as the International Energy Conservation Code (IECC) to improve energy efficiency as well as indoor air quality.

Above-code green building programs such as ENERGY STAR® for Homes, ENERGY STAR® Indoor Air Plus, the Leadership in Energy and Environment Design (LEED) Certification Building Program and the National Association of Home Builders (NAHB) Green Building Standard are certified green building programs that promote human health and conserve natural resources. Let Broan help you meet the goals of these programs.

You've come to the right place for product solutions.

With Broan's extensive product line-up, including exhaust and balanced ventilation options such as Heat Recovery Ventilators (HRVs) and Energy Recovery Ventilators (ERVs), you're sure to find the ideal solution to meet your needs.

SELECTING THE PROPER WHOLE HOUSE RESIDENTIAL VENTILATION SOLUTION.

Sizing your solution is a factor of square footage and the number of bedrooms in the dwelling to meet requirements. These charts are based on ASHRAE 62.2. Note that the 2010 and 2013 versions are different. Most states still operate under 62.2-2010 rates. Before specifying, check local building codes to ensure it meets requirements.

ASHRAE 62.2—2010 Required Continuous Ventilation Rate (CFM)

Floor Area Sq. Ft.	0-1 BR	2-3 BR	4-5 BR	6-7 BR	>7 BR
<1500	30	45	60	75	90
1501-3000	45	60	75	90	105
3001-4500	60	75	90	105	120
4501-6000	75	90	105	120	135
6001-7500	90	105	120	135	150
>7500	105	120	135	150	165

ASHRAE 62.2—2013 Required Continuous Ventilation Rate (CFM)

Floor Area Sq. Ft.	0-1 BR	2-3 BR	4-5 BR	6-7 BR	>7 BR
<500	30	40	45	55	60
500-1000	45	55	60	70	75
1001-1500	60	70	70	85	90
1501-2000	75	85	90	100	105
2001-2500	90	100	105	115	120
2501-3000	105	115	120	130	135
3001-3500	120	130	135	145	150
>3501	135	145	150	160	165

AN ALTERNATIVE FORMULA APPROACH TO THE TABLES GIVEN ABOVE.

An alternative formula approach to the tables given above also exists and typically results in a lower, more precise CFM requirement. Under the more common 62.2-2010 version, continuous CFM requirements can be calculated using a formula as follows.
 $CFM = .01 \times \text{floor area (in square feet)} + 7.5 \times (\text{number of bedrooms} + 1)$.

Example: A 3,500 square foot home with 4 bedrooms would require 73 CFM
 $.01 \times 3,500 = 35$
 $7.5 \times (4+1) = 38$
 Add together for a total of 73 CFM
 (as compared to the 90 from the above table).

The 62.2-2013 version increases the multiplier for floor area from .01 to .03. Note however that infiltration credits can be taken if blower door testing is conducted.

Whole-house Ventilation Options

Fan Series	Model	CFM	0.25" CFM	Sones	Motor Type	Sensing	Duct Size	Page No.
ULTRA Green™ Multi Speed	ZB80	80	80	<0.3*	DC	—	6" or 4"	12-13
	ZB80M	80	80	<0.3*	DC	Motion	6" or 4"	12-13
	ZB110	110	110	<0.3	DC	—	6"	12-13
	ZB110H	110	110	<0.3	DC	Humidity	6"	12-13
	ZB110M	110	110	<0.3	DC	Motion	6"	12-13
ULTRA Green™ Single Speed	XB50	50	50	<0.3	DC	—	6" or 4"	12-13
	XB80	80	80	<0.3*	DC	—	6" or 4"	12-13
	XB110	110	110	<0.3	DC	—	6"	12-13
	XB110H	110	110	<0.3	DC	Humidity	6"	12-13
ULTRA Pro	RB80	80	60	<0.3	PSC	—	4"	15
	RB110	110	91	0.6	PSC	—	4"	15
QTXE SmartSense**	QTXE080	80	56	0.3	PSC	—	6"	18
	QTXE110	110	86	0.7	PSC	—	6"	18
	SSQTXE080	80	56	0.7	PSC	—	6"	22-23
	SSQTXE110	110	86	0.7	PSC	—	6"	22-23
LoProfile	LP80	80	55	1.0	PSC	—	4"	29
InVent	AE80	80	60	0.8	PSC	—	4"	26
	AE50	50	92	0.5	PSC	—	4"	26

ENERGY STAR® fans use 70% less energy, on average, than standard models and may qualify for local utility rebates

*With 6" duct (0.3 sones with 4" duct)

**SmartSense Models: SSQTXE080 and SSQTXE110 (see pages 22 and 23)



Fan/Light Series	Model	CFM	0.25" CFM	Sones	Motor Type	Sensing	Duct Size	Page No.
ULTRA Green™ Multi Speed	ZB80L	80	80	<0.3*	DC	—	6" or 4"	12-13
	ZB80ML	80	80	<0.3*	DC	Motion	6" or 4"	12-13
	ZB110L	110	110	<0.3	DC	—	6"	12-13
	ZB110HL	110	110	<0.3	DC	Humidity	6"	12-13
	ZB110ML	110	110	<0.3	DC	Motion	6"	12-13
ULTRA Green™ Single Speed	XB50L	50	50	<0.3	DC	—	6" or 4"	12-13
	XB80L	80	80	<0.3*	DC	—	6" or 4"	12-13
	XB110L	110	110	<0.3	DC	—	6"	12-13
	XB110HL	110	110	<0.3	DC	Humidity	6"	12-13
ULTRA Pro	RB80L	80	60	<0.3	PSC	—	4"	15
	RB110L	110	91	0.8	PSC	—	4"	15
QTXE	QTXE080FLT	80	56	0.3	PSC	—	6"	18
	QTXE110FLT	110	86	0.7	PSC	—	6"	18
InVent	AE80L	80	60	0.8	PSC	—	4"	26
	A80L	80	92	1.0	PSC	—	4"	26

ENERGY STAR® fans use 70% less energy, on average, than standard models and may qualify for local utility rebates

Note that in addition to exhaust solutions to meet DUV requirements, we also offer a full line of balanced ventilation models (HRVs and ERVs).



BROAN CODE KEY

The exclusive online tool that ensures compliant ventilation selection.

Specifying a dwelling unit ventilation (DUV) system for residences can be complicated. Code Key from Broan is the only online resource that helps you select the right product in minutes. Choose the dwelling's state, home size facts and user preferences to receive a list of recommended ventilation products. Change parameters to instantly see a range of options. Code Key requires no software and works on mobile devices. It's another way Broan—the pioneer in ventilation for more than 80 years—leads the ventilation industry with forward-thinking products and customer service.

[Broan.com/tools-landing-page/codekey](https://broan.com/tools-landing-page/codekey)



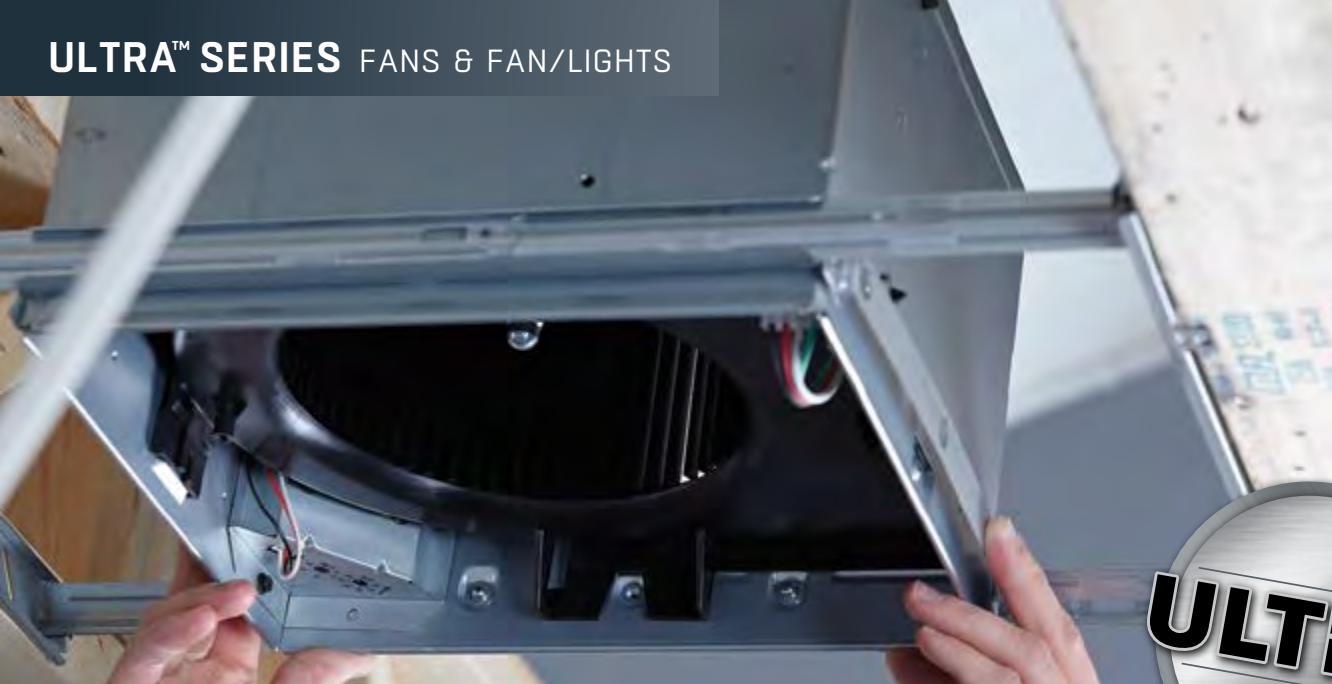

A REVOLUTION IN
VENTILATION FAN TECHNOLOGY
***ENGINEERED TO SIMPLIFY
INSTALLATION.***

WE DIDN'T JUST CHANGE ONE THING TO MAKE INSTALLATIONS FASTER, WE CHANGED EVERYTHING. From a unique telescoping mounting frame that installs room-side on retro-fits to an easy-to-insert housing and blower that snap into place, we designed the ULTRA™ Series to be the fastest, easiest, most universal installation in new construction or retro-fit. No matter what's behind the drywall on your next retro-fit job, you'll never have another difficult installation. And just as important, the ULTRA™ Series meets whole-house mechanical ventilation codes and green building program requirements. It's a revolutionary way to install and a revolutionary way to ventilate.





SOUND TECHNOLOGY

Reduce sound levels and improve sound quality in real-world installations. The innovative, patent-pending QStream™ technology utilizes airflow-smoothing baffles that reduce turbulence which means the blower can turn more slowly and quietly—without airflow loss.*

*Not available on 110 CFM ULTRA Green™ Models

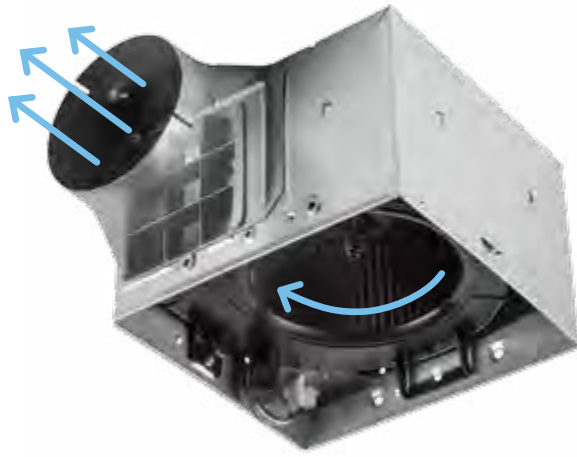

Inside/outside wiring capability provides flexible new or retrofit installation

Pre-installed screws in the mounting frame enable quick installation

Vertical positioning tabs ensure the housing is in the right place

The expandable mounting frame adjusts from 14"–24" and fits any type of joist, I-joist or truss construction

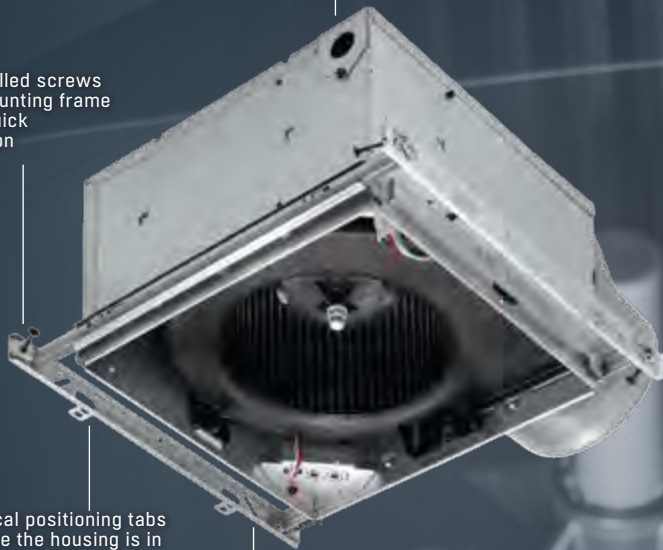

ULTRAQUICK™ INSTALLATION TECHNOLOGY

ULTRA™ Series Ventilation Fans are engineered to be the fastest, easiest, most universal installation in remodel, retrofit and new construction—in any type of joist or truss system. Exclusive features simplify room-side installation to save valuable time and money.

For energy saving options see ULTRA GREEN on page 12

RDFU PREMIUM RADIATION DAMPER FOR ULTRA GREEN™ AND ULTRA PRO™ FANS.

When the air temperature passing through the damper exceeds 165°F the fusible link melts, triggering the thermal fabric to automatically close across the damper. Airflow is interrupted by a flame and heat barrier, preventing the rapid spread of fire to other areas.

- Motor serviceable without disturbing drywall
- Galvanized steel frame
- High temperature, non-asbestos, reinforced fiber thermal fabric
- Stainless steel closure springs
- 165°F fusible link
- Use the same grille provided with the ULTRA™ Series fan
- Use Model RDFU with RDJUMPU for ULTRA Green™ and ULTRA Pro™ models with lighting and/or sensing
- UL Standard 555C Classified



THE PERFECT SOLUTION TO MEET TODAY'S CONTINUOUS VENTILATION REQUIREMENTS.

Built for easy installation in either new construction or retrofit applications, the ULTRA Green™ Series makes it simple to ventilate any room in the house. In today's tightly built homes, unhealthy pollutants and excess humidity stay trapped inside unless they are mechanically vented away. Exclusive ULTRA Smart™ DC Motor and Control Technology enables fans to maintain their powerful operation—even at high static pressures—and provide required air movement levels for whole-house ventilation, all while meeting spot ventilation needs on demand. Continuous CFM levels can be precisely adjusted to meet the specific needs of each home.

- HVI certified at <0.3 Sones, ULTRA Silent™ Sound Technology provides the quietest sound rating obtainable
- 50, 80 or 110 CFM
- Intermittent and continuous ventilation
- ULTRA Smart™ DC Motor and Control Technology monitors performance and adjusts motor speed to ensure rated air movement
- ENERGY STAR® certified
- ULTRA Quick™ Installation Technology saves time with the fastest, easiest, most universal installation
- XB and ZB models feature 6" ducting—50 and 80 CFM models include an optional 6" to 4" duct reducer
- Bright, energy efficient 36 watt fluorescent lighting
- UL Listed for use over bathtub or shower when connected to a GFCI protected branch circuit
- Type IC
- Fits 2" x 8" ceiling construction
- Optional RDFU Premium Radiation Dampener Kit available for all XB and ZB models.
- Models XB50, XB80, ZB50 and ZB80 feature QStream Technology



XB50 | XB80 | XB110 | ZB80 | ZB110
FANS

XB110H | ZB110H
HUMIDITY SENSING FANS

ZB80M | ZB110M
MOTION SENSING FANS

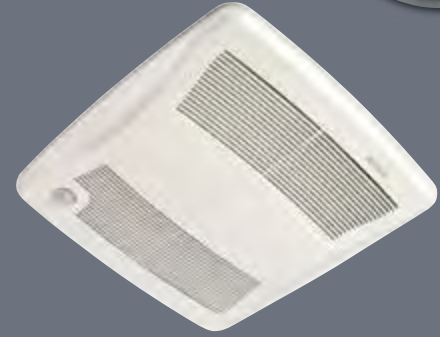
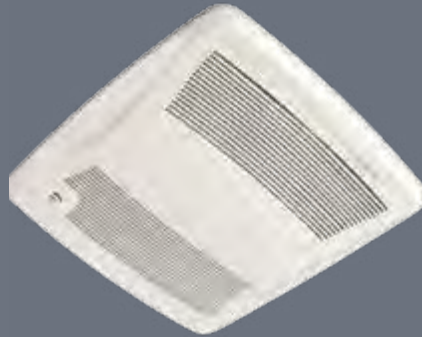
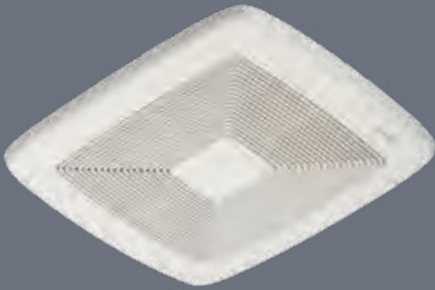

XB50L | XB80L | XB110L | ZB80L | ZB110L
FAN/LIGHTS

XB110HL | ZB110HL
HUMIDITY SENSING FAN/LIGHTS

ZB80ML | ZB110ML
MOTION SENSING FAN/LIGHTS

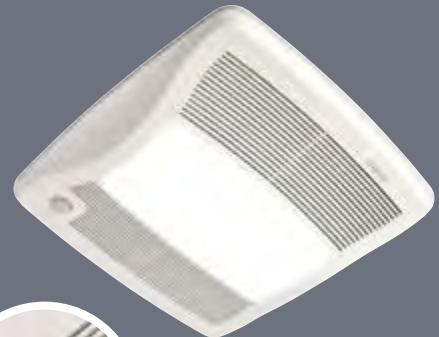
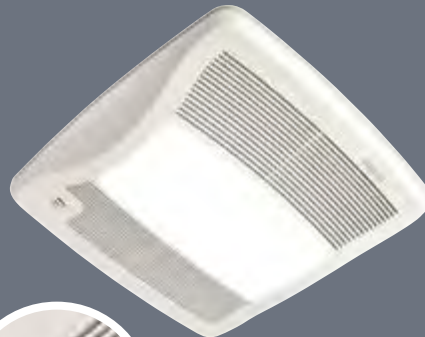
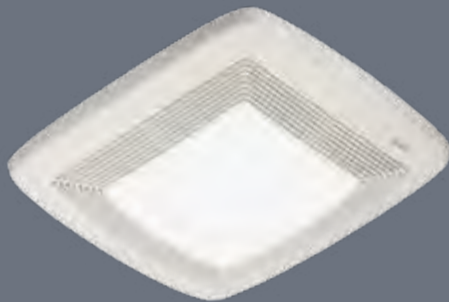

Humidity Sensing



Motion Sensing

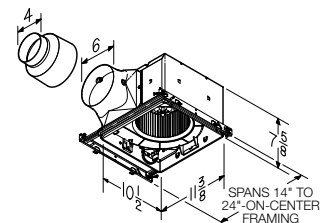

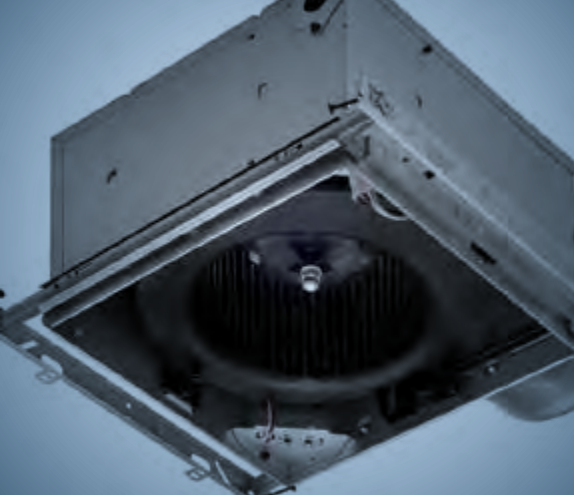

ULTRASMART™ DC MOTOR AND CONTROL TECHNOLOGY

To virtually ensure full-rated performance—regardless of the ducting situation—ULTRA Green™ Series fans automatically monitor and adjust CFM output. For continuous ventilation needs, multi-speed models may be precisely set as low as 30 CFM to avoid costly over-ventilating. A second dial controls runtime at maximum CFM. Our DC motor is the most efficient in our line—80 CFM models use only 5.8 watts.

POWERFUL MOTION & SENSING TECHNOLOGIES

ULTRA Fans with Sensaire humidity sensing technology detect the rapid rise in humidity at the ceiling level. This means that they will react to shower humidity much faster than competitive fans or wall controls. Multi-speed models turn the fan speed up from the lower continuous CFM level. Single-speed models turn the fan on automatically.

ULTRA Fans with motion sensing and multi-speed capability automatically turn the fan up to maximum speed from the lower continuous setting when motion is detected which is ideal for family members who forget to turn the fan on.

ULTRASILENT™ SOUND TECHNOLOGY

ULTRA Green™ Series Ventilation Fans are HVI certified at a remarkable <0.3 Sones; the quietest sound rating obtainable. A dynamically balanced DC motor mounted behind the wheel, a state-of-the-art blower that reduces turbulence, and a free-flowing 6" duct outlet opening that won't inhibit airflow make it possible. There's no quieter fan available.

ULTRA GREEN™ SERIES FANS SAVE UP TO 10 HERS POINTS AND UP TO \$200 PER YEAR IN OPERATING COST.*

Model	CFM	Sones	Light/Night Light	Humidity Sensing	Motion Sensing	Ducting	Grill Dimensions (in)		ENERGY STAR®
							L	W	
Single-speed Fans									
XB50	50	<0.3	—	—	—	6" to 4" reducer	13	13¾	Yes
	50	<0.3							
XB80	80	<0.3	—	—	—	6" to 4" reducer	13	13¾	Yes
	80	0.3							
XB110	110	<0.3	—	—	—	6"	13	13¾	Yes
XB110H	110	<0.3	—	Yes	—	6"	13¾	14	Yes
Single-speed Fan/Lights									
XB50L	50	<0.3	2- 18W GU24 / 4W	—	—	6" to 4" reducer	13	13¾	Yes
	50	<0.3							
XB80L	80	<0.3	2- 18W GU24 / 4W	—	—	6" to 4" reducer	13	13¾	Yes
	80	0.3							
XB110L	110	<0.3	2- 18W GU24 / 4W	—	—	6"	13	13¾	Yes
XB110HL	110	<0.3	2- 18W GU24 / 4W	Yes	—	6"	13¾	14	Yes
Multi-speed Fans									
ZB80	80	<0.3	—	—	—	6" to 4" reducer	13	13¾	Yes
	80	0.3							
ZB80M	80	<0.3	—	—	Yes	6" to 4" reducer	13¾	14	Yes
	80	0.3							
ZB110	110	<0.3	—	—	—	6"	13	13¾	Yes
ZB110H	110	<0.3	—	Yes	—	6"	13¾	14	Yes
ZB110M	110	<0.3	—	—	Yes	6"	13¾	14	Yes
Multi-speed Fan/Lights									
ZB80L	80	<0.3	2- 18W GU24 / 4W	—	—	6" to 4" reducer	13	13¾	Yes
	80	0.3							
ZB80ML	80	<0.3	2- 18W GU24 / 4W	—	Yes	6" to 4" reducer	13¾	14	Yes
	80	0.3							
ZB110L	110	<0.3	2- 18W GU24 / 4W	—	—	6"	13	13¾	Yes
ZB110HL	110	<0.3	2- 18W GU24 / 4W	Yes	—	6"	13¾	14	Yes
ZB110ML	110	<0.3	2- 18W GU24 / 4W	—	Yes	6"	13¾	14	Yes

ENERGY STAR® fans use 70% less energy, on average, than standard models and may qualify for local utility rebates



* Compared to a central fan-integrated system when used for continuous ventilation; based on software calculations and analysis conducted by Broan-NuTone.

QFLOW™ TECHNOLOGY MEANS SMOOTHER AIRFLOW AND OPTIMAL BACKDRAFT SEALING.

QFlow™ Damper Technology. Patent-pending QFlow technology helps achieve desired building airtightness scores when the fan is off. It also removes the duct damper flap from the airstream path, reducing static pressure and noise when the fan is on.

FAN OFF

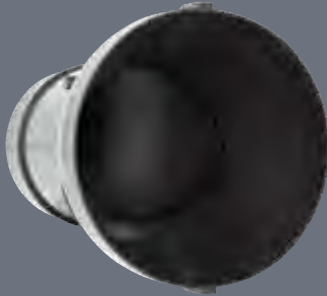

Without QFlow, outdoor air can intrude past the damper edges.

With QFlow, outdoor air intrusion is blocked with its edge-to-edge design.

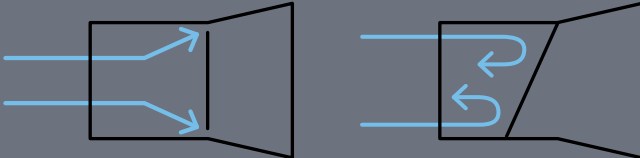

FAN ON

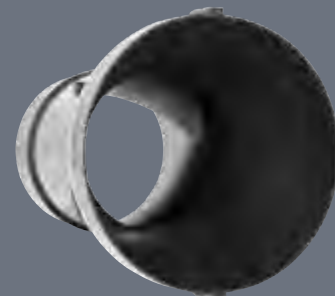

Pre-installed screws in the mounting frame enable quick installation

Without QFlow, the flap impedes airflow which increases static pressure, turbulence and noise.

With QFlow, the flap lifts out of the way, minimizing turbulence for more quiet operation.

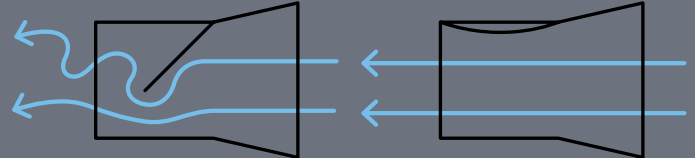

REDUCE SOUND LEVELS AND IMPROVE SOUND QUALITY IN REAL-WORLD INSTALLATIONS.



SOUND TECHNOLOGY

The innovative, patent-pending QStream™ technology utilizes airflow-smoothing baffles that reduce turbulence which means the blower can turn more slowly and quietly—without airflow loss.*

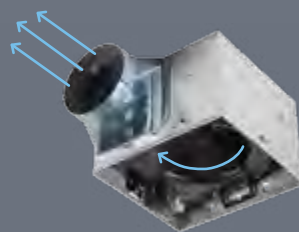

With QStream™ Technology

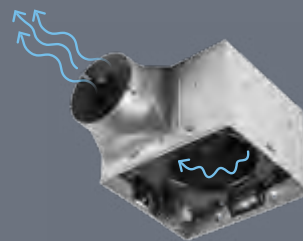

Without QStream™ Technology

ULTRAQUICK™ INSTALLATION TECHNOLOGY

ULTRA™ Series Ventilation Fans are engineered to be the fastest, easiest, most universal installation in remodel, retrofit or new construction—in any type of joist or truss system. Exclusive features simplify room-side installation to save valuable time and money.

Inside/outside wiring capability provides flexible new or retrofit installation

Pre-installed screws in the mounting frame enable quick installation

Vertical positioning tabs ensure the housing is in the right place

The expandable mounting frame adjusts from 14"-24" and fits any type of joist, I-joist or truss construction

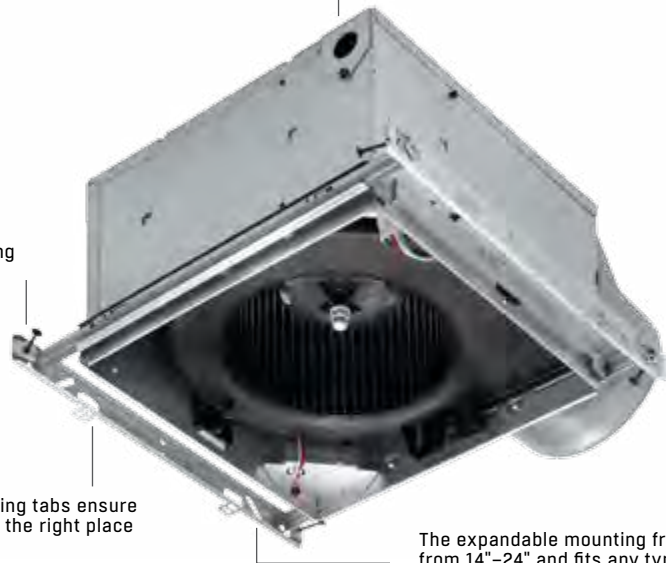

ULTRA PRO FEATURES

- Provide your customers extremely quiet operation with innovative sound reduction technologies.
- QStream™ technology features airflow-smoothing baffles to reduce turbulence.
- Optional RDFU Premium Radiation Damper Kit available for RB models.

The preferred install choice for professionals to deliver quiet performance



RB80 | RB110

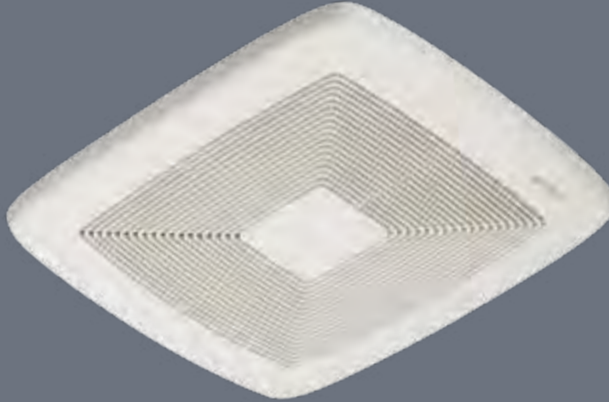

RB80L | RB110L

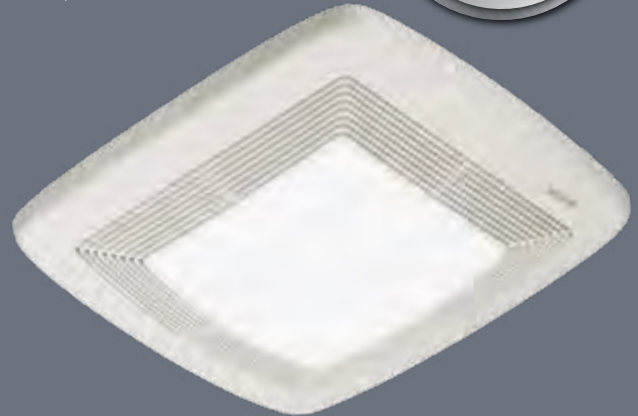

Ultra Pro Series

Model	Duct Size	CFM	Sones	Light/Night Light	Housing Dims (in)			Grille Dims (in)		Grille Finish	UL Listed for Tub/Shower Use	ENERGY STAR®
					W	L	H	L	W			
Single-Speed Fans												
RB80	4"	80	<0.3	—	11 ³ / ₈	10 ¹ / ₂	7 ⁵ / ₈	13	14	White Polymeric	Yes	Yes
RB110	4"	110	0.6	—	11 ³ / ₈	10 ¹ / ₂	7 ⁵ / ₈	13	14	White Polymeric	Yes	Yes
Single-Speed Fan/Lights												
RB80L	4"	80	<0.3	2- 18W GU24 / 4W	11 ³ / ₈	10 ¹ / ₂	7 ⁵ / ₈	13	13 ³ / ₄	White Polymeric	Yes	Yes
RB110L	4"	110	0.8	2- 18W GU24 / 4W	11 ³ / ₈	10 ¹ / ₂	7 ⁵ / ₈	13	13 ³ / ₄	White Polymeric	Yes	Yes

ENERGY STAR® fans use 70% less energy, on average, than standard models and may qualify for local utility rebates





BROAN QT SERIES

SO QUIET, YOU MIGHT EASILY FORGET

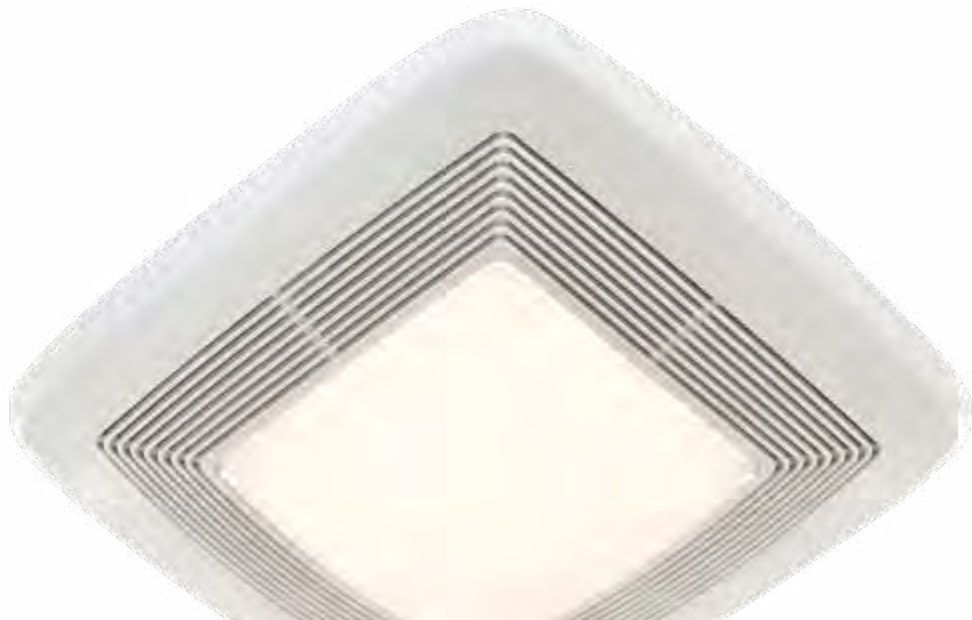



IT'S ON.

PEACEFUL MOMENTS CAN BE ENJOYED EVEN MORE WITH VENTILATION FROM A QUIET, QT SERIES FAN.

The very quiet Broan QT Series is the ideal solution for any room that benefits from ventilation. Most QT models operate at less than one sone—the sound of a quiet running refrigerator. But quiet operation doesn't mean less power. Installed properly, the QT Series maintains full-rated airflow in real-world installations. So choose a QT Series bath fan, fan/light or heater/fan/light for your application. Broan has the perfect solution for every room.

QTXE FAN FEATURES

- Very quiet operation 0.3 to 1.4 sones
- 80 CFM to 150 CFM
- QTXE features 6" ducting for superior performance
- QTXE models are ENERGY STAR® certified
- HVI Certified
- QTXE includes hanger bar system for fast, flexible installation for all types of construction
- Motor engineered for continuous operation
- UL Listed for use over bathtub or shower when connected to a GFCI protected branch circuit
- Fits 2" x 8" ceiling construction
- Radiation damper available separately, see page 19

QTXE

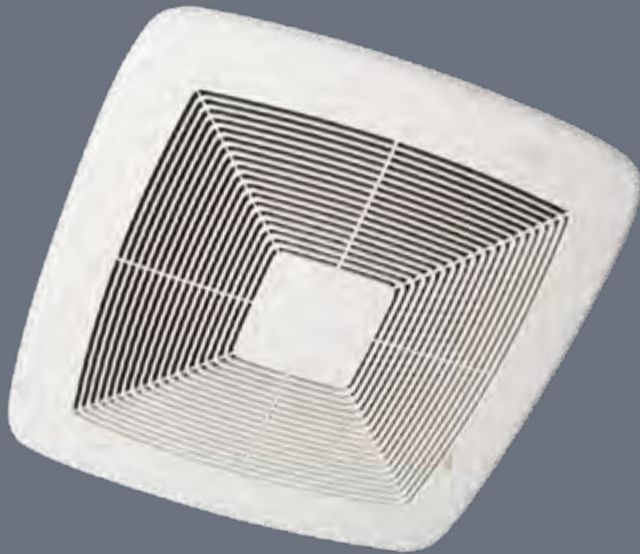

QTXE150

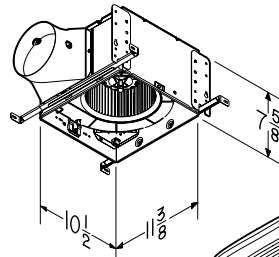

QTXE080, QTXE110

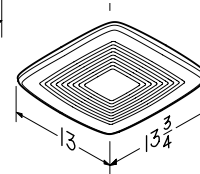
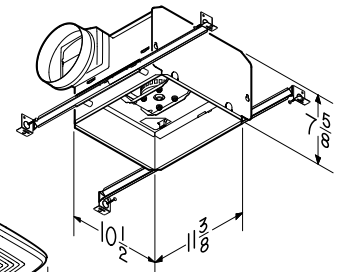

Broan QT Series™ Bath Fans. A bath fan needn't call attention to itself, especially when you don't want it to overpower the design of your bath or powder room. More important, it shouldn't call attention to itself when it's working. So we developed the QT Series™ to provide very relaxing ventilation. With an energy efficient option, it simply does its job quietly, in every sense of the word.

Model	CFM	Sones	Lighting	Bath Sq. Ft.	Ducting	ENERGY STAR®
QTXE080	80	0.3		75	6"▲	Yes
QTXE110	110	0.7		100	6"▲	Yes
QTXE150	150	1.4		140	6"▲	Yes
QTXE080FLT	80	0.3	36W♦ / 4W*	75	6"▲	Yes
QTXE110FLT	110	0.7	36W♦ / 4W*	100	6"▲	Yes
QTXE150FLT	150	1.4	36W♦ / 4W*	135	6"▲	Yes

ENERGY STAR® fans use 70% less energy, on average, than standard models and may qualify for local utility rebates

▲ See page 54 for 6" ducting (DT6W) product specifications

♦ 2, 18 watt GU24 based fluorescent bulbs included

* Night-light bulbs not included



QTXE FAN/LIGHT FEATURES

- Very quiet operation 0.3 to 1.4 sones
- 80 CFM to 150 CFM
- QTXE models feature 6" ducting for superior performance
- QTXE models are ENERGY STAR® certified
- Bright, energy efficient 36 watt fluorescent lighting (2, 18 watt GU24 based bulbs) included with non-sensing QTXE and QTRE models
- QTXE includes hanger bar system for fast and flexible installation for all types of construction
- 4 watt night light on all models (bulb not included)
- Motor engineered for continuous operation
- UL Listed for use over bathtub or shower when connected to a GFCI protected branch circuit
- HVI Certified

- Type IC
- Fits 2" x 8" ceiling construction
- Radiation damper available separately, see below

QTXE

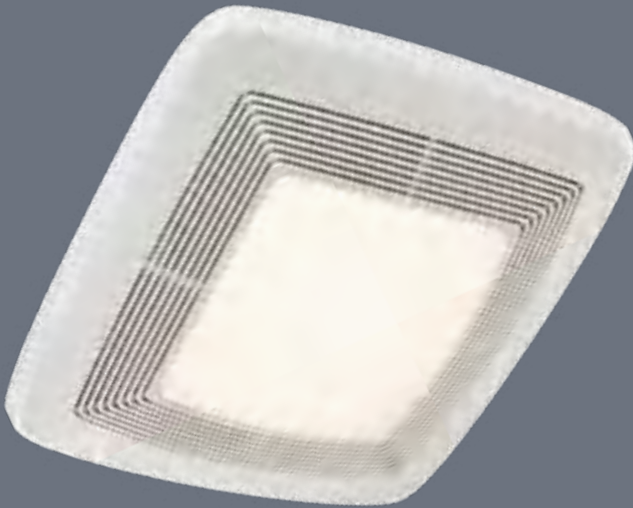

QTXE150FLT

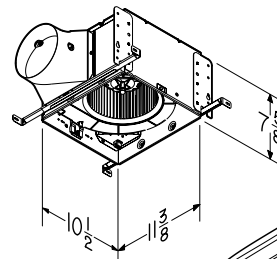

QTXE080FLT, QTXE110FLT

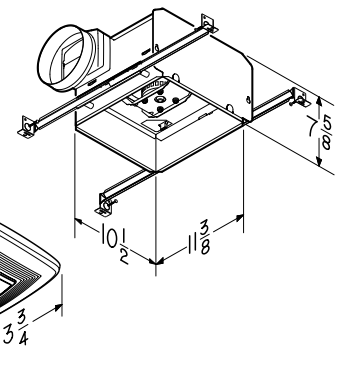

Broan QT Series™ Fan/Lights. The QT Series™ is the ultimate bath fan solution for today's homes. Select a QT Series™ fan/light to bring simple elegance to any bath or powder room. By sight or by sound, you'll barely notice a QT Series™ fan. Except, of course, when you need just the right amount of ventilation and light at the touch of a switch.

PREMIUM RADIATION DAMPERS FEATURES

- Motor serviceable without disturbing drywall
- Galvanized steel frame
- High temperature, non-asbestos, reinforced fiber thermal fabric
- UL Standard 555C Classified
- Stainless steel closure springs
- 165°F fusible link
- Use the same grille provided with the QT Series™ fan

Premium Radiation Dampers. When the air temperature passing through the damper exceeds 165°F the fusible link melts, triggering the thermal fabric to automatically close across the damper. Airflow is interrupted by a flame and heat barrier, preventing the rapid spread of fire to other areas.

RDFQF | RDFQL



Radiation Dampers	Description
RDFQF	For QTXE080 & QTXE110
RDFQL	For QTXE080FLT & QTXE110FLT
RDFQL plus RDJUMPQ	For QTXE110S

Humidity Sensing Fans with Sensaire® Technology.

Broan Sensaire® technology is a hands-free solution to fighting excess humidity and possible mold problems. It detects rapid increases in moisture levels at the ceiling, where steam and humidity naturally rise, and automatically turns the fan on.

With fans this quiet, we included automatic shutoff to save worry, and money. Broan Sensaire® technology is a perfect solution for high traffic bathrooms, the kids' bathroom, or for anyone who leaves the house before humidity is properly vented.

QTXE110S

INVENT AE80S | AE110S

INVENT AE80SL | AE110SL

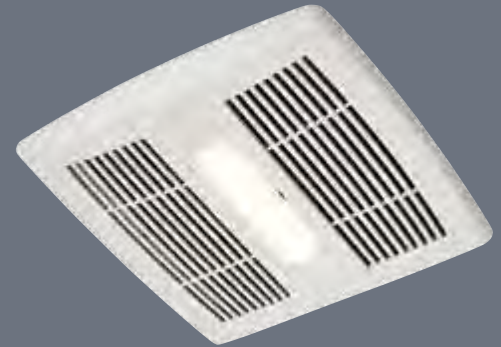
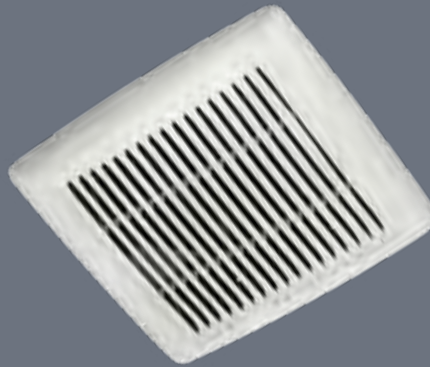
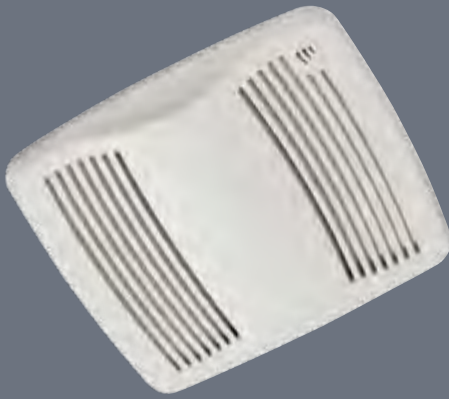

QTXE11S

AE80S, AE110S

AE80SL, AE110SL

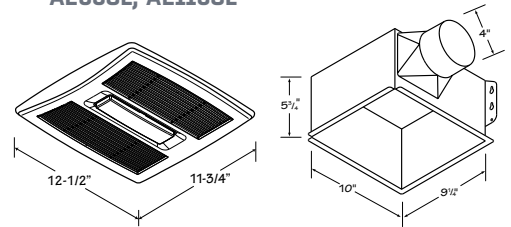
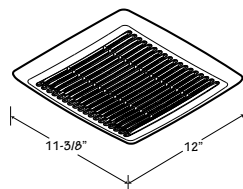
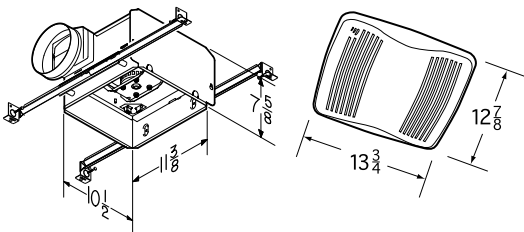

SENSAIRE® HUMIDITY SENSING FEATURES

- Detects a rapid rise in humidity
- User adjustable sensitivity control
- Easy to set shut off timer ranges from 5–60 minutes
- UL listed for use over bathtub and shower when connected to a GFCI protected branch circuit
- Energy Star Certified
- HVI Certified RDM1 radiation damper accessory for InVent Series

QTXE HUMIDITY SENSING FAN FEATURES

- Grille mounted humidity sensor for faster reaction time
- Fits 2" X 8" ceiling construction
- RDFQF radiation damper with RDJUMP accessory
- Includes hanger bar system for fast and flexible installation for all types of construction

INVENT HUMIDITY SENSING FAN AND FAN/LIGHT FEATURES

- FoldAway™ mounting ears for a 100% room side installation
- Efficient LED Lighting
- Fits 2" X 6" construction

Model	CFM	Sones	Bath Sq. Ft.	Lighting	Ducting	ENERGY STAR®
QTXE110S	110	0.7	100	—	6"▲	Yes
AE80S	80	0.8	75	—	4"	Yes
AE110S	110	1.0	100	—	4"	Yes
AE80SL	80	0.8	75	11 watt LED	4"	Yes
AE110SL	110	1.0	100	11 watt LED	4"	Yes

ENERGY STAR® fans use 70% less energy, on average, than standard models and may qualify for local utility rebates

▲ See page 54 for 6" ducting (DT6W) product specifications



INVENT SENSING FAN PROJECT PACKS

A000HFS PROJECT PACK



Simplify Installation with Project Packs.

Project Packs are available with four fan housings. When drywall work and painting is finished, the fan components needed to complete the job are available in a finish pack kit under a separate model number which includes the motor plate, motor, wheel and grille. See the matrix below for Project Pack order information.

Project Pack	Kit number	For model
Four-pack of FAN housings only:	A000HFS	
Four-pack finish kits for FAN models:	AE80F	AE80S
	AE110F	AE110S

AE80F | AE110F FINISH KITS



SMARTSENSE® VENTILATION SYSTEM

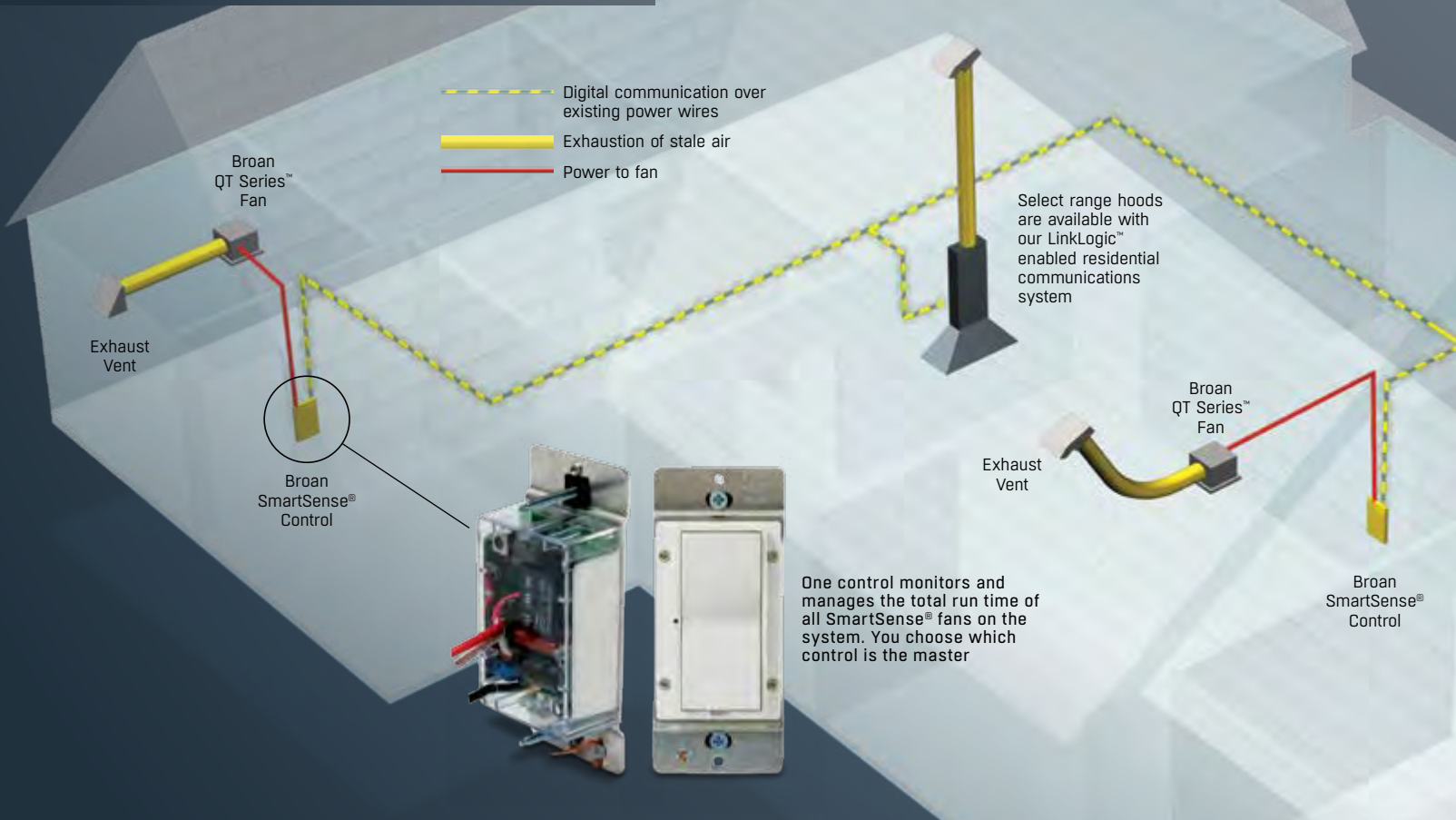

BROAN SMARTSENSE® AUTOMATICALLY COORDINATE YOUR BATH FANS

RDFQF



RDFQF PREMIUM RADIATION DAMPER FEATURES.

When the air temperature passing through the damper exceeds 165°F the fusible link melts, triggering the thermal fabric to automatically close across the damper. Airflow is interrupted by a flame and heat barrier, preventing the rapid spread of fire to other areas.

A SMART, ECONOMICAL OPTION TO MEET ASHRAE STANDARD 62.2.

Since most homes have several ventilation fans, Broan SmartSense[®] automatically operates your fans to ventilate your home around the clock. It's one solution for continuous and spot ventilation requirements.

A SmartSense[®] system coordinates ventilation fans in various locations to introduce fresher, healthier air. It may be programmed to ventilate based on the home's size, automatically cycling different fans based in the dwelling based on square footage and the number of bedrooms. LinkLogic control is at the heart of the system and requires no separate control wiring. SmartSense[®] is cost effective as it does not require integration with the home's air handler, and with only one fan running at a time, it uses less than 40 watts during ventilation cycles.

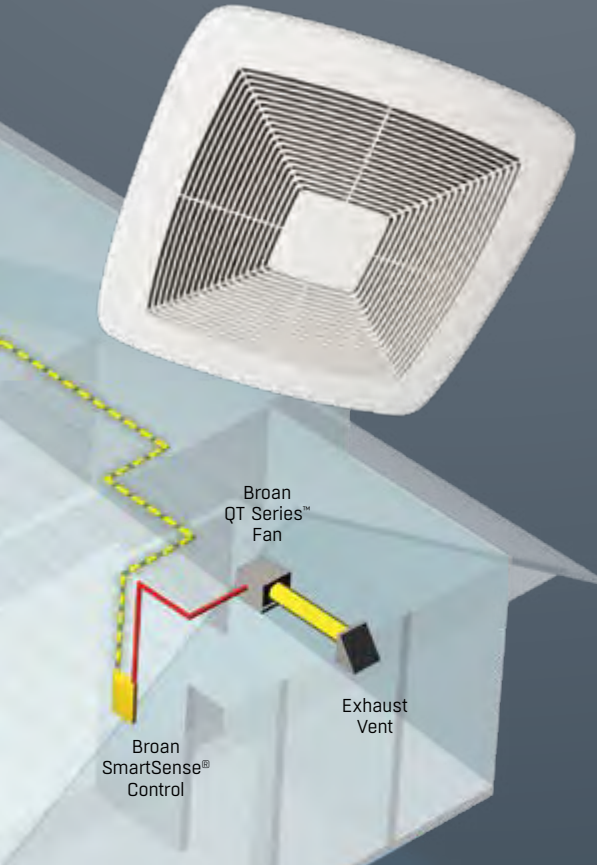

Model	CFM	Dimension
SSQTXE080	80	11 ³ / ₈ x 10 ¹ / ₂ x 7 ⁵ / ₈
SSQTXE110	110	11 ³ / ₈ x 10 ¹ / ₂ x 7 ⁵ / ₈



Wireless home control technology powered by INSTEON™.

- New timed-off and delayed-off features with new firmware
- Automatically operates the SMD series Make-Up Air Damper for installations requiring make-up air
- Interfaces with other LinkLogic[®] enabled products by Broan[®] or BEST[®]

AND RANGE HOOD TO VENTILATE YOUR HOME.

A BROAN AUTOMATIC MAKE-UP AIR DAMPER INTELLIGENTLY BRINGS FRESH AIR INSIDE.

The damper communicates with SSQTXE080 and SSQTXE110 fans as well as select BEST[®] and Broan range hoods to form a complete balanced ventilation system that ensures fresh air is available while ventilation is in process. This ensures balanced indoor air pressure while preventing unwanted air infiltration and wasted energy. SmartSense[™] automatically operates the Make-Up Air Damper for installations requiring make-up air.

Easy Installation

- Located in a 6-inch or 8-inch duct running between an exterior wall fresh air inlet (641FA or 643FA) to an interior location such as a cold-air return or supply duct
- Locally powered by a 24 VAC transformer
- Communicates over existing home electrical wiring

Broan Make-Up Air Damper features:

- Heavy-duty galvanized steel construction
- 24 VAC transformer
- 6-inch round (SMD6), 8-inch round (SMD8)
- Use with any single fan or combination of SSQTXE080 or SSQTXE110 fans

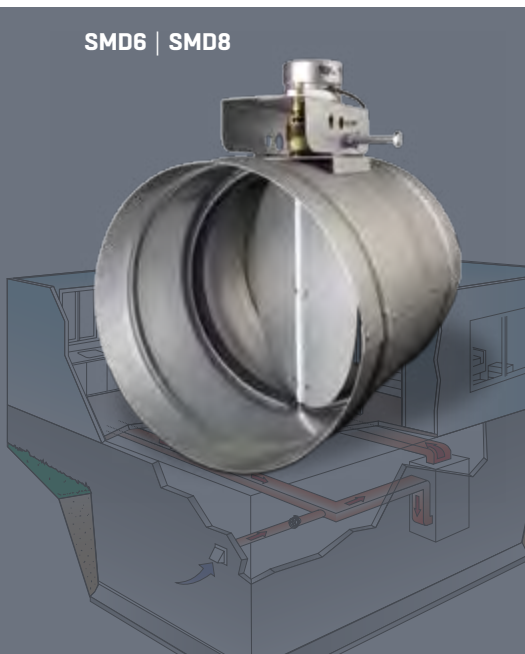

FLEXIBILITY FOR



NEW CONSTRUCTION AND

INVENT SERIES FANS WITH TRUESEAL™ DAMPER TECHNOLOGY CAN SAVE UP TO 1 HERS POINT AND UP TO \$9 PER YEAR IN OPERATING COSTS*.

FoldAway™ Mounting Ears are precisely positioned for new construction and fold flat for room-side retrofits. Every installation can be handled more efficiently.



With our TrueSeal™ Damper Technology, InVent fans reduce air leakage by up to 50% compared to competitive models¹; resulting in better home performance via blower door tests.



EzDuct™ Connector enables room-side installation without attic access. Attach the housing, pull the duct through, attach the EzDuct™ Connector and reset it with one screw.



*Compared to competitive fans; based on software calculations and analysis conducted by Broan-NuTone. Testing reflects total fan housing air tightness.

¹See Broan.com/InVent for details.



ROOM-SIDE RETROFIT FROM ONE FAN.

VERSATILE INSTALLATION. AIRTIGHT PERFORMANCE. LED LIGHTING.

InVent Series gives professionals smart options for new construction or room-side retrofits in one, hard-working product line. InVent is about innovations such as FoldAway™ mounting ears and TrueSeal™ Damper Technology that improves building airtightness like never before. With fresh grille designs and a full range of operating points, there's an InVent Series solution for every installation.

InVent™ SERIES

LED Lighting offers greater energy efficiency and longevity, and adds a unique design detail to this hard-working fan. 11 watt, 800 Lumens integrated LED module lasts up to 25,000 hours.



INVENT FAN & FAN/LIGHT FEATURES

AE50, AE80, AE110, AE80B, A80, A80HD, A110

- FoldAway™ mounting ears allow for easy installation in both new construction and room-side replacement
- New TrueSeal™ damper technology forms a tighter seal to reduce backdrafts

- EzDuct™ Connector allows room-side installation with no attic access required
- Effective ventilation clears humidity and odors
- Attractive grille styling

AE80L, AE80BL, AE110L

- LED Fan/Light with 11 watt, 800 Lumens, 3000K, 80 CRI integrated module
- LED lasts up to 25,000 hours for maintenance-free convenience

A50L, A70L, A80L, A110L

- Incandescent Fan/Light with A19 Base (bulb not included)

AE50 | A80 | AE80 | AE80B | A110 | AE110

AE80L | AE80BL | AE110L

A50L | A70L | A80L | A110L

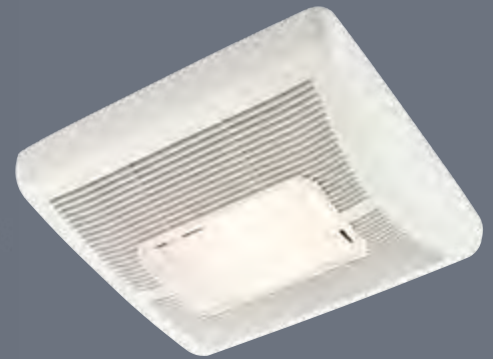
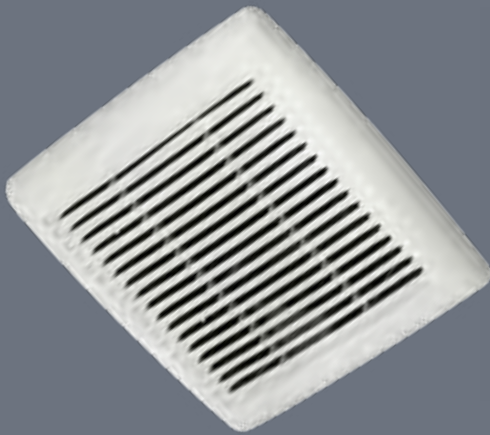

AE50, A80, AE80, AE80B, A110, AE110

AE80L, AE80BL, AE110L

A50L, A70L, A80L, A110L

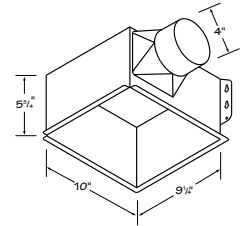
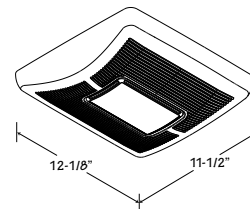
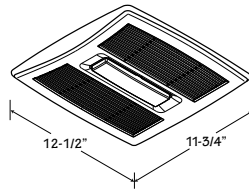
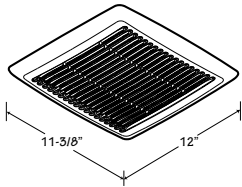

INVENT Fan Models

Model	CFM	Sones	ENERGY STAR®
A80	80	2.0	No
A80HD*	80	2.0	No
A110	110	3.0	No
AE50	50	0.5	Yes
AE80	80	0.8	Yes
AE80B	80	1.5	Yes
AE110	110	1.3	Yes

ENERGY STAR® fans use 70% less energy, on average, than standard models and may qualify for local utility rebates



*Metal Grille

INVENT Fan/Light Models

Model	CFM	Sones	Lighting	ENERGY STAR®
A50L	50	1.5	A19 Base**	No
A70L	70	2.0	A19 Base**	No
A80L	80	1.0	A19 Base**	No
A110L	110	1.3	A19 Base**	No
AE80BL	80	1.5	LED	Yes
AE80L	80	0.8	LED	Yes
AE110L	110	1.3	LED	Yes

ENERGY STAR® fans use 70% less energy, on average, than standard models and may qualify for local utility rebates



**Bulb Not Included

INVENT™ SERIES ACCESSORIES

A range of accessories ensures a custom fit in any application. Choose optional duct connectors, a radiation damper and a metal grille for commercial installations, and hanger bars for exact positioning.

With our QFlow™ Duct Connector (MODEL MQF4), InVent fans reduce air leakage by up to 65% compared to competitive models¹, offering an extremely tight seal when closed and completely open airflow when open.

RDM1 RADIATION DAMPER for fans and ENERGY STAR fan/lights only

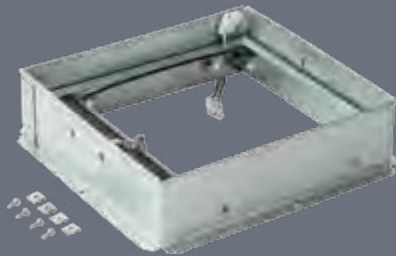

MQF4 DUCT CONNECTOR



MMG METAL GRILL

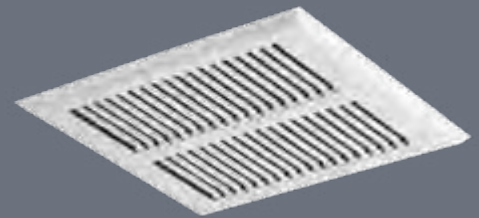

MHB4 HANGER BARS

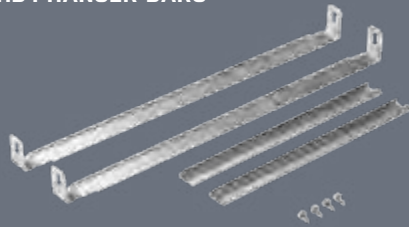

MMD4 METAL DUCT CONNECTOR



Broan InVent™ Series Project Packs. Keep your job on schedule and your inventory safe. Even if the final fan or fan/light product has not been selected, a project pack enables you to install a fan or fan/light housing now and choose the right-sized finish pack later. You won't have an open box on the job site with a motor and grille that could be lost or damaged.

INVENT Fan Finish Packs

Model	CFM	Sones	ENERGY STAR®
A80F	80	2.0	No
A80HDF*	80	2.0	No
A110F	110	3.0	No
AE50F	50	0.5	Yes
AE80BF	80	1.5	Yes
AE80F	80	0.8	Yes
AE110F	110	1.3	Yes

ENERGY STAR® fans use 70% less energy, on average, than standard models and may qualify for local utility rebates



*Metal Grille

INVENT Fan/Light Finish Packs

Model	CFM	Sones	Lighting	ENERGY STAR®
A70LF	70	2.0	A19 Base**	No
AE80BLF	80	1.5	LED	Yes
AE80LF	80	0.8	LED	Yes
AE110LF	100	1.3	LED	Yes

ENERGY STAR® fans use 70% less energy, on average, than standard models and may qualify for local utility rebates



**Bulb Not Included

INVENT Housing Packs

Model	Description
A000HF	Fan Housing
A000HL	Fan/Light Housing

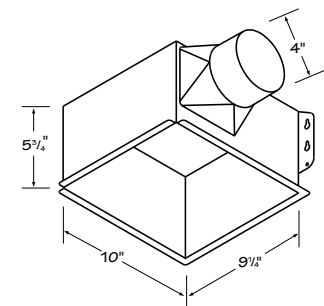

¹Testing reflects total fan housing air tightness. See Broan.com/InVent for details.



A WELL VENTILATED ROOM IS A

HEALTHIER



LOOK TO BROAN, THE VENTILATION EXPERTS, TO KEEP EVERY ROOM OF YOUR HOUSE FRESH.

Broan engineers the right product to fit every application, room size and need. Select from a variety of features that best meet your spot ventilation needs. Begin by assessing how powerful the fan should be or whether you could use additional lighting in your space. Think about what product style, finish or shape would look best. Rest assured, if you're concerned about saving money and energy, Broan bath fans that feature ENERGY STAR® can reduce energy consumption by as much as 70%. Broan has the perfect product designed around your needs.



Wall or ceiling mount, LoProfile is the right fan for a tight fit. The new Broan LoProfile™ Fan is our latest solution for installations where conventional ventilation simply won't fit. Where multi-family applications require it, the LoProfile™ fan is narrow enough to be installed in a wall between 2x4 studs. When plumbing or electrical obstructions are found behind the drywall in ceiling remodel applications our LoProfile™ fan can still fit without having to move anything. And that means most any room with space constraints can have powerful, quiet, efficient ventilation.

ROOM.



LP80

The oval connector accepts standard 4" duct, or 3" duct with the supplied adapter

Electrical connections can be made through the top or the side of the housing

LOPROFILE™

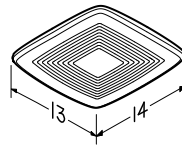
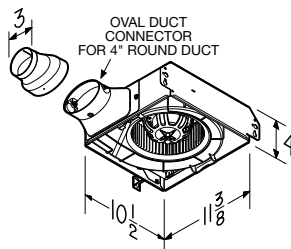

Model	CFM	Sones	ENERGY STAR®
LP80	80	1.0	Yes

ENERGY STAR® fans use 70% less energy, on average, than standard models and may qualify for local utility rebates



FEATURES

- Fits in 2x4 ceiling or wall construction
- 80 CFM with 4" duct ensures ample air movement; 70 CFM with 3" duct reducer
- >50 CFM at 0.25" static pressure meets ASHRAE 62.2 local ventilation requirements (with 4" oval duct or 3" round duct)
- Only 1.0 sones for quiet operation (4" duct)
- 4" oval or 3" round duct connection for installation flexibility
- Efficient operation lowers utility bills
- Ideal for multi-family applications
- Compatible with RDF1 Premium Radiation Damper
- Project Packs available

RDF1

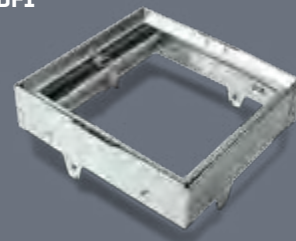

FAN/LIGHT FEATURES

657, 696

- Powerful centrifugal blower
- White polymeric grille complements virtually any décor
- A19 base lighting (bulb not included)
- Ceiling mount

750, 751

- Powerful centrifugal blower
- Round design eliminates squaring with walls
- Model 751 is the same as Model 750, but without a night light
- A19 base lighting (bulb not included)
- Ceiling mount

678, HD80L

- White polymeric grille complements virtually any décor
- Ceiling mount
- Project Packs available
- HD80L designed for continuous operation

CEILING & WALL MOUNT FEATURES

670, 671, 688, 689

- Compact housing fits between ceiling joists or wall studs
- Metal grille kits (available separately)
- Project Packs available for most models

657 | 696



750 | 751



678 | HD80L



670 | 671 | 688 | 689

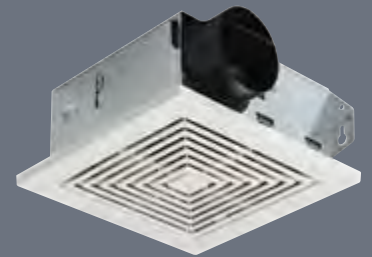

657, 696

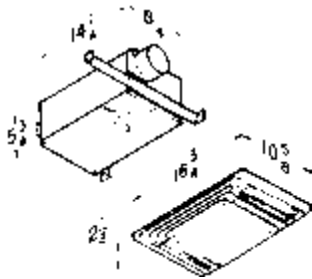

750, 751

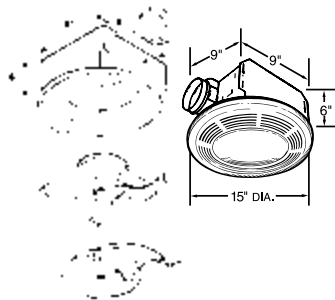

678, HD80L

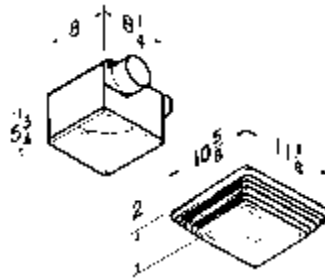

670, 671, 688, 689

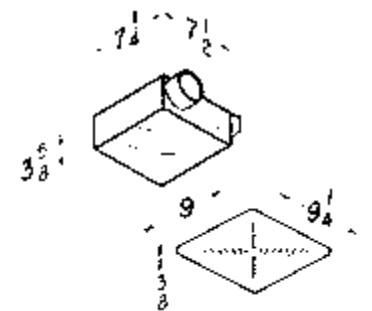

Model	CFM	Sones	Light/Night Light	Ducting
657	70	4.0	A19 Base	4"
696	100	4.5	A19 Base	4"
750	100	3.5	A19 Base / 7W	4"
751	100	3.5	A19 Base	4"
678	50	2.5	A19 Base	4"
HD80L	80	2.5	A19 Base	4"

Model	CFM	Sones	Ducting	Mounts
670	50	3.5	3"	Wall / Ceiling
671	70	6.0	3"	Wall / Ceiling
688	50	4.0	3"	Wall / Ceiling
689	60	5.5	3"	Wall / Ceiling

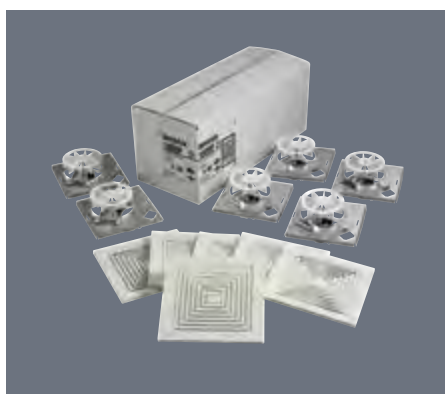

Project Packs. Convenient options for today's contractor. Broan "H" Packs include rough-in housings only, making multi-unit installation more convenient. "F" Packs allow motor/blower and grille assemblies to be ordered separately, nearer project completion, to help avoid losing, damaging or having to store components.

690 BATH FAN UPGRADE KIT

The Broan bath fan upgrade kit lets you convert your old bath fan to a brand new unit in just 10 minutes. Improve performance, reduce the sound level, and upgrade the appearance of your economy fan in minutes.

- Cut sound levels up to 50%
- Boost air movement up to 20%
- 10 minute installation
- 60 CFM, 3.0 Sones
- Modern white grille
- No special tools needed

690

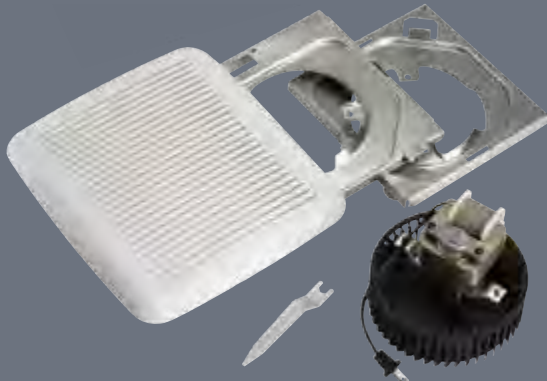

Included: Grille; two motor plates, depending on your fan model; wrench; quieter plug-in fan motor



1. Remove old grille



3. Attach new fan and new motor plate. Install into existing housing





2. Remove old fan assembly





4. Install new grille

Measure your existing fan housing to ensure proper fit

For use only with these bath fan models.*		Measurements	Yes	No
	NuTone 693, 695, 696N	7½" x 7¼"	•	
		8" x 7¼"	•	
	Broan 670, 671, 688, 689	7½" x 7¼"	•	
		8" x 8¼"		•
	Nautilus N671, N688	7½" x 7¼"	•	
		8" x 8¼"		•

*No other usage has been tested or authorized by Broan-NuTone LLC.

Broan 690 Upgrade Kit replaces the models below

If your grille looks like this:	The fan is very likely one of these models:	Housing dimensions:
	NuTone 693, 695, 696N	7½" x 7¼" or 8" x 7¼"
	Broan 670, 671, 688, 689 Nautilus N671, N688	7½" x 7¼" Not compatible with 8" x 8¼"

682 DUCT FREE FAN

- Patented, fast snap-in metal housing installation
- Fan circulates air past replaceable activated charcoal filter
- Fits 2" x 4" ceiling or wall construction

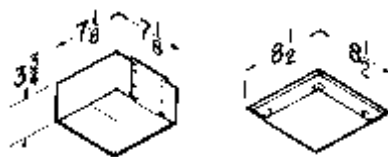

682

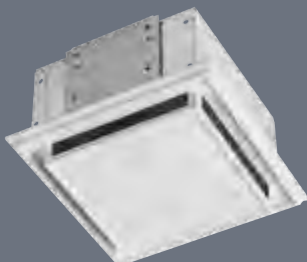

Model	CFM	Sones	Lighting	Notes
682	—	—	—	Duct-free Circulation
S97009563	—	—	—	Replacement filter

Duct-free. This easy-to-install solution is ideal where air circulation is needed but ducting is impossible or impractical. Use it as a solution for half baths or rooms where humidity isn't a concern.

QUALITY VENTILATION THAT COMPLEMENTS YOUR DÉCOR.

Every room needs ventilation, from closets to bedrooms to baths. But adding a fan/light combination that complements or enhances the room décor has been challenging. That's why the Broan Architectural products are perfect. Imagine a fan/light combination fixture that unobtrusively blends into the ceiling. Or a statement fan/light with a stunning LED perimeter glow that showcases your unique décor. The Architectural series helps you meet your decorating challenges without compromising your style.

VENTILATION THAT MOVES IN RATHER

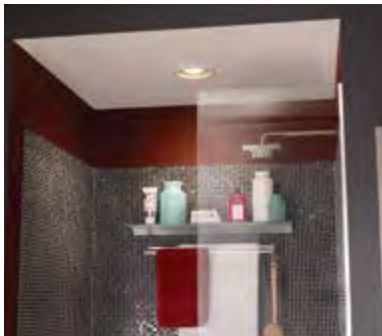



THE AIR, MOVING WAYS.

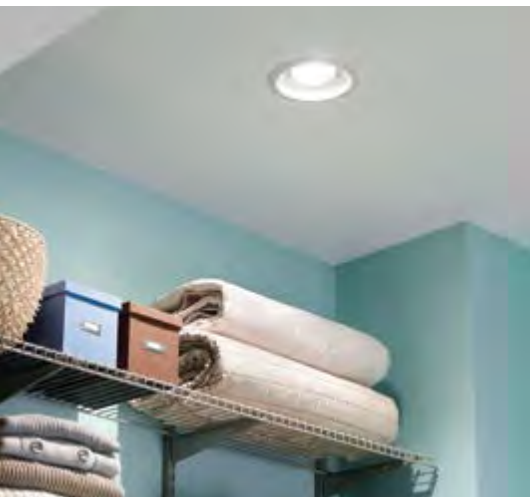
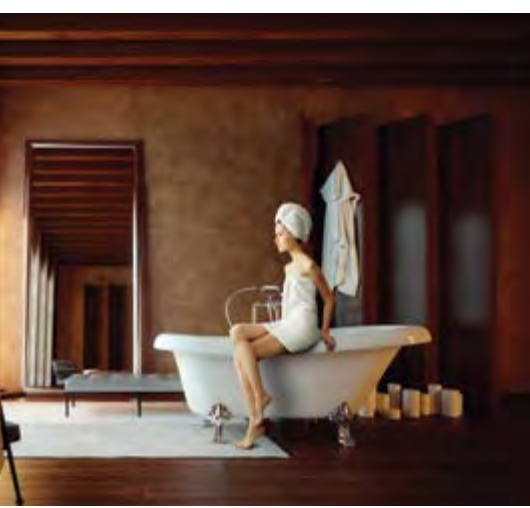
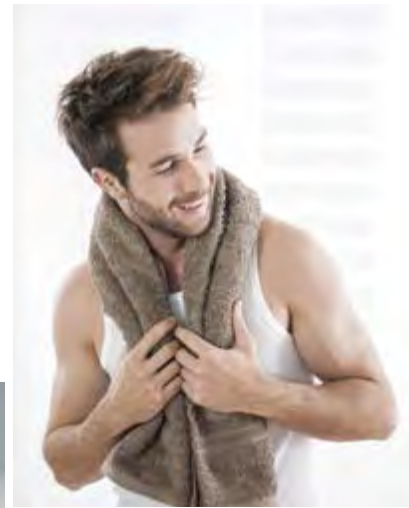

744 SERIES RECESSED FAN/LIGHT FEATURES

- High efficiency centrifugal fan
- 70 CFM at 1.5 sones
- Trim matched to designs of major recessed light manufacturers
- Put multiple units in larger rooms
- Model 744 uses a standard A19 base, 75 watt maximum (R30 or BR30 for standard applications)
- Models 744FL and 744SFL include a 16 watt, GU24 based, R30 shaped CFL bulb (included)
- Model 744LED includes a 10 watt, GU24 based LED bulb (included)
- All models UL Listed for use over bathtub or shower when connected to a GFCI protected branch circuit. Model 744 requires a PAR30L or PAR30LN type bulb (not included)
- 6⁷/₈" high housing appropriate for new construction and 2" x 8" ceiling joists
- 4" round duct connector
- Optional wall control switches available
- Type IC, sealed housing
- Not for use over cooking surfaces

Humidity Sensing Model 744SFL Features

- SensAire® technology detects the rapid rise in humidity and automatically turns the fan on and off
- Humidity is sensed at the ceiling level
- Easily accessible sensitivity adjustment
- Easy-to-set 5–60 minute shut-off timer

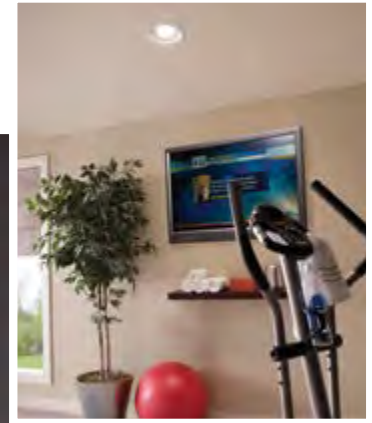
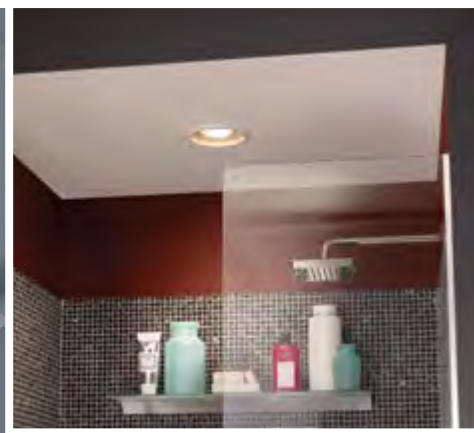

SensAire® technology behind the trim detects changes in humidity and automatically turns the fan on and off

**YOU'D NEVER KNOW
IT'S A FAN, AND THAT'S THE POINT**

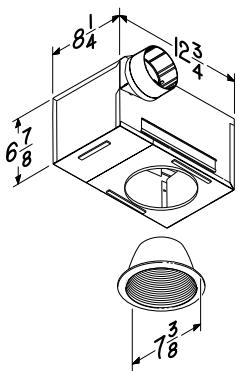

Model	CFM	Sones	Lighting	Humidity Sensing	Ducting	ENERGY STAR®
744	70	1.5	75W MAX	—	4"	—
744FL	70	1.5	16W Fluor.	—	4"	Yes
744LED	70	1.5	10W LED	—	4"	Yes
744SFL	70	1.5	16W Fluor.	Yes	4"	Yes

ENERGY STAR® fans use 70% less energy, on average, than standard models and may qualify for local utility rebates



Broan took recessed lighting a step further by incorporating powerful, quiet ventilation in the same design. These fan/lights disappear into the ceiling and match perfectly with other recessed lights. Models 744, 744FL and 744LED are practical ventilation solutions for any room in the house, such as the utility room, kitchen or high-traffic family room—any space you wish to keep fresh and comfortable. In the bath, Model 744SFL starts automatically when a rapid rise in humidity is detected. You'll never forget to turn the fan on again.

DECORATIVE FAN/LIGHT FIXTURE FEATURES

- 70 or 80 CFM at 2.5 or 3.5 Sones
- Corrosion-resistant finishes
- Beautifully styled glass globes
- Use two 60-watt incandescent candelabra bulbs (not included)
- Plug-in lighting fixture and permanently lubricated motor
- Polymeric blower wheel
- Not UL approved for use over bathtubs or showers
- Sturdy, keyholed mounting brackets for quick, accurate installation
- Fits 2" x 6" ceiling construction
- Tapered, polymeric 4" round duct fitting for easy, positive duct connection and no metallic clatter
- Type IC

FAN WITH SOFT SURROUND™ TECHNOLOGY FEATURES

- LED lasts up to 25,000 hours, nearly eliminating the hassle of bulb replacement
- 9 watt lighting for extreme energy efficiency
- Bright 800 lumen integrated LED light engine for energy efficiency
- 3000K color temperature provides bright, soft light ideal for bathrooms
- Minimum 80 Color Rendering Index (CRI) which meets ENERGY STAR® requirements
- Fits in 2" x 6" ceiling construction
- 110 CFM for strong air movement
- 1.5 sones for quiet operation
- ENERGY STAR® certified
- 4" duct connector balances powerful, quiet operation with easy installation
- UL listed for use over bathtubs and showers when connected to a GFCI protected branch circuit
- Type IC for use in direct contact with thermal insulation

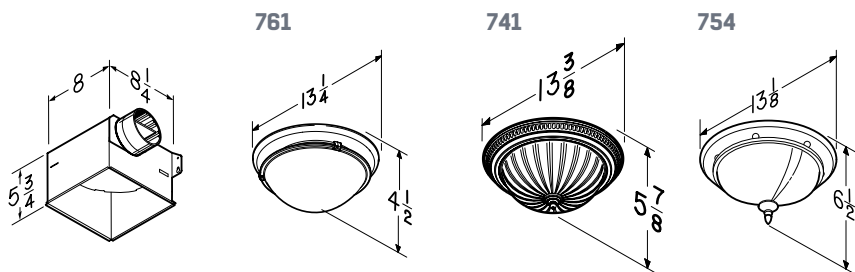

Model	CFM	Sones	Lighting	Bulb Type	Finish	Glass
761BN	80	2.5	2-60W	Candelabra	Brushed Nickel	White Opal
761RB	80	2.5	2-60W	Candelabra	Oil-Rubbed Bronze	Ivory Alabaster
761WHA	80	2.5	2-60W	Candelabra	White	White Alabaster
741SN	70	3.5	2-60W	Standard	Satin Nickel	Frosted
754RB	70	3.5	2-60W	Candelabra	Oil-Rubbed Bronze	White Alabaster

A beautiful balance of elegance and performance.

Now you can ventilate while adding quiet elegance and exceptional design to any room in your home with beautifully styled glass globe lighting. These fan/lights are available in corrosion-resistant decorator finishes.

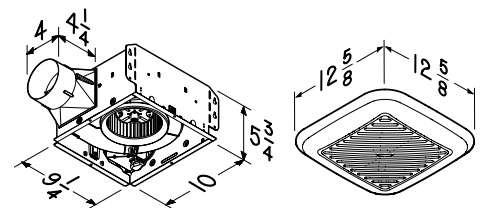

Model	CFM	Sones	Lighting	HVI	Ducting	ENERGY STAR®
791LEDM	110	1.5	9W LED	Yes	4"	Yes

ENERGY STAR® fans use 70% less energy, on average, than standard models and may qualify for local utility rebates





EVERY ROOM CAN BE MORE

COMFORTABLE

WITH A LITTLE VEN



THERE'S A BROAN VENTILATION SOLUTION FOR EVERY ROOM IN YOUR HOME.

Without doubt, every room needs ventilation. That's why our specialty lines deliver clean, fresh air where you need it most—including your bathrooms, laundry room, recreation room, workshop or nursery. Look to our room-to-room, wall/ceiling mount, through-wall or vertical discharge utility fans for powerful spot ventilation. Or, install our remote mounted in-line ventilation system for a quiet whole-house solution. Our recessed fan/lights perfectly match other recessed fixtures, including humidity sensing options that start automatically when a rapid rise in humidity is detected. Elegant, simple, practical and powerful. Exactly what you've come to expect from Broan.

VENTILATION FOR THE *MUSIC FAN*

Quiet Ventilation Fan with Quality Wireless Speakers.

It's your music—out of sight. Unlike wireless speakers that require counter space, Sensonic™ speakers with *Bluetooth*® wireless technology fill your room with rich sound from above. From hard rock to news talk, play any audio through the dual high-fidelity speakers and enjoy entertainment and privacy at the touch of a button.



TILATION.



Speaker also available as an accessory. Quickly and easily add a high-fidelity Sensonic™ speaker to most Broan or NuTone QT Series Ventilation Fans

SENSONIC FEATURES

- Dual High-Fidelity Sensonic™ Speakers
- Brilliant audio performance concealed behind your fan grille
- Play any audio through most *Bluetooth*®-enabled devices
- Effective, extremely quiet ventilation clears humidity and odors quickly
- ENERGY STAR® certified
- UL Listed for use over bathtub or shower when installed with a GFCI protected branch circuit
- Type IC for use in direct contact with thermal insulation
- Fits 2"x 8" ceiling construction
- Includes unique spacer for easy I-joist mounting
- Mounts between joists with optional QTHB1 Hanger Bar Kit (sold separately)

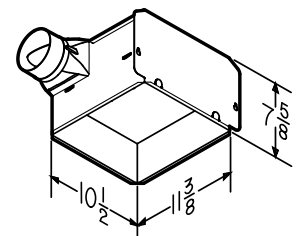

Model	Description	CFM	Sones	Ducting
SPK110	Fan with Speaker	110	1.0	4"
SPKACC	Speaker Accessory	—	—	—



The *Bluetooth*® word mark and logos are registered trademarks owned by Bluetooth SIG, Inc. and any use of such marks by Broan-NuTone LLC is under license.



THROUGH-WALL FANS

- Housing adjusts to fit walls from 4½"-9½" thick
- Specially designed polymeric fan blade
- Built-in damper minimizes backdrafts for energy efficiency
- Paintable polymeric grilles
- Accessorize with wall switch or variable speed wall control
- Louvered exterior wall cap with built-in bird screen
- 6" diameter flexible aluminum duct included

508 (10"), **509/509S** (8")
 • 509S: features an integral ON/OFF rotary switch-no wall switch to wire

512M
 • 6" Through-Wall

12C MOTORDOR®

- 10" Through-Wall
- Separate motor opens and closes the vent door automatically

WALL/CEILING-MOUNT, SIDE DISCHARGE FANS

502, 503

- Installs easily between ceiling joists or wall studs
- Built-in damper prevents backdrafts
- Fits 3¼" x 10" duct

508 | 509 | 509S

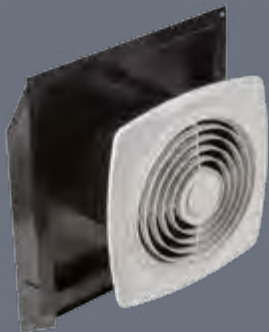

512M



12C MOTORDOR®

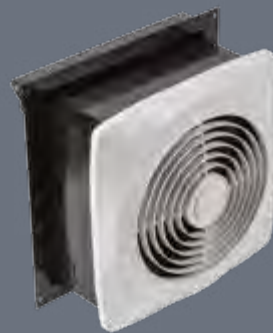

502 | 503

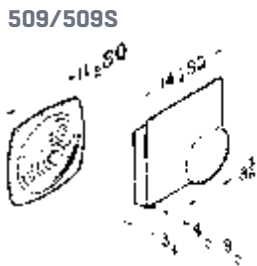
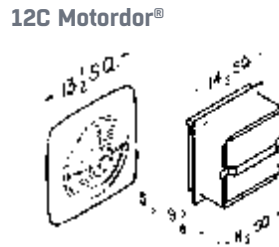
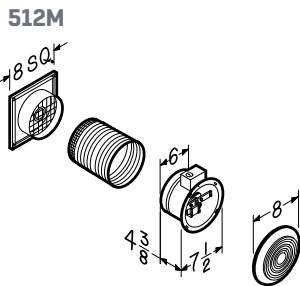
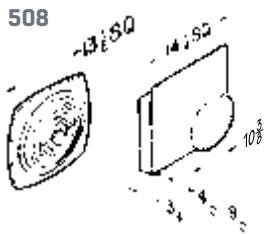
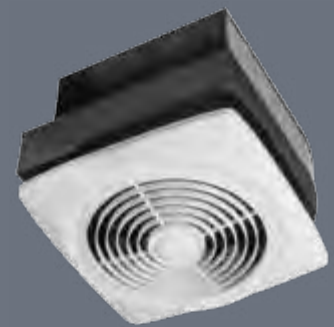

Model	CFM	Sones	Diameter	Sizing Specifications
506	470	8.0	10"	Fits 4½"-9½" thick walls
507	250	7.0	8"	Fits 4½"-9½" thick walls
510	380	6.5	10"	Fits 3"-5½" thick walls
511	180	4.5	8"	Fits 3"-5½" thick walls
502	270	8.0	10"	Fits 3¼" x 10" duct
503	160	5.0	8"	Fits 3¼" x 10" duct
508	270	6.0	10"	Fits 4½"-9½" thick walls
509/509S	180	6.5	8"	Fits 4½"-9½" thick walls 509S Integral ON/OFF Rotary Switch
512	90	3.5	6"	Fits up to 5½" thick walls
512M	70	3.5	6"	Fits up to 5¼"-10" thick walls
12C Motordor®	360	8.0	10"	Fits 5½"-97/8" thick walls
504	350	6.5	10"	Fits 10" round duct
505	180	6.5	8"	Fits 8" round duct
673	60	4.5	6"	Fits 6" round duct

VERTICAL DISCHARGE

- Galvanized steel housing installs easily between ceiling joists
- Steel mounting brackets with keyhole slots for fast installation

504

- 10" vertical discharge
- Fits 10" round duct-use Model 472 transition/damper (available separately) for 8" round duct (performance will be reduced)

505

- 8" vertical discharge with built-in damper
- 8" fan, 8 $\frac{1}{4}$ " diameter housing

673

- 6" vertical discharge with built-in damper
- 6" paintable fan, spin-on, white polymeric grille

CHAIN-OPERATED UTILITY FANS

- Pull-chain opens the door and starts fan
- Housing adjusts to fit walls from 4 $\frac{1}{2}$ "-9 $\frac{1}{2}$ " thick
- Specially designed polymeric fan blade
- Housing features foam-insulated door for energy efficiency

506

- 10" fan (10 $\frac{3}{8}$ " diameter sleeve)

507

- 8" fan (8 $\frac{3}{8}$ " diameter sleeve)

504 | 505

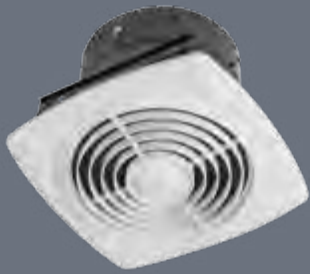

673



506 | 507

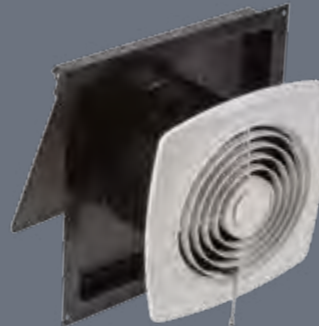

504

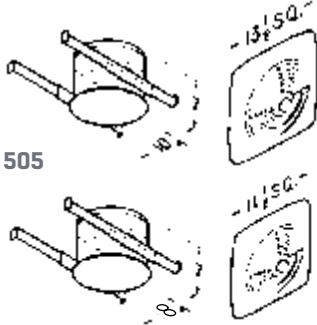

505



673

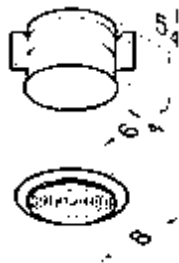

506

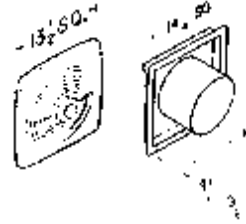

507

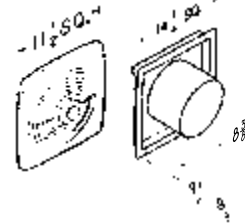

ROOM-TO-ROOM FANS

Room-to-Room ventilators provide quick solutions where more ventilation is needed—without installing new ductwork.

- Built-in variable speed control
- Easy installation through wall 3"-5 $\frac{1}{2}$ " thick
- Permanently lubricated motor
- Paintable white polymeric grilles
- Not for use in kitchens

510, 10"; **511**, 8"

510, 511

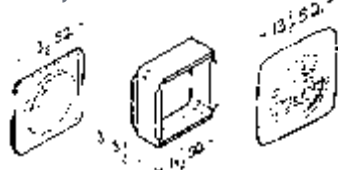

512

- 6" Room-to-Room
- Use 57W or 57V variable speed control separately

512



512

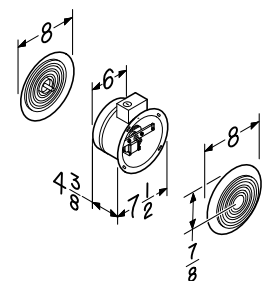

510 | 511

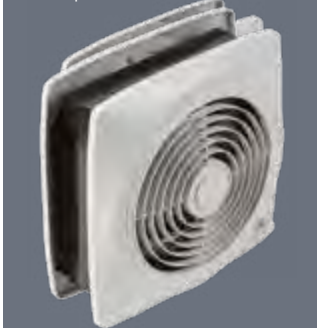

MULTI- AND SINGLE-PORT IN-LINE VENTILATORS FEATURES

- Energy-efficient, permanently lubricated motors
- High pressure centrifugal blowers easily accommodate long duct runs
- Designed for quick, easy installation
- HVI certified and AMCA licensed
- Suitable for intermittent or continuous ventilation applications
- Removable panels offer easy access to the motor without disturbing ductwork
- Plug-in blower simplifies wiring

Multi-Port In-Line Ventilators

- Ventilate multiple bathrooms or other rooms simultaneously
- Great solution for large, open spaces
- Install in virtually any orientation
- 6" round outlet; 4" round inlets (two inlet duct covers included)
- Use 2, 3 or all 4 inlet ports

Single-Port In-Line Ventilators

- Ventilate any room in virtual silence
- 6" round outlet and inlet for easy duct connections

MP100 | MP140 | MP200

MP280

SP100 | SP140 | SP200

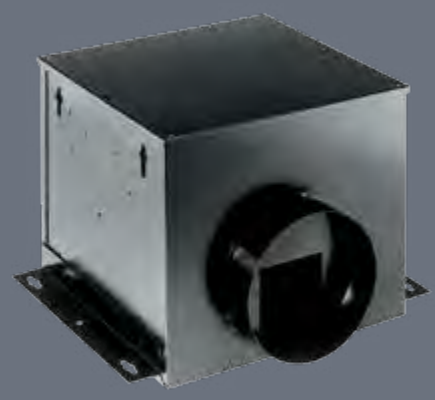

MP100, MP140, MP200

MP280

SP100, SP140, SP200

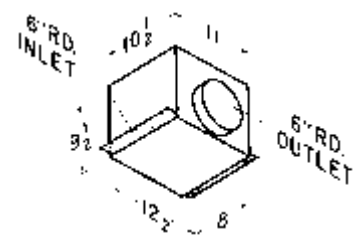
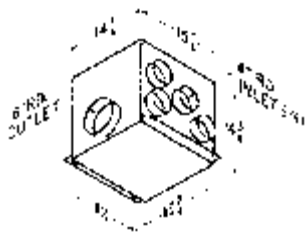
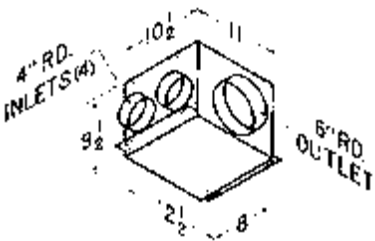

Multi-Port	CFM	Sones	Notes
MP100	110	1.0	Four inlets
MP140	150	1.5	Four inlets
MP200	210	2.0	Four inlets
MP280	290	3.0	Four inlets
SP100	110	1.0	One inlet only
SP140	150	1.5	One inlet only
SP200	210	2.0	One inlet only

HVI rated air flow at 0.2" static pressure. Sound test procedures are similar to HVI tests for other exhaust fans.

Remote Mounted In-Line Ventilation Fans.

Quiet and efficient residential solutions. The concept is simple: mount a high-performance ventilator in an out-of-the-way spot and you get the power with virtually no sound. Install the housing in the attic or the basement, wherever it's most convenient and discrete.

WITH A MULTI-PORT, IN-LINE VENTILATION SOLUTION

the blower is mounted away from the living area for virtually silent operation. Multi-port installations allow ventilation of up to four rooms, or use multiple inlet ports to clear the air in larger rooms. Single-port, in-line ventilators provide the same noise reduction benefits.



CVG4 | CVG6



Room Inlets

- Models available for 6" (CVG6) or 4" (CVG4) round duct
- Install in ceiling or wall
- Paint to match room décor
- Available in six packs only

Accessories

Model	Description	Ducting/Size	Notes
CVG4	Grille Intake	4"	Round Grille
CVG6	Grille Intake	6"	Round Grille
CVLD4	Sleeve	4"	Sleeve with damper
CVLD6	Sleeve	6"	Sleeve with damper
CVL4	Sleeve	4"	Sleeve without damper
CVL6	Sleeve	6"	Sleeve without damper
FY6	Y Adapter Only	6" x 6" x 6"	



INSTANT HEAT, RIGHT WHEN YOU NEED IT AND ONLY WHERE YOU NEED IT

POWERFUL HEATING, LIGHT AND VENTILATION AT THE TOUCH OF A SWITCH.

No matter where you live your house can become chilled. Maybe it's early fall before the furnace is on, or maybe the cool desert nights mean colder rooms. And there's certainly one room you never want to be chilly—the bathroom. Whether it's taking a morning shower, or relaxing in a whirlpool at the end of a long day, your family appreciates a warm, comfortable bathroom. Broan heater/fan/lights are the perfect solution. You have instant heat to quickly warm up the room, a quiet ventilation fan to remove excess humidity and a convenient light—all in one fixture. Each one can be operated separately, or they can be used simultaneously when needed, no furnace required.



ED IT.
WANT IT.

QT SERIES FEATURES

- Efficient PowerHeat™ heater design
- Choice of standard A19 base (2, 60 watt) lighting (bulbs not included) or energy-efficient 36 watt GU24 fluorescent (bulbs included)
- Fan motor is engineered for continuous operation
- HVI Certified
- Type IC
- Requires a dedicated 20 amp circuit
- Switches sold separately
- 7 watt night-light bulb not included

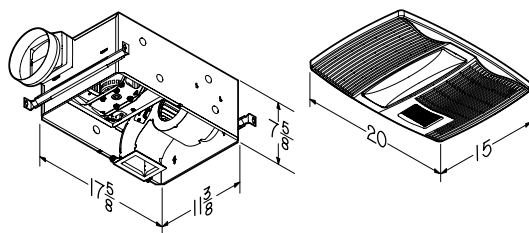

PowerHeat™ is a Broan design that maximizes heat output per watt. With the heater element close to the forced air exit grille, the internal components are not heated. Heat is delivered into the room and does not escape into the ceiling or attic space.



Heater/Fan/Light

Model	CFM	Sones	Bath Sq Ft.	Lighting/ Night Light	Heater Watts	Ducting
QTX110HL	110	0.9	100	Std. A19 Base (2- 60W)** / 7W**	1500	6"
QTX110HFLT	110	0.9	100	36W Fluorescent (2- 18W)* / 7W**	1500	6"

*Bulbs included
**Bulbs not included



DIRECTIONALLY ADJUSTABLE HEATER/FAN LIGHT FEATURES

- Heater/Fan/Light brings convenient, comforting warmth to your bathroom
- Quiet, high-output heater with exclusive directionally adjustable design (see below)
- 4" ducting for new construction or retrofit
- Multi-function wall switches sold separately
- Choice of Standard A19 base or energy-efficient 27 watt GU24 (bulb included) fluorescent lighting
- Fan motor is engineered for continuous operation
- HVI Certified
- Type IC
- Requires a dedicated 20 amp circuit
- Fits 2" x 6" ceiling construction

100HL | 100HFL

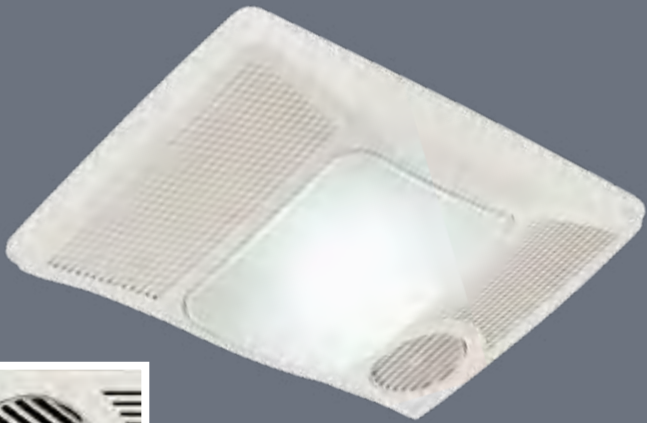

100HL, 100HFL

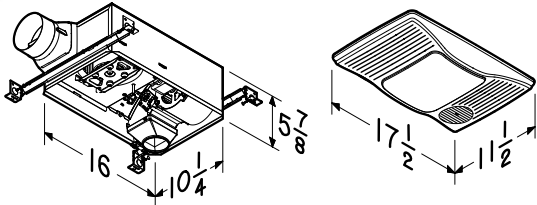

Heater/Fan/Lights

Model	CFM	Sones	Bath Sq Ft.	Lighting	Heater Watts	Ducting
100HL	100	2.0	90	Std A19 Base	1500	4"
100HFL	100	2.0	90	27W GU24 Fluorescent	1500	4"

Broan Directionally-adjustable Heater/Fan/Lights.

With our 360° directionally-adjustable heat outlet, you're assured the heat will end up exactly where you need it.



HEATER/FAN & HEATER/FAN/LIGHT FEATURES

- Designer white polymeric grilles complement virtually any décor
- 1300 watt heaters
- Fan, light and heater function independently or together
- Type IC
- Fits 2" x 6" ceiling construction
- Two- or three-function wall controls are available separately
- **655:** 20-amp circuit required
- **659:** 15-amp circuit required
- **656:** Heater/Light Only, 15-amp circuit required
- **658:** Heater/Fan, 15-amp circuit acceptable

655 | 656 | 659

658



655, 656, 659 Grille

658 Grille

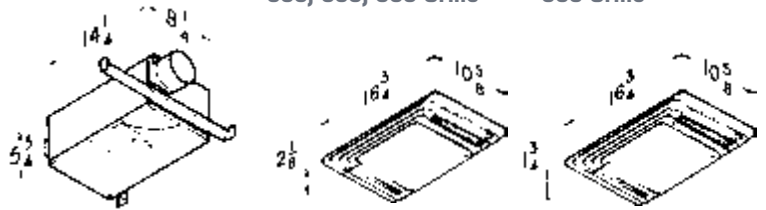

Heaters & Heater Fans

Model	CFM	Sones	Lighting	Ducting	Heater
655	70	4.0	Std A19 Base	4"	1300W
656	—	—	Std A19 Base	—	1300W
658	70	4.0	No Light	4"	1300W
659	50	2.5	Std A19 Base	4"	1300W

BULB HEATER/FAN FEATURES

- Quiet, highly efficient polymeric blower wheels
- Polymeric dampers prevent backdrafts and eliminate mechanical noise
- Polymeric 4" round duct connectors with tapered sleeves simplify ducting
- Operate fan and heater independently or together
- Attractive white polymeric grilles
- Compact steel housings with adjustable mounting brackets with keyhole slots that span up to 24"
- 250 watt R40 or BR40 size infrared bulbs (not included)
- Type IC, UL Listed for 60°C wiring (retrofits)
- **162:** One-Bulb Heater/Fan
- **164:** Two-Bulb Heater/Fan, Two-function control (available separately)

ONE OR TWO-BULB HEATERS—NO FAN

- Infrared bulbs deliver energy-saving warmth
- Get instant comfort in the bathroom without turning up the central thermostat
- 250 watt R40/BR40 size infrared bulbs (not included)
- Attractive, white polymeric grilles
- Compact steel housings
- Adjustable mounting brackets with keyhole slots span up to 24"
- **161:** One-Bulb Heater, UL Listed for 75°C wiring
- **163:** Two-Bulb Heater, Type IC

162

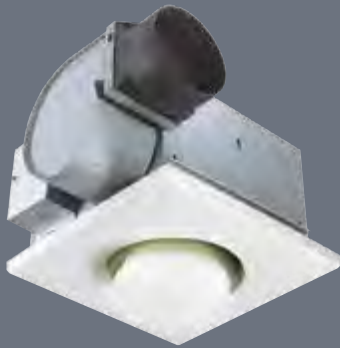

164



161



163



162

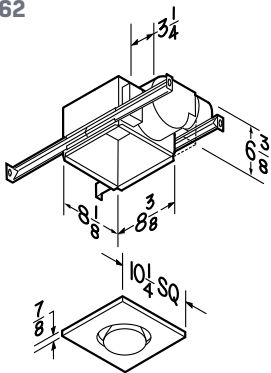

164

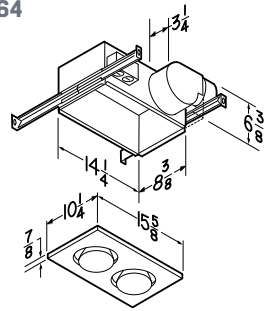

161

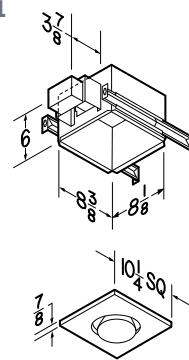

163

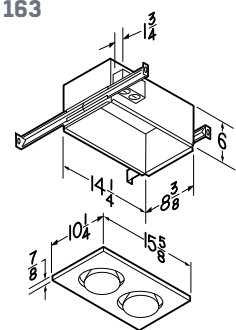

Bulb Heater Fans. Silent warmth and superior ventilation. Trust Broan Bulb Heater/Fans and Bulb Heaters for energy-saving warmth and instant comfort without ever having to touch your central thermostat. These units deliver superior performance and excellent ventilation in a compact package.

Bulb Heater/Fan & Bulb Heaters

Model	CFM	Sones	Bulb Watts
162 ¹	70	4.0	250
164 ¹	70	4.0	500
161 *	—	—	250
163	—	—	500

*NOT IC RATED
¹ HVI certified

PULL THE HEAT OUT OF YOUR ATTIC. PUT MONEY BACK IN YOUR WALLET.

Prevent heat and moisture build-up. In summer, attics can reach 150°F or more, warming your living area, increasing the air-conditioning load, and adding to your energy bill. In winter, ice dams can result, and moist air can condense causing mildew, rotting wood and wet insulation. Year-round attic ventilation ensures a cooler, drier attic that can extend roof life by preventing rot, premature aging and shingle distortion. A cooler attic extends the life of your air conditioner and lowers air conditioning expense.



How Much Ventilation Do You Need? Effective ventilation requires air to exit at or near the peak of the roof with replacement air drawn through soffit venting and louvers. The Home Ventilating Institute (HVI) recommends at least 10 air changes hourly to equalize temperature. Determine your attic ventilation needs below, or try the [Attic Ventilation Calculator at broan.com](http://broan.com).

DETERMINE YOUR VENTILATION NEEDS

1. Calculate the volume of your attic, in cubic feet, depending on the style of your home's roof.

 **Attic Volume for Gable Roof:**
Volume = Length x Width x Height x 1/2

 **Attic Volume for Hip Roof:**
Volume = Length x Width x Height x 1/3

2. Attic Volume x 10 Air Changes per Hour = Total Cubic Feet per Hour of ventilation recommended.

3. Total Cubic Feet per Hour 60 Minutes/Hour = Cubic Feet Per Minute (CFM) of Ventilation Recommended.

Example: Average Gable Attic Volume = $58\frac{3}{4}' \times 29' \times 7\frac{1}{4}' \times \frac{1}{2} = 6,176$ Cubic Feet
6,176 Cubic Feet x 10 Air Changes/Hour = 61,760 Cubic Feet/Hour ÷ 60 Min./Hour = 1,029 CFM

4. Replacement air is drawn through vents in your soffit. To determine the minimum soffit vent area required (in square inches) multiply the total CFM of your powered ventilator(s) by 0.48. This number is the total square inches of soffit venting required by your powered ventilator(s).

Example: 1,029 CFM x 0.48 = 494 Square Inches of soffit vent area recommended

ACCESSORIES

433



For use with Broan Models 353, 35316, 34560BK or 34560WW.

433 Automatic Shutter for Gable Mount Attic Ventilators

- Feature counter-balanced aluminum vanes that automatically open and close when the ventilator turns on and off
- Better air flow than stationary attic louvers
- Extruded aluminum frame fits flush with outside wall
- Weather-tight closure
- Easy to install

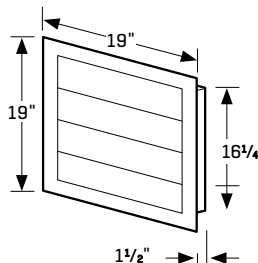

DH100W Humidistat

- Sold separately for use with all Broan powered attic ventilators. Humidistats automatically turn on the fan when moisture in the attic is detected



Model 73

- High Temperature Cut-off sold separately for use with all Broan powered attic ventilators. High temperature controls automatically turn off the ventilator at 204°F



• For additional switches see page 52-53

ROOF MOUNT, POWERED ATTIC VENTILATION



GABLE MOUNT, POWERED ATTIC VENTILATION

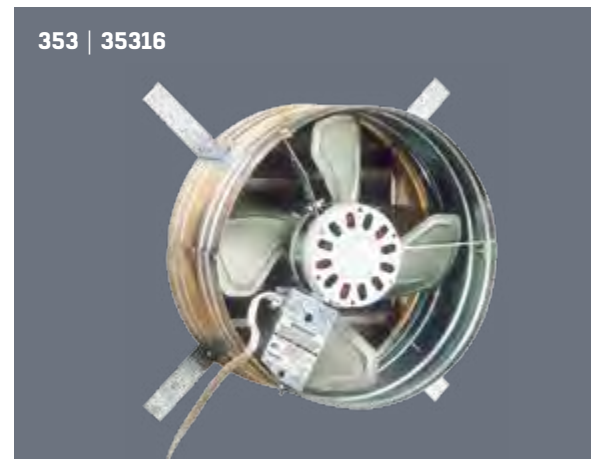

Powered Attic Ventilation Specifications

Model	Attic Sq Ft	AMPS	CFM*	RPM	Height	Diameter	Dome Material	Color
Roof Mount								
349BR	Up to 1400	4	1000	1050	9"	24½"	Painted Steel	Dark Brown
350BR 350BK	Up to 1500	3.6	1050	1000	8"	23¼"	PVC	Brown/Black
355BR 355BK	Up to 1715	4.3	1200	1050	8"	23¼"	PVC	Brown/Black
356BR 356BK	Up to 2285	8.0	1600	1500	8"	23¼"	PVC	Brown/Black
358	Up to 1715	4.3	1200	1050	8"	23¼"	Aluminum	Silver
Gable Mount								
353†	Up to 1460	3.4	1020 / 760**	1030	—	—	—	—
35316†	Up to 2285	3.9	1600 / 1160**	1420	—	—	—	—



DETERMINING THE CFM* REQUIREMENTS FOR YOUR ATTIC

Gable Mount Ventilators

Roof Pitch	8/12 or Less		9/12		12/12		15/12	
	Standard Louver	433 Louver	Standard Louver	433 Louver	Standard Louver	433 Louver	Standard Louver	433 Louver
Light Colored Roof Square Footage								
353	1085	1460	1015	1360	570	765	355	385
35316	1658	2285	1549	2135	870	200	559	770
Dark Colored Roof Square Footage								
353	950	1275	880	1185	500	670	315	425
35316	1442	1985	1347	1855	757	1055	486	670

Numbers in charts are attic square footage that fan can ventilate.

Roof Mount Ventilators

Roof Pitch	CFM	8/12 or Less	9/12	12/12	15/12
Light Colored Roof Square Footage					
349BR	1000	1490	1180	782	501
350BR, 350BK	1050	1500	1399	790	508
355BR, 355BK	1200	1715	1600	900	575
356BR, 356BK	1600	2285	2135	1200	770
358	1200	1715	1600	900	575
Dark Colored Roof Square Footage					
349BR	1000	1290	1200	684	427
350BR, 350BK	1050	1304	1219	694	430
355BR, 355BK	1200	1495	1390	790	505
356BR, 356BK	1600	1985	1855	1055	670
358	1200	1495	1390	790	505

† Model 433 Automatic Shutter Accessory sold separately. See page 46.

*Exhaust capacity HVI certified @ .03" static pressure.

**Higher CFM with Model 433 shutter. Lower CFM with standard wood louvre. The Home Ventilating Institute (HVI) recommends 1 sq. ft. of open air inlet per 300 CFM of fan capacity. The best location for these air intake vents is under the eaves with direct access to the attic. Vents for gable installations should be placed at the end of the house opposite the installed ventilator. Failure to provide these intakes could cause natural-draft gas appliances to backdraft.

VENTILATE YOUR ATTIC WITH THE POWER OF THE SUN.



Surface Mount—345SOBK and 345SOWW

For most roofs, our one piece SPAV is the perfect solution. Because our solar cells are highly efficient at capturing the sun's energy, there is no need for unsightly raised panels or tracking systems. Instead, what you see is a low profile ventilator in a contoured design that integrates well with the roof.

Curb Mount—345CSOBK and 345CSOWW

Identical in design to the Surface Mount unit but with an added lip for flat, tiled, or unusually steep roof installations. A Curb Mount installation requires the fabrication of a simple curb box frame made from treated 2x4s to create a solid platform and better manage water runoff.

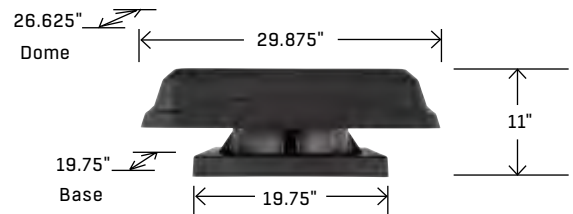
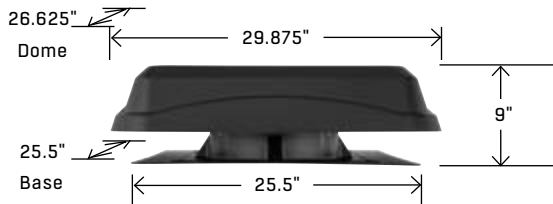

Solar Panel Integrated, low profile, 28 watt Solar Panel efficiently captures sunlight from dawn to dusk without the unsightly props or pivoting stands used by some manufacturers. Rugged, tempered glass withstands large hail and resists delaminating.

Housing Attractive, low profile, molded design, of UV-stabilized, color-dyed, rugged ABS plastic withstands impact from hail and resists fading. May also be painted to match roof color for installation flexibility.

Motor Direct-current, variable speed 17 volt motor is dynamically balanced for superior performance and silent operation.

Fan 12" Diameter, one-piece aluminum 5-blade, fan pitched for maximum air flow.

Hardware Stainless steel fasteners secure galvanized steel brackets and aluminum, heavy gauge screen for durability and corrosion resistance. Screen keeps out insects, animals, and birds without impeding airflow.

Optional Thermostat—Model CWT45 Easy to install, this optional accessory disables the motor below 50° for climates where cold-weather condensation isn't a concern and to extend motor life. The thermostat activates the motor at temperatures above 61° to vent air from dawn through dusk.

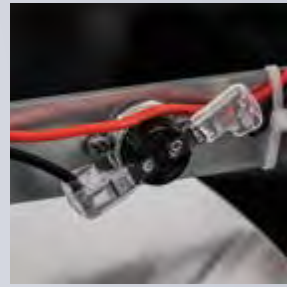

Visit broan.com for more information.

Remote Mount, 345RSOBK and 345RSOWW

In some cases, installing the ventilator in a location that is either less visible, more convenient to reach from the roof-side, or more accessible from the attic-side, is desirable. Remote mount enables the ventilator to be installed independent of the solar panel, up to 50' away (15' of wire included). Locate the remote, flat panel to receive the best sunlight exposure and hide the ventilator from view.

Gable Mount, 345GOBK & 345GOWW

If roof mounting is not possible or desired, gable installation provides the benefits of the SPAV with a remote-mounted, flat solar panel positioned to best capture the sun's energy, up to 50' away (15' of wire included). Finish the outside with a Broan model 433 gable shutter.

345RSOBK (BLACK) | 345RSOWW (WEATHERED WOOD)



345GOBK (BLACK) | 345GOWW (WEATHERED WOOD)

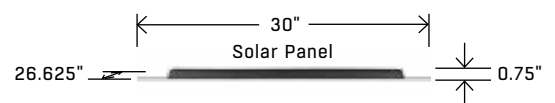
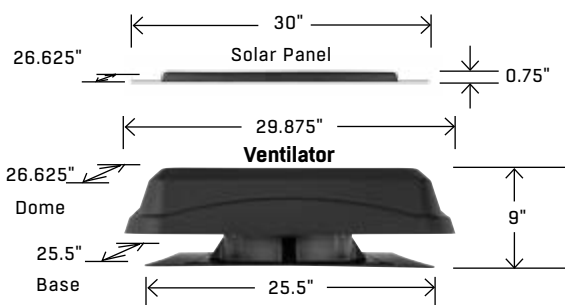

THE PERFECT CONTROL SOLUTION FOR EVERY ROOM AND NEED.



INDICATOR LIGHT CONTROL FOR CONVENIENCE

INDICATOR LIGHT CONTROLS

Model 69W*

- Single-Function Controls
- Ideal for use with quiet models, or Remote In-Line Ventilators
- 120V, 15 amps



Model 269WL, 269VL

- Two-Function Controls
- For use especially with quiet models and an auxiliary light source
- Lighted fan control 120V, 20 amps; unlighted 120/240/277V, 15 amps
- Fits two-gang box
- Controls available in White (W) or Ivory (V)



Model 685WL, 685VL

- Three-Function Controls
- For use especially with quiet models
- Lighted fan control 120V, 20 amps; two additional on/off rocker switches 120V, 15 amps each (20 amps total)
- Fits two-gang box
- Blister packs (P685WL, P685VL)
- Controls available in White (W) or Ivory (V)



THERMOSTAT AND HUMIDITY CONTROLS

Model 82W

- SensAire® technology responds to humidity up to 70% faster than competitive models; setpoint mode satisfies CA requirements
- Continuous ventilation mode helps to meet ASHRAE 62.2
- Compatible with any existing fan within electrical ratings
- Available in white; faceplate not included
- 120V, 4 amp



Model 70TW

- Thermostat for any fan
- 120, 250, 277 VAC,
- 22 amp capacity
- Fits single-gang box only



Model DH100W*

- Dehumidistat
- Dual voltage (24V/120V)
- Variable setting from 20–80% relative humidity
- Usage guide included
- Fits single-gang box only



MULTI-FUNCTION CONTROLS

Model 66W, 66V, 67W

- Three-Function Controls
- Three independent, 120V, 15 amp rocker switches (20 amps total)
- Fits single-gang opening
- Blister packs available (P66W, P66V, P67W)
- Controls available in White (W) or Ivory (V)
- Wall plates available in: White (66W) or Ivory (66V); Polished chrome finish (67W)



Model 68W, 68V

- Two-Function Controls
- Two independent, 120V, 15 amp rocker switches (20 amps total)
- Fits single-gang box
- Blister packs available (P68W, P68V)
- Controls available in White (W) or Ivory (V)



Model 77DW, 77DV

- Four-Function Controls
- Single switch provides three settings for fan sensor (On-Auto-Off) on Sensing models
- Remaining switches for light/night light
- Works with QTX110HL heater/fan/light/night light
- Controls available in White (W) or Ivory (V)
- Fits single-gang opening
- Blister packs available (P77DW)





MULTI-FUNCTION CONTROL TO SUIT EVERY NEED



SPEED CONTROL FOR QUIETER OPERATION OR FULL POWER



HUMIDITY SENSING TO HELP PREVENT FOGGY MIRRORS

SPEED CONTROLS

Model 57W, 57V (3-amp)

- 120V, 3 amps
- Fits single-gang box
- Positive on/off action—dial for variable selection of air speeds and sound levels
- Built-in radio noise suppressor
- Controls available in White (W) or Ivory (V)
- Blister packs available (P57W)



Model 72W, 72V (6-amp)

- 120V, 6 amps—Models 72W, 72V
- Fits single-gang box only
- Positive on/off action—dial for variable selection of air speeds and sound levels
- Built-in radio noise suppressor
- Controls available in White (W) or Ivory (V)



Model 78W, 78V

- 4-speed “no-hum” ceiling fan speed control
- Decorator wall plate
- Screws included
- 120V AC 1.5 amp
- Controls available in White (W) or Ivory (V)



TIMER AND OFF-DELAY CONTROLS

Model 59W, 59V, 71V*

- Model 59W, 59V—up to 60 minutes
- Model 71V—up to 12 hours
- Fits single-gang box
- 120V, 20 amps; 240V, 10 amps
- Operate continuously or for any set period
- Controls available in White (W) or Ivory (V)
- Blister packs available (P59W, P59V)



Model 61W, 61V

- Operate for any set period up to 15 minutes (no “continuous on” position)
- Fits single-gang box
- 120V, 20 amps; 240V, 10 amps
- Controls available in White (W) or Ivory (V)



Model 62W

- 60 Minute
- Two separate 120V, 15 amp on/off rocker switches (20 amps total)
- 120V, 20 amps or 240V, 10 amp timer
- Timer operates continuously or for any set period up to 60 minutes
- Fits two-gang box
- Controls available in White (W)



Model 63W, 63V

- 60 Minute
- Separate 120V, 15 amp on/off rocker switch
- Timer operates continuously or for any set period up to 60 minutes
- Fits two-gang box only
- Controls available in White (W) or Ivory (V)



Model 64W, 64V

- Fan/Light Control with Off-Delay
- Fan and light operate together when control is turned on
- Fan continues to operate for a user adjustable time period 5–60 minutes after light is turned off
- Center position bypasses timer and turns fan and light off immediately
- Fits single-gang box only
- 120V, 4 amps (fan), 4 amps (light)
- Requires hot and neutral wires in the switch box
- Controls available in White (W) or Ivory (V)



*Also for use with Powered Attic Ventilators—see pages 46–47

SELECTION GUIDE

		57W 57V	59W	61W 61V	62W	63W 63V	64W 64V	66W 66V	67W	68W 68V	69W 69V	70TW	71V	72W 72V	73	77DW 77DV	78W 78V	269WL 269VL	685WL	82W, DH100W	
Utility Fans	12C		•	•			•				•	•	•	•			•			•	
	502	•	•	•			•				•	•	•	•			•			•	
	503	•	•	•			•				•	•	•	•			•			•	
	504	•	•	•			•				•	•	•	•			•			•	
	505	•	•	•			•				•	•	•	•			•			•	
	506 & 507																				
	508	•	•	•			•				•	•	•	•			•			•	
	509	•	•	•							•	•		•			•			•	
	509S ¹		•	•			•					•	•				•			•	
	510 ²		•	•			•					•	•				•			•	
	511 ²											•					•				
	512 & 512M	•	•	•								•	•	•	•			•			•
673		•	•				•				•	•	•				•			•	
Ventilation Fans	670	•	•	•			•				•	•	•	•			•			•	
	671	•	•	•			•				•	•	•	•			•			•	
	682	•	•	•			•				•	•	•	•			•			•	
	688	•	•	•			•				•	•	•	•			•			•	
	689	•	•	•			•				•	•	•	•			•			•	
	690	•	•	•			•				•	•	•	•			•			•	
	LP80	•	•	•			•				•	•	•	•			•			•	
	QTXE080 QTXE110, QTXE150		•	•		•	•			•	•	•	•				•	•			•
	QTXE110S									•	•										
	XB50										•							•			•
	XB80										•							•			•
	XB110										•							•			•
	XB110H									•	•							•			•
	ZB80									•								•	•		•
	ZB80M									•	•							•			•
	ZB110									•								•	•		•
	ZB110H									•	•							•			•
	ZB110M									•	•							•			•
	RB80, RB110		•	•							•										•
	A80HD	•	•	•								•									•
AE50, A80, AE80, AE80B, AE80S, A110, AE110, AE110S	•	•	•								•									•	
Ventilation Fan/Lights	657	•	•	•		•	•			•		•	•	•						•	
	678	•	•	•		•	•			•		•	•	•						•	
	696	•	•	•		•	•			•		•	•	•						•	
	741SN	•	•	•		•	•			•		•	•	•						•	
	744					•				•		•								•	
	744FL					•				•		•								•	
	744LED					•				•		•								•	
	744SFL					•		•	•	•		•								•	
	750	•	•	•	•		•	•	•	•		•	•	•				•	•		•
	751	•	•	•		•	•			•		•	•	•				•			•
	754SN	•	•	•		•	•			•		•	•	•				•			•
	761BN, 761RB, 761WHA	•	•	•		•	•			•		•	•	•							•
	791LEDM	•	•				•			•		•							•		•
	RB80L, RB110L					•	•			•									•		•
	AE80L, AE80BL, AE80SL, AE110L, AE110SL	•				•	•			•									•		•
	A50L, A70L, A80L A110L	•				•	•			•									•		•

¹Built-in on/off switch. ²Built-in on/off variable switch

		57W 57V	59W	61W 61V	62W	63W 63V	64W 64V	66W 66V	67W	68W 68V	69WL 69VL	70TW	71V	72W 72V	73	77DW 77DV	78W 78V	269WL 269VL	685WL	82W, DH100W	
Ventilation Fan/Lights Continued	HD80L	•	•	•		•	•			•		•	•	•					•		•
	QTXE080FLT, QTXE110FLT, QTXE150FLT		•	•	•	•	•	•				•	•							•	•
	XB50L							•	•											•	•
	XB80L							•	•											•	•
	XB110L							•	•											•	•
	XB110HL							•	•								•				•
	ZB80L																	•			•
	ZB80ML																	•			•
	ZB110L																	•			•
	ZB110HL							•	•									•			•
	ZB110ML																	•			•
Heater/Fan/ Lights	100HL	•	•	•	•			•	•			•	•	•							•
	100HFL	•	•	•	•			•	•			•	•	•							•
	161		•	•			•				•										•
	162	•	•	•		•	•			•		•	•	•					•		•
	163		•	•		•					•										•
	164	•	•	•	•	•		•	•	•		•	•	•					•	•	•
	655	•	•	•	•			•	•			•	•	•					•	•	•
	656		•	•		•						•	•								•
	658	•	•	•		•				•		•	•	•					•		•
	659	•	•	•	•			•	•			•	•	•					•	•	•
	QTX110HL		•	•	•			•	•			•	•				•				•
	QTX110HFL		•	•	•			•	•			•	•				•				•
In-Line	MP100, MP140 MP200	•	•	•							•	•	•	•							•
	MP280	•	•	•							•	•	•	•							•
	SP100, SP140, SP200	•	•	•							•	•	•	•							•
Attic Ventilation	349BR		•	•							•	•	•	•	•						•
	350BK		•	•							•	•	•	•	•						•
	350BR		•	•							•	•	•	•	•						•
	353		•	•							•	•	•	•	•						•
	35316		•	•							•	•	•	•	•						•
	355BK		•	•							•	•	•	•	•						•
	355BR		•	•							•	•	•	•	•						•
	356BK		•	•							•	•	•		•						•
	356BR		•	•							•	•	•		•						•
	358		•	•							•	•	•	•	•						•

¹Built-in on/off switch. ²Built-in on/off variable switch

ADAPTERS

Model FY6

- 6" x 6" x 6" Y adapter

Model FY86

- 8" x 6" x 6" Y adapter

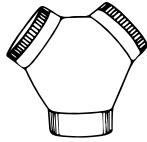

DAMPERS

Model 97 Damper

- 7" spring-loaded, in-line damper

Model BP87 Damper

- 7" vertical discharge damper

DUCTING

Model 406 Round Duct

- 6" round duct
- 2' galvanized section

Model 407 Round Duct

- 7" round duct
- 2' galvanized section

Model 410 Round Duct

- 10" round duct
- 2' galvanized section

Model 889 Duct

- 3 3/4" x 10" duct
- 2' galvanized sections

Models DT4C & DT6C Non-Insulated Flexible Duct

- 4" (DT4C) or 6" (DT6C) round
- DT4C is a 4-pack
- 25' standard length

Models DT4W, DT6W & 804DU Insulated Flexible Duct

- 4" (DT4W & 804DU) or 6" (DT6W) round
- 25' standard length

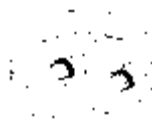
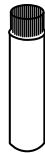

DUCTING KITS

Model RVK1A*

Flexible Roof Ducting Kit

- Includes Model 636 Roof Cap
- 4" diameter metal duct connector
- 2 duct clamps
- 4" to 3" reducer
- 8' of 4" flexible aluminum ducting



Model WVK2A*

Flexible Wall Ducting Kit

- Includes white polymeric wall cap
- 4" diameter metal duct connector
- 2 duct clamps
- 4" to 3" reducer
- 5' of 4" flexible aluminum ducting



ELBOWS

Model 415 Adjustable Elbow

- Fits 7" round duct



Model 418 Adjustable Elbow

- Fits 10" round duct

Model 419 Adjustable Elbow

- Fits 6" round duct

Model 428 Vertical Elbow

- Fits 3 3/4" x 10" duct

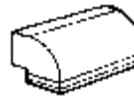

Model 429 Horizontal Elbow

- Fits 3 3/4" x 10" duct



Model 430 Short Eave Elbow

- For 3 3/4" x 10" duct
- Includes backdraft damper and grille (black)
- Only recommended for fans with more than 160 CFM



Model 431 Long Eave Elbow

- For 3 3/4" x 10" duct
- Includes backdraft damper and grille (black)
- Only recommended for fans with more than 160 CFM

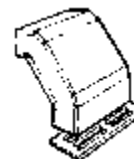

Model 839 Elbow

- 90° turn
- For use with 3 3/4" x 10" duct

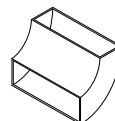

FILTERS

Model 834 Filter

- For 8" fans

Model 854 Filter

- Aluminum mesh grease filter
- For 10" fans

Model 99010042 Aluminum Filter

- Fits Utility Ventilator Models 503, 503MG, 505, 505MG, 509, 509MG, 509S and 509SMG



Model 99010271 Aluminum Filter

- Fits Utility Ventilator Models 12C, 12CMG, 502, 502MG, 504, 504MG, 508, 508MG, 510, 510MG, 511 and 511MG

METAL GRILLE KIT

Model 97011308

- Steel baked white enamel finish
- Fits fan Models 670, 671, 676, 684, 688 and 689
- Grille size is 10 3/4" square

ROOF CAPS

Model 437* 10" Round

- High-capacity design up to 1200 CFM
- Backdraft damper and built-in bird screen
- Steel housing, black electrically bonded epoxy finish



Model 611 Roof Cap*

- For flat roof installation
- Aluminum natural finish
- For up to 8" round duct



Model 611CM Roof Cap*

- For curb mount installation
- Other features same as Model 611

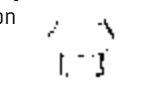

Model 612 Roof Cap*

- For flat roof installation
- Aluminum natural finish
- For up to 12" round duct



Model 612CM Roof Cap*

- For curb mount installation
- Other features same as Model 612

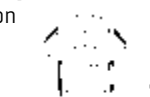

Model 634 Roof Cap*

- For 3 3/4" x 10" or up to 8" round duct
- Black
- Backdraft damper and birdscreen



ROOF CAPS CONTINUED

Model 634M Roof Cap*

- Same as Model 634 except for 6" round duct

Model 636 Roof Cap*

- For 3" or 4" round duct
- Built-in backdraft damper and bird screen
- Steel baked black enamel finish



Model 636AL Roof Cap*

- Same as Model 636, except aluminum natural finish

Model 644 Roof Cap*

- Same as Model 634, except for aluminum natural finish

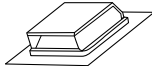

SLEEVES

Model CVLD4

- 4" sleeve with damper

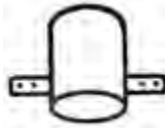

Model CVLD6

- 6" sleeve with damper

TRANSITIONS

Model 886 Transition

- Converts 7" round to 3 3/4" x 10" duct

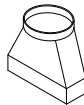

Model 475 Transition

- Converts 6" round duct to 4" round duct reducer
- Available in 6 Pack (475B)

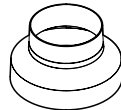

Model 413 Transition

- Converts 3 3/4" x 10" duct to 8" round duct



WALL CAPS

Model 613 Wall Cap*

- For 12" round duct
- Built-in backdraft damper and bird screen
- Aluminum natural finish



Model 639 Wall Cap*

- For 3 3/4" x 10" duct
- Spring-loaded backdraft damper
- Built-in bird screen
- Steel baked black enamel finish



Model 649 Wall Cap*

- Same as Model 639, except aluminum natural finish

Model 641 Wall Cap*

- For 6" round duct
- Built-in backdraft damper and bird screen
- Aluminum natural finish
- Model 647 for 7" Round duct



Model 647 Wall Cap*

- For 7" round duct
- Other features same as Model 641



Model 649 Wall Cap*

- Same as Model 639, except aluminum natural finish



Model 843BL Wall Cap*

- For 6" round duct
- Built-in backdraft damper and bird screen
- Black finish

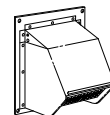

WALL CAPS CONTINUED

Models 885AL and 885BL Wall Cap*

- For 3" or 4" round duct
- 4" to 3" transition included
- Aluminum natural finish (885AL) and steel black enamel finish (885BL)
- Standard package—6 to a carton
- Built-in bird screen and damper

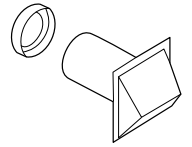

Model 642

- For 4" round duct
- Aluminum natural finish
- 4 to a carton

Model 643 Wall Cap*

- For 8" round duct
- Aluminum natural finish
- Backdraft damper, no birdscreen



Model 646 Louvered Wall* Cap for 6" Round Duct

- Single pack
- White polymeric



Model WC650 Wall Cap*

- For 4" round duct
- White polymeric
- 4 to a carton



TECHNICAL

What is a sone, and how is it measured? A sone is a measurement of sound of how sound is sensed. The lower the sone value, the quieter the listening environment. One sone is the equivalent of a quiet refrigerator. Broan fans feature the quietest rating possible at <0.3 sones as tested for HVI certification.

What does “HVI certified” mean? The Home Ventilating Institute (HVI) is an independent organization that certifies the airflow and sound performance of Broan products. For more information visit www.hvi.org.

What is ENERGY STAR®? Refer to the product matrix for specific Broan fans that meet ENERGY STAR® requirements. Many of these Broan products use high efficiency motors and lighting to reduce energy consumption by as much as 70%. Learn more about ENERGY STAR® at www.energystar.gov.

What does CFM mean? Cubic Feet per Minute (CFM) is the measure of air volume moved by the fan blower. Choose a fan with a CFM rating appropriate for your room size to ensure adequate ventilation.

What does “static pressure” mean? Static pressure is the measurement of airflow resistance as it is pushed through ductwork which reduces the effectiveness of the fan. Learn more on the Home Ventilating Institute website www.hvi.org.

What is whole-house ventilation? Whole-house ventilation provides today’s airtight homes with a relatively constant and controlled lower level of ventilation. Broan offers many virtually silent continuous ventilation solutions for ASHRAE 62.2 and programs such as LEED, ENERGY STAR® for Homes and CA Title 24.

OPERATION

How do I size a fan properly for my room size and the duct run? See the sizing guidelines on page 59 for details on proper sizing. This section provides an explanation and examples to help you make the right decision.

How long should a bath fan run after a shower is used? The Home Ventilating Institute recommends that a fan should be left on for 20 minutes more to clear humidity adequately and to ensure moisture and condensation is minimized.

How does Sensing Technology operate? Broan has unique sensing technology that detects humidity or motion. Multi-speed models automatically turn the fan speed up when someone enters the room or there is a rapid rise in the humidity level from the lower continuous CFM level. Single-speed models turn the fan on automatically.

How does the delay-off timer operate? Delay-off timers automatically shut the fan off after a time interval set by the user.

Why do the windows and mirrors fog even when the fan is running? If windows and mirrors are very cold, condensation can still form on these surfaces. And if your bathroom is sealed tightly, replacement air may not be entering the room fast enough to displace the moist air. Fan placement can also be a factor. Your fan should be located far from the replacement air source to ensure the moist air is drawn out first. Finally, make sure your ductwork is as short and straight as it can be in order to ensure proper air outflow.

Why is water dripping from the grille of the fan? Dripping water is either condensation (usually due to cold ductwork or improper duct installation), or a problem with the seal on a wall or roof vent. Insulated ductwork can help solve condensation problems, and running the fan longer will ensure moisture is completely removed from the duct.

Will Broan fans work in wall-mount applications? Refer to the product matrix for specific Broan bath and utility fans that may be wall mounted.

What type of exhaust fan is best for a sauna or hot tub area? High CFM-rated devices are normally recommended for this type of application.

Can I use a fan in a steam shower? No. Since these are normally sealed chambers, a vacuum will be created.

INSTALLATION

Can I mount Broan fans above my tub and shower? Most Broan fans are rated for use over a shower or bathtub with a GFCI (Ground Fault Circuit Interrupter).

Can my bath fan be surrounded by insulation? Yes. Broan bath fans are designed to provide adequate cooling for motors and lighting, as well as products with integral heaters.

Can I vent more than one bath fan out of a roof or wall cap? No. Always follow the manufacturer's recommended ventilation requirements.

What is the Broan Ventilation fan warranty? Go to <http://www.broan.com/warranty> for this information.

Do I need attic access to install a fan in a retrofit situation? Refer to the product matrix for specific Broan fans that may be installed without access from above with features such as telescoping mounting frames, snap-in housings, bendable mounting ears, drywall-mounting tabs and inside-out mounting duct connectors. Room-side retrofit installations are now a reality.

Can I install a heater over the bathtub or in a shower?

No. Heaters are not UL Listed (Underwriter's Laboratory) for installation over a bathtub or in a shower.

Can I use an inline or multi-port fan in one large bathroom? Yes, this works the best for large rooms because you can install the ports over the areas where the ventilation is needed the most (source control). The size of the multi-port would be determined by the size of the room.

Can larger diameter ducting be used with my bath fan? Yes, larger diameters will result in improved performance.

Can I use a smaller diameter duct than what the fan is designed for? This is not recommended. It will cause the fan to run harder, greatly reducing the CFM performance of the fan and create excess noise.

What type of duct is recommended, rigid or flexible? It is recommended, where possible, to use rigid duct. It has less resistance to air flow and allows the fan to operate much more efficiently. If flexible duct is used, be sure the duct is as straight as possible.

Can I exhaust my fan into my attic instead of out the roof or wall? Never exhaust air into spaces within walls, ceilings, attics, crawl spaces or garages. Humidity may damage the structure and insulation.

Where should the exhaust fan be located? Exhaust fans should be located in or near the shower or tub, and in an enclosed water closet. Keep exhaust points opposite the supply air source to ensure that the fresh air is drawn through the room. Bathroom doors should not be sealed too tightly at the bottom in order to allow "makeup air" to enter the room when the door is closed.

In what direction should I orient the exhaust outlet? The exhaust outlet is the point where air is discharged through the body of the fan housing into the ductwork. During installation, orient your fan with the exhaust outlet pointing toward the exit vent on your roof or wall to minimize turns in ductwork that impede airflow.

Will a bath fan or wall-mount utility fan serve as a range hood? No. Range hoods are specifically designed to handle grease and high temperature environments. Broan bath fans supplement odor and moisture removal in the kitchen, but are not intended for use as a range hood.

Can I use CFL or LED bulbs in fan/lights with A19 screw-base sockets? Yes, if key guidelines are followed. Go to broan.com FAQs for details.

PROPER INSTALLATION MAKES ALL THE DIFFERENCE.

Tape or caulk around the seam where the fan housing meets the sheetrock on the ceiling

If possible, use smooth, rigid ductwork as large as the exit opening on the body of the fan housing

Whenever possible, ductwork should slope down and away from the fan housing to direct any condensation toward the vent

Whether rigid or flexduct, the turning radius for the duct should be as large as possible

Pre-installed screws, keyhole slots and alignment tabs facilitate installation, taking the guesswork out of proper mounting.

Elbows, turns, long ducts and ductwork smaller than the fan's exit outlet will reduce performance.

Use wide aluminum foil or duct tape to join smooth metal ductwork seams.

Do not let flexible ductwork sag as this impedes airflow.

During installation, orient the bath fan outlet in the direction of the home's exit point to minimize duct turns.

Before adding an elbow or bend, allow 24" to 36" of straight run from the fan outlet point.

Duct-wrap insulation (R-5 or above) will help minimize condensation in cold climates, especially on long duct runs.

Quick guideline: For bathrooms up to 100 square feet, the HVI recommends ventilation of at least 1 CFM per square foot (about eight air changes per hour). For bathrooms over 100 square feet, add up the needs of each fixture to determine the total ventilation rate:

- Toilet 50 CFM
- Shower 50 CFM
- Bathtub 50 CFM
- Jetted tub 100 CFM

Exit vents should have backdraft flaps to help keep cold air from entering the duct

EASY STEPS FOR CHOOSING AND SIZING THE RIGHT VENTILATION FAN FOR YOUR HOME.

Determine which rooms could use ventilation, and how much is needed. **Spot ventilation** is used in localized areas to remove moisture, odor and airborne pollutants quickly. Most commonly used in the bath or powder room, spot ventilation can also be used in a laundry room, exercise area, closet, or bedroom, wherever air should be changed frequently. Decorative and recessed models can be ideal solutions for these situations. According to the Home Ventilating Institute (HVI), Air Changes per Hour (ACH) for comfortable and healthy living should be as follows: Bathrooms: 8 changes, Kitchens: 15 changes, Living/Bedrooms: 6 changes. Broan bath fans, utility fans and high capacity fans can meet these needs.

Calculate the air movement necessary for proper ventilation. Air movement is measured in Cubic Feet per Minute (CFM). To determine CFM requirements, first determine the size of your room. Measure and multiply the length, width and ceiling height of your room to determine cubic footage. Then use the multiplication factor of .13 and round up to the next "ten." See the three examples that follow.

Example 1:

Bathroom with 8' ceiling:
7' wide x 9' long x 8' high x .13 = 66. Select a bath fan with at least 70 CFM

Example 2:

Bathroom with 9' ceiling: 10' wide x 9' long x 9' high x .13 = 105. Select a bath fan with at least 110 CFM

Example 3:

For a bathroom with a vaulted ceiling, use the average ceiling height at the wall and the peak: 8' wide x 12' long x ((8' at wall + 12' at peak) / 2 = 10') average height x .13 = 125. Select a fan(s) with at least 130 CFM

Account for long duct runs and ductwork that turns before it reaches the exterior vent. When airflow is restricted in any way it slows down. Just as a car must slow down for a sharp corner, air decelerates when going through a turn in a duct run. Whenever possible, create a straight duct run with large radius turns, if they're necessary at all. Rigid ductwork is optimal because airflow restriction is minimized. Flexible tubing may be convenient to install, but resistance is created as air is moved over the spiral metal frame of the tubing. With long duct runs or ducts with multiple turns the fan works harder, noise increases and fan performance (CFM) is compromised. Select a fan model with an even greater CFM rating to compensate.

6" ducting overcomes most performance-related installation issues. Broan's ULTRA and QTX Green Series fans deliver high performance in virtually any real-world installation. They are engineered with a 6" duct connector for peak air movement and extremely quiet operation, even when the duct run is not short and straight.

INVENT Fans and Fan/Lights

Model	Page	CFM	Sones, HVI-Certified	Baths up to () Sq Ft	Lighting Watts Main/ Night Light	ENERGY STAR®	Fluorescent Lighting	Duct Size"	Housing Dims			Grille Dims		Grille Finish	Amps
								L"	W"	H"	L"	W"			
AE80	26	80	0.8	75	—	Yes	—	4	9 ³ / ₄	10	5 ³ / ₄	11 ³ / ₈	12	White Polymeric	0.3
AE110	26	110	1.3	105	—	Yes	—	4	9 ³ / ₄	10	5 ³ / ₄	11 ³ / ₈	12	White Polymeric	0.3
AE80B	26	80	1.5	75	—	Yes	—	4	9 ³ / ₄	10	5 ³ / ₄	11 ³ / ₈	12	White Polymeric	0.3
AE50	26	50	0.5	45	—	Yes	—	4	9 ³ / ₄	10	5 ³ / ₄	11 ³ / ₈	12	White Polymeric	0.2
A80HD*	26	80	2.0	75	—	No	—	4	9 ³ / ₄	10	5 ³ / ₄	11	12	White Painted Metal	0.37
A80	26	80	2.0	75	—	No	—	4	9 ³ / ₄	10	5 ³ / ₄	11 ³ / ₈	12	White Polymeric	0.37
AE80S	20	80	0.8	75	—	Yes	—	4	9 ³ / ₄	10	5 ³ / ₄	11 ³ / ₈	12	White Polymeric	0.3
A110	26	110	3.0	105	—	No	—	4	9 ³ / ₄	10	5 ³ / ₄	11 ³ / ₈	12	White Polymeric	0.4
AE110S	20	110	1.0	100	—	Yes	—	4	9 ³ / ₄	10	5 ³ / ₄	11 ³ / ₈	12	White Polymeric	0.3
A80L**	26	80	1.0	75	A19 Base	No	—	4	9 ³ / ₄	10	5 ³ / ₄	11 ¹ / ₂	12 ¹ / ₈	White Polymeric	1.2
A110L**	26	110	1.3	105	A19 Base	No	—	4	9 ³ / ₄	10	5 ³ / ₄	11 ¹ / ₂	12 ¹ / ₈	White Polymeric	1.2
A50L**	26	50	1.5	45	A19 Base	No	—	4	9 ³ / ₄	10	5 ³ / ₄	11 ¹ / ₂	12 ¹ / ₈	White Polymeric	1.0
A70L**	26	70	2.0	65	A19 Base	No	—	4	9 ³ / ₄	10	5 ³ / ₄	11 ¹ / ₂	12 ¹ / ₈	White Polymeric	1.2
AE80BL	26	80	1.5	75	11W LED	Yes	LED	4	9 ³ / ₄	10	5 ³ / ₄	11 ³ / ₄	12 ¹ / ₂	White Polymeric	0.3
AE80L	26	80	0.8	75	11W LED	Yes	LED	4	9 ³ / ₄	10	5 ³ / ₄	11 ³ / ₄	12 ¹ / ₂	White Polymeric	0.3
AE80SL	20	80	0.8	75	11W LED	Yes	LED	4	9 ³ / ₄	10	5 ³ / ₄	11 ³ / ₄	12 ¹ / ₂	White Polymeric	1.2
AE110L	26	110	1.3	105	11W LED	Yes	LED	4	9 ³ / ₄	10	5 ³ / ₄	11 ³ / ₄	12 ¹ / ₂	White Polymeric	0.3
AE110SL	20	110	1.0	100	11W LED	Yes	LED	4	9 ³ / ₄	10	5 ³ / ₄	11 ³ / ₄	12 ¹ / ₂	White Polymeric	1.2

*Metal grille. **Bulb not included.

Fans

Model	Page	CFM	Sones, HVI-Certified	Baths up to () Sq Ft	ENERGY STAR®	Duct Size"	L"	W"	H"	Grille Dims		Grille Finish	Amps
										L"	W"		
670	30	50	3.5	45	—	3	7 ¹ / ₄	7 ¹ / ₂	3 ⁵ / ₈	9	9 ¹ / ₄	White Polymeric	0.8
671	30	70	6.0	65	—	3	7 ¹ / ₄	7 ¹ / ₂	3 ⁵ / ₈	9	9 ¹ / ₄	White Polymeric	1.2
682	31	—	—	—	—	Duct-free	7 ¹ / ₈	7 ¹ / ₈	3 ³ / ₄	8 ¹ / ₂	8 ¹ / ₂	White Polymeric	1.0
688	30	50	4.0	45	—	3	7 ¹ / ₄	7 ¹ / ₂	3 ⁵ / ₈	9	9 ¹ / ₄	White Polymeric	0.9
689	30	60	5.5	55	—	3	7 ¹ / ₄	7 ¹ / ₂	3 ⁵ / ₈	9	9 ¹ / ₄	White Polymeric	1.5
690**	31	60	3.0	55	—	—	—	—	—	9 ⁵ / ₈	11 ¹ / ₈	White Polymeric	1.5
LP80	29	80	1.0	75	Yes	4 / 3	11 ³ / ₈	10 ¹ / ₂	4	13	13 ³ / ₄	White Polymeric	0.3
SPK110	37	110	1.0	75	Yes	4	11 ³ / ₈	10 ¹ / ₂	7 ³ / ₄	13	14	White Polymeric	0.9
SSQTXE080	23	80	—	—	Yes	—	11 ³ / ₈	10 ¹ / ₂	7 ³ / ₄	—	—	—	—
SSQTXE110	23	110	—	—	Yes	—	11 ³ / ₈	10 ¹ / ₂	7 ³ / ₄	—	—	—	—
QTXE080	18	80	0.3	75	Yes	6	11 ³ / ₈	10 ¹ / ₂	7 ⁵ / ₈	13	14	White Polymeric	0.4
QTXE110	18	110	0.7	100	Yes	6	11 ³ / ₈	10 ¹ / ₂	7 ⁵ / ₈	13	14	White Polymeric	0.3
QTXE110S	20	110	0.7	100	Yes	6	11 ³ / ₈	10 ¹ / ₂	7 ⁵ / ₈	12 ⁷ / ₈	13 ³ / ₄	White Polymeric	0.3
QTXE150	18	150	1.4	140	Yes	6	11 ³ / ₈	10 ¹ / ₂	7 ⁵ / ₈	13	14	White Polymeric	0.5
RB80	15	80	<0.3	75	Yes	4	11 ³ / ₈	10 ¹ / ₂	7 ⁵ / ₈	13	13 ³ / ₄	White Polymeric	0.3
RB110	15	110	0.6	100	Yes	4	11 ³ / ₈	10 ¹ / ₂	7 ⁵ / ₈	13	13 ³ / ₄	White Polymeric	0.3
XB50	13	50	<0.3	45	Yes	6 / 4	10 ¹ / ₂	11 ³ / ₈	7 ⁵ / ₈	13	13 ³ / ₄	White Polymeric	0.1
XB80	13	80	<0.3*	75	Yes	6 / 4	10 ¹ / ₂	11 ³ / ₈	7 ⁵ / ₈	13	13 ³ / ₄	White Polymeric	0.1
XB110	13	110	<0.3	100	Yes	6	10 ¹ / ₂	11 ³ / ₈	7 ⁵ / ₈	13	13 ³ / ₄	White Polymeric	0.2
XB110H	13	110	<0.3	100	Yes	6	10 ¹ / ₂	11 ³ / ₈	7 ⁵ / ₈	13 ¹ / ₈	14	White Polymeric	0.2
ZB80	13	80	<0.3*	75	Yes	6 / 4	10 ¹ / ₂	11 ³ / ₈	7 ⁵ / ₈	13	13 ³ / ₄	White Polymeric	0.1
ZB80M	13	80	<0.3*	75	Yes	6 / 4	10 ¹ / ₂	11 ³ / ₈	7 ⁵ / ₈	13 ¹ / ₈	14	White Polymeric	0.1
ZB110	13	110	<0.3	100	Yes	6	10 ¹ / ₂	11 ³ / ₈	7 ⁵ / ₈	13	13 ³ / ₄	White Polymeric	0.2
ZB110H	13	110	<0.3	100	Yes	6	10 ¹ / ₂	11 ³ / ₈	7 ⁵ / ₈	13 ¹ / ₈	14	White Polymeric	0.2
ZB110M	13	110	<0.3	100	Yes	6	10 ¹ / ₂	11 ³ / ₈	7 ⁵ / ₈	13 ¹ / ₈	14	White Polymeric	0.2

Radiation Dampers can be found on page 11, 19, 22, 27, 29 and 72

*With 6" duct (with 4" duct 0.3)

**Replacement grille and motor kit

Fan/Lights

Model	Page	CFM	Sones, HVI-Certified	Baths up to () Sq Ft	Lighting Watts Main/ Night Light	ENERGY STAR®	Fluorescent Lighting	Duct Size"	Housing Dims			Grille Dims		Grille Finish	Amps
									L"	W"	H"	L"	W"		
657	30	70	4.0	65	100	—	—	4	14 ¹ / ₄	8 ³ / ₄	5 ³ / ₄	16 ³ / ₄	10 ⁵ / ₈	White Polymeric	2.0
678	30	50	2.5	45	100	—	—	4	8 ³ / ₄	8	5 ³ / ₄	11 ¹ / ₈	10 ⁵ / ₈	White Polymeric	1.6
696	30	100	4.5	90	100	—	—	4	14 ¹ / ₄	8 ³ / ₄	5 ³ / ₄	16 ³ / ₄	10 ⁵ / ₈	White Polymeric	2.0
741SN	35	70	3.5	65	120 (2-60W)	—	—	4	8 ³ / ₄	8	5 ³ / ₄	13 ³ / ₈ Dia	—	Satin Nickel	2.2
754SN	35	70	3.5	65	120 (2-60W)	—	—	4	8 ³ / ₄	8	5 ³ / ₄	13 ³ / ₈ Dia	—	Nickel	2.2
761BN	35	80	2.5	75	120 (2-60W)	—	—	4	8 ³ / ₄	8	5 ³ / ₄	13 ³ / ₈ Dia	—	Brushed Nickel	1.6
761RB	35	80	2.5	75	120 (2-60W)	—	—	4	8 ³ / ₄	8	5 ³ / ₄	13 ³ / ₈ Dia	—	Oil-rubbed Bronze	1.6
761WHA	35	80	2.5	75	120 (2-60W)	—	—	4	8 ³ / ₄	8	5 ³ / ₄	13 ³ / ₈ Dia	—	White	1.6
744	34	70	1.5	65	75	—	—	4	8 ³ / ₄	12 ³ / ₄	6 ³ / ₄	7 ³ / ₈ Dia	—	Matte White	1.2
744FL	34	70	1.5	65	14	Yes	Yes	4	8 ³ / ₄	12 ³ / ₄	6 ³ / ₄	7 ³ / ₈ Dia	—	Matte White	0.7
744LED	34	70	1.5	65	10W LED	Yes	—	4	8 ³ / ₄	12 ³ / ₄	6 ³ / ₄	7 ³ / ₈ Dia	—	Matte White	0.55
744SFL	34	70	1.5	65	14	Yes	Yes	4	8 ³ / ₄	12 ³ / ₄	6 ³ / ₄	7 ³ / ₈ Dia	—	Matte White	0.7
750	30	100	3.5	90	100 / 7	—	—	4	9	9	6	15 Dia	—	White Polymeric	1.9
751	30	100	3.5	90	100	—	—	4	9	9	6	15 Dia	—	White Polymeric	1.9
791LEDM	35	100	1.5	100	9W LED	Yes	LED	4	9 ¹ / ₄	10	5 ³ / ₄	12 ⁵ / ₈	12 ⁵ / ₈	White	0.5
HD80L	30	80	2.5	75	100	—	—	4	8 ³ / ₄	8	5 ³ / ₄	11 ¹ / ₈	10 ⁵ / ₈	White Polymeric	1.6
QTXE080FLT	18	80	0.3	75	2- 18W fluor/4	Yes	Yes	6	11 ³ / ₈	10 ¹ / ₂	7 ³ / ₈	13 ³ / ₈	14 ¹ / ₄	White Polymeric	1.0
QTXE150FLT	18	150	1.4	140	2- 18W fluor/4	Yes	Yes	6	11 ³ / ₈	10 ¹ / ₂	7 ³ / ₈	13 ³ / ₈	14 ¹ / ₄	White Polymeric	1.2
RB80L	15	80	<0.3	75	2- 18W fluor/4	Yes	Yes	4	11 ³ / ₈	10 ¹ / ₂	7 ³ / ₈	13	13 ³ / ₄	White Polymeric	1.0
RB110L	15	110	0.8	100	2- 18W fluor/4	Yes	Yes	4	11 ³ / ₈	10 ¹ / ₂	7 ³ / ₈	13	13 ³ / ₄	White Polymeric	1.0
XB50L	13	50	<0.3	45	2- 18W fluor/4	Yes	Yes	6 / 4	10 ¹ / ₂	11 ³ / ₈	7 ³ / ₈	13	13 ³ / ₄	White Polymeric	0.7
XB80L	13	80	<0.3*	75	2- 18W fluor/4	Yes	Yes	6 / 4	10 ¹ / ₂	11 ³ / ₈	7 ³ / ₈	13	13 ³ / ₄	White Polymeric	0.7
XB110L	13	110	<0.3	100	2- 18W fluor/4	Yes	Yes	6	10 ¹ / ₂	11 ³ / ₈	7 ³ / ₈	13	13 ³ / ₄	White Polymeric	0.9
XB110HL	13	110	<0.3	100	2- 18W fluor/4	Yes	Yes	6	10 ¹ / ₂	11 ³ / ₈	7 ³ / ₈	13 ³ / ₈	14	White Polymeric	0.9
ZB80L	13	80	<0.3*	75	2- 18W fluor/4	Yes	Yes	6 / 4	10 ¹ / ₂	11 ³ / ₈	7 ³ / ₈	13	13 ³ / ₄	White Polymeric	0.8
ZB80ML	13	80	<0.3*	75	2- 18W fluor/4	Yes	Yes	6 / 4	10 ¹ / ₂	11 ³ / ₈	7 ³ / ₈	13 ³ / ₈	14	White Polymeric	0.8
ZB110L	13	110	<0.3	100	2- 18W fluor/4	Yes	Yes	6	10 ¹ / ₂	11 ³ / ₈	7 ³ / ₈	13	13 ³ / ₄	White Polymeric	0.9
ZB110HL	13	110	<0.3	100	2- 18W fluor/4	Yes	Yes	6	10 ¹ / ₂	11 ³ / ₈	7 ³ / ₈	13 ³ / ₈	14	White Polymeric	0.9
ZB110ML	13	110	<0.3	100	2- 18W fluor/4	Yes	Yes	6	10 ¹ / ₂	11 ³ / ₈	7 ³ / ₈	13 ³ / ₈	14	White Polymeric	0.9

*With 6" duct (with 4" duct 0.3)

Heater/Fan/Lights

Model	Page	CFM	Sones, HVI-Certified	Lighting Watts Main/ Night Light	Housing Dimensions			Grille Dimensions		Grille Finish	Duct Size"	Total Connected			
					L"	W"	H"	L"	W"			Amps	Load In Watts	Heater Wattage	BTU
100HL	44	100	2.0	100W	16	10 ¹ / ₄	5 ⁷ / ₈	17 ¹ / ₂	11 ¹ / ₂	White Polymeric	4	14.5	1830	1500	5120
100HFL	44	100	2.0	27W Fluor. (Incl.)	16	10 ¹ / ₄	5 ⁷ / ₈	17 ¹ / ₂	11 ¹ / ₂	White Polymeric	4	14.0	1760	1500	5120
162*	45	70	4.0	*250W (1)	8 ³ / ₈	8 ³ / ₈	6 ³ / ₈	10 ¹ / ₄	10 ¹ / ₄	White Polymeric	4	2.5	300	250*	853
164*	45	70	4.0	*250W (2)	14 ¹ / ₄	8 ³ / ₈	6 ³ / ₈	15 ⁵ / ₈	10 ¹ / ₄	White Polymeric	4	4.5	545	500*	1707
655	44	70	4.0	100W	14 ¹ / ₄	8 ³ / ₄	5 ³ / ₄	16 ³ / ₄	10 ⁵ / ₈	White Polymeric	4	12.8	1536	1300	4437
656	44	—	—	100W	14 ¹ / ₄	8 ³ / ₄	5 ³ / ₄	16 ³ / ₄	10 ⁵ / ₈	White Polymeric	—	11.9	1428	1300	4437
658	44	70	4.0	n/a	14 ¹ / ₄	8 ³ / ₄	5 ³ / ₄	16 ³ / ₄	10 ⁵ / ₈	White Polymeric	4	11.9	1428	1300	4437
659	44	50	2.5	100W	14 ¹ / ₄	8 ³ / ₄	5 ³ / ₄	16 ³ / ₄	10 ⁵ / ₈	White Polymeric	4	12.0	1440	1300	4437
QTX110HL	43	110	0.9	120W/7W	17 ⁵ / ₈	11 ³ / ₈	7 ⁵ / ₈	20	15	White Polymeric	6	14.6	1710	1500	5120
QTX110HFLT	43	110	0.9	36W Fluor. (GU24 Incl.)/7W	17 ⁵ / ₈	11 ³ / ₈	7 ⁵ / ₈	20	15	White Polymeric	6	13.9	1626	1500	5120

*Ventilation Fan/Bulb Heater versions

Bulb Heater (no fan)

Model	Page	CFM	Sones, HVI-Certified	Lighting Watts Main/ Night Light	Housing Dimensions			Grille Dimensions		Grille Finish	Duct Size"	Amps	Total Connected		
					L"	W"	H"	L"	W"				Load In Watts	Heater Wattage	BTU
161	45			n/a	8 ¹ / ₈	8 ³ / ₈	6 ³ / ₈	10 ¹ / ₄	10 ¹ / ₄	White Polymeric		2.1		250	853
163	45			n/a	8 ¹ / ₈	14 ¹ / ₄	6 ³ / ₈	15 ⁵ / ₈	10 ¹ / ₄	White Polymeric		4.3		500	1707

See models 162 and 164 above for Ventilation Fan/Bulb Heater versions

Utility Fans

Model	Page	CFM	Sones	Housing Dimensions			Grille Dimensions		Amps	Duct Size
				L"	W"	H"	L"	W"		
12C	38	360	8.0	—	11 ¹ / ₂ Sq	—	13 ¹ / ₂ Sq	1.7	Direct Discharge	
502	38	270	8.0	16 ³ / ₄	13 ⁷ / ₈	3 ¹ / ₄	13 ¹ / ₂ Sq	1.7	3 ¹ / ₄ " x 10"	
503	38	160	5.0	14	12	3 ¹ / ₄	11 ¹ / ₂ Sq	1.5	3 ¹ / ₄ " x 10"	
504	38	350	6.5	—	10 ³ / ₄ Rd	7	13 ¹ / ₂ Sq	1.7	10"	
505	38	180	6.5	—	8 ¹ / ₄ Rd	7	11 ¹ / ₂ Sq	1.5	8"	
506	38	470	8.0	—	10 ³ / ₈ Rd	—	13 ¹ / ₂ Sq	1.7	Direct Discharge	
507	38	250	7.0	—	8 ³ / ₈ Rd	—	11 ¹ / ₂ Sq	1.5	Direct Discharge	
508	38	270	6.0	—	10 ³ / ₈ Rd	—	13 ¹ / ₂ Sq	1.7	Direct Discharge	
509	38	180	6.5	—	8 ³ / ₈ Rd	—	13 ¹ / ₂ Sq	1.5	Direct Discharge	
509S	38	180	6.5	—	8 ³ / ₈ Rd	—	13 ¹ / ₂ Sq	1.5	Direct Discharge	
510	38	380	6.5	—	11 ¹ / ₂ Sq	—	13 ¹ / ₂ Sq	1.7	Room to room wall fan	
511	38	180	4.5	—	11 ¹ / ₂ Sq	—	13 ¹ / ₂ Sq	0.9	Room to room wall fan	
512	38	90	3.5	—	6 Rd	—	8 Dia	0.7	Room to room wall fan	
512M	38	70	3.5	—	6 Rd	—	8 Dia	0.7	Direct Discharge	
673	38	60	4.5	—	6 ¹ / ₄ Rd	5 ¹ / ₄	8 Dia	1.0	6"	

In-Line Ventilators

Model	Page	CFM	0.2" Ps Sones	Housing Dimensions			Amps	Duct Size
				L"	W"	H"		
MP100	40	110	1.0	11	10 ¹ / ₂	9 ¹ / ₂	0.5	4- 4" Rd Inlets, 6" Rd Outlet
MP140	40	150	1.5	11	10 ¹ / ₂	9 ¹ / ₂	0.8	4- 4" Rd Inlets, 6" Rd Outlet
MP200	40	210	2.0	11	10 ¹ / ₂	9 ¹ / ₂	1.3	4- 4" Rd Inlets, 6" Rd Outlet
MP280	40	290	3.0	15 ¹ / ₄	14 ¹ / ₄	14 ³ / ₄	2.5	4- 4" Rd Inlets, 6" Rd Outlet
SP100	40	110	1.0	11	10 ¹ / ₂	9 ¹ / ₂	0.5	6" Rd Inlet and Outlet
SP140	40	150	1.5	11	10 ¹ / ₂	9 ¹ / ₂	0.8	6" Rd Inlet and Outlet
SP200	40	210	2.0	11	10 ¹ / ₂	9 ¹ / ₂	1.3	6" Rd Inlet and Outlet

Powered Attic Ventilators—Gable and Roof Mount

Model	Page	Description	Housing Dimensions			CFM	Sones	Amps	Dome Color	Dome Material
			L"	W"	H"					
349BR	47	PAV—Roof Mount	25 Sq	24 ¹ / ₂ Dia Dome	9	1000	n/a	4.0	Dark Brown	Metal
350BK	47	PAV—Roof Mount	22 ¹ / ₄ Sq	23 ¹ / ₄ Dia Dome	8	1050	n/a	3.6	Black	PVC
350BR	47	PAV—Roof Mount	22 ¹ / ₄ Sq	23 ¹ / ₄ Dia Dome	8	1050	n/a	3.6	Brown	PVC
353	47	PAV—Gable Mount	15 Dia	—	8	1020	n/a	3.4	—	—
35316	47	PAV—Gable Mount	15 Dia	—	8	1600	n/a	3.9	—	—
355BK	47	PAV—Roof Mount	22 ¹ / ₄ Sq	23 ¹ / ₄ Dia Dome	8	1200	n/a	4.3	Black	PVC
355BR	47	PAV—Roof Mount	22 ¹ / ₄ Sq	23 ¹ / ₄ Dia Dome	8	1200	n/a	4.3	Brown	PVC
356BK	47	PAV—Roof Mount	22 ¹ / ₄ Sq	23 ¹ / ₄ Dia Dome	8	1600	n/a	8.0	Black	PVC
356BR	47	PAV—Roof Mount	22 ¹ / ₄ Sq	23 ¹ / ₄ Dia Dome	8	1600	n/a	8.0	Brown	PVC
358	47	PAV—Roof Mount	22 ¹ / ₄ Sq	23 ¹ / ₄ Dia Dome	8	1200	n/a	4.3	Silver	Metal

Solar-Powered Attic Ventilators—Surface, Curb, Remote and Gable

Model*	Page	Mount	Color	Housing Material*	Solar Panel Power Output	Pieces	Dome/Panel Dimensions (inches)		
							Height"	Width"	Length"
345CS0BK	48	Curb	Black	ABS Plastic	28 Watts	1 pc	11	29 ⁷ / ₈	26 ⁵ / ₈
345CS0WW	48	Curb	Weathered Wood	ABS Plastic	28 Watts	1 pc	11	29 ⁷ / ₈	26 ⁵ / ₈
345G0BK	49	Gable	Black	ABS Plastic	28 Watts	2 pcs	3 ³ / ₄ / 11	30 / 19 ³ / ₄	26 ⁵ / ₈ / 19 ³ / ₄
345G0WW	49	Gable	Weathered Wood	ABS Plastic	28 Watts	2 pcs	3 ³ / ₄ / 11	30 / 19 ³ / ₄	26 ⁵ / ₈ / 19 ³ / ₄
345RS0BK	49	Remote	Black	ABS Plastic	28 Watts	2 pcs	3 ³ / ₄ / 9	30 / 29 ⁷ / ₈	26 ⁵ / ₈ / 26 ⁵ / ₈
345RS0WW	49	Remote	Weathered Wood	ABS Plastic	28 Watts	2 pcs	3 ³ / ₄ / 9	30 / 29 ⁷ / ₈	26 ⁵ / ₈ / 26 ⁵ / ₈
345S0BK	48	Surface	Black	ABS Plastic	28 Watts	1 pc	9	29 ⁷ / ₈	26 ⁵ / ₈
345S0WW	48	Surface	Weathered Wood	ABS Plastic	28 Watts	1 pc	9	29 ⁷ / ₈	26 ⁵ / ₈

*All UV-enhanced ABS plastic housings may be painted to match roof color



HIGH
NEED HIGH





-TRAFFIC ENVIRONMENTS PERFORMANCE VENTILATION.

LOOKING FOR AN EXCEPTIONALLY QUIET SOLUTION TO LIGHT COMMERCIAL VENTILATION?

With their heavy-duty motors, Broan High Capacity Ventilation Fans are the perfect answer for ventilating conference rooms, dining areas, public restrooms and other heavily-trafficked spaces. Low-vibration and low-profile, these discrete products work quietly and powerfully behind the scenes to remove odor, humidity and air-borne particulates that affect indoor air quality.



100/150 CFM FEATURES

- 6" round metal duct connector
- Single, impact-resistant centrifugal blower wheel housing
- 20 gauge galvanized steel housing
- Duct horizontally, vertically, or in-line with a separate adapter
- Low profile, white polymeric or painted white enamel metal grille
- Models L100L and L150L are UL Listed for use over bathtubs or showers when connected to a GFCI branch circuit
- Model 80L Variable Speed Control adjusts blower speed and sound level (available separately)

200/250/300 CFM FEATURES

- 8" round metal duct connector
- Single, impact-resistant centrifugal blower wheel (Model L300KMG has a metal wheel)
- 20 gauge galvanized steel housing
- Duct horizontally, vertically, or in-line with a separate adapter
- Models L200L, L250L and L300L are UL Listed for use over bathtubs or showers when connected to a GFCI branch circuit
- Model 80L Variable Speed Control adjusts blower speed and sound level (available separately)

SPECIAL FEATURES FOR

Model L300KMG

- Removable access panel; Suitable for kitchen use

Models L100L, L150L

- Removable access panel, no insulation
- Two 6" round duct connectors
- No grille

Models L200L, L250L, L300L

- Suitable for kitchen installations
- Removable access panel, no insulation
- Two 8" round duct connectors

L100 | L150 | L200 | L250 | L300
POLYMERIC GRILL



L100MG | L150MG | L200MG | L250MG, L300MG | L300KMG
METAL GRILL

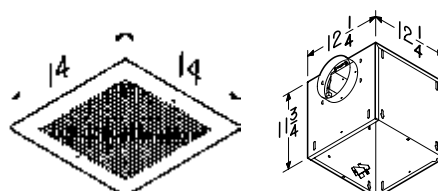
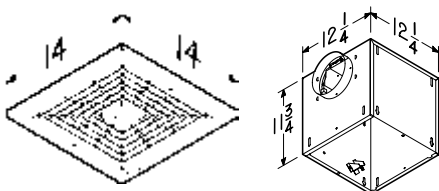
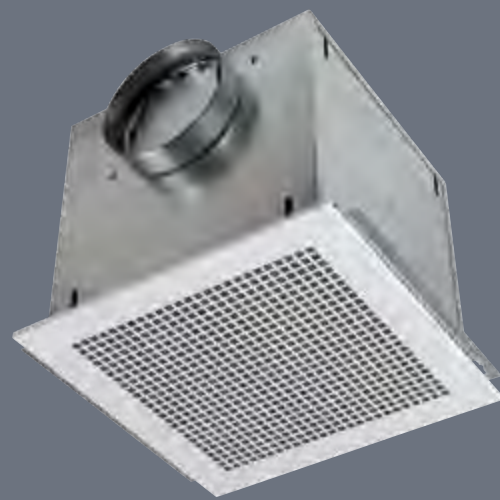

Metal grilles are not acceptable for use over tub or shower.

100–300 CFM Specifications

Model	CFM	Sones	Amps	Sound Insulation	Notes
White Polymeric Grill					
L100	109	0.9	1.1	Yes	
L150	157	1.5	1.3	Yes	
L200	210	1.7	1.8	Yes	
L250	259	2.2	2.1	Yes	
L300	308	2.9	2.6	Yes	
White Metal Grill					
L100MG	115	0.9	1.1	Yes	
L150MG	161	1.4	1.3	Yes	
L200MG	215	1.9	1.8	No	
L250MG	265	2.5	2.1	No	
L300MG	316	3.0	2.6	No	
L300KMG	277	3.1	2.6	No	
In-line Ventilator					
L100L	106	0.7	1.1	No	No Grille
L150L	147	1.1	1.3	No	No Grille
L200L	195	1.9	1.8	No	No Grille
L250L	245	2.3	2.1	No	No Grille
L300L	293	3.1	2.6	No	No Grille

See page 71 for CFM details.

FOR EVERY
VENTILATION NEED



L100L | L150L | L200L | L250L | L300L IN-LINE VENTILATORS

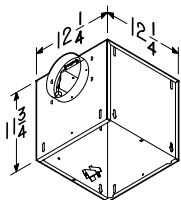
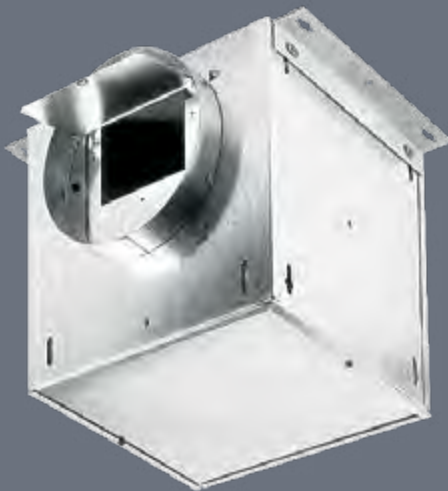

MODEL 80L

- Adjust ventilation easily in any room
- Variable Speed Control mounts inside the fan housing and allows blower speed adjustment
- For Broan High Capacity Fans L100–L900
- Speed control with metal housing
- Fan insulation is perforated for easy installation
- 120V, 3 amps, 60 Hz

80L VARIABLE SPEED CONTROL



400/500/700 CFM FEATURES

- 4 $\frac{1}{2}$ " x 18 $\frac{1}{2}$ " duct connector
- Two impact-resistant centrifugal blower wheels
- Duct horizontally or vertically—In-line available with separate adapter
- Quiet automatic backdraft dampers
- Variable Speed Control adjusts blower speed and sound level (available separately)
- Models with "K" suffix suitable for kitchens
- Not for use over tub or shower

Models L400L, L500L, L700L

- Removable access panel; no insulation

Model L400K

- Suitable for kitchens
- Two metal centrifugal blower wheels
- Order Aluminum Filter LAF2

Model L500K

- Two metal centrifugal blower wheels
- Order Aluminum Filter LAF2
- Suitable for kitchens

L400* | L400K | L500* | L500K | L700*
METAL GRILLE



L400L | L500L | L700L
IN-LINE VENTILATORS

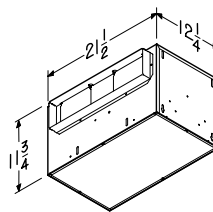
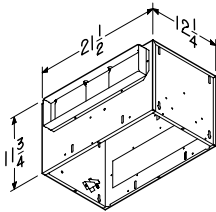
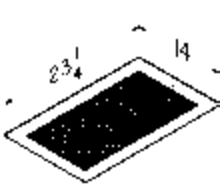

400-700 CFM Specifications

Model	CFM	Sones	Amps	Sound Insulation	Notes
L400	434	2.3	1.4	Yes	Metal grille
L400K	406	3.3	1.4	No	Suitable for kitchens
L500	514	3.3	2.2	Yes	Metal grille
L500K	481	4.4	2.2	No	Suitable for kitchens
L700	701	4.7	2.9	Yes	Metal grille
L400L	406	1.6	1.4	No	No grille
L500L	519	3.4	2.2	No	No grille
L700L	681	3.7	2.9	No	No grille

*See page 71 for CFM details.

Metal grilles are not acceptable for use over tub or shower.

900/1500/2000 CFM FEATURES

- 8" x 12" duct
- Painted white enamel metal grille
- Single, impact-resistant centrifugal blower wheel
- Ducted horizontally or vertically, or in-line with separate adapter
- Model 80L Variable Speed Control adjusts blower speed and sound level (available separately)
- Not for use over tub or shower

Models L900, L1500 (shown)

- L900 can use the 80L variable speed blower control (sold separately)

Models L900L, L1500L

- Removable access panel; no insulation
- Can use the 80L variable speed blower control (sold separately)

Model L2000L

- 38"L x 14⁵/₈"W x 14⁵/₈"H
- Fits 7³/₄" x 33³/₄" duct
- Optional metal grille (Model G102) and damper kit (Model D100)

L900 | L1500*
METAL GRILLE

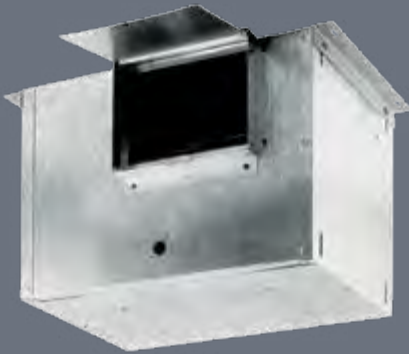

L900L | L1500L
IN-LINE VENTILATORS

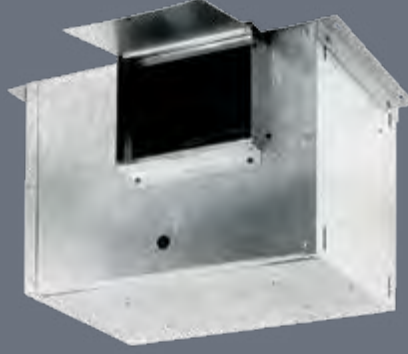

L2000L
IN-LINE VENTILATORS



Shown with optional metal grille (Model G102) and damper kit (Model D100).

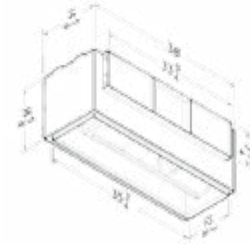
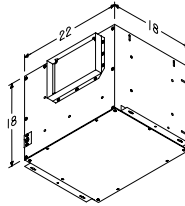
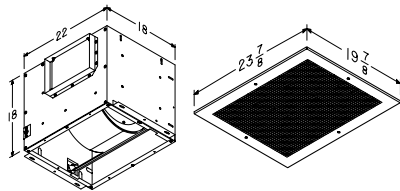

80L
VARIABLE SPEED CONTROL



900–2000 CFM Specifications

Model	CFM	Sones	Amps	Notes
L900	901	4.1	3.0	Painted white enamel metal grille
L1500	1513	8.4	5.0	Painted white enamel metal grille
L900L	894	3.8	3.0	In-line
L1500L	1214	6.7	5.0	In-line
L2000L	1791	9.4	5.8	In-line

See page 71 for CFM details.

Metal grilles are not acceptable for use over tub or shower.

MODEL 80L

- Adjust ventilation easily in any room
- Variable Speed Control mounts inside the fan housing and allows blower speed adjustment
- For Broan High Capacity Fans L100–L900L
- Speed control with metal housing
- Fan insulation is perforated for easy installation
- 120V, 3 amps, 60 Hz

PERFORMANCE DATA INVENT

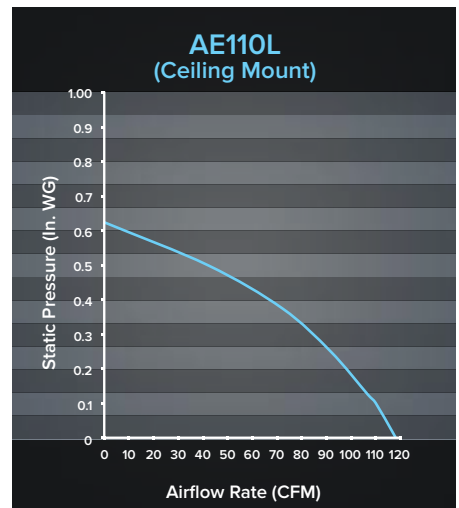
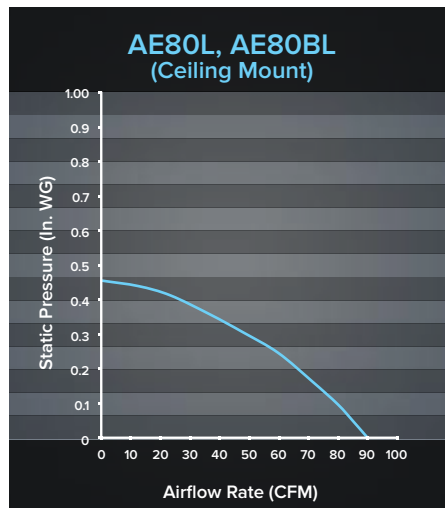
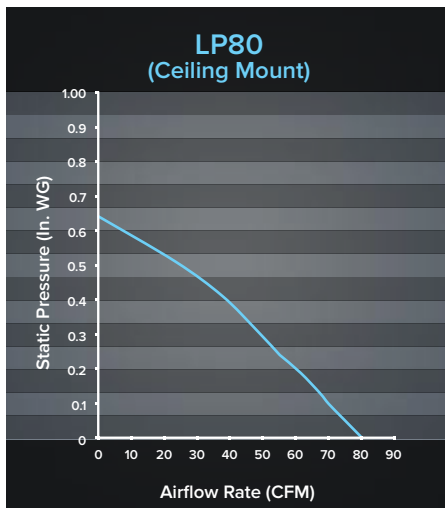
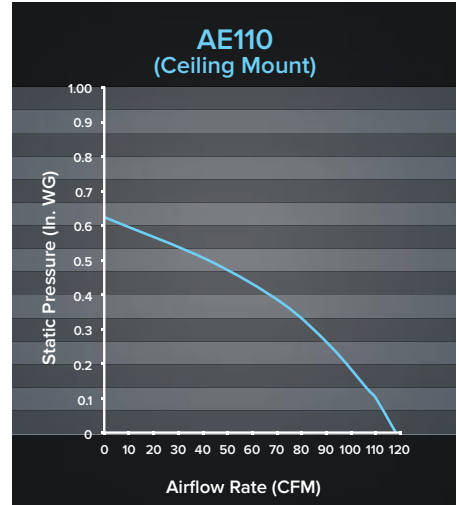
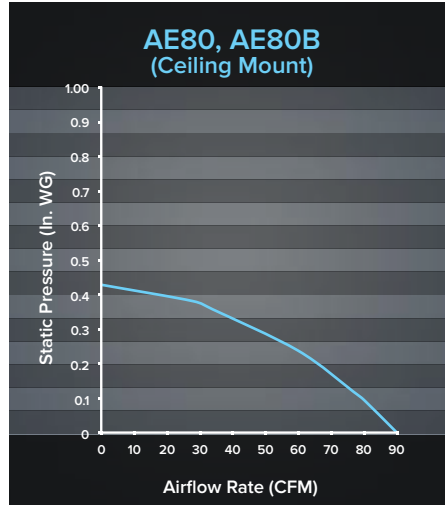
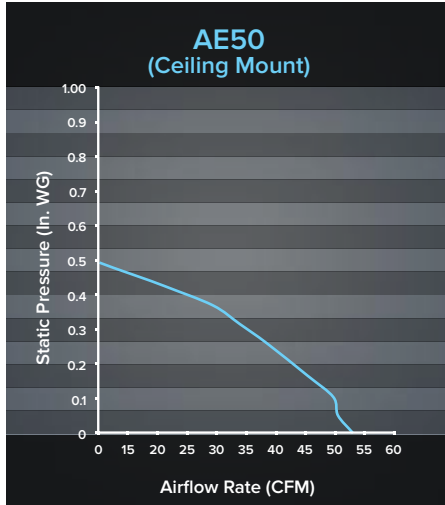

PERFORMANCE DATA LIGHT COMMERCIAL

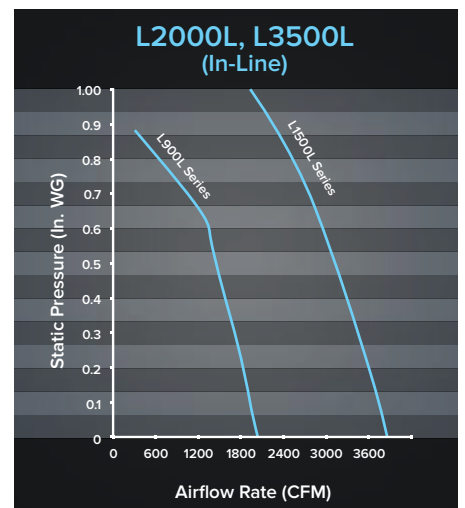
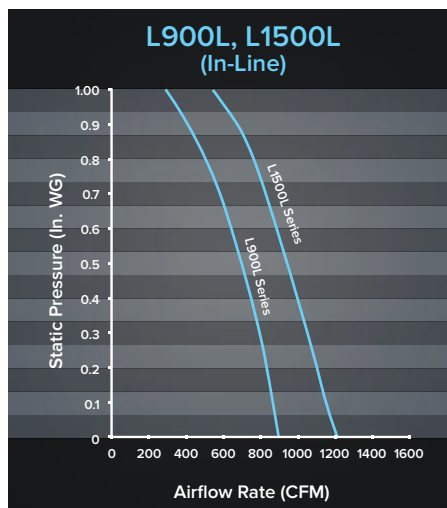
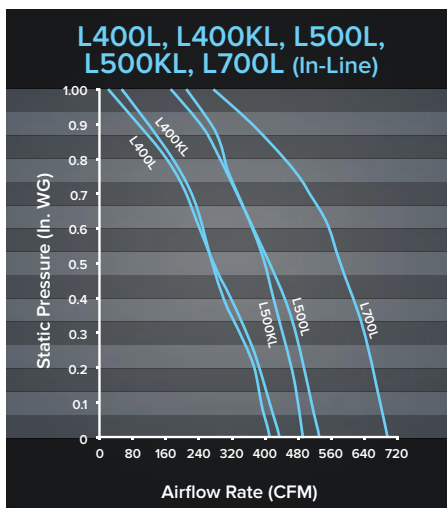
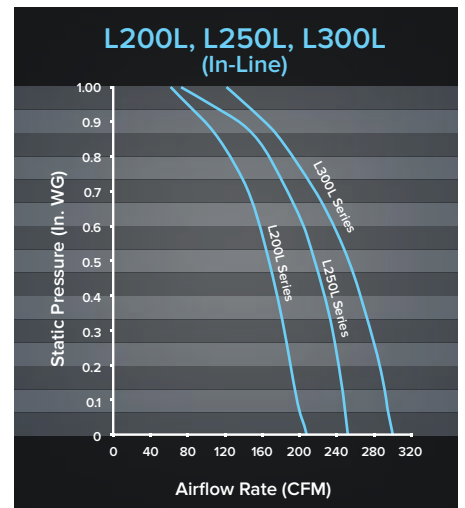
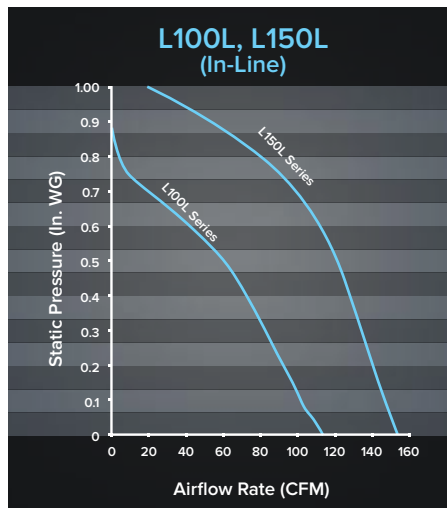
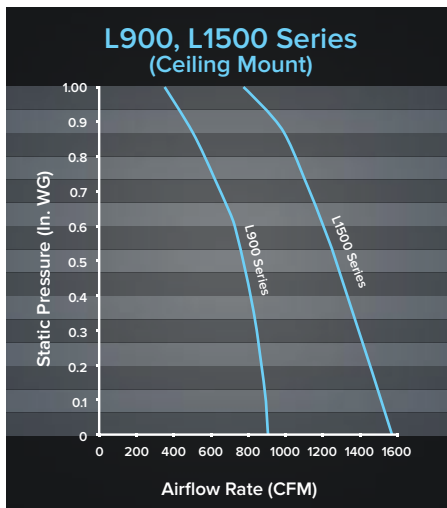
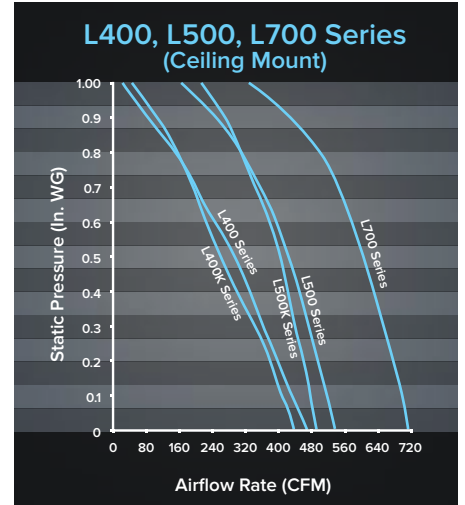
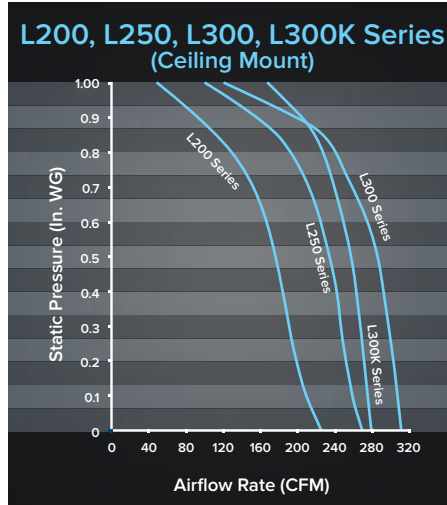
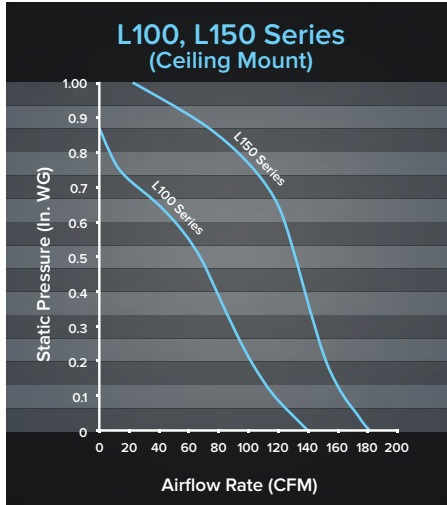

For In-line models, performance listed is for straight-through ducting at .125" static pressure. For complete Sonnes and CFM at other static pressures, see our Web site at www.Broan.com.

ROOF CAPS

Model 437

- High-capacity design up to 1200 CFM
- Built-in bird screen
- Steel housing, black electrically bonded epoxy finish



Model 611

- For flat roof installation
- Aluminum natural finish
- For up to 8" round duct



Model 611CM

- For curb mount installation
- Other features same as Model 611



Model 612

- For flat roof installation
- Aluminum natural finish
- For up to 12" round duct

Model 612CM

- For curb mount installation
- Other features same as Model 612

Model 634

- For 3 $\frac{1}{4}$ " x 10" or up to 8" round duct
- Built-in backdraft damper and bird screen
- Steel housing, black electrically bonded epoxy finish



Model 634M

- Same as Model 634, except for 6" round duct

Model 644

- Same as Model 634, except aluminum natural finish

GREASE FILTERS

Models LAF1 & LAF2

- Aluminum mesh filter traps grease and protects motor
- Dishwasher safe
- LAF1 (12" x 12") for L100/150/200/250/300 Series
- LAF1 for use with metal grilles
- LAF2 (12" x 21 $\frac{1}{4}$ ") for L400/500 Series

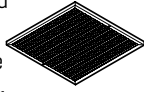

WALL CAPS

Model 441

- For 10" round duct
- Steel with aluminum louvers

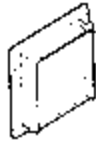

Model 613

- For 12" round duct
- Built-in backdraft damper and bird screen
- Aluminum natural finish

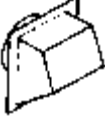

Model 641

- Same as Model 613, except for 6" round duct

Model 643

- For 8" round duct
- Built-in backdraft damper
- Aluminum natural finish



Model 843BL

- For 6" round duct
- Built-in backdraft damper and bird screen
- Black finish



IN-LINE ADAPTERS

Model 961L

- For L100/L150 Series
- Galvanized steel
- 6" round duct intake

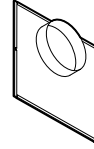

Model 981L

- For L200/L250/L300 Series
- Galvanized steel
- 8" round duct intake

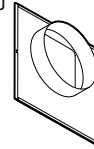

Model 982L

- For L400/L500/L700 Series
- Galvanized steel
- 4 $\frac{1}{2}$ " x 18 $\frac{1}{2}$ " duct intake

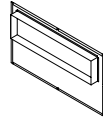

Model 983L

- For L900/L1500 Series
- Galvanized steel
- 8" x 12" duct intake

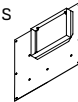

DUCT TRANSITIONS

Models 423 & T81212

- Galvanized steel
- 423: (4 $\frac{1}{2}$ " x 18 $\frac{1}{2}$ " to 10" round)
- T81212: (8" x 12" to 12" round)

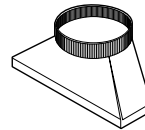

VIBRATION DAMPENING HANGERS

Model V104 (not shown)

- For Model L2000L
- Heavy gauge steel construction
- Neoprene vibration dampening cushion
- Maximum load 75 lbs (each)
- For $\frac{3}{8}$ " diameter threaded rod (available separately from others)
- Set of four required for each ventilator

METAL GRILLE KIT

Model MG1

- For L100/150/200/250/300 Series
- White enamel painted steel
- Mounting screws included

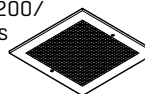

RADIATION DAMPERS

When excessive heat is detected, the breakaway fusible link triggers the closing of the radiation damper's fire resistant screen to prevent smoke and fire from traveling through ductwork.

Features

- 165° fusible link
- Galvanized steel frame
- Stainless steel negator-type closure spring



High Capacity Models RD1, RD2, RD3 (not shown)

- UL rated 3-hour ceiling radiation dampers
- High temperature, non-asbestos, reinforced fiber thermal fabric
- RD1 (12 $\frac{1}{2}$ " x 12 $\frac{1}{2}$ ") for L100/150/200/250/300 Series
- RD2 (21 $\frac{3}{4}$ " x 12 $\frac{1}{2}$ ") for L400/500/700 Series
- RD3 (22 $\frac{1}{4}$ " x 18 $\frac{1}{4}$ ") for L900/1500 Series

WALL CONTROLS

REMOTE IN-LINE VENTILATOR ACCESSORIES

Model DH100W

- Dehumidistat
- Dual voltage (24V/120V)
- Variable setting from 20–80% relative humidity
- Usage guide included



Model 70TW

- Thermostat for any fan 120, 250, 277 VAC, 22 amp capacity



DECORATOR WALL CONTROLS

Model 69W

- Single-Function Controls
- 120V, 15 amps



SPEED CONTROLS

Model 57W, 57V 3-Amp

- 120V, 3 amps
- Fits single-gang box
- Positive on/off action—dial for variable selection of air speeds and sound levels
- Built-in radio noise suppressor
- Blister packs available (P57W)



Model 72W, 72V 6-Amp

- 120V, 6 amps—Models 72W, 72V
- Same features as 57W/57V



TIMER & OFF-DELAY CONTROLS

Model 64W, 64V

- Fan/Light Control with Off-Delay
- Fan and light operate together when control is turned on
- Fan continues to operate for a user adjustable time period 5-60 minutes after light is turned off
- Center position bypasses timer and turns fan and light off immediately
- Fits single-gang box
- 120V, 4 amps (fan), 4 amps (light)
- Requires hot and neutral wires in the switch box

Model 80L

- For Broan High Capacity Fans L100–L900L
- Speed control with metal housing
- Fan insulation is perforated for easy installation
- 120V, 3 amps, 60 Hz
- cUL Listed

TWO-FUNCTION CONTROLS

Model 68W, 68V

- Two-Function Controls
- Two independent, 120V, 15 amp rocker switches (20 amps total)
- Fits single-gang box
- Blister packs available (P68W, P68V)



TIMER & OFF-DELAY CONTROLS

Model 59W, 59V, 71V

- Model 59W, 59V—up to 60 minutes
- Model 71V—up to 12 hours
- Fits single-gang box
- 120V, 20 amps; 240V, 10 amps
- Blister packs available (P59W, P59V)
- Operate continuously or for any set period



Model 61W, 61V

- Operate for any set period up to 15 minutes (no “continuous on” position)
- Other features same as 59W/59V



Specifications

Model	CFM/Sones .125" Ps (AMCA)		Housing Dimensions			Grille Dimensions		Amps at 60 Hz	Duct"	Watts	Volts
	CFM	Sones	L"	W"	H"	L"	W"				
L100	109	0.9	12 ³ / ₄	12 ³ / ₄	11 ³ / ₄	14	14	1.1	6	87	120
L100L	106	0.7	12 ³ / ₄	12 ³ / ₄	11 ³ / ₄	—	—	1.1	6	87	120
L100MG	115	0.9	12 ³ / ₄	12 ³ / ₄	11 ³ / ₄	14	14	1.1	6	87	120
L150	157	1.5	12 ³ / ₄	12 ³ / ₄	11 ³ / ₄	14	14	1.3	6	100	120
L150L	147	1.1	12 ³ / ₄	12 ³ / ₄	11 ³ / ₄	—	—	1.3	6	100	120
L150MG	161	1.4	12 ³ / ₄	12 ³ / ₄	11 ³ / ₄	14	14	1.3	6	100	120
L200	210	1.7	12 ³ / ₄	12 ³ / ₄	11 ³ / ₄	14	14	1.8	8	127	120
L200L	195	1.9	12 ³ / ₄	12 ³ / ₄	11 ³ / ₄	—	—	1.8	8	127	120
L200MG	215	1.9	12 ³ / ₄	12 ³ / ₄	11 ³ / ₄	14	14	1.8	8	127	120
L250	259	2.2	12 ³ / ₄	12 ³ / ₄	11 ³ / ₄	14	14	2.1	8	166	120
L250L	245	2.3	12 ³ / ₄	12 ³ / ₄	11 ³ / ₄	—	—	2.1	8	166	120
L250MG	265	2.5	12 ³ / ₄	12 ³ / ₄	11 ³ / ₄	14	14	2.1	8	166	120
L300	308	2.9	12 ³ / ₄	12 ³ / ₄	11 ³ / ₄	14	14	2.6	8	212	120
L300KMG	277	3.1	12 ³ / ₄	12 ³ / ₄	11 ³ / ₄	14	14	2.6	8	212	120
L300L	293	3.1	12 ³ / ₄	12 ³ / ₄	11 ³ / ₄	—	—	2.6	8	212	120
L300MG	316	3.0	12 ³ / ₄	12 ³ / ₄	11 ³ / ₄	14	14	2.6	8	212	120
L400	434	2.3	21 ¹ / ₂	12 ³ / ₄	11 ³ / ₄	23 ³ / ₄	14	1.4	4 ¹ / ₂ x 18 ¹ / ₂	146	120
L400K	406	3.3	21 ¹ / ₂	12 ³ / ₄	11 ³ / ₄	23 ³ / ₄	14	1.4	4 ¹ / ₂ x 18 ¹ / ₂	146	120
L400L	406	1.6	21 ¹ / ₂	12 ³ / ₄	11 ³ / ₄	—	—	1.4	4 ¹ / ₂ x 18 ¹ / ₂	146	120
L500	514	3.3	21 ¹ / ₂	12 ³ / ₄	11 ³ / ₄	23 ³ / ₄	14	2.2	4 ¹ / ₂ x 18 ¹ / ₂	232	120
L500K	481	4.4	21 ¹ / ₂	12 ³ / ₄	11 ³ / ₄	23 ³ / ₄	14	2.2	4 ¹ / ₂ x 18 ¹ / ₂	232	120
L500L	519	3.4	21 ¹ / ₂	12 ³ / ₄	11 ³ / ₄	—	—	2.2	4 ¹ / ₂ x 18 ¹ / ₂	232	120
L700	701	4.7	21 ¹ / ₂	12 ³ / ₄	11 ³ / ₄	23 ³ / ₄	14	2.9	4 ¹ / ₂ x 18 ¹ / ₂	313	120
L700L	681	3.7	21 ¹ / ₂	12 ³ / ₄	11 ³ / ₄	—	—	2.9	4 ¹ / ₂ x 18 ¹ / ₂	313	120
L900	901	4.1	22	18	18	23 ⁷ / ₈	19 ⁷ / ₈	3.0	8 x 12	306	120
L900L	894	3.8	22	18	18	—	—	3.0	8 x 12	306	120
L1500	1513	8.4	22	18	18	23 ⁷ / ₈	19 ⁷ / ₈	5.0	8 x 12	468	120
L1500L	1214	6.7	22	18	18	—	—	5.0	8 x 12	468	120
L2000L	1791	9.4	38	14 ⁵ / ₈	14 ⁵ / ₈	—	—	5.8	7 ³ / ₄ x 33 ³ / ₄	590	120

Sones and CFM listed for ceiling mount models are for horizontal ducting at .125" static pressure

Wall Controls

Model	L100– L700 Series	L900 Series	L1500 Series	L2000L Series	HD50L HD80L
57W 57V	•				
59W 59V	•	•	•	•	
61W 61V	•	•	•	•	
64W 64V	•	•			
68W 68V					•
69W	•	•	•	•	
70TW	•	•	•	•	
71V	•	•	•	•	
72W 72V	•	•	•	•	
80L	•	•			
DH 100W	•	•	•	•	

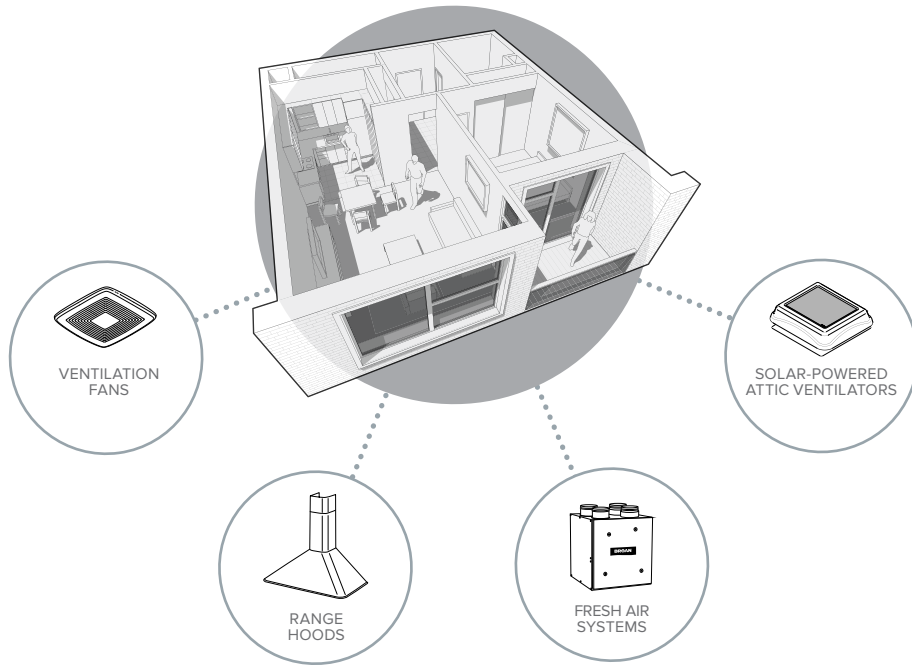

THE LEADER IN RESIDENTIAL INDOOR AIR QUALITY.
WELCOME TO A BROAN HOME.

Broan® is America's leading brand of residential ventilation products including range hoods, ventilation fans, heater/fan/light combination units, fresh air systems, whole-house fans and electric and solar-powered attic ventilators.



Broan.com

Broan-NuTone LLC, 926 W. State Street
Hartford, WI 53027 **800-558-1711**
In Canada call **877-896-1119**

America's Choice For Green Builders® Proud to be ENERGY STAR® partners.



0 26715 24032 6