

Straight Blade Plugs & Connectors for Any Application

Arrow Hart's extensive offering of straight blade plugs and connectors cover the full range of Hospital, Industrial and Commercial Specification Grades for applications where quality and durability are critical

Features & Benefits**Hospital Specification Grade Plugs & Connectors**

Built to meet and exceed UL Federal Specification and Hospital Grade testing, Arrow Hart's Hospital Grade Plugs and Connectors assure reliable performance in the most demanding healthcare applications.

**Industrial Specification Grade Plugs, Connectors, Flanged Inlet & Flanged Outlets**

With a variety of styles including SafetyGrip, AutoGrip and QuickGrip, these devices are designed to install quickly and easily and provide reliable performance in tough industrial environments.

**Commercial Specification Grade Straight Blade Plugs & Connectors**

Designed for light commercial applications, where ease-of-use, value and quality are critical.

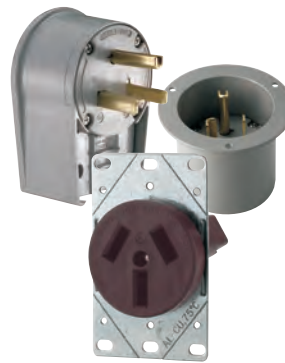
**Specification Grade Straight Blade Power Devices**

Heavy duty design and construction make Arrow Hart power devices ideal for any high amperage industrial or commercial power connectivity application.

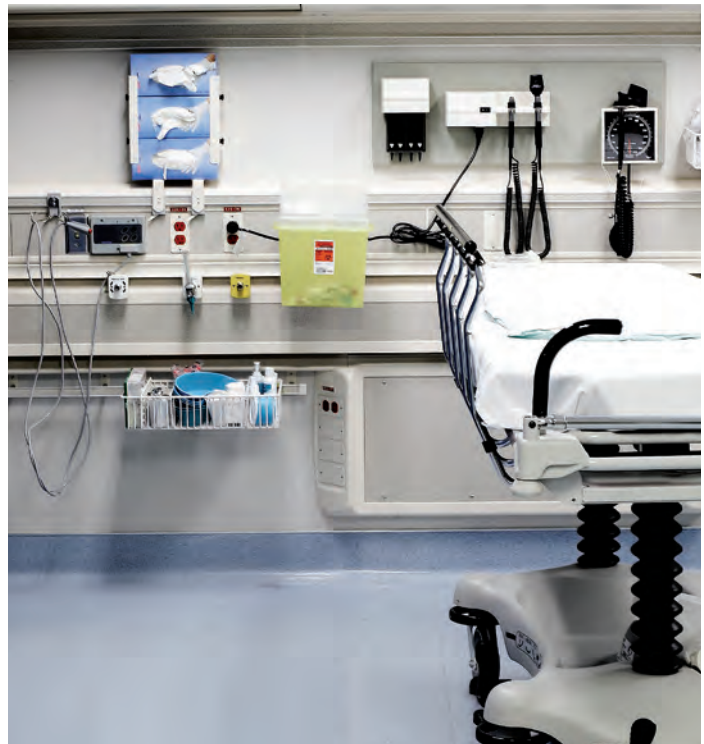
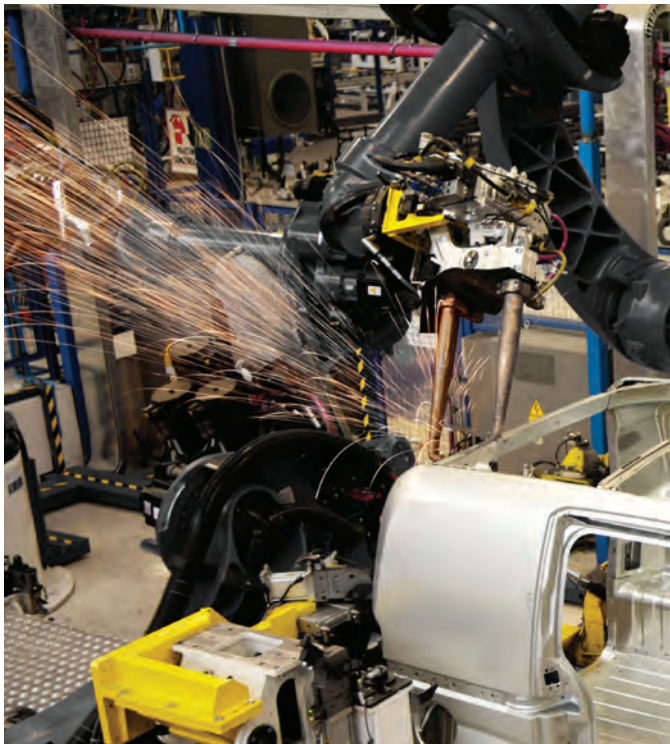

SafetyGrip Hospital and Industrial Grade Plugs & Connectors

1 Rugged nylon body resists impact and exposure to chemicals

2 Neoprene gasket seals around cord for added terminal protection from external elements

3 Dual range cord grip provides positive cord gripping while limiting strain on conductors

4 Rating information clearly marked on face of device

5 Wiring chamber provides generous space for wiring

6 Textured surface allows for easy grip and handling

Back Body

Front Body



SafetyGrip Hospital Grade devices exceed Federal Spec. and Hospital Grade testing for use in demanding healthcare environments



Clear terminal cover allows for easy inspection of conductors and terminations



Retained quick drive assembly screws speed installation



Four position angled plug option is ideal for applications requiring power cord to lay close to walls and floors

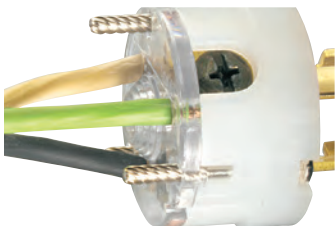

Tapered, individual wire pockets guide stranded wire into contact area for ease of installation

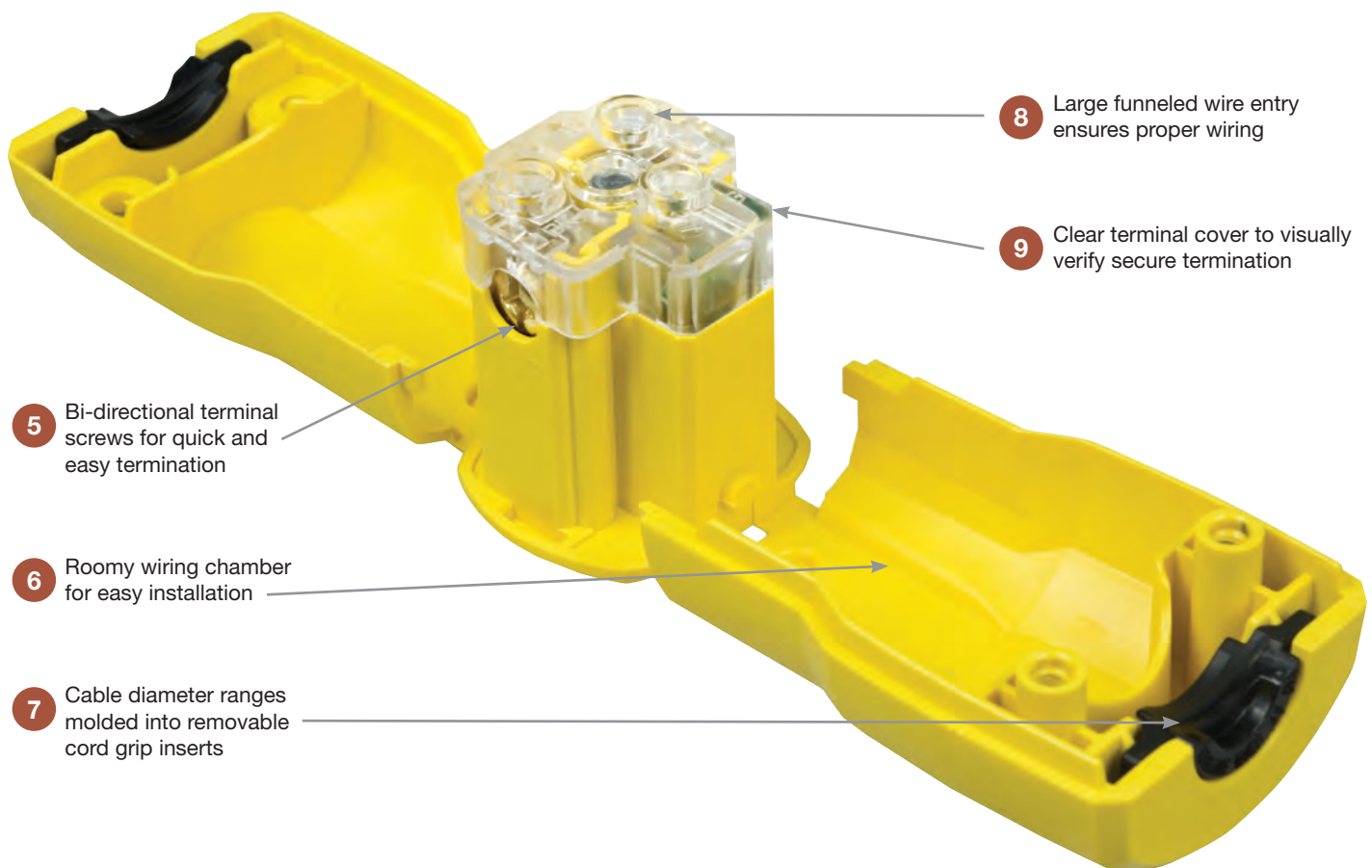
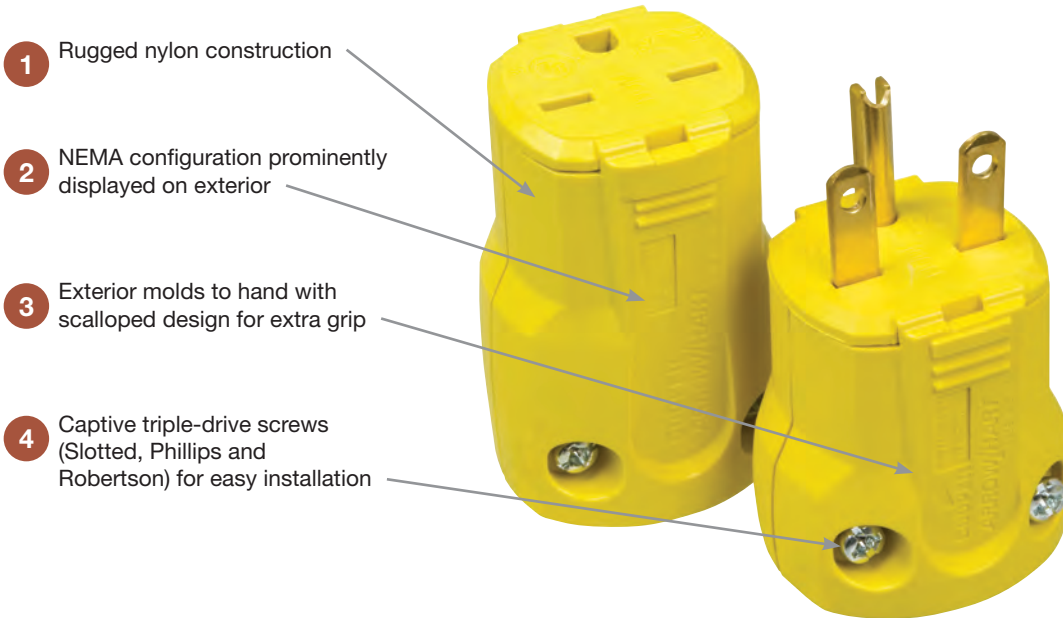

Multiple-head drive screws provide versatility for ease of use

QuickGrip Hospital and Industrial Grade Plugs & Connectors

Specifications and availability are subject to change without notice.

AutoGrip Hospital and Industrial Grade Plugs & Connectors

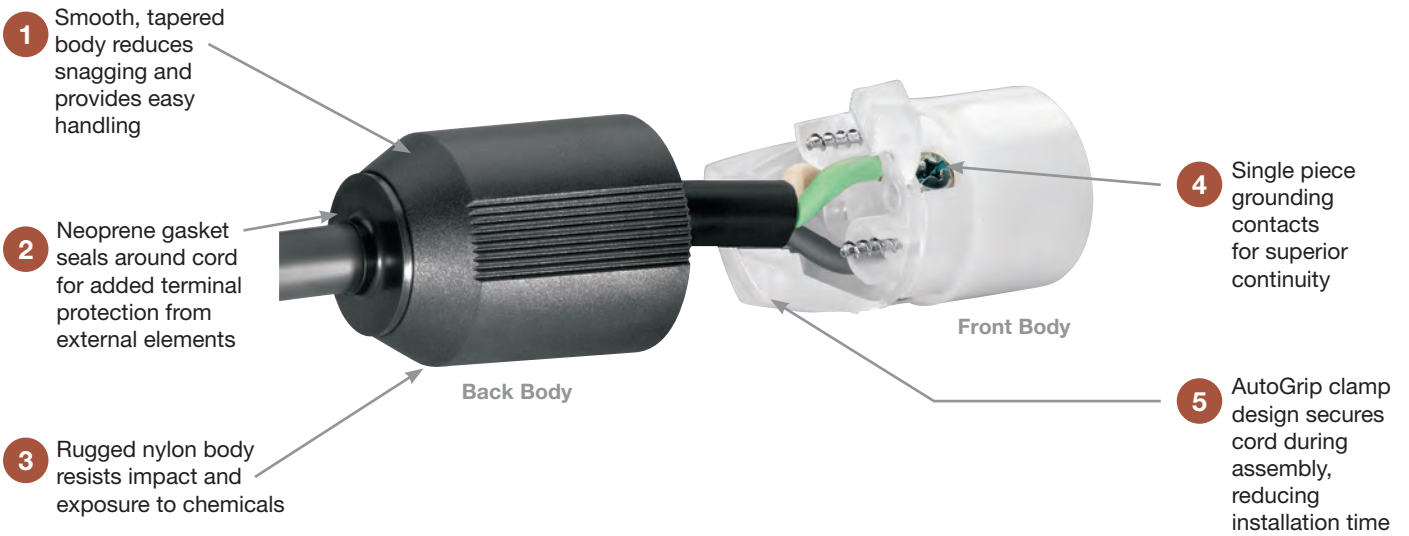

AutoGrip Hospital Grade devices exceed Federal Spec. and Hospital Grade testing for use in demanding healthcare environments



Unique clamp design secures cord during assembly, reducing installation time



Retained quick drive assembly screws speed installation



Multiple-head drive screws provide versatility for ease of use



Tapered, individual wire pockets guide stranded wire into contact area for ease of installation

Specifications and availability are subject to change without notice.

**Hospital Grade
Straight Blade
Plugs & Connectors**

2-Pole, 3-Wire Grounding
15A, 125V/AC
NEMA 5-15



5-15P



5-15R

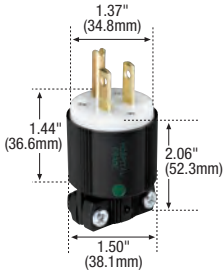

6266HG

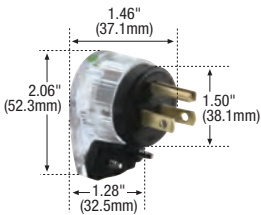

6265HGC



AH8119W

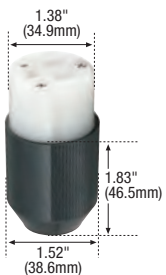

5369NHG

Hospital Grade Plugs & Connectors



Rating A	V/AC	NEMA	Description	Cord Diameter	Color	Plug Catalog No.	Connector Catalog No.	
15	125	5-15	SafetyGrip Straight Body	0.33-0.66" (8.3-16.7mm)	BK & W	<input type="checkbox"/> 6266HG	<input type="checkbox"/> 6269HG	•
			SafetyGrip Straight Body	0.33-0.66" (8.3-16.7mm)	C	<input type="checkbox"/> 6266HGC	<input type="checkbox"/> 6269HGC	•
			SafetyGrip Angled Body	0.33-0.66" (8.3-16.7mm)	BK & W	<input type="checkbox"/> 6265HG	—	•
			SafetyGrip Angled Body	0.33-0.66" (8.3-16.7mm)	C	<input type="checkbox"/> 6265HGC	—	•
			QuickGrip Straight Body	0.22-0.66" (5.6-16.7mm)	W	<input type="checkbox"/> AH8115W	<input type="checkbox"/> AH8119W	
			AutoGrip Straight Body	0.33-0.66" (8.3-16.7mm)	BK & W	<input type="checkbox"/> 5266NHG	<input type="checkbox"/> 5269NHG	•
			AutoGrip Isolated Ground, Straight Body	0.33-0.66" (8.3-16.7mm)	RN	<input type="checkbox"/> IG5266NHG	—	•

**Hospital Grade
Straight Blade
Plugs & Connectors**

2-Pole, 3-Wire Grounding
20A, 125V/AC
NEMA 5-20



5-20P



5-20R

Hospital Grade Plugs & Connectors



Rating A	V/AC	NEMA	Description	Cord Diameter	Color	Plug Catalog No.	Connector Catalog No.	
20	125	5-20	SafetyGrip Straight Body	0.33-0.66" (8.3-16.7mm)	BK & W	<input type="checkbox"/> 6766HG†	<input type="checkbox"/> 6769HG†	•
			SafetyGrip Angled Body	0.33-0.66" (8.3-16.7mm)	BK & W	<input type="checkbox"/> 6765HG†	—	•
			SafetyGrip Angled Body	0.33-0.66" (8.3-16.7mm)	C	<input type="checkbox"/> 6765HGC†	—	•
			AutoGrip Straight Body	0.33-0.66" (8.3-16.7mm)	BK & W	<input type="checkbox"/> 5366NHG*	<input type="checkbox"/> 5369NHG	•

† Not Nom Spec, * Not Fed Spec

Hospital Grade Dimensional
Information: B-14

Specification Information:

SafetyGrip HG Plugs &
Connectors: B-21
AutoGrip HG Plugs &
Connectors: B-21
QuickGrip HG Plugs &
Connectors: B-21

Color Information:

BK (Black), C (Clear), RN (Orange), W (White)



Specifications and availability are subject to change without notice.

Indicates NAFTA Compliant - Page R-30

Hospital Grade Straight Blade Receptacles

2-Pole, 3-Wire Grounding
15A, 250V/AC; 20A, 250V/AC
NEMA 6-15R, 6-20R

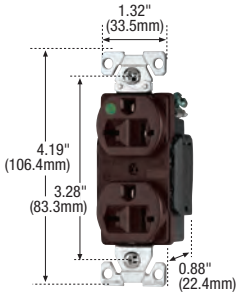
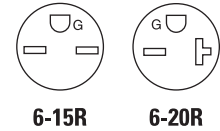

AH8400

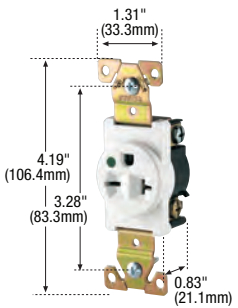

8410

Premium Hospital Grade Receptacles



Rating	A	V/AC	NEMA	Description	Color Suffix	Catalog No.			
15	250	6-15R	Duplex Receptacle, Back & Side Wire		V, W	<input type="checkbox"/> AH8600__			
			Single Receptacle, Back & Side Wire		V, W	<input type="checkbox"/> 8610__			
20	250	6-20R	Duplex Receptacle, Back & Side Wire		B, GY, RD, V, W	<input type="checkbox"/> AH8400__			
			Single Receptacle, Back & Side Wire		B, GY, RD, V, W	<input type="checkbox"/> 8410__			

Accessories for Hospital Grade NEMA 6-15 & 6-20 Receptacles

Description	Catalog No.	
1-Gang standard size duplex receptacle nylon wallplate, Ivory	<input type="checkbox"/> 5132V	
1-Gang standard size single receptacle wallplate, CuVerro	<input type="checkbox"/> 93091CU	
1-Gang mid-size duplex receptacle polycarbonate wallplate, Light Almond	<input type="checkbox"/> PJ8LA	
1-Gang standard size duplex receptacle wallplate, CuVerro	<input type="checkbox"/> 93101CUR	



Color Ordering Information:

For ordering devices, include Catalog No. followed by the Color Suffix: B (Brown), GY (Gray), RD (Red), V (Ivory), W (White)



Specifications and availability are subject to change without notice.

ArrowLink™ option available. Add "M" suffix to Standard catalog number (example AH8300W, AH8300WM). For ordering information on ArrowLink & ArrowLink SPD connectors, see Page K-2

Build-To-Spec Customizable Devices - Page K-4

Indicates NAFTA Compliant - Page R-30

Specification Information:
Premium HG Receptacles: A-26
ArrowLink Premium HG Receptacles: A-30 & A-31
CuVerro Wallplates L-22

Hospital Grade Straight Blade Plugs & Connectors

2-Pole, 3-Wire Grounding
15A, 250V/AC
NEMA 6-15

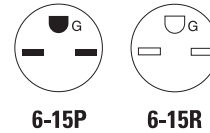

Hospital Grade Plugs & Connectors							
Rating A	V/AC	NEMA	Description	Cord Diameter	Color	Plug Catalog No.	Connector Catalog No.
15	250	6-15	SafetyGrip Angled Body	0.33-0.66" (8.3-16.7mm)	BK & W	□ 6665HG	—
			SafetyGrip Angled Body	0.33-0.66" (8.3-16.7mm)	C	□ 6665HGC	—

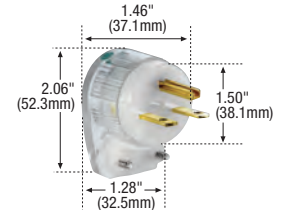

6665HGC

Hospital Grade Straight Blade Plugs & Connectors

2-Pole, 3-Wire Grounding
20A, 250V/AC
NEMA 6-20

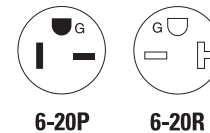

Hospital Grade Plugs & Connectors							
Rating A	V/AC	NEMA	Description	Cord Diameter	Color	Plug Catalog No.	Connector Catalog No.
20	250	6-20	SafetyGrip Angled Body	0.33-0.66" (8.3-16.7mm)	BK & W	□ 6865HG	—
			SafetyGrip Angled Body	0.33-0.66" (8.3-16.7mm)	C	□ 6865HGC	—



6865HG

Color Information:
BK (Black), C (Clear), W (White)

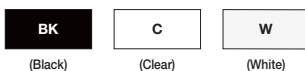

Specifications and availability are subject to change without notice.

Hospital Grade Dimensional Information: B-14

Specification Information:
Safety Grip HG Plugs & Connectors: B-21

Straight Blade Plugs & Connectors for Any Application

Arrow Hart's extensive offering of straight blade plugs and connectors cover the full range of Hospital, Industrial and Commercial Specification Grades for applications where quality and durability are critical

Features & Benefits**Hospital Specification Grade Plugs & Connectors**

Built to meet and exceed UL Federal Specification and Hospital Grade testing, Arrow Hart's Hospital Grade Plugs and Connectors assure reliable performance in the most demanding healthcare applications.

**Industrial Specification Grade Plugs, Connectors, Flanged Inlet & Flanged Outlets**

With a variety of styles including SafetyGrip, AutoGrip and QuickGrip, these devices are designed to install quickly and easily and provide reliable performance in tough industrial environments.

**Commercial Specification Grade Straight Blade Plugs & Connectors**

Designed for light commercial applications, where ease-of-use, value and quality are critical.

**Specification Grade Straight Blade Power Devices**

Heavy duty design and construction make Arrow Hart power devices ideal for any high amperage industrial or commercial power connectivity application.

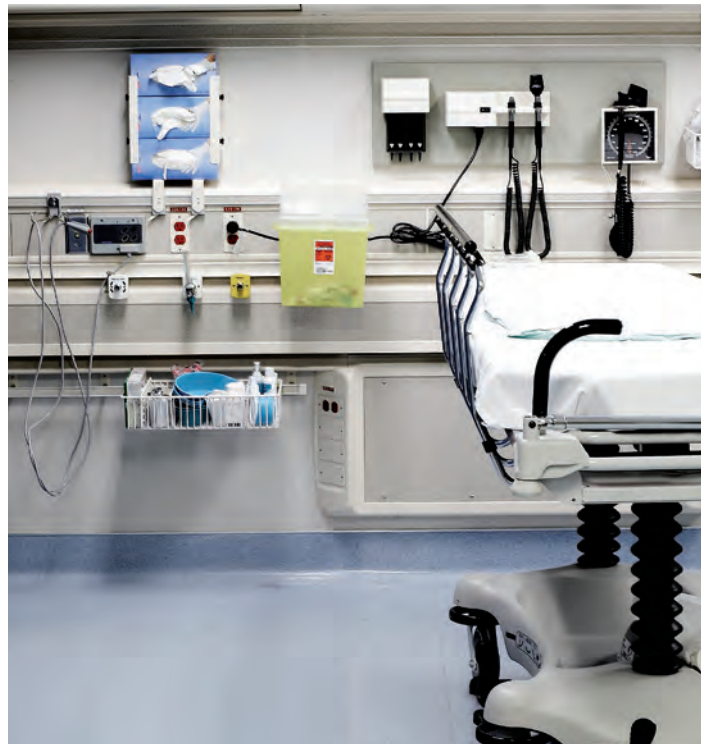
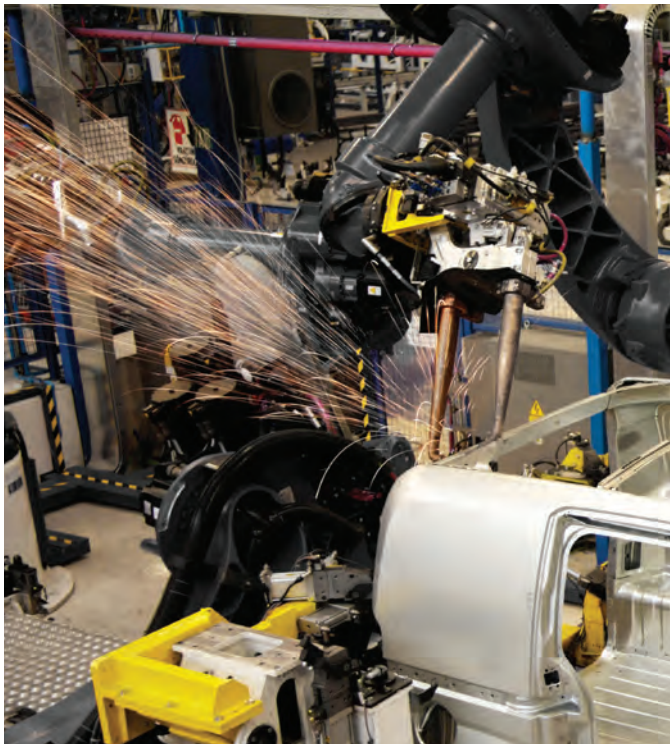

SafetyGrip Hospital and Industrial Grade Plugs & Connectors

1 Rugged nylon body resists impact and exposure to chemicals

2 Neoprene gasket seals around cord for added terminal protection from external elements

3 Dual range cord grip provides positive cord gripping while limiting strain on conductors

4 Rating information clearly marked on face of device

5 Wiring chamber provides generous space for wiring

6 Textured surface allows for easy grip and handling

Back Body

Front Body



SafetyGrip Hospital Grade devices exceed Federal Spec. and Hospital Grade testing for use in demanding healthcare environments



Clear terminal cover allows for easy inspection of conductors and terminations



Retained quick drive assembly screws speed installation



Four position angled plug option is ideal for applications requiring power cord to lay close to walls and floors

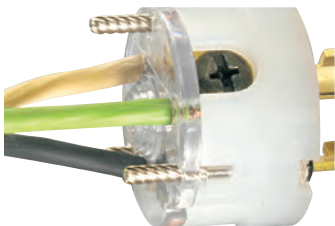

Tapered, individual wire pockets guide stranded wire into contact area for ease of installation

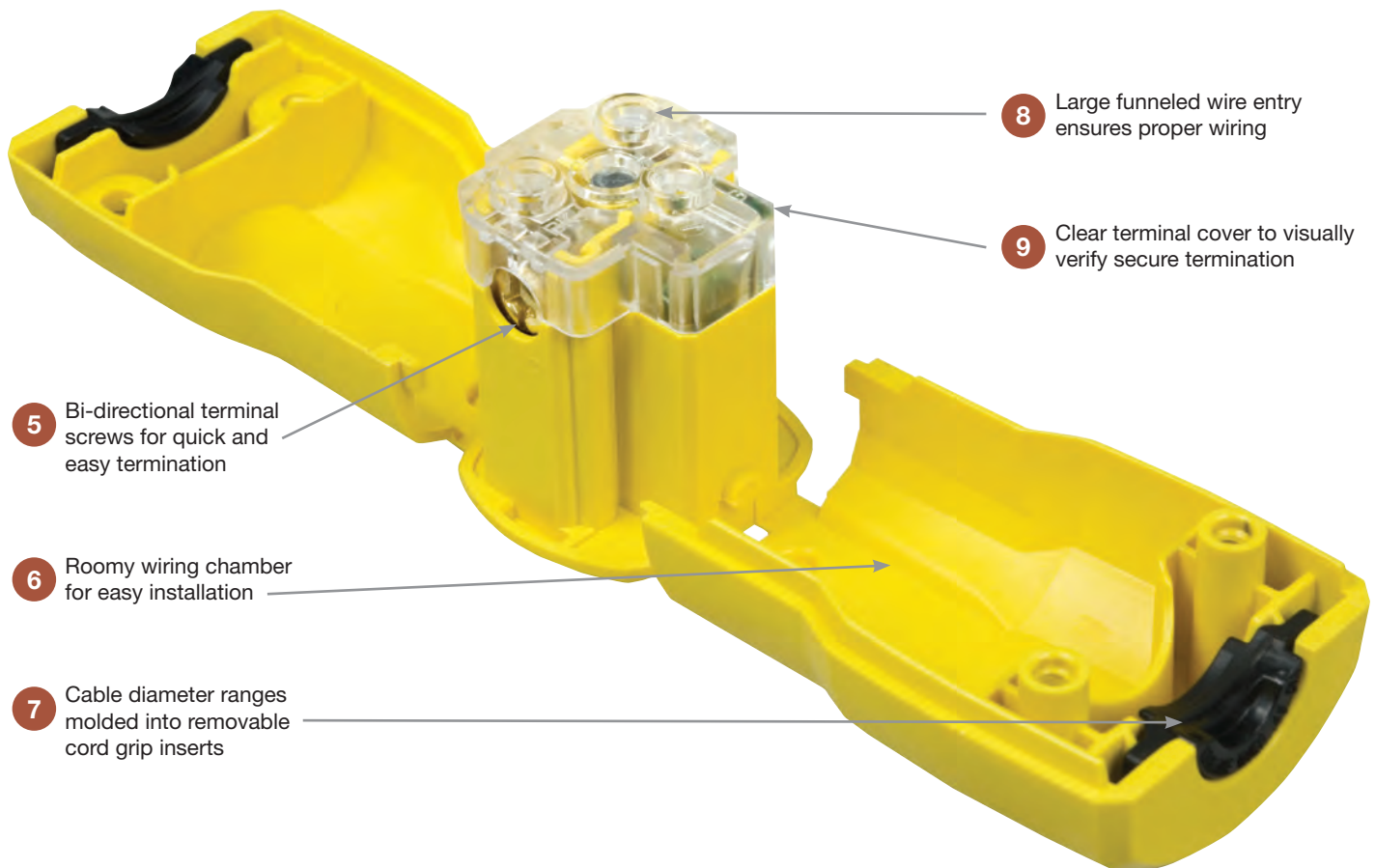
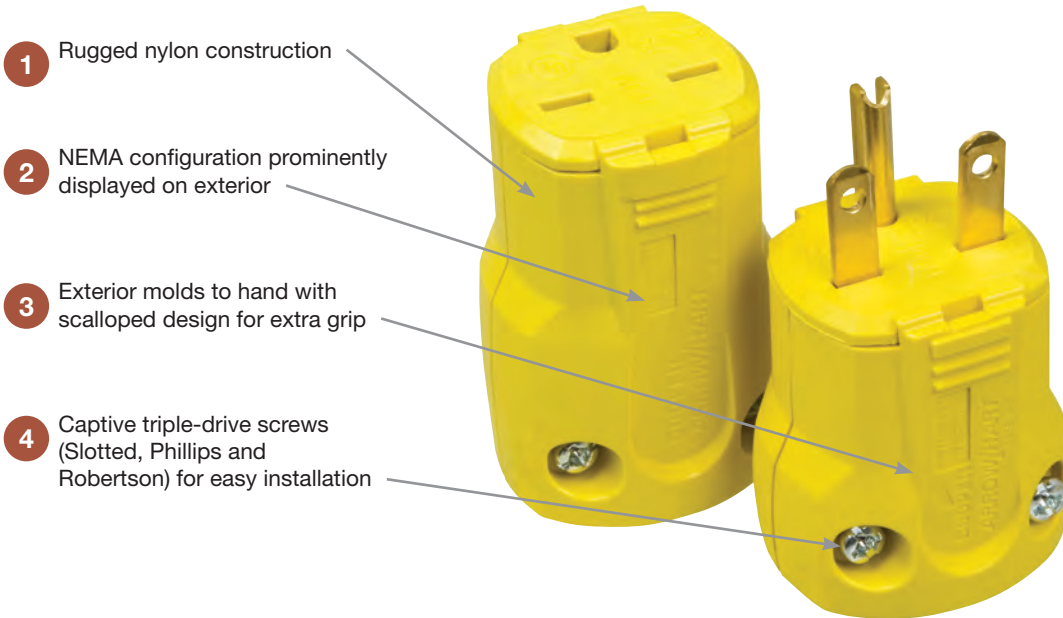

Multiple-head drive screws provide versatility for ease of use

QuickGrip Hospital and Industrial Grade Plugs & Connectors

Specifications and availability are subject to change without notice.

AutoGrip Hospital and Industrial Grade Plugs & Connectors

1 Smooth, tapered body reduces snagging and provides easy handling

2 Neoprene gasket seals around cord for added terminal protection from external elements

3 Rugged nylon body resists impact and exposure to chemicals

4 Single piece grounding contacts for superior continuity

5 AutoGrip clamp design secures cord during assembly, reducing installation time

Back Body

Front Body



AutoGrip Hospital Grade devices exceed Federal Spec. and Hospital Grade testing for use in demanding healthcare environments



Unique clamp design secures cord during assembly, reducing installation time



Retained quick drive assembly screws speed installation



Multiple-head drive screws provide versatility for ease of use



Tapered, individual wire pockets guide stranded wire into contact area for ease of installation

Specifications and availability are subject to change without notice.

**Hospital Grade
Straight Blade
Plugs & Connectors**

2-Pole, 3-Wire Grounding
15A, 125V/AC
NEMA 5-15



5-15P



5-15R

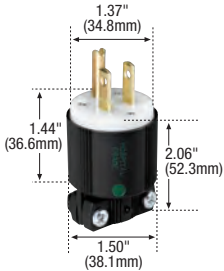

6266HG

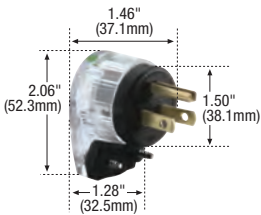

6265HGC



AH8119W

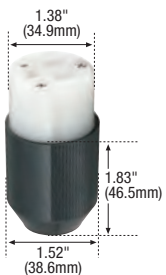

5369NHG

Hospital Grade Plugs & Connectors



Rating A	V/AC	NEMA	Description	Cord Diameter	Color	Plug Catalog No.	Connector Catalog No.	
15	125	5-15	SafetyGrip Straight Body	0.33-0.66" (8.3-16.7mm)	BK & W	□ 6266HG	□ 6269HG	•
			SafetyGrip Straight Body	0.33-0.66" (8.3-16.7mm)	C	□ 6266HGC	□ 6269HGC	•
			SafetyGrip Angled Body	0.33-0.66" (8.3-16.7mm)	BK & W	□ 6265HG	—	•
			SafetyGrip Angled Body	0.33-0.66" (8.3-16.7mm)	C	□ 6265HGC	—	•
			QuickGrip Straight Body	0.22-0.66" (5.6-16.7mm)	W	□ AH8115W	□ AH8119W	
			AutoGrip Straight Body	0.33-0.66" (8.3-16.7mm)	BK & W	□ 5266NHG	□ 5269NHG	•
			AutoGrip Isolated Ground, Straight Body	0.33-0.66" (8.3-16.7mm)	RN	□ IG5266NHG	—	•

**Hospital Grade
Straight Blade
Plugs & Connectors**

2-Pole, 3-Wire Grounding
20A, 125V/AC
NEMA 5-20



5-20P



5-20R

Hospital Grade Plugs & Connectors



Rating A	V/AC	NEMA	Description	Cord Diameter	Color	Plug Catalog No.	Connector Catalog No.	
20	125	5-20	SafetyGrip Straight Body	0.33-0.66" (8.3-16.7mm)	BK & W	□ 6766HG†	□ 6769HG†	•
			SafetyGrip Angled Body	0.33-0.66" (8.3-16.7mm)	BK & W	□ 6765HG†	—	•
			SafetyGrip Angled Body	0.33-0.66" (8.3-16.7mm)	C	□ 6765HGC†	—	•
			AutoGrip Straight Body	0.33-0.66" (8.3-16.7mm)	BK & W	□ 5366NHG*	□ 5369NHG	•

† Not Nom Spec, * Not Fed Spec

Hospital Grade Dimensional
Information: B-14

Specification Information:
SafetyGrip HG Plugs &
Connectors: B-21
AutoGrip HG Plugs &
Connectors: B-21
QuickGrip HG Plugs &
Connectors: B-21

Color Information:

BK (Black), C (Clear), RN (Orange), W (White)



Specifications and availability are subject to change without notice.

Indicates NAFTA Compliant - Page R-30

Hospital Grade Straight Blade Receptacles

2-Pole, 3-Wire Grounding
15A, 250V/AC; 20A, 250V/AC
NEMA 6-15R, 6-20R

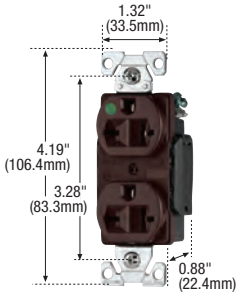
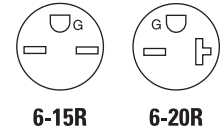

AH8400

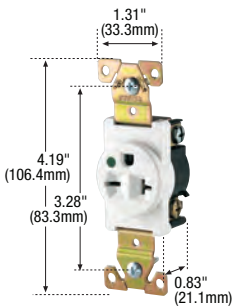

8410

Premium Hospital Grade Receptacles



Rating	A	V/AC	NEMA	Description	Color Suffix	Catalog No.			
15	250	6-15R	Duplex Receptacle, Back & Side Wire		V, W	<input type="checkbox"/> AH8600__			
			Single Receptacle, Back & Side Wire		V, W	<input type="checkbox"/> 8610__			
20	250	6-20R	Duplex Receptacle, Back & Side Wire		B, GY, RD, V, W	<input type="checkbox"/> AH8400__			
			Single Receptacle, Back & Side Wire		B, GY, RD, V, W	<input type="checkbox"/> 8410__			

Accessories for Hospital Grade NEMA 6-15 & 6-20 Receptacles

Description	Catalog No.	
1-Gang standard size duplex receptacle nylon wallplate, Ivory	<input type="checkbox"/> 5132V	
1-Gang standard size single receptacle wallplate, CuVerro	<input type="checkbox"/> 93091CU	
1-Gang mid-size duplex receptacle polycarbonate wallplate, Light Almond	<input type="checkbox"/> PJ8LA	
1-Gang standard size duplex receptacle wallplate, CuVerro	<input type="checkbox"/> 93101CUR	



5132V



93091CU



PJ8LA



93101CUR

Specification Information:
Premium HG Receptacles: A-26
ArrowLink Premium HG Receptacles: A-30 & A-31
CuVerro Wallplates L-22

Color Ordering Information:

For ordering devices, include Catalog No. followed by the Color Suffix: B (Brown), GY (Gray), RD (Red), V (Ivory), W (White)



Specifications and availability are subject to change without notice.



ArrowLink™ option available. Add "M" suffix to Standard catalog number (example AH8300W, AH8300WM). For ordering information on ArrowLink & ArrowLink SPD connectors, see Page K-2

Build-To-Spec Customizable Devices - Page K-4
 Indicates NAFTA Compliant - Page R-30

Hospital Grade Straight Blade Plugs & Connectors

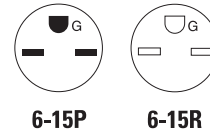
2-Pole, 3-Wire Grounding
15A, 250V/AC
NEMA 6-15



Hospital Grade Plugs & Connectors  							
Rating A	V/AC	NEMA	Description	Cord Diameter	Color	Plug Catalog No.	Connector Catalog No.
15	250	6-15	SafetyGrip Angled Body	0.33-0.66" (8.3-16.7mm)	BK & W	□ 6665HG	—
			SafetyGrip Angled Body	0.33-0.66" (8.3-16.7mm)	C	□ 6665HGC	—

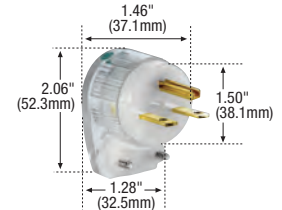



6665HGC

Hospital Grade Straight Blade Plugs & Connectors

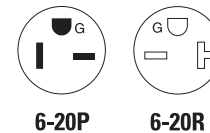
2-Pole, 3-Wire Grounding
20A, 250V/AC
NEMA 6-20



Hospital Grade Plugs & Connectors  							
Rating A	V/AC	NEMA	Description	Cord Diameter	Color	Plug Catalog No.	Connector Catalog No.
20	250	6-20	SafetyGrip Angled Body	0.33-0.66" (8.3-16.7mm)	BK & W	□ 6865HG	—
			SafetyGrip Angled Body	0.33-0.66" (8.3-16.7mm)	C	□ 6865HGC	—



6865HG

Color Information:
BK (Black), C (Clear), W (White)



Specifications and availability are subject to change without notice.

Hospital Grade Dimensional Information: B-14

Specification Information:
Safety Grip HG Plugs & Connectors: B-21