

## Nonmetallic Raceway with Twin Snap Cover System Available Factory Prewired

5400 Series™ Raceway provides wire and cable management for data, voice, video, and power applications. For school and office applications, this is an ideal solution for providing flexibility and accessibility of wire and cable.



5400 Series Raceway with  
Twin Snap Cover System.

### FEATURES & BENEFITS

- **Large cable capacity in a low profile design.** Accommodates needs now and in the future.
- **Twin Snap cover.** Complete segregation of access to power and low voltage services for installation flexibility.
- **Corner drop feed.** Provides solution for feeding horizontal runs of raceway.
- **2" (51mm) bend radius compliant fittings.** These fittings snap onto overlapping raceway base and cover for an aesthetic installation. Fittings are UL verified for a 2" (51mm) bend radius and exceed the recommendations of TIA/EIA 569-A. They provide cable protection in lay-in and pull through cable installations.
- **5400TB available prewired.** Manufactured to specified job site lengths, raceway comes completely prewired, ready to install. Jobs can be packaged by area, floor, or building and shipped per job site requirements.
- **Electrical device identification for prewired jobs.** Eliminates guesswork and circuit tracing to speed additions and renovations.
- **A/V compatible.** 5507 Series Faceplates provide A/V compatibility for 5400 Series Raceway installations.
- **Pre-punched mounting holes.** Faster and easier raceway installation.
- **Device mounting in-line, offset or both.** Offers flexibility and up to three separate services at the same location.
- **Made of PVC material.** Lightweight and easy to cut. Meets UL flammability requirements. UL Listed for up to 600V.
- **Ivory and white finishes.** Blend with any decor. Custom colors available. Consult factory for more information. Paintable using latex paint.
- **Communication connectivity options.** Accepts industry standard and proprietary devices from a wide range of manufacturers to provide a seamless and aesthetically pleasing interface for voice, data, audio, and video applications at the point of use.
- **UL and cUL Listed component raceways.** File E90378 Guide RJTX, Fittings: File E90377 Guide RJYT. Meets Article 388 of NEC and meets Section 12-600 of CEC.

## 5400 Series Raceway System Layout

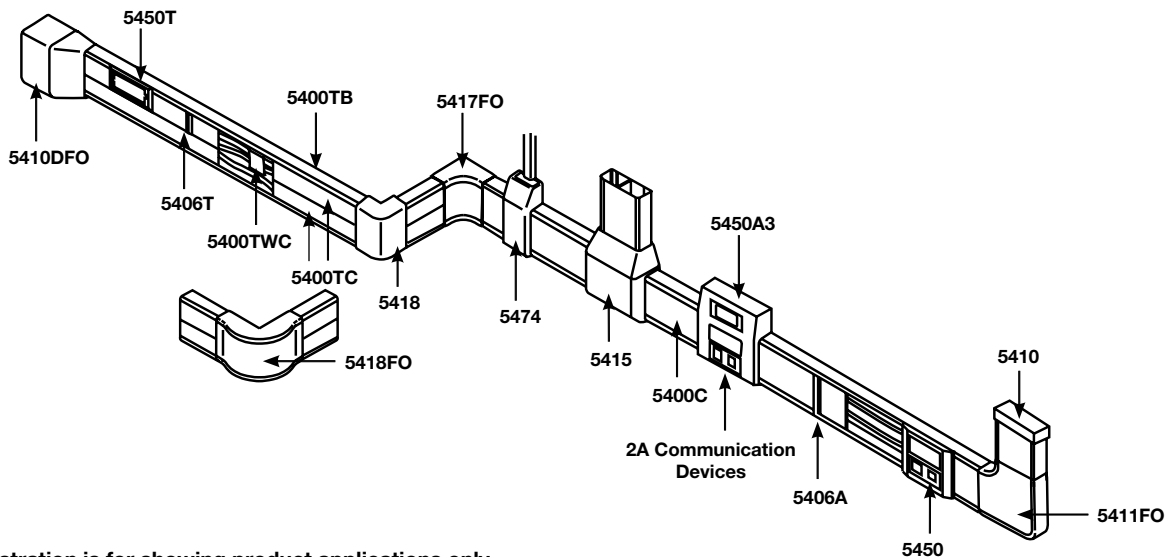

## 5400T Series Raceway & MXN Series Raceway Wire Fill Capacity Charts

### 5400TB Series Raceway Wire Fill Capacities for Power

	WIRE SIZE CABLE/WIRE SIZE	O.D. (Approx. Dia.)		NO. OF CONDUCTORS	
		Inches	(mm)	COMP. A	COMP. B*
POWER WIRING WITHOUT DEVICES	14 AWG	0.111	(2.8)	50	50
	12 AWG	0.130	(3.3)	34	34
	10 AWG	0.164	(4.2)	60	60
	8 AWG	0.216	(5.5)	21	21
	6 AWG	0.254	(6.5)	19	19
POWER WIRING WITH DEVICES	14 AWG	0.111	(2.8)	50	50
	12 AWG	0.130	(3.3)	34	34
	10 AWG	0.164	(4.2)	60	60
	8 AWG	0.216	(5.5)	21	21
	6 AWG	0.254	(6.5)	19	19

\* Total raceway capacity not to exceed capacity specified in Compartment B.

### 5400TB Series Raceway Wire Fill Capacities for Communications

	CABLE/WIRE SIZE	O.D. (Approx. Dia.)		COMP. A
		Inches	(mm)	40% FILL*
UNSHIELDED TWISTED PAIR	4-pair, 24 AWG Cat 3	0.190	(4.8)	52
	4-pair, 24 AWG Cat 5e	0.210	(5.3)	42
	4-pair, 24 AWG Cat 6	0.250	(6.3)	30
	4-pair, 24 AWG Cat 6a**	0.250	(6.3)	15
	25-pair, 24 AWG	0.250	(6.3)	11
COAXIAL	RG6/U	0.270	(6.9)	26
FIBER	ZipCord	0.118 x 0.236	(3 x 6)	53
	Round 4-Strand Fiber	0.187	(4.8)	54
	Round 6-Strand Fiber	0.256	(6.5)	28

\* Wire fill capacity is reduced to allow for proper conductor bend radius and maximum permissible heat rise.

\*\* Category 6 augmented (6a) cable for 10 gigabit Ethernet – maximum allowed cable diameter per addenda No. 11 ANSI TIA/EIA 568-B.2.



**PEP  
ECO  
PASS  
PORT®**

Download this product's PEP ecopassport® environmental product declaration at [www.legrand.us/resources-and-downloads](http://www.legrand.us/resources-and-downloads). This declaration conforms with ISO 14025 and 14040 and is in alignment with EN 15804.

## 5400T Series Raceway & MXN Series Raceway Wire Fill Capacity Charts (continued)

### MXN Series Raceway Wire Fill Capacities for Power

WIRE SIZE CABLE/WIRE SIZE	O.D. (Approx. Dia.) Inches (mm)	NO. OF CONDUCTORS EACH COMPARTMENT
14 AWG	0.111 (2.8)	16
12 AWG	0.130 (3.3)	14
10 AWG	0.164 (4.2)	14
8 AWG	0.216 (5.5)	15

Total Raceway Capacity is  
7.44 sq. in. (4800mm<sup>2</sup>)

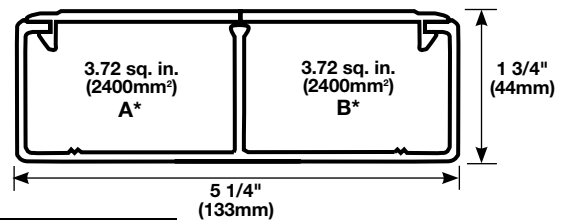

### MXN Series Raceway Wire Fill Capacities for Communications

	CABLE/WIRE SIZE	O.D. (Approx. Dia.) Inches (mm)	EA. COMPARTMENT 40% FILL
UNSHIELDED TWISTED PAIR	4-pair, 24 AWG Cat 3	0.190 (4.8)	19
	4-pair, 24 AWG Cat 5e	0.210 (5.3)	16
	4-pair, 24 AWG Cat 6	0.250 (6.3)	11
	4-pair, 24 AWG Cat 6a*	0.250 (6.3)	5
	25-pair, 24 AWG	0.250 (6.3)	4
COAXIAL	RG6/U	0.270 (6.9)	9
FIBER	ZipCord	0.118 x 0.236 (3 x 6)	20
	Round 4-Strand Fiber	0.187 (4.8)	20
	Round 6-Strand Fiber	0.256 (6.5)	10

**NOTE:** Wire fill capacity is reduced to allow for proper conductor bend radius and maximum permissible heat rise.

\* Category 6 augmented (6a) cable for 10 gigabit Ethernet – maximum allowed cable diameter per addenda No. 11 ANSI TIA/EIA 568-B.2.

## 5400 Series Raceway Ordering Information

Catalog No./Item	Description/Specifications	Catalog No./Item	Description/Specifications
<b>5400TB</b> 	<b>Two-Compartment Base</b> – Two equal compartments – Base accepts single or Twin Snap Cover. 5400TB Series Raceway available in 8' (2.44m) lengths with pre-punched mounting holes	<b>MXN2F21</b> 	<b>Entrance End Fitting</b> – For feeding corner drop raceway from larger conduits. Has concentric 3/4", 1", and 1 1/2" trade size KOs.
<b>5400C</b> 	<b>Full Width Cover</b> – Use with 5400TB. Available in 8' (2.44m) lengths.	<b>MXN2A08</b> 	<b>Corner Drop Raceway Base and Cover</b> – Used as a vertical corner feed drop to horizontal run of 5400 or 40N2 Series Raceways. Two compartments. Packaged with base and cover.
<b>5400TC</b> 	<b>Twin Snap Cover</b> – Use with 5400TB Series Raceway in Twin Snap applications. Order separate cover for each compartment. Available in 8' (2.44m) lengths.	<b>MXN2FWC</b> 	<b>Wire Clip</b> – Retains wires in MXN2A08 Corner Drop Raceway.
<b>5400TWC</b> 	<b>Twin Snap Cover Wire Clip</b> – Retains wires in raceway.		

**NOTE:** No suffix denotes Ivory finish. Add "-WH" suffix for White finish.

## 5400 Series Raceway Fittings Ordering Information

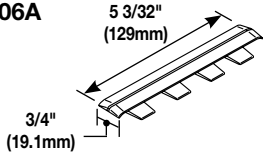
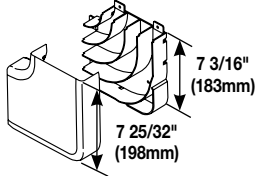
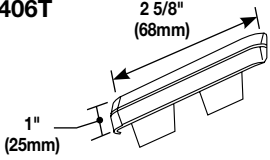
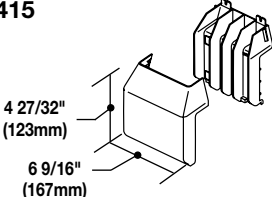
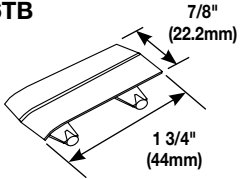
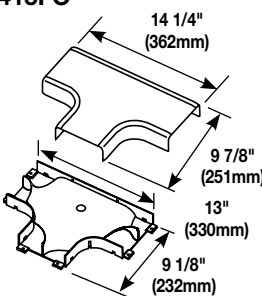
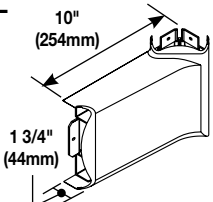
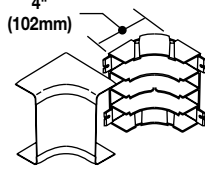
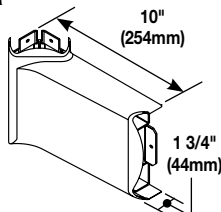
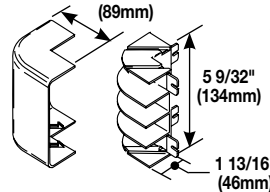
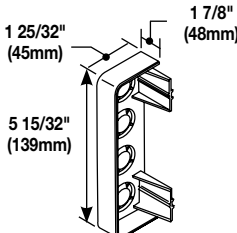
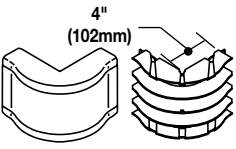
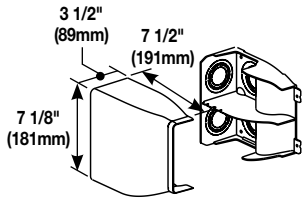
Catalog No./Item	Description/Specifications	Catalog No./Item	Description/Specifications
<b>5406A</b>  <p>5 3/32" (129mm) 3/4" (19.1mm)</p>	<b>Cover Clip</b> – For covering joint where two pieces of 5400T Cover come together.	<b>5411FO</b>  <p>7 3/16" (183mm) 7 25/32" (198mm)</p>	<b>Bend Radius Full Capacity Flat Elbow</b> – For right angle turns on the same surface. Integral dividers provide 2" (51mm) cable bend radius for UTP and Fiber Optic installations. Ideal for lay-in or pull-through installations.
<b>5406T</b>  <p>2 5/8" (68mm) 1" (25mm)</p>	<b>Twin Snap Cover Clip</b> – For covering joint where two pieces of 5400TC Cover come together.	<b>5415</b>  <p>4 27/32" (123mm) 6 9/16" (167mm)</p>	<b>Tee</b> – For branching raceway at right angles.
<b>5406TB</b>  <p>7/8" (22.2mm) 1 3/4" (44mm)</p>	<b>Base Seam Clip</b> – For covering joint where two pieces of 5400TB Base come together.	<b>5415FO</b>  <p>14 1/4" (362mm) 9 7/8" (251mm) 13" (330mm) 9 1/8" (232mm)</p>	<b>Bend Radius Full Capacity Tee</b> – For branching raceway at right angles. Provides separation of services and 2" (51mm) cable bend radius for UTP and Fiber Optic installations.
<b>5408L</b>  <p>10" (254mm) 1 3/4" (44mm)</p>	<b>Transition Fitting</b> – For transitioning from MXN2A08 Corner Drop to a horizontal run of 5400TB Series Raceway to the left.	<b>5417FO</b>  <p>4" (102mm)</p>	<b>Bend Radius Full Capacity Internal Elbow</b> – A full capacity 90° internal corner with integral dividers that provide 2" (51mm) cable bend radius for UTP and Fiber Optic installations. Ideal for lay-in or pull-through installations.
<b>5408R</b>  <p>10" (254mm) 1 3/4" (44mm)</p>	<b>Transition Fitting</b> – For transitioning from MXN2A08 Corner Drop to a horizontal run of 5400TB Series Raceway to the right.	<b>5418</b>  <p>3 1/2" (89mm) 5 9/32" (134mm) 1 13/16" (46mm)</p>	<b>External Elbow</b> – For right angle turns around external corners.
<b>5410</b>  <p>1 25/32" (45mm) 1 7/8" (48mm) 5 15/32" (139mm)</p>	<b>Blank End Fitting</b> – For closing open end of 5400TB Series Raceway. Has four 1/2" trade size KOs for end feed.	<b>5418FO</b>  <p>4" (102mm)</p>	<b>Bend Radius Full Capacity External Elbow</b> – For right angle turns around external corners. Integral dividers provide 2" (51mm) cable bend radius for UTP and Fiber Optic installations. Use the 5418FO as a radiused alternative to 5418.
<b>5410DFO</b>  <p>3 1/2" (89mm) 7 1/2" (191mm) 7 1/8" (181mm)</p>	<b>Bend Radius Divided Entrance End Fitting</b> – Divided fitting to feed 5400TB Series Raceway. Includes 1", 1 1/4", 1 1/2", and 2" trade size KOs on back and top.		

**NOTE:** No suffix denotes Ivory finish. Add "-WH" suffix for White finish.

## 5400 Series Raceway Fittings Ordering Information (Continued)

Catalog No./Item	Description/Specifications	Catalog No./Item	Description/Specifications
<b>5450</b> 	<b>Device Bracket</b> – For mounting power and communication devices in-line with 5400TB Series Raceway. For use with 5507 Series Faceplates, Ortronics® TracJack and Series II Modules, Pass & Seymour® Activate Series Inserts, and Wiremold CM2 Series Open System Communication Modules.	<b>CM-EPLA*</b> 	<b>End Plates</b> – Includes two outlet identification labels with clear covers and two matching screw covers. Required for mounting Pass & Seymour Activate and Wiremold CM2 Series Open System communication modules into 5450 Series device brackets.
<b>5450T</b> 	<b>Twin Snap Cover Device Bracket</b> – For power or communication devices in a single compartment. For use with 5507 Series Faceplates, Ortronics® TracJack and Series II Modules, Pass & Seymour® Activate Series Inserts, and Wiremold CM2 Series Open System Communication Modules.	<b>5474</b> 	<b>Transition Fitting</b> – Makes transition from 5400TB Series Raceway to 400, 800, 2300 Series Raceways or Eclipse™ PN03, PN05, and PN10 Series Raceways.
<b>5450A3</b> 	<b>Three Device Mounting Bracket</b> – For mounting up to three power or communication devices at one location in-line and offset from 5400TB Series Raceway. For use with 5507 Series Faceplates, Ortronics® TracJack and Series II Modules, Pass & Seymour® Activate Series Inserts, and Wiremold CM2 Series Open System Communication Modules.		

**NOTE:** No suffix denotes Ivory finish. Add “-WH” suffix for White finish.

\* **CM-EPLA** End Plates are required when using Wiremold CM2 Series Open System communication modules and Pass & Seymour® Activate inserts. **S2-EPL** End Plates are required when using Ortronics Series II inserts. To mount Ortronics TracJack inserts, use 5507-4TJ or 5507-6TJ Faceplates.

TRANSITION FITTINGS TO EXISTING WIRING OR OTHER WIREMOLD RACEWAYS		
CONNECTION REQUIRED		CATALOG NUMBER
FROM	TO	
5400TB	400, 800, 2300	5474
5400TB	PN03, PN05, PN10	5474
5400TB	MXN2A08	5408L/5408R
1/2" Trade size Conduit or Armored Cable	Side of 5400	5410 or 5410DFO
3/4", 1", 1 1/2" & 2" Trade size Conduit or Armored Cable	Back or Side of 5400TB	5410DFO



Ideal for offices and classrooms.

## 5507 Series Faceplates Ordering Information

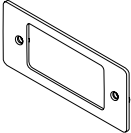
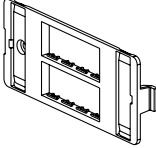
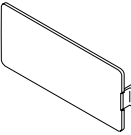
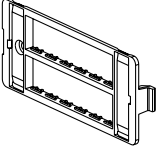
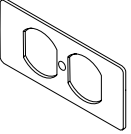
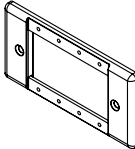
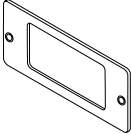
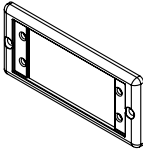
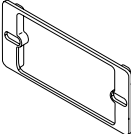
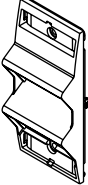
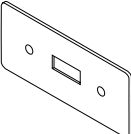
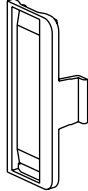
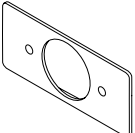
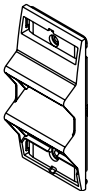
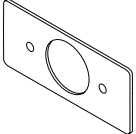
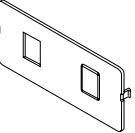
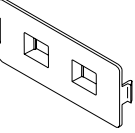
Catalog No./Item	Description/Specifications	Catalog No./Item	Description/Specifications
5507AD	 <b>Modular Furniture Adapter</b> – For mounting modular furniture adapters.	5507-4TJ	 <b>Ortronics® Faceplate</b> – For mounting Ortronics® communication inserts. Accepts four TracJack Devices.
5507B	 <b>Blank Faceplate</b> – For covering unused compartments in the device bracket.	5507-6TJ	 <b>Ortronics® Faceplate</b> – For mounting Ortronics® communication inserts. Accepts six TracJack Devices.
5507D	 <b>Duplex Faceplate</b> – For covering duplex style devices. Accepts 106 Frame.	5507MAAP	 <b>Extron® MAAP Faceplate</b> – Accepts four Extron® Electronics MAAP single space modules.
5507R	 <b>Rectangular Faceplate</b> – For covering rectangular style devices.	5507AAP	 <b>Extron® AAP Faceplate</b> – Accepts two Extron® Electronics AAP single space modules.
5507S	 <b>Rectangular Spacer</b> – For mounting commercial device plates. Installs between the device bracket and a device.	CM-ARA	 <b>Angled Raceway Adapter</b> – Includes two outlet identification labels with clear covers and two matching screw covers. Provides angled exit in multi-channel raceway systems and WallSource™ Boxes. Accepts two Pass & Seymour® Activate 2A size modules or two Wiremold CM2 Series open System communication modules. Snaps into standard device mounting brackets. Fits 5507 Series Faceplate opening.
5507SW	 <b>Switch Faceplate</b> – For covering standard toggle switches.	S2-EPL	 <b>End Plate</b> – For mounting Ortronics® Series II modules into 5507 opening. Includes two outlet identification labels with clear covers and two matching screw covers.
5507T1	 <b>Single Receptacle Faceplate</b> – For covering single receptacles – 1.59" (40mm) diameter.	ARA-S2	 <b>Angled Raceway Adapter</b> – For use with multi-channel raceway device brackets and WallSource device mounting brackets. Angled exit provides additional mounting depth required for A/V connections, as well as ensuring the required bend radius for UTP and fiber optic cabling. Holds two Ortronics® Series II modules. Fits 5507 Series Faceplate opening.
5507T2	 <b>Single Receptacle Faceplate</b> – For covering single receptacles – 1.41" (36mm) diameter.		
5507RJ	 <b>Dual RJ11/RJ45 Connector Faceplate</b> – For mounting one or two RJ keystone type connectors – has one opening and a KO for the other.		
5507FRJ	 <b>Flush Dual RJ11/RJ45 Connector Faceplate</b> – Same as 5507RJ except the connectors are recessed to provide a flush installation.		

**NOTE:** No suffix denotes Ivory finish. Add “-WH” suffix for White finish. All faceplates have a standard measurement of 4 1/4" x 1 7/8" (108mm x 34mm).

## 5400 Series Raceway Prewired Features

Features	Standard	Options
<b>Communication Devices</b>	Ortronics or Pass & Seymour Activate™ Connectivity System Devices	Other manufacturers
<b>Electrical Devices</b>	Pass & Seymour	Other manufacturers and some international devices
<b>Base Length</b>	Longest = 8' (2.4m), shortest = 1' (305mm)	–
<b>Finish</b>	PVC – White or Ivory	Custom colors
<b>Wire Type</b>	THHN Stranded	Options per specification
<b>Wiring Splices</b>	Insulation displacement connectors	Continuous wiring or twist-on wire connector
<b>Grounding Conductors</b>	Wire gauge per National Electrical Code (NEC) and shared grounding wires	Oversized and/or separate grounding wires
<b>Device Identification</b>	Gray self-adhesive polyester label with black letters	Self-adhesive engraved nameplate
<b>Neutrals</b>	Shared neutral	Oversized and/or separate neutral wires
<b>Pigtails</b>	1' (305mm) feeds and receptacle leads	Per specification
<b>Conduit Feeds</b>	Raceway drilled at job site	Entrance end cap
<b>Record Drawings</b>	3 sets and 2 copies of marked-up blueprints	Per job requirements
<b>Submittal Services</b>	Detailed Submittal	Submittal Free

## Device and Raceway Labeling Detail for Prewired Applications

- Device labeling is available in the following materials:
  - Gray self-adhesive polyester label with black lettering (standard).
  - Other color self-adhesive polyester labels.
  - Engraving of covers with black lettering.
  - Engraved phenolic nameplates with adhesive backing.
- The back of the raceway is labeled with the raceway number and the room or area number(s).
- Data and power requirements can be switched with data on top and power on bottom.

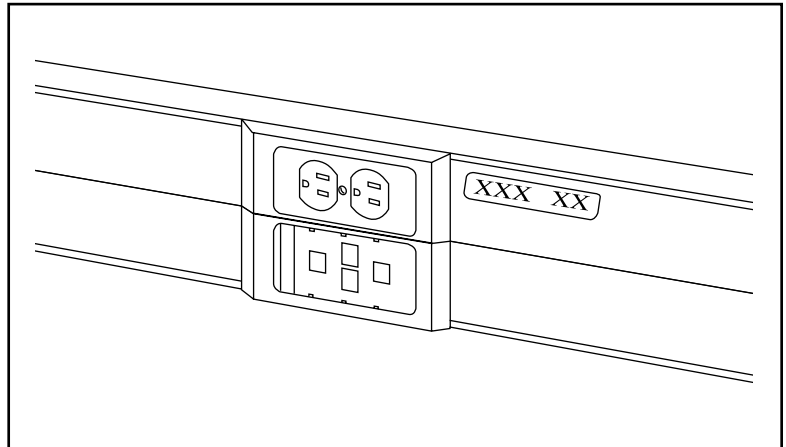

## 5400 Series Raceway Ordering Specifications for Prewired Applications

**Two options available when ordering a prewired job:**

- 1. Detailed Submittal** The detailed submittal will show exactly how each raceway run will be built including lengths, number and type of receptacles, wiring schematics, circuiting information, etc. The contractor and/or distributor must review, clarify any information not clearly indicated on the drawings or specs, approve, and return to the factory before production can begin.
- 2. Submittal Free** The Wiremold Prewired Express™ Building Plan Checklist is filled out by the contractor or distributor and sent along with plans, casework, and specs to the factory. No submittal is required and the project is scheduled for production upon receipt of all necessary information.

**NOTE: All brand and product names referenced in this document are registered trademarks or trademarks of their respective holders.**



**NOTE:** The paper used to print this document is an environmentally responsible paper with 10% post consumer waste, with FSC and SFI Chain of Custody certifications, Lacey Act compliant. 100% of the electricity used to manufacture Flo sheets is generated with Green-e certified renewable energy.



**Electrical Wiring Systems**

60 Woodlawn Street  
West Hartford, CT 06110  
Phone: 1.877.BY.LEGRAND (295-3472)  
[www.legrand.us](http://www.legrand.us)

570 Applewood Crescent  
Vaughan, Ontario L4K 4B4  
Phone: 905.738.9195  
[www.legrand.ca](http://www.legrand.ca)





## Nonmetallic Raceway with Twin Snap Cover System Available Factory Prewired

5400 Series™ Raceway provides wire and cable management for data, voice, video, and power applications. For school and office applications, this is an ideal solution for providing flexibility and accessibility of wire and cable.



5400 Series Raceway with  
Twin Snap Cover System.

### FEATURES & BENEFITS

- **Large cable capacity in a low profile design.** Accommodates needs now and in the future.
- **Twin Snap cover.** Complete segregation of access to power and low voltage services for installation flexibility.
- **Corner drop feed.** Provides solution for feeding horizontal runs of raceway.
- **2" (51mm) bend radius compliant fittings.** These fittings snap onto overlapping raceway base and cover for an aesthetic installation. Fittings are UL verified for a 2" (51mm) bend radius and exceed the recommendations of TIA/EIA 569-A. They provide cable protection in lay-in and pull through cable installations.
- **5400TB available prewired.** Manufactured to specified job site lengths, raceway comes completely prewired, ready to install. Jobs can be packaged by area, floor, or building and shipped per job site requirements.
- **Electrical device identification for prewired jobs.** Eliminates guesswork and circuit tracing to speed additions and renovations.
- **A/V compatible.** 5507 Series Faceplates provide A/V compatibility for 5400 Series Raceway installations.
- **Pre-punched mounting holes.** Faster and easier raceway installation.
- **Device mounting in-line, offset or both.** Offers flexibility and up to three separate services at the same location.
- **Made of PVC material.** Lightweight and easy to cut. Meets UL flammability requirements. UL Listed for up to 600V.
- **Ivory and white finishes.** Blend with any decor. Custom colors available. Consult factory for more information. Paintable using latex paint.
- **Communication connectivity options.** Accepts industry standard and proprietary devices from a wide range of manufacturers to provide a seamless and aesthetically pleasing interface for voice, data, audio, and video applications at the point of use.
- **UL and cUL Listed component raceways.** File E90378 Guide RJTX, Fittings: File E90377 Guide RJYT. Meets Article 388 of NEC and meets Section 12-600 of CEC.

## 5400 Series Raceway System Layout

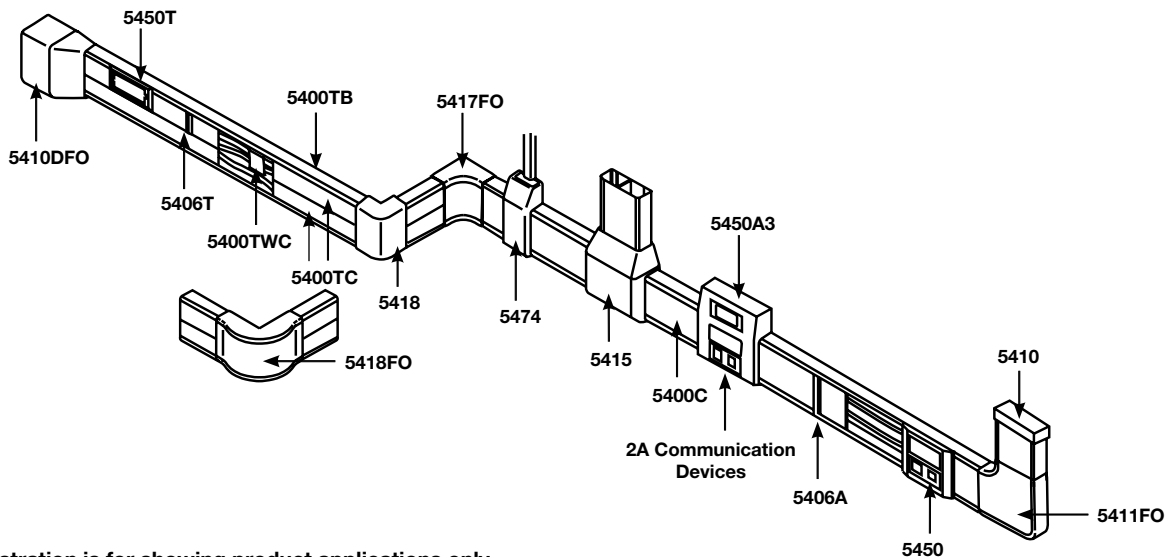

**NOTE:** Illustration is for showing product applications only.

## 5400T Series Raceway & MXN Series Raceway Wire Fill Capacity Charts

### 5400TB Series Raceway Wire Fill Capacities for Power

	WIRE SIZE CABLE/WIRE SIZE	O.D. (Approx. Dia.)		NO. OF CONDUCTORS	
		Inches	(mm)	COMP. A	COMP. B*
POWER WIRING WITHOUT DEVICES	14 AWG	0.111	(2.8)	50	50
	12 AWG	0.130	(3.3)	34	34
	10 AWG	0.164	(4.2)	60	60
	8 AWG	0.216	(5.5)	21	21
	6 AWG	0.254	(6.5)	19	19
POWER WIRING WITH DEVICES	14 AWG	0.111	(2.8)	50	50
	12 AWG	0.130	(3.3)	34	34
	10 AWG	0.164	(4.2)	60	60
	8 AWG	0.216	(5.5)	21	21
	6 AWG	0.254	(6.5)	19	19

\* Total raceway capacity not to exceed capacity specified in Compartment B.

### 5400TB Series Raceway Wire Fill Capacities for Communications

	CABLE/WIRE SIZE	O.D. (Approx. Dia.)		COMP. A
		Inches	(mm)	40% FILL*
UNSHIELDED TWISTED PAIR	4-pair, 24 AWG Cat 3	0.190	(4.8)	52
	4-pair, 24 AWG Cat 5e	0.210	(5.3)	42
	4-pair, 24 AWG Cat 6	0.250	(6.3)	30
	4-pair, 24 AWG Cat 6a**	0.250	(6.3)	15
	25-pair, 24 AWG	0.250	(6.3)	11
COAXIAL	RG6/U	0.270	(6.9)	26
FIBER	ZipCord	0.118 x 0.236	(3 x 6)	53
	Round 4-Strand Fiber	0.187	(4.8)	54
	Round 6-Strand Fiber	0.256	(6.5)	28

\* Wire fill capacity is reduced to allow for proper conductor bend radius and maximum permissible heat rise.

\*\* Category 6 augmented (6a) cable for 10 gigabit Ethernet – maximum allowed cable diameter per addenda No. 11 ANSI TIA/EIA 568-B.2.



**PEP  
ECO  
PASS  
PORT®**

Download this product's PEP ecopassport® environmental product declaration at [www.legrand.us/resources-and-downloads](http://www.legrand.us/resources-and-downloads). This declaration conforms with ISO 14025 and 14040 and is in alignment with EN 15804.

## 5400T Series Raceway & MXN Series Raceway Wire Fill Capacity Charts (continued)

### MXN Series Raceway Wire Fill Capacities for Power

WIRE SIZE CABLE/WIRE SIZE	O.D. (Approx. Dia.) Inches (mm)	NO. OF CONDUCTORS EACH COMPARTMENT
14 AWG	0.111 (2.8)	16
12 AWG	0.130 (3.3)	14
10 AWG	0.164 (4.2)	14
8 AWG	0.216 (5.5)	15

Total Raceway Capacity is  
7.44 sq. in. (4800mm<sup>2</sup>)

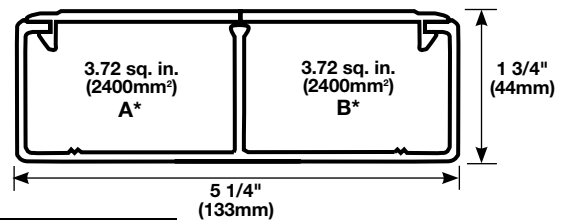

### MXN Series Raceway Wire Fill Capacities for Communications

	CABLE/WIRE SIZE	O.D. (Approx. Dia.) Inches (mm)	EA. COMPARTMENT 40% FILL
UNSHIELDED TWISTED PAIR	4-pair, 24 AWG Cat 3	0.190 (4.8)	19
	4-pair, 24 AWG Cat 5e	0.210 (5.3)	16
	4-pair, 24 AWG Cat 6	0.250 (6.3)	11
	4-pair, 24 AWG Cat 6a*	0.250 (6.3)	5
	25-pair, 24 AWG	0.250 (6.3)	4
COAXIAL	RG6/U	0.270 (6.9)	9
FIBER	ZipCord	0.118 x 0.236 (3 x 6)	20
	Round 4-Strand Fiber	0.187 (4.8)	20
	Round 6-Strand Fiber	0.256 (6.5)	10

**NOTE:** Wire fill capacity is reduced to allow for proper conductor bend radius and maximum permissible heat rise.

\* Category 6 augmented (6a) cable for 10 gigabit Ethernet – maximum allowed cable diameter per addenda No. 11 ANSI TIA/EIA 568-B.2.

## 5400 Series Raceway Ordering Information

Catalog No./Item	Description/Specifications	Catalog No./Item	Description/Specifications
<b>5400TB</b> 	<b>Two-Compartment Base</b> – Two equal compartments – Base accepts single or Twin Snap Cover. 5400TB Series Raceway available in 8' (2.44m) lengths with pre-punched mounting holes	<b>MXN2F21</b> 	<b>Entrance End Fitting</b> – For feeding corner drop raceway from larger conduits. Has concentric 3/4", 1", and 1 1/2" trade size KOs.
<b>5400C</b> 	<b>Full Width Cover</b> – Use with 5400TB. Available in 8' (2.44m) lengths.	<b>MXN2A08</b> 	<b>Corner Drop Raceway Base and Cover</b> – Used as a vertical corner feed drop to horizontal run of 5400 or 40N2 Series Raceways. Two compartments. Packaged with base and cover.
<b>5400TC</b> 	<b>Twin Snap Cover</b> – Use with 5400TB Series Raceway in Twin Snap applications. Order separate cover for each compartment. Available in 8' (2.44m) lengths.	<b>MXN2FWC</b> 	<b>Wire Clip</b> – Retains wires in MXN2A08 Corner Drop Raceway.
<b>5400TWC</b> 	<b>Twin Snap Cover Wire Clip</b> – Retains wires in raceway.		

**NOTE:** No suffix denotes Ivory finish. Add "-WH" suffix for White finish.

## 5400 Series Raceway Fittings Ordering Information

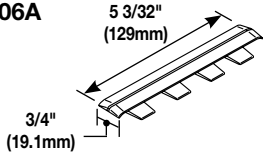
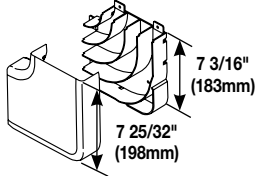
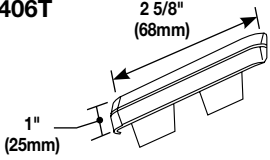
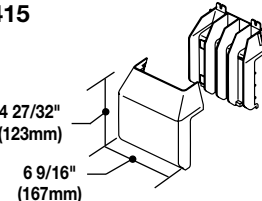
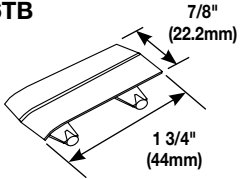
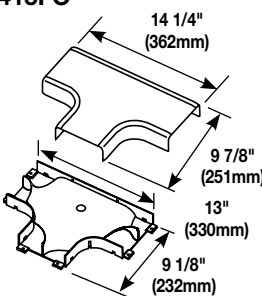
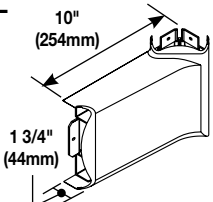
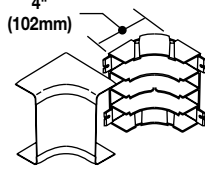
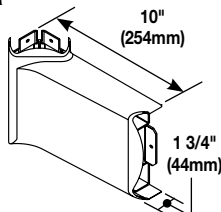
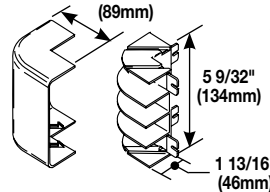
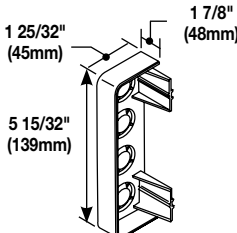
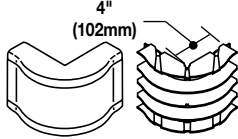
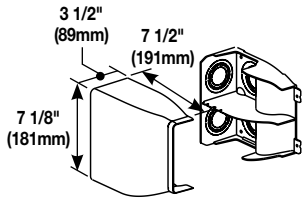
Catalog No./Item	Description/Specifications	Catalog No./Item	Description/Specifications
<b>5406A</b>  <p>5 3/32" (129mm) 3/4" (19.1mm)</p>	<b>Cover Clip</b> – For covering joint where two pieces of 5400T Cover come together.	<b>5411FO</b>  <p>7 3/16" (183mm) 7 25/32" (198mm)</p>	<b>Bend Radius Full Capacity Flat Elbow</b> – For right angle turns on the same surface. Integral dividers provide 2" (51mm) cable bend radius for UTP and Fiber Optic installations. Ideal for lay-in or pull-through installations.
<b>5406T</b>  <p>2 5/8" (68mm) 1" (25mm)</p>	<b>Twin Snap Cover Clip</b> – For covering joint where two pieces of 5400TC Cover come together.	<b>5415</b>  <p>4 27/32" (123mm) 6 9/16" (167mm)</p>	<b>Tee</b> – For branching raceway at right angles.
<b>5406TB</b>  <p>7/8" (22.2mm) 1 3/4" (44mm)</p>	<b>Base Seam Clip</b> – For covering joint where two pieces of 5400TB Base come together.	<b>5415FO</b>  <p>14 1/4" (362mm) 9 7/8" (251mm) 13" (330mm) 9 1/8" (232mm)</p>	<b>Bend Radius Full Capacity Tee</b> – For branching raceway at right angles. Provides separation of services and 2" (51mm) cable bend radius for UTP and Fiber Optic installations.
<b>5408L</b>  <p>10" (254mm) 1 3/4" (44mm)</p>	<b>Transition Fitting</b> – For transitioning from MXN2A08 Corner Drop to a horizontal run of 5400TB Series Raceway to the left.	<b>5417FO</b>  <p>4" (102mm)</p>	<b>Bend Radius Full Capacity Internal Elbow</b> – A full capacity 90° internal corner with integral dividers that provide 2" (51mm) cable bend radius for UTP and Fiber Optic installations. Ideal for lay-in or pull-through installations.
<b>5408R</b>  <p>10" (254mm) 1 3/4" (44mm)</p>	<b>Transition Fitting</b> – For transitioning from MXN2A08 Corner Drop to a horizontal run of 5400TB Series Raceway to the right.	<b>5418</b>  <p>3 1/2" (89mm) 5 9/32" (134mm) 1 13/16" (46mm)</p>	<b>External Elbow</b> – For right angle turns around external corners.
<b>5410</b>  <p>1 25/32" (45mm) 1 7/8" (48mm) 5 15/32" (139mm)</p>	<b>Blank End Fitting</b> – For closing open end of 5400TB Series Raceway. Has four 1/2" trade size KOs for end feed.	<b>5418FO</b>  <p>4" (102mm)</p>	<b>Bend Radius Full Capacity External Elbow</b> – For right angle turns around external corners. Integral dividers provide 2" (51mm) cable bend radius for UTP and Fiber Optic installations. Use the 5418FO as a radiused alternative to 5418.
<b>5410DFO</b>  <p>3 1/2" (89mm) 7 1/2" (191mm) 7 1/8" (181mm)</p>	<b>Bend Radius Divided Entrance End Fitting</b> – Divided fitting to feed 5400TB Series Raceway. Includes 1", 1 1/4", 1 1/2", and 2" trade size KOs on back and top.		

**NOTE:** No suffix denotes Ivory finish. Add "-WH" suffix for White finish.

## 5400 Series Raceway Fittings Ordering Information (Continued)

Catalog No./Item	Description/Specifications	Catalog No./Item	Description/Specifications
<b>5450</b> 	<b>Device Bracket</b> – For mounting power and communication devices in-line with 5400TB Series Raceway. For use with 5507 Series Faceplates, Ortronics® TracJack and Series II Modules, Pass & Seymour® Activate Series Inserts, and Wiremold CM2 Series Open System Communication Modules.	<b>CM-EPLA*</b> 	<b>End Plates</b> – Includes two outlet identification labels with clear covers and two matching screw covers. Required for mounting Pass & Seymour Activate and Wiremold CM2 Series Open System communication modules into 5450 Series device brackets.
<b>5450T</b> 	<b>Twin Snap Cover Device Bracket</b> – For power or communication devices in a single compartment. For use with 5507 Series Faceplates, Ortronics® TracJack and Series II Modules, Pass & Seymour® Activate Series Inserts, and Wiremold CM2 Series Open System Communication Modules.	<b>5474</b> 	<b>Transition Fitting</b> – Makes transition from 5400TB Series Raceway to 400, 800, 2300 Series Raceways or Eclipse™ PN03, PN05, and PN10 Series Raceways.
<b>5450A3</b> 	<b>Three Device Mounting Bracket</b> – For mounting up to three power or communication devices at one location in-line and offset from 5400TB Series Raceway. For use with 5507 Series Faceplates, Ortronics® TracJack and Series II Modules, Pass & Seymour® Activate Series Inserts, and Wiremold CM2 Series Open System Communication Modules.		

**NOTE:** No suffix denotes Ivory finish. Add “-WH” suffix for White finish.

\* **CM-EPLA** End Plates are required when using Wiremold CM2 Series Open System communication modules and Pass & Seymour® Activate inserts. **S2-EPL** End Plates are required when using Ortronics Series II inserts. To mount Ortronics TracJack inserts, use 5507-4TJ or 5507-6TJ Faceplates.

TRANSITION FITTINGS TO EXISTING WIRING OR OTHER WIREMOLD RACEWAYS		
CONNECTION REQUIRED		CATALOG NUMBER
FROM	TO	
5400TB	400, 800, 2300	5474
5400TB	PN03, PN05, PN10	5474
5400TB	MXN2A08	5408L/5408R
1/2" Trade size Conduit or Armored Cable	Side of 5400	5410 or 5410DFO
3/4", 1", 1 1/2" & 2" Trade size Conduit or Armored Cable	Back or Side of 5400TB	5410DFO



**Ideal for offices and classrooms.**

## 5507 Series Faceplates Ordering Information

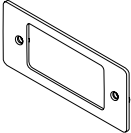
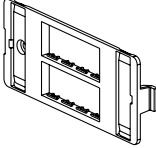
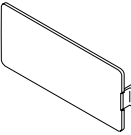
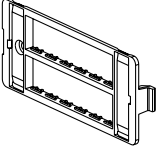
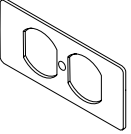
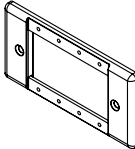
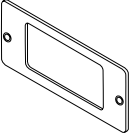
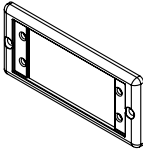
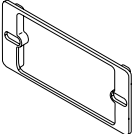
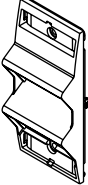
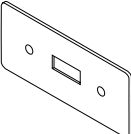
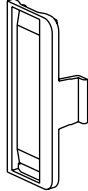
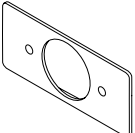
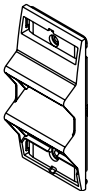
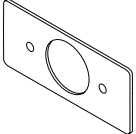
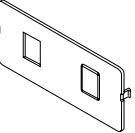
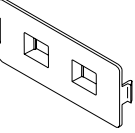
Catalog No./Item	Description/Specifications	Catalog No./Item	Description/Specifications
5507AD	 <b>Modular Furniture Adapter</b> – For mounting modular furniture adapters.	5507-4TJ	 <b>Ortronics® Faceplate</b> – For mounting Ortronics® communication inserts. Accepts four TracJack Devices.
5507B	 <b>Blank Faceplate</b> – For covering unused compartments in the device bracket.	5507-6TJ	 <b>Ortronics® Faceplate</b> – For mounting Ortronics® communication inserts. Accepts six TracJack Devices.
5507D	 <b>Duplex Faceplate</b> – For covering duplex style devices. Accepts 106 Frame.	5507MAAP	 <b>Extron® MAAP Faceplate</b> – Accepts four Extron® Electronics MAAP single space modules.
5507R	 <b>Rectangular Faceplate</b> – For covering rectangular style devices.	5507AAP	 <b>Extron® AAP Faceplate</b> – Accepts two Extron® Electronics AAP single space modules.
5507S	 <b>Rectangular Spacer</b> – For mounting commercial device plates. Installs between the device bracket and a device.	CM-ARA	 <b>Angled Raceway Adapter</b> – Includes two outlet identification labels with clear covers and two matching screw covers. Provides angled exit in multi-channel raceway systems and WallSource™ Boxes. Accepts two Pass & Seymour® Activate 2A size modules or two Wiremold CM2 Series open System communication modules. Snaps into standard device mounting brackets. Fits 5507 Series Faceplate opening.
5507SW	 <b>Switch Faceplate</b> – For covering standard toggle switches.	S2-EPL	 <b>End Plate</b> – For mounting Ortronics® Series II modules into 5507 opening. Includes two outlet identification labels with clear covers and two matching screw covers.
5507T1	 <b>Single Receptacle Faceplate</b> – For covering single receptacles – 1.59" (40mm) diameter.	ARA-S2	 <b>Angled Raceway Adapter</b> – For use with multi-channel raceway device brackets and WallSource device mounting brackets. Angled exit provides additional mounting depth required for A/V connections, as well as ensuring the required bend radius for UTP and fiber optic cabling. Holds two Ortronics® Series II modules. Fits 5507 Series Faceplate opening.
5507T2	 <b>Single Receptacle Faceplate</b> – For covering single receptacles – 1.41" (36mm) diameter.		
5507RJ	 <b>Dual RJ11/RJ45 Connector Faceplate</b> – For mounting one or two RJ keystone type connectors – has one opening and a KO for the other.		
5507FRJ	 <b>Flush Dual RJ11/RJ45 Connector Faceplate</b> – Same as 5507RJ except the connectors are recessed to provide a flush installation.		

**NOTE:** No suffix denotes Ivory finish. Add “-WH” suffix for White finish. All faceplates have a standard measurement of 4 1/4" x 1 7/8" (108mm x 34mm).

## 5400 Series Raceway Prewired Features

Features	Standard	Options
<b>Communication Devices</b>	Ortronics or Pass & Seymour Activate™ Connectivity System Devices	Other manufacturers
<b>Electrical Devices</b>	Pass & Seymour	Other manufacturers and some international devices
<b>Base Length</b>	Longest = 8' (2.4m), shortest = 1' (305mm)	–
<b>Finish</b>	PVC – White or Ivory	Custom colors
<b>Wire Type</b>	THHN Stranded	Options per specification
<b>Wiring Splices</b>	Insulation displacement connectors	Continuous wiring or twist-on wire connector
<b>Grounding Conductors</b>	Wire gauge per National Electrical Code (NEC) and shared grounding wires	Oversized and/or separate grounding wires
<b>Device Identification</b>	Gray self-adhesive polyester label with black letters	Self-adhesive engraved nameplate
<b>Neutrals</b>	Shared neutral	Oversized and/or separate neutral wires
<b>Pigtails</b>	1' (305mm) feeds and receptacle leads	Per specification
<b>Conduit Feeds</b>	Raceway drilled at job site	Entrance end cap
<b>Record Drawings</b>	3 sets and 2 copies of marked-up blueprints	Per job requirements
<b>Submittal Services</b>	Detailed Submittal	Submittal Free

## Device and Raceway Labeling Detail for Prewired Applications

- Device labeling is available in the following materials:
  - Gray self-adhesive polyester label with black lettering (standard).
  - Other color self-adhesive polyester labels.
  - Engraving of covers with black lettering.
  - Engraved phenolic nameplates with adhesive backing.
- The back of the raceway is labeled with the raceway number and the room or area number(s).
- Data and power requirements can be switched with data on top and power on bottom.

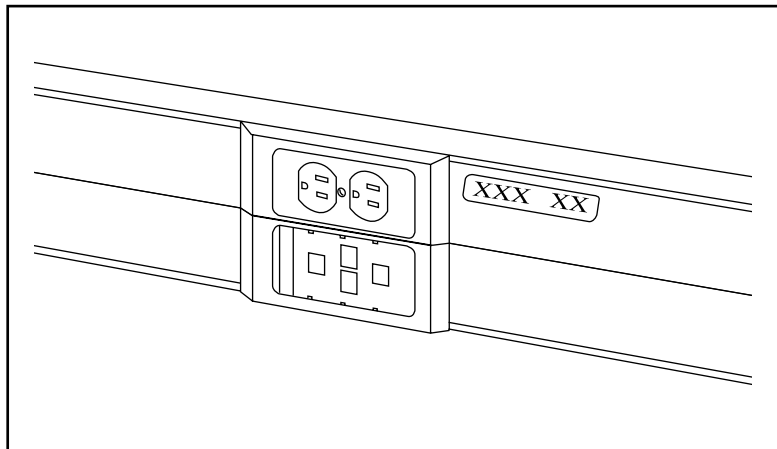

## 5400 Series Raceway Ordering Specifications for Prewired Applications

**Two options available when ordering a prewired job:**

- 1. Detailed Submittal** The detailed submittal will show exactly how each raceway run will be built including lengths, number and type of receptacles, wiring schematics, circuiting information, etc. The contractor and/or distributor must review, clarify any information not clearly indicated on the drawings or specs, approve, and return to the factory before production can begin.
- 2. Submittal Free** The Wiremold Prewired Express™ Building Plan Checklist is filled out by the contractor or distributor and sent along with plans, casework, and specs to the factory. No submittal is required and the project is scheduled for production upon receipt of all necessary information.

**NOTE: All brand and product names referenced in this document are registered trademarks or trademarks of their respective holders.**



**NOTE:** The paper used to print this document is an environmentally responsible paper with 10% post consumer waste, with FSC and SFI Chain of Custody certifications, Lacey Act compliant. 100% of the electricity used to manufacture Flo sheets is generated with Green-e certified renewable energy.



**Electrical Wiring Systems**

60 Woodlawn Street  
West Hartford, CT 06110  
Phone: 1.877.BY.LEGRAND (295-3472)  
[www.legrand.us](http://www.legrand.us)

570 Applewood Crescent  
Vaughan, Ontario L4K 4B4  
Phone: 905.738.9195  
[www.legrand.ca](http://www.legrand.ca)

