

## Utility Boxes and Accessories

### 4" x 2 1/8" Utility Boxes

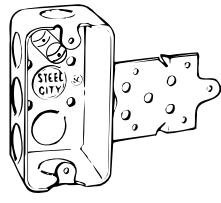

58351 1/2\*



58351 B 1/4  
B bracket recessed 1/4"



58361 1/2\*

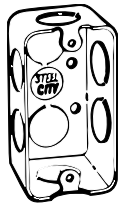

58361 3/4

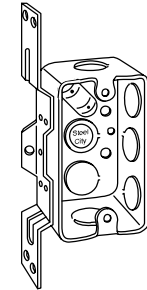

58361 V 1/2\*  
CV bracket recessed 1/2"

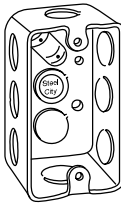

58371 1/2\*

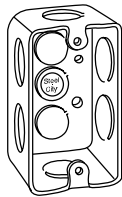

58371 3/4



58371 T 1/2  
T bracket recessed 5/8"



58371V1/2-25\*  
CV bracket recessed 1/2"

CAT. NO.	DEPTH (IN.)	CU. IN. CAPACITY	BRKTS.	KNOCKOUTS (IN.)			STD CTN.
				EA. SIDE CONDUIT	EA. END CONDUIT	BOTTOM CONDUIT	
<b>With Conduit KOs</b>							
58351 1/2*	1 1/2	10.3	—	3-1/2	1-1/2	2-1/2	50
58351 B 1/4	1 1/2	10.3	B	3-1/2	1-1/2	2-1/2	25
58361 1/2*	1 1/8	13.0	—	3-1/2	1-1/2	2-1/2	50
58361 3/4	1 1/8	13.0	—	2-3/4	1-3/4	2-3/4	50
58361 V 1/2*	1 1/8	13.0	CV	3-1/2	1-1/2	2-1/2	50
58371 1/2*	2 1/8	14.5	—	3-1/2	1-1/2	2-1/2	50
58371 3/4	2 1/8	14.5	—	2-3/4	1-3/4	2-3/4	50
58371 T 1/2*	2 1/8	14.5	T	3-1/2	1-1/2	2-1/2	25
58371V1/2-25*	2 1/8	14.5	CV	3-1/2	1-1/2	2-1/2	25

\* Factory-provided raised ground-screw location.

### 4 1/8" x 2 1/2" Utility Boxes

68361 1/2

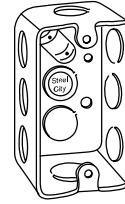

68371 1/2

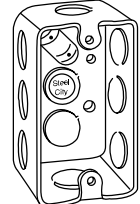

CAT. NO.	DEPTH (IN.)	CU. IN. CAPACITY	KNOCKOUTS (IN.)			STD. CTN.
			EA. SIDE CONDUIT	EA. END CONDUIT	BOTTOM CONDUIT	
<b>With Conduit KOs</b>						
68361 1/2*	1 1/16	17.0	3-1/2	1-1/2	2-1/2	25
68371 1/2*	2 1/16	18.8	3-1/2	1-1/2	2-1/2	50

\* Factory-provided raised ground-screw location.

### 4" x 2 1/8" Utility Box Covers



58 C 1

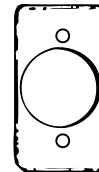

58 C 4

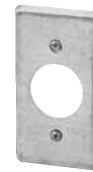

58 C 5



58 C 6



58 C 7

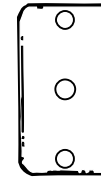

58 C 11

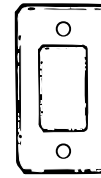

58 C 16



58 C 30

CAT. NO.	DIA. HOLE (IN.)	DESCRIPTION	STD. CTN.
<b>Raised 1/4"</b>			
58 C 1	—	Blank	100
58 C 4	1 1/32	For 4-wire twist-lock single flush receptacle	25
58 C 5	1 1/32	For single receptacle	25
58 C 6	—	With 1/2" KO	25
58 C 7	—	For duplex flush receptacle	100
58 C 11	—	With 1/32" bushed hole	25
58 C 16	—	For single GFCI receptacle	25
58 C 30	—	For one toggle switch	100

Includes captivated Phillips head screws.

## Utility/Handy Boxes and Accessories

### 4 1/8" x 2 1/2" Utility Box Covers Raised 3/16"

68-C-1

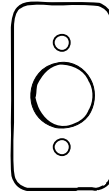

68 C 5

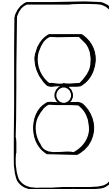

68 C 7

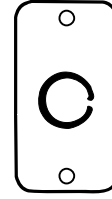

68 C 6

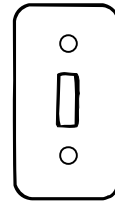

68 C 30

CAT. NO.	DIA. HOLE (IN.)	DESCRIPTION	STD. CTN.
68 C 1	—	Blank	25
68 C 5	1 3/2	For single receptacle	25
68 C 6	—	With 1/2" KO	25
68 C 7	—	For duplex flush receptacle	25
68 C 30	—	For one toggle switch	25

Includes captivated Phillips head screws.

### 4" x 2 1/8" Utility Box Extension Rings

CAT. NO.	DEPTH (IN.)	CU. IN. CAPACITY	KNOCKOUTS(IN.)		STD. CTN.
			EA. SIDE CONDUIT	EA. END CONDUIT	
<i>With Conduit KOs</i>					
59361 1/2	1 1/8	13.0	3-1/2	1-1/2	50
59361 3/4	1 1/8	13.0	2-3/4	1-3/4	25

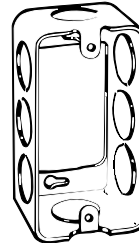

59361 1/2

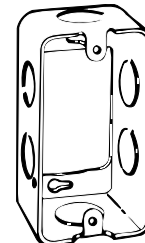

59361 3/4

### Handy Boxes

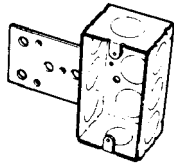

102-W-LB-1/4

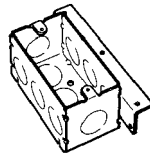

103-W-AB

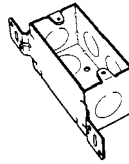

104-W-FB-3/4

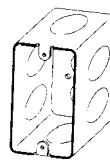

106-3/4



106-FB-1/2



106-FB-3/4

CAT. NO.	DEPTH (IN.)	CU. IN. CAPACITY	DESCRIPTION	CONSTRUCTION TYPE	STD. CTN.
102-W-LB-1/4	1 1/2	10.3	<b>1 1/2" deep x 4" long x 2 1/8" wide</b> Three 1/2" KOs in one side, lateral bracket on other side, one 1/2" KO in each end and three 1/2" KOs in bottom. Furnished with four mounting holes in bottom. Bracket offset 1/4" from face*	Welded	50
103-W-AB	1 1/8	13.0	<b>1 1/8" deep x 4" long x 2 1/8" wide</b> Three 1/2" KOs in one side, angle bracket on other side, one 1/2" KO in each end and three 1/2" KOs in bottom. Bracket offset 3/16" from face*	Welded	50
104-W-FB-3/4	2 1/8	14.5	<b>2 1/8" deep x 4" long x 2 1/8" wide</b> Two 3/4" KOs in one side, flat bracket on other side, one 3/4" KO in each end and two 3/4" KOs in bottom. Flat bracket offset 3/16" from face*	Welded	50
106-3/4	2 3/16	18.0	<b>2 3/16" deep x 4 1/8" long x 2 3/16" wide</b> Two 3/4" KOs in each side, one 3/4" KO in each end and three 1/2" KOs in bottom. Two mounting holes in bottom	Drawn	50
106-FB-1/2	2 3/16	18.0	<b>2 3/16" deep x 4 1/8" long x 2 3/16" wide</b> Three 1/2" KOs in one side, flat bracket on other side, one 1/2" KO in each end and three 1/2" KOs in bottom. Flat bracket offset 3/16" from face	Drawn	50
106-FB-3/4	2 3/16	18.0	<b>2 3/16" deep x 4 1/8" long x 2 3/16" wide</b> Two 3/4" KOs in each side, flat bracket on other side, one 3/4" KO in each end and three 1/2" KOs in bottom. Flat bracket offset 3/16" from face	Drawn	50

\*Uses Steel City® 100 series covers.

## Handy/Gang Boxes and Accessories

### Multi-Gang Handy Boxes

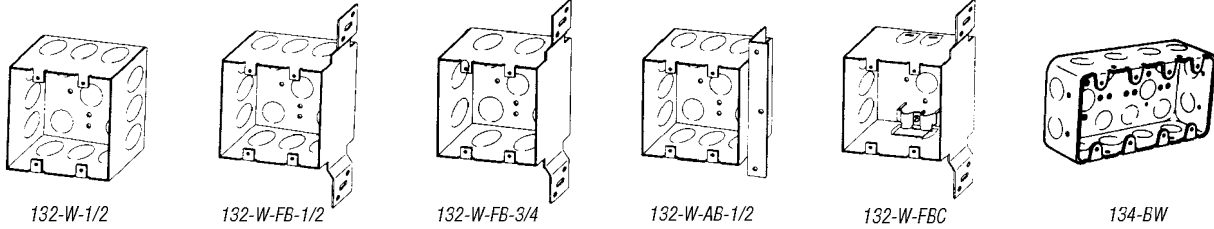

CAT. NO.	DEPTH (IN.)	CU. IN. CAPACITY	DESCRIPTION	STD. CTN.
132-W-1/2	2 1/8	30.3	<b>A Two-Gang Box, 2 1/8" deep — 4" square</b> Three 1/2" KOs in each of four sides and three 1/2" KOs in a line in bottom with two 3/4" KOs at opposite ends in bottom*	25
132-W-FB-1/2	2 1/8	30.3	<b>A Two-Gang Box, 2 1/8" deep — 4" square</b> Three 1/2" KOs in each of three sides, flat bracket on fourth side and five 1/2" KOs in bottom. Flat bracket offset 3/16" from face*	25
132-W-FB-3/4	2 1/8	30.3	<b>A Two-Gang Box, 2 1/8" deep — 4" square</b> Two 3/4" KOs in each of three sides, flat bracket on fourth side and three 1/2" KOs in a line with two 3/4" KOs at opposite ends in bottom. Flat bracket offset 3/16" from face*	25
132-W-AB-1/2	2 1/8	30.3	<b>A Two-Gang Box, 2 1/8" deep — 4" square</b> Three 1/2" KOs in each of three sides, angle bracket on fourth side and five 1/2" KOs in bottom. Bracket offset 3/16" from face*	25
132-W-FBC	2 1/8	30.3	<b>For Non-Metallic Cable — A Two-Gang Box, 2 1/8" deep — 4" square</b> Two Loom KOs in each of two opposite sides, two 1/2" KOs in side opposite flat bracket and one 1/2" KO in bottom. Two Loom clamps for use on non-metallic sheathed cable with 10/32 deep-slotted screws assembled. Flat bracket offset 3/16" from face*	25
134-BW	2 1/8	58.0	<b>A Four-Gang Box</b> Four 1/2" KOs in each side, two 1/2" KOs in each end and ten 1/2" KOs in bottom. Uses Steel City SB-4 cover	20

\*Uses Steel City® SB-2 covers.

### Drawn-Style Gang Boxes

CAT. NO.	DEPTH (IN.)	CU. IN. CAPACITY	HEIGHT (IN.)	LGTH. (IN.)	KNOCKOUTS (IN.)			STD. CTN.
					EA. SIDE CONDUIT	EA. END CONDUIT	BOTTOM CONDUIT	
<b>With Conduit KOs</b>								
2G 1/2 3/4	1 3/8	45.0	4 1/2	6 13/16	2-1/2 2-3/4	1-1/2 1-3/4	3-1/2 2-3/4	5
3G 1/2 3/4	1 3/8	58.0	4 1/2	8 5/8	3-1/2 2-3/4	1-1/2 1-3/4	6-1/2 4-3/4	5
4G 1/2 3/4	1 3/8	70.0	4 1/2	10 1/16	3-1/2 3-3/4	1-1/2 1-3/4	6-1/2 4-3/4	5
5G 1/2 3/4	1 3/8	85.0	4 1/2	12 1/4	4-1/2 3-3/4	1-1/2 1-3/4	6-1/2 4-3/4	1
6G 1/2 3/4	1 3/8	95.0	4 1/2	14 1/16	4-1/2 4-3/4	1-1/2 1-3/4	6-1/2 4-3/4	1
H2BD 3/4 1	2 1/2	71.0	4 1/2	6 13/16	2-3/4 1-1	1-3/4 1-1	3-1/2 2-3/4	10
H3BD 3/4 1	2 1/2	90.0	4 1/2	8 5/8	4-3/4 1-1	1-3/4 1-1	6-1/2 4-3/4	10
H4BD 3/4 1	2 1/2	110.0	4 1/2	10 1/16	2-3/4 2-1	1-3/4 1-1	6-1/2 4-3/4	5
H5BD 3/4 1	2 1/2	132.0	4 1/2	12 1/4	3-3/4 2-1	1-3/4 1-1	6-1/2 4-3/4	5
H6BD 3/4 1	2 1/2	150.0	4 1/2	14 1/16	3-3/4 3-1	1-3/4 1-1	6-1/2 4-3/4	5



2G 1/2 & 3/4



3G 1/2 & 3/4

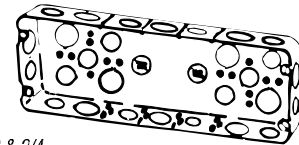

5G 1/2 & 3/4

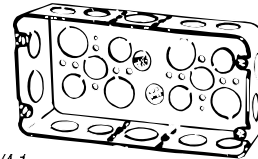

H3BD 3/4 1

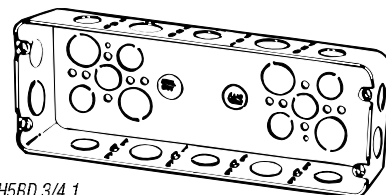

H5BD 3/4 1

## Gang Boxes and Accessories

### Multi-Gang Boxes

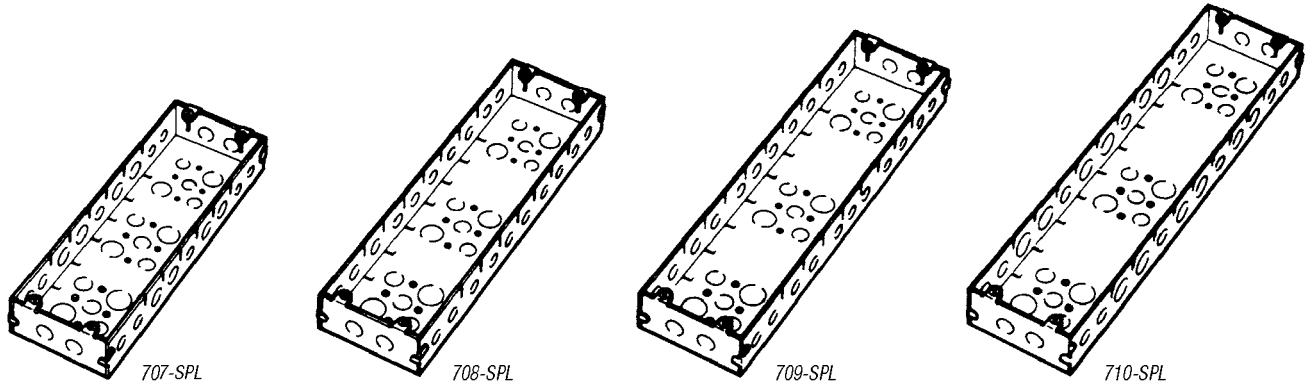

CAT. NO.	CU. IN. CAPACITY	DESCRIPTION	STD. CTN.
707-SPL	126.5	<b>Seven-Gang Box, 1<sup>13</sup>/<sub>16</sub>" deep x 4<sup>1</sup>/<sub>16</sub>" long x 15<sup>15</sup>/<sub>16</sub>" wide</b> Five 1/2" KOs and four 3/4" KOs in each side, two 1/2" KOs in each end and nine 1/2" KOs with six 3/4" KOs in bottom. Furnished with four 8/32 screws. For use with either Steel City® 807 and SB-7, 808 and SB-8, or just GB-7 rings and covers	1
708-SPL	141.3	<b>Eight-Gang Box, 1<sup>13</sup>/<sub>16</sub>" deep x 4<sup>1</sup>/<sub>16</sub>" long x 17<sup>3</sup>/<sub>4</sub>" wide</b> Six 1/2" KOs and four 3/4" KOs in each side, two 1/2" KOs in each end and nine 1/2" KOs with six 3/4" KOs in bottom. Furnished with four 8/32 screws. For use with either Steel City® 808 and SB-8, 809 and SB-9, or just GB-8 rings and covers	1
709-SPL	155.8	<b>Nine-Gang Box, 1<sup>13</sup>/<sub>16</sub>" deep x 4<sup>1</sup>/<sub>16</sub>" long x 19<sup>9</sup>/<sub>16</sub>" wide</b> Six 1/2" and five 3/4" KOs in each side and two 1/2" KOs in each end and nine 1/2" KOs with six 3/4" KOs in bottom. Furnished with four 8/32 screws. For use with either Steel City® 809 and SB-9, 810 and SB-10, or just GB-9 rings and covers	1
710-SPL	170.5	<b>Ten-Gang Box, 1<sup>13</sup>/<sub>16</sub>" deep x 4<sup>1</sup>/<sub>16</sub>" long x 21<sup>1</sup>/<sub>4</sub>" wide</b> Six 1/2" KOs and six 3/4" KOs in each side, two 1/2" KOs in each end and nine 1/2" KOs with six 3/4" KOs in bottom. Furnished with four 8/32 screws. For use with either Steel City® 810 and SB-10, or just GB-10 rings and covers	1

### Gang Box Partitions

CAT. NO.	DESCRIPTION	STD. CTN.
SGP	Hi/low-voltage partition for 1 <sup>1</sup> / <sub>2</sub> "-deep box	25
DGP	Hi/low-voltage partition for 2 <sup>1</sup> / <sub>2</sub> "-deep box	50



SGP

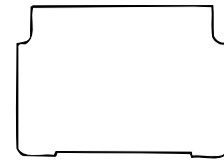

DGP

### 2-, 3- and 4-Gang Drawn-Style Device Boxes

CAT. NO.	GANG	DEPTH (IN.)	CU. IN. CAPACITY	BRACKETS	EA. SIDE CONDUIT	EA. END CONDUIT	STD. CTN.
2G4DV 1/2 3/4	2	2 <sup>1</sup> / <sub>2</sub> "	30.3	CV	2-1/2", 1-3/4"	2-1/2", 1-3/4"	25
3G4D 1/2	3	2 <sup>1</sup> / <sub>2</sub> "	44.3	—	3-1/2"	2-1/2"	20
3G4D B 1/2	3	2 <sup>1</sup> / <sub>2</sub> "	44.3	B	3-1/2"	2-1/2"	20
3G4D V 1/2	3	2 <sup>1</sup> / <sub>2</sub> "	44.3	CV	3-1/2"	2-1/2"	20
4G4D 1/2	4	2 <sup>1</sup> / <sub>2</sub> "	58.0	—	4-1/2"	2-1/2"	20
4G4D B 1/2	4	2 <sup>1</sup> / <sub>2</sub> "	58.0	B	4-1/2"	2-1/2"	20
4G4D V 1/2	4	2 <sup>1</sup> / <sub>2</sub> "	58.0	CV	4-1/2"	2-1/2"	20

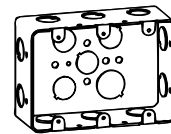

3G4D 1/2

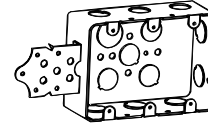

3G4D B 1/2



3G4D V 1/2

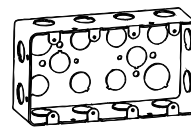

4G4D 1/2

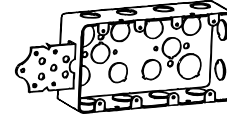

4G4D B 1/2

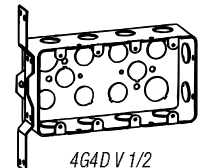

4G4D V 1/2

## Gang Boxes and Accessories

### Gang Box Covers

When covers are required to accommodate various combinations of devices, use the following catalog numbers plus the suffix "SPECIAL," and then indicate the combinations desired. When necessary, also indicate the sequence of devices.

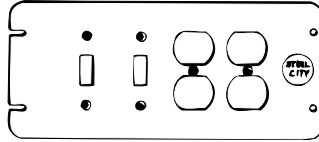

EXAMPLE: 4-GCS Special

- As illustrated (above), this is a 4-GCS Special for two toggle switches on left side and two duplex receptacles on right side

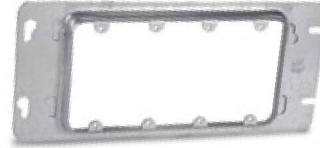

4-GC

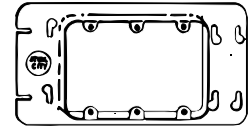

3-GC

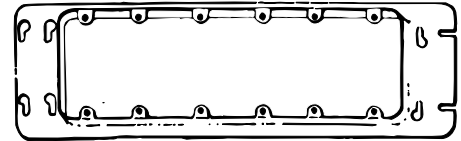

6 GC

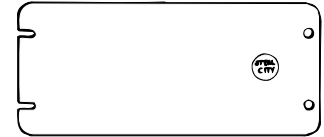

3-GCB

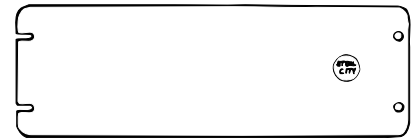

5 GCB

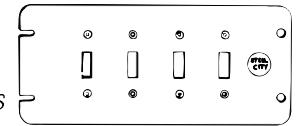

4-GCS

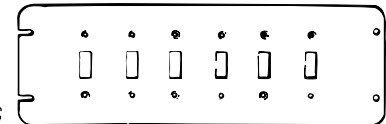

6 GCS

CAT. NO.	LGTH. (IN.)	CU. IN. CAPACITY	DESCRIPTION	STD. CTN.
<b>4 1/16" Wide—Raised 1/16" for Plaster</b>				
2-GC	7	8.5	Holes between gangs are spaced on	5
3-GC	8 13/16	13.5	1/16" centers; tapped holes in ears;	5
4-GC	10 5/8	18.3	spaced on 3/32" centers to accommodate	5
5 GC	12 7/16	23.0	all standard receptacles and switches;	5
6 GC	14 1/4	28.3	furnished with extra plugged screw holes; if these screw holes are used, the cover will fit the next smaller size box	5
<b>4 1/16" Wide — Flat, Blank</b>				
2-GCB	7	—	—	25
3-GCB	8 13/16	—	—	25
4-GCB	10 5/8	—	—	25
5 GCB	12 7/16	—	—	25
6 GCB	14 1/4	—	—	25
<b>4 1/16" Wide — Flat for Toggle Switches</b>				
2-GCS	7	—	For 2 toggle switches	25
3-GCS	8 13/16	—	For 3 toggle switches	25
4-GCS	10 5/8	—	For 4 toggle switches	25
5 GCS	12 7/16	—	For 5 toggle switches	25
6 GCS	14 1/4	—	For 6 toggle switches	25

4 1/16" wide — special covers — flat to accommodate combinations of devices.

### Multi-Gang Rings

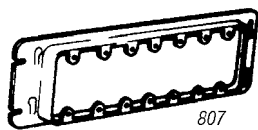

807

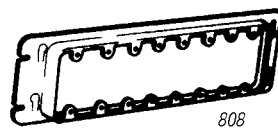

808

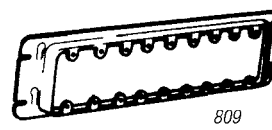

809

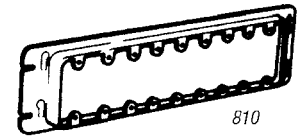

810

CAT. NO.	CU. IN. CAPACITY	DESCRIPTION	STD. CTN.
807	36.3	<b>A seven-gang switch ring, 3/4" raised x 4 1/8" long x 15 15/16" wide</b> Fits Steel City® 706 or 707 outlet boxes and uses GB-7 covers	1
808	41.0	<b>An eight-gang switch ring, 3/4" raised x 4 1/8" long x 17 1/4" wide</b> Fits Steel City® 707 or 708 outlet boxes and uses GB-8 covers	1
809	46.5	<b>A nine-gang switch ring, 3/4" raised x 4 1/8" long x 19 1/8" wide</b> Fits Steel City® 708 or 709 outlet boxes and uses GB-9 covers	1
810	51.5	<b>A ten-gang switch ring, 3/4" raised x 4 1/8" long x 21 1/8" wide</b> Fits Steel City® 709 or 710 outlet boxes and uses GB-10 covers	1

## Gang Boxes and Accessories

### Multi-Gang Covers — SB Series

CAT. NO.	DESCRIPTION	STD. CTN.
SB-2	2-gang cover	1
SB-3	3-gang cover	1
SB-4	4-gang cover	1
SB-5	5-gang cover	1
SB-6	6-gang cover	1
SB-7	7-gang cover	1
SB-8	8-gang cover	1
SB-9	9-gang cover	1
SB-10	10-gang cover	1

*Fits Steel City® 132, 133 and 134 series handy boxes (both welded and drawn) and 800 series multi-gang rings.*

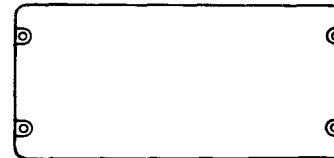
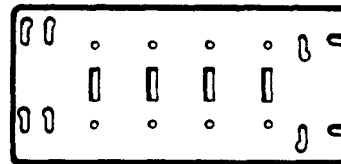
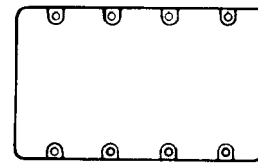
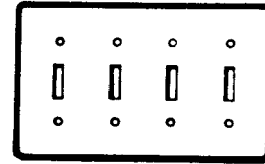

Typical Mounting Arrangement

### Multi-Gang Covers — GB Series

CAT. NO.	DESCRIPTION	STD. CTN.
GB-2	2-gang cover	1
GB-3	3-gang cover	1
GB-4	4-gang cover	1
GB-5	5-gang cover	1
GB-6	6-gang cover	1
GB-7	7-gang cover	1
GB-8	8-gang cover	1
GB-9	9-gang cover	1
GB-10	10-gang cover	1

*Fits Steel City® 700 series multi-gang boxes.*

### How To Order.

1. Indicate style of cover "GB" or "SB"
2. Use symbols for each opening
3. Separate each symbol with a dash (-)
4. Allow 4 to 6 weeks for shipment

Symbols	Example:
DR Duplex Receptacle	
TS Toggle Switch	
SR Single Receptacle — Opening 1.4"	
B Blank	
TL Twist Lock (4-Wire) — Opening 1.594"	
	<div style="display: flex; justify-content: space-around; align-items: center;"> <div style="text-align: center;">↑ SB-5:DR</div> <div style="text-align: center;">↑ TS</div> <div style="text-align: center;">↑ SR</div> <div style="text-align: center;">↑ B</div> <div style="text-align: center;">↑ TL</div> </div>

## Utility Boxes and Accessories

### 4" x 2 1/8" Utility Boxes



58351 1/2\*

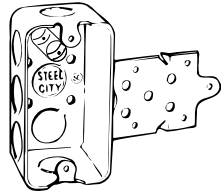

58351 B 1/4  
B bracket recessed 1/4"



58361 1/2\*

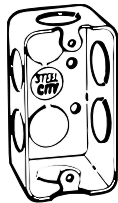

58361 3/4

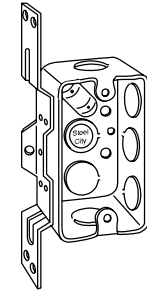

58361 V 1/2\*  
CV bracket recessed 1/2"

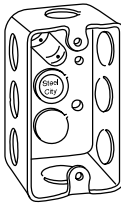

58371 1/2\*

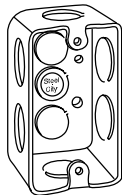

58371 3/4



58371 T 1/2  
T bracket recessed 5/8"



58371V1/2-25\*  
CV bracket recessed 1/2"

CAT. NO.	DEPTH (IN.)	CU. IN. CAPACITY	BRKTS.	KNOCKOUTS (IN.)			STD CTN.
				EA. SIDE CONDUIT	EA. END CONDUIT	BOTTOM CONDUIT	
<b>With Conduit KOs</b>							
58351 1/2*	1 1/2	10.3	—	3-1/2	1-1/2	2-1/2	50
58351 B 1/4	1 1/2	10.3	B	3-1/2	1-1/2	2-1/2	25
58361 1/2*	1 1/8	13.0	—	3-1/2	1-1/2	2-1/2	50
58361 3/4	1 1/8	13.0	—	2-3/4	1-3/4	2-3/4	50
58361 V 1/2*	1 1/8	13.0	CV	3-1/2	1-1/2	2-1/2	50
58371 1/2*	2 1/8	14.5	—	3-1/2	1-1/2	2-1/2	50
58371 3/4	2 1/8	14.5	—	2-3/4	1-3/4	2-3/4	50
58371 T 1/2*	2 1/8	14.5	T	3-1/2	1-1/2	2-1/2	25
58371V1/2-25*	2 1/8	14.5	CV	3-1/2	1-1/2	2-1/2	25

\* Factory-provided raised ground-screw location.

### 4 1/8" x 2 1/2" Utility Boxes

68361 1/2

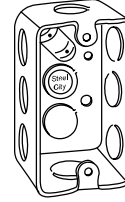

68371 1/2

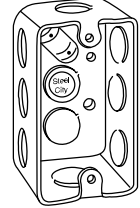

CAT. NO.	DEPTH (IN.)	CU. IN. CAPACITY	KNOCKOUTS (IN.)			STD. CTN.
			EA. SIDE CONDUIT	EA. END CONDUIT	BOTTOM CONDUIT	
<b>With Conduit KOs</b>						
68361 1/2*	1 1/16	17.0	3-1/2	1-1/2	2-1/2	25
68371 1/2*	2 1/16	18.8	3-1/2	1-1/2	2-1/2	50

\* Factory-provided raised ground-screw location.

### 4" x 2 1/8" Utility Box Covers



58 C 1

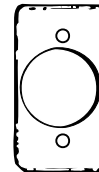

58 C 4

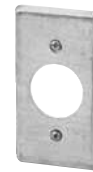

58 C 5



58 C 6



58 C 7

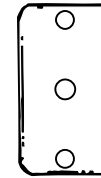

58 C 11

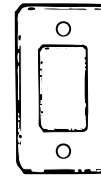

58 C 16



58 C 30

CAT. NO.	DIA. HOLE (IN.)	DESCRIPTION	STD. CTN.
<b>Raised 1/4"</b>			
58 C 1	—	Blank	100
58 C 4	1 1/32	For 4-wire twist-lock single flush receptacle	25
58 C 5	1 1/32	For single receptacle	25
58 C 6	—	With 1/2" KO	25
58 C 7	—	For duplex flush receptacle	100
58 C 11	—	With 1/32" bushed hole	25
58 C 16	—	For single GFCI receptacle	25
58 C 30	—	For one toggle switch	100

Includes captivated Phillips head screws.

## Utility/Handy Boxes and Accessories

### 4 1/8" x 2 1/2" Utility Box Covers Raised 3/16"

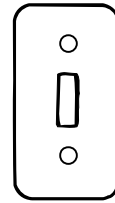
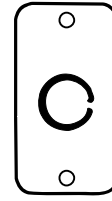
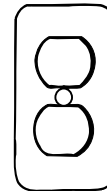
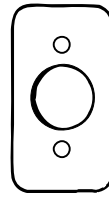
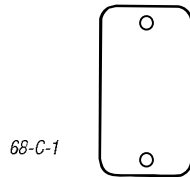

CAT. NO.	DIA. HOLE (IN.)	DESCRIPTION	STD. CTN.
68 C 1	—	Blank	25
68 C 5	1 3/2	For single receptacle	25
68 C 6	—	With 1/2" KO	25
68 C 7	—	For duplex flush receptacle	25
68 C 30	—	For one toggle switch	25

Includes captivated Phillips head screws.

### 4" x 2 1/8" Utility Box Extension Rings

CAT. NO.	DEPTH (IN.)	CU. IN. CAPACITY	KNOCKOUTS(IN.)		STD. CTN.
			EA. SIDE CONDUIT	EA. END CONDUIT	
<i>With Conduit KOs</i>					
59361 1/2	1 1/8	13.0	3-1/2	1-1/2	50
59361 3/4	1 1/8	13.0	2-3/4	1-3/4	25

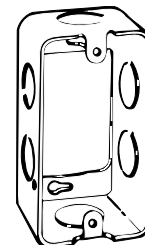
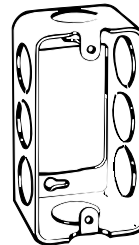

### Handy Boxes

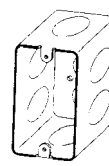
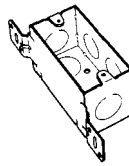
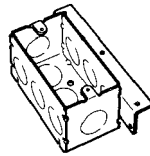
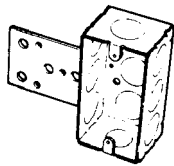

CAT. NO.	DEPTH (IN.)	CU. IN. CAPACITY	DESCRIPTION	CONSTRUCTION TYPE	STD. CTN.
102-W-LB-1/4	1 1/2	10.3	<b>1 1/2" deep x 4" long x 2 1/2" wide</b> Three 1/2" KOs in one side, lateral bracket on other side, one 1/2" KO in each end and three 1/2" KOs in bottom. Furnished with four mounting holes in bottom. Bracket offset 1/4" from face*	Welded	50
103-W-AB	1 1/8	13.0	<b>1 1/8" deep x 4" long x 2 1/8" wide</b> Three 1/2" KOs in one side, angle bracket on other side, one 1/2" KO in each end and three 1/2" KOs in bottom. Bracket offset 3/16" from face*	Welded	50
104-W-FB-3/4	2 1/8	14.5	<b>2 1/8" deep x 4" long x 2 1/8" wide</b> Two 3/4" KOs in one side, flat bracket on other side, one 3/4" KO in each end and two 3/4" KOs in bottom. Flat bracket offset 3/16" from face*	Welded	50
106-3/4	2 3/16	18.0	<b>2 3/16" deep x 4 1/8" long x 2 3/16" wide</b> Two 3/4" KOs in each side, one 3/4" KO in each end and three 1/2" KOs in bottom. Two mounting holes in bottom	Drawn	50
106-FB-1/2	2 3/16	18.0	<b>2 3/16" deep x 4 1/8" long x 2 3/16" wide</b> Three 1/2" KOs in one side, flat bracket on other side, one 1/2" KO in each end and three 1/2" KOs in bottom. Flat bracket offset 3/16" from face	Drawn	50
106-FB-3/4	2 3/16	18.0	<b>2 3/16" deep x 4 1/8" long x 2 3/16" wide</b> Two 3/4" KOs in each side, flat bracket on other side, one 3/4" KO in each end and three 1/2" KOs in bottom. Flat bracket offset 3/16" from face	Drawn	50

\*Uses Steel City® 100 series covers.



## Handy/Gang Boxes and Accessories

### Multi-Gang Handy Boxes

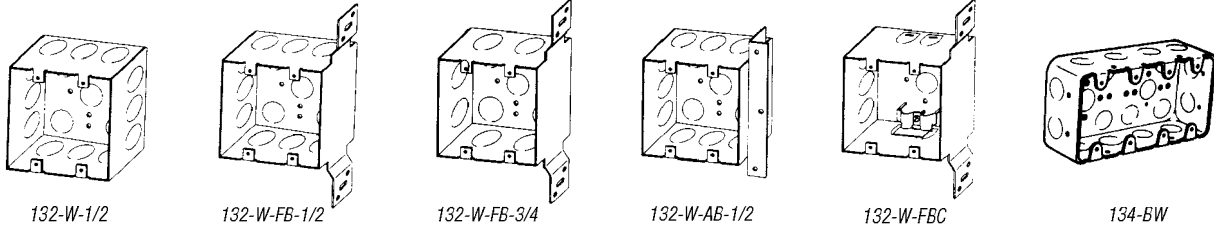

CAT. NO.	DEPTH (IN.)	CU. IN. CAPACITY	DESCRIPTION	STD. CTN.
132-W-1/2	2 1/8	30.3	<b>A Two-Gang Box, 2 1/8" deep — 4" square</b> Three 1/2" KOs in each of four sides and three 1/2" KOs in a line in bottom with two 3/4" KOs at opposite ends in bottom*	25
132-W-FB-1/2	2 1/8	30.3	<b>A Two-Gang Box, 2 1/8" deep — 4" square</b> Three 1/2" KOs in each of three sides, flat bracket on fourth side and five 1/2" KOs in bottom. Flat bracket offset 3/16" from face*	25
132-W-FB-3/4	2 1/8	30.3	<b>A Two-Gang Box, 2 1/8" deep — 4" square</b> Two 3/4" KOs in each of three sides, flat bracket on fourth side and three 1/2" KOs in a line with two 3/4" KOs at opposite ends in bottom. Flat bracket offset 3/16" from face*	25
132-W-AB-1/2	2 1/8	30.3	<b>A Two-Gang Box, 2 1/8" deep — 4" square</b> Three 1/2" KOs in each of three sides, angle bracket on fourth side and five 1/2" KOs in bottom. Bracket offset 3/16" from face*	25
132-W-FBC	2 1/8	30.3	<b>For Non-Metallic Cable — A Two-Gang Box, 2 1/8" deep — 4" square</b> Two Loom KOs in each of two opposite sides, two 1/2" KOs in side opposite flat bracket and one 1/2" KO in bottom. Two Loom clamps for use on non-metallic sheathed cable with 10/32 deep-slotted screws assembled. Flat bracket offset 3/16" from face*	25
134-BW	2 1/8	58.0	<b>A Four-Gang Box</b> Four 1/2" KOs in each side, two 1/2" KOs in each end and ten 1/2" KOs in bottom. Uses Steel City SB-4 cover	20

\*Uses Steel City® SB-2 covers.

### Drawn-Style Gang Boxes

CAT. NO.	DEPTH (IN.)	CU. IN. CAPACITY	HEIGHT (IN.)	LGTH. (IN.)	KNOCKOUTS (IN.)			STD. CTN.
					EA. SIDE CONDUIT	EA. END CONDUIT	BOTTOM CONDUIT	
<b>With Conduit KOs</b>								
2G 1/2 3/4	1 3/8	45.0	4 1/2	6 13/16	2-1/2 2-3/4	1-1/2 1-3/4	3-1/2 2-3/4	5
3G 1/2 3/4	1 3/8	58.0	4 1/2	8 5/8	3-1/2 2-3/4	1-1/2 1-3/4	6-1/2 4-3/4	5
4G 1/2 3/4	1 3/8	70.0	4 1/2	10 1/16	3-1/2 3-3/4	1-1/2 1-3/4	6-1/2 4-3/4	5
5G 1/2 3/4	1 3/8	85.0	4 1/2	12 1/4	4-1/2 3-3/4	1-1/2 1-3/4	6-1/2 4-3/4	1
6G 1/2 3/4	1 3/8	95.0	4 1/2	14 1/16	4-1/2 4-3/4	1-1/2 1-3/4	6-1/2 4-3/4	1
H2BD 3/4 1	2 1/2	71.0	4 1/2	6 13/16	2-3/4 1-1	1-3/4 1-1	3-1/2 2-3/4	10
H3BD 3/4 1	2 1/2	90.0	4 1/2	8 5/8	4-3/4 1-1	1-3/4 1-1	6-1/2 4-3/4	10
H4BD 3/4 1	2 1/2	110.0	4 1/2	10 1/16	2-3/4 2-1	1-3/4 1-1	6-1/2 4-3/4	5
H5BD 3/4 1	2 1/2	132.0	4 1/2	12 1/4	3-3/4 2-1	1-3/4 1-1	6-1/2 4-3/4	5
H6BD 3/4 1	2 1/2	150.0	4 1/2	14 1/16	3-3/4 3-1	1-3/4 1-1	6-1/2 4-3/4	5



2G 1/2 & 3/4

3G 1/2 & 3/4

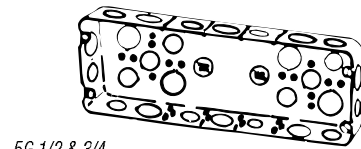

5G 1/2 & 3/4

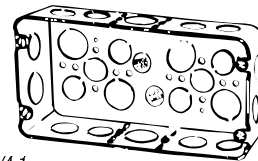

H3BD 3/4 1

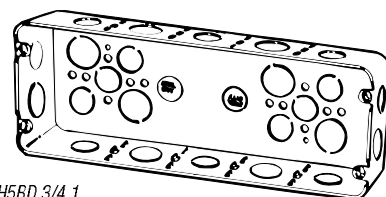

H5BD 3/4 1

## Gang Boxes and Accessories

### Multi-Gang Boxes

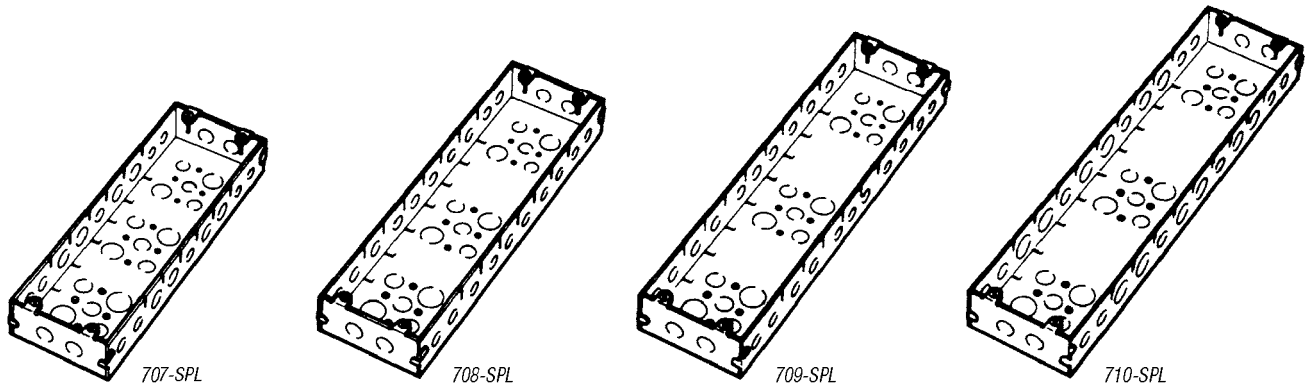

CAT. NO.	CU. IN. CAPACITY	DESCRIPTION	STD. CTN.
707-SPL	126.5	<b>Seven-Gang Box, 1<sup>13</sup>/<sub>16</sub>" deep x 4<sup>9</sup>/<sub>16</sub>" long x 15<sup>15</sup>/<sub>16</sub>" wide</b> Five 1/2" KOs and four 3/4" KOs in each side, two 1/2" KOs in each end and nine 1/2" KOs with six 3/4" KOs in bottom. Furnished with four 8/32 screws. For use with either Steel City® 807 and SB-7, 808 and SB-8, or just GB-7 rings and covers	1
708-SPL	141.3	<b>Eight-Gang Box, 1<sup>13</sup>/<sub>16</sub>" deep x 4<sup>9</sup>/<sub>16</sub>" long x 17<sup>3</sup>/<sub>4</sub>" wide</b> Six 1/2" KOs and four 3/4" KOs in each side, two 1/2" KOs in each end and nine 1/2" KOs with six 3/4" KOs in bottom. Furnished with four 8/32 screws. For use with either Steel City® 808 and SB-8, 809 and SB-9, or just GB-8 rings and covers	1
709-SPL	155.8	<b>Nine-Gang Box, 1<sup>13</sup>/<sub>16</sub>" deep x 4<sup>9</sup>/<sub>16</sub>" long x 19<sup>9</sup>/<sub>16</sub>" wide</b> Six 1/2" and five 3/4" KOs in each side and two 1/2" KOs in each end and nine 1/2" KOs with six 3/4" KOs in bottom. Furnished with four 8/32 screws. For use with either Steel City® 809 and SB-9, 810 and SB-10, or just GB-9 rings and covers	1
710-SPL	170.5	<b>Ten-Gang Box, 1<sup>13</sup>/<sub>16</sub>" deep x 4<sup>9</sup>/<sub>16</sub>" long x 21<sup>3</sup>/<sub>4</sub>" wide</b> Six 1/2" KOs and six 3/4" KOs in each side, two 1/2" KOs in each end and nine 1/2" KOs with six 3/4" KOs in bottom. Furnished with four 8/32 screws. For use with either Steel City® 810 and SB-10, or just GB-10 rings and covers	1

### Gang Box Partitions

CAT. NO.	DESCRIPTION	STD. CTN.
SGP	Hi/low-voltage partition for 1 <sup>1</sup> / <sub>2</sub> "-deep box	25
DGP	Hi/low-voltage partition for 2 <sup>1</sup> / <sub>2</sub> "-deep box	50



SGP

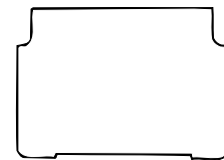

DGP

### 2-, 3- and 4-Gang Drawn-Style Device Boxes

CAT. NO.	GANG	DEPTH (IN.)	CU. IN. CAPACITY	BRACKETS	EA. SIDE CONDUIT	EA. END CONDUIT	STD. CTN.
2G4DV 1/2 3/4	2	2 <sup>1</sup> / <sub>2</sub> "	30.3	CV	2-1/2", 1-3/4"	2-1/2", 1-3/4"	25
3G4D 1/2	3	2 <sup>1</sup> / <sub>2</sub> "	44.3	—	3-1/2"	2-1/2"	20
3G4D B 1/2	3	2 <sup>1</sup> / <sub>2</sub> "	44.3	B	3-1/2"	2-1/2"	20
3G4D V 1/2	3	2 <sup>1</sup> / <sub>2</sub> "	44.3	CV	3-1/2"	2-1/2"	20
4G4D 1/2	4	2 <sup>1</sup> / <sub>2</sub> "	58.0	—	4-1/2"	2-1/2"	20
4G4D B 1/2	4	2 <sup>1</sup> / <sub>2</sub> "	58.0	B	4-1/2"	2-1/2"	20
4G4D V 1/2	4	2 <sup>1</sup> / <sub>2</sub> "	58.0	CV	4-1/2"	2-1/2"	20

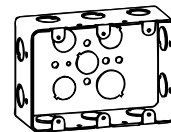

3G4D 1/2

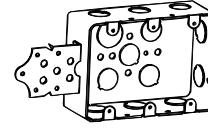

3G4D B 1/2



3G4D V 1/2

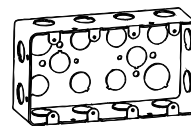

4G4D 1/2

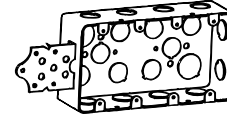

4G4D B 1/2

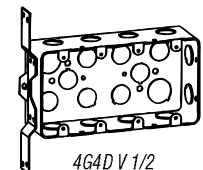

4G4D V 1/2

## Gang Boxes and Accessories

### Gang Box Covers

When covers are required to accommodate various combinations of devices, use the following catalog numbers plus the suffix "SPECIAL," and then indicate the combinations desired. When necessary, also indicate the sequence of devices.

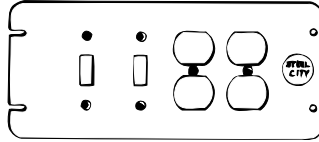

EXAMPLE: 4-GCS Special

- As illustrated (above), this is a 4-GCS Special for two toggle switches on left side and two duplex receptacles on right side

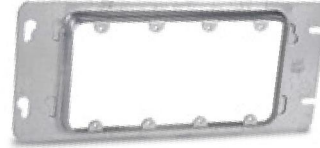

4-GC

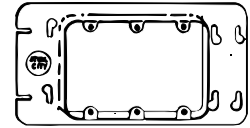

3-GC

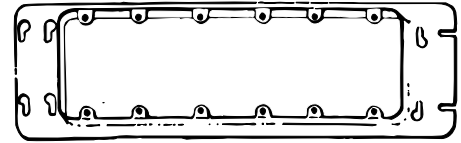

6-GC

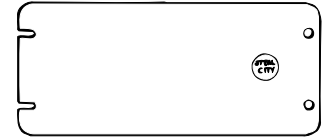

3-GCB

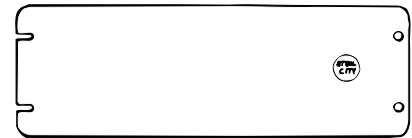

5-GCB

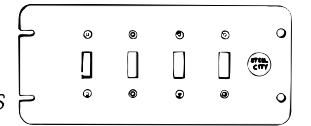

4-GCS

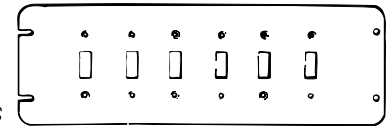

6-GCS

CAT. NO.	LGTH. (IN.)	CU. IN. CAPACITY	DESCRIPTION	STD. CTN.
<b>4 1/16" Wide—Raised 1/16" for Plaster</b>				
2-GC	7	8.5	Holes between gangs are spaced on	5
3-GC	8 13/16	13.5	1/16" centers; tapped holes in ears;	5
4-GC	10 5/8	18.3	spaced on 3/32" centers to accommodate	5
5-GC	12 7/16	23.0	all standard receptacles and switches;	5
6-GC	14 1/4	28.3	furnished with extra plugged screw holes; if these screw holes are used, the cover will fit the next smaller size box	5
<b>4 1/16" Wide — Flat, Blank</b>				
2-GCB	7	—	—	25
3-GCB	8 13/16	—	—	25
4-GCB	10 5/8	—	—	25
5-GCB	12 7/16	—	—	25
6-GCB	14 1/4	—	—	25
<b>4 1/16" Wide — Flat for Toggle Switches</b>				
2-GCS	7	—	For 2 toggle switches	25
3-GCS	8 13/16	—	For 3 toggle switches	25
4-GCS	10 5/8	—	For 4 toggle switches	25
5-GCS	12 7/16	—	For 5 toggle switches	25
6-GCS	14 1/4	—	For 6 toggle switches	25

4 1/16" wide — special covers — flat to accommodate combinations of devices.

### Multi-Gang Rings

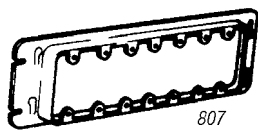

807

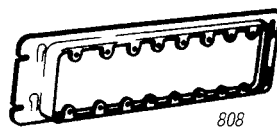

808

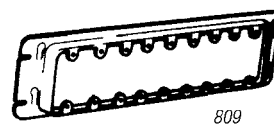

809

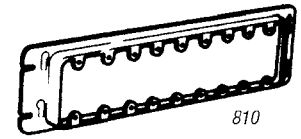

810

CAT. NO.	CU. IN. CAPACITY	DESCRIPTION	STD. CTN.
807	36.3	<b>A seven-gang switch ring, 3/4" raised x 4 1/16" long x 15 15/16" wide</b> Fits Steel City® 706 or 707 outlet boxes and uses GB-7 covers	1
808	41.0	<b>An eight-gang switch ring, 3/4" raised x 4 1/16" long x 17 1/4" wide</b> Fits Steel City® 707 or 708 outlet boxes and uses GB-8 covers	1
809	46.5	<b>A nine-gang switch ring, 3/4" raised x 4 1/16" long x 19 1/16" wide</b> Fits Steel City® 708 or 709 outlet boxes and uses GB-9 covers	1
810	51.5	<b>A ten-gang switch ring, 3/4" raised x 4 1/16" long x 21 1/16" wide</b> Fits Steel City® 709 or 710 outlet boxes and uses GB-10 covers	1

## Gang Boxes and Accessories

### Multi-Gang Covers — SB Series

CAT. NO.	DESCRIPTION	STD. CTN.
SB-2	2-gang cover	1
SB-3	3-gang cover	1
SB-4	4-gang cover	1
SB-5	5-gang cover	1
SB-6	6-gang cover	1
SB-7	7-gang cover	1
SB-8	8-gang cover	1
SB-9	9-gang cover	1
SB-10	10-gang cover	1

*Fits Steel City® 132, 133 and 134 series handy boxes (both welded and drawn) and 800 series multi-gang rings.*

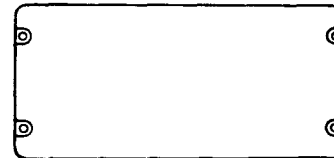
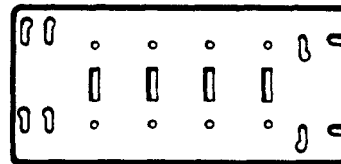
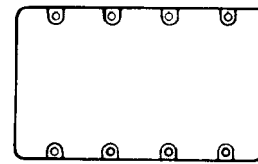
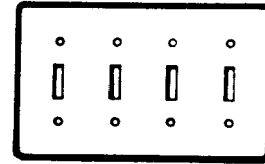

Typical Mounting Arrangement

### Multi-Gang Covers — GB Series

CAT. NO.	DESCRIPTION	STD. CTN.
GB-2	2-gang cover	1
GB-3	3-gang cover	1
GB-4	4-gang cover	1
GB-5	5-gang cover	1
GB-6	6-gang cover	1
GB-7	7-gang cover	1
GB-8	8-gang cover	1
GB-9	9-gang cover	1
GB-10	10-gang cover	1

*Fits Steel City® 700 series multi-gang boxes.*

### How To Order.

1. Indicate style of cover "GB" or "SB"
2. Use symbols for each opening
3. Separate each symbol with a dash (-)
4. Allow 4 to 6 weeks for shipment

Symbols	Example:
DR Duplex Receptacle	
TS Toggle Switch	
SR Single Receptacle — Opening 1.4"	
B Blank	
TL Twist Lock (4-Wire) — Opening 1.594"	