

Copper Mechanical Connectors

Only nine lug sizes fit cables from #14 to 1000 kcmil.

LOCKTITE® One-Hole Lugs

- Easily installed with key wrench
- Saddle and cable socket make direct, all-around, low-resistance contact with cable
- Convenient peephole permits easy inspection
- For use with code copper conductor (600V)

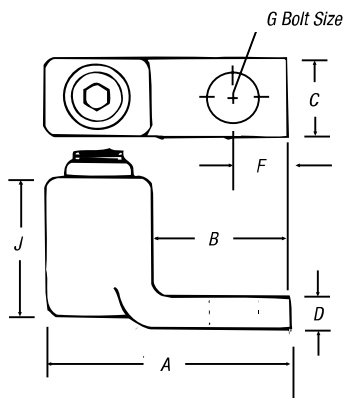

CAT. NO.	CABLE SIZE	DIMENSIONS (IN.)						
		G	A	B	C	D	J	F
31003 [†]	14 to 8	1/4	1 1/8	9/16	1/2	1/8	17/32	9/32
31005-TB [†]	8 to 4	1/4	1 1/8	5/8	1/2	1/8	17/32	9/32
31007	4 to 1	1/4	1 3/8	1 1/16	5/8	7/32	1	1 1/32
31009	1 to 2/0	3/8	1 15/16	1	13/16	1/4	1 3/16	7/16
31011	2/0 to 4/0	3/8	2 3/8	1 1/4	1	9/32	1 11/32	17/32
31013	4/0 to 300	1/2	2 3/4	1 1/2	1 3/16	5/16	1 17/32	5/8
31015	300 to 500	1/2	3 1/16	1 11/16	1 3/8	1 1/32	1 13/16	3/4
31017	500 to 750	1/2	3 23/32	2 3/16	1 3/8	1 1/32	2 1/8	1
31019	750 to 1000	3/4	4 1/16	2 15/32	1 7/8	1 1/32	2 11/32	1 1/16

[†]With Filister Head Screw. All others, hex socket screws.

LOCKTITE® One-Hole Flag-Type Lugs

- For use with code copper conductor (600V)

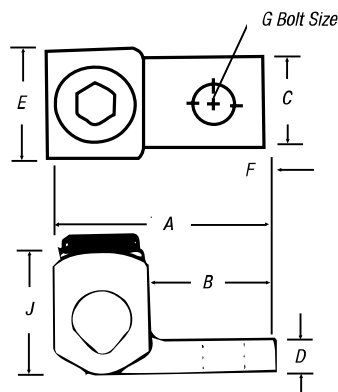

CAT. NO.	CABLE SIZE	DIMENSIONS (IN.)							
		G	A	B	C	D	J	F	E
31005-AL [†]	8 to 4	1/4	1 1/8	5/8	1/2	1/8	17/32	9/32	1/2

[†]With Filister Head Screw.

Bolt holes and spacings listed are standard, but lugs with blank tongues can be furnished.

For torque requirements, see page F-188.

Copper Mechanical Connectors

Only nine lug sizes fit cables from #14 to 1000 kcmil.

LOCKTITE® One-Hole Lugs

- Easily installed with key wrench
- Saddle and cable socket make direct, all-around, low-resistance contact with cable
- Convenient peephole permits easy inspection
- For use with code copper conductor (600V)

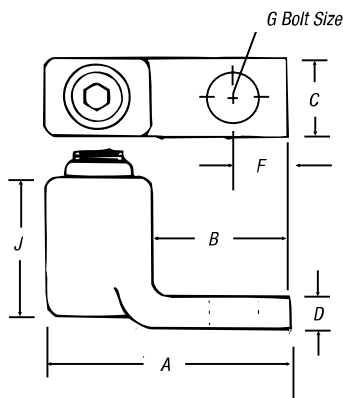

CAT. NO.	CABLE SIZE	DIMENSIONS (IN.)						
		G	A	B	C	D	J	F
31003 [†]	14 to 8	1/4	1 1/8	9/16	1/2	1/8	17/32	9/32
31005-TB [†]	8 to 4	1/4	1 1/8	5/8	1/2	1/8	17/32	9/32
31007	4 to 1	1/4	1 3/8	1 1/16	5/8	7/32	1	1 1/32
31009	1 to 2/0	3/8	1 15/16	1	13/16	1/4	1 3/16	7/16
31011	2/0 to 4/0	3/8	2 3/8	1 1/4	1	9/32	1 11/32	17/32
31013	4/0 to 300	1/2	2 3/4	1 1/2	1 3/16	5/16	1 17/32	5/8
31015	300 to 500	1/2	3 1/16	1 11/16	1 3/8	1 1/32	1 13/16	3/4
31017	500 to 750	1/2	3 23/32	2 3/16	1 3/8	1 1/32	2 1/8	1
31019	750 to 1000	3/4	4 1/16	2 15/32	1 7/8	1 1/32	2 11/32	1 1/16

[†]With Filister Head Screw. All others, hex socket screws.

LOCKTITE® One-Hole Flag-Type Lugs

- For use with code copper conductor (600V)

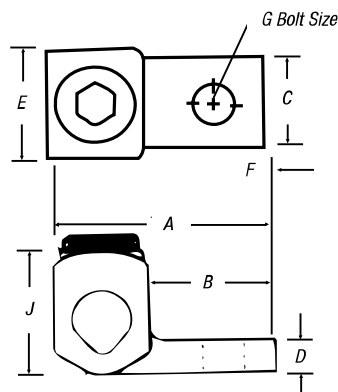

CAT. NO.	CABLE SIZE	DIMENSIONS (IN.)							
		G	A	B	C	D	J	F	E
31005-AL [†]	8 to 4	1/4	1 1/8	5/8	1/2	1/8	17/32	9/32	1/2

[†]With Filister Head Screw.

Bolt holes and spacings listed are standard, but lugs with blank tongues can be furnished.

For torque requirements, see page F-188.