

Mulberry

Outlet Box Covers

Device • Utility • Finished • FS • Gang
Conduit Bodies and Covers • KO Seals
Reducing Washers



Mulberry Outlet Box Covers

New in this catalog:

- *A full line of die-cast, powder painted conduit bodies: 1/2 - 4", threaded and set screw.*
- *Assembled conduit body kits.*
- *Mogul conduit bodies.*
- *More illustrations and details on finished covers.*
- *Information on covers with special openings.*

As always, Mulberry offers:

- *Superior quality casting, tapping, and finishing.*
- *Smooth powder paint finish on 4" raised covers and conduit bodies.*
- *Special openings and combinations on most covers.*
- *Excellent service: local stock, fast turnaround, and quick delivery from our factory and regional warehouses.*
- *Products made in USA.*

COVERS

Round	C4
Square	C5
4" Square Device and Offset	C6
4-11/16" Square Device	C7
Tile Type Device	C8
Utility	C9
4" Finished	C10-11
4-11/16" Finished	C12
FS Type	C13
Flat Gang Box	C14

REDUCING WASHERS

C15

CONDUIT BODIES AND COVERS

Threaded and Set Screw Bodies and Kits	C16-17
SLBs and Moguls	C18
Covers and Gaskets	C19

KNOCKOUT SEALS, SWITCHBOX SUPPORTS, AND NAIL PLATES

C20

Conduit Bodies

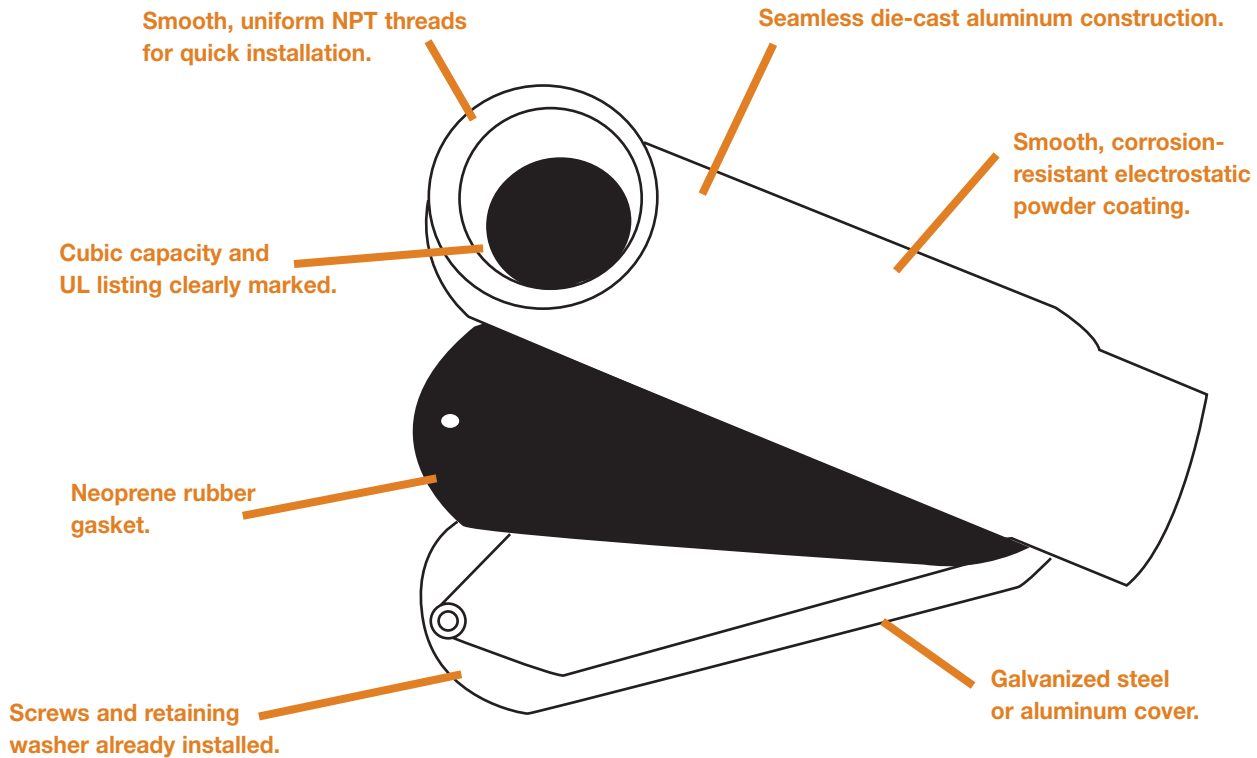

- Unassembled (body only) or assembled with matching steel cover and gasket.
- Kits with aluminum covers also available.
- Please see pages C16-C19 for details.
- Ask about our "Great Bodies" promotion.

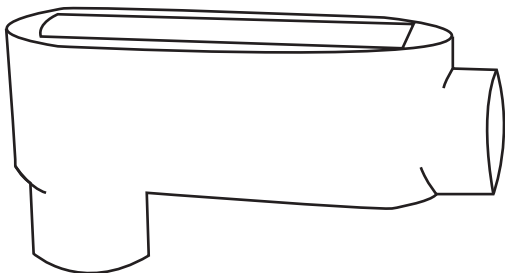

Threaded Bodies for Rigid or IMC

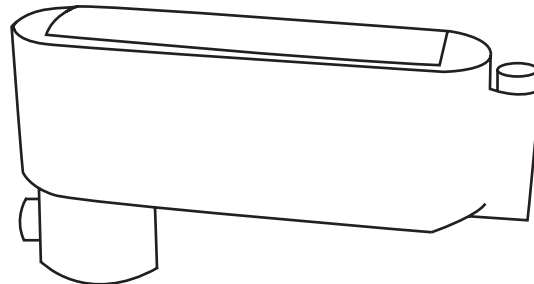

Set-Screw Bodies for EMT



Round Covers

3-1/2" and 4"



- Galvanized steel.
- UL Listed.

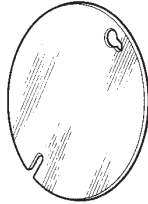

No. 11001



No. 11003

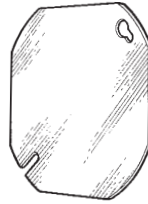

No. 11101

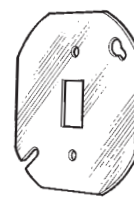

No. 11108

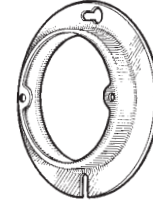

No. 11124

Catalog No.	Old No.	Universal Key No.	Description	Carton Quantity	Weight Per 100 Units
3 1/2" ROUND FLAT					
11001	24FC	24C1	Blank	100	17 lbs.
11002†	24FB	24C12F	Bushed Hole (.4375" dia.)	100	17 lbs.
11003	24FK	24C6	1/2" Knockout	100	17 lbs.
11006	24FR	24C50	Single Receptacle	100	14 lbs.
11008	24FT	—	Toggle	100	16 lbs.
4" ROUND FLAT					
11101	54FC	54C1	Blank	100	21 lbs.
11102†	54FB	54C12F	Bushed Hole (.4375" dia.)	100	21 lbs.
11103	54FK	54C6	1/2" Knockout	100	21 lbs.
11104†	54FS	54C28	Spider	100	18 lbs.
11105*	54FD	54C100	Duplex Receptacle	100	19 lbs.
11106	54FR	54C50	Single Receptacle	100	20 lbs.
11108	54FT	—	Toggle	100	23 lbs.
11109	543R	—	TL Receptacle (1.5937" dia.)	100	20 lbs.
4" ROUND RAISED					
11121	54RC	54C2	Blank	100	29 lbs.
11122†	54RB	54C12	Bushed Hole (.4375" dia.)	100	29 lbs.
11123†	54RK	54C7	1/2" Knockout	100	29 lbs.
11124	54R3	54C3	3" Opening (ears tapped, 2 3/4" between device centers, raised 5/8")	100	19 lbs.
11125	54R3-1/2	54C3-1/2	3" Opening (ears tapped, 2 3/4" between device centers, raised 1/2")	100	18 lbs.

*Not UL Listed.

†To be discontinued when stock exhausted.

Square Covers

4" and 4-11/16"



- UL • Galvanized steel.
- UL Listed.

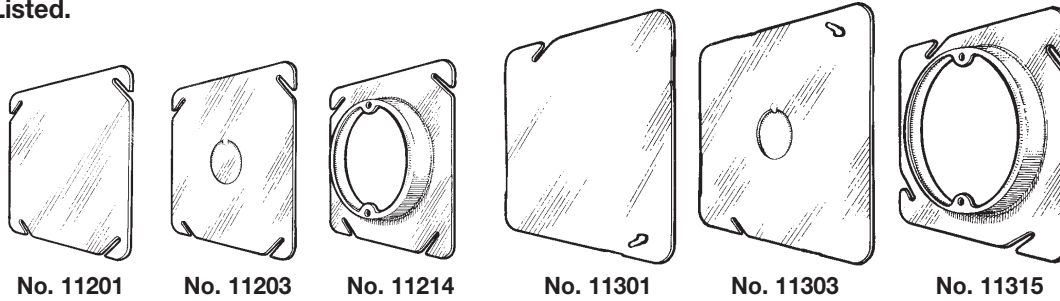

Catalog No.	Old No.	Universal Key No.	Description	Carton Quantity	Weight Per 100 Units
4" SQUARE FLAT					
11201	52FC	52C1	Blank	50	29 lbs.
11202†	52FB	52C12F	Bushed Hole (.4375" dia.)	100	29 lbs.
11203	52FK	52C6	½" Knockout	100	28 lbs.
4" SQUARE RAISED					
11211	52RC	52C2	Blank, Raised 5/8"	100	36 lbs.
11212	52RB	—	Bushed Hole (.4375" dia.)	100	38 lbs.
11214	52R3	52C3	3" Opening (ears tapped, 2¾" between device centers, raised 5/8")	100	26 lbs.
11215	52R3-½	52C3-½	3" Opening (ears tapped, 2¾" between device centers, raised ½")	100	22 lbs.
4-11/16" SQUARE FLAT					
11301	72FC	72C1	Blank	50	40 lbs.
11303	72FK	72C6	½" Knockout	50	39 lbs.
4-11/16" SQUARE-RAISED 5/8"					
11311	72RC	72C2	Blank	25	50 lbs.
11314	72R3	72C3	3" Opening (ears tapped, 2¾" between device centers)	25	38 lbs.
11315	72R4	72C4	4" Opening (ears tapped, 3½" between device centers)	25	30 lbs.

†To be discontinued when stock exhausted.

4" Square Device and Offset Covers



- Square drawn.
- Galvanized steel.
- UL Listed.

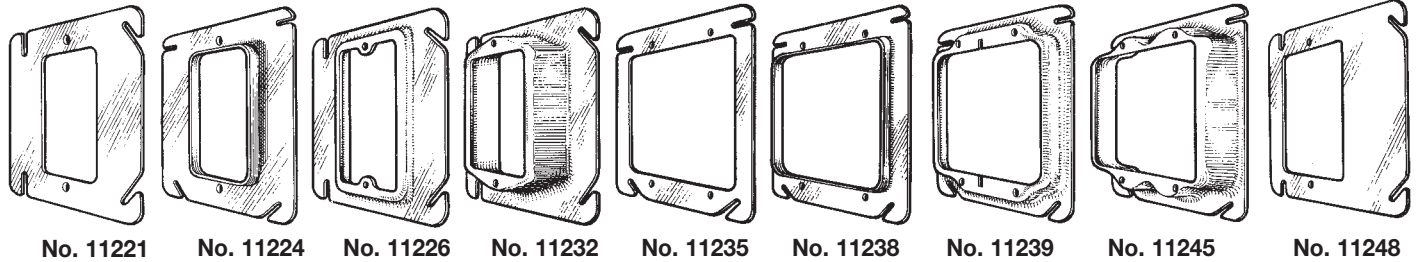

Catalog No.	Old No.	Universal Key No.	Description	Carton Quantity	Weight Per 100 Units
-------------	---------	-------------------	-------------	-----------------	----------------------

1 DEVICE — 4" SQUARE (SQUARE DRAWN)

11221	5201	52C0	Flat	100	17 lbs.
11222	5201-1/8	52C62-1/8	Raised 1/8"	100	17 lbs.
11223	5201-1/4	52C62	Raised 1/4"	100	18 lbs.
11224	5201DW-1/4	52C36	Drywall 1/4"	100	25 lbs.
11225	5201-3/8	52C13-3/8	Raised 3/8"	100	19 lbs.
11226	5201-1/2	52C13	Raised 1/2 "	100	22 lbs.
11227	5201-5/8	52C14-5/8	Raised 5/8"	50	25 lbs.
11228	5201-3/4	52C14	Raised 3/4"	50	28 lbs.
11230	5201-1	52C15	Raised 1"	25	33 lbs.
11231	5201-1 1/4	52C16	Raised 1 1/4"	25	38 lbs.
11232*	5201-1 1/2	52C16-1 1/2	Raised 1 1/2 "	25	41 lbs.

2 DEVICES — 4" SQUARE

11235	5202	52C00	Flat	100	12 lbs.
11236	5202-1/8	52C20-1/8	Raised 1/8"	50	13 lbs.
11237	5202-1/4	52C20	Raised 1/4"	50	13 lbs.
11238	5202DW-1/4	52C37	Drywall 1/4"	50	18 lbs.
11239	5202-3/8	52C17-3/8	Raised 3/8"	50	16 lbs.
11240	5202-1/2	52C17	Raised 1/2"	50	18 lbs.
11241	5202-5/8	52C18-5/8	Raised 5/8"	50	21 lbs.
11242	5202-3/4	52C18	Raised 3/4"	50	24 lbs.
11244	5202-1	52C19	Raised 1"	25	30 lbs.
11245	5202-1 1/4	52C21	Raised 1 1/4"	25	35 lbs.

OFFSET COVERS — 4" SQUARE

11248*	52C10-F	52C10-F	Flat	100	22 lbs.
11249*	52C10-1/8	52C10-1/8	Raised 1/8"	100	21 lbs.
11250*	52C10-1/4	52C10-1/4	Raised 1/4"	100	22 lbs.
11251*	52C10-1/2	52C10-1/2	Raised 1/2"	100	25 lbs.
11252*	52C10-3/4	52C10-3/4	Raised 3/4"	25	30 lbs.
11253*	52C10-1	52C10-1	Raised 1"	25	33 lbs.

*Not square drawn.

4 11/16" Square Device Covers



 • Galvanized steel.
• UL Listed.

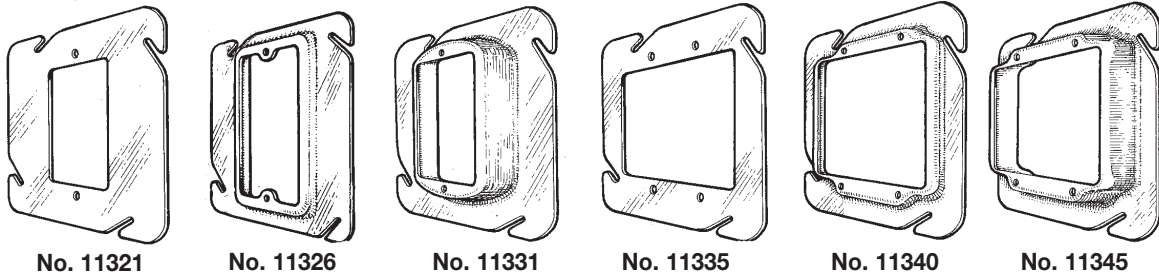

Catalog No.	Old No.	Universal Key No.	Description	Carton Quantity	Weight Per 100 Units
1 DEVICE — 4-11/16" SQUARE (SQUARE DRAWN)					
11321	7201	72C0	Flat	50	31 lbs.
11323	7201-1/4	72C62	Raised 1/4"	50	31 lbs.
11326	7201-1/2	72C13	Raised 1/2"	50	34 lbs.
11327	7201-5/8	72C14-5/8	Raised 5/8"	50	36 lbs.
11328	7201-3/4	72C14	Raised 3/4"	50	38 lbs.
11330	7201-1	72C15	Raised 1"	25	44 lbs.
11331*	7201-1 1/4	72C16	Raised 1 1/4"	25	48 lbs.
2 DEVICES — 4-11/16" SQUARE					
11335	7202	72C00	Flat	50	23 lbs.
11337	7202-1/4	72C20	Raised 1/4"	50	24 lbs.
11340	7202-1/2	72C17	Raised 1/2"	50	29 lbs.
11341	7202-5/8	72C18-5/8	Raised 5/8"	25	32 lbs.
11342	7202-3/4	72C18	Raised 3/4"	25	35 lbs.
11344	7202-1	72C19	Raised 1"	25	46 lbs.
11345	7202-1 1/4	72C21	Raised 1 1/4"	25	43 lbs.

*Not square drawn.

Tile Type Device Covers

4" and 4-11/16" Square



- Galvanized steel.
- UL Listed.

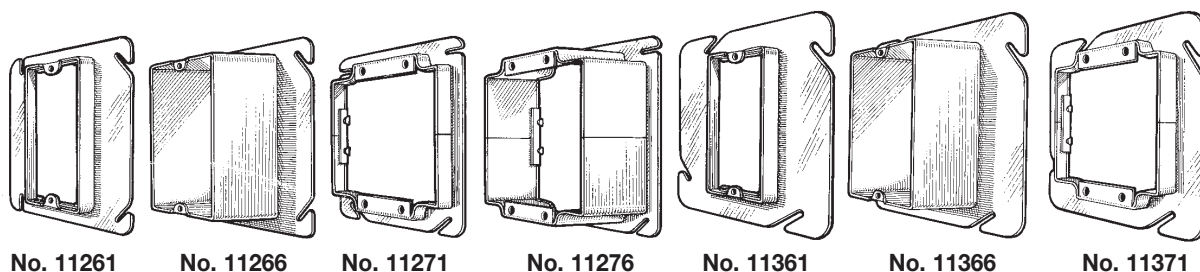

No. 11261

No. 11266

No. 11271

No. 11276

No. 11361

No. 11366

No. 11371

Catalog No.	Old No.	Universal Key No.	Description	Carton Quantity	Weight Per 100 Units
-------------	---------	-------------------	-------------	-----------------	----------------------

1 DEVICE —4" SQUARE

11261	52T1-1/2	52C49-1/2	Raised 1/2"	25	31 lbs.
11262	52T1-3/4	52C49-3/4	Raised 3/4"	25	36 lbs.
11263	52T1-1	52C49-1	Raised 1"	25	41 lbs.
11264	52T1-1 1/4	52C49-1 1/4	Raised 1 1/4"	25	45 lbs.
11265	52T1-1 1/2	52C49-1 1/2	Raised 1 1/2"	25	51 lbs.
11266	52T1-2	52C49-2	Raised 2"	25	60 lbs.

2 DEVICES —4" SQUARE

11271	52T2-1/2	52C52-1/2	Raised 1/2"	25	27 lbs.
11272	52T2-3/4	52C52-3/4	Raised 3/4"	25	33 lbs.
11273	52T2-1	52C52-1	Raised 1"	25	40 lbs.
11274	52T2-1 1/4	52C52-1 1/4	Raised 1 1/4"	25	45 lbs.
11275	52T2-1 1/2	52C52-1 1/2	Raised 1 1/2"	25	51 lbs.
11276	52T2-2	52C52-2	Raised 2"	20	63 lbs.

1 DEVICE —4-11/16" SQUARE

11361	72T1-1/2	72C49-1/2	Raised 1/2"	25	40 lbs.
11362	72T1-3/4	72C49-3/4	Raised 3/4"	25	45 lbs.
11363	72T1-1	72C49-1	Raised 1"	25	51 lbs.
11364	72T1-1 1/4	72C49-1 1/4	Raised 1 1/4"	25	55 lbs.
11365	72T1-1 1/2	72C49-1 1/2	Raised 1 1/2"	25	45 lbs.
11366	72T1-2	72C49-2	Raised 2"	25	70 lbs.

2 DEVICES —4-11/16" SQUARE

11371	72T2-1/2	72C52-1/2	Raised 1/2"	25	36 lbs.
11372	72T2-3/4	72C52-3/4	Raised 3/4"	25	43 lbs.
11373	72T2-1	72C52-1	Raised 1"	25	49 lbs.
11374	72T2-1 1/4	72C52-1 1/4	Raised 1 1/4"	25	55 lbs.
11375	72T2-1 1/2	72C52-1 1/2	Raised 1 1/2"	25	62 lbs.
11376	72T2-2	72C52-2	Raised 2"	20	76 lbs.

Utility Covers



- Galvanized steel, smooth finish.
- 4-³/₃₂" x 2-⁷/₃₂".
- Special utility covers available in stainless steel and painted metal (please use item no. 10011).
- UL Listed.

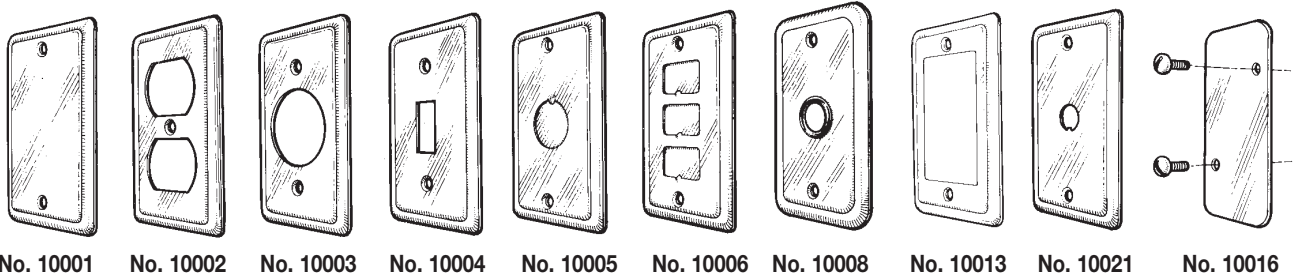

Catalog No.	Old No.	Universal Key No.	Description	Box Quantity	Carton Quantity	Weight Per 100 Units
10001	UB	58C1	Blank	25	250	10 lbs.
10002	UD	58C7	Duplex	25	250	7 lbs.
10003	US	58C5	Single Receptacle	25	250	8 lbs.
10004	UT	58C30	Toggle	25	250	9 lbs.
10005	UK	58C6	½" Knockout	25	250	9 lbs.
10006*†	UAMT	58C40	3 Device Interchangeable with strap	20	200	16 lbs.
10008*	U-01B	58C11	Bushed Telephone 5/8" ID	20	200	11 lbs.
10009	U3R	58C4	1.620" dia. 20A TL Receptacle	25	250	8 lbs.
10010	U3330R	—	1.730" dia. 30A TL Receptacle	25	250	8 lbs.
10013	UGFI	—	GFCI Receptacle (Box mounting 3.281")	25	250	7 lbs.
10021*	AUCD	—	Appliance Switch (.4687" dia.)	25	250	9 lbs.
10016	3/4CFC	—	Rectangular cover for small handy box (3.7813 x 1.5938", fits Appleton 4SS, Raco 640)	25	250	12 lbs.

*Painted with a baked cadilite finish.

†To be discontinued when stock exhausted.

4" Finished Covers

1/2" Raised



COVERS



- Powder coated steel.
- Fully depressed corners for easier, faster mounting.
- Additional screwholes on duplex receptacles to meet NEC requirement.
- Special 4" raised covers available (please use item no. 11441).
- UL Listed.

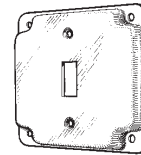

No. 11401

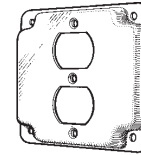

No. 11402

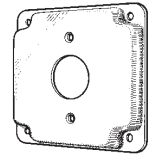

No. 11403

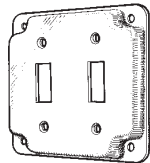

No. 11410

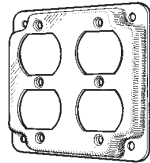

No. 11411

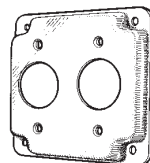

No. 11412

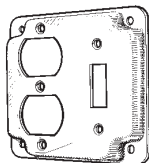

No. 11413

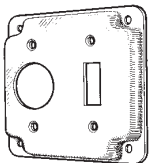

No. 11414

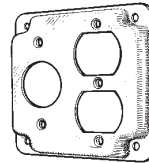

No. 11415

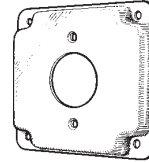

No. 11421

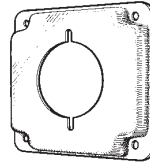

No. 11422

Catalog No.	Old No.	Universal Key No.	Description	Carton Quantity	Weight Per 100 Units
11400	19B	—	Blank	50	38 lbs.
11401	19T	RS9	1 Toggle	50	39 lbs.
11402	19D	RS12	1 Duplex	50	35 lbs.
11403	9S	RS11	1 Single Receptacle	50	36 lbs.
11410	192T	RS5	2 Toggle Switches	50	38 lbs.
11411	192D	RS8	2 Duplex Receptacles	50	31 lbs.
11412	192S	RS10	2 Single Receptacles (2" between device centers)	50	34 lbs.
11413	19TD	RS2	Toggle / Duplex	50	35 lbs.
11414	19TS	RS1	Toggle / Single Receptacle	50	36 lbs.
11415	19DS	RS3	Duplex / Single Receptacle	50	32 lbs.
11421	193R	RS4	1.620" dia. 20A TL Receptacle	50	35 lbs.
11422	193D	RS13	2.125" dia. Range/Dryer Receptacle	50	33 lbs.

4" Finished Covers

1/2" Raised

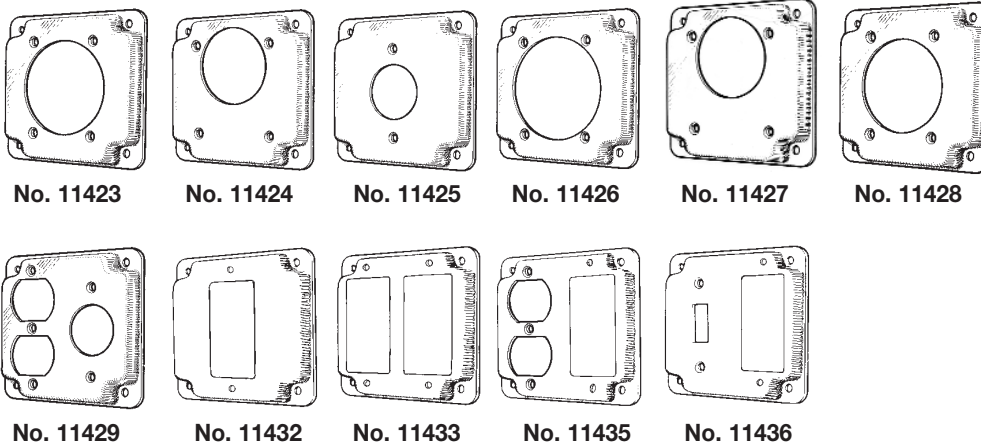

Catalog No.	Old No.	Universal Key No.	Description	Carton Quantity	Weight Per 100 Units
11423	195R	RS14	2.480" dia. Power Outlet	50	30 lbs.
11424	195RR	—	2.165" dia. Power Outlet	50	33 lbs.
11425	193330R	RS15	1.730" dia. TL Receptacle	50	35 lbs.
11426	19L5R	—	1.625" dia. Power Outlet for Leviton #278 & 279	50	29 lbs.
11427	19N5RR	—	2.275" dia. Power Outlet	50	32 lbs.
11428	19P5R	—	2.255" dia. Power Outlet for P&S Nos. 5740, 5744, 5750, 5754, etc.	50	33 lbs.
11429	19D3R	—	1 Duplex / 1 20A TL Receptacle	50	32 lbs.
11432	19GFI	—	1 GFCI Receptacle*	50	33 lbs.
11433	192GFI	—	2 GFCI Receptacles*	50	27 lbs.
11435	19DGFI	—	1 Duplex / 1 GFCI Receptacle*	50	27 lbs.
11436	19TGFI	—	1 Toggle Switch / 1 GFCI Receptacle*	50	35 lbs.

*Strap "ears" must be cut off prior to mounting on plate.

4 11/16" Finished Covers

1/2" Raised



COVERS



- Powder coated steel.
- Additional screwholes meet NEC requirement and mount to ears on any box.
- Special 4-11/16" raised covers available (please use item no. 11541).
- UL Listed.

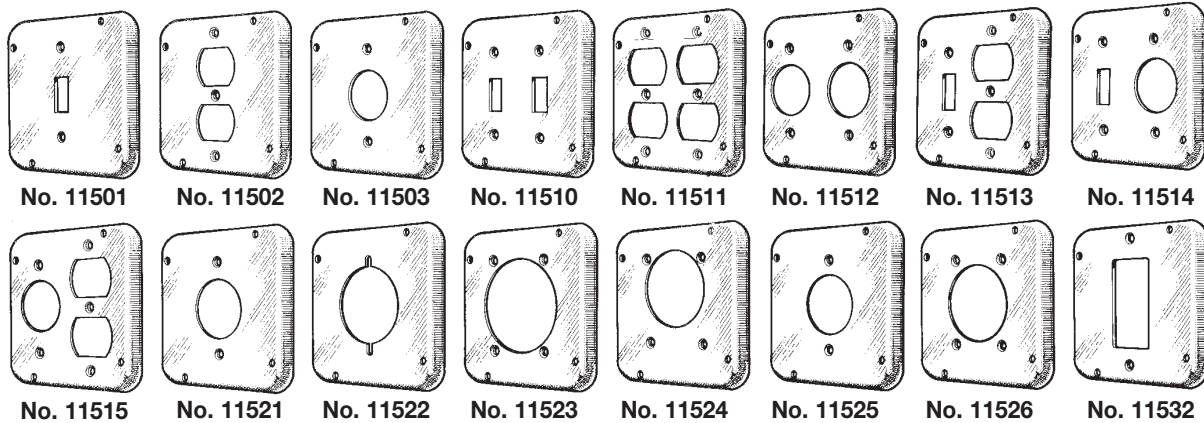

Catalog No.	Old No.	Universal Key No.	Description	Carton Quantity	Weight Per 100 Units
11500	72RBL	—	Blank	25	53 lbs.
11501	72RT	RSL9	Toggle	25	51 lbs.
11502	72RD	RSL12	Duplex	25	48 lbs.
11503	72RS	RSL11	1 Single Receptacle	25	50 lbs.
11510	72R2T	RSL5	2 Toggle Switches	25	52 lbs.
11511	72R2D	RSL8	2 Duplex Receptacles	25	45 lbs.
11512	72R2S	RSL10	2 Single Receptacles (2" between device centers)	25	49 lbs.
11513	72RTD	RSL2	Toggle / Duplex	25	47 lbs.
11514	72RTS	RSL1	Toggle / Single Receptacle	25	52 lbs.
11515	72RDS	RSL3	Duplex / Single Receptacle	25	46 lbs.
11521	72R3R	RSL4	1.620" dia. 20A TL Receptacle	25	49 lbs.
11522	72R3D	RSL13	2.125" dia. Range/ Dryer Receptacle	25	47 lbs.
11523	72R5R	RSL14	2.480" dia. Power Outlet	25	45 lbs.
11524	72R5RR	—	2.165" dia. Power Outlet	25	46 lbs.
11525	72R3330	RSL15	1.730" dia. Power Outlet	25	48 lbs.
11526	72RL5R	—	2.625" dia. Power Outlet	25	43 lbs.
11527	72RN5RR	—	2.275" dia. Power Outlet	25	46 lbs.
11528	72RP5R	—	2.255" dia. Power Outlet	25	48 lbs.
11529	72R23R	—	2 1.620" dia. 20A TL Receptacles (2.25" between device centers)	25	46 lbs.
11532	72RGFI	—	1 GFCI Receptacle	25	47 lbs.
11533	72R2GFI	—	2 GFCI Receptacles	25	40 lbs.
11534	72RD3D	—	1 Duplex / 2.125" dia. Receptacle	25	43 lbs.
11535	72RDGFI	—	1 Duplex / 1 GFCI Receptacle	25	45 lbs.
11536	72RTGFI	—	1 Toggle Switch / 1 GFCI Receptacle	25	47 lbs.
11538	72RD3R	—	Duplex / 1.620" dia. TL Receptacle	25	46 lbs.

FS Type Covers

1-3 Gangs



- Powder coated steel.
- Raised, rounded edge for use with FS fittings with raised lip on top, except Crouse Hinds.
- Special FS covers available in stainless steel or aluminum (please use item nos. 11641-11643 for 1-3 gangs).

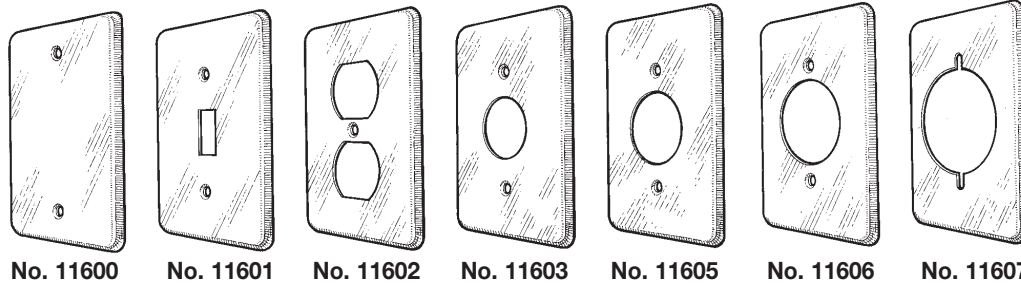

Catalog No.	Old No.	Description	Box Quantity	Carton Quantity	Weight Per 100 Units
1 GANG					
11600	FSB	Blank	20	200	14 lbs.
11601	FST	Toggle	20	200	16 lbs.
11602	FSD	Duplex	20	200	13 lbs.
11603	FSR	Single Receptacle	20	200	13 lbs.
11605	FS3R	1.620" dia. TL Receptacle	20	200	14 lbs.
11606	FS3330R	1.730" dia. TL Receptacle	20	200	12 lbs.
11607	FS3D	2.125" dia. Range/Dryer Rcpt.	20	200	11 lbs.
11608	—	GFCI Receptacle (2 screw)	20	200	12 lbs.
11609	—	GFCI Receptacle (4 screw)	20	200	13 lbs.
2 GANGS					
11611	FS2B	2 Blank	10	100	22 lbs.
11612	FS2T	2 Toggle Switches	10	100	21 lbs.
11613	FS2D	2 Duplex Receptacles	10	100	17 lbs.
11614	FS2R	2 Single Receptacles	10	100	20 lbs.
11615	FSTD	Toggle / Duplex	10	100	23 lbs.
11616	FSTS	Toggle / Single Receptacle	10	100	21 lbs.
11618	FS23D	2.125" dia. Range/Dryer Rcpt.	10	100	19 lbs.
11620	—	2 GFCI Receptacles	10	100	15 lbs.
11621	—	Switch / GFC1 Receptacle	10	100	19 lbs.
3 GANGS					
11622	FS3B	3 Blank	10	100	33 lbs.
11623	FS3T	3 Toggle Switches	10	100	31 lbs.
11624	FS3D	3 Duplex Receptacles	10	100	24 lbs.
11625	FS2TD	2 Toggle / 1 Duplex Receptacle	10	100	34 lbs.
11626	FS2TS	2 Toggle / 1 Single Receptacle	10	100	35 lbs.
11628	FS23R	2 1.620" dia. TL Receptacles	10	100	20 lbs.
11629	FS23330R	1 1.730" dia. TL Receptacles	10	100	19 lbs.
11630	—	3 GFCI Receptacles	10	100	27 lbs.

Flat Gang Box Covers

2-10 Gangs



COVERS

- Galvanized steel.
- Devices spaced 1-13/16" between centers.
- All gang box covers 4-11/16" high.
- Individually packaged.
- Special covers available (please use item nos. 10142-10150 for 2-10 gangs).

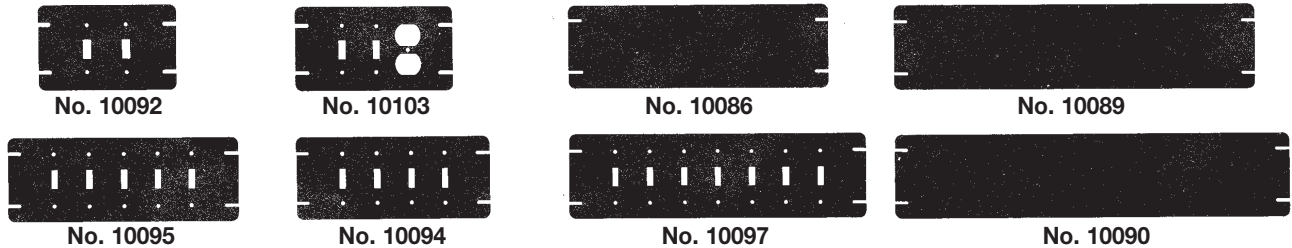

Catalog No.	Old No.	Description	Width	Weight Per 100 Units
BLANKS				
10082	2BGB	2 Gang Blank	7"	58 lbs.
10083	3BGB	3 Gang Blank	8-7/8"	68 lbs.
10084	4BGB	4 Gang Blank	10-5/8"	86 lbs.
10085	5BGB	5 Gang Blank	12-7/16"	107 lbs.
10086	6BGB	6 Gang Blank	14-1/4"	117 lbs.
10087	7BGB	7 Gang Blank	16-1/16"	137 lbs.
10088	8BGB	8 Gang Blank	17-15/16"	150 lbs.
10089	9BGB	9 Gang Blank	19-3/4"	170 lbs.
10090	10BGB	10 Gang Blank	21-9/16"	182 lbs.
SWITCHES				
10092	2TGB	2 Gang Switch	7"	56 lbs.
10093	3TGB	3 Gang Switch	8-7/8"	66 lbs.
10094	4TGB	4 Gang Switch	10-5/8"	87 lbs.
10095	5TGB	5 Gang Switch	12-7/16"	103 lbs.
10096	6TGB	6 Gang Switch	14-1/4"	113 lbs.
10097	7TGB	7 Gang Switch	16-1/16"	132 lbs.
10098	8TGB	8 Gang Switch	17-15/16"	146 lbs.
10099	9TGB	9 Gang Switch	19-3/4"	154 lbs.
10100	10TGB	10 Gang Switch	21-9/16"	173 lbs.
COMBINATIONS AND DUPLEX RECEPTACLES				
10103	2T10DRGB	3 Gang: 2 Switch, 1 Duplex	8-7/8"	62 lbs.
10104	3T10DRGB	4 Gang: 3 Switch, 1 Duplex	10-5/8"	83 lbs.
10105	4T10DRGB	5 Gang: 4 Switch, 1 Duplex	12-7/16"	93 lbs.
10111	1T20DRGB	3 Gang: 1 Switch, 2 Duplex	8-7/8"	59 lbs.
10122	20DRGB	2 Gang Duplex Receptacle	7"	47 lbs.
10123	30DRGB	3 Gang Duplex Receptacle	8-7/8"	54 lbs.
10124	40DRGB	4 Gang Duplex Receptacle	10-5/8"	71 lbs.
10125	50DRGB	5 Gang Duplex Receptacle	12-7/16"	79 lbs.
10126	60DRGB	6 Gang Duplex Receptacle	14-1/4"	88 lbs.
10127	70DRGB	7 Gang Duplex Receptacle	16-1/16"	99 lbs.
10128	80DRGB	8 Gang Duplex Receptacle	17-15/16"	105 lbs.
10129	90DRGB	9 Gang Duplex Receptacle	19-3/4"	120 lbs.
10130	100DRGB	10 Gang Duplex Receptacle	21-9/16"	137 lbs.

Reducing Washers

1/2" x 1/4" - 4" x 3-1/2"

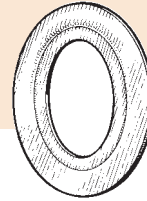

- Galvanized steel.
- Raised flanges to fit snugly into box knockout.
- Minimum order: box quantity.

Catalog No.	Old No.	Box Size	Box Quantity	Carton Quantity	Weight Per 100 Units
40001	R00*	1/2" x 15/32"	250	2500	.9 lbs.
40002	R0**	1/2" x 1/4"	250	2500	.9 lbs.
40003	R1	1/2" x 3/8"	250	2500	.9 lbs.
40005	R2	3/4" x 1/2"	250	2500	1.6 lbs.
40006	R3	1" x 1/2"	250	2500	1.6 lbs.
40007	R4	1" x 3/4"	250	2500	1.4 lbs.
40008	R5	1 1/4" x 1/2"	100	1000	3 lbs.
40009	R6	1 1/4" x 3/4"	100	1000	3 lbs.
40010	R7	1 1/4" x 1"	100	1000	3 lbs.
40011	R8	1 1/2" x 1/2"	100	1000	5 lbs.
40012	R9	1 1/2" x 3/4"	100	1000	5 lbs.
40013	R10	1 1/2" x 1"	100	1000	4 lbs.
40014	R11	1 1/2" x 1 1/4"	100	1000	3 lbs.
40015	R12	2" x 1/2"	50	500	10 lbs.
40016	R13	2" x 3/4"	50	500	9 lbs.
40017	R14	2" x 1"	50	500	8 lbs.
40018	R15	2" x 1 1/4"	50	500	7 lbs.
40019	R16	2" x 1 1/2"	50	500	6 lbs.
40020	R17	2 1/2" x 1/2"	25	250	10 lbs.
40021	R18	2 1/2" x 3/4"	25	250	8 lbs.
40022	R19	2 1/2" x 1"	25	250	9 lbs.
40023	R20	2 1/2" x 1 1/4"	25	250	8 lbs.
40024	R21	2 1/2" x 1 1/2"	25	250	7 lbs.
40025	R22	2 1/2" x 2"	25	250	5 lbs.
40026	R23	3" x 1/2"	25	250	21 lbs.
40027	R24	3" x 3/4"	25	250	20 lbs.
40028	R25	3" x 1"	25	250	20 lbs.
40029	R26	3" x 1 1/4"	25	250	18 lbs.
40030	R27	3" x 1 1/2"	25	250	19 lbs.
40031	R28	3" x 2"	25	250	15 lbs.
40032	R29	3" x 2 1/2"	25	250	13 lbs.
40033	R30	3 1/2" x 1/2"	10	100	35 lbs.
40034	R31	3 1/2" x 3/4"	10	100	35 lbs.
40035	R32	3 1/2" x 1"	10	100	33 lbs.
40036	R33	3 1/2" x 1 1/4"	10	100	32 lbs.
40037	R34	3 1/2" x 1 1/2"	10	100	30 lbs.
40038	R35	3 1/2" x 2"	10	100	28 lbs.
40039	R36	3 1/2" x 2 1/2"	10	100	24 lbs.
40040	R37	3 1/2" x 3"	10	100	18 lbs.
40041	R38	4" x 1/2"	20	100	42 lbs.
40042	R39	4" x 3/4"	20	100	42 lbs.
40043	R40	4" x 1"	20	100	41 lbs.
40044	R41	4" x 1 1/4"	20	100	36 lbs.
40045	R42	4" x 1 1/2"	20	100	37 lbs.
40046	R43	4" x 2"	20	100	34 lbs.
40047	R44	4" x 2 1/2"	20	100	31 lbs.
40048	R45	4" x 3"	20	100	25 lbs.
40049	R46	4" x 3 1/2"	20	100	20 lbs.

REDUCING WASHERS

*R00 fits McGill canopy switch. **R0 fits standard canopy switch.

Conduit Bodies

Threaded and Set Screw Bodies and Kits



- Die-cast aluminum.
- Smooth, corrosion-resistant electrostatic powder coating.
- Available unassembled (body only) or assembled with matching steel cover and gasket.
- All 2½ - 4" conduit bodies and all SLBs come assembled with steel cover and gasket.
- Kits with aluminum covers also available.
- Cubic capacity and listings clearly marked.
- Ask about our "Great Bodies" promotion.
- UL Listed.

Hub Size	Unassembled (body only) Catalog No.		Assembled (with cover and gasket) Catalog No.		Box Quantity	Carton Quantity
	Threaded	Set Screw	Threaded	Set Screw		
LB						
½"	11801	11851	12801	12851	10	50
¾"	11802	11852	12802	12852	10	50
1"	11803	11853	12803	12853	5	25
1¼"	11804	11854	12804	12854	—	2
1½"	11805	11855	12805	12855	—	2
2"	11806	11856	12806	12856	—	1
2½"			12807	12857	—	1
3"			12808	12858	—	1
3½"			12809		—	1
4"			12810		—	1
LL						
½"	11811	11861	12811	12861	10	50
¾"	11812	11862	12812	12862	10	50
1"	11813	11863	12813	12863	5	25
1¼"	11814	11864	12814	12864	—	2
1½"	11815	11865	12815	12865	—	2
2"	11816	11866	12816	12866	—	1
2½"			12817		—	1
3"			12818		—	1
3½"			12819		—	1
4"			12820		—	1

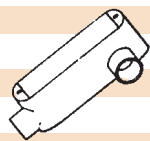
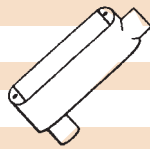

CONDUIT BODIES AND COVERS

For weights, please see price sheet or call Customer Service.

Conduit Bodies

Threaded and Set Screw Bodies and Kits



Hub Size	Unassembled (body only) Catalog No.		Assembled (with cover and gasket) Catalog No.		Box Quantity	Carton Quantity
	Threaded	Set Screw	Threaded	Set Screw		
LR						
1/2"	11821	11871	12821	12871	10	50
3/4"	11822	11872	12822	12872	10	50
1"	11823	11873	12823	12873	5	25
1 1/4"	11824	11874	12824	12874	—	2
1 1/2"	11825	11875	12825	12875	—	2
2"	11826	11876	12826	12876	—	1
2 1/2"			12827		—	1
3"			12828		—	1
3 1/2"			12829		—	1
4"			12830		—	1
C						
1/2"	11831	11881	12831	12881	10	50
3/4"	11832	11882	12832	12882	10	50
1"	11833	11883	12833	12883	5	25
1 1/4"	11834	11884	12834	12884	—	2
1 1/2"	11835	11885	12835	12885	—	2
2"	11836	11886	12836	12886	—	1
2 1/2"			12837		—	1
3"			12838		—	1
T						
1/2"	11841	11891	12841	12891	10	50
3/4"	11842	11892	12842	12892	10	50
1"	11843	11893	12843	12893	5	25
1 1/4"	11844	11894	12844	12894	—	2
1 1/2"	11845	11895	12845	12895	—	2
2"	11846	11896	12846	12896	—	1
2 1/2"			12847		—	1
3"			12848		—	1

CONDUIT BODIES AND COVERS

Conduit Bodies

SLBs and Moguls

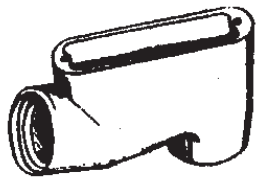





SLB



Catalog No.	Hub Size	Box Quantity	Carton Quantity	Weight per 100 Units
SLBs				
11901	1/2"	10	50	24 lbs.
11902	3/4"	10	50	30 lbs.
11903	1"	5	25	55 lbs.
11904	1 1/4"	—	1	140 lbs.
11905	1 1/2"	—	1	150 lbs.
11906	2"	—	1	260 lbs.

MOGUL CONDUIT BODIES COMPLETE WITH COVER, GASKET, AND SCREWS

-  • Die-cast aluminum alloy
-  • Suitable for wet locations
-  • Meet NEC 6x requirements
-  • Dome-style cover allows easier wire pulling
-  • UL Listed and CSA Approved

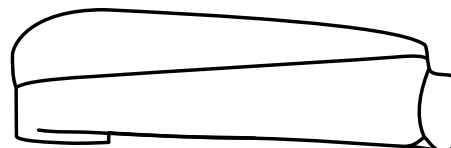

11914	1 1/4"	5	130 lbs.
11915	1 1/2"	2	350 lbs.
11916	2"	2	310 lbs.

Conduit Fitting Covers and Gaskets

Oval-Round F-35 Series, 1/2" - 4"



- Galvanized steel or aluminum.
- Screws and washers mounted.
- Gaskets are neoprene rubber.
- For use with all standard conduit bodies, except Crouse Hinds and 2½"-3" and 3½"-4" Red Dot/L.E. Mason.
- UL Listed.

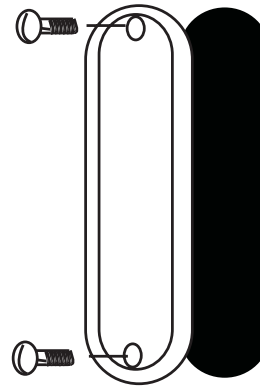

No. 11699 No. 11720

Catalog No.	Old No.	Description	Box Quantity	Carton Quantity	Weight Per 100 Units
GALVANIZED STEEL — 1/2 - 4"					
11699	1/2F35C	Blank, ½"	25	250	10 lbs.
11700	3/4F35C	Blank, ¾"	25	250	13 lbs.
11701	1F35C	Blank, 1"	20	200	15 lbs.
11702	1-1/4F35C	Blank, 1¼"-1½"	—	25	32 lbs.
11703	2F35C	Blank, 2"	—	25	51 lbs.
11704	3F35C	Blank, 2½"-3"	—	25	88 lbs.
11705	4F35C	Blank, 3½"-4"	—	25	142 lbs.
ALUMINUM — 1/2 - 4"					
11710	1/2AF35C	Blank, ½"	25	250	4 lbs.
11711	3/4AF35C	Blank, ¾"	25	250	5 lbs.
11712	1AF35C	Blank, 1"	20	200	7 lbs.
11713	1-1/4AF35C	Blank, 1¼"-1½"	—	25	13 lbs.
11714	2AF35C	Blank, 2"	—	25	25 lbs.
11715	3AF35C	Blank, 2½"-3"	—	25	36 lbs.
11716	4AF35C	Blank, 3½"-4"	—	25	66 lbs.
GASKETS — 1/2 - 4"					
11720	1/2F35G	Full, ½"	100	1000	2 lbs.
11721	3/4F35G	Full, ¾"	100	1000	2 lbs.
11722	1F35G	Full, 1"	50	500	3 lbs.
11723	1-1/4F35G	Full, 1¼"-1½"	—	600	5 lbs.
11724	2F35G	Full, 2"	—	400	7 lbs.
11725	3F35G	Full, 2½"-3"	—	200	14 lbs.
11726	4F35G	Full, 3½"-4"	—	150	20 lbs.

CONDUIT BODIES AND COVERS

Knockout Seals, Switchbox Supports, and Nail Plates

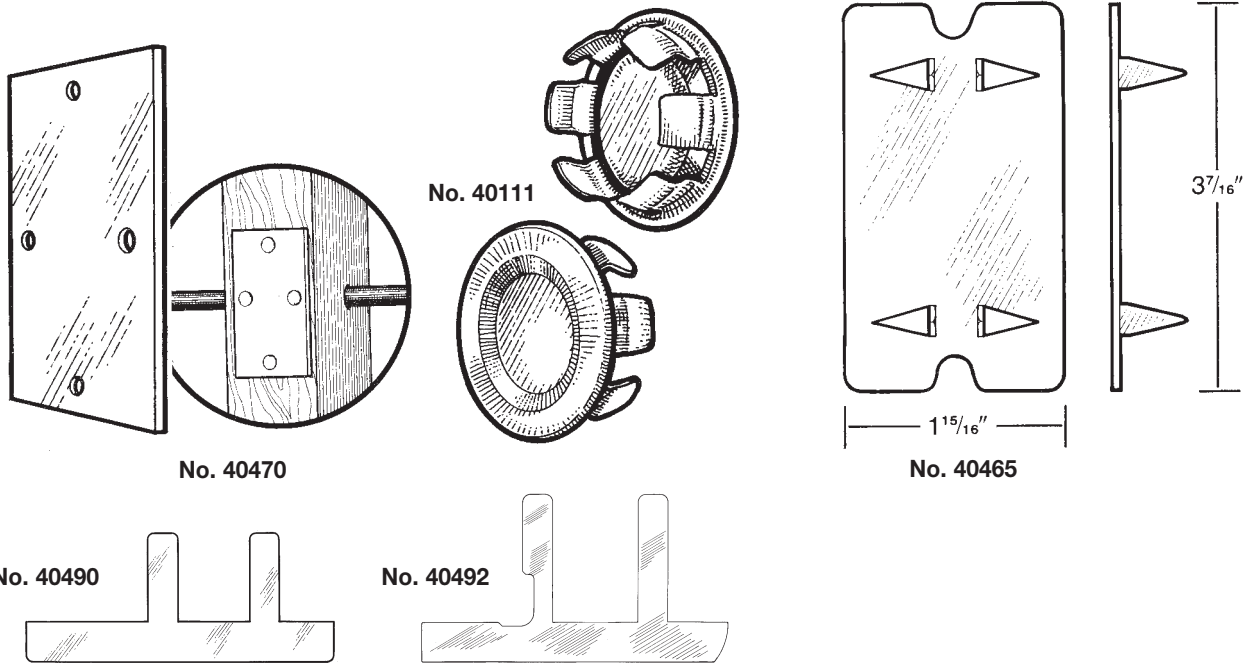

Catalog No.	Old No.	Description	Box Quantity	Carton Quantity	Weight Per 100 Units
CLOSED TYPE KNOCKOUT SEALS; BRIGHT ZINC PLATED STEEL					
40111	CKS1	1/2"	100	1000	1.5 lbs.
40112	CKS2	3/4"	100	1000	1.8 lbs.
40113	CKS3	1"	50	500	2 lbs.
40114	CKS4	1 1/4"	50	500	3 lbs.
40115	CKS5	1 1/2"	50	500	4 lbs.
40116	CKS6	2"	25	250	6 lbs.

SWITCH BOX SUPPORTS

40490	GBS	Standard	50 pairs	500 pairs	3 lbs.
40492	LLGBS	Long Legs	50 pairs	500 pairs	3 lbs.

NAIL PLATES (.062" THICK STEEL)

40465	NPH	1-15/16" x 3 7/16" Self-nailing	—	200	12 lbs.
40470	NPH	1 1/2" x 3" 4 nail holes	—	200	8 lbs.



Mulberry Metal Products, Inc.
2199 Stanley Terrace
P.O. Box 443
Union, New Jersey 07083

tel. 908.688.8850
fax. 908.688.7294
www.mulberrymetal.com

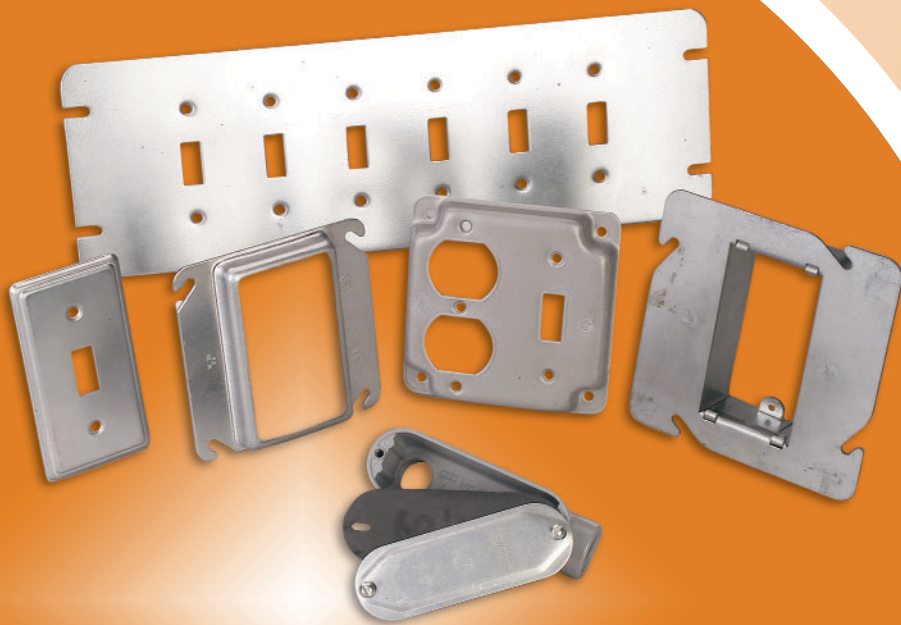

Mulberry

Outlet Box Covers

Device • Utility • Finished • FS • Gang
Conduit Bodies and Covers • KO Seals
Reducing Washers



Mulberry Outlet Box Covers

New in this catalog:

- *A full line of die-cast, powder painted conduit bodies: 1/2 - 4", threaded and set screw.*
- *Assembled conduit body kits.*
- *Mogul conduit bodies.*
- *More illustrations and details on finished covers.*
- *Information on covers with special openings.*

As always, Mulberry offers:

- *Superior quality casting, tapping, and finishing.*
- *Smooth powder paint finish on 4" raised covers and conduit bodies.*
- *Special openings and combinations on most covers.*
- *Excellent service: local stock, fast turnaround, and quick delivery from our factory and regional warehouses.*
- *Products made in USA.*

COVERS

Round	C4
Square	C5
4" Square Device and Offset	C6
4-11/16" Square Device	C7
Tile Type Device	C8
Utility	C9
4" Finished	C10-11
4-11/16" Finished	C12
FS Type	C13
Flat Gang Box	C14

REDUCING WASHERS

C15

CONDUIT BODIES AND COVERS

Threaded and Set Screw Bodies and Kits	C16-17
SLBs and Moguls	C18
Covers and Gaskets	C19

KNOCKOUT SEALS, SWITCHBOX SUPPORTS, AND NAIL PLATES

C20

Conduit Bodies

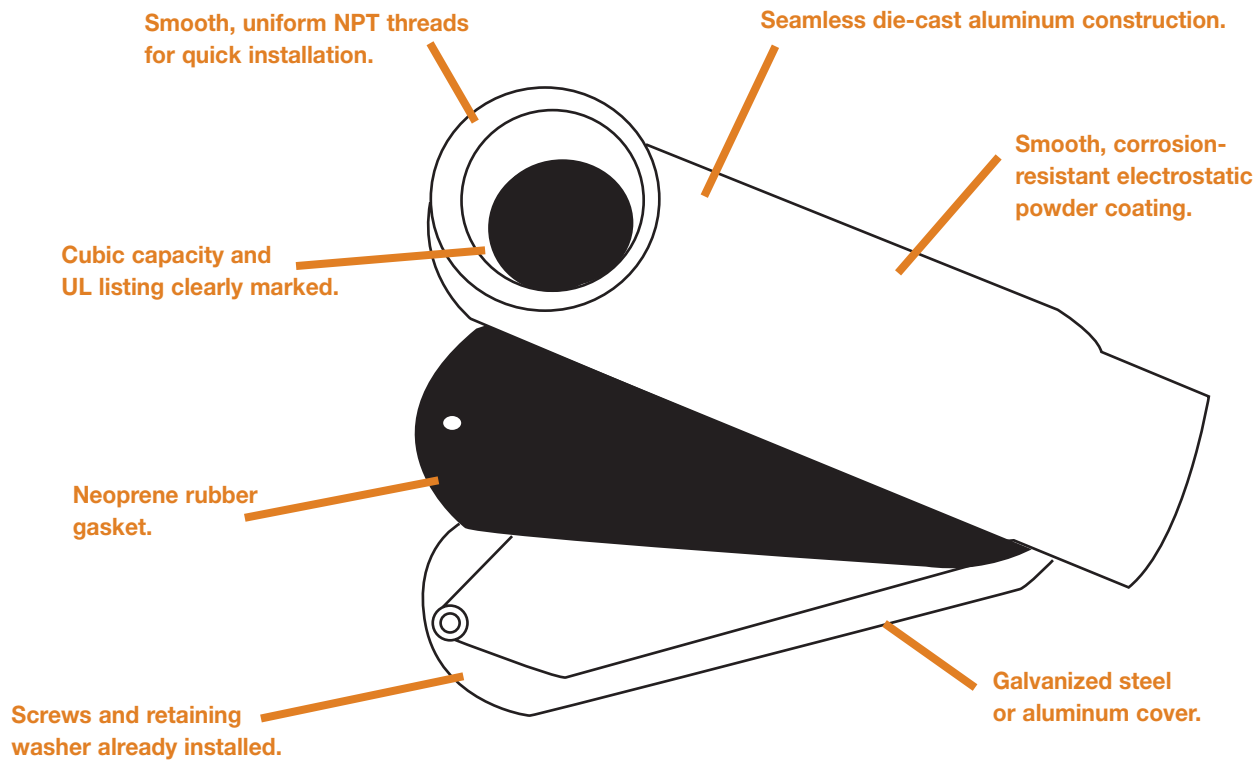

- Unassembled (body only) or assembled with matching steel cover and gasket.
- Kits with aluminum covers also available.
- Please see pages C16-C19 for details.
- Ask about our "Great Bodies" promotion.

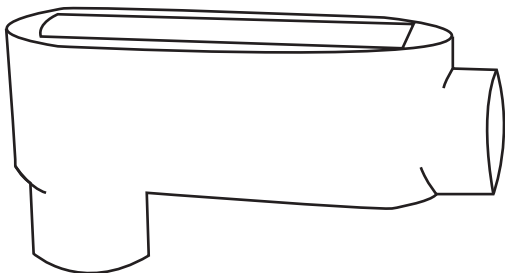

Threaded Bodies for Rigid or IMC

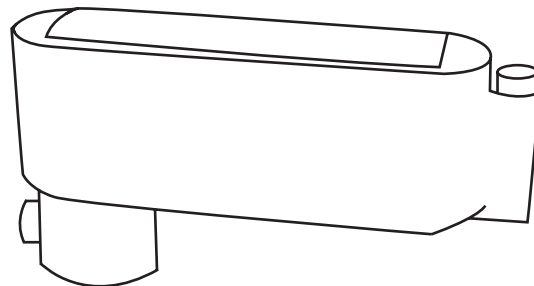

Set-Screw Bodies for EMT



Round Covers

3-1/2" and 4"



- Galvanized steel.
- UL Listed.

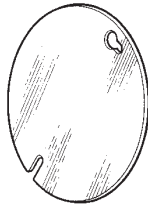

No. 11001



No. 11003

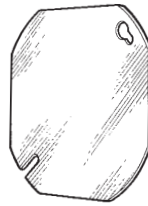

No. 11101

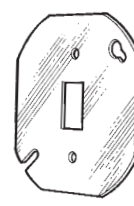

No. 11108

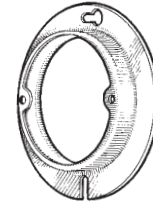

No. 11124

Catalog No.	Old No.	Universal Key No.	Description	Carton Quantity	Weight Per 100 Units
3 1/2" ROUND FLAT					
11001	24FC	24C1	Blank	100	17 lbs.
11002†	24FB	24C12F	Bushed Hole (.4375" dia.)	100	17 lbs.
11003	24FK	24C6	1/2" Knockout	100	17 lbs.
11006	24FR	24C50	Single Receptacle	100	14 lbs.
11008	24FT	—	Toggle	100	16 lbs.

4" ROUND FLAT					
11101	54FC	54C1	Blank	100	21 lbs.
11102†	54FB	54C12F	Bushed Hole (.4375" dia.)	100	21 lbs.
11103	54FK	54C6	1/2" Knockout	100	21 lbs.
11104†	54FS	54C28	Spider	100	18 lbs.
11105*	54FD	54C100	Duplex Receptacle	100	19 lbs.
11106	54FR	54C50	Single Receptacle	100	20 lbs.
11108	54FT	—	Toggle	100	23 lbs.
11109	543R	—	TL Receptacle (1.5937" dia.)	100	20 lbs.

4" ROUND RAISED					
11121	54RC	54C2	Blank	100	29 lbs.
11122†	54RB	54C12	Bushed Hole (.4375" dia.)	100	29 lbs.
11123†	54RK	54C7	1/2" Knockout	100	29 lbs.
11124	54R3	54C3	3" Opening (ears tapped, 2 3/4" between device centers, raised 5/8")	100	19 lbs.
11125	54R3-1/2	54C3-1/2	3" Opening (ears tapped, 2 3/4" between device centers, raised 1/2")	100	18 lbs.

*Not UL Listed.

†To be discontinued when stock exhausted.

Square Covers

4" and 4-11/16"



- Galvanized steel.
- UL Listed.

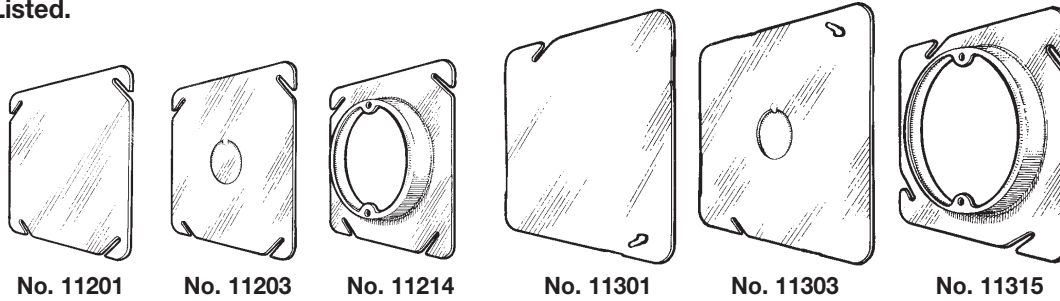

Catalog No.	Old No.	Universal Key No.	Description	Carton Quantity	Weight Per 100 Units
4" SQUARE FLAT					
11201	52FC	52C1	Blank	50	29 lbs.
11202†	52FB	52C12F	Bushed Hole (.4375" dia.)	100	29 lbs.
11203	52FK	52C6	½" Knockout	100	28 lbs.
4" SQUARE RAISED					
11211	52RC	52C2	Blank, Raised 5/8"	100	36 lbs.
11212	52RB	—	Bushed Hole (.4375" dia.)	100	38 lbs.
11214	52R3	52C3	3" Opening (ears tapped, 2¾" between device centers, raised 5/8")	100	26 lbs.
11215	52R3-½	52C3-½	3" Opening (ears tapped, 2¾" between device centers, raised ½")	100	22 lbs.
4-11/16" SQUARE FLAT					
11301	72FC	72C1	Blank	50	40 lbs.
11303	72FK	72C6	½" Knockout	50	39 lbs.
4-11/16" SQUARE-RAISED 5/8"					
11311	72RC	72C2	Blank	25	50 lbs.
11314	72R3	72C3	3" Opening (ears tapped, 2¾" between device centers)	25	38 lbs.
11315	72R4	72C4	4" Opening (ears tapped, 3½" between device centers)	25	30 lbs.

†To be discontinued when stock exhausted.

4" Square Device and Offset Covers



- Square drawn.
- Galvanized steel.
- UL Listed.

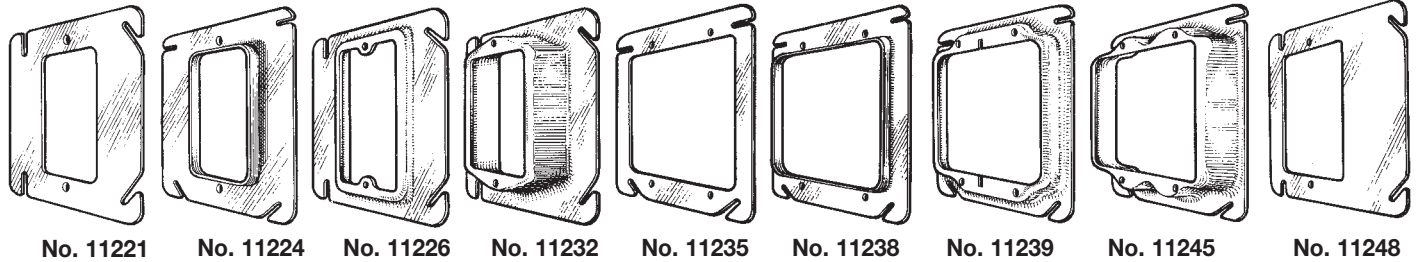

Catalog No.	Old No.	Universal Key No.	Description	Carton Quantity	Weight Per 100 Units
-------------	---------	-------------------	-------------	-----------------	----------------------

1 DEVICE — 4" SQUARE (SQUARE DRAWN)

11221	5201	52C0	Flat	100	17 lbs.
11222	5201-1/8	52C62-1/8	Raised 1/8"	100	17 lbs.
11223	5201-1/4	52C62	Raised 1/4"	100	18 lbs.
11224	5201DW-1/4	52C36	Drywall 1/4"	100	25 lbs.
11225	5201-3/8	52C13-3/8	Raised 3/8"	100	19 lbs.
11226	5201-1/2	52C13	Raised 1/2 "	100	22 lbs.
11227	5201-5/8	52C14-5/8	Raised 5/8"	50	25 lbs.
11228	5201-3/4	52C14	Raised 3/4"	50	28 lbs.
11230	5201-1	52C15	Raised 1"	25	33 lbs.
11231	5201-1 1/4	52C16	Raised 1 1/4"	25	38 lbs.
11232*	5201-1 1/2	52C16-1 1/2	Raised 1 1/2 "	25	41 lbs.

2 DEVICES — 4" SQUARE

11235	5202	52C00	Flat	100	12 lbs.
11236	5202-1/8	52C20-1/8	Raised 1/8"	50	13 lbs.
11237	5202-1/4	52C20	Raised 1/4"	50	13 lbs.
11238	5202DW-1/4	52C37	Drywall 1/4"	50	18 lbs.
11239	5202-3/8	52C17-3/8	Raised 3/8"	50	16 lbs.
11240	5202-1/2	52C17	Raised 1/2"	50	18 lbs.
11241	5202-5/8	52C18-5/8	Raised 5/8"	50	21 lbs.
11242	5202-3/4	52C18	Raised 3/4"	50	24 lbs.
11244	5202-1	52C19	Raised 1"	25	30 lbs.
11245	5202-1 1/4	52C21	Raised 1 1/4"	25	35 lbs.

OFFSET COVERS — 4" SQUARE

11248*	52C10-F	52C10-F	Flat	100	22 lbs.
11249*	52C10-1/8	52C10-1/8	Raised 1/8"	100	21 lbs.
11250*	52C10-1/4	52C10-1/4	Raised 1/4"	100	22 lbs.
11251*	52C10-1/2	52C10-1/2	Raised 1/2"	100	25 lbs.
11252*	52C10-3/4	52C10-3/4	Raised 3/4"	25	30 lbs.
11253*	52C10-1	52C10-1	Raised 1"	25	33 lbs.

*Not square drawn.

4 11/16" Square Device Covers



UL • Galvanized steel.
• UL Listed.

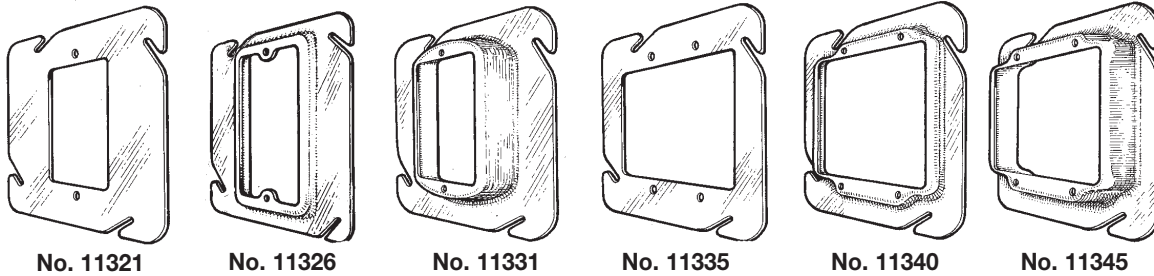

Catalog No.	Old No.	Universal Key No.	Description	Carton Quantity	Weight Per 100 Units
1 DEVICE — 4-11/16" SQUARE (SQUARE DRAWN)					
11321	7201	72C0	Flat	50	31 lbs.
11323	7201-1/4	72C62	Raised 1/4"	50	31 lbs.
11326	7201-1/2	72C13	Raised 1/2"	50	34 lbs.
11327	7201-5/8	72C14-5/8	Raised 5/8"	50	36 lbs.
11328	7201-3/4	72C14	Raised 3/4"	50	38 lbs.
11330	7201-1	72C15	Raised 1"	25	44 lbs.
11331*	7201-1 1/4	72C16	Raised 1 1/4"	25	48 lbs.
2 DEVICES — 4-11/16" SQUARE					
11335	7202	72C00	Flat	50	23 lbs.
11337	7202-1/4	72C20	Raised 1/4"	50	24 lbs.
11340	7202-1/2	72C17	Raised 1/2"	50	29 lbs.
11341	7202-5/8	72C18-5/8	Raised 5/8"	25	32 lbs.
11342	7202-3/4	72C18	Raised 3/4"	25	35 lbs.
11344	7202-1	72C19	Raised 1"	25	46 lbs.
11345	7202-1 1/4	72C21	Raised 1 1/4"	25	43 lbs.

*Not square drawn.

Tile Type Device Covers

4" and 4-11/16" Square



- Galvanized steel.
- UL Listed.

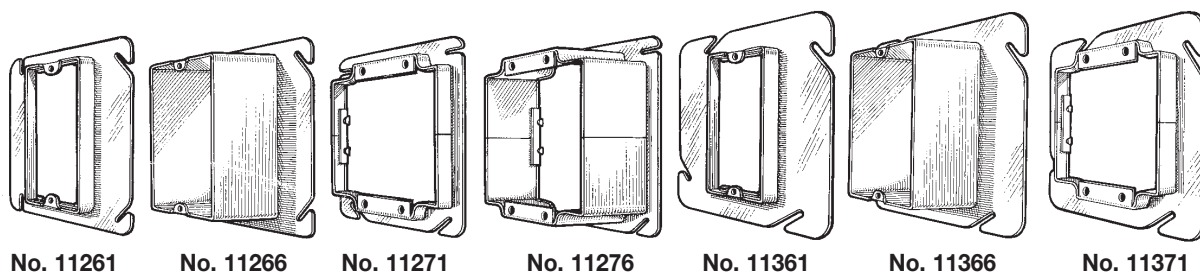

No. 11261

No. 11266

No. 11271

No. 11276

No. 11361

No. 11366

No. 11371

Catalog No.	Old No.	Universal Key No.	Description	Carton Quantity	Weight Per 100 Units
-------------	---------	-------------------	-------------	-----------------	----------------------

1 DEVICE —4" SQUARE

11261	52T1-1/2	52C49-1/2	Raised 1/2"	25	31 lbs.
11262	52T1-3/4	52C49-3/4	Raised 3/4"	25	36 lbs.
11263	52T1-1	52C49-1	Raised 1"	25	41 lbs.
11264	52T1-1 1/4	52C49-1 1/4	Raised 1 1/4"	25	45 lbs.
11265	52T1-1 1/2	52C49-1 1/2	Raised 1 1/2"	25	51 lbs.
11266	52T1-2	52C49-2	Raised 2"	25	60 lbs.

2 DEVICES —4" SQUARE

11271	52T2-1/2	52C52-1/2	Raised 1/2"	25	27 lbs.
11272	52T2-3/4	52C52-3/4	Raised 3/4"	25	33 lbs.
11273	52T2-1	52C52-1	Raised 1"	25	40 lbs.
11274	52T2-1 1/4	52C52-1 1/4	Raised 1 1/4"	25	45 lbs.
11275	52T2-1 1/2	52C52-1 1/2	Raised 1 1/2"	25	51 lbs.
11276	52T2-2	52C52-2	Raised 2"	20	63 lbs.

1 DEVICE —4-11/16" SQUARE

11361	72T1-1/2	72C49-1/2	Raised 1/2"	25	40 lbs.
11362	72T1-3/4	72C49-3/4	Raised 3/4"	25	45 lbs.
11363	72T1-1	72C49-1	Raised 1"	25	51 lbs.
11364	72T1-1 1/4	72C49-1 1/4	Raised 1 1/4"	25	55 lbs.
11365	72T1-1 1/2	72C49-1 1/2	Raised 1 1/2"	25	45 lbs.
11366	72T1-2	72C49-2	Raised 2"	25	70 lbs.

2 DEVICES —4-11/16" SQUARE

11371	72T2-1/2	72C52-1/2	Raised 1/2"	25	36 lbs.
11372	72T2-3/4	72C52-3/4	Raised 3/4"	25	43 lbs.
11373	72T2-1	72C52-1	Raised 1"	25	49 lbs.
11374	72T2-1 1/4	72C52-1 1/4	Raised 1 1/4"	25	55 lbs.
11375	72T2-1 1/2	72C52-1 1/2	Raised 1 1/2"	25	62 lbs.
11376	72T2-2	72C52-2	Raised 2"	20	76 lbs.

Utility Covers



- Galvanized steel, smooth finish.
- 4-³/₃₂" x 2-⁷/₃₂".
- Special utility covers available in stainless steel and painted metal (please use item no. 10011).
- UL Listed.

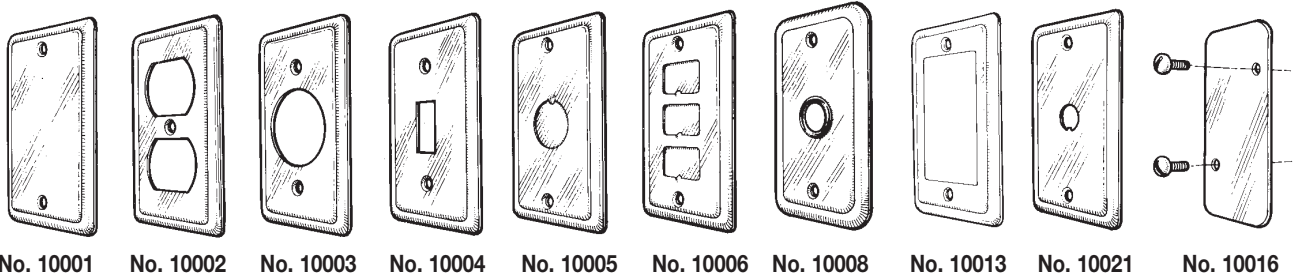

Catalog No.	Old No.	Universal Key No.	Description	Box Quantity	Carton Quantity	Weight Per 100 Units
10001	UB	58C1	Blank	25	250	10 lbs.
10002	UD	58C7	Duplex	25	250	7 lbs.
10003	US	58C5	Single Receptacle	25	250	8 lbs.
10004	UT	58C30	Toggle	25	250	9 lbs.
10005	UK	58C6	½" Knockout	25	250	9 lbs.
10006*†	UAMT	58C40	3 Device Interchangeable with strap	20	200	16 lbs.
10008*	U-01B	58C11	Bushed Telephone 5/8" ID	20	200	11 lbs.
10009	U3R	58C4	1.620" dia. 20A TL Receptacle	25	250	8 lbs.
10010	U3330R	—	1.730" dia. 30A TL Receptacle	25	250	8 lbs.
10013	UGFI	—	GFCI Receptacle (Box mounting 3.281")	25	250	7 lbs.
10021*	AUCD	—	Appliance Switch (.4687" dia.)	25	250	9 lbs.
10016	3/4CFC	—	Rectangular cover for small handy box (3.7813 x 1.5938", fits Appleton 4SS, Raco 640)	25	250	12 lbs.

*Painted with a baked cadilite finish.

†To be discontinued when stock exhausted.

4" Finished Covers

1/2" Raised



COVERS



- Powder coated steel.
- Fully depressed corners for easier, faster mounting.
- Additional screwholes on duplex receptacles to meet NEC requirement.
- Special 4" raised covers available (please use item no. 11441).
- UL Listed.

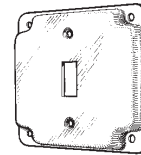

No. 11401

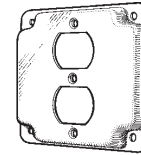

No. 11402

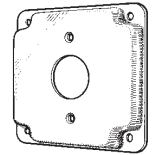

No. 11403

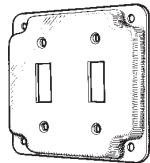

No. 11410

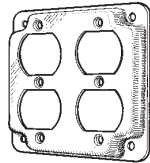

No. 11411

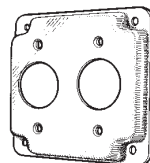

No. 11412

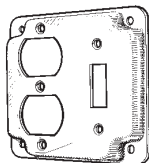

No. 11413

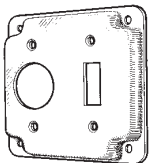

No. 11414

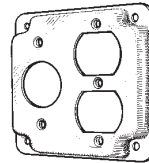

No. 11415

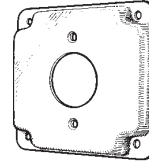

No. 11421

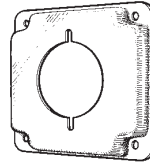

No. 11422

Catalog No.	Old No.	Universal Key No.	Description	Carton Quantity	Weight Per 100 Units
11400	19B	—	Blank	50	38 lbs.
11401	19T	RS9	1 Toggle	50	39 lbs.
11402	19D	RS12	1 Duplex	50	35 lbs.
11403	9S	RS11	1 Single Receptacle	50	36 lbs.
11410	192T	RS5	2 Toggle Switches	50	38 lbs.
11411	192D	RS8	2 Duplex Receptacles	50	31 lbs.
11412	192S	RS10	2 Single Receptacles (2" between device centers)	50	34 lbs.
11413	19TD	RS2	Toggle / Duplex	50	35 lbs.
11414	19TS	RS1	Toggle / Single Receptacle	50	36 lbs.
11415	19DS	RS3	Duplex / Single Receptacle	50	32 lbs.
11421	193R	RS4	1.620" dia. 20A TL Receptacle	50	35 lbs.
11422	193D	RS13	2.125" dia. Range/Dryer Receptacle	50	33 lbs.

4" Finished Covers

1/2" Raised

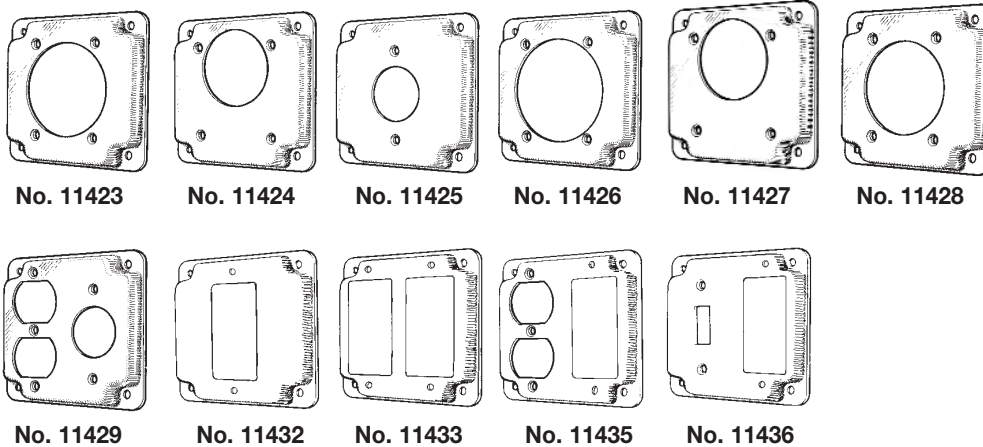

Catalog No.	Old No.	Universal Key No.	Description	Carton Quantity	Weight Per 100 Units
11423	195R	RS14	2.480" dia. Power Outlet	50	30 lbs.
11424	195RR	—	2.165" dia. Power Outlet	50	33 lbs.
11425	193330R	RS15	1.730" dia. TL Receptacle	50	35 lbs.
11426	19L5R	—	1.625" dia. Power Outlet for Leviton #278 & 279	50	29 lbs.
11427	19N5RR	—	2.275" dia. Power Outlet	50	32 lbs.
11428	19P5R	—	2.255" dia. Power Outlet for P&S Nos. 5740, 5744, 5750, 5754, etc.	50	33 lbs.
11429	19D3R	—	1 Duplex / 1 20A TL Receptacle	50	32 lbs.
11432	19GFI	—	1 GFCI Receptacle*	50	33 lbs.
11433	192GFI	—	2 GFCI Receptacles*	50	27 lbs.
11435	19DGFI	—	1 Duplex / 1 GFCI Receptacle*	50	27 lbs.
11436	19TGFI	—	1 Toggle Switch / 1 GFCI Receptacle*	50	35 lbs.

*Strap "ears" must be cut off prior to mounting on plate.

4 11/16" Finished Covers

1/2" Raised



COVERS

- Powder coated steel.
- Additional screwholes meet NEC requirement and mount to ears on any box.
- Special 4-11/16" raised covers available (please use item no. 11541).
- UL Listed.

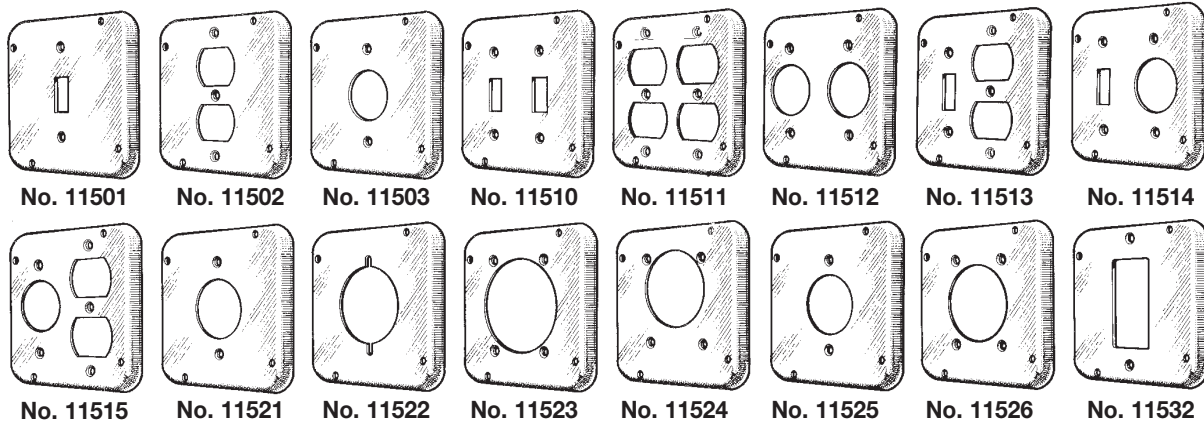

Catalog No.	Old No.	Universal Key No.	Description	Carton Quantity	Weight Per 100 Units
11500	72RBL	—	Blank	25	53 lbs.
11501	72RT	RSL9	Toggle	25	51 lbs.
11502	72RD	RSL12	Duplex	25	48 lbs.
11503	72RS	RSL11	1 Single Receptacle	25	50 lbs.
11510	72R2T	RSL5	2 Toggle Switches	25	52 lbs.
11511	72R2D	RSL8	2 Duplex Receptacles	25	45 lbs.
11512	72R2S	RSL10	2 Single Receptacles (2" between device centers)	25	49 lbs.
11513	72RTD	RSL2	Toggle / Duplex	25	47 lbs.
11514	72RTS	RSL1	Toggle / Single Receptacle	25	52 lbs.
11515	72RDS	RSL3	Duplex / Single Receptacle	25	46 lbs.
11521	72R3R	RSL4	1.620" dia. 20A TL Receptacle	25	49 lbs.
11522	72R3D	RSL13	2.125" dia. Range/ Dryer Receptacle	25	47 lbs.
11523	72R5R	RSL14	2.480" dia. Power Outlet	25	45 lbs.
11524	72R5RR	—	2.165" dia. Power Outlet	25	46 lbs.
11525	72R3330	RSL15	1.730" dia. Power Outlet	25	48 lbs.
11526	72RL5R	—	2.625" dia. Power Outlet	25	43 lbs.
11527	72RN5RR	—	2.275" dia. Power Outlet	25	46 lbs.
11528	72RP5R	—	2.255" dia. Power Outlet	25	48 lbs.
11529	72R23R	—	2 1.620" dia. 20A TL Receptacles (2.25" between device centers)	25	46 lbs.
11532	72RGFI	—	1 GFCI Receptacle	25	47 lbs.
11533	72R2GFI	—	2 GFCI Receptacles	25	40 lbs.
11534	72RD3D	—	1 Duplex / 2.125" dia. Receptacle	25	43 lbs.
11535	72RDGFI	—	1 Duplex / 1 GFCI Receptacle	25	45 lbs.
11536	72RTGFI	—	1 Toggle Switch / 1 GFCI Receptacle	25	47 lbs.
11538	72RD3R	—	Duplex / 1.620" dia. TL Receptacle	25	46 lbs.

FS Type Covers

1-3 Gangs



- Powder coated steel.
- Raised, rounded edge for use with FS fittings with raised lip on top, except Crouse Hinds.
- Special FS covers available in stainless steel or aluminum (please use item nos. 11641-11643 for 1-3 gangs).

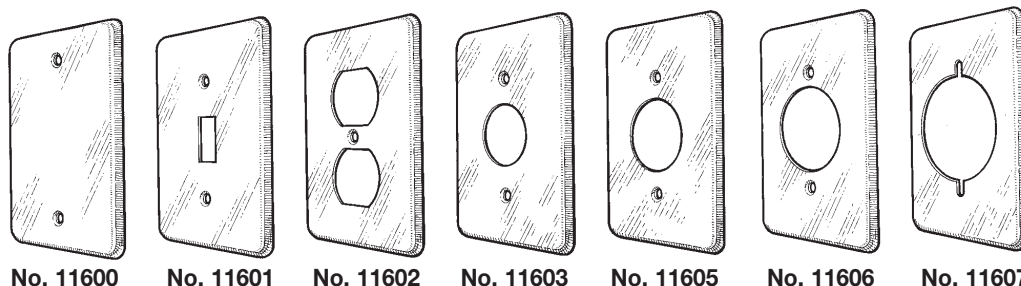

Catalog No.	Old No.	Description	Box Quantity	Carton Quantity	Weight Per 100 Units
1 GANG					
11600	FSB	Blank	20	200	14 lbs.
11601	FST	Toggle	20	200	16 lbs.
11602	FSD	Duplex	20	200	13 lbs.
11603	FSR	Single Receptacle	20	200	13 lbs.
11605	FS3R	1.620" dia. TL Receptacle	20	200	14 lbs.
11606	FS3330R	1.730" dia. TL Receptacle	20	200	12 lbs.
11607	FS3D	2.125" dia. Range/Dryer Rcpt.	20	200	11 lbs.
11608	—	GFCI Receptacle (2 screw)	20	200	12 lbs.
11609	—	GFCI Receptacle (4 screw)	20	200	13 lbs.
2 GANGS					
11611	FS2B	2 Blank	10	100	22 lbs.
11612	FS2T	2 Toggle Switches	10	100	21 lbs.
11613	FS2D	2 Duplex Receptacles	10	100	17 lbs.
11614	FS2R	2 Single Receptacles	10	100	20 lbs.
11615	FSTD	Toggle / Duplex	10	100	23 lbs.
11616	FSTS	Toggle / Single Receptacle	10	100	21 lbs.
11618	FS23D	2.125" dia. Range/Dryer Rcpt.	10	100	19 lbs.
11620	—	2 GFCI Receptacles	10	100	15 lbs.
11621	—	Switch / GFC1 Receptacle	10	100	19 lbs.
3 GANGS					
11622	FS3B	3 Blank	10	100	33 lbs.
11623	FS3T	3 Toggle Switches	10	100	31 lbs.
11624	FS3D	3 Duplex Receptacles	10	100	24 lbs.
11625	FS2TD	2 Toggle / 1 Duplex Receptacle	10	100	34 lbs.
11626	FS2TS	2 Toggle / 1 Single Receptacle	10	100	35 lbs.
11628	FS23R	2 1.620" dia. TL Receptacles	10	100	20 lbs.
11629	FS23330R	1 1.730" dia. TL Receptacles	10	100	19 lbs.
11630	—	3 GFCI Receptacles	10	100	27 lbs.

Flat Gang Box Covers

2-10 Gangs



COVERS

- Galvanized steel.
- Devices spaced 1-13/16" between centers.
- All gang box covers 4-11/16" high.
- Individually packaged.
- Special covers available (please use item nos. 10142-10150 for 2-10 gangs).

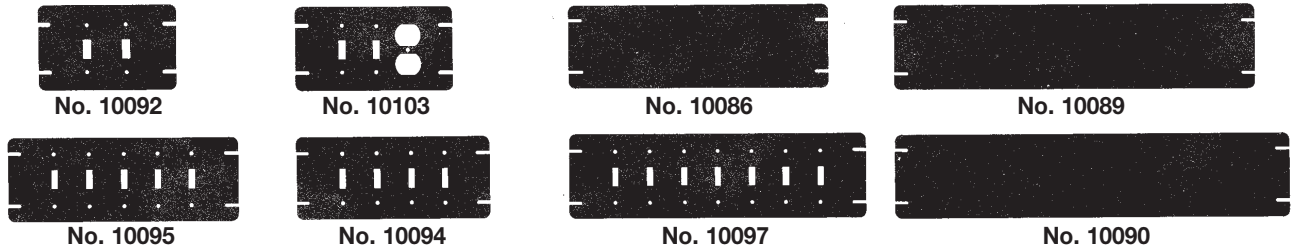

Catalog No.	Old No.	Description	Width	Weight Per 100 Units
BLANKS				
10082	2BGB	2 Gang Blank	7"	58 lbs.
10083	3BGB	3 Gang Blank	8-7/8"	68 lbs.
10084	4BGB	4 Gang Blank	10-5/8"	86 lbs.
10085	5BGB	5 Gang Blank	12-7/16"	107 lbs.
10086	6BGB	6 Gang Blank	14-1/4"	117 lbs.
10087	7BGB	7 Gang Blank	16-1/16"	137 lbs.
10088	8BGB	8 Gang Blank	17-15/16"	150 lbs.
10089	9BGB	9 Gang Blank	19-3/4"	170 lbs.
10090	10BGB	10 Gang Blank	21-9/16"	182 lbs.
SWITCHES				
10092	2TGB	2 Gang Switch	7"	56 lbs.
10093	3TGB	3 Gang Switch	8-7/8"	66 lbs.
10094	4TGB	4 Gang Switch	10-5/8"	87 lbs.
10095	5TGB	5 Gang Switch	12-7/16"	103 lbs.
10096	6TGB	6 Gang Switch	14-1/4"	113 lbs.
10097	7TGB	7 Gang Switch	16-1/16"	132 lbs.
10098	8TGB	8 Gang Switch	17-15/16"	146 lbs.
10099	9TGB	9 Gang Switch	19-3/4"	154 lbs.
10100	10TGB	10 Gang Switch	21-9/16"	173 lbs.
COMBINATIONS AND DUPLEX RECEPTACLES				
10103	2T10DRGB	3 Gang: 2 Switch, 1 Duplex	8-7/8"	62 lbs.
10104	3T10DRGB	4 Gang: 3 Switch, 1 Duplex	10-5/8"	83 lbs.
10105	4T10DRGB	5 Gang: 4 Switch, 1 Duplex	12-7/16"	93 lbs.
10111	1T20DRGB	3 Gang: 1 Switch, 2 Duplex	8-7/8"	59 lbs.
10122	20DRGB	2 Gang Duplex Receptacle	7"	47 lbs.
10123	30DRGB	3 Gang Duplex Receptacle	8-7/8"	54 lbs.
10124	40DRGB	4 Gang Duplex Receptacle	10-5/8"	71 lbs.
10125	50DRGB	5 Gang Duplex Receptacle	12-7/16"	79 lbs.
10126	60DRGB	6 Gang Duplex Receptacle	14-1/4"	88 lbs.
10127	70DRGB	7 Gang Duplex Receptacle	16-1/16"	99 lbs.
10128	80DRGB	8 Gang Duplex Receptacle	17-15/16"	105 lbs.
10129	90DRGB	9 Gang Duplex Receptacle	19-3/4"	120 lbs.
10130	100DRGB	10 Gang Duplex Receptacle	21-9/16"	137 lbs.

Reducing Washers

1/2" x 1/4" - 4" x 3-1/2"

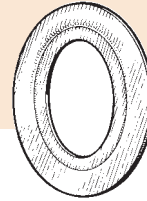

- Galvanized steel.
- Raised flanges to fit snugly into box knockout.
- Minimum order: box quantity.

Catalog No.	Old No.	Box Size	Box Quantity	Carton Quantity	Weight Per 100 Units
40001	R00*	1/2" x 15/32"	250	2500	.9 lbs.
40002	R0**	1/2" x 1/4"	250	2500	.9 lbs.
40003	R1	1/2" x 3/8"	250	2500	.9 lbs.
40005	R2	3/4" x 1/2"	250	2500	1.6 lbs.
40006	R3	1" x 1/2"	250	2500	1.6 lbs.
40007	R4	1" x 3/4"	250	2500	1.4 lbs.
40008	R5	1 1/4" x 1/2"	100	1000	3 lbs.
40009	R6	1 1/4" x 3/4"	100	1000	3 lbs.
40010	R7	1 1/4" x 1"	100	1000	3 lbs.
40011	R8	1 1/2" x 1/2"	100	1000	5 lbs.
40012	R9	1 1/2" x 3/4"	100	1000	5 lbs.
40013	R10	1 1/2" x 1"	100	1000	4 lbs.
40014	R11	1 1/2" x 1 1/4"	100	1000	3 lbs.
40015	R12	2" x 1/2"	50	500	10 lbs.
40016	R13	2" x 3/4"	50	500	9 lbs.
40017	R14	2" x 1"	50	500	8 lbs.
40018	R15	2" x 1 1/4"	50	500	7 lbs.
40019	R16	2" x 1 1/2"	50	500	6 lbs.
40020	R17	2 1/2" x 1/2"	25	250	10 lbs.
40021	R18	2 1/2" x 3/4"	25	250	8 lbs.
40022	R19	2 1/2" x 1"	25	250	9 lbs.
40023	R20	2 1/2" x 1 1/4"	25	250	8 lbs.
40024	R21	2 1/2" x 1 1/2"	25	250	7 lbs.
40025	R22	2 1/2" x 2"	25	250	5 lbs.
40026	R23	3" x 1/2"	25	250	21 lbs.
40027	R24	3" x 3/4"	25	250	20 lbs.
40028	R25	3" x 1"	25	250	20 lbs.
40029	R26	3" x 1 1/4"	25	250	18 lbs.
40030	R27	3" x 1 1/2"	25	250	19 lbs.
40031	R28	3" x 2"	25	250	15 lbs.
40032	R29	3" x 2 1/2"	25	250	13 lbs.
40033	R30	3 1/2" x 1/2"	10	100	35 lbs.
40034	R31	3 1/2" x 3/4"	10	100	35 lbs.
40035	R32	3 1/2" x 1"	10	100	33 lbs.
40036	R33	3 1/2" x 1 1/4"	10	100	32 lbs.
40037	R34	3 1/2" x 1 1/2"	10	100	30 lbs.
40038	R35	3 1/2" x 2"	10	100	28 lbs.
40039	R36	3 1/2" x 2 1/2"	10	100	24 lbs.
40040	R37	3 1/2" x 3"	10	100	18 lbs.
40041	R38	4" x 1/2"	20	100	42 lbs.
40042	R39	4" x 3/4"	20	100	42 lbs.
40043	R40	4" x 1"	20	100	41 lbs.
40044	R41	4" x 1 1/4"	20	100	36 lbs.
40045	R42	4" x 1 1/2"	20	100	37 lbs.
40046	R43	4" x 2"	20	100	34 lbs.
40047	R44	4" x 2 1/2"	20	100	31 lbs.
40048	R45	4" x 3"	20	100	25 lbs.
40049	R46	4" x 3 1/2"	20	100	20 lbs.

*R00 fits McGill canopy switch. **R0 fits standard canopy switch.

REDUCING WASHERS

Conduit Bodies

Threaded and Set Screw Bodies and Kits



- Die-cast aluminum.
- Smooth, corrosion-resistant electrostatic powder coating.
- Available unassembled (body only) or assembled with matching steel cover and gasket.
- All 2½ - 4" conduit bodies and all SLBs come assembled with steel cover and gasket.
- Kits with aluminum covers also available.
- Cubic capacity and listings clearly marked.
- Ask about our "Great Bodies" promotion.
- UL Listed.

Hub Size	Unassembled (body only) Catalog No.		Assembled (with cover and gasket) Catalog No.		Box Quantity	Carton Quantity
	Threaded	Set Screw	Threaded	Set Screw		
LB						
½"	11801	11851	12801	12851	10	50
¾"	11802	11852	12802	12852	10	50
1"	11803	11853	12803	12853	5	25
1¼"	11804	11854	12804	12854	—	2
1½"	11805	11855	12805	12855	—	2
2"	11806	11856	12806	12856	—	1
2½"			12807	12857	—	1
3"			12808	12858	—	1
3½"			12809		—	1
4"			12810		—	1

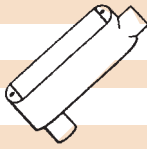

LL						
½"	11811	11861	12811	12861	10	50
¾"	11812	11862	12812	12862	10	50
1"	11813	11863	12813	12863	5	25
1¼"	11814	11864	12814	12864	—	2
1½"	11815	11865	12815	12865	—	2
2"	11816	11866	12816	12866	—	1
2½"			12817		—	1
3"			12818		—	1
3½"			12819		—	1
4"			12820		—	1

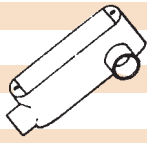

For weights, please see price sheet or call Customer Service.

Conduit Bodies

Threaded and Set Screw Bodies and Kits



Hub Size	Unassembled (body only) Catalog No.		Assembled (with cover and gasket) Catalog No.		Box Quantity	Carton Quantity
	Threaded	Set Screw	Threaded	Set Screw		
LR						
1/2"	11821	11871	12821	12871	10	50
3/4"	11822	11872	12822	12872	10	50
1"	11823	11873	12823	12873	5	25
1 1/4"	11824	11874	12824	12874	—	2
1 1/2"	11825	11875	12825	12875	—	2
2"	11826	11876	12826	12876	—	1
2 1/2"			12827		—	1
3"			12828		—	1
3 1/2"			12829		—	1
4"			12830		—	1
C						
1/2"	11831	11881	12831	12881	10	50
3/4"	11832	11882	12832	12882	10	50
1"	11833	11883	12833	12883	5	25
1 1/4"	11834	11884	12834	12884	—	2
1 1/2"	11835	11885	12835	12885	—	2
2"	11836	11886	12836	12886	—	1
2 1/2"			12837		—	1
3"			12838		—	1
T						
1/2"	11841	11891	12841	12891	10	50
3/4"	11842	11892	12842	12892	10	50
1"	11843	11893	12843	12893	5	25
1 1/4"	11844	11894	12844	12894	—	2
1 1/2"	11845	11895	12845	12895	—	2
2"	11846	11896	12846	12896	—	1
2 1/2"			12847		—	1
3"			12848		—	1

CONDUIT BODIES AND COVERS

Conduit Bodies

SLBs and Moguls

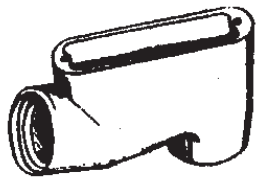





SLB



Catalog No.	Hub Size	Box Quantity	Carton Quantity	Weight per 100 Units
SLBs				
11901	½"	10	50	24 lbs.
11902	¾"	10	50	30 lbs.
11903	1"	5	25	55 lbs.
11904	1¼"	—	1	140 lbs.
11905	1½"	—	1	150 lbs.
11906	2"	—	1	260 lbs.

MOGUL CONDUIT BODIES COMPLETE WITH COVER, GASKET, AND SCREWS

-  • Die-cast aluminum alloy
-  • Suitable for wet locations
-  • Meet NEC 6x requirements
-  • Dome-style cover allows easier wire pulling
-  • UL Listed and CSA Approved

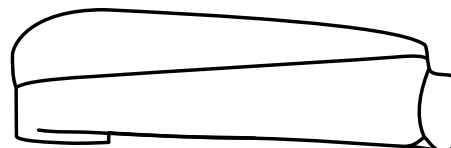

11914	1¼"	5	5	130 lbs.
11915	1½"	2	2	350 lbs.
11916	2"	2	2	310 lbs.

CONDUIT BODIES AND COVERS

Conduit Fitting Covers and Gaskets

Oval-Round F-35 Series, 1/2" - 4"



- Galvanized steel or aluminum.
- Screws and washers mounted.
- Gaskets are neoprene rubber.
- For use with all standard conduit bodies, except Crouse Hinds and 2½"-3" and 3½"-4" Red Dot/L.E. Mason.
- UL Listed.

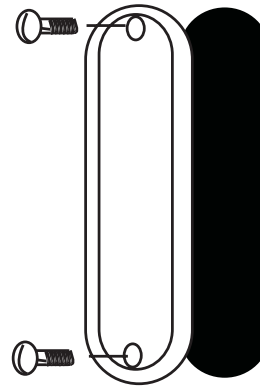

No. 11699 No. 11720

Catalog No.	Old No.	Description	Box Quantity	Carton Quantity	Weight Per 100 Units
GALVANIZED STEEL — 1/2 - 4"					
11699	1/2F35C	Blank, 1/2"	25	250	10 lbs.
11700	3/4F35C	Blank, 3/4"	25	250	13 lbs.
11701	1F35C	Blank, 1"	20	200	15 lbs.
11702	1-1/4F35C	Blank, 1¼"-1½"	—	25	32 lbs.
11703	2F35C	Blank, 2"	—	25	51 lbs.
11704	3F35C	Blank, 2½"-3"	—	25	88 lbs.
11705	4F35C	Blank, 3½"-4"	—	25	142 lbs.
ALUMINUM — 1/2 - 4"					
11710	1/2AF35C	Blank, 1/2"	25	250	4 lbs.
11711	3/4AF35C	Blank, 3/4"	25	250	5 lbs.
11712	1AF35C	Blank, 1"	20	200	7 lbs.
11713	1-1/4AF35C	Blank, 1¼"-1½"	—	25	13 lbs.
11714	2AF35C	Blank, 2"	—	25	25 lbs.
11715	3AF35C	Blank, 2½"-3"	—	25	36 lbs.
11716	4AF35C	Blank, 3½"-4"	—	25	66 lbs.
GASKETS — 1/2 - 4"					
11720	1/2F35G	Full, 1/2"	100	1000	2 lbs.
11721	3/4F35G	Full, 3/4"	100	1000	2 lbs.
11722	1F35G	Full, 1"	50	500	3 lbs.
11723	1-1/4F35G	Full, 1¼"-1½"	—	600	5 lbs.
11724	2F35G	Full, 2"	—	400	7 lbs.
11725	3F35G	Full, 2½"-3"	—	200	14 lbs.
11726	4F35G	Full, 3½"-4"	—	150	20 lbs.

CONDUIT BODIES AND COVERS

Knockout Seals, Switchbox Supports, and Nail Plates

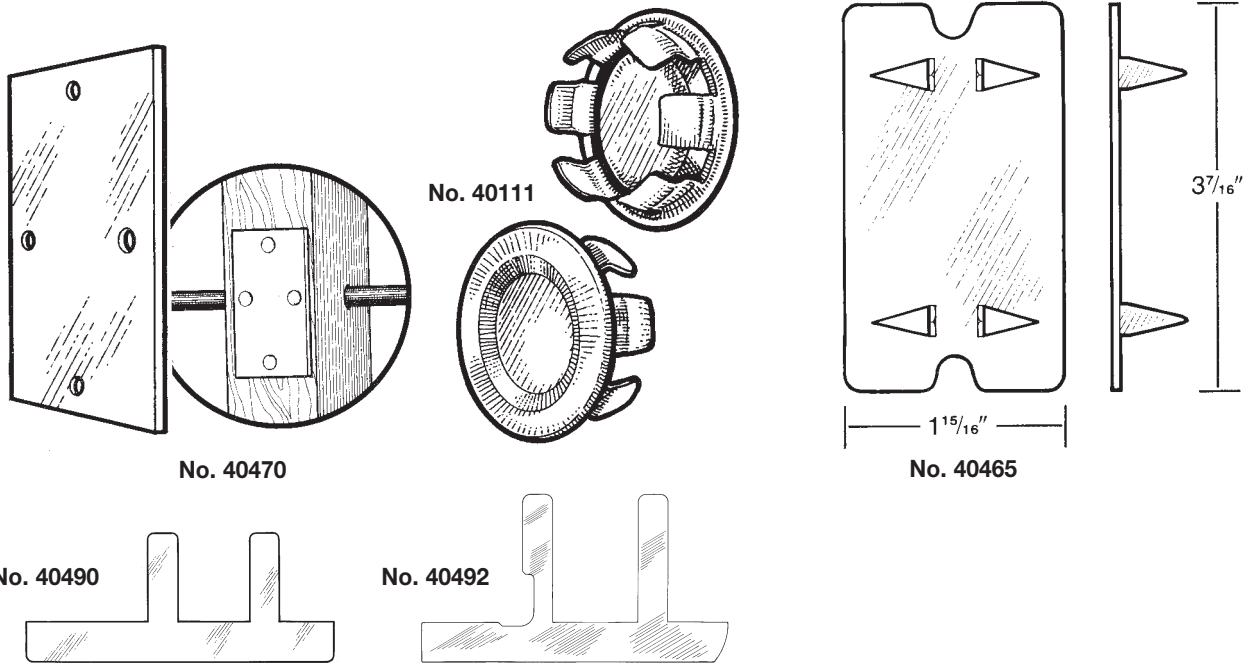

Catalog No.	Old No.	Description	Box Quantity	Carton Quantity	Weight Per 100 Units
CLOSED TYPE KNOCKOUT SEALS; BRIGHT ZINC PLATED STEEL					
40111	CKS1	1/2"	100	1000	1.5 lbs.
40112	CKS2	3/4"	100	1000	1.8 lbs.
40113	CKS3	1"	50	500	2 lbs.
40114	CKS4	1 1/4"	50	500	3 lbs.
40115	CKS5	1 1/2"	50	500	4 lbs.
40116	CKS6	2"	25	250	6 lbs.

SWITCH BOX SUPPORTS

40490	GBS	Standard	50 pairs	500 pairs	3 lbs.
40492	LLGBS	Long Legs	50 pairs	500 pairs	3 lbs.

NAIL PLATES (.062" THICK STEEL)

40465	NPH	1-15/16" x 3 7/16" Self-nailing	—	200	12 lbs.
40470	NPH	1 1/2" x 3" 4 nail holes	—	200	8 lbs.



Mulberry Metal Products, Inc.
2199 Stanley Terrace
P.O. Box 443
Union, New Jersey 07083

tel. 908.688.8850
fax. 908.688.7294
www.mulberrymetal.com