

ELECTRICAL & TELEPHONE BOXES

- Etched polypropylene face
- Face anchored in concrete
- Ultra-violet inhibitor
- Exceeds ASTM-D1693 Standards for Environmental Stress Cracking Resistance
- Meets Caltrans #3 1/2 State Specifications

R-Series Concrete Lid No. N09R 20 lbs.

Cast-In Bolt
Down Bracket

HNT-E02 For
Bolt Down
Application

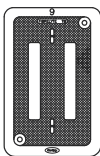

FL09T

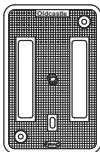

N09J

Electrical Box No. N09 BOX 90 lbs.

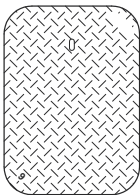
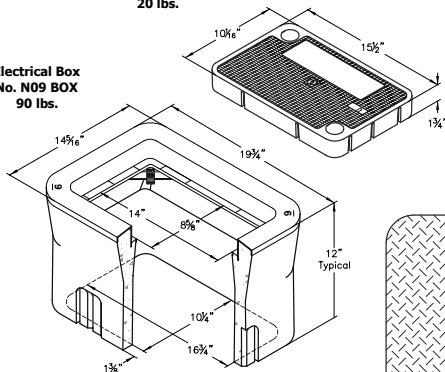

B09-61D

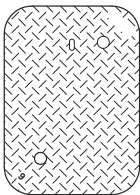

N09-61J

A high density reinforced concrete box with non-setting shoulders positioned to maintain grade and facilitate back filling. Approximate dimensions and weight shown.

Oldcastle Ordering Code	Item	Approx. Shipping Weight	Description
N09BOX	BOX	90 lbs.	N09 Electrical Box (10 1/4" x 16 3/4") - Meets #3-1/2 State Specifications - 28 per pallet
N09R	LID	20 lbs.	Reinforced Concrete Lid with Plastic Ring - (Order N90 Bolt Down Kit Separately)
FL09T	LID	5 lbs.	Fibrelyte Lid, Non-Concrete, Bolt Down (Order N90 Bolt Down Kit Separately)
N09J	LID	22 lbs.	Cast Iron Lid Bolt Down, (Order N90 Bolt Down Kit Separately)
B09-61D	COVER	22 lbs.	Steel Checker Plate Cover
N09-61J	COVER	22 lbs.	Steel Checker Plate Cover, Bolt Down (Order N90 Bolt Down Kit Separately)
B09X12	EXTENSION	87 lbs.	12" Reinforced Concrete Box Extension - 28 per pallet
B09SL	SLAB	32 lbs.	Reinforced Concrete Slab (13 1/4" x 19 3/4")

Galvanizing available on all steel covers.



Oldcastle® Enclosure Solutions

Phone: (800) 735-5566 Fax: (800) 486 6806

Copyright© 2017 Oldcastle, Inc.

N09 BOX

FILE NAME: N09_ISO

ISSUE DATE: January, 2011

OldcastleEnclosures.com

N09 ELECTRICAL BOX

10-1/4" x 16-3/4"

CHRISTY

ELECTRICAL & TELEPHONE BOXES

- Etched polypropylene face
- Face anchored in concrete
- Ultra-violet inhibitor
- Exceeds ASTM-D1693 Standards for Environmental Stress Cracking Resistance
- Meets Caltrans #3 1/2 State Specifications

R-Series Concrete Lid No. N09R 20 lbs.

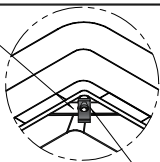
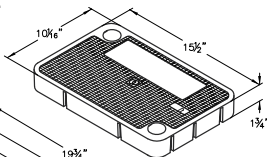

HNT-E02 For Bolt Down Application

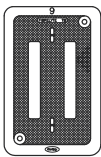

FL09T

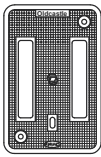

N09J

Electrical Box No. N09 BOX 90 lbs.

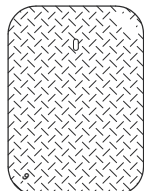
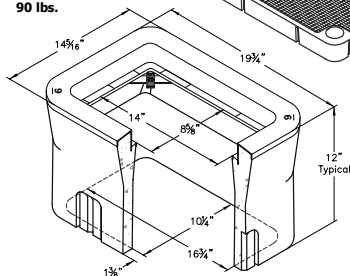

B09-61D

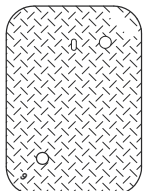

N09-61J

A high density reinforced concrete box with non-setting shoulders positioned to maintain grade and facilitate back filling. Approximate dimensions and weight shown.

Oldcastle Ordering Code	Item	Approx. Shipping Weight	Description
N09BOX	BOX	90 lbs.	N09 Electrical Box (10 1/8" x 16 3/4") - Meets #3-1/2 State Specifications - 28 per pallet
N09R	LID	20 lbs.	Reinforced Concrete Lid with Plastic Ring - (Order N90 Bolt Down Kit Separately)
FL09T	LID	5 lbs.	Fibrelyte Lid, Non-Concrete, Bolt Down (Order N90 Bolt Down Kit Separately)
N09J	LID	22 lbs.	Cast Iron Lid Bolt Down, (Order N90 Bolt Down Kit Separately)
B09-61D	COVER	22 lbs.	Steel Checker Plate Cover
N09-61J	COVER	22 lbs.	Steel Checker Plate Cover, Bolt Down (Order N90 Bolt Down Kit Separately)
B09X12	EXTENSION	87 lbs.	12" Reinforced Concrete Box Extension - 28 per pallet
B09SL	SLAB	32 lbs.	Reinforced Concrete Slab (13 1/4" x 19 1/4")

Galvanizing available on all steel covers.

Oldcastle Enclosure Solutions

Phone: (800) 735-5566 Fax: (800) 486 6806
Copyright © 2017 Oldcastle, Inc.

N09 BOX

FILE NAME: N09_ISO
ISSUE DATE: January, 2011
OldcastleEnclosures.com

N09 ELECTRICAL BOX 10-1/8" x 16-3/4"

CHRISTY