



Kellems has wide experience with grips for use with fiber optic cable. As the industry leader in producing wire mesh grips for the stringent requirements of fiber optic applications, Kellems has developed several series of grips for use with fiber optic communications cable.

These grips include pulling grips with built in swivels, grips with steel ends to protect fragile cable ends, grips with low profiles to pull cables in tight places and the OPTISOK® an effective tool to place preterminated cables. Also available are grips to support fiber optic cable.

### Safety And Working Load Factors For Wire Mesh Grips

The broad application of Kellems grips on a wide variety of objects requires that adequate safety factors be used to establish working loads. The approximate breaking strength of a Kellems grip represents an average calculation based on data established from actual direct tension testing done in our engineering laboratories.

It is impossible to catalog or guarantee a safety factor suitable for all applications as operating conditions are never the same. The tension, diameter, movement, number of objects gripped, gripping surface, and the attachments used are just some of the factors which vary with each application. These factors, together with the effects of abrasion, corrosion, prior use or abuse and any other variables of a specific application, must be considered by the user and the grip replaced as appropriate. Where the conditions of

### Select the Correct Fiber Optic Grip

Each Kellems grip is designed to work on a specific range of cable diameters.

- Step 1** Determine your cable outside diameter.
- Step 2** Find the grip size that encompasses your cable diameter.
- Step 3** Whenever possible, use a closed mesh that assembles over the cable end. If the cable end is not available, use a split mesh.
- Step 4** Where available, select an eye style that suits your needs.
- Step 5** Estimate the tension to be put on the grip, establish the working load you require and compare this to the listed approximate breaking strength of the grip to insure that the grip will be strong enough.

the application are not well defined or known or where risk of injury to persons or property is involved, a greater safety factor should be utilized.

**Under normal conditions, Kellems' recommended factor of safety is five for catalog listed pulling grips, and ten for catalog listed support grips.**

Any warranty as to quality, performance or fitness for use of grips is always premised on the condition that the published breaking strengths apply only to new, unused grips, and that such products are properly stored, handled, used, maintained and inspected by the user at a frequency appropriate for the use and condition of the grip.

For grip applications on materials other than those that the grips have been specifically designed for, consult the factory.

### Examples

Grip Style	Approx. Breaking Strength Lbs. (N)	Safety Factor	Max. Recommended Load Lbs. (N)	Catalog Number
Pulling Grips	2,500 (11,120)	5	500 (2,224)	<b>033291196</b>
Support Grips	400 (1,779)	10	40 (178)	<b>022291004</b>

The maximum recommended working load is the tension to be exerted on the grip in application with a margin of safety to take care of unforeseen and unusual circumstances.

It is the end-user's decision to determine how much of a safety factor is acceptable to for the application.

### Fiber Optic Grip Materials

Material	Features	Product Group
Galvanized steel wire	<ul style="list-style-type: none"> <li>• High strength</li> <li>• Not subject to continuous outside environment</li> </ul>	<ul style="list-style-type: none"> <li>• Pulling grips</li> </ul>
Tin-coated bronze wire	<ul style="list-style-type: none"> <li>• Corrosion resistant for normal outside areas</li> <li>• Non-magnetic</li> <li>• Moderate strength</li> </ul>	<ul style="list-style-type: none"> <li>• Support grips</li> </ul>
Non-metallic braid	<ul style="list-style-type: none"> <li>• Superior flex life</li> <li>• Non-conductive</li> <li>• Corrosion resistant</li> <li>• Moderate strength</li> </ul>	<ul style="list-style-type: none"> <li>• OPTISOK®</li> </ul>

### Approvals

CSA Certification is indicated on appropriate product catalog pages.



Kellems offers a unique and simple to use tool for the installation of preconnectorized fiber optic cables, jumpers and bundles of twisted pair communication cables - the OPTISOK®.

The OPTISOK® is a highly flexible and expandable nonmetallic sleeve open on one end and with a pulling ring on the other. It will expand to enclose the larger group of fiber optic connectors and grab the cable below the connector bundle by wrapping and taping to provide a gripping tool that will grab the cable(s) below the connectors. The pulling ring can be attached to a pulling line or fish tape and the OPTISOK® will act as the pulling tool.

OPTISOK® will contain and protect the connector bundle and save time and labor by making the pulling job easier, protecting the connectors from possible damage during the pull and facilitating the passage of the connector bundle through cramped and tight spaces. The OPTISOK® can be used to pull cables through plenums, underfloor duct, office partitions, raised access floors and conduits. Three sizes are available for all applications.

### How to Select OPTISOK®

- Identify connector bundle diameter to be inserted into the OPTISOK®.
- Choose appropriate catalog number based on size range.

### Installation Information

**Step 1** Expand open end of OPTISOK® and gently work in fiber optic connector bundle.

**Step 2** Still gently, work connector bundle up to the forward section of the OPTISOK®.

**Step 3** Starting at approximately 6" (15.2cm) from tail end of OPTISOK®, tightly fold over the OPTISOK® around cables and tape wrapped section 3" (7.62cm) past tail end onto the bundle.

**Step 4** Securely attach pulling line or tape to pulling ring.

*Note: To remove OPTISOK® carefully unwrap tape and slide out cables and connectors or cut OPTISOK® away without damaging connectors or cables.*

#### Step 1

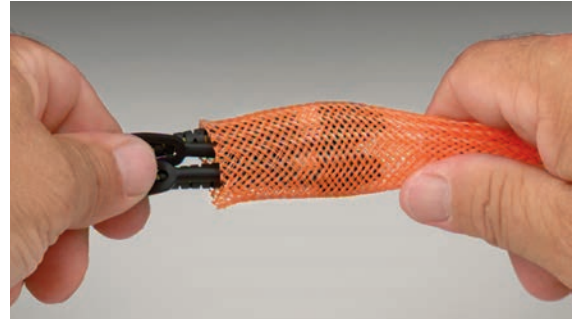

#### Step 2



#### Step 3



#### Step 4





## **Pulling Grip for Loose Tube Fiber Optic Cable**

---

Kellems offers a wire mesh specifically designed to pull loose tube fiber optic cable and meet the special pulling requirements recommended by fiber optic cable manufacturers.

Many fiber optic cable manufacturers require special cable preparation prior to pulling where a short section of the outer jacket is stripped off exposing the aramid strength member. This creates two cable diameters, one including the jacket and a second smaller diameter at the strength member. Kellems fiber grip with its special weave will accommodate and securely grab both diameters, at the outside jacket and the internal aramid strength member.

Additionally, this galvanized steel mesh grip has longer leads at the pulling eye to facilitate pulling the cable up through the top, a very low profile lug and eye to slip through tight areas, and short shoulders to protect the cable while maintaining the slim profile.

The grip can be used to pull cable overhead as well as underground through conduit and duct. It easily mates with a swivel and has the necessary strength to securely make pulls.

## **Application Information**

---

- Prior to pulling cable, follow cable manufacturers' cable preparation recommendations.
- Never exceed cable manufacturers' pulling tension recommendations.
- Never use grips to approximate breaking strength safety factor of 5 recommended.

## **Pulling Grips for Other Outside Plant Cables, Swivel Eye, Flexible Eye, Split Style, Low Profile**

---

Kellems Pulling Grips for fiber optic cable are made of high strength galvanized steel strand. They feature a multiweave mesh, with one-half the mesh length double weave, and the second half single weave. This special weave provides positive holding power while allowing the grip to remain flexible with no damage to the cable jacket. Added features include a steel nose cone which protects the cable end and allows the grip to pass easily through conduit and enclosures. The eye connects easily to a swivel or a pulling line. Several grip sizes are available to accommodate all diameters of fiber optic cable.

## **Application**

---

Kellems Flexible Eye Pulling Grips for fiber optic cable are used for the installation of fiber optic communication lines either underground, overhead, through conduit or through enclosures. They will fit single cables or cable bundles, are easily installed on the cable, and are reusable.

## **Benefits**

---

- High strength multiweave mesh for positive holding power.
- Highly flexible mesh to follow the pulling path of the cable.
- Steel nose cone reduces snags and hang-ups and protects cable end.
- Easily installed and removed.
- A dependable, reusable pulling tool.



## Support Grips for Fiber Optic Cable

---

Kellems Support Grips for fiber optic cable are specially designed to hold the cable weight as it hangs in a vertical or horizontal position. Fiber optic cable must be supported and Kellems Grips provide the support easily and economically.

These grips are made of high grade, non-magnetic tin-coated bronze strand. They are offered in universal bale or single eye configurations and are available in either closed mesh (for use where the cable end is available) or in split mesh, rod closing (for installation on existing cable runs or at specific locations).

## Split Support Grip Rod Closing Instructions

---

The stainless steel rod is a precise built-in feature which makes threading easy and fast. The strands of the mesh pass around the rod and match up with the strands from the opposite direction. The rod does not touch the cable at any point and therefore cannot cut the cable. Rod Closing Grips are reusable. They may be removed and reused as many times as desired.

## Fast to Install

---

**Step 1** Wrap the grip around the cable and thread the rod through the preformed loops with a corkscrew motion, using the curved end of the rod to engage the loops.

---

**Step 2** The action required is a steady push and twist simultaneously. The fingers of the left hand are used to bring the loops together just ahead of the hook on the end of the rod.

---

**Step 3** To remove, simply pull the rod out.

---





### Types of Attachment

The five attachment methods shown below provide unlimited flexibility of attachment to meet any condition.

**IMPORTANT**  
Read all breaking strength, safety and technical data relating to this product. Pages V-41 to V-42.

#### Type E

Double Eye Grip, used where fastening is made with eyebolts or similar anchor terminations.



#### Type A

Single Eye Grip, used where fastening MUST be made from one point.



#### Type U

Universal Bale Grip, used to fasten around a structure or closed eye.



#### Type Y

Threaded bolt ( $\frac{5}{16}$ -18 x 1½" long), used to fasten through drilled holes in plate.



#### Type F

Split fitting to fit AN-818 nuts. Fitting is positioned over nut and located with internal flange. A hose clamp is furnished and required to hold the fitting in correct position.

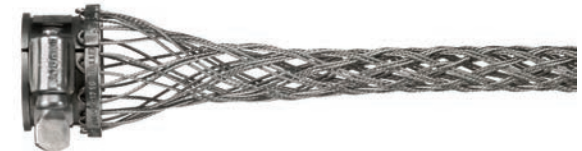

*Note: It should be emphasized that Kellems® Hose Containment Grips are not to be used as a pressure reinforcing device for hose systems. These grips are custom made. Consult Technical Services for details.*

Kellems Hose Containment Grips are used on high pressure, flexible hose lines to prevent the hose from whipping violently in the event of hose failure at the fitting. These grips will prevent serious injury to personnel and damage to equipment by holding the hose in place in the event of hose failure.

Kellems patented Hose Containment Grips are made of stainless steel with double weave mesh construction for high strength and come complete with hose clamps.

Kellems Hose Containment Grips are supplied in diameters, length and attachments to meet individual requirements. Contact the Wiring Device-Kellems factory for specific information. These grips help meet OSHA Federal Register 1926-302 (b), 1926-603 (9), (10), JIC H-1-1973 (H13.11) and JIC P-1-1975 (P11.34) requirements.



Kellems Strain Relief Grips are designed to prevent tension from being transmitted to joints and terminals on electrical cord, cable and conduit. In most applications, a Kellems grip for strain relief is stronger than the cable itself and gives much greater security than the use of a fitting alone. Kellems Grips for strain relief help make electrical systems safer, and save money by minimizing downtime from costly electrical failure due to cable pull-out. Kellems Grips also aid in compliance with the National Electric Code's terminal tension protection requirements.

**Select the Correct Grip for Strain Relief**

Kellems Grips for strain relief are designed to fit on electrical cord, cable or flexible conduit.

**Step 1** Refer to the chart below to determine the grip style best suited for your application.







**Step 2** Determine your cable outside diameter or conduit size.

**Step 3** Locate environment—indoors or outdoors.

**Step 4** Decide if a liquidtight seal is required.

**Step 5** Select NPT size and fitting style.

**Strain Relief System Selection Chart**

Grip Type	Application	Features	Cord or Conduit Range Inches (cm)	Type Fitting or Attachment	Page Number
<b>Deluxe Cord Aluminum Fitting/ Stainless Steel Grip</b> 	Outdoors or indoors where subjected to moisture or splash. Examples are crane and hoist pendant drop stations, hand tools, pumps and processing equipment.	Aluminum fittings, stainless steel mesh, neoprene oil-and-watertight bushing. Double-single weave.	.187"-3.250" (.47-8.25)	NPT, PG, and metric aluminum, male straight, 45° male, 90° male, female straight. Thread sizes 3/8"-3".	V-58, V-59, V-62
<b>Deluxe Cord Nylon Fitting/ Stainless Steel Grip</b> 	Outdoors or indoors where subjected to moisture or splash. Examples are marine and food processing equipment.	Nylon fitting, stainless steel mesh, double-single weave, neoprene oil-and-watertight bushing.	.187"-1.125" (.47-2.86)	NPT nylon, male straight, 90° male. Thread sizes 1/2"-1".	V-60
<b>Deluxe Cord Nylon Fitting/ Non-metallic Grip</b> 	Indoor or outdoors. Provides liquidtight seal, where exposed to moisture. Excellent for oil refining and chemical processing.	Non-metallic grip is corrosion resistant, nonconductive and provides superior gripping and flexing benefits. Neoprene liquidtight bushing. Nylon fitting.	.187"-1.000" (.47-2.54)	NPT nylon, straight male, thread sizes 3/8"-1" 90° male, thread sizes 1/2"-1".	V-61
<b>Deluxe Cord Stainless Steel Fitting And Grip</b> 	Indoor or outdoor use where exposed to moisture. Very strong for heavy abuse areas such as drilling platforms, steel mills and mines.	Stainless steel fitting and grip for strength. Neoprene liquidtight bushing. Double/single weave grip.	.187"-1.000" (.47-2.54)	Straight male Only with NPT Thread sizes 1/2"-1".	V-61
<b>Dust-Tight Strain Relief</b> 	Indoor use only for wiring of electrical enclosures, machine tools, portable power tools, bus drop cable systems.	Neoprene gasket—seals out chips, dirt, dust. One piece design with galvanized steel mesh. Insulating bushing available. Zinc-plated steel locknut.	.240"-2.450" (.61-6.22)	Straight male NPS or NPT	V-63
<b>Liquidtight Flexible Conduit Grip (Metal and Non-Metallic)</b> 	Wiring of machine tools, electrical enclosures, motors and systems where metallic liquidtight flexible conduit is subjected to vibration, flexure, motion or strain.	Stainless steel mesh, liquidtight fittings. Sealing "O" rings (optional). Choice of fittings.	.375"-4.000" trade sizes	NPT 1/2"-4", Hubbell fittings, Male straight, 45° male, 90° male, female straight.	V-66, V-67
<b>Liquidtight Flexible Conduit Grip (UL Type A)</b> 	Wiring or machine tools, electrical enclosures, motors and systems where conduit is subject to vibration and strain.	Stainless steel mesh, liquidtight fittings with "O" ring and locknut.	.375"-2.008" trade size male	NPT steel, Hubbell fittings, straight male, 90° Thread sizes 1/2"-2".	V-68

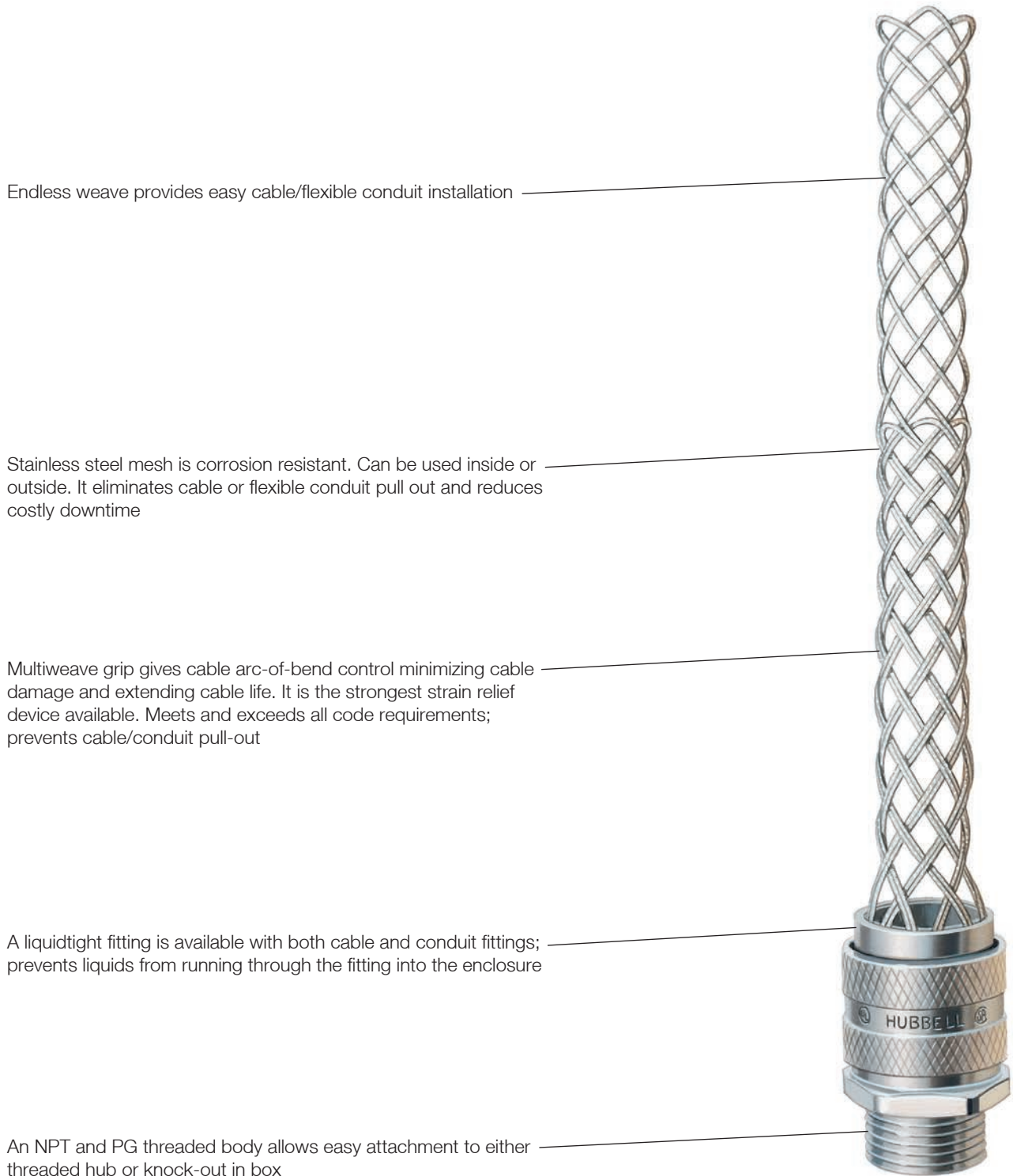

Endless weave provides easy cable/flexible conduit installation

Stainless steel mesh is corrosion resistant. Can be used inside or outside. It eliminates cable or flexible conduit pull out and reduces costly downtime

Multiweave grip gives cable arc-of-bend control minimizing cable damage and extending cable life. It is the strongest strain relief device available. Meets and exceeds all code requirements; prevents cable/conduit pull-out

A liquidtight fitting is available with both cable and conduit fittings; prevents liquids from running through the fitting into the enclosure

An NPT and PG threaded body allows easy attachment to either threaded hub or knock-out in box

**IMPORTANT**

Read all breaking strength, safety and technical data relating to this product. Pages V-69 to V-76.

**Non-Insulated, Wide Range Strain Relief**

Thread Size	Cable Diameter Range Inches (cm)	Mesh Length @ Nom. Dia. Inches (cm)	Catalog Number
½ NPT	.24"-.32" (.61-.81)	3.25" (8.25)	<b>073031200</b>
½ NPT	.32"-.43" (.81-1.09)	3.75" (9.52)	<b>073031201</b>
½ NPT	.43"-.54" (1.09-1.37)	4.75" (12.06)	<b>073031202</b>
¾ NPT	.54"-.73" (1.37-1.85)	6.5" (16.51)	<b>073031203</b>
1 NPT	.73"-.97" (1.85-2.46)	7" (17.78)	<b>073031204</b>
1¼ NPT	.97"-1.25" (2.46-3.17)	9" (22.86)	<b>073031205</b>
PG29*	.73"-.97" (1.85-2.46)	7" (17.78)	<b>073PG291204</b>

Note: \*Panzergewinde.



**Insulated, Wide Range Strain Relief with Insulating Bushing**

Thread Size	Cable Diameter Range Inches (cm)	Mesh Length @ Nom. Dia. Inches (cm)	Dim. A Inches (cm)	Min. Space Between Grips Inches (cm)	Catalog Number
½ NPS	.24"-.32" (.61-.81)	3.25" (8.25)	1" (2.54)	1.25" (3.17)	<b>073031206</b>
½ NPS	.32"-.43" (.81-1.09)	3.75" (9.52)	1" (2.54)	1.25" (3.17)	<b>073031207</b>
½ NPS	.43"-.54" (1.09-1.37)	4.75" (12.06)	1" (2.54)	1.25" (3.17)	<b>073031208</b>
¾ NPS	.54"-.73" (1.37-1.85)	6.5" (16.51)	1" (2.54)	1.5" (3.81)	<b>073031209</b>
1 NPS	.73"-.97" (1.85-2.46)	7" (17.78)	1.313" (3.02)	1.75" (4.44)	<b>073031210</b>
1¼ NPS	.97"-1.25" (2.46-3.17)	9" (22.86)	1.313" (3.02)	2.25" (5.71)	<b>073031211</b>
1½ NPT	1.25"-1.50" (3.17-3.81)	11.75" (29.84)	1.313" (3.02)	2.5" (6.35)	<b>073031212</b>
2 NPT	1.50"-1.70" (3.81-4.32)	13.25" (33.65)	1.375" (3.49)	3.25" (8.25)	<b>073031213</b>
2½ NPT	1.70"-2.00" (4.32-5.08)	13.5" (34.29)	1.5" (3.81)	3.625" (9.21)	<b>073031214</b>
2½ NPT	2.00"-2.45" (5.08-6.22)	13.75" (34.92)	1.5" (3.81)	3.625" (9.21)	<b>073031215</b>







### Thread Adapters for Multi-Pin Connectors

Kellems® Thread Adapters are devices formatting AN-MS connectors and other multi-pin connectors to Kellems grips with NPT threaded fittings. They are made of aluminum with internal threads and replace the connector cord clamp. These adapters permit the installation of Kellems Grips, to prevent cable or conduit pull-out and control arc-of-bend.

### Applications

Thread adapters allow the installation of Kellems® Grips on multi-pin connectors at electrical consoles, mobile equipment, control switches, assembly equipment and testing machines.

### Benefits

- Easy installation.
- Allows the use of Kellems grips.
- Extends connector and cable life.

### Thread Adapters for Multi-Pin Connectors

Thread Adapters					Deluxe Cord Grips		Strain Relief Grips		Liquidtight Conduit Grips (Insulated Throat)
AN-MS Connector Size**	AN-MS Cable Clamp Number***	Thread Size A Inch	NPT Thread Size B	Catalog Number	Cable Diameter Range Inches (cm)	Catalog Number	Cable Diameter Range Inches (cm)	Catalog Number	Catalog Number
8S, 10S	3057-3	½" x 28"	⅜	<b>091041000</b>	.250"-.312" (.63-.79)	07401001	—	—	—
10SL, 12, 12S	3057-4	⅝" x 24"		<b>091041001</b>	.312"-.375" (.79-.95)	07401002			
14, 14S	3057-6	¾" x 20"		<b>091041002</b>	.375"-.437" (.95-1.11)	07401003			
14, 14S	3057-6	¾" x 20"	½	<b>091041003</b>	.187"-.250" (.47-.63)	07401004	.24"-.32" (.61-.81)	073031200	—
16, 16S	3057-8	⅞" x 20"		<b>091041004</b>	.250"-.375" (.63-.95)	07401006	.32"-.43" (.81-1.09)	073031201	074093512
18	3057-10	1" x 20"		<b>091041006</b>	.375"-.500" (.95-1.27)	07401008	.43"-.54" (1.09-1.37)	073031202	—
16, 16S	3057-8	⅞" x 20"	¾	<b>091041005</b>	.187"-.250" (.47-.63)	07401011	.54"-.74" (1.37-1.85)	073031203	074093513
18	3057-10	1" x 20"		<b>091041007</b>	.250"-.375" (.63-.95)	07401013			
20, 22	3057-12	1¼" x 18"		<b>091041008</b>	.375"-.500" (.95-1.27)	07401015			
					.500"-.625" (1.27-1.59)	07401017			
				.625"-.750" (1.59-1.90)	07401018				
20, 22	3057-12	1¼" x 18"	1	<b>091041009</b>	.375"-.500" (.95-1.27)	074011195	.73"-.97" (1.85-2.46)	073031204	074093514
24, 28	3057-16	1⅞" x 18"		<b>091041010</b>	.500"-.625" (1.27-1.59)	07401019			
32	3057-20	1¾" x 18"		<b>091041012</b>	.625"-.750" (1.59-1.90)	07401021			
36	3057-24	2" x 18"		<b>091041015</b>	.750"-.875" (1.90-2.22)	07401023			
					.875"-1.000" (2.22-2.54)	07401025			
24, 28	3057-16	1⅞" x 18"	1¼	<b>091041011</b>	.750"-.875" (1.90-2.22)	074011251	.97"-1.25" (2.46-3.17)	073031205	074093515
32	3057-20	1¾" x 18"		<b>091041013</b>	.875"-1.000" (2.22-2.54)	07401026			
36	3057-24	2" x 18"		<b>091041016</b>	1.000"-1.125" (2.54-2.86)	07401027			
					1.125"-1.375" (2.86-3.17)	07401028			
32	3057-20	1¾" x 18"	1½	<b>091041014</b>	.875"-1.000" (2.22-2.54)	07401029	—	—	074093516
36	3057-24	2" x 18"		<b>091041017</b>	1.000"-1.125" (2.54-2.86)	07401030			
40	3057-28	2¼" x 16"		<b>091041019</b>	1.125"-1.250" (2.86-3.17)	07401031			
				1.250"-1.375" (3.17-3.49)	07401032				

Note: \*Cable jacket may have to be stripped to pass through connector body.

\*\*Number stamped on connector shell.

\*\*\*Number stamped on clamp shell.

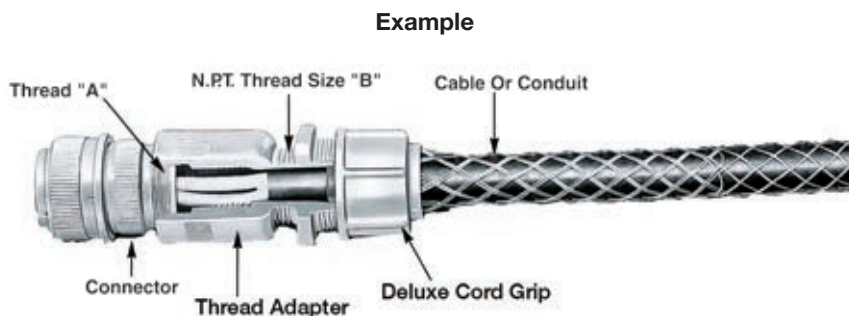

091041006



## Wire Mesh Grip Materials

Material	Features	Product Group
Galvanized steel wire	<ul style="list-style-type: none"> <li>• High strength</li> <li>• Not subject to continuous outside environment</li> </ul>	<ul style="list-style-type: none"> <li>• Strain relief grips</li> <li>• I-Grips</li> </ul>
Stainless steel wire (302/304)	<ul style="list-style-type: none"> <li>• High strength</li> <li>• Corrosion resistant</li> <li>• Slightly magnetic</li> </ul>	<ul style="list-style-type: none"> <li>• Deluxe cord grips</li> <li>• Liquidtight, flexible, metal conduit grips</li> <li>• UL type A conduit grips</li> </ul>
Non-metallic strand	<ul style="list-style-type: none"> <li>• Superior flex life</li> <li>• Non-conductive</li> <li>• Corrosion resistant</li> <li>• Moderate strength</li> </ul>	<ul style="list-style-type: none"> <li>• Non-metallic deluxe cord grips</li> </ul>

## Operating Temperatures

Material	Temperature Range
Aluminum	-40°F to +300°F (-40°C to +149°C).
Aluminum Deluxe Cord Grips	-30°F to +240°F (-34°C to +115°C).
Non-Metallic Deluxe Cord Grips	-30°F to +225°F (-34°C to +107°C).
Nylon	-40°F to +225°F (-40°C to +107°C).
Nylon Fitting with Stainless Steel Mesh	-40°F to +225°F (-40°C to +107°C).
Stainless Steel	-60°F to +1000°F (-51°C to +537°C).
Stainless Steel Deluxe Cord Grips	-30°F to +240°F (-34°C to +115°C).
Neoprene (Bushings)	-30°F to +240°F (-34°C to +115°C).

## Hazardous Locations

	Product Categories
The product categories listed to the right are suitable for use in hazardous locations per Class I Div. 2, Class II Div. 1 & 2, Class III Div. 1 & 2.	Deluxe cord grip, aluminum fitting; Deluxe cord grip, nylon fitting; Deluxe cord grip, non-metallic; Sealtite conduit grips; Dusttight strain relief grips.

## Flammability

Non-metallic deluxe cord grips will not support combustion. Listed below are the ratings.

Component	Rating
Mesh grip	UL 94HB.
Fitting	UL 94V-2.

## Approvals

UL Listing and CSA Certification are indicated on appropriate product catalog pages.

Agency	UL Control Number
Underwriters Laboratories Inc.	898D and 899D.
	UL Listed in accordance with Standard 514B for indoor/outdoor use.

## Wet Locations

	Product Categories
The products noted to the right are suitable for use in wet locations when a listed sealing ring is used between box and fitting.	Deluxe cord grip, aluminum fitting; Deluxe sealing ring cord grip; Deluxe cord grip, non-metallic; Sealtite conduit grips; Hubbell non-metallic conduit grips; Cord connectors; Hubbell Juniors; PolyTuff® connectors; Hubbell sealtite conduit connectors.



## Form Size Definition

The term "Form Size" refers to the physical mass or overall dimensions of a cord connector. Form 1 is the smallest size, Form 8 is the largest size.

## Knockout Holes

NPT Hub Size Inches	Knockout Hole Recommended Min. to Max. Inches (cm)	
¼	.540"	.570" (1.37-1.45)
⅜	.671"	.701" (1.70-1.78)
½	.859"	.906" (2.18-2.30)
¾	1.094"	1.141" (2.78-2.90)
1	1.359"	1.406" (3.45-3.57)
1¼	1.719"	1.766" (4.37-4.49)
1½	1.969"	2.016" (5.00-5.12)
2	2.453"	2.500" (6.23-6.35)
2½	2.953"	3.000" (7.50-7.62)
3	3.578"	3.625" (9.09-9.21)

## Product Data

### Deluxe Cord Grips, Liquidtight for Insulated Cables

Deluxe Cord Grips helps to alleviate pull tension on terminals, control cable arc-of-bend, prevent cord pull-out, and provide a liquidtight seal. They are offered with either aluminum, stainless steel or nylon fittings in a variety of configurations and NPT thread sizes. Additionally, a completely non-metallic product is offered on page V-61.

## Application

Deluxe Cord Grips are used indoors or outdoors to help prevent cord pull-out, and where cables are subjected to moisture, splash or submersion. Specific uses are: wiring enclosures, pendant stations, hand tools, construction, processing and material handling equipment, pumps, motors and machine tools.

## Benefits

- Helps to prevent cable pull-out.
- Controls cable arc-of-bend.
- Provides a liquidtight seal.
- Corrosion resistant stainless steel mesh with aluminum collar.



## Deluxe Cord Grips Fitting Dimensions

### Straight Hubbell Connectors

F NPT Inches	Aluminum, Inches (cm)					Nylon, Inches (cm)					Stainless Steel, Inches (cm)								
	A Form Dia.	B Ref.	C	D Throat Dia.	E A/C* A/F*	A Dia.	B Ref.	C	D Throat Dia.	E A/C* A/F*	A A/C* A/F*	B Ref.	C	D Throat Dia.	E A/C* A/F*				
3/8-18	1 .88" (2.24)	.90" (2.29)	.46" (1.17)	.44" (1.12)	.99" (2.51)	.88" (2.24)	1.00" (2.54)	1.10" (2.79)	.43" (1.09)	.45" (1.14)	1.00" (2.54)	.93" (2.36)	1.01" (2.57)	.88" (2.24)	.90" (2.29)	.46" (1.17)	.45" (1.14)	.87" (2.21)	.75" (1.90)
1/2-14	1 .88" (2.24)	.90" (2.29)	.46" (1.17)	.44" (1.12)	.99" (2.51)	.88" (2.24)	1.00" (2.54)	1.10" (2.79)	.43" (1.09)	.45" (1.14)	1.00" (2.54)	.93" (2.36)	—	—	—	—	—	—	—
1/2-14	2 1.13" (2.87)	1.10" (2.79)	.55" (1.40)	.64" (1.63)	1.11" (2.82)	1.00" (2.54)	1.32" (3.35)	1.50" (3.81)	.53" (1.35)	.58" (1.47)	1.25" (3.17)	1.12" (2.84)	1.30" (3.30)	1.13" (2.87)	1.10" (2.79)	.54" (1.37)	.63" (1.60)	1.16" (2.95)	1.00" (2.54)
1/2-14	3 1.38" (3.51)	1.50" (3.81)	.55" (1.40)	.64" (1.63)	1.40" (3.56)	1.25" (3.17)	—	—	—	—	—	—	—	—	—	—	—	—	—
3/4-14	2 1.13" (2.87)	1.10" (2.79)	.55" (1.40)	.64" (1.63)	1.29" (3.28)	1.13" (2.87)	—	—	—	—	—	—	—	—	—	—	—	—	—
3/4-14	3 1.38" (3.51)	1.50" (3.81)	.55" (1.40)	.82" (2.08)	1.40" (3.56)	1.25" (3.17)	1.56" (3.96)	1.60" (4.06)	.55" (1.40)	.77" (1.96)	1.44" (3.66)	1.31" (3.33)	1.59" (4.04)	1.38" (3.51)	1.30" (3.30)	.56" (1.42)	.81" (2.06)	1.44" (3.66)	1.25" (3.17)
1-11 1/2	3 —	—	—	—	—	—	—	—	—	—	—	—	—	—	—	—	—	—	—
1-11 1/2	4 1.75" (4.44)	1.60" (4.06)	.71" (1.80)	1.02" (2.59)	1.81" (4.60)	1.62" (4.11)	1.88" (4.78)	1.75" (4.44)	.70" (1.78)	1.01" (2.57)	1.84" (4.67)	1.63" (4.14)	2.02" (5.13)	1.75" (4.44)	1.40" (3.56)	.70" (1.78)	1.03" (2.62)	1.88" (4.78)	1.63" (4.14)
1-11 1/2	5 2.31" (5.87)	1.70" (4.32)	.66" (1.68)	1.01" (2.57)	2.28" (5.79)	2.00" (5.08)	—	—	—	—	—	—	—	—	—	—	—	—	—
1 1/4-11 1/2	5 2.31" (5.87)	1.70" (4.32)	.74" (1.88)	1.26" (3.20)	2.28" (5.79)	2.12" (5.38)	—	—	—	—	—	—	—	—	—	—	—	—	—
1 1/2-11	5 2.31" (5.87)	1.70" (4.32)	.74" (1.88)	1.38" (3.51)	2.28" (5.79)	2.12" (5.38)	—	—	—	—	—	—	—	—	—	—	—	—	—
1 1/2-11 1/2	6 3.00" (7.62)	2.20" (5.59)	.75" (1.90)	1.50" (3.81)	2.97" (7.54)	2.75" (6.98)	—	—	—	—	—	—	—	—	—	—	—	—	—
2-11 1/2	6 3.00" (7.62)	2.20" (5.59)	.80" (2.03)	1.92" (4.88)	3.24" (8.24)	3.00" (7.62)	—	—	—	—	—	—	—	—	—	—	—	—	—
2-11 1/2	7 3.85" (9.78)	2.70" (6.86)	.88" (2.24)	1.94" (4.93)	4.05" (10.29)	3.75" (9.52)	—	—	—	—	—	—	—	—	—	—	—	—	—
2 1/2-8	7 3.85" (9.78)	2.70" (6.86)	1.30" (3.30)	2.32" (5.89)	4.34" (11.02)	4.02" (10.21)	—	—	—	—	—	—	—	—	—	—	—	—	—
2 1/2-8	8 4.75" (12.06)	2.70" (6.86)	1.25" (3.17)	2.38" (6.05)	4.86" (12.34)	4.50" (11.43)	—	—	—	—	—	—	—	—	—	—	—	—	—
3-8	7 3.85" (9.78)	2.70" (6.86)	1.30" (3.30)	2.54" (6.45)	4.34" (11.02)	4.01" (10.21)	—	—	—	—	—	—	—	—	—	—	—	—	—
3-8	8 4.50" (11.43)	2.70" (6.86)	1.38" (3.51)	3.00" (7.62)	4.86" (12.34)	4.50" (11.43)	—	—	—	—	—	—	—	—	—	—	—	—	—

Note: \*A/C— Across Corners; A/F— Across Flats.

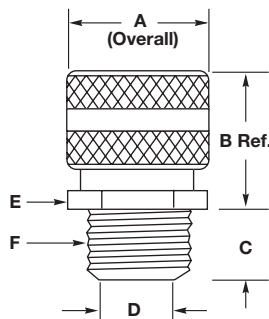

Dimensions shown are approximate and are subject to change without notice.



**Deluxe Cord Grips Fitting Dimensions**

**45° Hubbell Connectors**

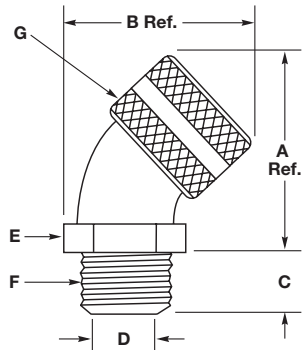

Aluminum, Inches (cm)								
F NPT Inches	Form	A Ref.	B Ref.	C	D Throat Dia.	E		G Dia.
						Across Comers	Across Flats	
½-14	2	2.00" (5.08)	1.90" (4.83)	.550" (1.40)	.560" (1.42)	1.270" (3.23)	1.110" (2.79)	1.125" (2.86)
¾-14	3	2.30" (5.84)	2.50" (6.53)	.560" (1.42)	.750" (1.90)	1.480" (3.76)	1.281" (3.25)	1.375" (3.49)
1-11½	4	2.60" (6.60)	2.80" (7.11)	.700" (1.78)	1.000" (2.54)	1.690" (4.29)	1.500" (3.81)	1.750" (4.44)
1¼-11½	5	3.90" (9.91)	3.90" (9.91)	.740" (1.88)	1.250" (3.17)	2.45" (6.22)	2.125" (5.40)	2.310" (5.87)
1½-11½	5	3.90" (9.91)	3.90" (9.91)	.740" (1.88)	1.500" (3.81)	2.45" (6.22)	2.125" (5.40)	2.310" (5.87)

**90° Hubbell Connectors**

Aluminum, Inches (cm)								Nylon, Inches (cm)							
F NPT Inches	Form	A	B Ref.	C	D Throat Dia.	E		G Dia.	A	B Ref.	C	D Throat Dia.	E		G Dia.
						A/C*	A/F*						A/C*	A/F*	
¾-18	1	1.27" (3.23)	2.00" (5.08)	.460" (1.17)	.440" (1.12)	1.15" (2.92)	1.10" (2.79)	.875" (2.22)	—	—	—	—	—	—	—
½-14	2	1.56" (3.96)	2.30" (5.84)	.500" (1.27)	.546" (1.39)	1.30" (3.30)	1.13" (2.87)	1.125" (2.86)	1.41" (3.58)	2.50" (6.35)	.550" (1.40)	.575" (1.46)	1.23" (3.12)	1.12" (2.82)	1.315" (3.34)
¾-14	3	1.79" (4.55)	2.80" (7.11)	.560" (1.42)	.765" (1.94)	1.49" (3.78)	1.31" (3.33)	1.375" (3.49)	1.65" (4.19)	2.81" (7.14)	.560" (1.42)	.765" (1.94)	1.42" (3.61)	1.29" (3.28)	1.560" (3.96)
1-11½	4	2.08" (5.28)	3.20" (8.13)	.700" (1.78)	1.000" (2.54)	1.70" (4.32)	1.50" (3.81)	1.750" (4.44)	1.99" (5.05)	3.30" (8.38)	.700" (1.78)	1.010" (2.57)	1.82" (4.62)	1.60" (4.06)	1.875" (4.76)
1¼-11½	5	3.18" (8.08)	4.30" (10.92)	.730" (1.85)	1.260" (3.20)	2.47" (6.27)	2.15" (5.46)	2.310" (5.87)	—	—	—	—	—	—	—
1½-11½	5	3.18" (8.08)	4.30" (10.92)	.750" (1.92)	1.500" (3.81)	2.47" (6.27)	2.15" (5.46)	2.310" (5.87)	—	—	—	—	—	—	—
2-11½	6	3.51" (8.92)	5.50" (13.97)	.800" (2.03)	1.920" (4.88)	2.98" (7.57)	2.78" (7.06)	3.000" (7.62)	—	—	—	—	—	—	—

Note: \*A/C - Across Corners; A/F - Across Flats.

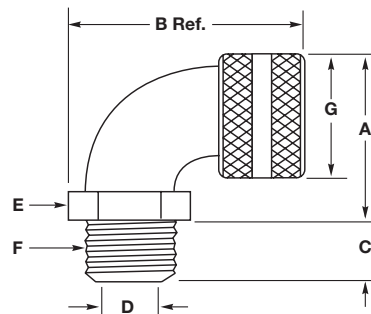

Dimensions shown are approximate and are subject to change without notice.



## Deluxe Cord Grips Fitting Dimensions

### Female Hubbell Connectors

Aluminum, Inches (cm)							
F NPT Inches	Form	A Dia.	B Ref.	C	D Throat Dia.	E	
						Across Corners	Across Flats
3/8-18	1	.88" (2.24)	1.40" (3.56)	.560" (1.42)	.44" (1.12)	.94" (2.39)	.81" (2.06)
1/2-14	2	1.13" (2.87)	1.80" (4.57)	.560" (1.42)	.63" (1.60)	1.15" (2.92)	1.00" (2.54)
3/4-14	2	1.13" (2.87)	2.10" (5.33)	.750" (1.90)	.63" (1.60)	1.44" (3.66)	1.25" (3.17)
1-11½	4	1.75" (4.44)	2.30" (5.84)	.880" (2.24)	1.10" (2.79)	1.88" (4.78)	1.63" (4.14)
1¼-11½	5	2.31" (5.87)	2.80" (7.11)	.950" (2.41)	1.43" (3.63)	2.64" (6.71)	2.29" (5.82)
1½-11½	5	2.31" (5.87)	2.80" (7.11)	.950" (2.41)	1.43" (3.63)	2.64" (6.71)	2.29" (5.82)

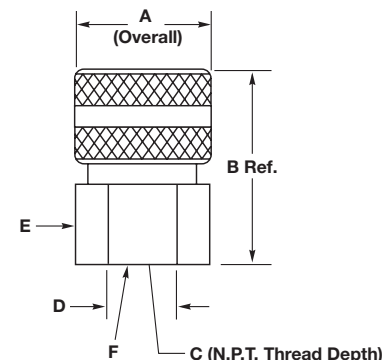

## Product Data

### Dust-Tight Strain Relief Grips for Insulated Cables

Kellems® Strain Relief Grips connect flexible cord or bus drop cable to electrical enclosures. For indoor use only, they are available with either insulated or non-insulated aluminum fittings, and feature single weave, galvanized steel mesh grips with patented wide range mesh construction. They come with a locknut and a neoprene gasket that provides a dust tight seal.

### Application

Used to connect electrical cable to power boxes, cabinets, panel boards, power centers, machine tools and with bus drop systems.

### Benefits

- Helps prevent cord or cable pull-out.
- Provides a dust tight seal.
- Easy installation.
- Patented mesh construction.
- One piece design.

### I-Grips for Insulated Cables

Kellems I-Grips are made of high strength, plastic coated galvanized steel strand. They are offered in six sizes to fit all cable diameters used with Hubbell Insulgrip®. Kellems I-Grips will control cable arc-of-bend and reduce high pull tensions from being transmitted to the wiring terminals.

### Application

Kellems I-Grips will fit 2, 3, 4 and 5 wire Hubbell Insulgrip plugs and connector bodies. The eye tabs fit under the nylon cord clamp and the screws slide through the eyelets, securing the grip in place.

I-Grips can be used on any Insulgrip cord set which requires cable, arc-of-bend control or heavy duty strain relief. Cord sets used at in-door construction sites or for plant maintenance jobs are examples.

These grips are for indoor use only.

### Benefits

- Easily attached to Insulgrip plugs and connector bodies.
- Fits all sizes.
- Provides heavy duty strain relief.
- Controls cable arc-of-bend.

Note: I-Grips should not be used on Insulgrip devices when "Seal-Tite®" weatherproof covers are to be installed.

Dimensions shown are approximate and are subject to change without notice.



**Strain Relief Grips for Liquidtight Flexible Metal and PolyTuff® I Non-Metallic Conduit**

Kellems Liquidtight, Flexible Metal Conduit Grips are offered with high quality Hubbell plated steel fittings in a wide variety of NPT sizes and configurations, either insulated or non-insulated. The addition of a stainless steel mesh to these fittings makes them stronger than the conduit itself. Kellems Conduit Grips helps prevent conduit pull-out from the connecting fitting that is subject to stress, pull tension, vibration, motion or strain. They promote safe electrical systems and reduce equipment downtime.

**Application**

Kellems Conduit Grips are used in the wiring of machine tools, motors, molding equipment, transformers, weaving and paper machines, fans, lighting, bakeries, breweries, food processing, chemical plants, dairies, mines and any application that requires Liquidtight Conduit.

**Benefits**

- Helps prevent conduit pull-out and damage at the fitting.
- Reduces equipment downtime.
- Liquidtight fittings.
- Easily installed.
- Stainless steel grip resists corrosion.

Kellems Conduit Grips are suitable for use in hazardous locations per Class I Div. 2, Class II Div. 1 & 2, Class III Div. 1 & 2 of the National Electric Code.

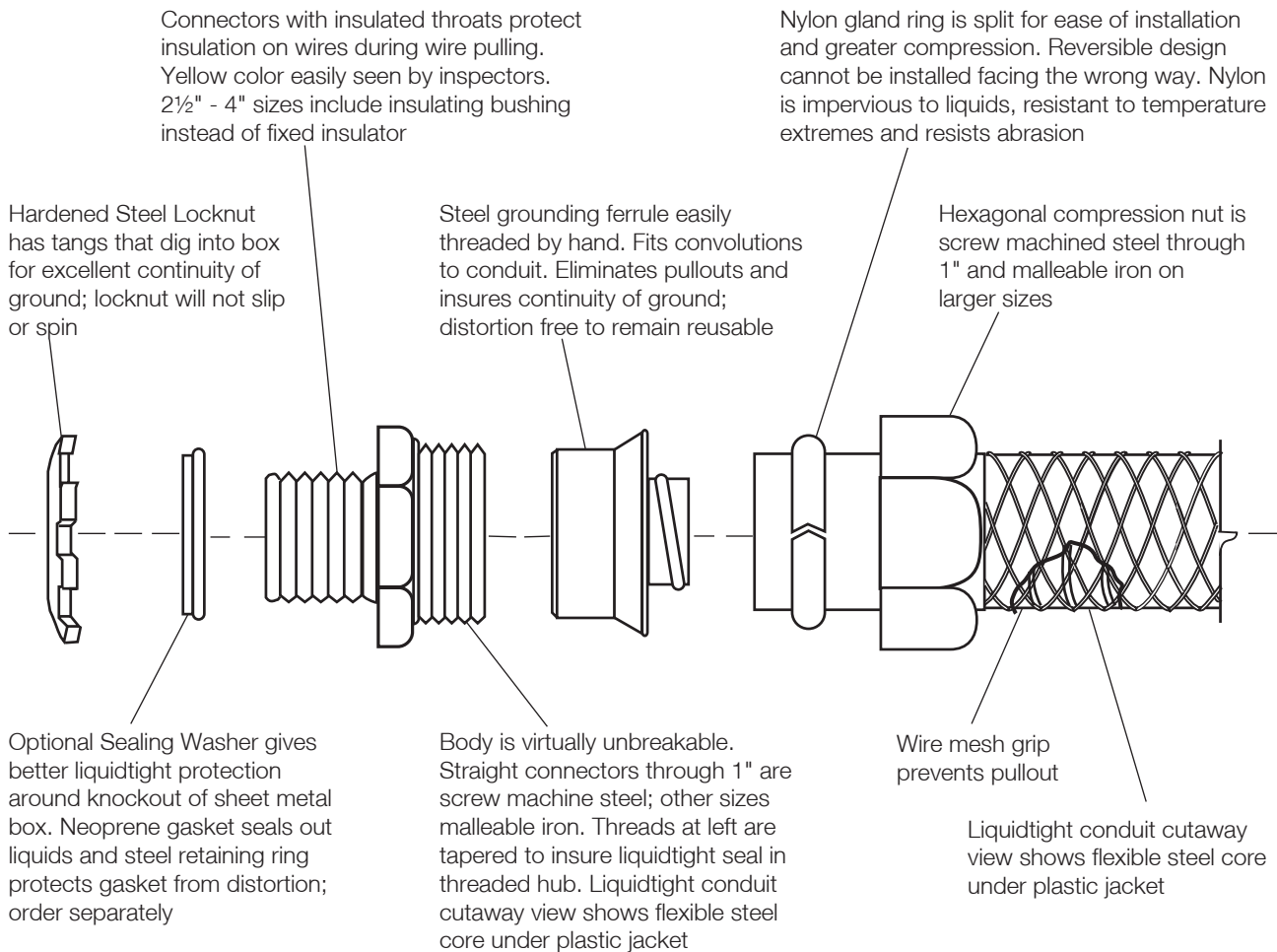



## Liquidtight Conduit Grip Fitting Dimensions, Inches

### Straight with Male Fitting

Dimensions, Inches

Trade Size Inches	A Ref.	B Ref.	C		D Throat Dia.	E		Catalog Number
			A/C*	A/F*		A/C*	A/F*	
3/8	1.43"	.59"	1.20"	1.06"	.61"	1.07"	.93"	<b>074093401</b>
1/2	1.43"	.59"	1.34"	1.19"	.61"	1.22"	1.06"	<b>074093402</b>
3/4	1.56"	.59"	1.55"	1.37"	.84"	1.43"	1.25"	<b>074093403</b>
1	1.68"	.66"	1.95"	1.69"	1.06"	1.73"	1.56"	<b>074093404</b>
1 1/4	2.03"	.63"	2.39"	2.06"	1.37"	2.36"	2.08"	<b>074093405</b>
1 1/2	2.21"	.63"	2.72"	2.38"	1.53"	2.79"	2.48"	<b>074093406</b>
2	2.28"	.69"	3.08"	2.87"	2.06"	3.32"	2.90"	<b>074093408</b>

### Straight with Male Fitting with Insulated Throat

Dimensions, Inches

Trade Size Inches	A Ref.	B Ref.	C		D Throat Dia.	E		Catalog Number
			A/C*	A/F*		A/C*	A/F*	
3/8	1.50"	.66"	1.20"	1.06"	.57"	1.07"	.93"	<b>074093511</b>
1/2	1.50"	.66"	1.34"	1.19"	.57"	1.22"	1.06"	<b>074093512</b>
3/4	1.62"	.66"	1.55"	1.38"	.78"	1.43"	1.25"	<b>074093513</b>
1	1.75"	.72"	1.95"	1.69"	.98"	1.73"	1.56"	<b>074093514</b>
1 1/4	2.09"	.69"	2.39"	2.06"	1.29"	2.36"	2.08"	<b>074093515</b>
1 1/2	2.28"	.69"	2.72"	2.37"	1.53"	2.79"	2.48"	<b>074093516</b>
2	2.34"	.75"	3.08"	2.87"	1.95"	3.32"	2.90"	<b>074093518</b>
2 1/2	3.56"	1.06"	3.92"	3.62"	2.42"	3.85"	3.60"	<b>074093520</b>
3	3.81"	1.06"	4.70"	4.31"	3.01"	4.65"	4.33"	<b>074093522</b>
4	3.81"	1.06"	5.75"	5.31"	3.96"	5.75"	5.39"	<b>074093526</b>

### 45° Angle with Male Fitting

Dimensions, Inches

Trade Size Inches	H Ref.	J Ref.	K Ref.	L		M Throat Dia.	N		Catalog Number
				A/C*	A/F*		A/C*	A/F*	
3/8	1.19"	1.28"	.59"	1.20"	1.06"	.60"	1.16"	1.02"	<b>074093441</b>
1/2	1.19"	1.28"	.59"	1.34"	1.19"	.61"	1.21"	1.06"	<b>074093442</b>
3/4	1.19"	1.43"	.59"	1.55"	1.45"	.84"	1.50"	1.32"	<b>074093443</b>
1	1.38"	1.53"	.66"	1.95"	1.69"	1.05"	1.82"	1.59"	<b>074093444</b>
1 1/4	1.42"	1.69"	.63"	2.39"	2.06"	1.37"	2.32"	2.03"	<b>074093445</b>
1 1/2	1.66"	2.00"	.66"	2.72"	2.38"	1.60"	2.62"	2.29"	<b>074093446</b>
2	1.69"	2.25"	.66"	3.08"	2.88"	2.05"	3.21"	2.80"	<b>074093448</b>

### 45° Angle with Male Fitting with Insulated Throat

Dimensions, Inches

Trade Size Inches	H Ref.	J Ref.	K Ref.	L		M Throat Dia.	N		Catalog Number
				A/C*	A/F*		A/C*	A/F*	
3/8	1.25"	1.28"	.66"	1.20"	1.06"	.57"	1.16"	1.02"	<b>074093561</b>
1/2	1.25"	1.28"	.66"	1.34"	1.19"	.57"	1.21"	1.06"	<b>074093562</b>
3/4	1.25"	1.44"	.66"	1.55"	1.45"	.78"	1.50"	1.32"	<b>074093563</b>
1	1.44"	1.53"	.72"	1.95"	1.69"	.98"	1.82"	1.59"	<b>074093564</b>
1 1/4	1.48"	1.69"	.69"	2.39"	2.06"	1.29"	2.32"	2.03"	<b>074093565</b>
1 1/2	1.72"	2.00"	.72"	2.72"	2.38"	1.53"	2.62"	2.29"	<b>074093566</b>
2	1.75"	2.25"	.72"	3.08"	2.87"	1.95"	3.21"	2.80"	<b>074093568</b>

### 90° Angle with Male Fitting

Dimensions, Inches

Trade Size Inches	D Ref.	E Ref.	F		G Ref.	O Throat Dia.	P		Catalog Number
			A/C*	A/F*			A/C*	A/F*	
3/8	1.31"	.59"	1.20"	1.06"	1.44"	.60"	1.13"	.99"	<b>074093421</b>
1/2	1.31"	.59"	1.34"	1.12"	1.44"	.61"	1.21"	1.00"	<b>074093422</b>
3/4	1.44"	.59"	1.55"	1.45"	1.63"	.83"	1.48"	1.29"	<b>074093423</b>
1	1.78"	.66"	1.95"	1.60"	2.19"	1.05"	1.80"	1.57"	<b>074093424</b>
1 1/4	1.97"	.63"	2.39"	2.06"	2.50"	1.37"	2.32"	2.02"	<b>074093425</b>
1 1/2	2.19"	.66"	2.72"	2.38"	2.69"	1.61"	2.58"	2.25"	<b>074093426</b>
2	2.53"	.66"	3.08"	2.87"	3.25"	2.05"	3.14"	2.75"	<b>074093428</b>

### 90° Angle with Male Fitting with Insulated Throat

Dimensions, Inches

Trade Size Inches	D Ref.	E Ref.	F		G Ref.	O Throat Dia.	P		Catalog Number
			A/C*	A/F*			A/C*	A/F*	
3/8	1.38"	.66"	1.20"	1.06"	1.44"	.60"	1.13"	.99"	<b>074093541</b>
1/2	1.38"	.66"	1.34"	1.12"	1.44"	.57"	1.21"	1.00"	<b>074093542</b>
3/4	1.50"	.66"	1.55"	1.45"	1.63"	.78"	1.48"	1.29"	<b>074093543</b>
1	1.84"	.66"	1.95"	1.60"	2.19"	.98"	1.80"	1.57"	<b>074093544</b>
1 1/4	2.03"	.69"	2.39"	2.06"	2.50"	1.29"	2.32"	2.02"	<b>074093545</b>
1 1/2	2.25"	.69"	2.72"	2.38"	2.69"	1.53"	2.58"	2.20"	<b>074093546</b>
2	2.59"	.72"	3.08"	2.87"	3.25"	1.95"	3.14"	2.75"	<b>074093548</b>
2 1/2	3.44"	1.00"	3.92"	3.63"	4.25"	2.42"	3.78"	3.50"	<b>074093550</b>
3	3.75"	1.00"	4.70"	4.31"	4.87"	3.01"	4.64"	4.30"	<b>074093552</b>

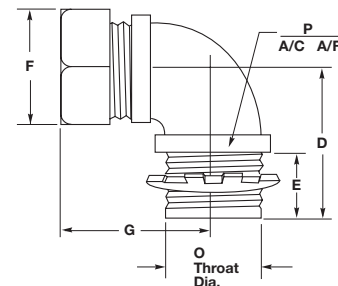
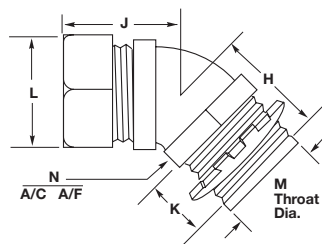
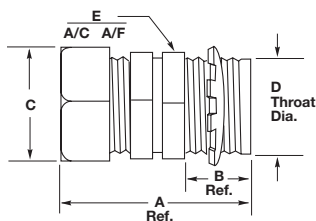

Note: \*A/C - Across Corners; A/F - Across Flats.

Dimensions shown are approximate and are subject to change without notice.





**Strain Relief for UL Type A, Flexible, Liquidtight Conduit**

Kellems Grips for UL Type A, non-metallic, flexible, liquidtight conduit are available in straight and 90° male and feature a high quality Hubbell plated steel or malleable iron fitting, complete with a sealing O-ring, lock nut and stainless steel mesh. These grips increase the retention of the conduit in the fitting, control its arc-of-bend and provide a liquidtight seal.

**Application**

These grips are used on UL Type A non-metallic conduit connections at limit switches, motor boxes, panel boards, control stations and on all types of machinery and machine tools.

Steel Locknut has tangs that dig into box for excellent continuity of ground; locknut will not slip or spin

Neoprene O-ring is factory assembled into the body to seal out liquids

Insulated throat protects insulation on wires during pulling; yellow color easily seen by inspectors

Yellow nylon ferrule fits inside non-metallic conduit to hold the shape; barb in designed to assure liquidtight seal even with non-square cut; ferrule is keyed to fit into body to prevent conduit twisting

**Benefits**

- Provides a liquidtight seal.
- Helps prevent conduit pull-out.
- Reduces conduit cutting, kinking, fraying and splitting at the fitting.
- Easily installed.

Body is virtually unbreakable. Straight connectors through 1" are screw machine steel; other sizes are malleable iron. Threads are tapered to insure liquidtight seal when used in threaded hub; octagonal shape inside holds the ferrule to prevent conduit from twisting during installation

Wire mesh grip prevents pullout

Hexagonal compression nut is machine steel through 1" malleable iron on larger sizes; tapered interior compresses sleeve over conduit sealing out liquids and preventing pullout

Yellow nylon sleeve installs over conduit; six slits in sleeve permit tight compression onto conduit as compression nut is tightened

**Dimensional Charts For UL Type A, Liquidtight Conduit Grip Fittings**

**Straight with Male Fitting with Insulated Throat**

Dimensions Inches (cm)

Trade Size NPT Inches	A	B	C	D	Catalog Number
3/8	1.922" (4.88)	.594" (1.51)	1.156" (2.94)	3.75" (9.52)	<b>H038CNK</b>
1/2	1.922" (4.88)	.594" (1.51)	1.250" (3.17)	4.50" (11.43)	<b>H050CNK</b>
3/4	2.016" (5.12)	.594" (1.51)	1.500" (3.81)	6.25" (15.87)	<b>H075CNK</b>
1	2.157" (5.48)	.719" (1.83)	1.844" (4.68)	7.50" (19.05)	<b>H100CNK</b>
1 1/4	2.219" (5.64)	.750" (1.91)	2.312" (5.87)	9.00" (22.86)	<b>H125CNK</b>
1 1/2	2.344" (5.95)	.750" (1.91)	2.578" (6.55)	13.50" (34.29)	<b>H150CNK</b>
2	2.406" (6.11)	.750" (1.91)	3.187" (8.09)	14.50" (36.83)	<b>H200CNK</b>

**90° Angle with Male Fitting with Insulated Throat**

Dimensions Inches (cm)

Trade Size NPT Inches	E	F	G	H	I	Catalog Number
3/8	1.250" (3.18)	.594" (1.51)	1.156" (2.94)	1.453" (3.69)	3.75" (9.52)	<b>H0389CNK</b>
1/2	1.281" (3.25)	.594" (1.51)	1.250" (3.17)	1.453" (3.69)	4.50" (11.43)	<b>H0509CNK</b>
3/4	1.438" (3.65)	.594" (1.51)	1.500" (3.81)	1.000" (2.54)	6.25" (15.87)	<b>H0759CNK</b>
1	1.750" (4.44)	.719" (1.83)	1.844" (4.68)	2.125" (5.40)	7.50" (19.05)	<b>H1009CNK</b>
1 1/4	1.969" (5.00)	.750" (1.91)	2.312" (5.87)	2.344" (5.95)	9.00" (22.86)	<b>H1259CNK</b>
1 1/2	2.250" (5.71)	.750" (1.91)	2.578" (6.55)	2.500" (6.35)	13.50" (34.29)	<b>H1509CNK</b>
2	2.531" (6.43)	.750" (1.91)	3.187" (8.09)	2.781" (7.06)	14.50" (36.83)	<b>H2009CNK</b>

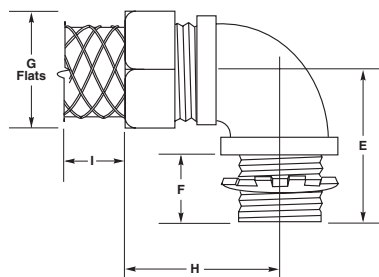
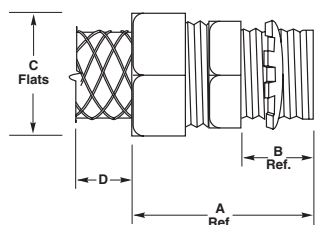
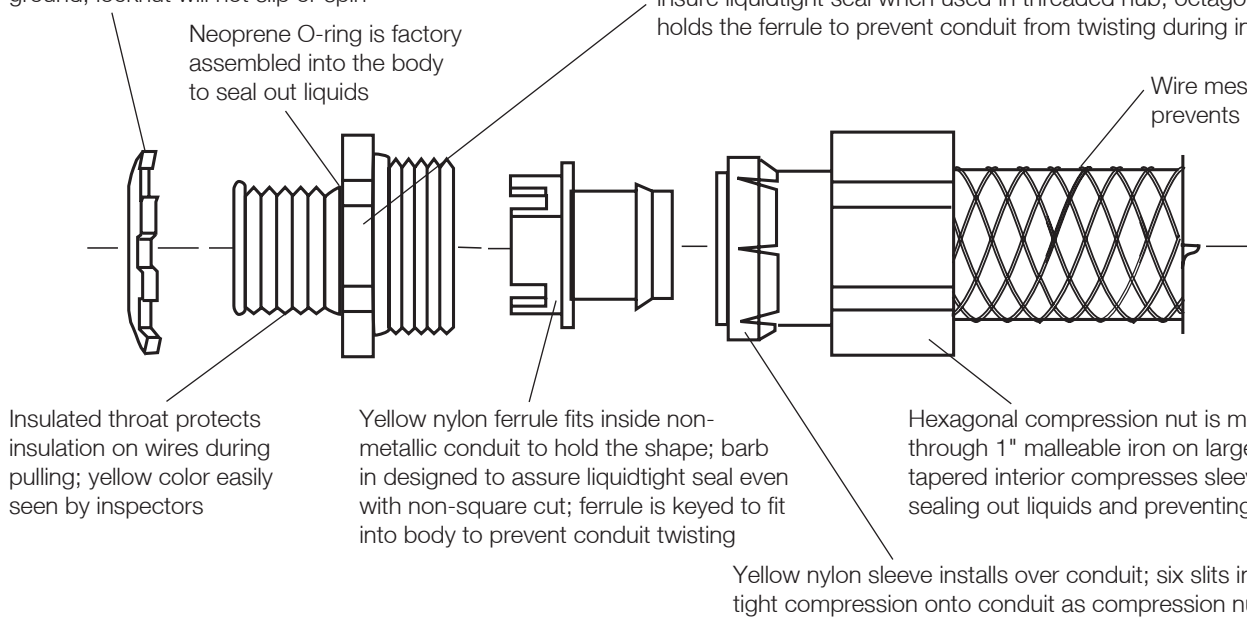



Kellems has wide experience with grips for use with fiber optic cable. As the industry leader in producing wire mesh grips for the stringent requirements of fiber optic applications, Kellems has developed several series of grips for use with fiber optic communications cable.

These grips include pulling grips with built in swivels, grips with steel ends to protect fragile cable ends, grips with low profiles to pull cables in tight places and the OPTISOK® an effective tool to place preterminated cables. Also available are grips to support fiber optic cable.

### Safety And Working Load Factors For Wire Mesh Grips

The broad application of Kellems grips on a wide variety of objects requires that adequate safety factors be used to establish working loads. The approximate breaking strength of a Kellems grip represents an average calculation based on data established from actual direct tension testing done in our engineering laboratories.

It is impossible to catalog or guarantee a safety factor suitable for all applications as operating conditions are never the same. The tension, diameter, movement, number of objects gripped, gripping surface, and the attachments used are just some of the factors which vary with each application. These factors, together with the effects of abrasion, corrosion, prior use or abuse and any other variables of a specific application, must be considered by the user and the grip replaced as appropriate. Where the conditions of

### Select the Correct Fiber Optic Grip

Each Kellems grip is designed to work on a specific range of cable diameters.

- Step 1** Determine your cable outside diameter.
- Step 2** Find the grip size that encompasses your cable diameter.
- Step 3** Whenever possible, use a closed mesh that assembles over the cable end. If the cable end is not available, use a split mesh.
- Step 4** Where available, select an eye style that suits your needs.
- Step 5** Estimate the tension to be put on the grip, establish the working load you require and compare this to the listed approximate breaking strength of the grip to insure that the grip will be strong enough.

the application are not well defined or known or where risk of injury to persons or property is involved, a greater safety factor should be utilized.

**Under normal conditions, Kellems' recommended factor of safety is five for catalog listed pulling grips, and ten for catalog listed support grips.**

Any warranty as to quality, performance or fitness for use of grips is always premised on the condition that the published breaking strengths apply only to new, unused grips, and that such products are properly stored, handled, used, maintained and inspected by the user at a frequency appropriate for the use and condition of the grip.

For grip applications on materials other than those that the grips have been specifically designed for, consult the factory.

### Examples

Grip Style	Approx. Breaking Strength Lbs. (N)	Safety Factor	Max. Recommended Load Lbs. (N)	Catalog Number
Pulling Grips	2,500 (11,120)	5	500 (2,224)	<b>033291196</b>
Support Grips	400 (1,779)	10	40 (178)	<b>022291004</b>

The maximum recommended working load is the tension to be exerted on the grip in application with a margin of safety to take care of unforeseen and unusual circumstances.

It is the end-user's decision to determine how much of a safety factor is acceptable to for the application.

### Fiber Optic Grip Materials

Material	Features	Product Group
Galvanized steel wire	<ul style="list-style-type: none"> <li>• High strength</li> <li>• Not subject to continuous outside environment</li> </ul>	<ul style="list-style-type: none"> <li>• Pulling grips</li> </ul>
Tin-coated bronze wire	<ul style="list-style-type: none"> <li>• Corrosion resistant for normal outside areas</li> <li>• Non-magnetic</li> <li>• Moderate strength</li> </ul>	<ul style="list-style-type: none"> <li>• Support grips</li> </ul>
Non-metallic braid	<ul style="list-style-type: none"> <li>• Superior flex life</li> <li>• Non-conductive</li> <li>• Corrosion resistant</li> <li>• Moderate strength</li> </ul>	<ul style="list-style-type: none"> <li>• OPTISOK®</li> </ul>

### Approvals

CSA Certification is indicated on appropriate product catalog pages.



Kellems offers a unique and simple to use tool for the installation of preconnectorized fiber optic cables, jumpers and bundles of twisted pair communication cables - the OPTISOK®.

The OPTISOK® is a highly flexible and expandable nonmetallic sleeve open on one end and with a pulling ring on the other. It will expand to enclose the larger group of fiber optic connectors and grab the cable below the connector bundle by wrapping and taping to provide a gripping tool that will grab the cable(s) below the connectors. The pulling ring can be attached to a pulling line or fish tape and the OPTISOK® will act as the pulling tool.

OPTISOK® will contain and protect the connector bundle and save time and labor by making the pulling job easier, protecting the connectors from possible damage during the pull and facilitating the passage of the connector bundle through cramped and tight spaces. The OPTISOK® can be used to pull cables through plenums, underfloor duct, office partitions, raised access floors and conduits. Three sizes are available for all applications.

### How to Select OPTISOK®

- Identify connector bundle diameter to be inserted into the OPTISOK®.
- Choose appropriate catalog number based on size range.

### Installation Information

**Step 1** Expand open end of OPTISOK® and gently work in fiber optic connector bundle.

**Step 2** Still gently, work connector bundle up to the forward section of the OPTISOK®.

**Step 3** Starting at approximately 6" (15.2cm) from tail end of OPTISOK®, tightly fold over the OPTISOK® around cables and tape wrapped section 3" (7.62cm) past tail end onto the bundle.

**Step 4** Securely attach pulling line or tape to pulling ring.

*Note: To remove OPTISOK® carefully unwrap tape and slide out cables and connectors or cut OPTISOK® away without damaging connectors or cables.*

#### Step 1

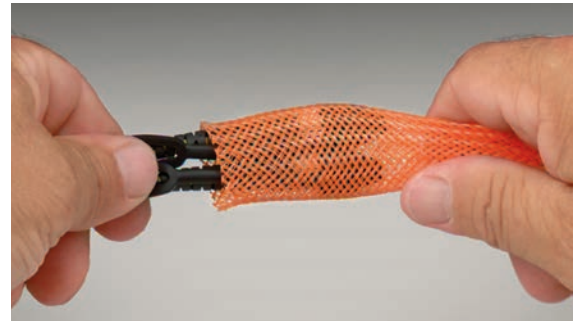

#### Step 2



#### Step 3



#### Step 4





## **Pulling Grip for Loose Tube Fiber Optic Cable**

---

Kellems offers a wire mesh specifically designed to pull loose tube fiber optic cable and meet the special pulling requirements recommended by fiber optic cable manufacturers.

Many fiber optic cable manufacturers require special cable preparation prior to pulling where a short section of the outer jacket is stripped off exposing the aramid strength member. This creates two cable diameters, one including the jacket and a second smaller diameter at the strength member. Kellems fiber grip with its special weave will accommodate and securely grab both diameters, at the outside jacket and the internal aramid strength member.

Additionally, this galvanized steel mesh grip has longer leads at the pulling eye to facilitate pulling the cable up through the top, a very low profile lug and eye to slip through tight areas, and short shoulders to protect the cable while maintaining the slim profile.

The grip can be used to pull cable overhead as well as underground through conduit and duct. It easily mates with a swivel and has the necessary strength to securely make pulls.

## **Application Information**

---

- Prior to pulling cable, follow cable manufacturers' cable preparation recommendations.
- Never exceed cable manufacturers' pulling tension recommendations.
- Never use grips to approximate breaking strength safety factor of 5 recommended.

## **Pulling Grips for Other Outside Plant Cables, Swivel Eye, Flexible Eye, Split Style, Low Profile**

---

Kellems Pulling Grips for fiber optic cable are made of high strength galvanized steel strand. They feature a multiweave mesh, with one-half the mesh length double weave, and the second half single weave. This special weave provides positive holding power while allowing the grip to remain flexible with no damage to the cable jacket. Added features include a steel nose cone which protects the cable end and allows the grip to pass easily through conduit and enclosures. The eye connects easily to a swivel or a pulling line. Several grip sizes are available to accommodate all diameters of fiber optic cable.

## **Application**

---

Kellems Flexible Eye Pulling Grips for fiber optic cable are used for the installation of fiber optic communication lines either underground, overhead, through conduit or through enclosures. They will fit single cables or cable bundles, are easily installed on the cable, and are reusable.

## **Benefits**

---

- High strength multiweave mesh for positive holding power.
- Highly flexible mesh to follow the pulling path of the cable.
- Steel nose cone reduces snags and hang-ups and protects cable end.
- Easily installed and removed.
- A dependable, reusable pulling tool.



## Support Grips for Fiber Optic Cable

---

Kellems Support Grips for fiber optic cable are specially designed to hold the cable weight as it hangs in a vertical or horizontal position. Fiber optic cable must be supported and Kellems Grips provide the support easily and economically.

These grips are made of high grade, non-magnetic tin-coated bronze strand. They are offered in universal bale or single eye configurations and are available in either closed mesh (for use where the cable end is available) or in split mesh, rod closing (for installation on existing cable runs or at specific locations).

## Split Support Grip Rod Closing Instructions

---

The stainless steel rod is a precise built-in feature which makes threading easy and fast. The strands of the mesh pass around the rod and match up with the strands from the opposite direction. The rod does not touch the cable at any point and therefore cannot cut the cable. Rod Closing Grips are reusable. They may be removed and reused as many times as desired.

## Fast to Install

---

**Step 1** Wrap the grip around the cable and thread the rod through the preformed loops with a corkscrew motion, using the curved end of the rod to engage the loops.

---

**Step 2** The action required is a steady push and twist simultaneously. The fingers of the left hand are used to bring the loops together just ahead of the hook on the end of the rod.

---

**Step 3** To remove, simply pull the rod out.

---





### Types of Attachment

The five attachment methods shown below provide unlimited flexibility of attachment to meet any condition.

#### Type E

Double Eye Grip, used where fastening is made with eyebolts or similar anchor terminations.

#### Type A

Single Eye Grip, used where fastening MUST be made from one point.

#### Type U

Universal Bale Grip, used to fasten around a structure or closed eye.

#### Type Y

Threaded bolt ( $\frac{5}{16}$ -18 x 1 $\frac{1}{2}$ " long), used to fasten through drilled holes in plate.

#### Type F

Split fitting to fit AN-818 nuts. Fitting is positioned over nut and located with internal flange. A hose clamp is furnished and required to hold the fitting in correct position.

### IMPORTANT

Read all breaking strength, safety and technical data relating to this product. Pages V-41 to V-42.

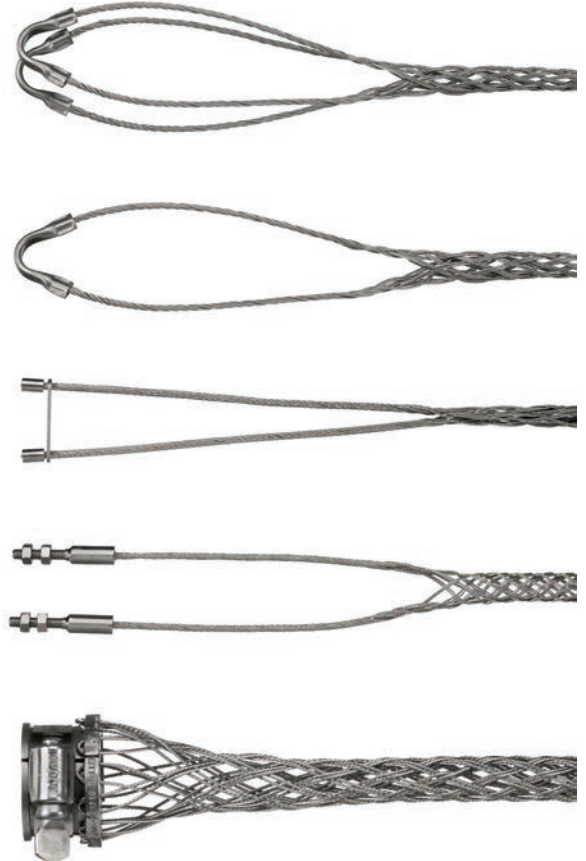

*Note: It should be emphasized that Kellems® Hose Containment Grips are not to be used as a pressure reinforcing device for hose systems. These grips are custom made. Consult Technical Services for details.*

Kellems Hose Containment Grips are used on high pressure, flexible hose lines to prevent the hose from whipping violently in the event of hose failure at the fitting. These grips will prevent serious injury to personnel and damage to equipment by holding the hose in place in the event of hose failure.

Kellems patented Hose Containment Grips are made of stainless steel with double weave mesh construction for high strength and come complete with hose clamps.

Kellems Hose Containment Grips are supplied in diameters, length and attachments to meet individual requirements. Contact the Wiring Device-Kellems factory for specific information. These grips help meet OSHA Federal Register 1926-302 (b), 1926-603 (9), (10), JIC H-1-1973 (H13.11) and JIC P-1-1975 (P11.34) requirements.



Kellems Strain Relief Grips are designed to prevent tension from being transmitted to joints and terminals on electrical cord, cable and conduit. In most applications, a Kellems grip for strain relief is stronger than the cable itself and gives much greater security than the use of a fitting alone. Kellems Grips for strain relief help make electrical systems safer, and save money by minimizing downtime from costly electrical failure due to cable pull-out. Kellems Grips also aid in compliance with the National Electric Code's terminal tension protection requirements.

**Select the Correct Grip for Strain Relief**

Kellems Grips for strain relief are designed to fit on electrical cord, cable or flexible conduit.

**Step 1** Refer to the chart below to determine the grip style best suited for your application.







**Step 2** Determine your cable outside diameter or conduit size.

**Step 3** Locate environment—indoors or outdoors.

**Step 4** Decide if a liquidtight seal is required.

**Step 5** Select NPT size and fitting style.

**Strain Relief System Selection Chart**

Grip Type	Application	Features	Cord or Conduit Range Inches (cm)	Type Fitting or Attachment	Page Number
<b>Deluxe Cord Aluminum Fitting/ Stainless Steel Grip</b> 	Outdoors or indoors where subjected to moisture or splash. Examples are crane and hoist pendant drop stations, hand tools, pumps and processing equipment.	Aluminum fittings, stainless steel mesh, neoprene oil-and-watertight bushing. Double-single weave.	.187"-3.250" (.47-8.25)	NPT, PG, and metric aluminum, male straight, 45° male, 90° male, female straight. Thread sizes 3/8"-3".	V-58, V-59, V-62
<b>Deluxe Cord Nylon Fitting/ Stainless Steel Grip</b> 	Outdoors or indoors where subjected to moisture or splash. Examples are marine and food processing equipment.	Nylon fitting, stainless steel mesh, double-single weave, neoprene oil-and-watertight bushing.	.187"-1.125" (.47-2.86)	NPT nylon, male straight, 90° male. Thread sizes 1/2"-1".	V-60
<b>Deluxe Cord Nylon Fitting/ Non-metallic Grip</b> 	Indoor or outdoors. Provides liquidtight seal, where exposed to moisture. Excellent for oil refining and chemical processing.	Non-metallic grip is corrosion resistant, nonconductive and provides superior gripping and flexing benefits. Neoprene liquidtight bushing. Nylon fitting.	.187"-1.000" (.47-2.54)	NPT nylon, straight male, thread sizes 3/8"-1" 90° male, thread sizes 1/2"-1".	V-61
<b>Deluxe Cord Stainless Steel Fitting And Grip</b> 	Indoor or outdoor use where exposed to moisture. Very strong for heavy abuse areas such as drilling platforms, steel mills and mines.	Stainless steel fitting and grip for strength. Neoprene liquidtight bushing. Double/single weave grip.	.187"-1.000" (.47-2.54)	Straight male Only with NPT Thread sizes 1/2"-1".	V-61
<b>Dust-Tight Strain Relief</b> 	Indoor use only for wiring of electrical enclosures, machine tools, portable power tools, bus drop cable systems.	Neoprene gasket—seals out chips, dirt, dust. One piece design with galvanized steel mesh. Insulating bushing available. Zinc-plated steel locknut.	.240"-2.450" (.61-6.22)	Straight male NPS or NPT	V-63
<b>Liquidtight Flexible Conduit Grip (Metal and Non-Metallic)</b> 	Wiring of machine tools, electrical enclosures, motors and systems where metallic liquidtight flexible conduit is subjected to vibration, flexure, motion or strain.	Stainless steel mesh, liquidtight fittings. Sealing "O" rings (optional). Choice of fittings.	.375"-4.000" trade sizes	NPT 1/2"-4", Hubbell fittings, Male straight, 45° male, 90° male, female straight.	V-66, V-67
<b>Liquidtight Flexible Conduit Grip (UL Type A)</b> 	Wiring or machine tools, electrical enclosures, motors and systems where conduit is subject to vibration and strain.	Stainless steel mesh, liquidtight fittings with "O" ring and locknut.	.375"-2.008" trade size male	NPT steel, Hubbell fittings, straight male, 90° Thread sizes 1/2"-2".	V-68



Endless weave provides easy cable/flexible conduit installation

Stainless steel mesh is corrosion resistant. Can be used inside or outside. It eliminates cable or flexible conduit pull out and reduces costly downtime

Multiweave grip gives cable arc-of-bend control minimizing cable damage and extending cable life. It is the strongest strain relief device available. Meets and exceeds all code requirements; prevents cable/conduit pull-out

A liquidtight fitting is available with both cable and conduit fittings; prevents liquids from running through the fitting into the enclosure

An NPT and PG threaded body allows easy attachment to either threaded hub or knock-out in box

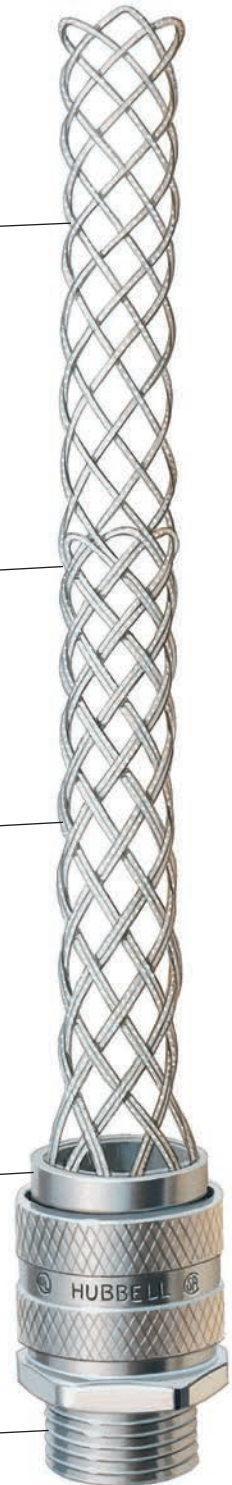



**IMPORTANT**

Read all breaking strength, safety and technical data relating to this product. Pages V-69 to V-76.

**Non-Insulated, Wide Range Strain Relief**

Thread Size	Cable Diameter Range Inches (cm)	Mesh Length @ Nom. Dia. Inches (cm)	Catalog Number
½ NPT	.24"-.32" (.61-.81)	3.25" (8.25)	<b>073031200</b>
½ NPT	.32"-.43" (.81-1.09)	3.75" (9.52)	<b>073031201</b>
½ NPT	.43"-.54" (1.09-1.37)	4.75" (12.06)	<b>073031202</b>
¾ NPT	.54"-.73" (1.37-1.85)	6.5" (16.51)	<b>073031203</b>
1 NPT	.73"-.97" (1.85-2.46)	7" (17.78)	<b>073031204</b>
1¼ NPT	.97"-1.25" (2.46-3.17)	9" (22.86)	<b>073031205</b>
PG29*	.73"-.97" (1.85-2.46)	7" (17.78)	<b>073PG291204</b>

Note: \*Panzergewinde.



**Insulated, Wide Range Strain Relief with Insulating Bushing**

Thread Size	Cable Diameter Range Inches (cm)	Mesh Length @ Nom. Dia. Inches (cm)	Dim. A Inches (cm)	Min. Space Between Grips Inches (cm)	Catalog Number
½ NPS	.24"-.32" (.61-.81)	3.25" (8.25)	1" (2.54)	1.25" (3.17)	<b>073031206</b>
½ NPS	.32"-.43" (.81-1.09)	3.75" (9.52)	1" (2.54)	1.25" (3.17)	<b>073031207</b>
½ NPS	.43"-.54" (1.09-1.37)	4.75" (12.06)	1" (2.54)	1.25" (3.17)	<b>073031208</b>
¾ NPS	.54"-.73" (1.37-1.85)	6.5" (16.51)	1" (2.54)	1.5" (3.81)	<b>073031209</b>
1 NPS	.73"-.97" (1.85-2.46)	7" (17.78)	1.313" (3.02)	1.75" (4.44)	<b>073031210</b>
1¼ NPS	.97"-1.25" (2.46-3.17)	9" (22.86)	1.313" (3.02)	2.25" (5.71)	<b>073031211</b>
1½ NPT	1.25"-1.50" (3.17-3.81)	11.75" (29.84)	1.313" (3.02)	2.5" (6.35)	<b>073031212</b>
2 NPT	1.50"-1.70" (3.81-4.32)	13.25" (33.65)	1.375" (3.49)	3.25" (8.25)	<b>073031213</b>
2½ NPT	1.70"-2.00" (4.32-5.08)	13.5" (34.29)	1.5" (3.81)	3.625" (9.21)	<b>073031214</b>
2½ NPT	2.00"-2.45" (5.08-6.22)	13.75" (34.92)	1.5" (3.81)	3.625" (9.21)	<b>073031215</b>





### Thread Adapters for Multi-Pin Connectors

Kellems® Thread Adapters are devices formatting AN-MS connectors and other multi-pin connectors to Kellems grips with NPT threaded fittings. They are made of aluminum with internal threads and replace the connector cord clamp. These adapters permit the installation of Kellems Grips, to prevent cable or conduit pull-out and control arc-of-bend.

### Applications

Thread adapters allow the installation of Kellems® Grips on multi-pin connectors at electrical consoles, mobile equipment, control switches, assembly equipment and testing machines.

### Benefits

- Easy installation.
- Allows the use of Kellems grips.
- Extends connector and cable life.

### Thread Adapters for Multi-Pin Connectors

Thread Adapters					Deluxe Cord Grips		Strain Relief Grips		Liquidtight Conduit Grips (Insulated Throat)
AN-MS Connector Size**	AN-MS Cable Clamp Number***	Thread Size A Inch	NPT Thread Size B	Catalog Number	Cable Diameter Range Inches (cm)	Catalog Number	Cable Diameter Range Inches (cm)	Catalog Number	Catalog Number
8S, 10S	3057-3	½" x 28"	⅜	<b>091041000</b>	.250"-.312" (.63-.79)	07401001	—	—	—
10SL, 12, 12S	3057-4	⅝" x 24"		<b>091041001</b>	.312"-.375" (.79-.95)	07401002			
14, 14S	3057-6	¾" x 20"		<b>091041002</b>	.375"-.437" (.95-1.11)	07401003			
14, 14S	3057-6	¾" x 20"	½	<b>091041003</b>	.187"-.250" (.47-.63)	07401004	.24"-.32" (.61-.81)	073031200	—
16, 16S	3057-8	⅞" x 20"		<b>091041004</b>	.250"-.375" (.63-.95)	07401006	.32"-.43" (.81-1.09)	073031201	074093512
18	3057-10	1" x 20"		<b>091041006</b>	.375"-.500" (.95-1.27)	07401008	.43"-.54" (1.09-1.37)	073031202	—
16, 16S	3057-8	⅞" x 20"	¾	<b>091041005</b>	.187"-.250" (.47-.63)	07401011	.54"-.74" (1.37-1.85)	073031203	074093513
18	3057-10	1" x 20"		<b>091041007</b>	.250"-.375" (.63-.95)	07401013			
20, 22	3057-12	1¼" x 18"		<b>091041008</b>	.375"-.500" (.95-1.27)	07401015			
					.500"-.625" (1.27-1.59)	07401017			
				.625"-.750" (1.59-1.90)	07401018				
20, 22	3057-12	1¼" x 18"	1	<b>091041009</b>	.375"-.500" (.95-1.27)	074011195	.73"-.97" (1.85-2.46)	073031204	074093514
24, 28	3057-16	1⅞" x 18"		<b>091041010</b>	.500"-.625" (1.27-1.59)	07401019			
32	3057-20	1¾" x 18"		<b>091041012</b>	.625"-.750" (1.59-1.90)	07401021			
36	3057-24	2" x 18"		<b>091041015</b>	.750"-.875" (1.90-2.22)	07401023			
					.875"-1.000" (2.22-2.54)	07401025			
24, 28	3057-16	1⅞" x 18"	1¼	<b>091041011</b>	.750"-.875" (1.90-2.22)	074011251	.97"-1.25" (2.46-3.17)	073031205	074093515
32	3057-20	1¾" x 18"		<b>091041013</b>	.875"-1.000" (2.22-2.54)	07401026			
36	3057-24	2" x 18"		<b>091041016</b>	1.000"-1.125" (2.54-2.86)	07401027			
					1.125"-1.375" (2.86-3.17)	07401028			
32	3057-20	1¾" x 18"	1½	<b>091041014</b>	.875"-1.000" (2.22-2.54)	07401029	—	—	074093516
36	3057-24	2" x 18"		<b>091041017</b>	1.000"-1.125" (2.54-2.86)	07401030			
40	3057-28	2¼" x 16"		<b>091041019</b>	1.125"-1.250" (2.86-3.17)	07401031			
				1.250"-1.375" (3.17-3.49)	07401032				

Note: \*Cable jacket may have to be stripped to pass through connector body.

\*\*Number stamped on connector shell.

\*\*\*Number stamped on clamp shell.

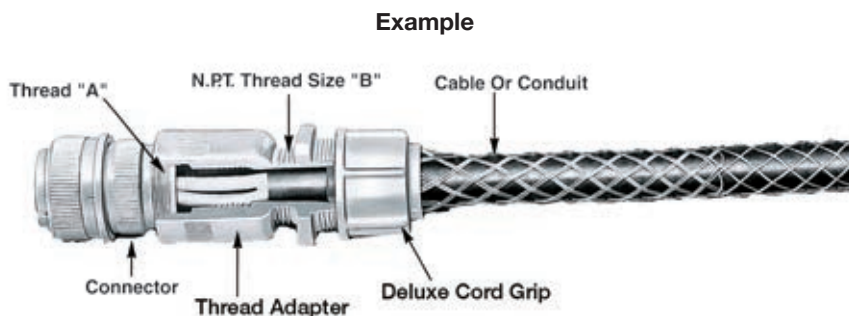

091041006



## Wire Mesh Grip Materials

Material	Features	Product Group
Galvanized steel wire	<ul style="list-style-type: none"> <li>• High strength</li> <li>• Not subject to continuous outside environment</li> </ul>	<ul style="list-style-type: none"> <li>• Strain relief grips</li> <li>• I-Grips</li> </ul>
Stainless steel wire (302/304)	<ul style="list-style-type: none"> <li>• High strength</li> <li>• Corrosion resistant</li> <li>• Slightly magnetic</li> </ul>	<ul style="list-style-type: none"> <li>• Deluxe cord grips</li> <li>• Liquidtight, flexible, metal conduit grips</li> <li>• UL type A conduit grips</li> </ul>
Non-metallic strand	<ul style="list-style-type: none"> <li>• Superior flex life</li> <li>• Non-conductive</li> <li>• Corrosion resistant</li> <li>• Moderate strength</li> </ul>	<ul style="list-style-type: none"> <li>• Non-metallic deluxe cord grips</li> </ul>

## Operating Temperatures

Material	Temperature Range
Aluminum	-40°F to +300°F (-40°C to +149°C).
Aluminum Deluxe Cord Grips	-30°F to +240°F (-34°C to +115°C).
Non-Metallic Deluxe Cord Grips	-30°F to +225°F (-34°C to +107°C).
Nylon	-40°F to +225°F (-40°C to +107°C).
Nylon Fitting with Stainless Steel Mesh	-40°F to +225°F (-40°C to +107°C).
Stainless Steel	-60°F to +1000°F (-51°C to +537°C).
Stainless Steel Deluxe Cord Grips	-30°F to +240°F (-34°C to +115°C).
Neoprene (Bushings)	-30°F to +240°F (-34°C to +115°C).

## Hazardous Locations

	Product Categories
The product categories listed to the right are suitable for use in hazardous locations per Class I Div. 2, Class II Div. 1 & 2, Class III Div. 1 & 2.	Deluxe cord grip, aluminum fitting; Deluxe cord grip, nylon fitting; Deluxe cord grip, non-metallic; Sealtite conduit grips; Dusttight strain relief grips.

## Flammability

Non-metallic deluxe cord grips will not support combustion. Listed below are the ratings.

Component	Rating
Mesh grip	UL 94HB.
Fitting	UL 94V-2.

## Approvals

UL Listing and CSA Certification are indicated on appropriate product catalog pages.

Agency	UL Control Number
Underwriters Laboratories Inc.	898D and 899D.
	UL Listed in accordance with Standard 514B for indoor/outdoor use.

## Wet Locations

	Product Categories
The products noted to the right are suitable for use in wet locations when a listed sealing ring is used between box and fitting.	Deluxe cord grip, aluminum fitting; Deluxe sealing ring cord grip; Deluxe cord grip, non-metallic; Sealtite conduit grips; Hubbell non-metallic conduit grips; Cord connectors; Hubbell Juniors; PolyTuff® connectors; Hubbell sealtite conduit connectors.



## Form Size Definition

The term "Form Size" refers to the physical mass or overall dimensions of a cord connector. Form 1 is the smallest size, Form 8 is the largest size.

## Knockout Holes

NPT Hub Size Inches	Knockout Hole Recommended Min. to Max. Inches (cm)	
¼	.540" to .570"	(1.37-1.45)
⅜	.671" to .701"	(1.70-1.78)
½	.859" to .906"	(2.18-2.30)
¾	1.094" to 1.141"	(2.78-2.90)
1	1.359" to 1.406"	(3.45-3.57)
1¼	1.719" to 1.766"	(4.37-4.49)
1½	1.969" to 2.016"	(5.00-5.12)
2	2.453" to 2.500"	(6.23-6.35)
2½	2.953" to 3.000"	(7.50-7.62)
3	3.578" to 3.625"	(9.09-9.21)

## Product Data

### Deluxe Cord Grips, Liquidtight for Insulated Cables

Deluxe Cord Grips helps to alleviate pull tension on terminals, control cable arc-of-bend, prevent cord pull-out, and provide a liquidtight seal. They are offered with either aluminum, stainless steel or nylon fittings in a variety of configurations and NPT thread sizes. Additionally, a completely non-metallic product is offered on page V-61.

## Application

Deluxe Cord Grips are used indoors or outdoors to help prevent cord pull-out, and where cables are subjected to moisture, splash or submersion. Specific uses are: wiring enclosures, pendant stations, hand tools, construction, processing and material handling equipment, pumps, motors and machine tools.

## Benefits

- Helps to prevent cable pull-out.
- Controls cable arc-of-bend.
- Provides a liquidtight seal.
- Corrosion resistant stainless steel mesh with aluminum collar.



## Deluxe Cord Grips Fitting Dimensions

### Straight Hubbell Connectors

F NPT Inches	Aluminum, Inches (cm)					Nylon, Inches (cm)					Stainless Steel, Inches (cm)								
	A Form Dia.	B Ref.	C	D Throat Dia.	E A/C* A/F*	A Dia.	B Ref.	C	D Throat Dia.	E A/C* A/F*	A A/C* A/F*	B Ref.	C	D Throat Dia.	E A/C* A/F*				
3/8-18	1 .88" (2.24)	.90" (2.29)	.46" (1.17)	.44" (1.12)	.99" (2.51)	.88" (2.24)	1.00" (2.54)	1.10" (2.79)	.43" (1.09)	.45" (1.14)	1.00" (2.54)	.93" (2.36)	1.01" (2.57)	.88" (2.24)	.90" (2.29)	.46" (1.17)	.45" (1.14)	.87" (2.21)	.75" (1.90)
1/2-14	1 .88" (2.24)	.90" (2.29)	.46" (1.17)	.44" (1.12)	.99" (2.51)	.88" (2.24)	1.00" (2.54)	1.10" (2.79)	.43" (1.09)	.45" (1.14)	1.00" (2.54)	.93" (2.36)	—	—	—	—	—	—	—
1/2-14	2 1.13" (2.87)	1.10" (2.79)	.55" (1.40)	.64" (1.63)	1.11" (2.82)	1.00" (2.54)	1.32" (3.35)	1.50" (3.81)	.53" (1.35)	.58" (1.47)	1.25" (3.17)	1.12" (2.84)	1.30" (3.30)	1.13" (2.87)	1.10" (2.79)	.54" (1.37)	.63" (1.60)	1.16" (2.95)	1.00" (2.54)
1/2-14	3 1.38" (3.51)	1.50" (3.81)	.55" (1.40)	.64" (1.63)	1.40" (3.56)	1.25" (3.17)	—	—	—	—	—	—	—	—	—	—	—	—	—
3/4-14	2 1.13" (2.87)	1.10" (2.79)	.55" (1.40)	.64" (1.63)	1.29" (3.28)	1.13" (2.87)	—	—	—	—	—	—	—	—	—	—	—	—	—
3/4-14	3 1.38" (3.51)	1.50" (3.81)	.55" (1.40)	.82" (2.08)	1.40" (3.56)	1.25" (3.17)	1.56" (3.96)	1.60" (4.06)	.55" (1.40)	.77" (1.96)	1.44" (3.66)	1.31" (3.33)	1.59" (4.04)	1.38" (3.51)	1.30" (3.30)	.56" (1.42)	.81" (2.06)	1.44" (3.66)	1.25" (3.17)
1-11½	3 —	—	—	—	—	—	—	—	—	—	—	—	—	—	—	—	—	—	—
1-11½	4 1.75" (4.44)	1.60" (4.06)	.71" (1.80)	1.02" (2.59)	1.81" (4.60)	1.62" (4.11)	1.88" (4.78)	1.75" (4.44)	.70" (1.78)	1.01" (2.57)	1.84" (4.67)	1.63" (4.14)	2.02" (5.13)	1.75" (4.44)	1.40" (3.56)	.70" (1.78)	1.03" (2.62)	1.88" (4.78)	1.63" (4.14)
1-11½	5 2.31" (5.87)	1.70" (4.32)	.66" (1.68)	1.01" (2.57)	2.28" (5.79)	2.00" (5.08)	—	—	—	—	—	—	—	—	—	—	—	—	—
1¼-11½	5 2.31" (5.87)	1.70" (4.32)	.74" (1.88)	1.26" (3.20)	2.28" (5.79)	2.12" (5.38)	—	—	—	—	—	—	—	—	—	—	—	—	—
1½-11	5 2.31" (5.87)	1.70" (4.32)	.74" (1.88)	1.38" (3.51)	2.28" (5.79)	2.12" (5.38)	—	—	—	—	—	—	—	—	—	—	—	—	—
1½-11½	6 3.00" (7.62)	2.20" (5.59)	.75" (1.90)	1.50" (3.81)	2.97" (7.54)	2.75" (6.98)	—	—	—	—	—	—	—	—	—	—	—	—	—
2-11½	6 3.00" (7.62)	2.20" (5.59)	.80" (2.03)	1.92" (4.88)	3.24" (8.24)	3.00" (7.62)	—	—	—	—	—	—	—	—	—	—	—	—	—
2-11½	7 3.85" (9.78)	2.70" (6.86)	.88" (2.24)	1.94" (4.93)	4.05" (10.29)	3.75" (9.52)	—	—	—	—	—	—	—	—	—	—	—	—	—
2½-8	7 3.85" (9.78)	2.70" (6.86)	1.30" (3.30)	2.32" (5.89)	4.34" (11.02)	4.02" (10.21)	—	—	—	—	—	—	—	—	—	—	—	—	—
2½-8	8 4.75" (12.06)	2.70" (6.86)	1.25" (3.17)	2.38" (6.05)	4.86" (12.34)	4.50" (11.43)	—	—	—	—	—	—	—	—	—	—	—	—	—
3-8	7 3.85" (9.78)	2.70" (6.86)	1.30" (3.30)	2.54" (6.45)	4.34" (11.02)	4.01" (10.21)	—	—	—	—	—	—	—	—	—	—	—	—	—
3-8	8 4.50" (11.43)	2.70" (6.86)	1.38" (3.51)	3.00" (7.62)	4.86" (12.34)	4.50" (11.43)	—	—	—	—	—	—	—	—	—	—	—	—	—

Note: \*A/C— Across Corners; A/F— Across Flats.

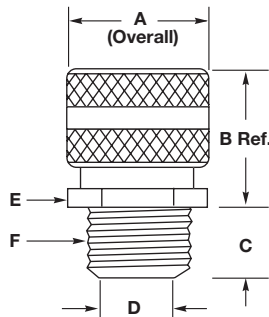

Dimensions shown are approximate and are subject to change without notice.



**Deluxe Cord Grips Fitting Dimensions**

**45° Hubbell Connectors**

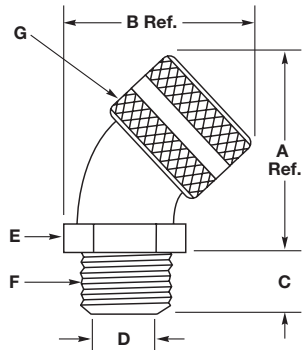

Aluminum, Inches (cm)								
F NPT Inches	Form	A Ref.	B Ref.	C	D Throat Dia.	E		G Dia.
						Across Comers	Across Flats	
½-14	2	2.00" (5.08)	1.90" (4.83)	.550" (1.40)	.560" (1.42)	1.270" (3.23)	1.110" (2.79)	1.125" (2.86)
¾-14	3	2.30" (5.84)	2.50" (6.53)	.560" (1.42)	.750" (1.90)	1.480" (3.76)	1.281" (3.25)	1.375" (3.49)
1-11½	4	2.60" (6.60)	2.80" (7.11)	.700" (1.78)	1.000" (2.54)	1.690" (4.29)	1.500" (3.81)	1.750" (4.44)
1¼-11½	5	3.90" (9.91)	3.90" (9.91)	.740" (1.88)	1.250" (3.17)	2.45" (6.22)	2.125" (5.40)	2.310" (5.87)
1½-11½	5	3.90" (9.91)	3.90" (9.91)	.740" (1.88)	1.500" (3.81)	2.45" (6.22)	2.125" (5.40)	2.310" (5.87)

**90° Hubbell Connectors**

Aluminum, Inches (cm)									Nylon, Inches (cm)						
F NPT Inches	Form	A	B Ref.	C	D Throat Dia.	E		G Dia.	A	B Ref.	C	D Throat Dia.	E		G Dia.
						A/C*	A/F*						A/C*	A/F*	
¾-18	1	1.27" (3.23)	2.00" (5.08)	.460" (1.17)	.440" (1.12)	1.15" (2.92)	1.10" (2.79)	.875" (2.22)	—	—	—	—	—	—	—
½-14	2	1.56" (3.96)	2.30" (5.84)	.500" (1.27)	.546" (1.39)	1.30" (3.30)	1.13" (2.87)	1.125" (2.86)	1.41" (3.58)	2.50" (6.35)	.550" (1.40)	.575" (1.46)	1.23" (3.12)	1.12" (2.82)	1.315" (3.34)
¾-14	3	1.79" (4.55)	2.80" (7.11)	.560" (1.42)	.765" (1.94)	1.49" (3.78)	1.31" (3.33)	1.375" (3.49)	1.65" (4.19)	2.81" (7.14)	.560" (1.42)	.765" (1.94)	1.42" (3.61)	1.29" (3.28)	1.560" (3.96)
1-11½	4	2.08" (5.28)	3.20" (8.13)	.700" (1.78)	1.000" (2.54)	1.70" (4.32)	1.50" (3.81)	1.750" (4.44)	1.99" (5.05)	3.30" (8.38)	.700" (1.78)	1.010" (2.57)	1.82" (4.62)	1.60" (4.06)	1.875" (4.76)
1¼-11½	5	3.18" (8.08)	4.30" (10.92)	.730" (1.85)	1.260" (3.20)	2.47" (6.27)	2.15" (5.46)	2.310" (5.87)	—	—	—	—	—	—	—
1½-11½	5	3.18" (8.08)	4.30" (10.92)	.750" (1.92)	1.500" (3.81)	2.47" (6.27)	2.15" (5.46)	2.310" (5.87)	—	—	—	—	—	—	—
2-11½	6	3.51" (8.92)	5.50" (13.97)	.800" (2.03)	1.920" (4.88)	2.98" (7.57)	2.78" (7.06)	3.000" (7.62)	—	—	—	—	—	—	—

Note: \*A/C - Across Corners; A/F - Across Flats.

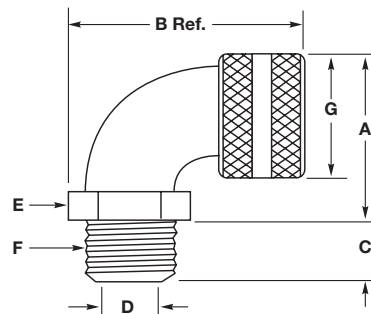

Dimensions shown are approximate and are subject to change without notice.



## Deluxe Cord Grips Fitting Dimensions

### Female Hubbell Connectors

Aluminum, Inches (cm)							
F NPT Inches	Form	A Dia.	B Ref.	C	D Throat Dia.	E	
						Across Corners	Across Flats
3/8-18	1	.88" (2.24)	1.40" (3.56)	.560" (1.42)	.44" (1.12)	.94" (2.39)	.81" (2.06)
1/2-14	2	1.13" (2.87)	1.80" (4.57)	.560" (1.42)	.63" (1.60)	1.15" (2.92)	1.00" (2.54)
3/4-14	2	1.13" (2.87)	2.10" (5.33)	.750" (1.90)	.63" (1.60)	1.44" (3.66)	1.25" (3.17)
1-11½	4	1.75" (4.44)	2.30" (5.84)	.880" (2.24)	1.10" (2.79)	1.88" (4.78)	1.63" (4.14)
1¼-11½	5	2.31" (5.87)	2.80" (7.11)	.950" (2.41)	1.43" (3.63)	2.64" (6.71)	2.29" (5.82)
1½-11½	5	2.31" (5.87)	2.80" (7.11)	.950" (2.41)	1.43" (3.63)	2.64" (6.71)	2.29" (5.82)

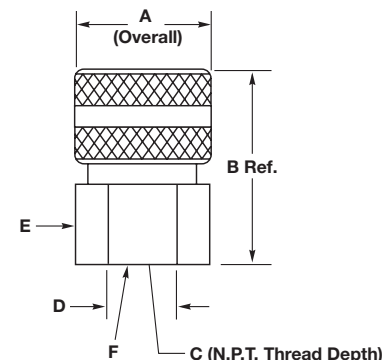

## Product Data

### Dust-Tight Strain Relief Grips for Insulated Cables

Kellems® Strain Relief Grips connect flexible cord or bus drop cable to electrical enclosures. For indoor use only, they are available with either insulated or non-insulated aluminum fittings, and feature single weave, galvanized steel mesh grips with patented wide range mesh construction. They come with a locknut and a neoprene gasket that provides a dust tight seal.

### Application

Used to connect electrical cable to power boxes, cabinets, panel boards, power centers, machine tools and with bus drop systems.

### Benefits

- Helps prevent cord or cable pull-out.
- Provides a dust tight seal.
- Easy installation.
- Patented mesh construction.
- One piece design.

### I-Grips for Insulated Cables

Kellems I-Grips are made of high strength, plastic coated galvanized steel strand. They are offered in six sizes to fit all cable diameters used with Hubbell Insulgrip®. Kellems I-Grips will control cable arc-of-bend and reduce high pull tensions from being transmitted to the wiring terminals.

### Application

Kellems I-Grips will fit 2, 3, 4 and 5 wire Hubbell Insulgrip plugs and connector bodies. The eye tabs fit under the nylon cord clamp and the screws slide through the eyelets, securing the grip in place.

I-Grips can be used on any Insulgrip cord set which requires cable, arc-of-bend control or heavy duty strain relief. Cord sets used at in-door construction sites or for plant maintenance jobs are examples.

These grips are for indoor use only.

### Benefits

- Easily attached to Insulgrip plugs and connector bodies.
- Fits all sizes.
- Provides heavy duty strain relief.
- Controls cable arc-of-bend.

Note: I-Grips should not be used on Insulgrip devices when "Seal-Tite®" weatherproof covers are to be installed.

Dimensions shown are approximate and are subject to change without notice.



**Strain Relief Grips for Liquidtight Flexible Metal and PolyTuff® I Non-Metallic Conduit**

Kellems Liquidtight, Flexible Metal Conduit Grips are offered with high quality Hubbell plated steel fittings in a wide variety of NPT sizes and configurations, either insulated or non-insulated. The addition of a stainless steel mesh to these fittings makes them stronger than the conduit itself. Kellems Conduit Grips helps prevent conduit pull-out from the connecting fitting that is subject to stress, pull tension, vibration, motion or strain. They promote safe electrical systems and reduce equipment downtime.

**Application**

Kellems Conduit Grips are used in the wiring of machine tools, motors, molding equipment, transformers, weaving and paper machines, fans, lighting, bakeries, breweries, food processing, chemical plants, dairies, mines and any application that requires Liquidtight Conduit.

**Benefits**

- Helps prevent conduit pull-out and damage at the fitting.
- Reduces equipment downtime.
- Liquidtight fittings.
- Easily installed.
- Stainless steel grip resists corrosion.

Kellems Conduit Grips are suitable for use in hazardous locations per Class I Div. 2, Class II Div. 1 & 2, Class III Div. 1 & 2 of the National Electric Code.

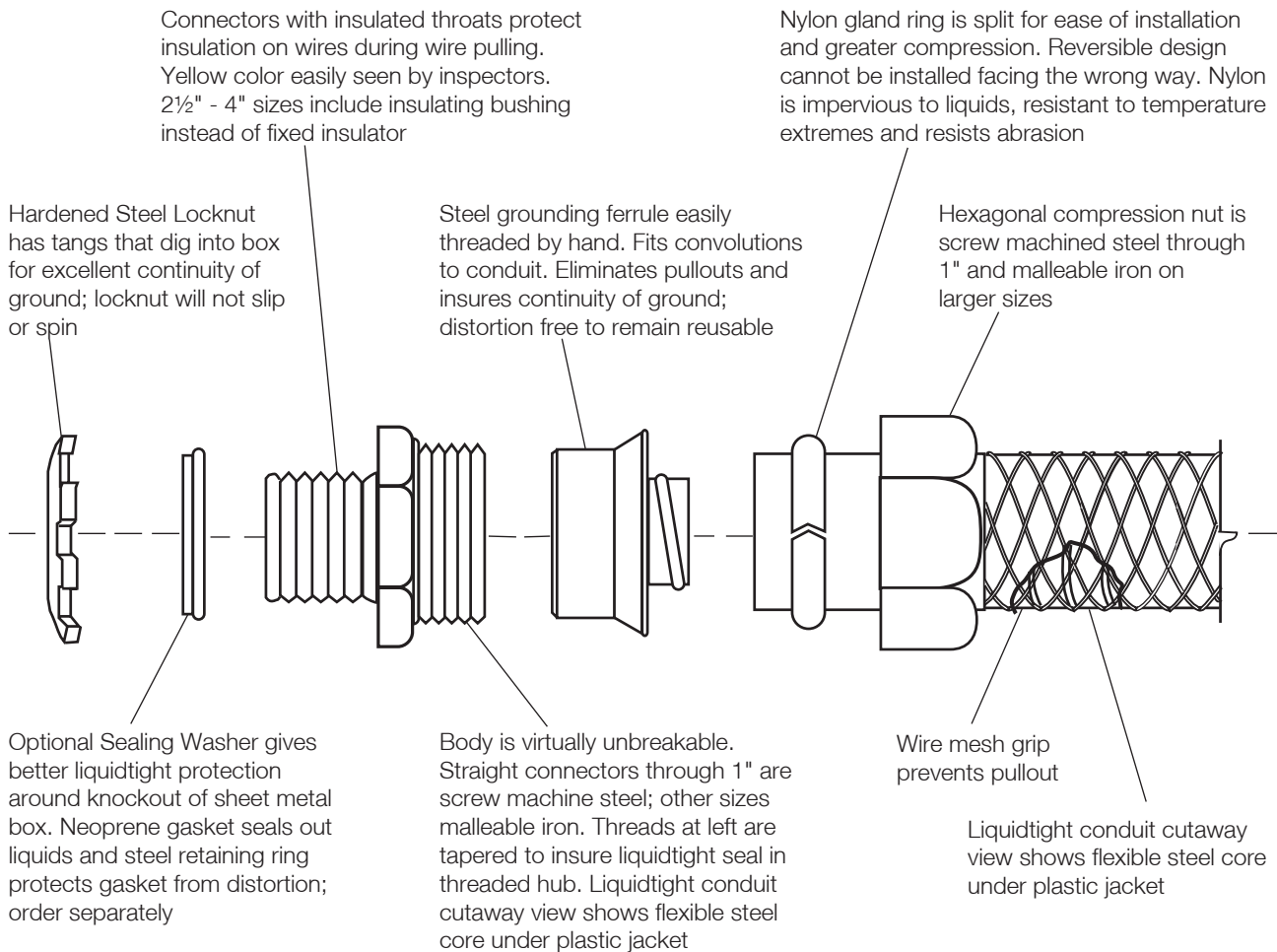





## Liquidtight Conduit Grip Fitting Dimensions, Inches

### Straight with Male Fitting

Dimensions, Inches

Trade Size Inches	A Ref.	B Ref.	C		D Throat Dia.	E		Catalog Number
			A/C*	A/F*		A/C*	A/F*	
3/8	1.43"	.59"	1.20"	1.06"	.61"	1.07"	.93"	<b>074093401</b>
1/2	1.43"	.59"	1.34"	1.19"	.61"	1.22"	1.06"	<b>074093402</b>
3/4	1.56"	.59"	1.55"	1.37"	.84"	1.43"	1.25"	<b>074093403</b>
1	1.68"	.66"	1.95"	1.69"	1.06"	1.73"	1.56"	<b>074093404</b>
1 1/4	2.03"	.63"	2.39"	2.06"	1.37"	2.36"	2.08"	<b>074093405</b>
1 1/2	2.21"	.63"	2.72"	2.38"	1.53"	2.79"	2.48"	<b>074093406</b>
2	2.28"	.69"	3.08"	2.87"	2.06"	3.32"	2.90"	<b>074093408</b>

### Straight with Male Fitting with Insulated Throat

Dimensions, Inches

Trade Size Inches	A Ref.	B Ref.	C		D Throat Dia.	E		Catalog Number
			A/C*	A/F*		A/C*	A/F*	
3/8	1.50"	.66"	1.20"	1.06"	.57"	1.07"	.93"	<b>074093511</b>
1/2	1.50"	.66"	1.34"	1.19"	.57"	1.22"	1.06"	<b>074093512</b>
3/4	1.62"	.66"	1.55"	1.38"	.78"	1.43"	1.25"	<b>074093513</b>
1	1.75"	.72"	1.95"	1.69"	.98"	1.73"	1.56"	<b>074093514</b>
1 1/4	2.09"	.69"	2.39"	2.06"	1.29"	2.36"	2.08"	<b>074093515</b>
1 1/2	2.28"	.69"	2.72"	2.37"	1.53"	2.79"	2.48"	<b>074093516</b>
2	2.34"	.75"	3.08"	2.87"	1.95"	3.32"	2.90"	<b>074093518</b>
2 1/2	3.56"	1.06"	3.92"	3.62"	2.42"	3.85"	3.60"	<b>074093520</b>
3	3.81"	1.06"	4.70"	4.31"	3.01"	4.65"	4.33"	<b>074093522</b>
4	3.81"	1.06"	5.75"	5.31"	3.96"	5.75"	5.39"	<b>074093526</b>

### 45° Angle with Male Fitting

Dimensions, Inches

Trade Size Inches	H Ref.	J Ref.	K Ref.	L		M Throat Dia.	N		Catalog Number
				A/C*	A/F*		A/C*	A/F*	
3/8	1.19"	1.28"	.59"	1.20"	1.06"	.60"	1.16"	1.02"	<b>074093441</b>
1/2	1.19"	1.28"	.59"	1.34"	1.19"	.61"	1.21"	1.06"	<b>074093442</b>
3/4	1.19"	1.43"	.59"	1.55"	1.45"	.84"	1.50"	1.32"	<b>074093443</b>
1	1.38"	1.53"	.66"	1.95"	1.69"	1.05"	1.82"	1.59"	<b>074093444</b>
1 1/4	1.42"	1.69"	.63"	2.39"	2.06"	1.37"	2.32"	2.03"	<b>074093445</b>
1 1/2	1.66"	2.00"	.66"	2.72"	2.38"	1.60"	2.62"	2.29"	<b>074093446</b>
2	1.69"	2.25"	.66"	3.08"	2.88"	2.05"	3.21"	2.80"	<b>074093448</b>

### 45° Angle with Male Fitting with Insulated Throat

Dimensions, Inches

Trade Size Inches	H Ref.	J Ref.	K Ref.	L		M Throat Dia.	N		Catalog Number
				A/C*	A/F*		A/C*	A/F*	
3/8	1.25"	1.28"	.66"	1.20"	1.06"	.57"	1.16"	1.02"	<b>074093561</b>
1/2	1.25"	1.28"	.66"	1.34"	1.19"	.57"	1.21"	1.06"	<b>074093562</b>
3/4	1.25"	1.44"	.66"	1.55"	1.45"	.78"	1.50"	1.32"	<b>074093563</b>
1	1.44"	1.53"	.72"	1.95"	1.69"	.98"	1.82"	1.59"	<b>074093564</b>
1 1/4	1.48"	1.69"	.69"	2.39"	2.06"	1.29"	2.32"	2.03"	<b>074093565</b>
1 1/2	1.72"	2.00"	.72"	2.72"	2.38"	1.53"	2.62"	2.29"	<b>074093566</b>
2	1.75"	2.25"	.72"	3.08"	2.87"	1.95"	3.21"	2.80"	<b>074093568</b>

### 90° Angle with Male Fitting

Dimensions, Inches

Trade Size Inches	D Ref.	E Ref.	F		G Ref.	O Throat Dia.	P		Catalog Number
			A/C*	A/F*			A/C*	A/F*	
3/8	1.31"	.59"	1.20"	1.06"	1.44"	.60"	1.13"	.99"	<b>074093421</b>
1/2	1.31"	.59"	1.34"	1.12"	1.44"	.61"	1.21"	1.00"	<b>074093422</b>
3/4	1.44"	.59"	1.55"	1.45"	1.63"	.83"	1.48"	1.29"	<b>074093423</b>
1	1.78"	.66"	1.95"	1.60"	2.19"	1.05"	1.80"	1.57"	<b>074093424</b>
1 1/4	1.97"	.63"	2.39"	2.06"	2.50"	1.37"	2.32"	2.02"	<b>074093425</b>
1 1/2	2.19"	.66"	2.72"	2.38"	2.69"	1.61"	2.58"	2.25"	<b>074093426</b>
2	2.53"	.66"	3.08"	2.87"	3.25"	2.05"	3.14"	2.75"	<b>074093428</b>

### 90° Angle with Male Fitting with Insulated Throat

Dimensions, Inches

Trade Size Inches	D Ref.	E Ref.	F		G Ref.	O Throat Dia.	P		Catalog Number
			A/C*	A/F*			A/C*	A/F*	
3/8	1.38"	.66"	1.20"	1.06"	1.44"	.60"	1.13"	.99"	<b>074093541</b>
1/2	1.38"	.66"	1.34"	1.12"	1.44"	.57"	1.21"	1.00"	<b>074093542</b>
3/4	1.50"	.66"	1.55"	1.45"	1.63"	.78"	1.48"	1.29"	<b>074093543</b>
1	1.84"	.66"	1.95"	1.60"	2.19"	.98"	1.80"	1.57"	<b>074093544</b>
1 1/4	2.03"	.69"	2.39"	2.06"	2.50"	1.29"	2.32"	2.02"	<b>074093545</b>
1 1/2	2.25"	.69"	2.72"	2.38"	2.69"	1.53"	2.58"	2.20"	<b>074093546</b>
2	2.59"	.72"	3.08"	2.87"	3.25"	1.95"	3.14"	2.75"	<b>074093548</b>
2 1/2	3.44"	1.00"	3.92"	3.63"	4.25"	2.42"	3.78"	3.50"	<b>074093550</b>
3	3.75"	1.00"	4.70"	4.31"	4.87"	3.01"	4.64"	4.30"	<b>074093552</b>

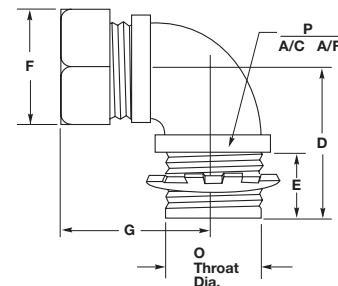
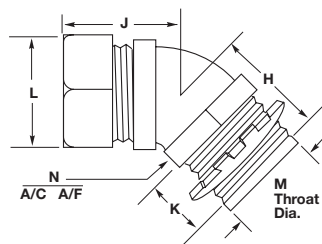
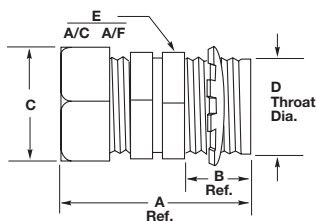

Note: \*A/C - Across Corners; A/F - Across Flats.

Dimensions shown are approximate and are subject to change without notice.



**Strain Relief for UL Type A, Flexible, Liquidtight Conduit**

Kellems Grips for UL Type A, non-metallic, flexible, liquidtight conduit are available in straight and 90° male and feature a high quality Hubbell plated steel or malleable iron fitting, complete with a sealing O-ring, lock nut and stainless steel mesh. These grips increase the retention of the conduit in the fitting, control its arc-of-bend and provide a liquidtight seal.

**Application**

These grips are used on UL Type A non-metallic conduit connections at limit switches, motor boxes, panel boards, control stations and on all types of machinery and machine tools.

Steel Locknut has tangs that dig into box for excellent continuity of ground; locknut will not slip or spin

Neoprene O-ring is factory assembled into the body to seal out liquids to seal out liquids

Insulated throat protects insulation on wires during pulling; yellow color easily seen by inspectors

Yellow nylon ferrule fits inside non-metallic conduit to hold the shape; barb in designed to assure liquidtight seal even with non-square cut; ferrule is keyed to fit into body to prevent conduit twisting

**Benefits**

- Provides a liquidtight seal.
- Helps prevent conduit pull-out.
- Reduces conduit cutting, kinking, fraying and splitting at the fitting.
- Easily installed.

Body is virtually unbreakable. Straight connectors through 1" are screw machine steel; other sizes are malleable iron. Threads are tapered to insure liquidtight seal when used in threaded hub; octagonal shape inside holds the ferrule to prevent conduit from twisting during installation

Wire mesh grip prevents pullout

Hexagonal compression nut is machine steel through 1" malleable iron on larger sizes; tapered interior compresses sleeve over conduit sealing out liquids and preventing pullout

Yellow nylon sleeve installs over conduit; six slits in sleeve permit tight compression onto conduit as compression nut is tightened

**Dimensional Charts For UL Type A, Liquidtight Conduit Grip Fittings**

**Straight with Male Fitting with Insulated Throat**

Dimensions Inches (cm)

Trade Size NPT Inches	A	B	C	D	Catalog Number
3/8	1.922" (4.88)	.594" (1.51)	1.156" (2.94)	3.75" (9.52)	<b>H038CNK</b>
1/2	1.922" (4.88)	.594" (1.51)	1.250" (3.17)	4.50" (11.43)	<b>H050CNK</b>
3/4	2.016" (5.12)	.594" (1.51)	1.500" (3.81)	6.25" (15.87)	<b>H075CNK</b>
1	2.157" (5.48)	.719" (1.83)	1.844" (4.68)	7.50" (19.05)	<b>H100CNK</b>
1 1/4	2.219" (5.64)	.750" (1.91)	2.312" (5.87)	9.00" (22.86)	<b>H125CNK</b>
1 1/2	2.344" (5.95)	.750" (1.91)	2.578" (6.55)	13.50" (34.29)	<b>H150CNK</b>
2	2.406" (6.11)	.750" (1.91)	3.187" (8.09)	14.50" (36.83)	<b>H200CNK</b>

**90° Angle with Male Fitting with Insulated Throat**

Dimensions Inches (cm)

Trade Size NPT Inches	E	F	G	H	I	Catalog Number
3/8	1.250" (3.18)	.594" (1.51)	1.156" (2.94)	1.453" (3.69)	3.75" (9.52)	<b>H0389CNK</b>
1/2	1.281" (3.25)	.594" (1.51)	1.250" (3.17)	1.453" (3.69)	4.50" (11.43)	<b>H0509CNK</b>
3/4	1.438" (3.65)	.594" (1.51)	1.500" (3.81)	1.000" (2.54)	6.25" (15.87)	<b>H0759CNK</b>
1	1.750" (4.44)	.719" (1.83)	1.844" (4.68)	2.125" (5.40)	7.50" (19.05)	<b>H1009CNK</b>
1 1/4	1.969" (5.00)	.750" (1.91)	2.312" (5.87)	2.344" (5.95)	9.00" (22.86)	<b>H1259CNK</b>
1 1/2	2.250" (5.71)	.750" (1.91)	2.578" (6.55)	2.500" (6.35)	13.50" (34.29)	<b>H1509CNK</b>
2	2.531" (6.43)	.750" (1.91)	3.187" (8.09)	2.781" (7.06)	14.50" (36.83)	<b>H2009CNK</b>

